

KORG

KR-55 Pro

KORG RHYTHM

Owner's Manual

Table of contents

Introduction	2	Recorder mode	20
Main features.....	2	Metronome function	20
About the Owner's Manual.....	2	Count start function.....	20
Parts and their functions	3	Mark function	20
Top panel.....	3	Loop recording/playback function.....	21
Rear panel.....	6	Exporting song data.....	21
Setup	7	Importing an audio file	21
Connections.....	7	Player mode	22
About SD cards	7	Playlist function	22
Turning the power on/off.....	8	Loop/auto-consecutive playback function	22
Quick Start	9	Adjusting the playback speed.....	22
Listening to the demo performances	9	System mode.....	23
Connecting and playing instruments.....	10	Making system settings	23
Playing and recording rhythm styles (Rhythm mode).....	11	Setting items.....	23
Using the recorder function (Recorder mode)	13	Formatting an SD card [M8] "Init"	23
Playing audio files and recording your performance (Player mode)	16	SD card test function "tEst"	23
Rhythm mode	18	Appendix.....	24
Registering a rhythm variation and tempo to the [M1]–[M8] buttons.....	18	Voice name list	24
Chain function.....	18	Data structure on the KR-55 Pro	24
Metronome function	19	Using a foot switch	25
Count start function.....	19	Troubleshooting	25
Tonal character when the tempo/playback speed is adjusted.....	19	Error messages.....	26
		Specifications.....	27
		KR-55 Pro Signal Path.....	28

Introduction

Thank you for purchasing the **KORG RHYTHM KR-55 Pro**. To help you get the most out of your new instrument, please read this manual carefully.

Main features

Rhythm Player function

- You can enjoy jamming along with realistic live-recorded drum and percussion accompaniment.
- Twenty-four different rhythm styles are built in. You can directly select these rhythm styles by using the buttons on the top panel.
- Each rhythm style has two variations, and each of these variations contains three rhythm patterns: basic, fill-in 1, and fill-in 2. You can switch variations or rhythm patterns in real time as needed during your performance.
- You can use the chain function to create the rhythm structure of an entire song so that it will play automatically.

Acoustage (surround) function

- Acoustage technology provides an expansive, extra-wide sound field.

* Acoustage (Virtual Surround Technology by KORG) is Korg's original and revolutionary virtual sound technology for creating a unique personal acoustic space. This technology offers an unprecedented and unique three-dimensional acoustic experience, when connecting stereo speakers to the OUTPUT L/MONO and R jacks. The playback system itself is acoustically analyzed, and optimizations are applied for that specific system so that its full potential can be realized.

Full-fledged mixer functionality

- A mic input, two guitar inputs, and an AUX input allow multi-channel mixing.
- You can apply a reverb effect to the inputs from the MIC IN jack, INPUT 1 jack, and INPUT 2 jack.
- You can use an equalizer to adjust the tonal character.

Tuner function

- You can tune while viewing a large and easily visible meter.
- You can tune while listening to the pitch of an audible guide tone.

Recording function *1

- You can create complete songs by recording chained rhythm styles along with your own performance.
- You can record along with the playback of an audio file from an SD card.
- The completed song data can be exported (written) as a standard audio file, and played back by a commercially available audio player or loaded into your computer DAW.

Player function *1

- Standard audio files (WAV) can be played back from an SD card.
- You can use the playlist function to play back your audio files in a specific order. A playlist you create can be used for background music or live performances.
- You can change the playback speed of audio files.

Foot switch control

- By using a VOX VFS5 foot switch, you can perform operational tasks without having to take your hands off of your instrument. This includes operations such as rhythm playback or beginning recording/playback while you play your instrument.

*1: You'll need to insert an SD card into the KR-55 Pro.

About the Owner's Manual

The KR-55 Pro Owner's Manual is organized as follows:

- KR-55 Pro Quick Start Guide (printed material)
- KR-55 Pro Owner's Manual (PDF: this booklet)

Download the PDF from the following website.

<http://www.korg.com>

Tip: We recommend that you read this manual while referring to the STAGEMAN 80 video manual. You can view this manual on the Korg website.

<http://www.korg.com>

Regarding data

Unexpected malfunctions caused by inappropriate operation can cause the contents of memory to be lost. Please save important data to other media for safekeeping. KORG INC. accepts no responsibility for any damages resulting from loss of data.

COPYRIGHT WARNING

This professional device is intended only for use with works for which you yourself own the copyright, for which you have received permission from the copyright holder to publicly perform, record, broadcast, sell, and duplicate, or in connection with activities which constitute "fair use" under copyright law. If you are not the copyright holder, have not received permission from the copyright holder, or have not engaged in fair use of the works, you may be violating copyright law, and may be liable for damages and penalties. If you are unsure about your rights to a work, please consult a copyright attorney.

KORG TAKES NO RESPONSIBILITY FOR ANY INFRINGEMENT COMMITTED THROUGH USE OF KORG PRODUCTS.

* All product names and company names are the trademarks or registered trademarks of their respective owners.

Parts and their functions

Top panel

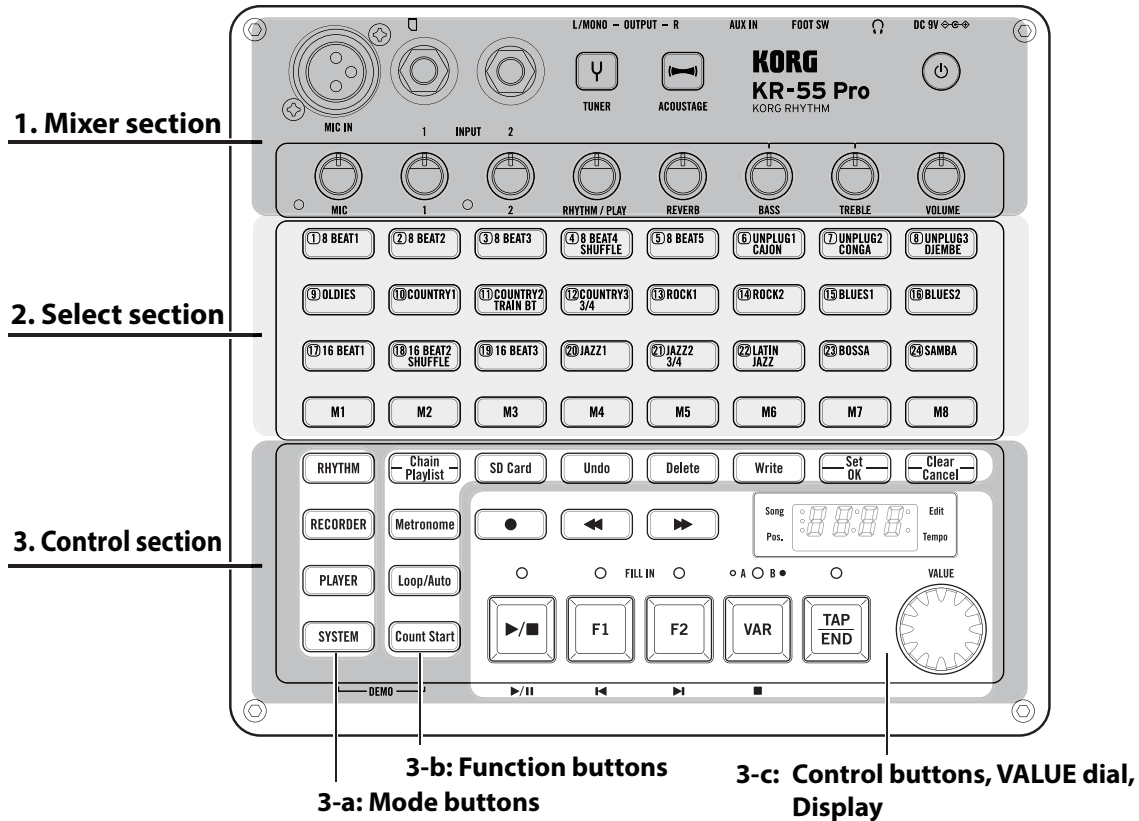

1. Mixer section

MIC IN jack (XLR jack)

Connect a dynamic mic here.

⚠ Condenser mics are incompatible with the KR-55 Pro.

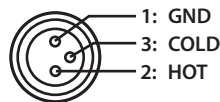

INPUT 1 jack, INPUT 2 jack

Connect a guitar, bass, or other instrument to these jacks.

TUNER button

Turns the tuner function on.

ACOUSTAGE button

Switches the Acoustage (wide) function on/off.

⚠ The Acoustage function cannot be used while recording.

⚠ Turn the Acoustage (wide) function off when using headphones. The Acoustage function is optimal when connecting stereo speakers to the OUTPUT L/MONO and R jacks.

Power button

Turns the power on.

See page 8 "Turning the power on/off"

Note: The power button blinks rapidly if the batteries become low while the KR-55 Pro is running on batteries.

The KR-55 Pro has an auto power-off function. The auto power-off function automatically turns off the power when there has been no user input for a certain length of time (which you can specify). If the auto power-off function has turned the power off, simply turn it back on again.

Tip: You can specify the time after which the auto power-off turns the power off (see page 23 "[M3] Auto power-off function "APOF"").

MIC knob, peak LED

This knob adjusts the input level from the mic that's connected to the MIC IN jack. To avoid signal clipping (signal that's too loud) this knob should be adjusted so that the peak LED doesn't light up when signal is being input at a high volume level.

(INPUT) 1 knob, (INPUT) 2 knob, peak LED

These knobs adjust the input level from the instruments that are connected to INPUTS 1&2. To avoid signal clipping (signal that's too loud) each knob should be adjusted so that the peak LED doesn't light up when signal is being loudly input. The peak LED is shared by INPUT 1 and INPUT 2. If you're using both input jacks, adjust the knobs for both INPUT 1 & INPUT 2.



RHYTHM/PLAY knob

RHYTHM / PLAY

- **Rhythm mode:** This knob adjusts the volume of the rhythm style or metronome.
- **Recorder mode, Player mode:** This knob adjusts the playback volume of the recorder or player.

Note: Turning the knob all the way to the right produces unity gain.



REVERB knob

This knob adjusts the send level to the reverb effect. You can apply reverb to the signals from the MIC IN jack, INPUT 1 jack, and INPUT 2 jack.

By default, reverb is applied to the following inputs: MIC IN jack, INPUT 1 jack, and INPUT 2 jack. If you want, you can apply the reverb only to the MIC IN jack, or only to the INPUT 1 and INPUT 2 jack (see page 23 "[M2] Effect operation "EFF"").



BASS knob

This knob adjusts the tone of the low-frequency range.



TREBLE knob

This knob adjusts the tone of the high-frequency range.



VOLUME knob

This knob adjusts the overall volume.

2. Select section

The functions of these buttons will change depending on the mode that's selected.

[8 BEAT] - [24 SAMBA] buttons

- **Rhythm mode:** select the rhythm style or metronome sound. If the chain function is on, these buttons indicate the rhythm style that is played.
- **Recorder mode:** select the metronome sound that is heard when the metronome is on.
- **Player mode:** select the audio file to play back.
- **Tuner function:** indicate the pitch. See page 10 "Using the tuner function".

[M1] - [M8] buttons

- **Rhythm mode:** These buttons blink to indicate the playback position of the currently selected rhythm style. When the chain function is on, you'll use these buttons to check the location where the rhythm style is registered. You can also use these to register a favorite rhythm variation and performance tempo, and recall it instantly (memory function).
- **Recorder mode:** Registers the position of the song data (see page 20 "Mark function").
- **Player mode:** Use these buttons to select a folder inside the inserted SD card. (see page 24 "Folder and file structure").
- **System mode:** Select system setting items
- **Tuner function:** Sound a guide tone (see page 10 "Using the tuner function")

3. Control section

3-a: Mode buttons

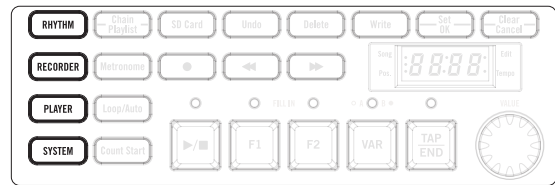

RHYTHM button

Selects Rhythm mode. In Rhythm mode you can play back 24 different rhythm styles. You can also record your own performance along with the chained rhythm styles. See page 11 "Playing and recording rhythm styles (Rhythm mode)"

See page 18 "Rhythm mode"

RECORDER button

Selects Recorder mode. In Recorder mode you can make a new recording, overdub onto an existing recording, or use loop recording.

See page 20 "Recorder mode"

PLAYER button

Selects Player mode. In Player mode, you can play audio files from the SD card. You can also record your own performance along with the audio file playback.

See page 16 "Playing audio files and recording your performance (Player mode)"

See page 22 "Player mode"

SYSTEM button

Selects System mode. In System mode you can check the status of the system and adjust settings for the overall system.

See page 23 "System mode"

Tip: If you press the [SYSTEM] button and the [Count Start] button simultaneously, you enter Demo mode (see page 9 "Listening to the demo performances").

3-b: Function buttons

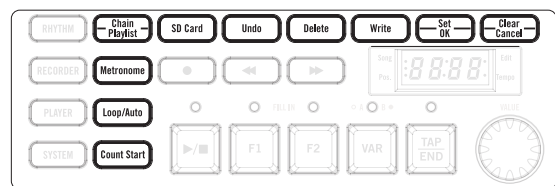

Chain Playlist button

- **Rhythm mode:** Turns the chain function on/off (see page 18 "Chain function").
- **Player mode:** Turns the playlist function on/off (see page 22 "Playlist function").

Metronome button

- **Recorder mode, Player mode:** Turns the metronome function start/stop. To change the time signature of the metronome, hold down the [Metronome] button and turn the VALUE dial.

See page 19 "Metronome function"

Loop/Auto button

- **Recorder mode:** Switches the loop function on/off. When the loop function is on, the region specified by the Mark function can be played as a loop, or recorded. (see page 20 “Mark function”, page 21 “Loop recording/playback function”).
- **Player mode:** Turns the loop/auto-consecutive playback function on/off. If the loop/auto-consecutive playback function is on, you can play one file or all files as a loop or consecutively. (see page 22 “Loop/auto-consecutive playback function”).

Tip: You can choose from several types of functions when the loop/auto-consecutive playback function is on.

Count Start button

- **Rhythm mode, Recorder mode:** Turns the count start function on/off. If this is on, playback or recording will start after a two-measure count. Use the VALUE dial to specify the tempo of the count (see page 19 “Count start function”).

Note: If you’re overdubbing, you need to select the tempo that matches your song.

Tip: In Rhythm mode, use the RHYTHM/PLAY knob to adjust the volume of the count. In Recorder mode the volume is fixed, and cannot be controlled by the RHYTHM/PLAY knob.

Tip: If you want the count to be other than a 4/4 time signature, change the time signature (see page 19 “Count start function”).

SD Card button

When you insert an SD card, the button is lit. When you press the button, the display shows the remaining available recording time. In System mode, this button accesses the SD Card Test function. (see page 23 “SD card test function “tEST””)

Undo button

- **Recorder mode:** After recording in Recorder mode, this button reverts to the state prior to recording (button lit up). Press the button once again to return to the state after recording (button unlit).

Delete button

- **Rhythm mode:** If the Chain function is on, this button deletes all rhythm styles that are assigned to the currently selected chain.
- **Recorder mode:** Deletes the currently selected song
- **Player mode:** Deletes the currently selected audio file

Press the [Delete] button until it lights, and then press the [Set/OK] button to execute the deletion.

Write button

- **Recorder mode:** From the currently selected song data, exports (writes) an audio file that can be played in Player mode.
- **Player mode:** Imports (loads) the currently selected audio file into Recorder mode.

Set/OK button, Clear/Cancel button

- **Rhythm mode:** Use these buttons to edit the chain, or to register/deregister memories.
- **Recorder mode:** Use these buttons to OK/cancel operations such as registering a mark, deleting song data, or exporting.
- **Player mode:** Use these buttons to OK/cancel operations such as editing a playlist or importing an audio file.

Note: If an error message is displayed, the [Set/OK] button blinks. Press the [Set/OK] button to clear the error and return to the previous display.

3-c: Control buttons, VALUE dial, Display

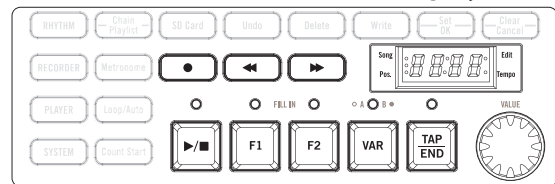

Record-standby button

Enters the record-standby state. From the record-standby state, press the [▶/■] button to start recording. You can record the external audio input from a mic or guitar, and the rhythm style played in Rhythm mode.

- **Rhythm mode:** Your performance is recorded along with the rhythm style playback.
- **Recorder mode:** Your performance is recorded. Your performance is also overdubbed onto the recorded song data.
- **Player mode:** Your performance is recorded along with the playback of the audio file.

In the record-standby state or during recording, the three LEDs in the left of the display operate as the recording level meter.

Left/Right buttons

- **Rhythm mode:** If the Chain function is on, these buttons move the position where you will edit the rhythm style.
- **Recorder mode:** These buttons move the recording/playback position within the song.
- **Player mode:** These buttons move the playback position within the audio file.

Play/Pause button

Starts/pauses playback or recording.

- **Rhythm mode:** Starts/stops the rhythm style playback.
- **Recorder mode:** Starts/pauses song data playback.
- **Player mode:** Starts/pauses audio file playback.

Note: If the LED above the [▶/■] button is blinking, this indicates that the data is being prepared. Please wait.

F1, F2 (Fill In) buttons

- **Rhythm mode:** Specify a fill-in for the currently selected rhythm style. In the record-standby state, these buttons select the recording-destination song number.
- **Recorder mode:** Select song data.
- **Player mode:** Select an audio file. If the playlist function is on, you can hold down the [VAR] button and use these

buttons to switch between playlist banks.

In the record-standby state, these buttons select the recording-destination song number.



VAR button

- **Rhythm mode:** Switch variations for the currently selected rhythm style. If the Chain function is on, this button returns to the beginning of the chain.
- **Recorder mode:** Stops song data recording or playback, and returns to the beginning of the song.
- **Player mode:** Stops audio file playback, and returns to the beginning of the song.



TAP END button

This button specifies the ending of the rhythm style or the tempo. To set the tempo, press this button several times. You can also press this button to hear the sound that's assigned to the metronome.

- **Rhythm mode:** When the rhythm is playing, this button switches to the ending pattern of the rhythm style. When the rhythm is stopped or when the metronome is on, this button specifies the tempo.
- **Recorder mode:** Sets the tempo of the metronome when the metronome is on.
- **Player mode:** Returns the playback speed to the original setting.
- **System mode:** Displays the names of the system items.
- **Tuner function:** Changes the tuner's guide tone.

VALUE dial

- **Rhythm mode:** Adjusts the tempo of the rhythm style or metronome (48–240).
- **Recorder mode:** Changes the tempo of the metronome when the metronome is on (48–240).
- **Player mode:** Changes the speed of audio file playback (-25%–+25%).

The VALUE dial is also used when changing various other settings.

Display

The display shows various types of information such as the tempo of the rhythm style or metronome, the playback speed of an audio file, the song data number or audio file number, the playback position, the values of various settings, the note name for the tuner function, and error messages.

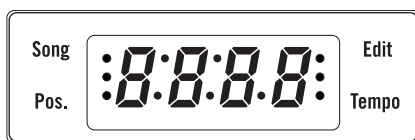

Song LED

This is lit up if the display shows a song data number or an audio file number.

Pos. LED

This is lit up if the display shows the current position in the chain function of Rhythm mode or the playback position of song data or an audio file.

Edit LED

This is lit up if you are editing or viewing various settings.

Tempo LED

This is lit up if the display shows the tempo of a rhythm style or the metronome.

REC Level LED

In the record-standby state or during recording (when the [●] button is blinking or lit), the three LEDs at the left including the Song LED and Pos. LED operate as the recording level meter. The top LED (Song LED) indicates the peak, and will light when the input is excessive.

- ▲ Adjust the recording level so that the top peak LED flickers occasionally.

Note: If the display is showing something other than the content described above, these LEDs will be unlit.

Rear panel

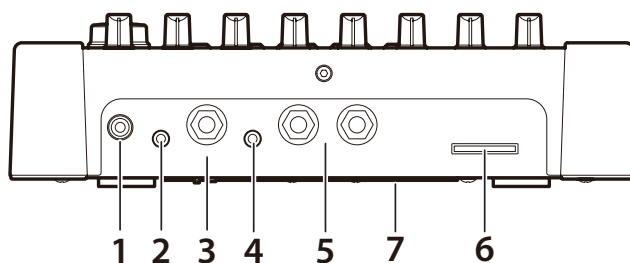

1. DC 9V jack

Connect the included AC adapter (DC 9V) here.

2. ♪ jack (stereo mini jack)

Connect your headphones here.

- ▲ You must connect a stereo plug to this jack. No sound will be output if you connect a mono plug.

3. FOOT SW jack

Connect a VOX VFS5 foot switch (commercially available) here.

You can use the foot switch to play rhythm styles and perform other operations without having to put down your instrument (see page 25 "Using a foot switch").

4. AUX IN jack (stereo mini-jack)

Connect an electronic instrument or other audio source here. You can perform along with rhythm styles played back by the KR-55 Pro or with music from your audio player. Use the controls of the connected device to adjust the volume level.

5. OUTPUT L/MONO, R jack (mono phone jack)

Connect this to an external device such as a powered monitor speaker.

6. SD card slot

Insert an SD card here (see page 7 "About SD cards").

7. Battery cover

Install six AA batteries. You can use either alkaline batteries or nickel-metal hydride batteries.

Setup

Connections

The following illustration shows a typical connection example for the KR-55 Pro. Connect your equipment as appropriate for your needs.

- ⚠ Before connecting anything, turn off the power or minimize the volume to all devices. Careless operation could damage your speaker system or cause unexpected malfunctions.
- ⚠ If you connect a mic or an acoustic guitar, acoustic feedback could occur depending on the position of the mic or acoustic guitar or the volume of the KR-55 Pro. If this occurs, take the following steps.
 - Move the external speaker away from the mic or acoustic guitar.
 - Change the direction of the mic or acoustic guitar.
 - Adjust the volume of the KR-55 Pro.

About SD cards

SD cards that can be used with the KR-55 Pro

The KR-55 Pro can use the following types of SD cards: SDHC (UHS-I) 4 GB–32 GB recommendation.

Inserting or removing an SD card

1. Make sure that the power is off.
2. Insert the SD card into the SD card slot located on the rear panel of the KR-55 Pro until you hear the card click into place.
3. To remove the SD card, push it inward until you hear it click; then release your finger.
4. The SD card pops out slightly, allowing you to remove it.

Note: For details on how to properly handle SD cards, refer to the manual included with your SD card.

- ⚠ Be sure to insert SD cards all the way, taking care that the card is oriented correctly. Do not force a card into the slot.
- ⚠ Do not insert or remove an SD card while the power of the KR-55 Pro is on. If you do so, the internal data or the data on the SD card could be lost, possibly rendering the SD card unusable.

Formatting (initializing) an SD card

An SD card that has been used with a computer, mobile phone, or digital camera cannot be used with the KR-55 Pro in that state. Before such an SD card can be used, it must be formatted by the KR-55 Pro.

You should also format the card in the following cases.

- If the display shows the error message (“Err-Crd-***”) at start-up.
- If the display shows the error message when playing or recording a song.

Formatting an SD card

Before you can format the card, you must stop recording or playback.

Note: Make sure that the SD card is inserted.

1. Press the [SYSTEM] button to enter System mode (the button lights).
2. Press the [M8] button (the button blinks).
The display indicates “Init” (Initialize), and the [Set/OK] button blinks.
3. To format the card, hold down the [Set/OK] button for approximately one second.
During formatting, the display’s “Init” indication and the [SD Card] button will blink.
When formatting has ended successfully, the display indicates “End”.

If an error occurs, the display indicates “Err.” If you want to try formatting the card again, repeat the procedure from step 2.

- ⚠ When you format an SD card, all data on the card is lost. If the card contains data that you want to keep, back it up on your computer before you format the card.

Testing whether recording can be done on an SD card

- ⚠ There are some SD cards onto which the KR-55 Pro cannot record. You can test whether a certain card can be used for recording. Refer to “SD card test function “tEst”” on page 23.

About recording time

1 Gbyte of memory allows approximately 100 minutes of recording; i.e., each minute of recording occupies approximately 10 Mbytes.

Note: These recording times are approximate. As the number of songs on the card increases, the maximum recording time decreases slightly.

Note: The recording times listed above are for the first recording of a new song. If you overdub, the used capacity is the total time that was actually recorded.

Viewing the time available for recording

Tip: Here’s how to view the time that is available for recording on the current SD card.

1. Press the [SD Card] button. Here you can check the free capacity of the SD card.
The display indicates “Sd:Fr** (free capacity).”
If the free capacity is more than one hour, the display indicates 1h, 2h, ... etc.
If the free capacity is less than one hour, the display indicates 59...00.

Note: In System mode, the display indicates “tEst” and the SD card test function is selected.

About the write protect setting of an SD card

SD cards have a write protect switch that prevents the data from being overwritten accidentally and lost. If a card is protected, you can’t save or delete data on it, use it to record with the audio recorder, or format the card.

If you need to perform these procedures, you must first set the switch to its original position.

Turning the power on/off

The KR-55 Pro can use either an AC adapter or batteries.

Using the AC adapter

- ⚠ Use only the included AC adapter. You risk causing a malfunction if you use any other AC adapter.
- 1. **Make sure that the power of the KR-55 Pro is off.**
Check that nothing is shown in the display, and that the buttons are unlit.
- 2. **Connect the DC plug of the AC adapter to the DC 9V jack located on the rear panel.**
- ⚠ Pay attention to the orientation of the jack when making this connection.
- 3. **Connect the plug of the AC adapter to an AC outlet.**
- ⚠ Be sure to use an AC outlet of the correct voltage for the adapter.

Using batteries

- ⚠ Batteries are not included. You must purchase them separately.
- 1. **Remove the battery cover from the rear panel.**
- 2. **Install six AA batteries, either alkaline or nickel-metal hydride, taking care that each battery is oriented in the correct polarity as shown in the illustration.**

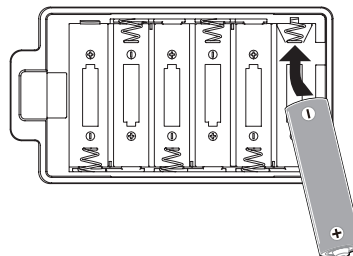

- 3. **In System mode, specify the type of batteries that you're using.**
See page 23 "[M1] Battery type "batt""
- ⚠ If you switch to using a different type of battery, be sure to specify the correct battery type in System mode.

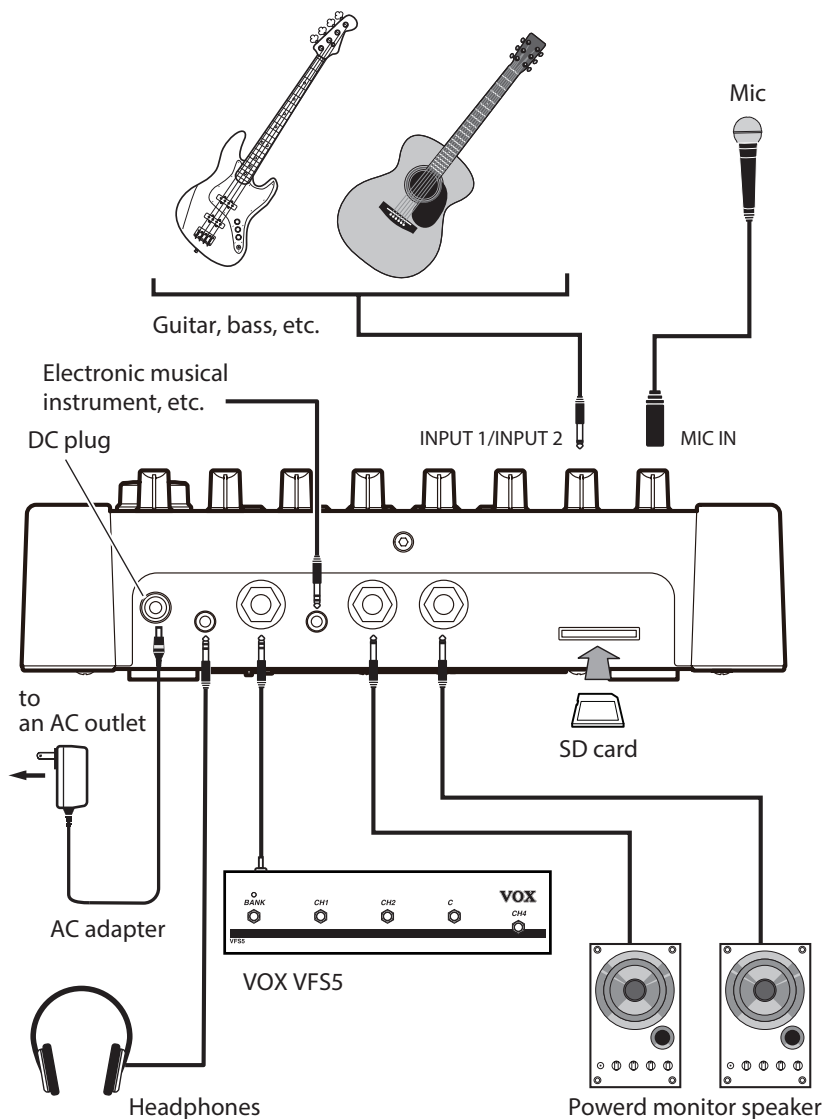

Replacing the batteries

Replace the batteries when the power button blinks.

- ⚠ As the batteries run low, you might hear noise or interruptions in the sound.
- ⚠ Unusable batteries should be removed immediately. If unusable batteries are left installed in the unit, they may leak, causing malfunctions. You should also remove the batteries if you don't plan to use the unit for an extended time.
- ⚠ Be sure to replace all six batteries together as a set. Do not mix fresh batteries with used batteries in the same set.

Turning the power on

Note: If a device is connected to the AUX IN jack, turn its power on before you continue.

Note: If you're using an SD card, insert it into the SD card slot before you turn on the power (see page 7 "About SD cards").

1. On the top panel, set the **VOLUME** knob to the **minimum level (far left)**.
2. On the top panel, hold down the **power button** for at least one second to make the button light. When the KR-55 Pro finishes starting up, it is ready to produce sound.
3. Turn on the power of the external equipment that is connected to the KR-55 Pro's **OUTPUT L/MONO and R** jacks, such as powered monitor speakers.
4. Adjust the volume on the external output device and on the KR-55 Pro.

Turning the power off

- ⚠ Never turn off the power or disconnect the AC adapter during recording, while data is being converted, or while data is being written to the system.
Doing so may make the KR-55 Pro malfunction, or damage the data on the SD card. If the data on the SD card has been damaged, format the card.

1. If recording or playback is occurring, press the [▶/■] button to stop.
2. Hold down the power button for one second or longer until the button blinks. After a time, the power button and display indication will go dark, and the KR-55 Pro will shut down.

Use caution when turning off the power!

To turn off the power of the KR-55 Pro, you must press the power button located on the panel. (When you do this, the KR-55 Pro saves its data.)

- ⚠ Never disconnect the AC adapter or remove the batteries while the power is on.

Quick Start

This quick start section explains the basic functionality of the KR-55 Pro. Start by reading this chapter to understand the basic functions; then read the subsequent chapters to delve in deeper.

Listening to the demo performances

The KR-55 Pro contains demo song data. Let's start by listening to the sound of the KR-55 Pro.

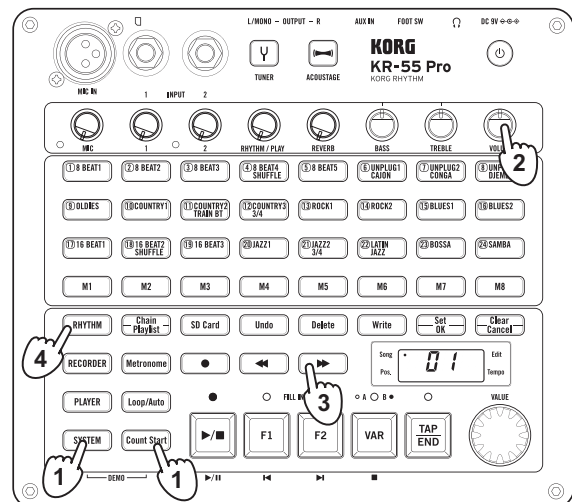

1. Simultaneously press the [SYSTEM] button and [Count Start] button to enter Demo mode. The [SYSTEM] button and [Count Start] button blink, and the demo song plays. The top panel buttons light in synchronization with the demo song.
2. Use the **VOLUME** knob to adjust the volume of the demo song.
3. You can press the [◀] or [▶] buttons to play the previous or next demo song.
4. To exit Demo mode, press any one of the mode buttons [RHYTHM], [RECORDER], [PLAYER], or [SYSTEM].

Connecting and playing instruments

The KR-55 Pro provides a mic input, two inputs for guitar or bass, and an AUX input, allowing multi-channel mixing. A variety of input sources are supported, including guitar, bass guitar, and a microphone.

Playing guitar

Here's how to connect a guitar.

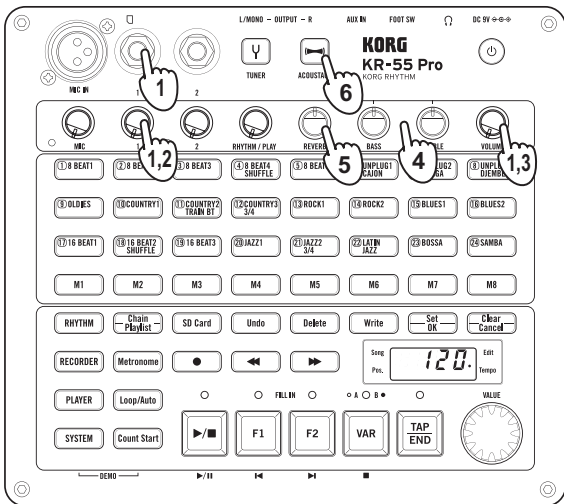

1. Set the (INPUT) 1 knob and the VOLUME knob to the minimum position, and connect your guitar to the INPUT 1 jack.
 2. Use the (INPUT) 1 knob to adjust the input level. To avoid signal clipping (signal that's too loud) this knob should be adjusted so that the peak LED doesn't light up when signal is being loudly input.
 3. Use the VOLUME knob to adjust the volume that is being outputted from the OUTPUT L/MONO and R jacks.
 4. Use the TREBLE knob and BASS knob to adjust the tone.
 5. As necessary, use the REVERB knob to adjust the effect. You can apply a reverb effect to the signals from the MIC IN jack, INPUT 1 jack, and INPUT 2 jack.
Tip: If you're using a VOX VFS5 foot switch, you can use it to turn reverb on/off.
 6. If you enable the Acoustage function by pressing the [ACOUSTAGE] button, the audio output from the KR-55 Pro will be heard in an expansive stereo field. When the Acoustage function is enabled the wide stereo effect will be applied to all audio signals output from the KR-55 Pro.
- 🔊 Turn this off when using headphones. The Acoustage function is optimal when connecting stereo speakers to the OUTPUT L/MONO and R jacks.

Using the tuner function

The KR-55 Pro has a built-in auto tuner.

Here's how to use it to tune your guitar.

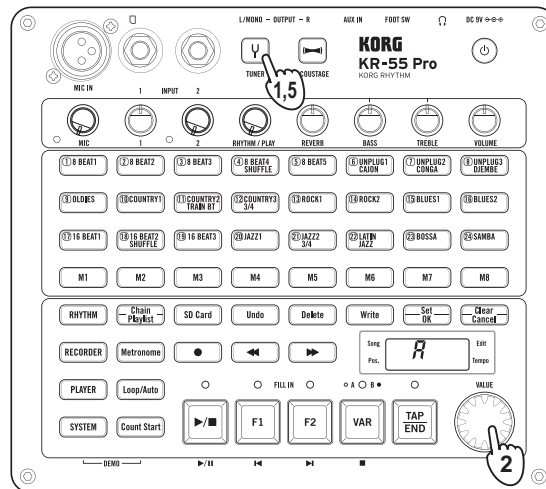

1. Press the [TUNER] button to turn on the tuner (the button lights up).
2. To change the calibration, turn the VALUE dial. You can set the calibration in a range of 435–445 Hz. By default, the calibration is set to 440 Hz.
3. Play any open string on your guitar. The note name of the string that you play will appear on the display. Tune the string roughly until the desired note name appears on the display.
1st string/6th string: "E"; 2nd string: "b"; 3rd string: "G"; 4th string: "d"; 5th string: "A"
4. Tune the string accurately while you watch the [(1) 8 BEAT1] – [(24) SAMBA] buttons. The buttons act as a meter. Tune so that only the two vertical columns in the center are lit up.

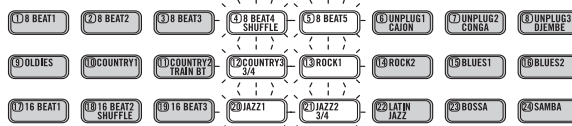

5. When you've finished tuning, press the [TUNER] button to turn the tuner function off.

Tip: When the tuner is on, you can use the [M1]–[M8] buttons of the select section to play an audible guide tone. Choose one of three sounds as the guide tone: guitar, bass, or piano. The sound is switched each time you press the [TAP/END] button.

Display	Button	Guide tone
Guit (guitar)	M1–M6	Strings 1–6 (1E, 2B, 3G, 4D, 5A, 6E)
bass (bass)	M1–M4	Strings 1–4 (1G, 2D, 3A, 4E)
Pian (piano)	M1–M8, [(17) 16 BEAT], [(18) 16 BEAT SHUFFLE], [(20) JAZZ]–[(22) BOSSA]	C, D, E, F, G, A, B, C, C#, D#, F#, G#, A#

Using a mic

Let's try connecting a mic to the MIC IN jack. Only dynamic mics can be used with the KR-55 Pro.

Condensator mics are not supported on the KR-55 Pro.

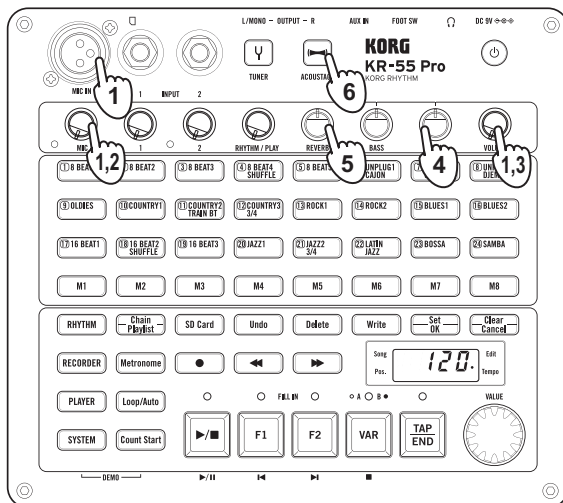

1. Set the MIC knob and VOLUME knob to the minimum position, and connect your mic to the MIC IN jack.
2. While vocalizing into the mic, use the MIC knob to adjust the mic's input level.
To avoid signal clipping (signal that's too loud) this knob should be adjusted so that the peak LED doesn't light up when signal is being input at a high volume level.
3. Use the VOLUME knob to adjust the volume that is being outputted from the powered monitor speakers connected to the OUTPUT L/MONO and R jacks.
4. Use the TREBLE knob and BASS knob to adjust the tone.
5. As necessary, use the REVERB knob to adjust the effect as desired.

Tip: If you're using a VOX VFS5 foot switch, you can use it to turn reverb on/off.

6. If you enable the Acoustage function by pressing the [ACOUSTAGE] button, the audio output from the KR-55 Pro will be heard in an expansive stereo field.

Playing and recording rhythm styles (Rhythm mode)

The KR-55 Pro has twenty-four built-in rhythm styles. You can sing or perform on an instrument while a rhythm style is being played. Your performance can also be recorded on the recorder along with the rhythm style.

Let's try out rhythm styles of various genres.

Selecting and playing a rhythm style

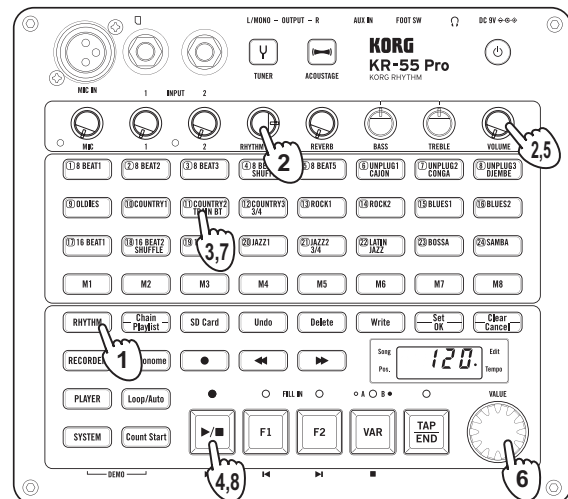

1. Press the [RHYTHM] button to enter Rhythm mode (the button lights up).
2. Set the VOLUME knob to a fairly low level, and set the RHYTHM/PLAY knob to about the 3 o'clock position.
3. Use the ([1] 8 BEAT1)–[(24) SAMBA] buttons to select a rhythm style.
The button of the selected rhythm style will light up.
4. Press the [▶/■] button to play the rhythm style.
During playback, the LED above the [▶/■] button is lit up. The [M1]–[M8] buttons blink to indicate the currently-playing measure of the rhythm style.
5. Use the VOLUME knob to adjust the volume.
6. Use the VALUE dial to set the tempo.
You can set the tempo in a range of ♩=48–240.
The display indicates the tempo value.
Tip: When rhythm playback is stopped, you can also set the tempo by pressing the [TAP/END] button several times.
7. If you press the button of a different rhythm style, playback switches to the newly selected rhythm style at the top of the next measure.
Note: Press the button slightly ahead of time so that the rhythm style will be ready to switch.
8. Press the [▶/■] button to stop playback.

Tip: You can use the chain function to create the rhythm framework for an entire song and play it consecutively (see page 18 "Chain function").

Switching variations, and inserting a fill-in or ending

Each rhythm style provides two variations. Each variation has three rhythm patterns: basic, fill-in 1, and fill-in 2.

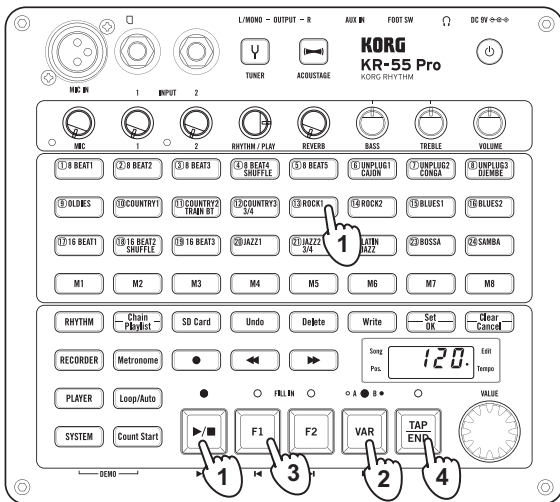

1. Select a rhythm style and play it.

See page 11 “Selecting and playing a rhythm style”

2. Press the [VAR] button to switch variations of the rhythm style.

You'll switch to variation B when the next measure begins. The LED above the [VAR] button lights up to indicate that variation B is selected.

Press the button once again to return to variation A (the LED goes dark).

3. During playback, press the [F1] or [F2] button.

A fill-in plays when the measure changes (the LED lights), and then the basic rhythm pattern returns.

Tip: From the stopped condition, you can press the [F1] or [F2] button to start playback with a fill.

4. During playback, press the [TAP/END] button.

At the next measure, an ending is played and then the rhythm style stops.

Tip: By using a VOX VFS5 foot switch, you can control the rhythm style playback while you play your instrument.

Recording your own performance together with the rhythm style

In Rhythm mode you can record your own performance along with the rhythm style.

Create a rhythm style chain ahead of time for the song that you want to perform (see page 18 “Creating a chain”). Our example here explains how to record using a chain that you've already registered.

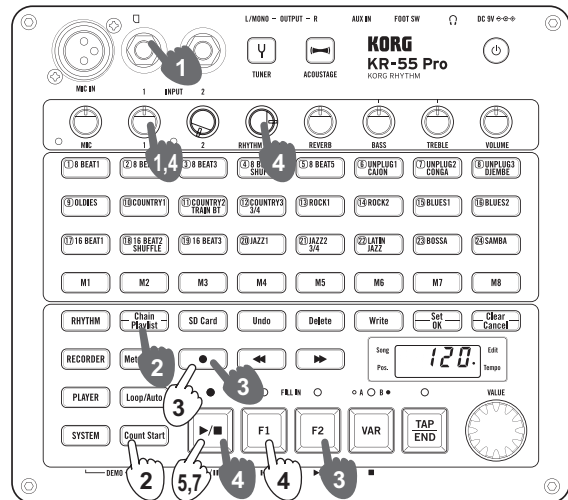

Getting ready to record

▲ The recorded data is saved on an SD card inserted in the SD card slot. In order to record, insert the SD card into the SD card slot before you turn on the power (see page 7 “Inserting or removing an SD card”).

1. Connect your mic or instrument.

See page 10 “Connecting and playing instruments”

Note: The Acoustage function cannot be used while recording.

2. Select a chain.

Press the [Chain/Playlist] button to turn the chain function on (the button lights). Use the [F1] or [F2] button to select the chain that you want to play back.

In this example, press the [F1] button to select the C01 chain. Specify the tempo as desired.

3. Put the KR-55 Pro in the record-standby state, and select the recording-destination song number.

Press the [●] button to enter the record-standby state (the button blinks).

The display indicates the song number (d01, d02...). The number of an unrecorded song blinks, and the number of an already-recorded song is lit.

Use the [F1] or [F2] button to select the song number that you want to record.

Tip: If there is an unrecorded song (new song), the lowest-numbered new song is selected automatically.

▲ If you select a previously-recorded song number (whose song number is lit) and then start recording, the previously recorded data is lost and overwritten by the newly recorded data.

4. Adjust the recording level of the rhythm style and the mic or instrument.

Set the volume of the rhythm style by turning the RHYTHM/PLAY knob to the 3 o'clock position. Use the MIC knob and the (INPUT) 1 and 2 knobs to adjust the volume level of your mic or instrument accordingly.

Note: In the record-standby state or during recording (when the [●] button is blinking or lit), the three LEDs at the left of the display operate as the recording level meter. Adjust the knobs listed above so that the top LED flickers occasionally.

To check the recording level of the rhythm style, press the [▶/■] button and make adjustments while you record.

When you've finished making adjustments, press the [▶/■] button to stop the rhythm style.

Note: The VOLUME knob does not affect the recording level. If acoustic feedback occurs, use this knob to lower the overall volume.

Start recording

1. Take the steps described in "Getting ready to record" on page 12.
2. Press the [Count Start] button to turn on the count start function (the button blinks).

Tip: The count start function inserts a two-measure count after you press the [●] button before recording starts.

3. Press the [●] button to enter the record-standby state. The LEDs above the [●] button and [▶/■] button blink.
4. Use the [F1] or [F2] button to select the song number that you want to record.

Note: Select the song number that you selected in step 3 of "Getting ready to record" on page 12.

5. Press the [▶/■] button. A two-measure count is sounded, and then recording starts. When recording starts, the LEDs above the [●] button and [▶/■] button will light up (the [Count Start] button goes dark).
6. Perform along with the rhythm style.

Tip: If you like, you can initially record just the rhythm style for which you specified a chain, and overdub your performance afterward. (See page 3 "1. Mixer section").

7. When you've finished performing, press the [▶/■] button to stop recording. You can listen to the recorded song in Recorder mode. (See page 13 "Playing back the recorded performance")

Tip: If the chain contained a stop setting, it stops automatically.

Using the recorder function (Recorder mode)

The KR-55 Pro has a built-in recorder that can record a variety of input sources. You can use this in a variety of ways, such as for reviewing your own personal practice sessions, or for keeping a record of your musical ideas.

Here we explain recording in Recorder mode. The content that you can record differs as follows depending on the mode.

- **Rhythm mode:** Your performance is recorded along with the rhythm style playback.
- **Recorder mode:** Your performance is recorded. Your performance can also be overdubbed onto the recorded song data.
- **Player mode:** Your performance is recorded along with the playback of the audio file.

Note: The BASS, TREBLE, and ACOUSTAGE effects cannot be recorded. The REVERB effect applied to the input audio from the MIC IN, INPUT 1, and 2 jacks can be recorded.

- ⚡ The recorded data is saved on an SD card inserted in the SD card slot. In order to record, insert the SD card into the SD card slot before you turn on the power (See page 7 "Inserting or removing an SD card").

Playing back the recorded performance

You'll use Recorder mode to play back the performance that you recorded on the KR-55 Pro.

1. Press the [RECORDER] button to enter Recorder mode (the button lights).
2. Use the [F1] or [F2] button to select the song number that you want to play.
3. Use the RHYTHM/PLAY knob to adjust the playback volume of the recorded performance.
 - ⚡ If you want the recorded sound to play back at the same volume as when it was recorded, turn the RHYTHM/PLAY knob all the way to the right.
4. Press the [▶/■] button to start playback.
5. Press the [▶/■] button to stop playback. To return to the beginning of the song, press the [VAR] button.

Recording your performance

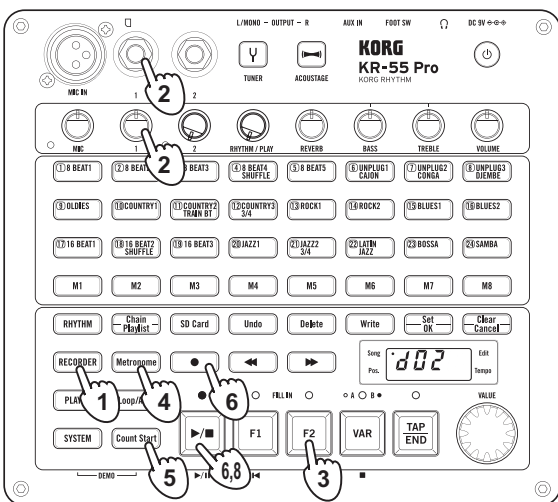

1. Press the [RECORDER] button to enter Recorder mode (the button lights up).
2. Connect the mic or instrument that you want to record, and adjust the volume.
See page 10 “Connecting and playing instruments”
3. Select a new song. Press the [F2] button until a song number blinks in the display. Blinking numbers are new songs. Numbers that remain lit up are previously-recorded songs.
Tip: On the KR-55 Pro, recorded data is called “song data,” and is handled in units called “songs.”
4. If you want to hear a metronome tone as a guide while you record, press the [Metronome] button to turn on the metronome function.
Use the [(1) 8 BEAT1]–[(16) BLUES2] buttons to select the sound of the metronome (see page 24 “Voice name list”).
By default, the metronome’s time signature is set to 4/4. If you want to change the time signature, hold down the [Metronome] button and turn the VALUE dial. You can select the time signature from the 9 choices in the range 3/4, 4/4, 4/5, 7/4, 5/8, 6/8, 7/8, 9/8, and 12/8. The display shows the time signature value.
Time signature display example: 4/4 time signature: “04:04”
5. Press the [Count Start] button to turn on the count start function (the button blinks).
6. To start recording, press the [●] button and then the [▶/■] button.
A two-measure count is sounded, and then recording starts (the [Count Start] button goes dark).
The song position in the display changes to a time indication.
7. Play your instrument.
8. When you’ve finished performing, press the [▶/■] button to stop recording.

Overdubbing onto a recorded song

Overdubbing is the process of recording additional material onto a previously-recorded song.

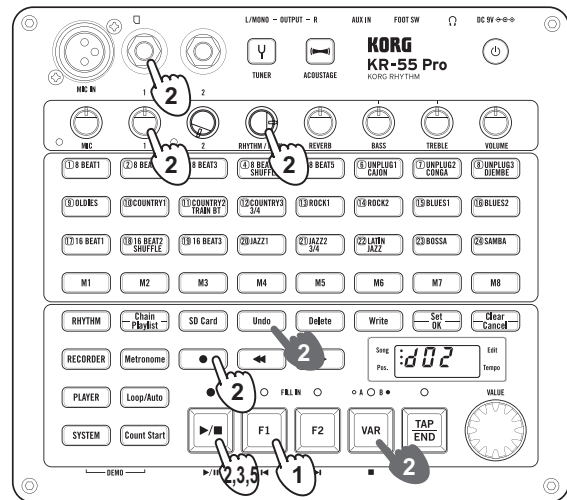

1. Use the [F1] or [F2] button to select the song that you want to overdub.
2. Adjust the playback audio and the mic or instrument recording level.
Set the volume of the playback audio by turning the RHYTHM/PLAY knob to the 3 o’clock position. Use the MIC knob and the (INPUT) 1 and 2 knobs to adjust the volume level of your mic or instrument accordingly.
▲ If you want the previously-recorded sound to be recorded at the same volume as when it was recorded, turn the RHYTHM/PLAY knob all the way to the right.
Note: In the record-standby state or during recording (when the [●] button is blinking or lit), the three LEDs at the left of the display operate as the recording level meter. Adjust the knobs listed above so that the top LED flickers occasionally.
Note: To check the recording level of the audio playback that is being recorded, press the [▶/■] button and make adjustments while you record.
When you’ve finished making adjustments, press the [VAR] button to return to the beginning of the song. After you’ve recorded and adjusted the level, press the [Undo] button to return to the state prior to recording.
Note: The VOLUME knob does not affect the recording level. If acoustic feedback occurs, use this knob to lower the overall volume.
3. To start overdubbing, press the [●] button and then the [▶/■] button.
Tip: If you press the [Count Start] button to turn on the count start function, overdubbing starts after a two-measure count is sounded.
4. Play your instrument.
5. When you’ve finished performing, press the [▶/■] button to stop recording.

Using punch-in to overdub onto a recorded song

You can play back a song and then start recording by pressing the [●] button at the moment you want to begin overdubbing.

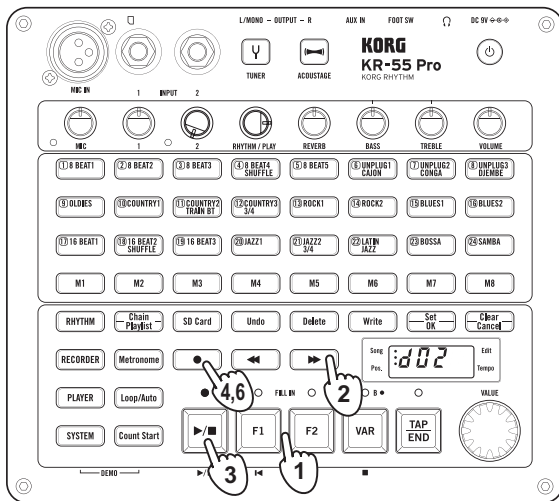

1. Use the [F1] or [F2] button to select the song where you want to add an overdub.
2. Use the [◀] or [▶] button to move to a location slightly earlier than the point where you want to punch-in. The display indicates the song position.
3. Press the [▶/■] button to start playback.
4. Just before the point where you want to overdub, press the [●] button to start recording (the button lights up).
5. Play your instrument.
6. When you've finished performing, press the [●] button to stop overdubbing. The song switches from recording to playback (the button goes dark).

Tip: If you're using a VOX VFS5 foot switch, you can use the foot switch to control punch-recording.

Tip: You can also use the mark function to record a specific region. (see page 20 "Mark function").

Returning to the state prior to recording (Undo)

You can use the [Undo] button if you're not satisfied with the recording you made.

Note: The Undo function is available only for recording in Recorder mode.

1. After recording, press the [Undo] button to return to the state prior to recording (the button will light up).
2. If you press the button once again, you'll return to the state after recording (button unlit).

Deleting a recorded song

Up to 50 songs can be recorded on one SD card. However in some cases, the number of songs that can be recorded might be less than 50 depending on the length of the recorded songs and on the capacity of the SD card.

If there is insufficient free capacity on the SD card, you'll need to either provide another SD card or delete data from the SD card.

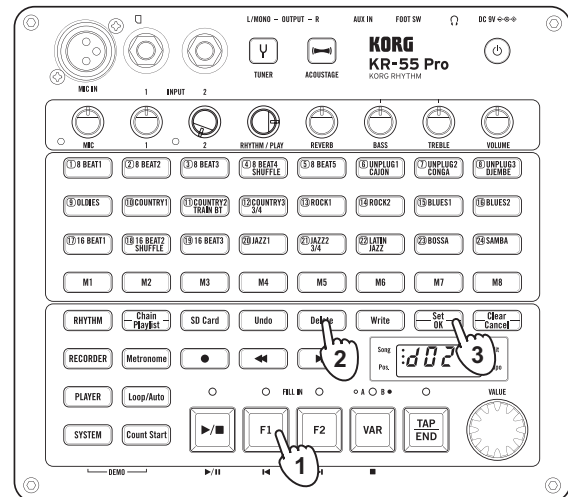

1. Use the [F1] or [F2] button to select the song that you want to delete.
2. Hold down the [Delete] button until it lights. The [Set/OK] and [Clear/Cancel] buttons blink.
3. Press the [Set/OK] button. If you decide to cancel the deletion, press the [Clear/Cancel] button. When the [Delete] button goes dark, deletion is complete.

Playing audio files and recording your performance (Player mode)

In Player mode, you can play WAV format (44.1 kHz/16-bit, stereo) audio files from the SD card.

You can also record your performance on the recorder along with the audio file that is playing back.

Playing audio files stored on an SD card

Here's how you can copy audio files from your computer to an SD card and play back those files on the KR-55 Pro.

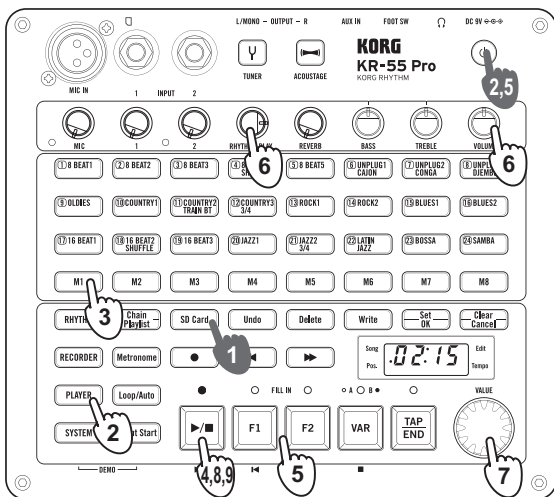

Preparing audio files

1. **Format an SD card on the KR-55 Pro.**
See page 7 "Formatting (initializing) an SD card"
2. **Power-off the KR-55 Pro, and remove the SD card.**
3. **Insert the SD card into your computer, and copy an audio file from your computer into one of the [M1]–[M8] locations in the PLAYER folder of the SD card.**
See page 24 "Folder and file structure"
4. **When you've finished copying the audio files, remove the SD card from your computer and insert it into the KR-55 Pro.**
5. **Power-on the KR-55 Pro.**

Playing back

1. **Take the steps described in "Preparing audio files" on page 16.**
2. **Press the [PLAYER] button to enter Player mode.**
The [SD Card] button lights.
The display shows the number of the audio files stored on the SD card. The first item of data on the SD card is selected. The audio files in the PLAYER folder of the SD card are shown by the KR-55 Pro in alphabetical order of their file name.
3. **Use the [M1]–[M8] buttons to select the folder on the SD card that contains the song you want to play.**
The button corresponding to the selected folder blinks.
See page 24 "Folder and file structure"
4. **Press the [▶/■] button to play the file.**
When the file has finished playing, the next file plays.

When all files in the SD card have played, playback stops.

Tip: This is because with the default settings, Loop/Auto is on, and the operating mode is LP:C1. You can change this mode (see page 22 "Loop/auto-consecutive playback function").

5. **You can use the [F1] or [F2] buttons to select an audio file to play.**
6. **Use the RHYTHM/PLAY knob to adjust the playback volume of the audio file, and use the VOLUME knob to adjust the overall volume.**
7. **During playback, you can use the VALUE dial to change the playback speed.**
You can adjust the speed in the range of $\pm 25\%$.
The value will be shown for about one second, after which the audio file number will be shown.
8. **During playback, you can press the [▶/■] button to pause.**
If you press the [VAR] button, playback stops and you return to the beginning.
9. **Press the [▶/■] button once again to start playback from the paused location.**

Tip: In Player mode, you can use the playlist function to play only the files you want in a specific order (see page 22 "Playlist function").

Recording your own performance together with the audio file playback

Just as you can record your performance together with a rhythm style, you can record your performance together with an audio file that's playing.

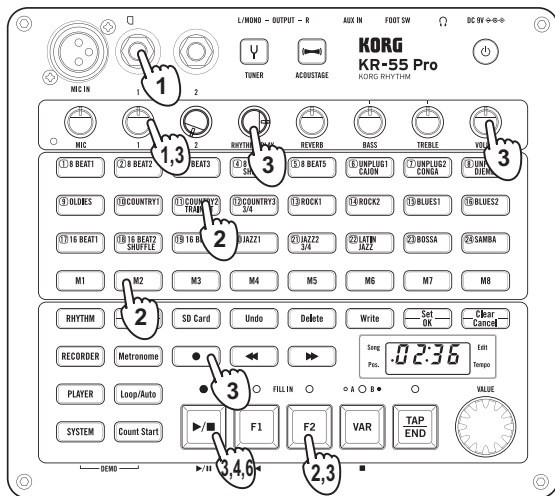

▲ The recorded data is saved on an SD card inserted in the SD card slot. In order to record, insert the SD card into the SD card slot before you turn on the power (see page 7 “Inserting or removing an SD card”).

1. Connect the mic or instrument that you want to record, and adjust the volume accordingly.

See page 10 “Connecting and playing instruments”

2. Use the [M1]–[M8], [(1) 8 BEAT1]–[(24) SAMBA] buttons or the [F1] and [F2] buttons to select an audio file.

3. Put the KR-55 Pro in the record-standby state, and select the song number that you want to record.

Press the [●] button to put the KR-55 Pro in the record-standby state, and then use the [F1] or [F2] button to select the song number that you want to record.

The display indicates the song number (d01, d02...). The number of a new song blinks, and the number of an already-recorded song is lit.

Tip: If there is a new song, the lowest-numbered new song is selected automatically.

- ▲ If you select a previously-recorded song number (whose song number is lit) and then start recording, the previously recorded data is lost and overwritten by the newly recorded data.

- **Adjust the playback of the audio file and the mic or instrument recording level.**

Set the volume of the audio file by turning the RHYTHM/PLAY knob to the 3 o'clock position. Use the MIC knob and the (INPUT) 1 and 2 knobs to adjust the volume level of your mic or instrument accordingly.

Note: Adjust the level so that the top LED of the three LEDs in the left side of the display flickers occasionally.

Note: Note: To check the recording level of the audio file, press the [▶/■] button to put the KR-55 Pro in the

recording state. When you've finished adjusting the level, press the [▶/■] button to stop; then re-select the song in the record-standby state.

Note: The VOLUME knob does not affect the recording level. If acoustic feedback occurs, use this knob to lower the overall volume.

4. Press the [▶/■] button to start recording.
The LEDs above the [●] button and [▶/■] button are lit.
5. Play your instrument along with the playback of the audio file.
6. When you've finished performing, press the [▶/■] button to stop recording.
You can listen to the recorded song in Recorder mode (see page 13 “Playing back the recorded performance”).

Tip: You can import data that can be used in Recorder mode, and then use Recorder mode to overdub onto that data. (see page 14 “Overdubbing onto a recorded song”)

Note: When recording in Player mode, you can't start recording from a specific point of the playback, nor can you record just a specific region. You can only record from the beginning of the audio file. If you want to record from mid-way through the playback, or only in a specific region, you'll need to use the import function.

Rhythm mode

In Rhythm mode you can play back rhythm styles and record your performance, and also use the following functions.

- A “memory function” that lets you register your favorite rhythm variations and performance tempo.
- A “chain function” that lets you create rhythm styles for an entire song by specifying a rhythm style for each measure.
- A “metronome function” that lets you sound the metronome in the time signature and tempo that you specify.
- A “count start function” that lets you insert a two-measure count when playing back a rhythm style.

The “Rhythm mode” section further explains these functions. For a guide to basic operation, refer to “Playing and recording rhythm styles (Rhythm mode)” on page 11.

Registering a rhythm variation and tempo to the [M1]–[M8] buttons

You can register a favorite rhythm variation and playback tempo to each of the [M1]–[M8] buttons.

Registering a rhythm variation and tempo

1. Select the rhythm variation that you want to register, and specify the tempo.

Note: You cannot register a fill-in or ending.

2. Press the [▶/■] button to stop the rhythm style.
3. Hold down the [Set] button and press one of the [M1]–[M8] buttons.
The rhythm style’s variation and tempo are registered.

Cancelling a registered rhythm variation and tempo

1. With the rhythm style stopped, hold down the [Clear/Cancel] button and press the button whose registration you want to cancel.
The registered content is cancelled.

Using the memory buttons to recall a registration

Tip: When the unit is shipped from the factory, a rhythm style and tempo is already assigned to each of the [M1]–[M8] buttons.

1. While the rhythm style is stopped, press one of the [M1]–[M8] buttons to select the rhythm that’s registered to that button.
The rhythm style switches to the variation and tempo that are registered to that button.
[M1]–[M8] buttons to which a variation and tempo are registered are lit when the rhythm style is stopped.
When you press a button to select a rhythm, it changes to blinking.
2. Press the [▶/■] button.
The rhythm style variation registered to that button plays.

Chain function

The chain function lets you create the rhythm track for an entire song by specifying a rhythm style for each measure.

Creating a chain

1. Press the [Chain/Playlist] button to turn on the chain function (the button lights up).
2. Use the [F1] button and [F2] button to select the chain bank.
You can create up to 30 banks of chains. When the KR-55 Pro starts up, the first chain (C01) is selected.
3. Hold down the [Chain/Playlist] button until it blinks. The three buttons [Chain/Playlist], [Set/OK], and [Clear/Cancel] blink, indicating that you can now register a rhythm style for each measure.

The LED of the [▶/■] button blinks when the rhythm style is playing.

The display indicates the measure number. The [M1]–[M8] buttons blink as a guide to eight-measure units of the specified measure location.

If you’ve selected a chain where a rhythm style is already registered, you’ll hear the rhythm style that is registered at the first measure or at the specified measure.

If no rhythm style has yet been registered for the chain, you’ll hear the “8 BEAT1” rhythm style, which is registered by default for the first measure.

4. Specify the tempo.
5. Use the [(1) 8 BEAT1]–[(24) SAMBA] buttons, [VAR] button, [F1] button, and [F2] button to specify the rhythm style, variation, and fill-in that you want to register.
6. Press the [Set/OK] button to confirm registration of the rhythm style.
The rhythm style is registered to that measure, and you move to the next measure. For measures where the registration has been completed, the corresponding button ([M1]–[M8]) changes to steadily lit up.
7. To specify the measure where you want to register a rhythm style, use the [◀] or [▶] button.
8. Repeat steps 5–7 to continue the registration process.
You can register rhythm styles for up to 999 measures in one chain.
9. To cancel the rhythm style of the specified measure, press the [Clear/Cancel] button.
The [M1]–[M8] button corresponding to that measure goes dark.
10. If you want to add one measure before the specified measure, hold down the [Set/OK] button for approximately one second. If you want to delete the specified measure, hold down the [Clear/Cancel] button for approximately one second.
11. To register the position of the last measure, press the [▶/■] button to make the LED go dark, and then press the [Set/OK] button. If you want to register an ending pattern to end the performance, press the [TAP/END] button to make the LED light up, and then press the [Set/OK] button.

12. When you are finished registering rhythm styles, press the [Chain/Playlist] button (the button lights up). All settings and the tempo are confirmed at this time.
13. To hear the newly created chain from the first measure, press the [VAR] button to return to the first measure, and then press the [▶/■] button to play back.

Playing the chain you created

1. With the [Chain/Playlist] button lit up, press the [▶/■] button.
The registered rhythm styles play, starting from the first measure. When playback reaches the last measure, it stops. During playback, you can press the [▶/■] button to pause. Press the button once again to resume playback from the paused location.
If you press the [VAR] button during playback, playback stops and you return to the first measure.

Deleting all rhythm styles registered to the entire chain

1. Use the [F1] and [F2] buttons to select the chain from which you want to delete all the rhythm styles you registered.
The number of the selected chain (C**) appears in the display.
2. Hold down the [Delete] button until it lights.
The [Set/OK] and [Clear/Cancel] buttons blink. The chain number shown in the display blinks.
3. Press the [Set/OK] button.
When the [Delete] button goes dark, deletion is complete. The chain now has the default settings (the 8 BEAT1 rhythm style is registered).

Metronome function

This lets you sound the metronome in the time signature and tempo that you specify.

1. Press the [Metronome] button to turn on the metronome (the button lights up).
2. Use the [(1) 8 BEAT1]–[(16) BLUES2] buttons to select a sound for the metronome.
3. Use the VALUE dial to set the tempo of the metronome.
Tip: You can also use the [TAP/END] button to set the tempo.
4. Use the RHYTHM/PLAY knob to adjust the volume of the metronome.

Note: The sound of the metronome is not recorded even if you record while the metronome is playing.

Note: In Rhythm mode, you can choose whether to play the metronome or a rhythm style. If the metronome is playing, pressing the [▶/■] button turns the metronome off, and switches to rhythm style playback.

In Recorder mode, only the metronome can be used. In Player mode, neither can be used.

About the metronome time signature

The metronome time signature is normally set to 4/4 (while you hold down the [Metronome] button, the display shows "04:04"). If you want to change the time signature, hold down the [Metronome] button and turn the VALUE dial. You can choose from the following time signatures: 3/4, 4/4, 5/4, 7/4, 5/8, 6/8, 7/8, 9/8, and 12/8.

Count start function

The count start function inserts a two-measure count before the rhythm style plays.

- 🔊 The count has the same time signature as the rhythm style.

Using the count start function

1. Press the [Count Start] button to turn on the count start function (the button blinks).
2. Press the [▶/■] button.
A two-measure count sounds, and then the rhythm style starts (the [Count Start] button goes dark).

Tonal character when the tempo/ playback speed is adjusted

In the KR-55 Pro's Rhythm mode, dedicated audio data for the rhythm styles are played back.

Multiple audio data are provided so that each audio data will provide a natural performance in its tempo range. When you adjust the tempo, the audio data being played back may be switched depending on the range of the adjustment; this can cause the character of the sound to differ somewhat depending on the tempo.

Recorder mode

The KR-55 Pro can record a variety of input sources, such as the performance of an instrument connected to the INPUT 1 jack or INPUT 2 jack, the vocal from a mic connected to the MIC IN jack, or an electronic instrument connected to the AUX IN jack.

The recorded data is saved in 44.1 kHz/16-bit stereo WAV format on an SD card inserted in the SD card slot.

You can record up to 50 songs on an SD card inserted in the SD card slot. However in some cases, the number of songs that can be recorded might be less than 50 depending on the length of the recorded songs and on the capacity of the SD card.

For additional details on basic operation, refer to “Registering a rhythm variation and tempo to the [M1]–[M8] buttons” on page 18.

⚠ If the display shows an error message such as Crd - bSy (Card-Busy) or “Err-Crd-***” (Error Card ***) during playback or recording, please format the card (see page 7 “Formatting (initializing) an SD card”).

The KR-55 Pro provides the following functions that are useful when recording.

- A “metronome function” that lets you sound the metronome during recording in the time signature and tempo that you specify.
- A “count start function” that inserts a two-measure count when you start recording.
- A “mark function” that lets you register a location within a song, and recall that location when you record.
- A “loop-playback and region-record function” that lets you loop-playback or record in a region between specified marks.

These functions are explained in depth in the “Recorder mode” section.

Metronome function

This lets you sound the metronome during recording in the time signature and tempo that you specify. In Recorder mode the metronome volume is fixed, and cannot be controlled by the RHYTHM/PLAY knob.

Additionally, in Recorder mode only the metronome can be used.

Other operation is the same as in Rhythm mode.

Tip: The sound of the metronome is not recorded when you record while the metronome is playing.

See page 19 “Metronome function”

Count start function

The count start function inserts a two-measure count before recording starts.

1. Press the [Count Start] button to turn on the count start function (the button lights up).
2. Press the [●] button and then press the [▶/■] button. A two-measure count is sounded, and then recording starts.

Tip: If you want to use the count start function when overdubbing, you must set the tempo to match your song.

About the count time signature

The time signature of the count is shared with the metronome. If you want to change it, hold down the [Metronome] button and turn the VALUE dial.

Mark function

This function lets you register a mark at a desired location within a song, and then recall that location when needed, such as when recording. You can register marks at eight locations in a song, and move directly to a registered mark by pressing a button.

Registering a mark

1. Use the [F1]/[F2] buttons to select a song.
2. Press the [▶/■] button to play the song.
3. At the location at which you want to register a mark, hold down the [Set/OK] button and press one of the [M1]–[M8] buttons (the button lights).
4. Press the [▶/■] button to stop the song.
5. Press the [M1]–[M8] button that you registered. You move to the location in the song at which you registered the mark.

Deleting a mark

1. Hold down the [Clear/Cancel] button and press the button ([M1]–[M8]) in which you registered the mark that you want to delete. The mark registered to the button you pressed is deleted (the button goes dark).

Loop recording/playback function

You can loop-playback or record the region between marks that you specify.

Playing a loop or recording a region

Here we explain how to loop-playback and record the region between the marks registered to the [M1] button and [M2] button.

1. **Press the [Loop/Auto] button to turn the loop function on (the button lights up).**
2. **Press the [M1] button to specify the loop-start location.**
The button blinks, and the loop region is specified as the region between the locations registered to the [M1] and [M2] buttons.

Note: Allow at least two seconds for the loop region.

The loop region is the region between the loop-start location and the location registered to the next button to the right. For example if you specify the [M1] button as the loop-start location, the loop region is the [M1]–[M2] region; if you specify the [M2] button as the loop-start location, the loop region is [M2]–[M3]. If no mark is registered to the next-numbered button, the loop setting is ignored. You can't specify the [M8] button as the loop-start location.

3. **Press the [▶/■] button.**
Loop playback occurs between the locations of the [M1] button and [M2] button.
4. **Press the [●] button.**
After playback reaches the end of the loop region, recording begins from the loop-start location.
5. **Play your instrument to record it.**
Recording ends when you reach the end of the loop region, and loop playback resumes.
If you want to continue overdubbing, press the [●] button again and repeat the process.
6. **Press the [▶/■] button to stop recording.**

Exporting song data

Song data that you record can be exported (written) as an audio file to the SD card.

The exported audio file can be played back using the KR-55 Pro's Player mode or a commercially available audio player, or loaded into your computer DAW.

The exported audio file is in the following format.

- File format: WAVE format uncompressed linear PCM
- Bit depth: 16-bit
- Sampling frequency: 44.1 kHz
- File name: SONGnnnn.WAV (the four characters "nnnn" are an automatically assigned consecutive number)

Export procedure

1. **Use the [F1] or [F2] buttons to select the song that you want to export.**
2. **Press the [Write] button.**
3. **Press the [Set/OK] button to export the song.**
If you decide to cancel, press the [Clear/Cancel] button.
The exported data is saved in the M1 folder of the SD card.
When exporting is complete, the [Write] button goes dark and the four-digit number of the exported file is displayed.

 The time required for exporting depends on the amount of free space on the SD card and on the length of the song you're exporting.

Importing an audio file

An audio file in the SD card can be imported (loaded) into song data that you can use in Recorder mode. The imported data can be played or overdubbed in Recorder mode.

 An audio file that can be played in Player mode cannot be directly played back in Recorder mode. The file must be imported as Song data that can be played in Recorder mode.

Audio files of the following format can be imported.

- File format: WAVE format uncompressed linear PCM
- Bit depth: 16-bit
- Sampling frequency: 44.1 kHz, stereo files

Import procedure

1. **In Player mode, use the [F1] or [F2] buttons to select the audio file that you want to import.**
2. **Press the [Write] button.**
3. **Use the [F1] or [F2] button to select the import-destination song number.**
The display indicates the song number (d01, d02...). The number of a new song blinks, and the number of an already-recorded song is lit.
Tip: If there is a new song, the lowest-numbered new song is selected automatically.
 If you select an already-recorded song (whose song number is lit) and begin the import, the selected song data is erased and overwritten by the imported data.
4. **Press the [Set/OK] button to import the song.**
If you decide to cancel, press the [Clear/Cancel] button.
The imported song data is placed in the song number that you specified.
The imported data is saved in the D*** folder of the SD card.

Player mode

In Player mode you can play back audio files from an SD card.

Audio files of the following formats can be played.

- WAV format (44.1 kHz / 16-bit)

While an audio file plays in Player mode, you can perform on an instrument connected to the KR-55 Pro or record your performance (see page 17 “Recording your own performance together with the audio file playback”).

 A song that you record in Recorder mode cannot be played back directly in Player mode. It must be converted into an audio file that can be played in Player mode.

Player mode has the following functions that are useful when playing audio files.

- A “playlist function” that lets you register audio files in a playlist and play them in the order you specified.
- A “loop/auto-consecutive playback function” that lets you loop the playback or automatically play files in succession.

These functions are further explained in this section, “Player mode.” For additional details on basic operation, refer to “Playing audio files and recording your performance (Player mode)” on page 16.

Playlist function

There are ten playlist banks; you can register up to 24 audio files in each bank, and play those files in the order you specify.

Creating a playlist

1. Press the [Chain/Playlist] button to turn the playlist function on (the button lights up).
2. Hold down the [VAR] button, and use the [F1] and [F2] buttons to select the playlist that you want to create.
3. Hold down the [Chain/Playlist] button until it blinks. The [Chain/Playlist] button and [Set/OK] blink; the KR-55 Pro is waiting for you to register an audio file.
4. Use the [M1]–[M8] buttons to select a file bank, and use the [F1] and [F2] buttons to select the audio file that you want to register. The display indicates the audio file number.

Tip: You can use the [M1]–[M8] buttons to select folders M1–M8 on the SD card (see page 24 “Folder and file structure”).

5. Press one of the [(1) 8 BEAT1]–[(24) SAMBA] buttons to register the selected audio file at the corresponding position of the playlist. The [(1) 8 BEAT1]–[(24) SAMBA] buttons correspond to the locations where up to 24 songs can be registered in a playlist. You create a playlist by assigning an audio file to each button. The file assigned to the [(1) 8 BEAT1] button is the first song, the file assigned to the [(2) 8 BEAT2] button is the second song, etc. The button lights when you register a file to it.
6. Repeat steps 4 and 5 to register audio files in the playlist.

Tip: To cancel a registration, press the [Clear/Cancel] button and then press the button [(1) 8 BEAT1]–[(24) SAMBA] for the audio file you want to unregister. The registration is cancelled, and the button goes dark.

7. When you are finished registering audio files to the playlist, press the [Chain/Playlist] button (the button lights up). The [Set/OK] button and [Clear/Cancel] button go dark.

Playing a playlist

1. Press the [Chain/Playlist] button to turn on the playlist function (the button lights up).
2. Hold down the [VAR] button, and use the [F1] and [F2] buttons to select the playlist (P01, P02...) that you want to play.
3. Use the [(1) 8 BEAT1]–[(24) SAMBA] buttons to select the audio file that you want to play.
4. Press the [▶/■] button to start playback.
5. The audio files play in the order they are registered in the playlist.

Loop/auto-consecutive playback function

In Player mode you can make files play as a loop or consecutively.

1. Press the [Loop/Auto] button to turn the loop/auto-consecutive function on (the button lights up).
2. Press the [▶/■] button. The player starts playback. When one audio file finishes playing, the next file automatically starts playing. The files play consecutively until the last file has finished playing.

This is how operation occurs if the operating mode is set to LP:C1. You can change the operating mode if you like. Make this setting in step 3.

If this is off, when one file finishes playing or recording, the position returns to the beginning of that file.

3. To change the operating mode, hold down the [Loop/Auto] button and turn the VALUE dial.

LP:1L: Loop one file

LP:AL: Loop all files

LP:C1: Play consecutively (no looping, normal operation)

LP:C2: Play consecutively (no looping, pause between files) You can also use the play button of the panel or of a connected foot switch to play the next file at the desired time.

Adjusting the playback speed

You can change the playback speed of an audio file in a range of -25%–+25% without affecting the pitch.

1. Use the VALUE dial to change the playback speed of the audio file.
2. If you press the [TAP] button, the speed returns to the original setting.

Note: The audio quality might be degraded if you change the playback speed of an audio file beyond a certain range.

Note: You can't change the playback speed of song data in Recorder mode.

System mode

In System mode you can adjust the following settings that affect the overall operation of the KR-55 Pro.

Making system settings

1. Press the [SYSTEM] button to enter System mode (the button lights up).
2. Use the [M1]–[M4] buttons to select a system setting item. The button that you pressed blinks. An abbreviated name of the selected function is shown on the display for approximately one second, and then the current value of the setting is shown.
3. Use the VALUE dial to change the setting.
4. Press a different mode button to exit System mode.

Setting items

For the procedure, refer to “Making system settings.”

[M1] Battery type “batt”

Specifies the type of batteries that are installed.

aL: Alkaline batteries

nH: Nickel-metal hydride batteries

⚠ If you specify a type of battery that is different than the batteries actually installed, the remaining battery capacity is not displayed correctly.

Note: If you are using the KR-55 Pro on batteries, and you press the [M1] button to select this item, the [(1) 8 BEAT1]–[(16) BLUES2] buttons light to indicate the remaining battery capacity. The lower the batteries are, the fewer buttons will be lit.

[M2] Effect operation “EFF”

Specifies the input jack(s) where the reverb effect is applied.

AL: MIC IN jack, INPUT 1 jack, INPUT 2 jack

M: MIC IN jack

In: INPUT 1 jack, INPUT 2 jack

[M3] Auto power-off function “APOF”

Specifies the time after which auto power-off operates.

oF: Auto power-off function is off

10: 10 minutes

30: 30 minutes

1h: 1 hour

4h: 4 hours

Formatting an SD card [M8] “Init”

Formats an SD card. (“Formatting an SD card” on page 7)

SD card test function “tEst”

This function tests a SD card by automatically reading and writing data to the card to determine whether the card is compatible with the recorder. The recorder will decide that a card is not compatible if the writing speed of the card is slower than the speed required for recording. Executing this test enables you to discover the recording conditions required for the card. In this way, you can use the card more efficiently.

⚠ The results of this test do NOT absolutely guarantee the operation of a card. Even if the recorder determines that your card can be used for recording based on the test results, the card may still cause an error (such as “Crd - bSy (Card-Busy)”) depending on recording conditions or the application environment.

Note: Make sure that the SD card is inserted.

1. Press the [SYSTEM] button to enter System mode (the button lights).
2. Press the [SD Card] button (the button is lit). The display indicates “tEst” (test), and the [Set/OK] button and the [Clear/Cancel] button blink.

Note: In other modes, pressing the [SD Card] button makes the display show the time available for recording.

3. To execute the card test, hold down the [Set/OK] button for approximately one second. During execution, the display blinks “tEst,” and the [Clear/Cancel] button blink.

Note: Depending on the type of SD card, the test may take some time.

If you decide to cancel the test, press the [Clear/Cancel] button.

When the test is completed, the display shows the test result.

Good: Recording is possible on this SD card.

bad: Recording to this SD card has some limitations.

MODE	Good	bad	Limitations
RHYTHM	○	×	Can't Record
RECORDER	○	△	Recording is available, but overdubbing is not.
PLAYER	○	△	Recording is not available, only playing WAV files.

Note: If you want to try the test again, repeat the procedure from step 2.

Appendix

Voice name list

Metronome

No.	Name	No.	Name
1	Metronome (Wood)	9	Closed HH 1
2	Metronome (Electronic)	10	Closed HH 2
3	Analog Clave	11	Analog HH 1
4	Analog Woodblock 1	12	Analog HH 2
5	Analog Woodblock 2	13	Maracas
6	Analog Bongo	14	Tambourine
7	Cowbell	15	Bass Drum
8	Sidestick	16	Hand Clap

Demo songs

1. Demo Song 1: Introduction to rhythm and functions
2. Demo Song 2: Demo song (Pops); song title "Open Heart"
3. Demo Song 3: Demo song (Blues); song title "Day In and Day Out"

Data structure on the KR-55 Pro

An SD card formatted and recorded on the KR-55 Pro has the following structure.

Folder and file structure

Recorder mode

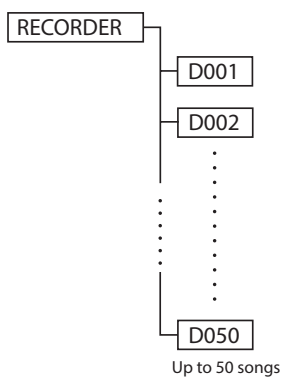

1. RECORDER (data folder)

The KR-55 Pro's system data and recorded data are saved here.

50 song folders are created in this folder.

Note: Depending on the capacity of the SD card you're using, it might not be possible to create 50 song files.

[RECORDER]: Song data folder for Recorder mode.

If you want to make a backup of the Recorder mode data, or use Recorder mode data on another SD card, use your computer to copy the [RECORDER] folder.

2. D001 (song folder)

This folder is created for each song when you record on the KR-55 Pro. New songs are created consecutively, starting with D001. The three digit number following "D" is the song number.

Tip: Songs exported in Recorder mode are saved in the [PLAYER] folder.

[D001]–[D050]: Song data folders.

Each song data folder contains recording data files and management files.

Player mode

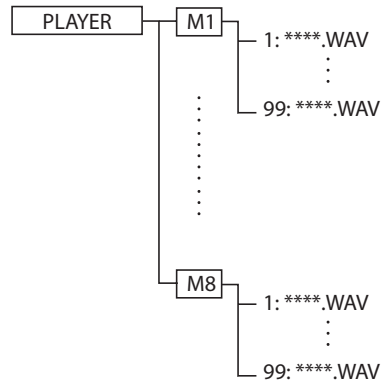

3. PLAYER folder

This is used when playing external audio files (WAV).

[PLAYER]: Audio data folder for Player mode

4. External WAV files

These are external files for playing or overdubbing on the KR-55 Pro.

The following formats can be played or overdubbed.

File format: WAV files

File bit depth: 16-bit

Sampling frequency: 44.1kHz

Channel: Stereo

[M1]–[M8]: Data folders for audio files

******.WAV:** Audio files

Up to 99 files can be used in each folder. If you have audio files that you want to play or overdub on the KR-55 Pro, copy them from your computer into these folders.

If you record a song in Recorder mode and use the export function to convert it to an audio file, that file is added to the M1 folder. The file name is "SONG****.WAV." "****" is a consecutive number that's assigned automatically.

Using a foot switch

If you connect a VOX VFS5 foot switch (commercially available) to the rear panel FOOT SW jack, you can use your foot to switch programs or perform recording operations.

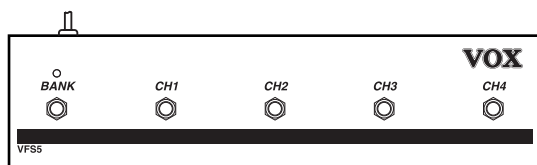

Each switch has the following function.

Switch	Rhythm mode	Recorder mode	Player mode
BANK	Play/Stop	Play/Pause	Play/Pause
CH1	Select fill-in 1 (when the Chain function is on, bank selection-)	Record	Select songs -
CH2	Select fill-in 2 (when the Chain function is on, bank selection-)	Stop	Select songs +
CH3	Switch variations	Move the song position -	Move the audio data position -
	Reverb on/off (while stopped, hold down for approximately one second)		Reverb on/off (while stopped, hold down for approximately one second)
CH4	Select ending (When the rhythm is playing)	Move the song position +	Move the audio data position +
	Tap tempo (When the rhythm is stopped or when the metronome is on)		

Tip: If reverb is on, the setting of the REVERB knob is applied.

Tip: In Rhythm mode when using the CH4 switch to adjust the tempo, the sound assigned to the metronome is heard each time you press the switch.

⚠ Turn off the power before you connect or disconnect the foot switch to the FOOT SW jack. If you connect or disconnect it when the power is on, you risk malfunctions or damage.

⚠ Do not press more than one switch at the same time. This could cause a malfunction.

Note: The BANK switch LED has no function on the KR-55 Pro.

Troubleshooting

1. Power won't turn on

- Is the AC adapter's DC plug connected to the rear panel DC 9V jack?
- Is the AC adapter's power plug connected to an AC outlet?
- Is the AC outlet working correctly?
- If you're using batteries, are they installed correctly?

2. No sound (or insufficient volume) is coming from the OUTPUT L/MONO, R and Ω jack.

- Could the guitar's volume be turned down?
- Is the guitar cable connected correctly?
- Could the guitar cable be broken?
- Could the top panel VOLUME knob be set to a low setting?
- Check the settings of the (INPUT) 1 knob, (INPUT) 2 knob, and MIC knob.

3. No sound from a device connected to the AUX IN jack

- Is the external device connected correctly?
- Could the external device's volume be turned down?

5. Can't play rhythm styles

- Could something other than Rhythm mode be selected?
- Could the top panel RHYTHM/PLAY knob be set to a low setting?
- Could the metronome be on?
If the metronome is on (LED lit up), rhythm styles won't play; the metronome sound is heard.

5. Can't switch rhythm styles or memories

- Could Chain be turned on ([CHAIN] button lit)?
- You can't switch memories during playback.

6. Can't record

- Is the input level set correctly?
- Is an SD card inserted? (see page 7 "About SD cards")
- Is there free capacity on the SD card?
- Is it an SD card that the KR-55 Pro can use for recording? (see page 23 "SD card test function "tEst"")

7. Recorded sound is unsatisfactory or interrupted

- Is the input level set appropriately?
- Could the KR-55 Pro have been subjected to an impact during recording?
- Is the reverb effect set correctly?

8. Can't play songs or audio files; no playback is heard

- Is an SD card inserted?(see page 7 "About SD cards")
- Does the SD card contain data?
- Could the top panel RHYTHM/PLAY knob be set to a low setting?
- Could the KR-55 Pro be in a mode other than Player mode or Recorder mode?

9. Can't enter Recorder mode or Player mode

- Is an SD card inserted?
- If you cannot enter Player mode, does the SD card contain a playable audio file (WAV 44.1 kHz 16-bit stereo)?

Error messages

If an error occurs on the KR-55 Pro or on the SD card, the display shows the following messages.

Crd - bSy (Card-Busy)

The SD card has a slow access speed, and cannot keep up with recording or playback. Use a different SD card.

- As you repeatedly write or delete songs, the order of the songs on the SD card can become discontinuous, lowering the processing capability. If this occurs, back up the important songs to your computer, and then format the SD card before using it further.

Err - Crd - * (Card Error)**

An error occurred while accessing the SD card. Connect the SD card to your computer and check it. If an error message is displayed, format the SD card.

Err/Un-/SUP/Frt (Error Unsupported [File] Format)

The music data is in a format that the KR-55 Pro cannot play.

Crd - FUL (Card Full)

The SD card has insufficient free capacity. Delete unneeded songs.

Err - FSy - * (File System Error)**

An error occurred during SD card processing. If this occurs frequently even after you've switched to a different SD card, please contact your country's Korg Distributor.

no-Crd (No Card)

No SD card is inserted.

no-dat (No data)

The SD card does not contain a playable audio file.

Un - Frt (Unformat)

The SD card is not formatted.

Other messages

Other messages may be displayed if the KR-55 Pro experiences an internal problem or malfunction. Please contact your country's Korg Distributor.

Specifications

Rhythm function

Rhythm Styles: 24 rhythm styles, two variations for each rhythm style, each variation has three patterns (basic, fill-in 1, fill-in 2).

Tempo: 48–240 bpm

Chain function: 30 banks (up to 999 measures can be registered in each)

Recorder function

Recording format: PCM audio WAV format (file name extension .wav), 44.1 kHz, 16-bit

Recording time: Depends on the SD card used; approximately 100 minutes per 1 GB

Maximum continuous recording time: 3 hours

Number of songs: Maximum 50

Number of multitrack recordings: Depends on the remaining free capacity of the SD card

Undo/Redo: Once

Player function

Playback formats: PCM audio WAV format (file name extension .wav) 44.1 kHz, 16-bit, Stereo

Maximum data size (time): Depends on the memory card used; approximately 100 minutes per 1 GB (for WAV data)

Maximum number of data files (number of folders): Up to 99 songs (per folder); a total of eight folders M1–M8 inside the PLAYER folder can be used.

Playlist function: 10 banks (up to 24 songs can be registered in each)

Mixer effect section

Effects: Reverb effect

Equalizer: BASS, TREBLE

ACOUSTAGE (wide stereo effect)

Tuner function

Scale: 12-note equal temperament

Chromatic

Calibration: 435–445 Hz

Tuning guide tone: Three types (guitar, bass, piano)

Display

7-segment four-digit LED

SD card

Usable cards: SDHC(UHS-I) 4 GB–32 GB recommendation

Input jacks

MIC IN jacks: XLR-3-32 type (balanced), input impedance 4.7 k Ω , nominal level -43 dBV

INPUT 1 jack, INPUT 2 jack (guitar, bass): 1/4" mono phone jack (unbalanced), input impedance 1 M Ω , nominal level -26 dBV

AUX INPUT jack: 1/8" stereo mini-phone jack (unbalanced), input impedance 10 k Ω , nominal level -17 dBV

FOOT SW jack: 1/4" stereo phone jack, usable foot switch: VOX VFS5 foot switch

Output jacks

OUTPUT L/MONO jack, R jack: 1/4" mono phone jack (unbalanced)

Ω jack: 1/8" stereo mini-phone jack, maximum level: 0 dBV, 30 mW, 32 Ω

Power supply:

DC 9V, six AA batteries (alkaline or nickel-metal hydride are supported)

Battery life:

approximately 7 hours (when using alkaline batteries)

approximately 7 hours (when using nickel-metal hydride batteries)

* Varies depending on the batteries used and the conditions of use

Current consumption

330 mA

Dimensions (WxDxH)

244 x 220 x 68 mm / 9.61" x 8.66" x 2.68"

Weight

1.4 kg / 3.09 lbs (Excluding batteries)

Included items

AC adapter (DC 9V, )

Option (sold separately)

Foot switch: VOX VFS5

* Specifications and appearance are subject to change without notice for improvement.

KR-55 Pro Signal Path

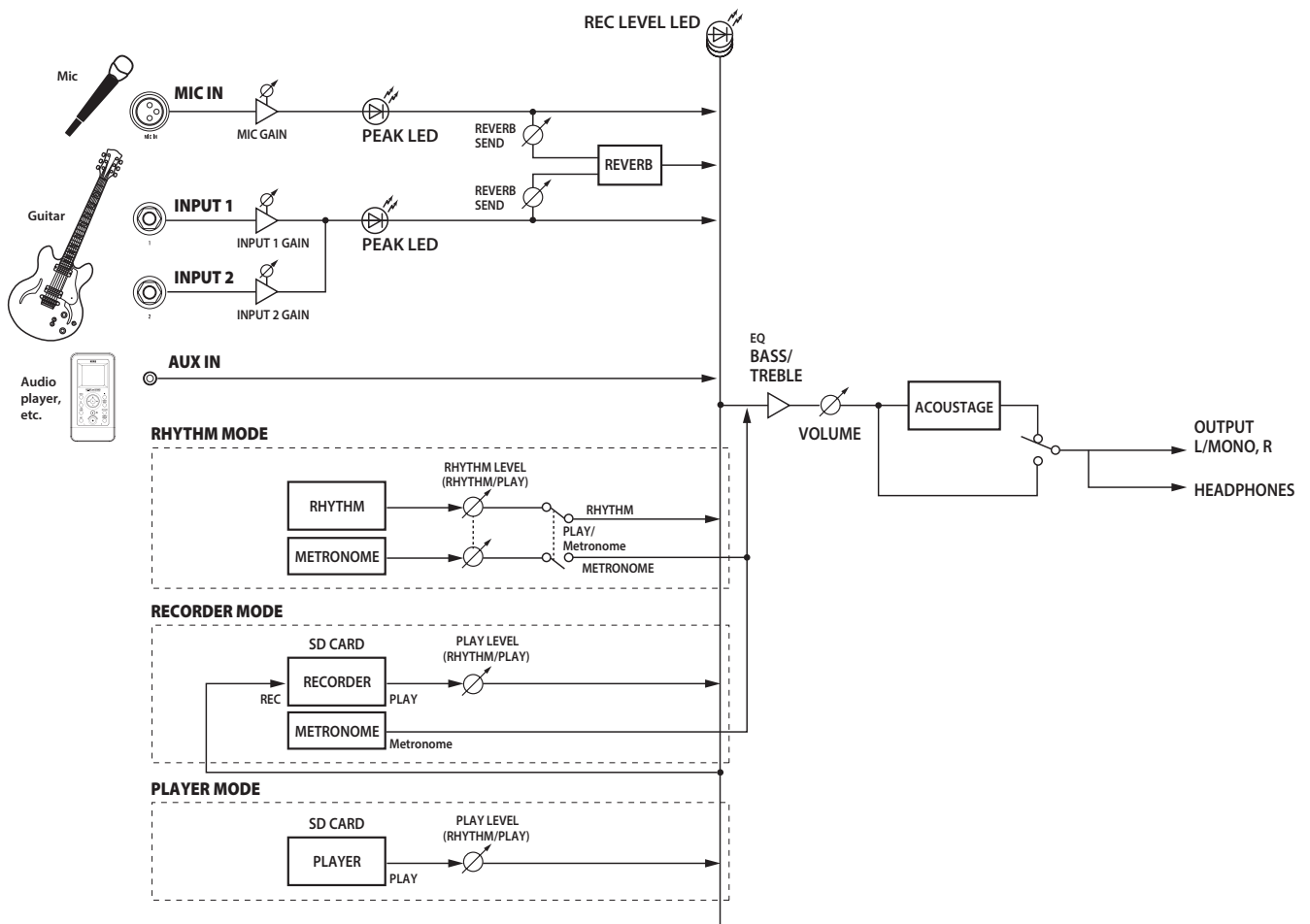

IMPORTANT NOTICE TO CONSUMERS

This product has been manufactured according to strict specifications and voltage requirements that are applicable in the country in which it is intended that this product should be used. If you have purchased this product via the internet, through mail order, and/or via a telephone sale, you must verify that this product is intended to be used in the country in which you reside.

WARNING: Use of this product in any country other than that for which it is intended could be dangerous and could invalidate the manufacturer's or distributor's warranty.

Please also retain your receipt as proof of purchase otherwise your product may be disqualified from the manufacturer's or distributor's warranty.

KORG INC.

4015-2 Yanokuchi, Inagi-City, Tokyo 206-0812 JAPAN

©2017 KORG INC.

Published 01/2018