

prologue

POLYPHONIC ANALOGUE SYNTHESIZER

Owner's Manual

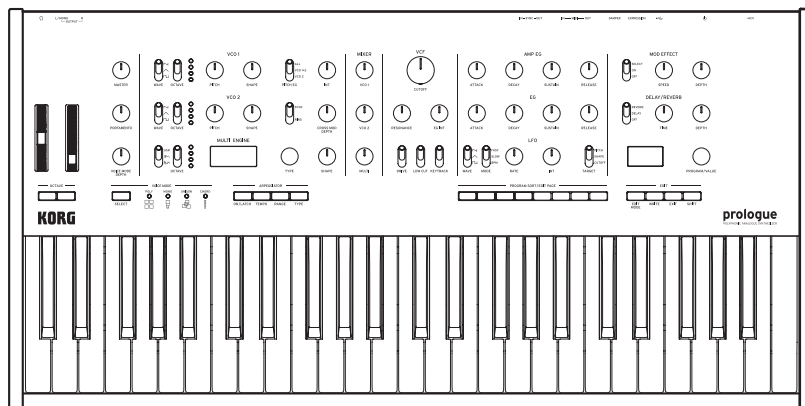
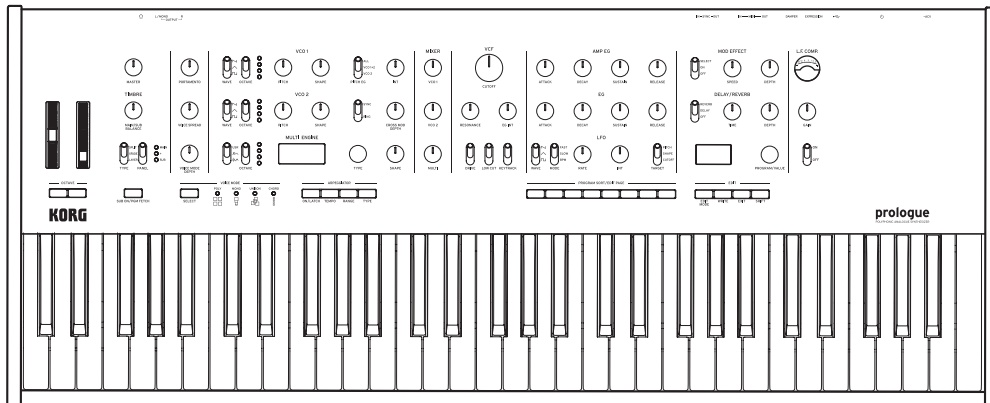

Contents

Introduction	3
About the owner's manual.....	3
prologue Key Features.....	3
Block Diagram	4
Controls and Connections	5
Front Panel Controls	5
Rear Panel Connections	7
Turning the prologue On and Off.....	9
Playing Programs	11
Selecting and Playing a Program	11
Using the program sort function.....	12
Using the live set.....	13
Using the arpeggiator.....	15
Programs	17
Program Architecture	17
Creating Sounds	18
Saving a Program	19
Basic Parameter Editing	20
MASTER controls	20
TIMBRE section.....	22
VCO 1/VCO 2/MULTI ENGINE section	24
MIXER section	30
FILTER section	31
EG/LFO section	33
EFFECT section.....	36
L.F. COMP. section (prologue-16 only)	38
About timbre	39
Edit Mode	43
How to enter the Edit mode.....	43
PROGRAM EDIT mode	45
FUNCTION mode	52
GLOBAL EDIT mode	54
Other functions	62
Tuning	62
Restoring the Factory settings	62
Shortcuts using the SHIFT button	63
Using with other devices	64
Syncing to instruments with SYNC IN/OUT jacks.....	64
Using with other MIDI devices.....	66
Data list	70
Specifications	78
MIDI Implementation Chart	80

Introduction

About the owner's manual

Prologue comes in two variations, prologue-16 with a 61-key keyboard, and prologue-8 with a 49-key keyboard.

The documentation for this product consists of the following:

- Quick Start Guide (included)
- Owner's Manual (what you're reading)

prologue Key Features

- The prologue is a keyboardist-oriented analog synthesizer featuring the best of Korg's expertise.
- Redesigned and refined analog circuitry. The prologue-16 and the prologue-8 provide respectively 16 and 8 analog voices.
- Each voice includes a MULTI ENGINE providing a noise generator, a VPM oscillator, and the possibility to load user programmed oscillators.
- Equipped with high quality digital effects (MODULATION, REVERB, DELAY).
- Can be used as a two timbre synthesizer, in split, crossfade, or layer configuration.
- A newly designed analog effect (L.F. COMP.) provides a boost and compression in the low frequency band for a powerful sound (only on prologue-16).
- 500 program locations (250 loaded with factory presets) can be recalled instantly, and used to store programs.
- Provides multiple ways to sort and search through programs.
- Real-time oscilloscope provides visual feedback of parameter changes.
- Sync In and Sync Out jacks allow you to expand your session setup.

Block Diagram

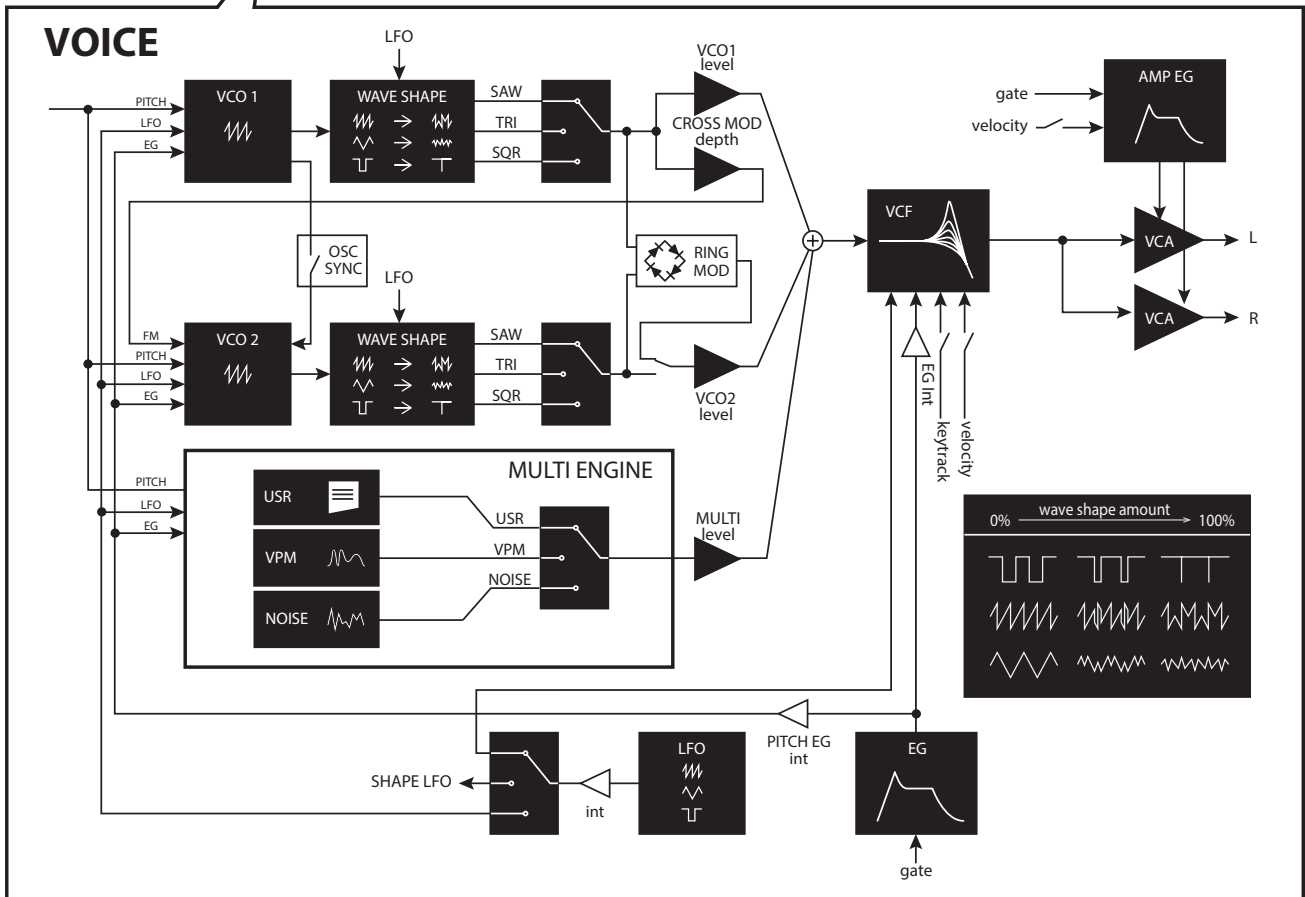
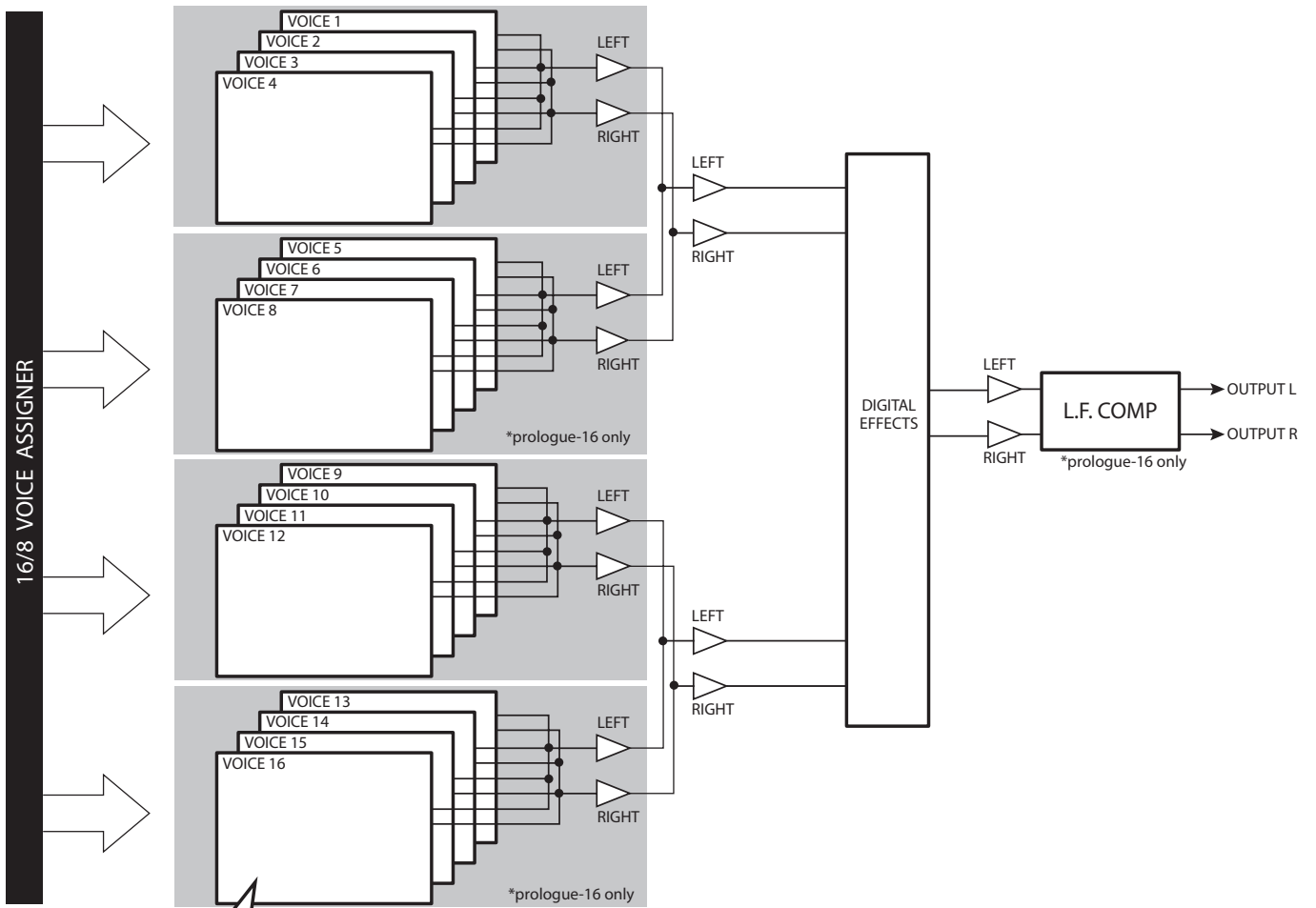

Controls and Connections

Front Panel Controls

This diagram shows the layout of the front panel knobs, switches, and buttons.

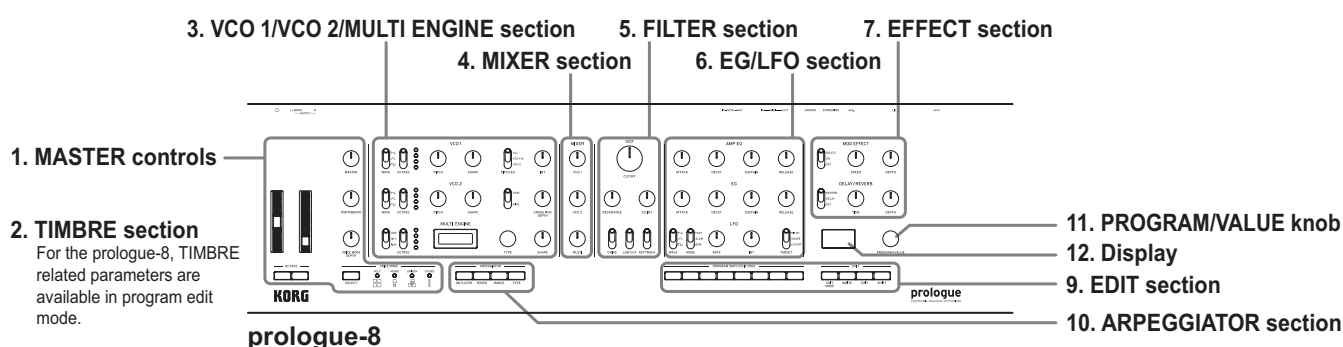
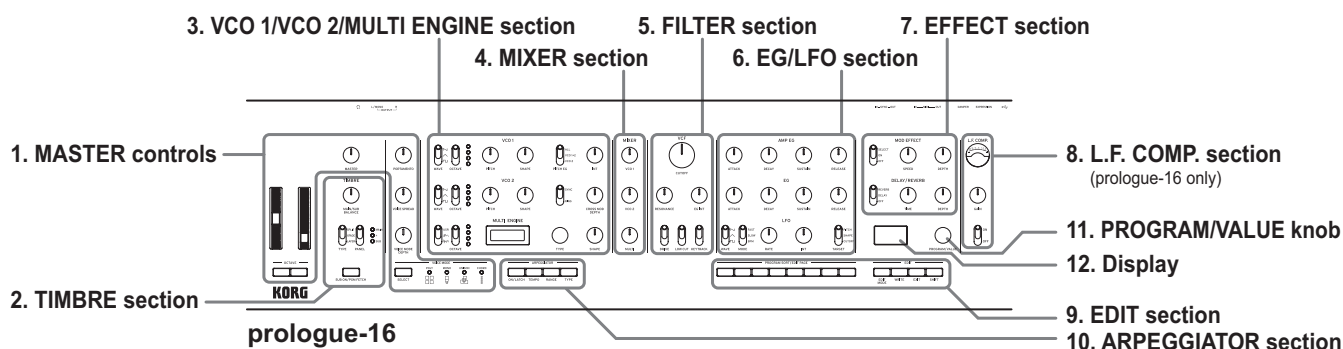

1. MASTER controls

- Pitch bend wheel
- Modulation wheel
- OCTAVE buttons
- MASTER knob
- PORTAMENTO knob
- VOICE SPREAD knob (prologue-16 only)
- VOICE MODE**
- VOICE MODE SELECT button
- VOICE MODE DEPTH knob

2. TIMBRE section

- SUB ON/PGM FETCH button (prologue-16 only)
- MAIN/SUB BALANCE knob
- TYPE switch
- PANEL switch

3. VCO 1/VCO 2/MULTI ENGINE section

- VCO 1**
- WAVE switch
- OCTAVE switch
- PITCH knob
- SHAPE knob
- VCO 2**
- WAVE switch
- OCTAVE switch
- PITCH knob
- SHAPE knob
- MODULATION**
- PITCH EG switch
- INT knob
- SYNC/RING switch
- CROSS MOD DEPTH knob

MULTI ENGINE

NOISE/VPM/USR switch

OCTAVE switch

Display

TYPE knob

SHAPE knob

4. MIXER section

VCO 1 knob

VCO 2 knob

MULTI knob

5. FILTER section

VCF

CUTOFF knob

RESONANCE knob

EG INT knob

DRIVE switch

LOW CUT switch

KEYTRACK switch

6. EG/LFO section

AMP EG

ATTACK knob

DECAY knob

SUSTAIN knob

RELEASE knob

EG

ATTACK knob

DECAY knob

SUSTAIN knob

RELEASE knob

LFO

WAVE switch

MODE switch

RATE knob

INT knob

TARGET switch

7. EFFECT section

MOD EFFECT

OFF/ON/SELECT switch

SPEED knob

DEPTH knob

DELAY/REVERB

OFF/DELAY/REVERB switch

TIME knob

DEPTH knob

8. L.F. COMP. section (prologue-16 only)

VU meter

GAIN knob

OFF/ON switch

9. PROGRAM/VALUE knob

10. Display

11. EDIT section

PROGRAM SORT/EDIT PAGE

Buttons 1–8

EDIT

EDIT MODE button

WRITE button

EXIT button

SHIFT button

12. ARPEGGIATOR section

ON/LATCH button

TEMPO button

RANGE button

TYPE button

Rear Panel Connections

The illustration below shows a typical example of connections for the prologue. Connect your equipment according to the needs of your own system.

- ⚠ Be sure that the power on all of your devices is turned off before you make connections. Leaving the power on when you make connections may cause malfunctions, or damage your speaker system and other components.

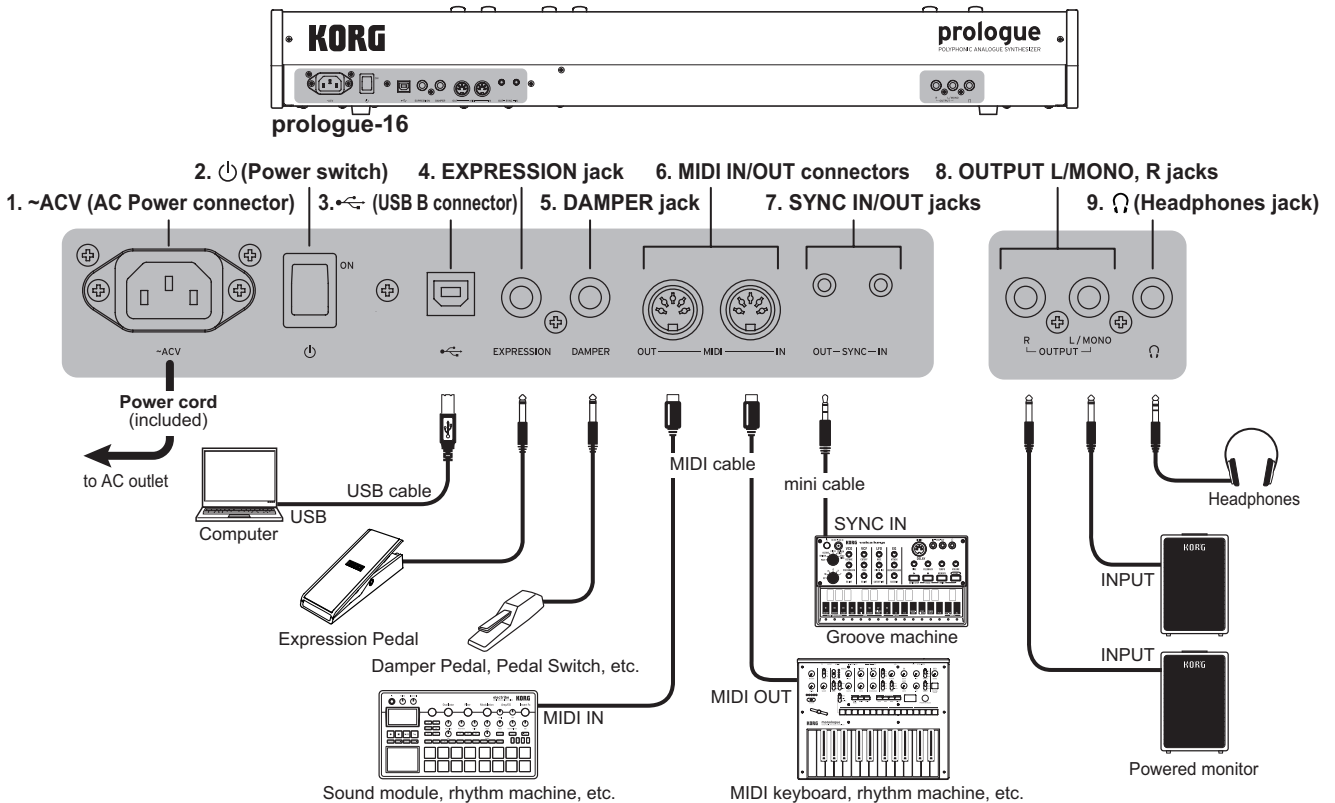

1. ~ACV (AC power connector)

Connect the AC power cord (included) to this jack.

2. Power switch

This turns the power on/off.

3. (USB B connector)

This connector allows the prologue to exchange MIDI messages with your computer.

4. EXPRESSION jack

Connect an optional XVP-20 volume/expression pedal (sold separately) or an XVP-10 expression pedal (sold separately) to control the assigned parameters.

5. DAMPER jack

Connect an optional DS-1H damper pedal (sold separately) or a PS-1/PS-3 pedal switch (sold separately) to control the damper effect.

- ⚠ This instrument does not feature a half-damper function.

6. MIDI IN/OUT connectors

These connectors allow the prologue to exchange MIDI messages with an external MIDI device. Refer to “Using with other MIDI devices” (p.66) for details.

7. SYNC IN/OUT jacks

Use a stereo mini-cable to connect the prologue to the Korg volca series and other instruments. This is used to synchronize the steps of the prologue with the pulses sent from the audio out jack of connected devices, DAWs and so on. Refer to “Syncing to instruments with SYNC IN/OUT jacks” (p.64) for details.

8. OUTPUT L/MONO, R jacks

These jacks are for stereo output. Connect these jacks to a powered monitor speaker or mixer. The volume level is adjusted using the MASTER knob. To output monaural sound, use the OUTPUT L/MONO jack.

9. (Headphone jack)

This jack outputs the same signal as that of the OUTPUT jack. Connect your headphone plug here.

Connecting to audio devices

- Connect your powered monitor speaker, mixer or other components to the OUTPUT jack (monaural output) of the prologue. Adjust the volume level using the MASTER knob.
- Connect your headphones to the headphones jack. This jack outputs the same signal as that of the OUTPUT jack.

Connecting to MIDI devices or a computer

- To exchange MIDI messages with an external MIDI device, connect the device to the MIDI IN/OUT connectors on the prologue.
- To exchange MIDI messages with your computer, connect your computer to the USB B connector on the prologue.

TIP Refer to “Using with other MIDI devices” (p.66) for details.

Connecting the SYNC IN and OUT jacks

- Use the SYNC IN and OUT jacks when you want to synchronize the output pulses and steps from the SYNC IN/OUT jacks of the Korg volca series or the audio out jacks of a DAW. Use a stereo mini-cable for this connection.
- The SYNC OUT jack sends a 5 V pulse of 15 ms at the beginning of each step.



TIP Refer to “Syncing to instruments with SYNC IN/OUT jacks” (p.64) for details.

Turning the prologue On and Off

Connecting the power cord included (with this keyboard)

Make sure that the prologue's power is turned off.

1. **Connect the included power cord to the AC Power connector.**

-  Make sure that your AC outlet is the correct voltage for your instrument.
-  Use only the included power cord. Using any different power cord may cause malfunctions or other issues.

2. **Make sure that any external output devices such as powered monitor speakers are turned off before connecting them to the prologue.**

TIP If you want to connect a MIDI device or computer to the prologue's MIDI connectors or USB B connector in order to use the prologue's keyboard and controllers to control an external MIDI tone generator, or if you want to use another MIDI keyboard or a sequencer to play the prologue's sound generator, you will need to configure the settings. Refer to "Using with other devices" (p.64) for details.

Turning the prologue On

1. **Make sure that both the prologue and any external output devices such as powered monitor speakers are turned off, and turn the volume of all devices all the way down.**
2. **Turn on the Power switch on the rear panel of the prologue.**
The word "Tuning..." will appear on the display, and the instrument will enter Tuning mode for the analog synthesizer circuit, for around 15 seconds. After this, the prologue will return to Play mode.
3. **Turn on any external output devices such as powered monitor speakers.**
4. **Adjust the volume of your external output equipment, and adjust the prologue's volume using the MASTER knob.**

Turning the prologue Off

Any Program data in the prologue that has not been saved will be lost when the power is turned off. Be sure to save any Program and other important data that you have edited (p.19, "Saving a Program").

1. Lower the volume of your powered monitors or external output system, and turn them off.
2. Turn off the Power switch on the rear panel of the prologue.
 - 🔊 Once you have turned the prologue off, wait about 10 seconds before turning the prologue on again.

Auto Power Off Feature

The prologue features an Auto Power Off feature that can automatically turn the prologue off after 4 hours have elapsed with no operation of the knobs, switches, buttons, or keyboard of the prologue. By default, the factory setting for the Auto Power Off is enabled. The Auto Power Off can be disabled using the steps below.

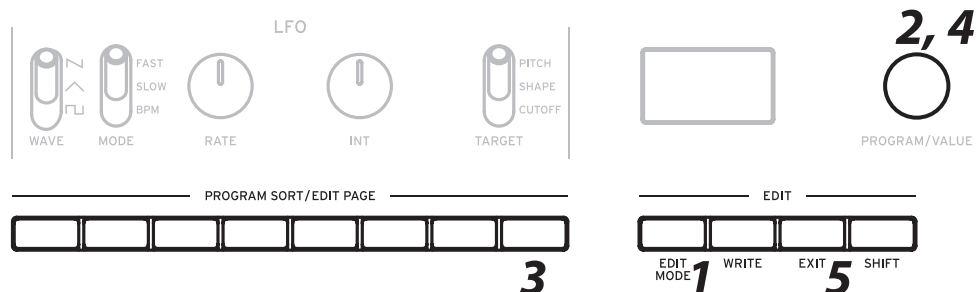

1. Press the **EDIT MODE** button.

The prologue will enter the Edit Mode, and the display will look like the illustration shown below.



2. Turn the **PROGRAM/VALUE** knob, and select **GLOBAL EDIT**.

TIP GLOBAL EDIT can also be selected by pressing the EDIT MODE button.

3. Press button **8** twice.

“Auto Power Off” will be displayed.

4. Turn the **PROGRAM/VALUE** knob, and select “Off”.

5. Press the **EXIT** button.

The prologue will enter the Play mode, and the display will indicate the current Program.

TIP Settings in GLOBAL EDIT are saved automatically.

Playing Programs

Selecting and Playing a Program

The prologue has 500 program locations of which 250 are preloaded with factory presets. The preset programs are assigned to the first 250 locations and are organized into sound categories for easy selection. The remaining locations contain the initialization program that can be used as a starting point when creating user programs.

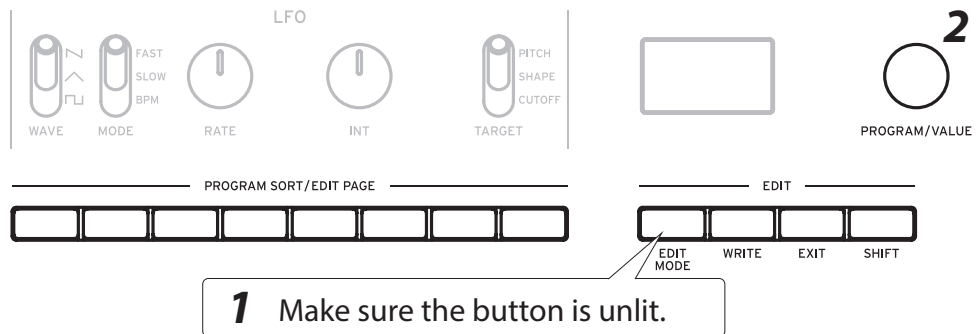

1. Enter the Play mode.

When the prologue is turned on, it will automatically enter the Play mode. In the Play mode, verify that the EDIT MODE button on the front panel are unlit.

2. Turn the PROGRAM/VALUE knob to select a Program.

The display will indicate the Program name and number. Refer to “Program List” (p.72) for details.

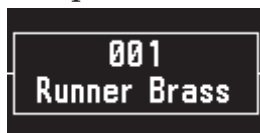

TIP In addition to showing Program name and number, the display can also be used as an **oscilloscope**, to show the electrical signals created by the waveform of the sound.

3. Play the keyboard and use the controls on the front panel, such as the OCTAVE buttons or the wheel.

The OCTAVE buttons on the left can be used to transpose the sound within a range of -2 to +2 octaves.

Move the pitch bend wheel up and down to change the pitch, and move the modulation wheel up and down to change the assigned parameters.

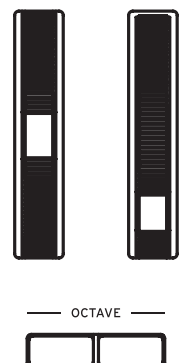

In Play mode, the LEDs to the right of the VOICE MODE SELECT button show the Voice mode status of the selected program. Press the VOICE MODE SELECT button to switch between and play in different Voice modes. Refer to “VOICE MODE” (p.20) for details.

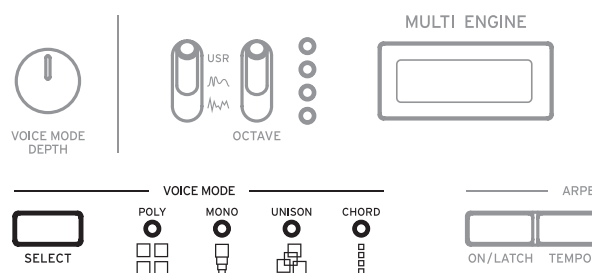

Using the program sort function

Sorting and selecting programs

The Korg prologue features a program sort function that lets you search for programs in many different ways. Use this function to quickly find your favorite programs from the multitude of programs available, using the method you like.

1. In Play mode, press one of the PROGRAM SORT/EDIT PAGE buttons from 1 to 8.

The programs before and after the currently selected program will be resorted, according to the sort function button that you pressed. Press the same button again to jump to the next block (the next category, alphabetical letter and so on), while the programs remain in order.

Program sort function list

Button	Type	Details
1	PROG NUM	Sorts by program number.
2	CATEGORY	Sorts by program category. Hold down button 2 to enter the category page in PROGRAM EDIT mode (p.45, “Category”) and change the program category. Press the WRITE button to save the program if you have made any changes (p.19, “Saving a Program”).
3	ALPHABETICAL	Sorts the programs in alphabetical (ABC order). Hold down button 3 to enter the category page in PROGRAM EDIT mode (p.45, “Button 2 (PROGRAM NAME)”) and change the program name. Press the WRITE button to save the program if you have made any changes (p.19, “Saving a Program”).

Button	Type	Details
4	LIKE	Sorts by programs that you have “liked.” Hold down button 4 to like a program. When “liked” is set for a program, an asterisk (*) will be shown to the right of the program number. To remove a like from a program, select the program and then hold down button 4 again.
5	FREQUENT	Sorts programs by how often how you have used them.
6	ENVELOPE	Sorts programs by the length of the EGs on the main timbre.
7	RANDOM	Sorts programs in random order.
8	LIVE SET	Sorts the programs that have been registered in the live set. Refer to “Using the live set” (p.13) for more details on the live set.

2. Turn the PROGRAM/VALUE knob to select a program.

Using the live set

With the live set feature on the prologue, you can register programs to use on the PROGRAM SORT/EDIT PAGE buttons 1 through 8, and then use the program sort function to quickly recall them. There are four banks in the live set, from A to D.

Registering programs to the live set

Use the live set to register programs that you frequently use when performing live.

- 1. In Play mode, select a program to register to the live set.**
- 2. Hold down PROGRAM SORT/EDIT PAGE button 8.**
“REGISTER” will appear on the display.
- 3. Turn the PROGRAM/VALUE knob to select the bank (A–D) where the program will be registered.**
The PROGRAM SORT/EDIT PAGE buttons (from 1–8) will blink up for programs that are registered to the live set. If no program is registered to a button, that button will light.

TIP Press the EXIT button to cancel.

- 4. Press a button for the program you wish to register, using PROGRAM SORT/EDIT PAGE buttons 1–8.**
The existing program will be registered as a live set, and the message “Complete” will appear on the display.
- 5. When registering another program, select the program after pressing any other PROGRAM SORT/EDIT PAGE button besides button 8, and register using the procedure from step 2.**

Deleting a program registered to the live set

You can delete programs that have been registered to the live set.

Using step 4 (p.13, “Registering programs to the live set”), hold down the button (which will be lit) for the program you wish to delete, using PROGRAM SORT/EDIT PAGE buttons 1–8.

The program registered to the button you have held down will be deleted, and the message “Cleared” will appear on the display.

Recalling a program from the live set

- 1. In Play mode, press PROGRAM SORT/EDIT PAGE button 8.**
“LIVE SET” will appear on the display.
- 2. Turn the PROGRAM/VALUE knob to select the bank (A–D).**
If a program has been registered to a live set for one of the PROGRAM SORT/EDIT PAGE buttons 1–8, that button will blink.
- 3. Press one of the PROGRAM SORT/EDIT PAGE buttons 1–8 to recall the program.**
The program registered to the button you have pressed will be recalled, and the program name will appear on the display.

TIP After recalling a program with a live set once, you can turn the PROGRAM/VALUE knob to select programs within the same bank. If you wish to select programs from another bank, follow the procedure from step 1.

Using the arpeggiator

The Korg prologue includes an arpeggiator function, which automatically plays programs in patterns based on the keys you press.

Performing with the arpeggiator

1. **In Play mode, press the ARPEGGIATOR ON/LATCH button.**

The arpeggiator will turn on, and the ON/LATCH button will light.

2. **Play the keyboard.**

The arpeggiator will operate using the key you pressed as a base note, while you are playing the keyboard.

TIP Holding down the ON/LATCH button will turn LATCH on, and the ON/LATCH button will blink. When LATCH is on, the arpeggiator will continue to function even when you take your hands off the keyboard. Press the ON/LATCH button once more to turn LATCH off.

Changing the arpeggiator settings

Setting the tempo

This sets the arpeggiator tempo.

1. **Turn the PROGRAM/VALUE knob while pressing the ARPEGGIATOR TEMPO button.**

You can adjust the BPM within a range of 30.0 to 600.0.

You can also tap the TEMPO button repeatedly to input the BPM using the tap tempo feature.

Setting the octave range

1. **Press the ARPEGGIATOR RANGE button to switch between octave ranges.** Each time the RANGE button is pressed, the octave range will change within 1–4 octaves.

Setting the arpeggiator type

This sets the arpeggiator type.

1. Press the **ARPEGGIATOR TYPE** button to set the arpeggiator to one of the following types.

Type	Function
Manual	The arpeggio will play in the order you play the keys.
Rise	The arpeggio will play from lower notes to higher notes.
Fall	The arpeggio will play from higher notes to lower notes.
Rise Fall	The arpeggio will play from lower notes to higher notes, and then go back down from high to low.
Random	One random note will be selected and played at a time for each note that you play.
Poly Random	Two random notes will be played at a time from the notes that you play. This will only work when the VOICE MODE is set to "POLY".

Programs

Program Architecture

A program includes settings for sounds, effects, timbres, Voice mode and arpeggiator. (MASTER knob, pitch bend wheel, OCTAVE buttons, L.F. COMP. section and arpeggiator LATCH settings are not included in a program.)

Try editing each related parameter, and enjoy the sounds of the prologue.

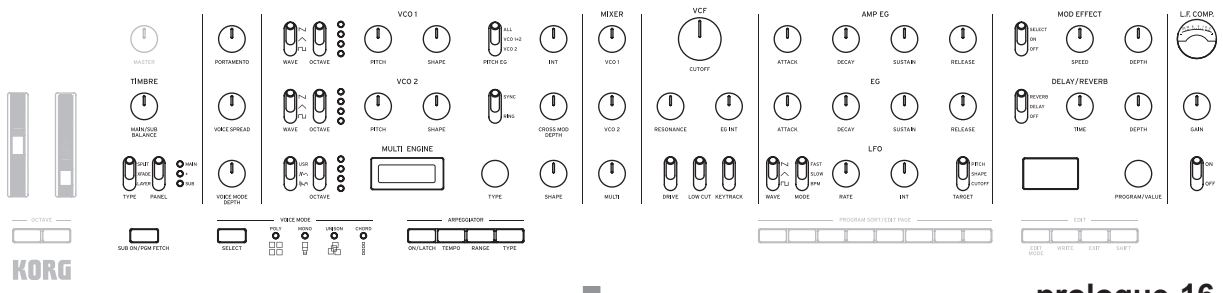

prologue-16

Basic Parametres

<p>VCO 1 WAVE OCTAVE PITCH SHAPE</p>	<p>MULTI ENGINE NOISE/VPM/USR OCTAVE TYPE SHAPE</p>	<p>AMP EG ATTACK DECAY SUSTAIN RELEASE</p>	<p>MOD EFFECT OFF/ON/SELECT* SPEED* DEPTH*</p>
<p>VCO 2 WAVE OCTAVE PITCH SHAPE</p>	<p>MIXER VCO1 VCO2 MULTI</p>	<p>EG ATTACK DECAY SUSTAIN RELEASE</p>	<p>DELAY/REVERB OFF/DELAY/REVERB* TIME* DEPTH*</p>
<p>MODULATION PITCH EG PITCH EG INT SYNC/RING CROSS MOD DEPTH</p>	<p>VCF CUTOFF RESONANCE EG INT DRIVE LOW CUT KEYTRACK</p>	<p>LFO WAVE MODE RATE INT TARGET</p>	<p>ARPEGGIATOR ON/LATCH* TEMPO* RANGE* TYPE*</p>

Detail Parametres

<p>SORT Category*</p> <p>PROGRAM NAME*</p> <p>TIMBRE Sub Timbre* Edit Timbre* Timbre Type* Main/Sub Balance* Main/Sub Position* Split Point*</p>	<p>PEDAL & WHEEL M.Wheel Assign M.Wheel Range E.Pedal Assign Bend Range + Bend Range -</p> <p>MODULATION LFO Key Sync LFO Voice Sync EG Velocity Amp Velocity*</p>	<p>OTHER SETTINGS Multi Routing Arpeggiator* Voice Spread Pan Width Portamento Mode* Program Level*</p> <p>MULTI ENGINE Param 1-6</p>	<p>EFFECTS Chorus Type* Ensemble Type* Flanger Type* Phaser Type* User Effects Type* Delay Type* Reverb Type* Mod Effect Sub Type* Reverb/Delay Sub Type* Mod Effect Assign* Reverb/Delay Assign*</p>
---	--	---	--

*: When the sub-timbre is enabled, changing these parameters will have no effect on timbres set in "EDIT TIMBRE", PROGRAM EDIT mode.

Creating Sounds

Editing a program means changing the Program's parameters to alter its sound.

There are two way to create sounds on the prologue.

- Select an existing Program that's close to the sound you want, and edit that Program's parameters to achieve your own custom sound.
- You can also initialize all the Program parameters to create your own sound from scratch.

Editing an Existing Program

1. **In Program mode, select the Program that you want to use as a starting point.**
2. **Use the knobs and switches on the front panel.**
Take a moment to consider the differences between the current Program and the sound you have in mind, and use the front panel controls to edit the necessary parameters.

TIP For details on how the pitch, sound, and volume change when using the knobs and switches, refer to "Basic Parameter Editing" (p.20).

 We recommend that you save the Program on the prologue after editing the sound. Any edits that you make will be lost if you turn off the power or recall a different Program. For details, refer to "Saving a Program" (p.19).

Creating a Program from Scratch

To create a sound from scratch, we recommend that you use the **Panel Load function**. This will load the current settings of each front panel control and provide a simple starting point for your iconic creations.

As you explore the front panel controls, you can see how each parameter will affect the sound, making it easier to understand how each section of the prologue functions and how the parameters interact.

Panel Load function

When the WRITE button is pressed while holding down the SHIFT button, the panel load function will be enabled. The sound will change to reflect the panel settings, and "Load Panel" will be indicated on the display.

Saving a Program

We recommend that you save your Program on the prologue after editing the sound.

⚠ Any edits that you make to the current program will be lost if you turn off the power or recall a different program before saving.

1. Edit the program in Play mode.

For details, refer to “Basic Parameter Editing” (p.20).

2. Press the WRITE button; the prologue will enter the Write standby mode, and the WRITE button will blink.

The message “Where to write?” will appear in the display.

3. Turn the PROGRAM/VALUE knob to select the Program number where your new sound will be saved.

TIP Press the EXIT button to cancel the operation.

4. Press the WRITE button once more.

The Program will be saved in internal memory, and the message “Complete” will appear in the display.

⚠ Never turn off the power while Programs are being saved. Doing so may destroy the internal data.

Basic Parameter Editing

In this section, we'll explain the basic parameters that make up a program. The basic parameters are assigned to the knobs and switches on the front panel.

MASTER controls

For details on the modulation wheel, pitch bend wheel, OCTAVE buttons and MASTER knob, refer to "Selecting and Playing a Program" (p.11). For details on the SUB ON/PGM FETCH button, refer to "Enabling the sub-timbre" (p.39).

PORTAMENTO knob [OFF, 0...127]

Specifies the length of the portamento.

The further the knob is turned to the right, the longer the portamento time will be.

VOICE SPREAD knob (prologue-16 only) [0...127]

This adjusts the amount of voice spread that is applied to achieve a stereo effect.

The further the knob is turned to the right, the stronger the voice spread effect will be.

This is set in "Voice Spread" (p.49) in PROGRAM EDIT mode on the prologue-8.

VOICE MODE

The prologue-16 features a 16-voice analog synthesizer engine, and the prologue-8 features a 8-voice analog synthesizer engine. The Voice mode function can be used to combine these voices in different ways when playing.

There are 4 different Voice modes. Use the SELECT button to switch between them.

Turn the VOICE MODE DEPTH knob to control a wide variety of effects for each Voice mode.

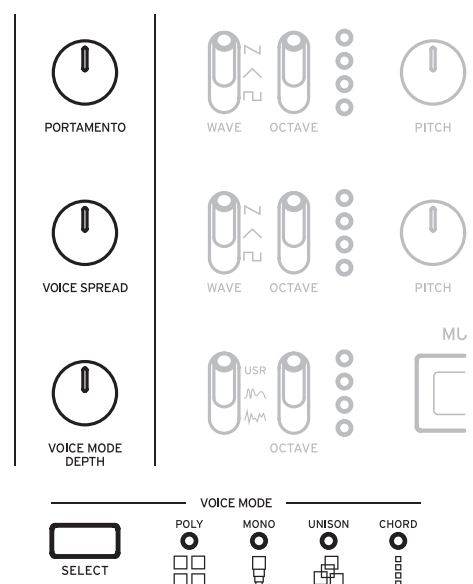

Voice mode list

Voice mode	Action	VOICE MODE DEPTH knob effect
POLY	Voice mode featuring 16 voices (for the prologue-16) or 8 voices (for the prologue-8), for playing as a poly synth.	[POLY, DUO 0...1023] Turn the knob to the right to switch to DUO mode, which stacks two voices when playing a key. Turning the knob to the right will increase the sound of the stacked voice, and deepen the detune effect.
MONO	Operate as a mono synth with sub-oscillator.	[Sub 0...1023] Turning the knob to the right will assign voices 2 and 3 as a sub-oscillator one octave lower, and turning the knob to the right once more will assign voice 4 as a sub-oscillator two octaves lower.
UNISON	All voices (16 voices on the prologue-16, 8 voices on the prologue-8) will sound in unison (at the same time), operating as a mono synth.	[Detune 0C...50C] Turning the knob to the right will increase the detuning effect.
CHORD	Play as a chord.	[5th, sus2, m, Maj, sus4, m7, 7, 7sus4, Maj7, aug, dim, m7♭5, mMaj7, Maj7♭5] Selects the chord to play.

TIMBRE section

Set the timbre of the prologue-16 in the TIMBRE section.

The timbre on the prologue-8 can be edited in PROGRAM EDIT mode (p.46, “Button 3 (TIMBRE)”).

The methods of enabling sub-timbres and operating each parameter are different for the prologue-16 and the prologue-8. Refer to “About timbre” (p.39) for details for both instruments.

SUB ON/PGM FETCH button (prologue-16 only)

This enables the sub-timbre and allows you to use the program fetch function. See “Program fetch function” (p.41) for details on the program fetch function.

Press this button to enable the sub-timbre, making the prologue play with two timbres (8 voices + 8 voices). The SUB ON/PGM FETCH button lights up at this time.

Hold down the button to enter the program fetch function in FUNCTION mode. The SUB ON/PGM FETCH button will blink.

To enable the sub-timbre on the prologue-8, use “Sub Timbre” (p.46) in PROGRAM EDIT mode. To use the program fetch function, set using “Button 2 (PROGRAM FETCH)” (p.52) in FUNCTION mode.

MAIN/SUB BALANCE knob (prologue-16 only) [0...127]

Adjusts the volume balance between the main timbre and the sub-timbre.

64: The volume for the main timbre and the sub-timbre will be the same.

Turning the knob to the left will increase the volume of the main timbre, and turning the knob to the right will increase the volume of the sub-timbre.

On the prologue-8, this is set in “Main/Sub Balance” (p.46) in PROGRAM EDIT mode.

TYPE switch (prologue-16 only) [LAYER, XFADE, SPLIT]

Sets the performance type for the main timbre and the sub-timbre.

LAYER: The main timbre and sub-timbre will be layered together when playing.

XFADE: As you move up the keyboard, the sub timbre will gradually crossfade into the main timbre.

SPLIT: The main timbre and sub-timbre will be split into different ranges of the keyboard when playing.

This is set in “Timbre Type” (p.46) in PROGRAM EDIT mode on the prologue-8.

TIP The position and split point are set in “Main/Sub Position” (p.46) and “Split Point” (p.46) respectively, in PROGRAM EDIT mode.

Sets the timbre to edit.

SUB: Edits the sub-timbre.

+ (MAIN+SUB): Edits both the main and sub-timbres.

MAIN: Edits the main timbre.

This is set in “Edit Timbre” (p.46) in PROGRAM EDIT mode on the prologue-8.

TIP Editing a timbre applies to the basic parameters on the front panel, as well as all detailed parameters in PROGRAM EDIT mode.

VCO 1/VCO 2/MULTI ENGINE section

VCO 1, VCO 2

VCO: Voltage Controlled Oscillators

There are two voltage controlled analog oscillators for each voice on prologue. Oscillator Parameters include the settings for the oscillator pitch (OCTAVE, PITCH) and the waveform (WAVE, SHAPE).

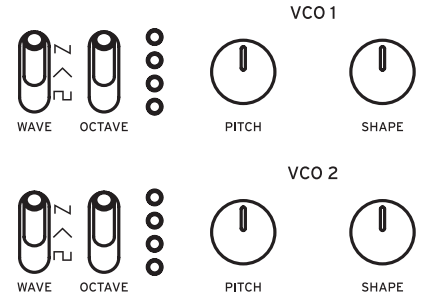

WAVE switch [□, ▲, ▼]

This sets the waveforms for Oscillators 1 and 2.

Square wave: This waveform has a sound that can be used to create wind instrument-type timbres, electronic sounds, and imitate vintage video games.

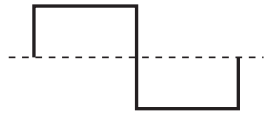

Triangle wave: This waveform has less high end harmonic content than a sawtooth or square wave, and so has a more round, less aggressive feel.

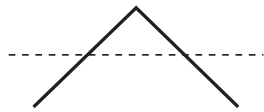

Sawtooth wave: This waveform is the most common analog synthesizer waveform, and can be used to recreate anything from standard synth sounds to basses, brass, and strings.

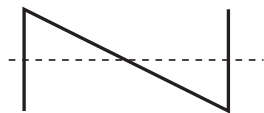

OCTAVE switch [2', 4', 8', 16']

The pitch of Oscillators 1 and 2 can be set in octave steps.

PITCH knob [-1200...+1200]

The pitch, or tuning, of Oscillators 1 and 2 can be set using steps of one cent.

SHAPE knob [0...1023]

This knob will determine the final shape, complexity, or duty-cycle (Square) of the selected waveform.

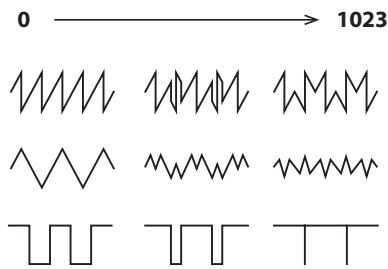

MODULATION

A powerful oscillator sync, cross modulation, and ring modulation can be applied to the oscillators.

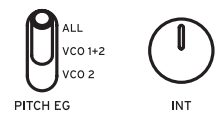

PITCH EG switch [VCO 2, VCO 1+2, ALL]

Select the oscillator and use the EG to modulate its pitch.

VCO 2: Uses the EG to modulate the pitch of oscillator 2.

VCO 1+2: Uses the EG to modulate the pitch of operators 1 and 2.

ALL: Uses the EG to modulate the pitch of operators 1 and 2, as well as the MULTI ENGINE.

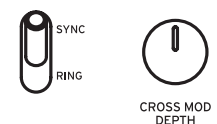

INT knob [-4800...+4800]

Sets the amount of pitch modulation (how much the pitch changes) for the PITCH EG. Turning the knob to the right results in a greater change in pitch from the EG. Refer to "EG" (p.34) for the EG settings.

SYNC/RING switch [RING, off, SYNC]

The allows you to apply oscillator sync or ring modulator effects to the sound.

RING: This produces a ring modulation effect.

Oscillator 1 is used to ring-modulate Oscillator 2. By adjusting the PITCH knob of Oscillator 2, you can create non-tonal metallic sounds.

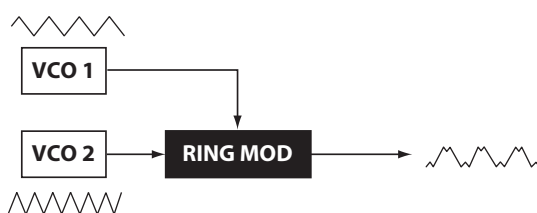

off (center position): Turns the oscillator sync and ring modulator off.

SYNC: With this type of modulation, the phase of Oscillator 2 is forcibly synchronized to the phase of Oscillator 1.

This adds harmonic overtones to the frequency of Oscillator 2, making a complex waveform.

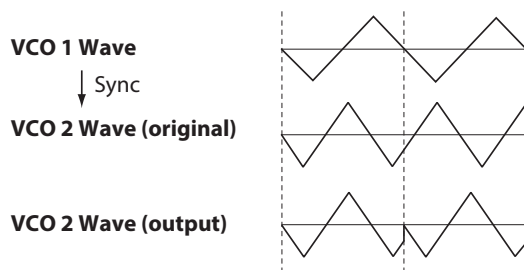

[CROSS MOD DEPTH knob](#) [0...1023]

Cross Mod (Modulation) allows Oscillator 1 to modulate the pitch of Oscillator 2.

Turning the knob to the right results in stronger modulation.

MULTI ENGINE

The MULTI ENGINE is a digital sound generation engine developed especially for this instrument.

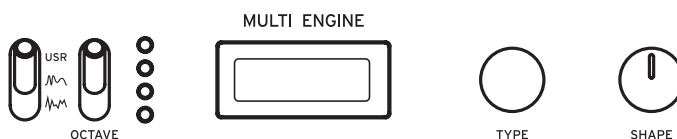

This engine operates as either a noise generator, a VPM oscillator

or a user oscillator, to make a wide range of sounds not possible with analog oscillators. You can upload your own oscillator programs to the user oscillator to make sounds.

[NOISE/VPM/USR switch](#) [NOISE, VPM, USR]

This sets which engine will be used, the noise generator, VPM oscillator or user oscillator.

NOISE (NOISE): The MULTI ENGINE is used as a noise generator.

VPM (VPM): The MULTI ENGINE is used as a VPM oscillator.

USR: The MULTI ENGINE is used as a user oscillator.

The OCTAVE switch, TYPE knob and SHAPE knob work differently, depending on the NOISE/VPM/USER switch setting. The settings are explained below.

NOISE

Noise is used to create percussion instrument sounds, or sound effects such as surf. Select one of the four noise generators using the TYPE knob. Move the SHAPE knob to make changes in the sound.

OCTAVE switch [2', 4', 8', 16']

The key tracking effect can be adjusted on an octave-by-octave basis, only when "Decim" is selected with the TYPE knob.

TYPE knob [High/Low/Peak/Decim]

Select the noise generator to use. The noise generator name will be indicated on the MULTI ENGINE display.

High: A high-pass filter will be used.

Low: A low-pass filter will be used.

Peak: A peak filter (bandpass filter) will be used.

Decim: A Decimator will be used.

SHAPE knob

Set the noise generator parameter to make changes to the sound. The parameters differ depending on the noise generator that you select using the TYPE knob, with the following effects.

SHAPE knob effects

Type	Parameter	SHAPE knob effects
High	Cutoff	[10.0Hz...21.0kHz] This adjusts the cutoff frequency of the HPF.
Low	Cutoff	[10.0Hz...21.0kHz] This adjusts the cutoff frequency of the LPF.
Peak	Bandwidth	[110Hz...880Hz] Adjusts the peak characteristic bandwidth.
Decim	Sample Rate	[240Hz...48.0kHz] Adjusts the sample rate.

VPM

This engine is a VPM (Variable Phase Modulation) oscillator that was developed especially for this instrument. The engine features a simple structure with one carrier and one modulator, but allows you to create a wide range of sounds.

Sixteen oscillator types are available for this VPM oscillator.

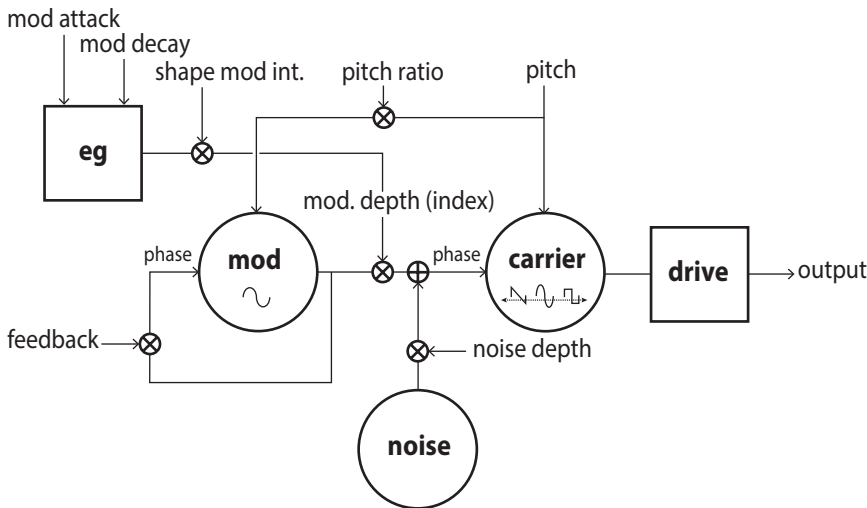

OCTAVE switch [2', 4', 8', 16']

The pitch of the VPM oscillator can be set in octaves.

TYPE knob [Sin1...Throat]

This selects the oscillator type to use.

The name of the oscillator type will be indicated on the MULTI ENGINE display.

Sin1: Modulated sine wave carrier basic type.

Sin2: Sine wave carrier and a modulator with self-feedback.

Sin3: Sine wave carrier with modulator 3 harmonics higher.

Sin4: Sine wave carrier with modulator 5 harmonics higher.

Saw1 Modulated sawtooth carrier basic type.

Saw2: Sine carrier based pseudo-sawtooth type.

Squ1: Modulated square wave carrier basic type.

Squ2: Sine carrier based pseudo-square wave type.

Fat1: Second subharmonic modulator with self-feedback and driven carrier output.

Fat2: Half subharmonic modulator with self-feedback and driven carrier output.

Air1: Noise modulated sine wave carrier.

Air2: Sine wave carrier modulated by both noise and a sine wave.

Decay1: Type with decaying modulation amount.

TIP Relative offsets to the internal EG decay time (see block diagram) can be added via the PROGRAM EDIT mode "Button 7 (MULTI ENGINE)" (p.50). For the last 4 types, setting Shape Mod Int to -100% will disable completely the impact of the EG.

Decay2: Type with strong decaying modulation amount.

Creep, Throat: Experimental type with complex and evolving modulations.

SHAPE knob

Turning the SHAPE knob only will set the “Modulator Depth,” and turning the SHAPE knob while holding down the SHIFT button will set the “Modulator Pitch Ratio.”

These parameters are common for all oscillator types, and produce the following effects.

SHAPE knob effects

Type	Parameter	SHAPE knob effects
Common	Modulator Depth (SHAPE knob)	[1.00...15.00] This adjusts the index and sets the intensity of the modulator.
	Modulator Pitch Ratio (SHIFT button+SHAPE knob)	[1:4, 1:2, 1:1, 2:1...] (range changes depending on TYPE) This adjusts the modulator ratio and adds overtones.

TIP Besides the SHAPE knob, the oscillator settings can be changed in detail with six parameters in PROGRAM EDIT mode. Refer to “When the VPM oscillator is selected” (p.50) for details.

USR

You can upload your own oscillator programs to make sounds with a user oscillator on the prologue.

Up to 16 user oscillators can be saved on this instrument. One factory-set default user oscillator is included with the prologue for demo purposes.

See the “prologue user contents guide” (www.korg.com) for details.

OCTAVE switch [2', 4', 8', 16']

The pitch of the user oscillator can be set in octaves.

TYPE knob

Select one of the user oscillators that are saved.

The name of the user oscillator will be indicated on the MULTI ENGINE display.

SHAPE knob [0...1023]

Produces the effect set for the user operator.

MIXER section

Use this section to set the output levels of oscillator 1, 2 and the MULTI ENGINE, and to adjust the balance.

VCO 1 knob [0...1023]

VCO 2 knob [0...1023]

MULTI knob [0...1023]

Sets the output levels of oscillator 1 and 2, and the MULTI ENGINE.

MIXER



VCO 1



VCO 2



MULTI

FILTER section

VCF

VCF: Voltage Controlled Filter

The low-pass filter shapes the tone by selectively filtering certain parts of the harmonic spectrum of the sound generated by the Oscillators and the Noise generator.

CUTOFF knob [0...1023]

This knob is used to set the cutoff frequency. Harmonic content above the cutoff frequency will be filtered out.

Turning the knob to the left will lower the cutoff frequency, and turning the knob to the right will raise the cutoff frequency.

- ⚠ If the CUTOFF value is set too low, the volume may be extremely low.

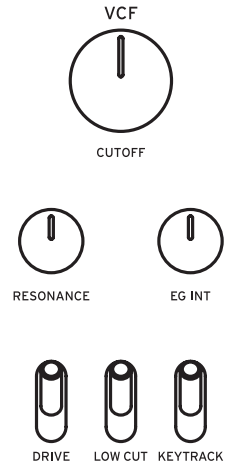

RESONANCE knob [0...1023]

Also known as Peak or Q, the RESONANCE control adds additional emphasis to the overtones occurring at the CUTOFF frequency, giving a distinctive character to the sound.

Turning the knob to the right will increase the resonance effect.

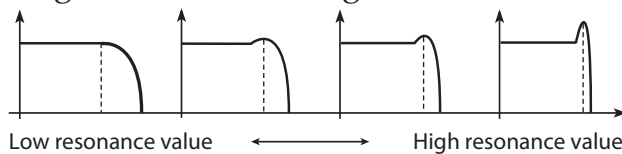

- TIP** The overtones that are emphasized will change depending on the cutoff frequency. For this reason, it's good to adjust the CUTOFF knob while adjusting the RESONANCE knob.
- ⚠ When emphasizing the overtones in this way, the sound may distort depending on the cutoff frequency or the input audio.

EG INT knob [-100%...0...+100%]

The Envelope Generator (EG) can be used to control the CUTOFF, or Filter frequency, over time using this EG INT (intensity) knob.

To learn more about the EG settings (p.34, "EG").

With this knob in the center position (0%), no EG is applied to the Filter.

Rotating the knob to the left of center increases the EG intensity, but with the polarity of the EG inverted.

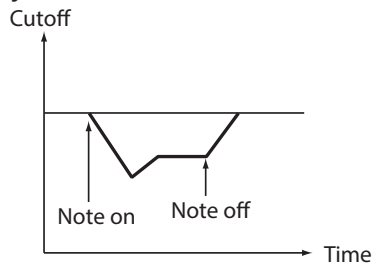

Rotating the knob to the right of center increases the EG intensity effect.

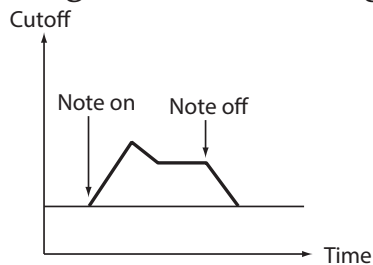

DRIVE switch [0%, 50%, 100%]

Sets the distortion effect produced by the drive circuit, in three stages.

0% (switch in the lower position): no drive effect.

50% (switch in the center position): drive effect will be set at half strength.

100% (switch in the upper position): drive effect will be set at maximum.

LOW CUT switch [OFF, ON]

Trims the low range of the sound via high-pass filter.

OFF (switch in the lower position): no low cut effect.

ON (switch in the upper position): low cut effect is applied.

KEYTRACK switch [0%, 50%, 100%]

Key tracking allows the note played on the keyboard to influence the cutoff frequency of the filter. This is useful when you want higher notes to have more upper harmonics, or to appear brighter, than lower notes.

0% (lower position): No keyboard tracking will be applied.

50% (center position): The cutoff frequency will change at half the rate/slope as the pitch of the keyboard.

100% (upper position): The cutoff frequency will change at the same rate/slope as the pitch of the keyboard.

EG/LFO section

AMP EG

VCA: Voltage Controlled Amplifier / EG: Envelope Generator

AMP Envelope Generator provides a precise control signal that varies over time to modify the VCA level.

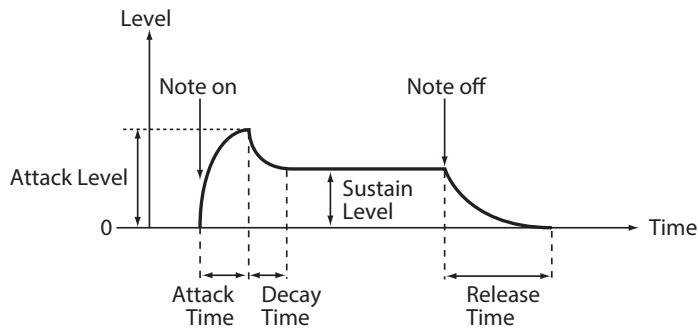
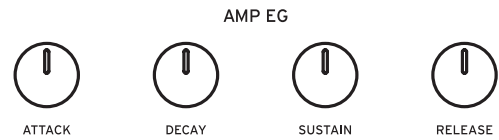

ATTACK knob [0...1023]

The ATTACK specifies the time required for the EG to reach its maximum level once a new note is played.

DECAY knob [0...1023]

The DECAY specifies the time required for the EG to fall to the preset Sustain level once the Attack portion of the EG is complete.

SUSTAIN knob [0...1023]

The SUSTAIN specifies the level that will be maintained while the key is held down (or a trigger is applied).

RELEASE knob [0...1023]

The RELEASE specifies the time required for the EG to reach its minimum level (zero) once the key or trigger is released.

EG

EG: Envelope Generator

The EG controls the cutoff frequency of the filter and temporal change of other parameters.

Modulation is applied to oscillators 1 and 2, the VCF and the LFO. The depth of the effect and other parameters are set using the PITCH EG INT knob (MODULATION), the EG INT knob (FILTER), the RATE knob (LFO), and the INT knob (LFO).

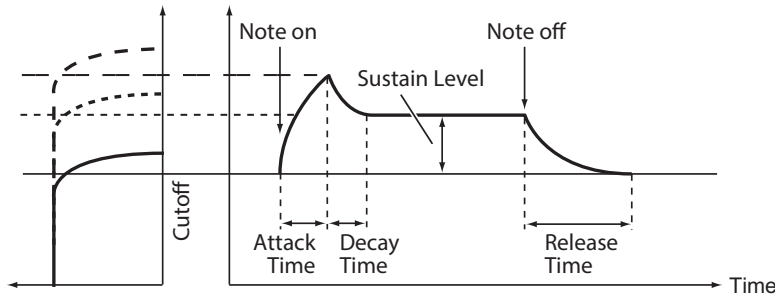
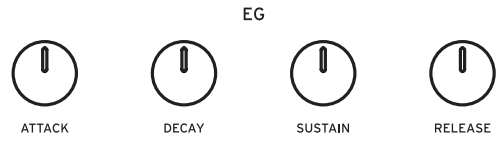

ATTACK knob [0...1023]

The ATTACK specifies the time required for the EG to reach its maximum level once a new note is played.

DECAY knob [0...1023]

The DECAY specifies the time required for the EG to fall to the preset Sustain level once the Attack portion of the EG is complete.

SUSTAIN knob [0...1023]

The SUSTAIN specifies the level that will be maintained while the key is held down (or a trigger is applied).

RELEASE knob [0...1023]

The RELEASE specifies the time required for the EG to reach its minimum level (zero) once the key or trigger is released.

LFO

LFO: Low Frequency Oscillator

The Low Frequency Oscillator creates a repeating cyclical signal. You can choose one of three LFO waveforms.

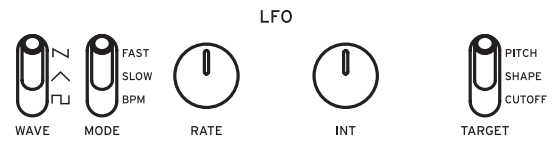

Depending on its target, the LFO can provide vibrato (PITCH); Tonal changes to the Oscillators (SHAPE); or Wah-Wah (CUTOFF) effects.

WAVE switch [□, △, ▽]

The LFO can be set to a square wave (□), a triangle wave (△), or a sawtooth wave (▽).

MODE switch [BPM, SLOW, FAST]

Specifies the range of change and action for the LFO frequency.

BPM: The LFO frequency synchronizes with the BPM of the arpeggiator.

SLOW: The range of change for the LFO frequency will be from 0.05 Hz–28 Hz.

FAST: The range of change for the LFO frequency will be from 0.5 Hz–2.8 kHz.

RATE knob [0...1023 / 4, 2, 1, 0, 3/4...1/64]

The rate knob adjusts the speed of the LFO.

Turning the knob to the right will increase the LFO speed.

INT knob [0...511]

The INT knob adjusts the intensity of the LFO.

Turning the knob to the right will increase the LFO intensity.

TIP When turning the INT knob while holding down the SHIFT button, the LFO waveform will be inverted. The setting range is 0–511.

TARGET switch [CUTOFF, SHAPE, PITCH]

Selects where the LFO modulation will be applied.

CUTOFF: Modulation is applied according to the VCF CUTOFF knob setting.

SHAPE: Modulation is applied according to the SHAPE knob setting for the oscillator, which is set in “LFO Target OSC” (p.48) of PROGRAM EDIT mode.

PITCH: Modulation is applied according to the PITCH knob setting for the oscillator, which is set in “LFO Target OSC” (p.48) of PROGRAM EDIT mode.

EFFECT section

The prologue features high-definition digital effects.

Select a modulation effect and a spatial effect (delay, reverb). The effects can be used in combination.

The prologue-16 features, when the SUB ON/PGM FETCH button is pressed (the button will light) while the sub-timbre is enabled, the modulation effect as well as the delay and reverb can be turned on and off separately for the main and sub-timbres (p.51, "Button 8 (EFFECTS)").

MOD EFFECT

OFF/ON/SELECT switch [OFF, ON, SELECT]

This sets the modulation effect.

OFF: Turns the modulation effect off.

ON: Turns the modulation effect on.

SELECT: Flipping the switch down will switch between modulation effects (CHORUS → ENSEMBLE → PHASER → FLANGER → USER → CHORUS → ...).

TIP Set the effect's sub-type in PROGRAM EDIT mode for a wider variety of effects (p.51, "Button 8 (EFFECTS)"). Switch the OFF/ON/SELECT switch while holding down the SHIFT button to select the modulation effect sub-type. For details on the sub-types, refer to "Effects list" (p.70).



SPEED knob [0...1023]

Changes the modulation effect speed to vary the sound.

Turning the knob to the right will increase the speed.

DEPTH knob [0...1023]

This sets the depth of the effect.

Turning the knob to the right will increase the intensity.

DELAY/REVERB

OFF/DELAY/REVERB switch [OFF, DELAY, REVERB]

This sets the spatial effect settings.

OFF: Turns the spatial effect off.

DELAY: Selects the delay.

REVERB: Selects the reverb.



TIP Set the effect's sub-type in PROGRAM EDIT mode for a wider variety of effects (p.51, "Button 8 (EFFECTS)"). For details on the sub-types, refer to "Effects list" (p.70).

TIME knob [0...1023]

This changes the amount of time the delay or reverb takes to disperse. Turning the knob to the right will make the delay or reverb time longer.

DEPTH knob [0...1023]

This sets the depth of the effect. Turning the knob to the right will increase the intensity.

L.F. COMP. section (prologue-16 only)

The L.F. COMP. is an analog effector used to boost or compress the low-frequency band.

This effect is placed last in the output series, providing a punchy sound.

 Note that this setting cannot be saved to a program.



GAIN



VU meter

Refer to "How to use the L.F. COMP." (p.38).

GAIN knob

This sets the intensity of the effect.

Turning the knob to the right will decrease the compressor threshold and increase the gain.

OFF/ON switch [OFF, ON]

This sets whether the effect is on or off.

OFF: Turns the L.F. COMP. off.

ON: Turns the L.F. COMP. on. When the L.F. COMP. is on, the VU meter LED will light, and the needle will move to around the 0 db mark.

How to use the L.F. COMP.

Turn the L.F. COMP. on to boost or compress the input signal, according to the GAIN knob setting.

Both the master volume (MASTER knob) and gain (GAIN knob) settings are important in achieving a good sound.

The compressor will tend to activate more often when the master volume is set high, since the output signal is strong. On the other hand, when the master volume is low, the compressor will activate less.

When a loud sound is outputted, you should be able to achieve enough compressor effect, even at lower gain settings.

The VU meter shows about how much the output signal is being compressed. When the needle moves to the left, this means that the compressor is being heavily applied.

Use both the MASTER knob and GAIN knob together to achieve a sound you like.

About timbre

The programs of the prologue contain two timbres, a main timbre and a sub-timbre. Enabling the sub-timbre will let you play the prologue as a two-timbre synthesizer. You can also use split, crossfade or layering when playing these timbres.

The **prologue-16** features 16 voices in single timbre mode, or 8+8 voices in double timbre mode.

The **prologue-8** features 8 voices in single timbre mode, or 4+4 voices in double timbre mode.

Enabling the sub-timbre

Use one of the methods below to enable the sub-timbre (double timbre mode).

prologue-16

1. In Play mode, press the SUB ON/PGM FETCH button.

The sub-timbre will be enabled, and the instrument will play in double timbre mode (8+8 voices).

The SUB ON/PGM FETCH button will light.

prologue-8

1. Press the EDIT MODE button.

The instrument will enter Edit mode.

2. Turn the PROGRAM/VALUE knob or press the EDIT MODE button, and select PROGRAM EDIT.

3. Press button 3.

“Sub Timbre” will appear on the display.

4. Turn the PROGRAM/VALUE knob, and select “On”.

The sub-timbre will be enabled, and the instrument will play in double timbre mode (4+4 voices).

5. Press the EXIT button.

Enter Play mode.

Setting the timbre parameters

You can also use split, crossfade or layering when playing two timbres, as well as adjust their volume balance.

prologue-16

1. Use the knobs and switches on the front panel to set the timbre parameters.

Adjust the **volume balance** between the main timbre and the sub-timbre using the **MAIN/SUB BALANCE knob**. For details, refer to “MAIN/SUB BALANCE knob (prologue-16 only)” (p.22).

Use the **TYPE switch** to set the timbre performance type (layer, crossfade or split). For details, refer to “TYPE switch (prologue-16 only)” (p.22).

Set the timbre position and split point (when playing in split mode) in “Timbre,” PROGRAM EDIT mode. Refer to “Button 3 (TIMBRE)” (p.46) for details.

Set the timbre to edit using the **PANEL switch**.

TIP Editing a timbre applies to the basic parameters on the front panel, as well as all detailed parameters in PROGRAM EDIT mode.

prologue-8

1. Press the EDIT MODE button.

The instrument will enter Edit mode.

2. Turn the PROGRAM/VALUE knob or press the EDIT MODE button, and select PROGRAM EDIT.

3. Press button 3 several times.

Each parameter related to the timbre is shown on the display.

Refer to “Button 3 (TIMBRE)” (p.46) for details on each parameter.

4. Turn the PROGRAM/VALUE knob to change the settings.

5. Press the EXIT button.

Program fetch function

Use the program fetch function to copy the sound of a program to the sub-timbre of the currently selected program. This function is especially convenient for combining sounds and hearing how they sound together.

prologue-16

1. Hold down the SUB ON/PGM FETCH button.

The prologue will enter the PROGRAM FETCH settings in FUNCTION mode, and the current program will be shown in the display.

In this case, if the sub-timbre is disabled, it will change to enabled.

 When pressing button 2 in FUNCTION mode to directly display "Program Fetch," the sub-timbre will not be enabled even when it is disabled.

2. Turn the PROGRAM/VALUE knob to display the main or sub-timbre of other programs, and select the sound to copy.

The word "PREV" will display to the right side of the program number in the display, so that you can confirm the sound.

The main timbre is displayed as "M" at bottom right, and the sub-timbre is displayed as "S" at bottom right.

Check the sounds by playing the keyboard.

 Initialization programs cannot be selected.

TIP To cancel the program fetch function, press the EXIT button.

3. Press the WRITE button.

The sound you selected will be copied to the sub-timbre of the program, and the display will indicate the message "Complete".

TIP We recommend that you save the program after using the program fetch function. Any edits that you make to the current program will be lost if you turn off the power or recall a different program before saving. See "Saving a Program" (p.19) for details.

prologue-8

1. Press the **EDIT MODE** button to enter **FUNCTION** mode.

2. Press **PROGRAM SORT/EDIT PAGE** button 2.

The prologue will enter the **PROGRAM FETCH** settings, and the current program will be shown in the display.

3. Turn the **PROGRAM/VALUE** knob to display the main or sub-timbre of other programs, and select the sound to copy.

The word "PREV" will display to the right side of the program number in the display, so that you can confirm the sound.

The main timbre is displayed as "M" at bottom right, and the sub-timbre is displayed as "S" at bottom right.

Check the sounds by playing the keyboard.

 Initialization programs cannot be selected.

TIP To cancel the program fetch function, press the **EXIT** button.

4. Press the **WRITE** button.

The sound you selected will be copied to the sub-timbre of the program, and the display will indicate the message "Complete".

TIP We recommend that you save the program after using the program fetch function. Any edits that you make to the current program will be lost if you turn off the power or recall a different program before saving. See "Saving a Program" (p.19) for details.

Edit Mode

Although nearly all of the prologue's main parameters can be edited using the knobs and switches on the panel, other detailed parameters are accessed using the **Edit mode**.

There are three sub-modes within the Edit mode: **PROGRAM EDIT mode**, **FUNCTION mode**, and **GLOBAL EDIT mode**.

How to enter the Edit mode

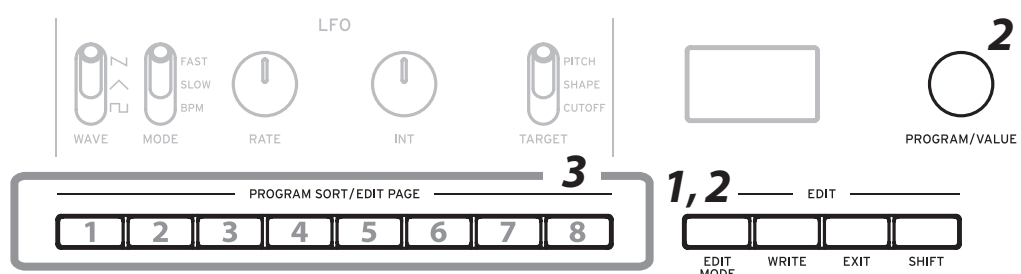

1. Press the EDIT MODE button.

Each Edit mode is shown in the display, and the buttons light.



2. Press the EDIT MODE button in succession; or use the PROGRAM/VALUE knob to select PROGRAM EDIT mode, FUNCTION mode, or GLOBAL EDIT mode.

PROGRAM EDIT mode: Use this mode to change the program name and assign parameters to the modulation wheel or pedal, as well as to make other program editing functions such as timbre settings.

FUNCTION mode: Use this mode to initialize or copy a program, perform a MIDI data dump and so on.

GLOBAL EDIT mode: Use this mode to set how the knobs and switches should function, as well as settings such as MIDI for the entire synthesizer.

3. Press the PROGRAM SORT/EDIT PAGE buttons 1–8.

The prologue will enter the respective Edit page, and the parameter names will be indicated on the display.

Press the same button repeatedly to switch to the page to the right.

TIP Press the same button repeatedly while holding the SHIFT button down to switch to the page to the left.

For details on each parameter, refer to “PROGRAM EDIT mode” (p.45), “FUNCTION mode” (p.52) and “GLOBAL EDIT mode” (p.54).

4. After you have configured the parameters in PROGRAM EDIT mode and/or FUNCTION mode, press the WRITE button to save your changes.

See “Saving a Program” (p.19) for details.

GLOBAL EDIT mode parameters are automatically saved when you switch pages, so there is no need to save them manually.

 If you do not save your changes and select another Program after you have configured the parameters in the PROGRAM EDIT mode and the FUNCTION mode, your settings will be lost.

PROGRAM EDIT mode

Button 1 SORT	Button 2 PROGRAM NAME	Button 3 TIMBRE	Button 4 PEDAL & WHEEL	Button 5 MODULATION	Button 6 OTHER SETTINGS	Button 7 MULTI ENGINE	Button 8 EFFECTS
Category	PROGRAM NAME	Sub Timbre	M.Wheel Assign	LFO Target OSC	Arpeggiator	Parameter 1	Mod Effect Sub Type
		Edit Timbre	M.Wheel Range	LFO Key Sync	Multi Routing	Parameter 2	Delay/Reverb Sub Type
		Timbre Type	E.Pedal Assign	LFO Voice Sync	EG Legato	Parameter 3	Mod Effect
		Main/Sub Balance	Bend Range +	EG Velocity	Portamento Mode	Parameter 4	Delay/Reverb
		Main/Sub Position	Bend Range -	Amp Velocity	Voice Spread	Parameter 5	
		Split Point			Program Level	Parameter 6	

Button 1 (SORT)

Configures the program sort settings.

Category

Sets the category for the program.

This setting is used when sorting programs into categories using the program sort function.

Button 2 (PROGRAM NAME)

You can create a Program Name up to 12 characters in length.

Rotate the PROGRAM/VALUE knob to select the desired character, then press button 2 to move the cursor to the next position.

Button 3 (TIMBRE)

This configures the timbre settings.

Sub Timbre [Off, On]

Sets whether the sub-timbre is enabled or disabled.

Edit Timbre [Main, Main+Sub, Sub]

This selects the timbre to edit.

Main: Edits the main timbre.

Main+Sub: Edits both the main and sub-timbres.

Sub: Edits the sub-timbre.

TIP Editing a timbre applies to the basic parameters on the front panel, as well as all detailed parameters in PROGRAM EDIT mode.

Timbre Type [Layer, Xfade, Split]

Sets the performance type for the main timbre and the sub-timbre.

Layer: The main timbre and sub-timbre will be layered together when playing.

Xfade: As you move up the keyboard, the sub timbre will gradually fade into the main timbre.

Split: The main timbre and sub-timbre will be split into different ranges of the keyboard when playing.

Main/Sub Balance [0...127]

Adjusts the volume balance between the main timbre and the sub-timbre.

64: The volume for the main timbre and the sub-timbre will be the same.

Increasing the value will make the main timbre louder, and decreasing the value will make the sub-timbre louder.

Main/Sub Position [Sub <--> Main / Main <--> Sub]

This sets the positions of the main timbre and the sub-timbre.

Sub <--> Main: Positions the main timbre on the right side of the keyboard, and the sub-timbre on the left side.

Main <--> Sub: Positions the main timbre on the left side of the keyboard, and the sub-timbre on the right side.

Split Point [C-1...9]

This sets the split point for the main and sub-timbres.

Button 4 (PEDAL & WHEEL)

This button is for settings related to the expression pedal, modulation wheel and pitch bend wheel.

M.Wheel Assign [BALANCE...GATE TIME]

This sets the parameters that are assigned to the modulation wheel.

BALANCE	A.EG ATTACK (Amp EG Attack)
PORTAMENTO	A.EG DECAY (Amp EG Decay)
V.SPREAD (Voice Spread)	A.EG SUSTAIN (Amp EG Sustain)
V.M DEPTH (Voice Mode Depth)	A.EG RELEASE (Amp EG Release)
VCO1 PITCH	EG ATTACK
VCO1 SHAPE	EG DECAY
VCO2 PITCH	EG SUSTAIN
VCO2 SHAPE	EG RELEASE
CROSS MOD	LFO RATE
PITCH EG INT	LFO INT
MULTI SHAPE (Multi Engine Shape)	MOD FX SPEED
VCO1 LEVEL	MOD FX DEPTH
VCO2 LEVEL	DL/RV TIME (Delay/Reverb Time)
MULTI LEVEL (Multi Engine Level)	DL/RV DEPTH (Delay/Reverb Depth)
CUTOFF	GATE TIME
RESONANCE	
CUTOFF EG INT	

M.Wheel Range [-100%...+100%]

Sets how much the assigned parameter will change when using the modulation wheel.

E.Pedal Assign [OFF, VOLUME...RV/DY DEPT]

This sets the parameters that are assigned to the expression pedal connected to this instrument.

OFF	RESONANCE
VOLUME	CUTOFF EG INT
BALANCE	A.EG ATTACK (Amp EG Attack)
PORTAMENTO	A.EG DECAY (Amp EG Decay)
V.SPREAD (Voice Spread)	A.EG SUSTAIN (Amp EG Sustain)
V.M DEPTH (Voice Mode Depth)	A.EG RELEASE (Amp EG Release)
VCO1 PITCH	EG ATTACK
VCO1 SHAPE	EG DECAY
VCO2 PITCH	EG SUSTAIN
VCO2 SHAPE	EG RELEASE
CROSS MOD	LFO RATE
PITCH EG INT	LFO INT
MULTI SHAPE (Multi Engine Shape)	MOD FX SPEED
VCO1 LEVEL	MOD FX DEPTH
VCO2 LEVEL	DL/RV TIME (Delay/Reverb Time)
MULTI LEVEL (Multi Engine Level)	DL/RV DEPTH (Delay/Reverb Depth)
CUTOFF	

Bend Range + [Off, 1 Note...12 Note]

Specifies how much pitch bend will be applied when moving the pitch bend wheel in the plus (upward) direction.

Bend Range - [Off 1 Note...12 Note]

Specifies how much pitch bend will be applied when moving the pitch bend wheel in the minus (downward) direction.

Button 5 (MODULATION)

Configures the modulation settings.

LFO Target OSC [All, VCO1+2, VCO2, Multi]

This selects the oscillator that modulation will be applied to.

All: Modulation is applied to operators 1 and 2, as well as the MULTI ENGINE.

VCO1+2: Modulation is applied to operators 1 and 2.

VCO2: Modulation is applied to operator 2.

Multi: Modulation is applied to the MULTI ENGINE.

LFO Key Sync [Off, On]

With the LFO Key Sync set to On, the phase of the LFO will be reset with each note-on received from the keyboard.

LFO Voice Sync [Off, On]

Use the LFO Voice Sync to choose whether the phase of the LFO will be synchronized between voices.

EG Velocity [0..127]

Sets the strength of the Cutoff EG Int using velocity.

Amp Velocity [0..127]

Amp Velocity is used to specify how much the volume will change according to the keyboard velocity.

0: The velocity will not affect the volume.

The larger the value, the more effect that keyboard velocity will have on volume.

Button 6 (OTHER SETTINGS)

Arpeggiator [Main+Sub, Main, Sub]

Sets the timbre(s) that will be played by the arpeggiator.

When this is set to “Main+Sub”, both timbres will sound. When this is set to “Main”, the arpeggiator will play only the main timbre; and when this is set to “Sub”, only the sub-timbre will sound.

Multi Routing [Pre VCF, Post VCF]

This sets whether the MULTI ENGINE is mixed prior to the signal reaching the VCF, or whether to bypass the VCF and mix.

When this is set to “Post VCF,” the VCF will not affect the MULTI ENGINE.

EG Legato [Off, On]

When the voice mode is set to “Mono”, “Unison” or “Chord,” this sets what happens with the EG when a key is played in legato while another key is being pressed.

Off: The EG will be retriggered.

On: The EG will not be retriggered.

Portamento Mode [Auto, On]

Auto: When playing in a legato style (playing a new note before any previously played note is released), portamento will be applied.

On: Portamento will be applied, even when fully releasing a key and then playing the next note.

Voice Spread [0...127]

This adjusts the amount of voice spread that is applied to achieve a stereo effect.

The higher the value, the stronger the voice spread effect will be.

Program Level [-18.0dB...+6.0dB]

Program Level allows you to adjust the volume of a Program relative to other Programs.

Increasing this value will make the volume louder.

Button 7 (MULTI ENGINE)

This button configures the MULTI ENGINE settings.
The parameters that are displayed will change, depending on the settings in “NOISE/VPM/USR switch” (p.26), MULTI ENGINE.

When the noise generator is selected

There are no parameters to set for the noise generator.

When the VPM oscillator is selected

The VPM oscillator has 16 presets, each with six parameters.
You can set these parameters to make changes to the sound.

If all parameters are set to 0%, the effects set in the preset will be used, and the effect will increase as the **value is increased (+)**.

Feedback (Parameter 1) [-100%...+100%]

Sets the depth of the modulator feedback.

Noise Depth (Parameter 2) [-100%...+100%]

Adjusts the depth of the noise modulation.

Shape Mod Int (Parameter 3) [-100%...+100%]

Adjusts the depth of the internal EG effect.

Mod Attack (Parameter 4) [-100%...+100%]

Adjusts the attack time of the internal EG.

Mod Decay (Parameter 5) [-100%...+100%]

Adjusts the decay time for the internal EG.

Mod Key Track (Parameter 6) [-100%...+100%]

Adjusts the depth of the modulator effect from keyboard tracking. The higher the sound frequency, the less noticeable the effect becomes.

When the user oscillator is selected

See the “prologue user contents guide” (www.korg.com) for details.

Button 8 (EFFECTS)

This button is used to configure the effects.

Mod Effect Sub Type

This sets the modulation effect type and the sub-type.

Push the OFF/ON/SELECT switch up to SELECT, and select the effect type.

Turn the PROGRAM/VALUE knob to select the sub-type.

TIP For details on the effect types and sub types, refer to "Effects list" (p.70).

Delay/Reverb Sub Type

This sets the delay or reverb effect type and the sub-type.

Use the OFF/DELAY/REVERB switch to select the effect type.

Turn the PROGRAM/VALUE knob to select the sub-type.

TIP For details on the effect types and sub types, refer to "Effects list" (p.70).

Mod Effect [Main+Sub, Main, Sub]

This sets the timbre(s) to which the modulation effect will be applied.

Main+Sub: Modulation effect will be applied to both main and sub-timbres.

Main: Modulation effect will be applied to the main timbre.

Sub: Modulation effect will be applied to the sub-timbre.

Delay/Reverb [Main+Sub, Main, Sub]

This sets the timbre(s) to which delay or reverb will be applied.

Main+Sub: Delay or reverb will be applied to both the main and sub-timbres.

Main: Delay or reverb will be applied to the main timbre.

Sub: Delay or reverb will be applied to the sub timbre.

FUNCTION mode

Button 1 INITIALIZE	Button 2 PROGRAM FETCH					Button 7 DUMP	Button 8 ALL DUMP
Init Program	Program Fetch					Program Dump	All Dump (USB)
Init Main Timbre							All Dump (MIDI)
Init Sub Timbre							

Button 1 (INITIALIZE)

This button initializes the current Program.

Turn the PROGRAM/VALUE knob until “Press WRITE” is indicated in the display. The WRITE button will blink.

Press the WRITE button to initialize the Program. The display will indicate the message “Initialized”.

Init Program

This initializes the currently selected program.

Init Main Timbre

Initializes the main timbre of the currently selected program.

Init Sub Timbre

Initializes the sub-timbre of the currently selected program.

Button 2 (PROGRAM FETCH)

Program Fetch

The program fetch function copies the sound of another program to the sub-timbre of the currently selected program.

Refer to “Program fetch function” (p.41) for details.

Button 7 (DUMP)

Program Dump

Transmits the SysEx data for the currently selected program to another prologue, MIDI data file, computer or other compatible device that is connected to this instrument.

Turn the PROGRAM/VALUE knob until “Press WRITE” is indicated in the display. The WRITE button will blink.

Press the WRITE button to send a SysEx Program dump from the prologue’s MIDI OUT and USB B connector. The display will indicate the message “Program Dump”.

Button 8 (ALL DUMP)

This button transmits the programs, live set and global SysEx data of this instrument to another prologue, MIDI data file, computer or other compatible device that is connected.

All Dump (USB)

Turn the PROGRAM/VALUE knob until “Press WRITE” is indicated in the display. The WRITE button will blink.

Press the WRITE button to transmit the MIDI data dump via the USB B connector. The display will indicate the message “Transmitting”. The data will take about 10 seconds to transmit.

-  If the USB cable is not connected, or if the MIDI IN port on the PC is not open, the data will not be transmitted.

All Dump (MIDI)

Turn the PROGRAM/VALUE knob until “Press WRITE” is indicated in the display. The WRITE button will blink.

Press the WRITE button to transmit the MIDI data dump via the MIDI OUT connector. The display will indicate the message “Transmitting”. The data will take about 30 seconds to transmit.

GLOBAL EDIT mode

GLOBAL EDIT functions apply to the entire prologue universally.

Button 1	Button 2	Button 3	Button 4	Button 5	Button 6	Button 7	Button 8
GLOBAL 1	GLOBAL 2	GLOBAL 3	GLOBAL 4	GLOBAL 5	GLOBAL 6	GLOBAL 7	GLOBAL 8
Master Tune	D.Pedal Polarity	Local SW	Sync In Unit	MIDI Route	MIDI Rx Prog Chg	Parameter Disp	Brightness
Transpose		Velocity Curve	Sync Out Unit	MIDI Global Ch	MIDI Rx CC		Auto Power Off
		Knob Mode	Sync In Polarity	MIDI Sub CC Ch	MIDI Rx Pitch Bend		
			Sync Out Polarity	Clock Source	MIDI Tx Prog Chg		
				MIDI Route	MIDI Tx CC		
					MIDI Tx Pitch Bend		

Button 1 (GLOBAL 1)

These functions control the tuning and transposition of the prologue.

Master Tune [-50 Cent...+50 Cent]

This adjusts the overall tuning of the entire prologue in one-cent units (semitone = 100 cents), over a range of ± 50 cents.

0: A4 is equal to 440 Hz.

Transpose [-12 Note...+12 Note]

Transposing the keyboard allows you play in a different key using familiar fingerings on the keyboard.

Button 2 (GLOBAL 2)

This button is used to set the polarity of the pedal.

D. Pedal Polarity [- (KORG), +]

Sets polarity to the same polarity as the damper pedal that is connected to the DAMPER jack. If the polarities do not match, the damper pedal will not operate correctly.

- **(KORG)**: Use this setting when connecting an optional DS-1H damper pedal (sold separately) or a PS-3/PS-1 pedal switch (sold separately). The polarity of Korg damper pedals and pedal switches is “-” (↓: open type).

+ : Use this setting when connecting damper pedals with a “+” polarity (↑: cross type). If the polarities do not match, the damper pedal will not operate correctly.

Button 3 (GLOBAL 3)

These functions relate to performance aspects of the prologue—knob operation, velocity curves, local settings, and more.

Local SW [Off, On]

The local connection makes a link between the prologue keyboard the sound-generating circuitry. Normally, this link is On. However, if you are using the prologue with an external sequencer or sequencing software, you will want to set the local connection to Off to eliminate the double-triggering of notes caused by MIDI echo.

Off: The prologue’s keyboard will be internally disconnected from the tone generator.

Velocity Curve [Type 1..8, Const 127]

Changing the Velocity Curve allows you to match the dynamic response of the prologue keyboard to your own playing style and technique.

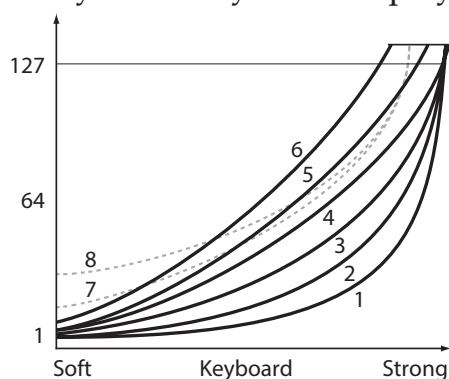

Type 1	This curve requires you to play strongly in order to produce an effect.
Type 2, 3	:
Type 4	This is a typical curve.
Type 5	:
Type 6	This curve produces an effect without requiring you to play very strongly.
Type 7	This curve produces a fairly steady effect with little change for medium-strength playing.
Type 8	This curve produces a fairly steady effect with little change for medium-strength playing (a flatter curve than 7).
Const 127	All notes will sound at maximum velocity.

Curve types 7 and 8 produce little change for medium-strength playing, and are suitable when keyboard velocity is not required, or when you want to play each note at the same velocity. However, these curves will produce a great deal of change with softly played notes, so the sound may be more difficult to control.

Choose the curve that is most appropriate for your playing dynamics or for the effect you want to obtain.

[Knob Mode](#) [\[Jump, Catch, Scale\]](#)

The front panel knobs can operate in one of three modes:
This action will be set for timbres that are set using “Edit Timbre”.

Jump: When you turn the knob, the parameter value will jump to the value indicated by the knob. Since this makes it easy to hear the results while editing, we recommend that you use this setting.

Catch: Turning the knob will not change the parameter value until the knob position matches the stored value. We recommend that you use this setting when you don’t want the sound to change abruptly, such as while performing.

Scale: When you turn the knob, the parameter value will increase or decrease in a relative manner in the direction that it is turned. When you turn the knob and it reaches the full extent of its motion, it will operate proportionate to the maximum or minimum value of the parameter. Once the knob position matches the parameter value, the knob position and parameter value will subsequently be linked.

If the parameter value does not change

In some cases, the parameter value may not change, even when you turn the knob from left to right. This means that the knob mode is set to “Catch”.

In this case, the actual value of the parameter you’re editing (the value shown in the display) will not change unless it matches the position of the knob. In Catch mode, the knob position and the value will be linked only when the knob position reaches the actual value. This prevents an unnatural change in sound that is caused when a value suddenly changes.

Let’s say that you’ve turned the knob to edit a certain parameter, and that the knob is in the position shown.



The actual value of the parameter is at the position shown by the triangle.

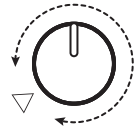

The parameter value will not change until the knob position reaches the triangle mark.

Once the knob has reached the position corresponding to the actual value, the parameter value and the knob position will be linked, and the value will change as you turn the knob.



Button 4 (GLOBAL 4)

These parameters relate to the SYNC IN/SYNC OUT jack settings.

Sync In Unit [16th Note, 8th Note]

This sets how much the arpeggiator will advance with each pulse received via the SYNC IN jack.

16th Note: The arpeggiator will advance one sixteenth note for each pulse.

8th Note: The arpeggiator will advance one eighth note for each pulse.

Sync Out Unit [16th Note, 8th Note]

This sets when to send each pulse via the SYNC OUT jack, according to how far the arpeggiator has advanced.

16th Note: A pulse will be outputted for every sixteenth note.

8th Note: A pulse will be outputted for every eighth note.

Sync In Polarity [Rise, Fall]

In order to achieve synchronization with other units, the polarity of the SYNC IN jack may need to be changed.

Rise: The prologue will sync to the pulse as it rises to its crest (the highest point) of the waveform.

Fall: The prologue will sync to the pulse as it falls to its trough (the lowest point) of the waveform.

Sync Out Polarity [Rise, Fall]

In order for other units to correctly sync with the prologue, the polarity of the SYNC OUT jack may need to be changed.

Rise: The prologue will create a sync pulse as it rises to its crest (the highest point) of the waveform.

Fall: The prologue will create a sync pulse as it falls to its trough (the lowest point) of the waveform.

Button 5 (GLOBAL 5)

These parameters relate to the prologue's MIDI capabilities.

MIDI Route [USB+MIDI, USB]

MIDI signals can be sent and received via the MIDI and USB connectors, or by the USB connector alone.

USB+MIDI: MIDI messages are received via the USB B connector and the MIDI IN connector; messages are transmitted from the USB B connector and the MIDI OUT connector.

USB: MIDI messages will be transmitted and received only via the USB B connector. When using the USB connector as a MIDI interface, it is advantageous to use this setting.

MIDI Global Ch [1..16]

Specifies the global MIDI channel of the prologue.

This MIDI channel is used to transmit and receive note messages, pitch bend message, data dump messages and control change messages for the main timbre.

- ⚠ The same channel cannot be selected for both "MIDI Global Ch" and "MIDI Sub CC Ch".

MIDI Sub CC Ch [1..16]

This MIDI channel is used to transmit and receive control change messages for the sub-timbre.

Set the device to which the prologue is connected and the prologue to the same MIDI channel.

- ⚠ The same channel cannot be selected for both "MIDI Global Ch" and "MIDI Sub CC Ch".

Clock Source [Auto (USB), Auto (MIDI), Internal]

Many features of the prologue can be sync'd to the tempo or BPM. This parameter allows you to specify whether the clock source is internal, or an external MIDI Clock Source.

Auto (USB), Auto (MIDI): When there is no input, the internal clock will be used; and when input is detected, the internal clock will be synchronized to the clocks from the USB B and MIDI IN connectors respectively.

Internal: Only the internal clock to be used.

- ⚠ When a cable is plugged into the SYNC IN jack, the internal clock is synchronized to the SYNC IN jack clock, regardless of the MIDI clock settings.

Button 6 (GLOBAL 6)

MIDI Rx Prog Chg [Off, On]

Selects whether MIDI program change messages will be received.

MIDI Rx CC [Off, On]

Selects whether MIDI control change messages will be received.

TIP CC#1 (Modulation Wheel), CC#64 (Damper) and CC#120 onward cannot be controlled using this setting.

MIDI Rx Pitch Bend [Off, On]

Selects whether MIDI pitch bend messages will be received.

MIDI Tx Prog Chg [Off, On]

Selects whether MIDI program change messages will be transmitted.

MIDI Tx CC [Off, On]

Selects whether MIDI control change messages will be transmitted.

MIDI Tx Pitch Bend [Off, On]

Selects whether MIDI pitch bend messages will be transmitted.

Button 7 (GLOBAL 7)

These parameters relate to the prologue's display, and what information is seen there.

Parameter Disp [Normal, All]

Normal: Only major information such as operating the pitch-related knobs or switching the OUTPUT ROUTING switch will be displayed.

All: When any knob except for the MASTER knob, the GAIN knob in the L.F. COMP. section (prologue-16 only) or the MULTI ENGINE TYPE knob is turned, the value is indicated; and when operating a switch, the setting is indicated. Parameters for switches that have an LED may not show up in the display.

Button 8 (GLOBAL 8)

These parameters relate to the prologue's display and power settings.

Brightness [1...10]

Adjusts the display brightness.

- ⚠ Continuous use of the prologue while the brightness is set to a high value will have an adverse effect on the overall life of the display.

Auto Power Off [Off, On]

Using the **Auto Power Off feature**, the prologue can be set to automatically turn off after approximately four hours have elapsed without any operation of the knobs, switches, or keyboard, and without any input. Once this occurs, you will need to turn the prologue on again manually.

Off: The Auto Power Off feature will be disabled.

On: The Auto Power Off feature is enabled. For details, refer to "Auto Power Off Feature" (p.10).

Other functions

Tuning

As with all analog instruments, the prologue's circuitry can drift over time during performance due to changes in environment and temperature. The prologue provides an **auto-tuning function** that automatically tunes the instrument's analog circuits on demand, to correct for any analog drift.

As you continue to play the prologue for a while right after you've turned it on, the pitch and tone may gradually drift. If the pitch drift becomes noticeable, use the steps below to tune the instrument. This will manually bring the prologue back into tune.

- 1. Press the EXIT button while holding down the SHIFT button.**

Tuning will begin, and the display will indicate "Tuning...".

The tuning will take about 15 seconds.

 During tuning, you will temporarily be unable to play the prologue.

Restoring the Factory settings

You can restore the prologue's preset Programs and global settings to their original factory-set state at any time.

- 1. Begin with the prologue turned Off.**

- 2. While holding down the WRITE button and the EXIT button, turn the prologue On.**

"FACTORY RESET" will be indicated in the display.

- 3. Turn the PROGRAM/VALUE knob to select the items you wish to reset to the factory-set default settings.**

PRESET: Restores the preset programs (001–250) and the live set to their factory-set default settings.

 If you do not want to erase the preset programs, press the WRITE button to save them to the user programs (251–500).

GLOBAL: Restores the GLOBAL settings to their factory-set default settings.

ALL: Restores the preset programs, user programs, the live set and GLOBAL settings to their factory-set default settings.

 Use caution, as this will replace all data with the factory-set default settings (including the sounds saved to the user programs).

4. Press the WRITE button.

The display will indicate the message “Are you sure?”.

5. Turn the PROGRAM/VALUE knob to select “Yes”, and press the WRITE button.

The factory-set default data will be reloaded, and the prologue will be restored to its factory default state.

TIP Press the EXIT button, or select “No” using the PROGRAM/VALUE knob and press the WRITE button to cancel the operation.

 Never turn off the prologue while data is being loaded.

Shortcuts using the SHIFT button

When in **Play mode**, you can hold down the SHIFT button and press other buttons at the same time for direct access to various convenient functions.

Function	SHIFT button +	
Load panel information	WRITE button	Loads the state of the front panel switches and knobs into the selected Program. Used to make the sound match the state of the controls on the front panel.
Tuning	EXIT button	When the prologue’s sound generator is not making any sound, auto-tuning occurs automatically; but you can use this function to retune the prologue manually in Play mode if the tuning seems to be drifting. The internal temperature tends to changes more right after the power is turned on, which may cause the instrument to go out of tune. Press the EXIT button while holding down the SHIFT button again to cancel manual tuning, if you accidentally started it by mistake.
Pitch settings	PITCH knob	Sets the pitch in semitones.
Effect select	OFF/ON/SELECT switch (MOD EFFECT)	Pushing this switch to SELECT allows you to set the effect’s sub-type.
LFO waveform phase settings	INT knob (LFO)	This allows you to invert the phase of the LFO waveform.
MULTI ENGINE parameter settings	SHAPE knob (MULTI ENGINE)	Adjusts the modulator ratio when setting the VPM with the MULTI ENGINE’s NOISE/VPM/USR switch.

Using with other devices

Syncing to instruments with SYNC IN/OUT jacks

The prologue can be connected to other instruments such as the Korg volca series or DAW equipment that have a SYNC IN and OUT jack, allowing multiple devices to play back together in sync.

Connection using the SYNC IN and OUT jacks

When controlling an external device from the prologue

In order to synchronize other devices such as the volca to the prologue, use a mini cable to connect the SYNC OUT jack of this instrument to the SYNC IN jack of the external device.

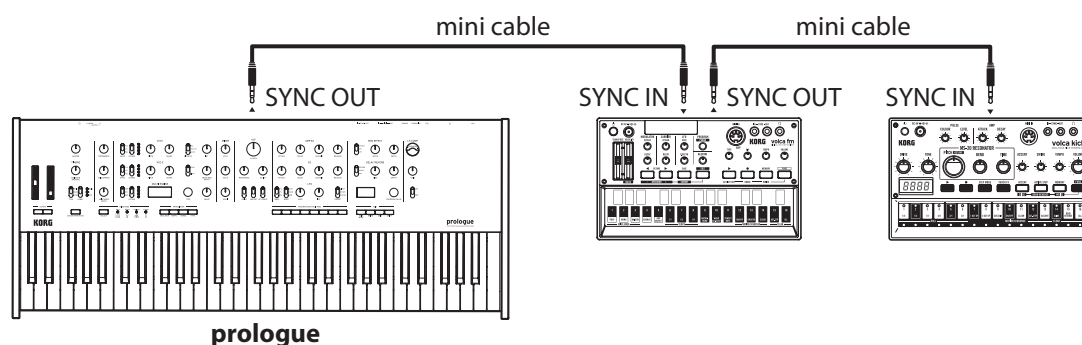

Use the same settings for “Sync Out Unit” on this prologue and “Sync In Unit” on the first external device to sync. Similarly, use the same settings for “Sync In Unit” on the second external device to sync.

Use the same settings for “Sync Out Polarity” on this prologue and “Sync In Polarity”, “Sync Out Polarity” on the first external device to sync. Similarly, use the same settings for “Sync In Polarity” on the second external device to sync.

Refer to "Button 4 (GLOBAL 4)" (p.58) for the settings to make on the prologue. See the owner’s manuals of each respective instrument for how to connect them for synchronization.

Starting the arpeggiator on the prologue and the sequencer on the connected device will make the sequencer of the connected device synchronize with the prologue.

Controlling the prologue from an external device

In order to synchronize this instrument to other devices, use a mini cable to connect the SYNC OUT jack of the external device and the SYNC IN jack of the prologue.

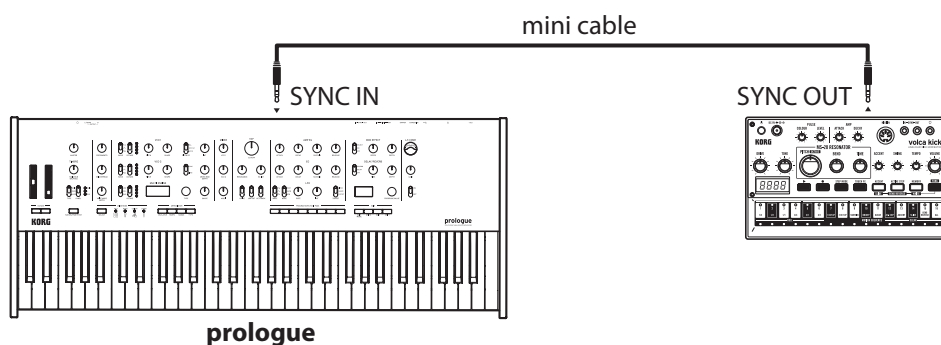

Set the "Sync In Unit" of the prologue to the same setting as the "Sync Out Unit" of the external device.

Set the "Sync In Polarity" of the prologue to the same setting as the "Sync Out Polarity" of the external device.

Refer to "Button 4 (GLOBAL 4)" (p.58) for the settings to make on the prologue.

See the owner's manuals of each respective instrument for how to connect them for synchronization.

Starting the sequencer of the connected device and the arpeggiator of this prologue will make the prologue's arpeggiator sync with the external device.

Using with other MIDI devices

MIDI stands for Musical Instrument Digital Interface, and is a worldwide standard for exchanging various types of musical data between electronic musical instruments and computers.

When MIDI cables are used to connect two or more MIDI devices, performance data can be exchanged between the devices, even if they were made by different manufacturers.

MIDI data can also be exchanged between the prologue and your personal computer using a single USB cable. The prologue lets you assign MIDI control change numbers (CC#) to the major parameters that affect the sound, and control these parameters from an external MIDI sequencer while you play the tone generator. You can also use the front panel knobs or buttons to transmit these control change messages, in order to control an external MIDI device.

You can also synchronize the prologue's tempo to the MIDI clock of an external MIDI sequencer or other device, so that the prologue will play in time with the external device and with any changes you make.

Connecting Devices via MIDI and USB

Controlling an external MIDI device from the prologue

If you want to use the prologue's keyboard, controllers, and sequencer to play sounds on or to control an external MIDI tone generator, connect the prologue's MIDI OUT connector to the external MIDI tone generator's MIDI IN connector using a MIDI cable.

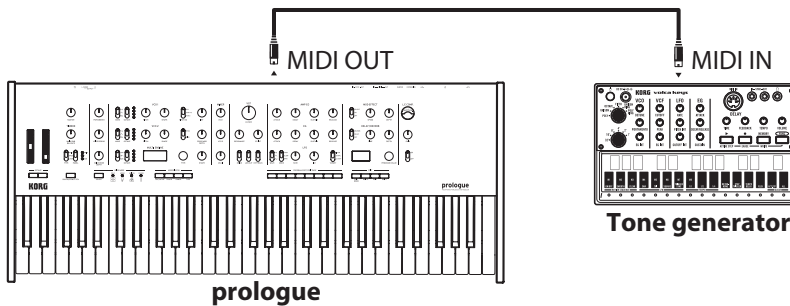

Controlling the prologue from an external MIDI device

If you want to play or control the prologue from another MIDI keyboard, sequencer, or other device, connect the MIDI OUT connector of the external MIDI device to the prologue's MIDI IN connector with a MIDI cable.

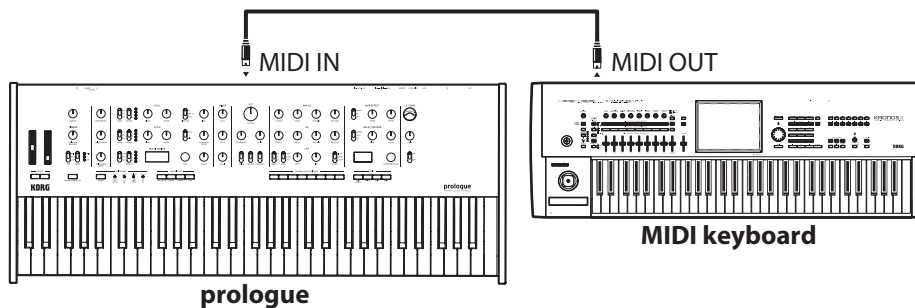

Connecting the prologue to a computer via MIDI

You might want to play the prologue's keyboard and record your performance on an external MIDI sequencer or computer (connected using the MIDI interface), and then play the prologue while monitoring or playing back what you recorded. You also might want to use the prologue as both an input device for playing notes and as a MIDI tone generator. In either case, you'll need to connect the MIDI OUT connector to the MIDI IN connector on both the prologue and the external MIDI sequencer or computer.

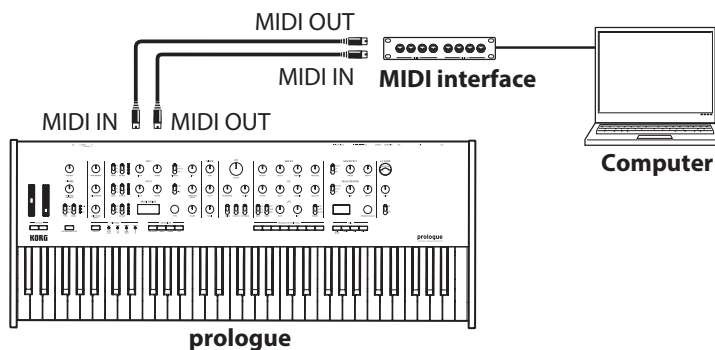

 Some MIDI interface devices may be unable to transmit or receive MIDI SysEx messages to or from the prologue.

TIP It's convenient to use the USB connector when connecting the prologue to a personal computer.

Connecting the prologue to a computer via USB

In order to use a USB connection, you'll need to install the Korg USB-MIDI driver on your computer. Download the "Korg USB-MIDI driver" from the Korg website, and install it as described in the accompanying documentation.

 If either the MIDI connection or the USB connection is not working properly, check the settings in button 5 "MIDI Route" (p.59) in the GLOBAL EDIT mode.

MIDI-Related Settings

Setting the MIDI channel

Use the button 5 “MIDI Global Ch” (p.59) and “MIDI Sub CC Ch” (p.59) in the GLOBAL EDIT mode to set the prologue’s MIDI channel.

TIP When synchronizing to an external MIDI device, refer to that device’s Owner’s manual.

Configuring the MIDI “LOCAL” setting when connected to an external MIDI sequencer or computer

The Echo Back setting of your external MIDI sequencer or computer system allows the MIDI notes and other messages being played by the prologue to be instantly passed along to any other MIDI equipment, including synthesizers, tone generators. However, this same Echo Back function can cause the prologue to double trigger: once when you play the note, and a second time as the external MIDI sequencer or computer system sends the note back to the prologue.

To prevent this from happening, you can simply disable the LOCAL connection between the prologue keyboard and the tone generating circuitry.

The LOCAL feature is accessed using button 3 “Local SW” (p.55) in the GLOBAL EDIT mode.

MIDI filter settings

Use these settings to configure whether program changes, control changes and pitch bend messages will be transmitted and received.

Refer to “Button 6 (GLOBAL 6)” (p.60) for these settings.

Synchronizing the arpeggiator playback

Use the “Clock Source” (p.59) setting on button 5 in GLOBAL EDIT mode to set whether the prologue will be the master (the device controlling the synchronization) or the slave (the device being controlled) when the arpeggiator is played.

TIP When synchronizing to an external MIDI device, refer to that device’s Owner’s manual.

Using the prologue as the master to slave external MIDI devices

Connect the MIDI OUT connector of the prologue to the MIDI IN connector on your external MIDI device(s).

In the GLOBAL EDIT mode, set the Clock Source of the prologue to “Internal”, and configure the external MIDI device to receive clock data via MIDI. The prologue will act as the master, and the tempo that is set using the TEMPO button on the prologue will be sent as MIDI timing clock data to operate the external MIDI device (sequencers, rhythm machines, and so on).

Slaving the prologue clock to an external MIDI device

Connect the MIDI IN connector of the prologue to the MIDI OUT connector on your external MIDI device.

In the GLOBAL EDIT mode, set the Clock Source of the prologue to “Auto (MIDI)”, and configure the external MIDI device to transmit MIDI clock data.

The prologue will automatically act as the slave whenever a MIDI timing clock is received, and will be driven by the tempo of the external MIDI device (sequencers, rhythm machines, and so on).

TIP Even if you set the Clock Source to “Auto (USB)” or “Auto (MIDI)”, the prologue will operate in “Internal” MIDI clock mode, unless a clock is received from an external device.

Data list

Effects list

EFFECT TYPE	SUB TYPE	
MOD		
Chorus	Stereo	A stereo chorus effect that varies the input signal to create a thicker or warmer sound.
	Light	A chorus effect with lighter modulation than the stereo type.
	Deep	A chorus effect with heavier modulation than the stereo type.
	Triphase	An effect with three choruses, each with different LFO phases.
	Harmonic	A chorus with slightly emphasized overtones.
	Mono	A monaural chorus.
	Feedback	A chorus that uses feedback to create an effect similar to a short delay.
	Vibrato	Produces a vibrato (wavering) effect.
Ensemble	Stereo	An LFO-driven effect with an intricate wavering sound. Produces a spatially deep and expansive ensemble effect.
	Light	An ensemble effect with lighter vibrato than the stereo type.
	Mono	A monaural ensemble effect.
Phaser	Stereo	Alters the phase of the sound to give the sound a swelling effect.
	Fast	A phaser effect that swells faster than the stereo type.
	Orange	An effect that models a popular analog phaser in an orange box.
	Small	An effect that models the classic New York phaser sound from the 1970s.
	Small Reso	A small-type phaser sound with strong peak components.
	Black	An effect modeled after the phaser sounds from Denmark with a wide dynamic range.
	Formant	A phaser derived from the sound of the human voice.
	Twinkle	A phaser that creates a twinkling (sparkly) sound.
Flanger	Stereo	An effect that creates a thick swelling sound and a sense of motion in pitch.
	Light	A flanger with a thinner effect than the stereo type.
	Mono	A monaural flanger.
	High Sweep	A flanger that sweeps through the high-frequency bands.
	Mid Sweep	A flanger that sweeps through the mid-frequency bands.
	Pan Sweep	A flanger that pans from left to right.
	Mono Sweep	A monaural sweeping flanger.
	Triphase	A flanger featuring the effect of three LFOs.
(USER)	This effect is not installed at factory-set default, so it cannot be selected. Upload a user effect in order to select. See the “prologue user contents guide” (www.korg.com) for details.	

EFFECT TYPE	SUB TYPE	
DELAY/REVERB		
Delay	Stereo	A stereo delay with an expansive left-right field.
	Mono	A straight monaural delay.
	Ping Pong	A ping-pong delay that bounces back and forth from left to right.
	Hi Pass	A delay with a high-pass filter on which the low frequency band fades out.
	Tape	Simulates a tape echo.
	One Tap	A delay without feedback, on which the delay sounds only once.
	Stereo BPM	A stereo delay on which the delay time is synced to the TEMPO button settings.
	Mono BPM	A monaural delay on which the delay time is synced to the TEMPO button settings.
	Ping BPM	A ping-pong delay on which the delay time is synced to the TEMPO button settings.
	Hi Pass BPM	A high-pass delay on which the delay time is synced to the TEMPO button settings.
	Tape BPM	A tape echo on which the delay time is synced to the TEMPO button settings.
	Doubling	A short delay with a doubling effect.
Reverb	Hall	A hall-type reverb that simulates the reverberations of a midsize concert hall or ensemble hall.
	Smooth	A clear reverb with a sustaining high end.
	Arena	A reverb that evokes the feeling of a spacious area like a stadium.
	Plate	A warm-sounding (wet) plate reverb.
	Room	A reverb that simulates the reverberations of a small room.
	Early Ref	A reverb that emphasizes the brighter initial reflections than the lingering echoes.
	Space	An unstable reverb reminiscent of being in space.
	Riser	A shimmering reverb that echoes one octave higher.
	Submarine	A deep reverb that echoes one octave lower.
	Horror	A reverb with a highly unstable tonal quality.

Program List

No	Program Name	Category	Timbre Type	Author
1	Runner Brass	POLY SYNTH	-	John Bowen
2	June Pad	PAD/STRINGS	-	Luke Edwards
3	In My Dream	COMBINATION	LAYER	Kazuto Okawa / LLLL
4	Solid Bass	BASS	-	Ian Bradshaw
5	Selfosc Lead	LEAD	-	Kazuto Okawa / LLLL
6	Opal Mine	POLY SYNTH	-	Tim Mantle
7	ReeceFlux	BASS	-	Francis Preve
8	Sherbet	CHORD	LAYER	KORG Inc.
9	Raid Rush	ARP	-	KORG Inc.
10	Sparkle	KEY/BELL	-	Luke Edwards
11	Poly Spread	POLY SYNTH	-	KORG Inc.
12	Harp-like	ARP	-	John Bowen
13	Poly Sync	POLY SYNTH	-	KORG Inc.
14	Cinematica	PAD/STRINGS	-	Francis Preve
15	Vertigo	SFX	LAYER	Tim Mantle
16	Frantasia	KEY/BELL	-	Francis Preve
17	Warm Circuit	PAD/STRINGS	LAYER	Kazuto Okawa / LLLL
18	Fat Bass	BASS	-	KORG Inc.
19	NeuModulator	POLY SYNTH	-	KORG Inc.
20	Too the Deep	SFX	-	Tim Mantle
21	Stab Saw	POLY SYNTH	-	KORG Inc.
22	Phasepad	POLY SYNTH	-	Francis Preve
23	Bright Poly	POLY SYNTH	-	Francis Preve
24	Marina	POLY SYNTH	-	Francis Preve
25	Anthem Synth	POLY SYNTH	-	KORG Inc.
26	2 Saw Oktave	POLY SYNTH	-	Henning Verlage
27	Mover	POLY SYNTH	-	Henning Verlage
28	Triple Saw	POLY SYNTH	-	James Sajeva & Nick Kwas
29	Prologue	POLY SYNTH	-	Henning Verlage
30	1973	POLY SYNTH	-	James Sajeva & Nick Kwas
31	TriSync	POLY SYNTH	-	John Bowen
32	Stella	POLY SYNTH	LAYER	Tim Mantle
33	Simple Saw	POLY SYNTH	-	Francis Preve
34	Simple Sqr	POLY SYNTH	-	Francis Preve
35	Profetique	POLY SYNTH	-	KORG Inc.
36	Electro Funk	POLY SYNTH	-	KORG Inc.
37	Detune Comp	POLY SYNTH	-	Henning Verlage
38	Krelus	POLY SYNTH	-	John Bowen
39	Soft Brass	POLY SYNTH	-	KORG Inc.
40	O-Bee Brass	POLY SYNTH	-	KORG Inc.
41	Proolly 800	POLY SYNTH	-	James Sajeva & Nick Kwas
42	HUGE Score!	POLY SYNTH	-	James Sajeva & Nick Kwas
43	Yacht Rock	POLY SYNTH	LAYER	James Sajeva & Nick Kwas
44	Synth Brass	POLY SYNTH	-	John Bowen
45	Cork	POLY SYNTH	-	John Bowen
46	Destiny	POLY SYNTH	-	Tim Mantle
47	Star Connect	POLY SYNTH	-	KORG Inc.
48	Sunset Synth	POLY SYNTH	-	KORG Inc.
49	Pole 2 pole	POLY SYNTH	-	Tim Mantle
50	Haunted	POLY SYNTH	-	Francis Preve

No	Program Name	Category	Timbre Type	Author
51	Steaming Pod	POLY SYNTH	-	KORG Inc.
52	Smooth 5th	POLY SYNTH	-	Henning Verlage
53	D51	POLY SYNTH	-	Luke Edwards
54	Code Snipper	POLY SYNTH	-	KORG Inc.
55	Mod Me Sigma	POLY SYNTH	LAYER	Kazuto Okawa / LLLL
56	Sine Pad	PAD/STRINGS	-	John Bowen
57	Gentle Pad	PAD/STRINGS	-	James Sajeve & Nick Kwas
58	Winters Tale	PAD/STRINGS	-	Tim Mantle
59	Noise Ping	PAD/STRINGS	-	Francis Preve
60	Logue Pad	PAD/STRINGS	-	KORG Inc.
61	Palmer's Gone	PAD/STRINGS	-	Tim Mantle
62	Big Rise	PAD/STRINGS	-	Henning Verlage
63	Pulse Pad	PAD/STRINGS	-	Henning Verlage
64	SoftPadVCFMd	PAD/STRINGS	-	Luke Edwards
65	Pad Close	PAD/STRINGS	-	KORG Inc.
66	Lush Pad	PAD/STRINGS	-	Henning Verlage
67	Pad Brass	PAD/STRINGS	-	John Bowen
68	Perseus	PAD/STRINGS	-	John Bowen
69	Chillipad	PAD/STRINGS	-	Francis Preve
70	Pipin'Hot	PAD/STRINGS	LAYER	James Sajeve & Nick Kwas
71	Enormous Pad	PAD/STRINGS	-	Francis Preve
72	PWM Strings	PAD/STRINGS	-	KORG Inc.
73	Pad Open	PAD/STRINGS	-	KORG Inc.
74	Warm Strings	PAD/STRINGS	-	Henning Verlage
75	Humana	PAD/STRINGS	-	Francis Preve
76	Archestra	PAD/STRINGS	-	Francis Preve
77	June Morning	PAD/STRINGS	-	KORG Inc.
78	SolarStrings	PAD/STRINGS	-	KORG Inc.
79	Out There	PAD/STRINGS	-	Francis Preve
80	UncleaNuclea	PAD/STRINGS	-	KORG Inc.
81	Blurry Flute	PAD/STRINGS	-	Henning Verlage
82	Awaken Pad	PAD/STRINGS	-	KORG Inc.
83	Moving Pad	PAD/STRINGS	-	Henning Verlage
84	Angelique	PAD/STRINGS	-	Francis Preve
85	VPM Sweeper	PAD/STRINGS	-	KORG Inc.
86	Dark Ocean	PAD/STRINGS	LAYER	Kazuto Okawa / LLLL
87	Ghosts Choir	PAD/STRINGS	-	KORG Inc.
88	Vocoder Pad	PAD/STRINGS	LAYER	KORG Inc.
89	Air Vox	PAD/STRINGS	-	KORG Inc.
90	Big Sweep	PAD/STRINGS	-	Henning Verlage
91	Bright Idea	PAD/STRINGS	-	Tim Mantle
92	Nomad Riser	PAD/STRINGS	LAYER	Tim Mantle
93	Rusty Sword	PAD/STRINGS	-	KORG Inc.
94	Organique	KEY/BELL	-	KORG Inc.
95	60's Organ	KEY/BELL	-	Henning Verlage
96	Basic Organ	KEY/BELL	-	Francis Preve
97	Tonewheel	KEY/BELL	-	Francis Preve
98	Perc Saws	KEY/BELL	-	John Bowen
99	Analog Clav	KEY/BELL	-	Henning Verlage
100	Synth Clav	KEY/BELL	-	KORG Inc.

No	Program Name	Category	Timbre Type	Author
101	EP logue	KEY/BELL	-	KORG Inc.
102	Synth Piano	KEY/BELL	-	KORG Inc.
103	Snow Piano	KEY/BELL	-	KORG Inc.
104	VPM Pad EP 1	KEY/BELL	-	KORG Inc.
105	VPM Pad EP 2	KEY/BELL	LAYER	KORG Inc.
106	Cave Echo	KEY/BELL	-	Francis Preve
107	Gentle Ocean	KEY/BELL	-	Kazuto Okawa / LLLL
108	Droplets	KEY/BELL	-	Tim Mantle
109	Pop Bell	KEY/BELL	-	John Bowen
110	Glasskey	KEY/BELL	-	KORG Inc.
111	Warm Bells	KEY/BELL	-	Henning Verlage
112	Sanctuary	KEY/BELL	-	Francis Preve
113	LALA Pad	KEY/BELL	-	Francis Preve
114	Icicycles	KEY/BELL	-	John Bowen
115	Dorf Town	KEY/BELL	-	John Bowen
116	The Chapel	KEY/BELL	-	Tim Mantle
117	Box O' Trix	KEY/BELL	-	Tim Mantle
118	Metal-like	KEY/BELL	-	John Bowen
119	Steely Drum	KEY/BELL	-	John Bowen
120	Megaorganic	KEY/BELL	-	James Sajeva & Nick Kwas
121	Carillon	KEY/BELL	-	Francis Preve
122	Metabell	KEY/BELL	-	Francis Preve
123	Short Hop	KEY/BELL	-	KORG Inc.
124	Lead Attack	KEY/BELL	-	Henning Verlage
125	Vel Pluck	KEY/BELL	-	Henning Verlage
126	Pizzverb	KEY/BELL	-	KORG Inc.
127	Majesty	KEY/BELL	LAYER	Tim Mantle
128	Harp	KEY/BELL	-	KORG Inc.
129	Mod Me Snow	KEY/BELL	-	Kazuto Okawa / LLLL
130	Future Shape	KEY/BELL	-	Kazuto Okawa / LLLL
131	Datrap Sub	BASS	-	James Sajeva & Nick Kwas
132	Kickin'Bass	BASS	-	KORG Inc.
133	Kickbass	BASS	-	KORG Inc.
134	Double Vase	BASS	LAYER	Tim Mantle
135	Perc Bass	BASS	-	John Bowen
136	Simple Bass	BASS	-	John Bowen
137	House Bass	BASS	-	KORG Inc.
138	KameleonBass	BASS	-	John Bowen
139	Squelch Bass	BASS	-	James Sajeva & Nick Kwas
140	Bassline	BASS	-	Henning Verlage
141	Drive Acid	BASS	-	KORG Inc.
142	Squ Rez Bass	BASS	-	KORG Inc.
143	80sWireBass	BASS	-	Henning Verlage
144	M.G.B.	BASS	-	KORG Inc.
145	Glide Bass	BASS	-	KORG Inc.
146	Organ Bass	BASS	-	Henning Verlage
147	Bottom Bass	BASS	-	KORG Inc.
148	Chunky Bass	BASS	-	John Bowen
149	Synwave Bass	BASS	-	Francis Preve
150	Reso Bass	BASS	-	Henning Verlage

No	Program Name	Category	Timbre Type	Author
151	Trusted Guy	BASS	-	KORG Inc.
152	BigFatAnalog	BASS	-	Henning Verlage
153	FunctionBass	BASS	-	Ian Bradshaw
154	Sink Tank	BASS	-	Kazuto Okawa / LLLL
155	Bass Stab	BASS	-	Kazuto Okawa / LLLL
156	Decode Soil	BASS	-	Kazuto Okawa / LLLL
157	Dawndrezz	BASS	-	Francis Preve
158	Bass/Lead	BASS	-	Henning Verlage
159	Buzz Freq	BASS	-	Kazuto Okawa / LLLL
160	King Hive	BASS	XFADE	Kazuto Okawa / LLLL
161	PhatSaw Bass	BASS	-	KORG Inc.
162	Surge Bass	BASS	-	KORG Inc.
163	Light Blast	BASS	-	Kazuto Okawa / LLLL
164	Mumblebass	BASS	-	KORG Inc.
165	Acidwheel	BASS	-	Francis Preve
166	Arp StufpH	BASS	-	KORG Inc.
167	Metal Power	BASS	-	Kazuto Okawa / LLLL
168	Mooncontact	LEAD	-	KORG Inc.
169	Dark Lead	LEAD	-	KORG Inc.
170	70s SynLead	LEAD	-	KORG Inc.
171	Perc Lead	LEAD	-	John Bowen
172	Chip Lead	LEAD	-	KORG Inc.
173	Vintage Horn	LEAD	-	Francis Preve
174	Classic Lead	LEAD	-	Henning Verlage
175	Sync Lead	LEAD	-	KORG Inc.
176	SYNC!!	LEAD	-	KORG Inc.
177	CurryFlavour	LEAD	-	Francis Preve
178	Growl	LEAD	-	KORG Inc.
179	Firearm SFX	LEAD	-	Kazuto Okawa / LLLL
180	Sunday Lead	LEAD	-	Henning Verlage
181	Waking Beast	LEAD	-	Kazuto Okawa / LLLL
182	DriveMetalLd	LEAD	-	KORG Inc.
183	Octave Lead	LEAD	-	KORG Inc.
184	Flangie Lead	LEAD	-	KORG Inc.
185	Disco Lead	LEAD	-	KORG Inc.
186	Detune Lead	LEAD	-	KORG Inc.
187	Dream Lead	LEAD	LAYER	Henning Verlage
188	Oh Yeah!	LEAD	-	Luke Edwards
189	Weekend Hymn	LEAD	-	Henning Verlage
190	MicroK Lead	LEAD	-	Luke Edwards
191	VCF Lead	LEAD	-	KORG Inc.
192	Octave Dive	LEAD	-	John Bowen
193	Modern Luck	LEAD	-	Francis Preve
194	Phatpluk	LEAD	-	Francis Preve
195	Dirty Pluck	LEAD	-	Henning Verlage
196	FerrousStab	LEAD	-	KORG Inc.
197	Spooky Sound	LEAD	-	Kazuto Okawa / LLLL
198	Prayer Lead	LEAD	-	Ian Bradshaw
199	Marzcontact	LEAD	-	KORG Inc.
200	#modular	LEAD	-	Francis Preve

No	Program Name	Category	Timbre Type	Author
201	Manoeuvres	LEAD	-	Francis Preve
202	Voice Lead	LEAD	-	KORG Inc.
203	Wave Ride	LEAD	-	Kazuto Okawa / LLLL
204	PhaseShifter	LEAD	-	Francis Preve
205	Big Five	LEAD	-	Francis Preve
206	5 Lead	LEAD	-	KORG Inc.
207	Stabby House	CHORD	-	James Sajeve & Nick Kwas
208	House Chord	CHORD	-	Henning Verlage
209	8track House	CHORD	XFADE	Tim Mantle
210	Wire Code	CHORD	-	Luke Edwards
211	Metal Zing	CHORD	-	Luke Edwards
212	Resurgence	CHORD	-	Tim Mantle
213	Strobe Night	CHORD	-	Tim Mantle
214	Flashin' Vox	CHORD	-	KORG Inc.
215	Repeat Chord	CHORD	LAYER	KORG Inc.
216	Skeletonblue	CHORD	-	KORG Inc.
217	Sign Times	ARP	-	KORG Inc.
218	Soft Arppad	ARP	-	Henning Verlage
219	Stairway	ARP	-	Francis Preve
220	Exciter	ARP	-	Tim Mantle
221	Hangry Hound	ARP	-	Francis Preve
222	Arpsteroids	ARP	-	James Sajeve & Nick Kwas
223	Barp	ARP	-	James Sajeve & Nick Kwas
224	Space Arp	ARP	-	Henning Verlage
225	Gear Goggles	ARP	-	Luke Edwards
226	Mean Deal	ARP	-	Tim Mantle
227	New Birth	ARP	LAYER	Tim Mantle
228	Arp + Pad	COMBINATION	LAYER	KORG Inc.
229	Specter	COMBINATION	LAYER	Henning Verlage
230	Dedspce(hld)	COMBINATION	LAYER	James Sajeve & Nick Kwas
231	Forlorn	COMBINATION	LAYER	John Bowen
232	Night Drive	COMBINATION	SPLIT	Kazuto Okawa / LLLL
233	Runner Blade	COMBINATION	SPLIT	John Bowen
234	Epiphany	COMBINATION	SPLIT	KORG Inc.
235	Sci-bi	COMBINATION	SPLIT	Tim Mantle
236	Plucky Split	COMBINATION	SPLIT	KORG Inc.
237	Old Scores	COMBINATION	SPLIT	Tim Mantle
238	Winter Wind	SFX	-	Kazuto Okawa / LLLL
239	Explosion	SFX	LAYER	KORG Inc.
240	Fly-by	SFX	LAYER	Tim Mantle
241	Blown Charge	SFX	LAYER	Tim Mantle
242	Sci-Fi Sweep	SFX	-	KORG Inc.
243	Horror Morph	SFX	LAYER	Tim Mantle
244	Dome Horn	SFX	-	Kazuto Okawa / LLLL
245	TH Ex	SFX	LAYER	Luke Edwards
246	ShootingStar	SFX	-	KORG Inc.
247	EnergyCharge	SFX	-	KORG Inc.
248	Doncamatic	SFX	SPLIT	KORG Inc.
249	Analog Tom	SFX	-	Francis Preve
250	tEcHpLuNk	SFX	-	James Sajeve & Nick Kwas

No	Program Name	Category	Timbre Type	Author
251 : 500	(Init Program)			

All Programs were made by Francis Preve, Henning Verlage, Ian Bradshaw, James Sajeve & Nick Kwas, John Bowen, Kazuto Okawa, Luke Edwards, Tim Mantle, KORC Inc.

For more information about the authors please visit:

Francis Preve	http://www.francispreve.com/
Henning Verlage	https://www.facebook.com/henningverlage
John Bowen	http://www.johnbowen.com/
Kazuto Okawa / LLLL	https://www.facebook.com/lllltokyo/
Tim Mantle	http://www.timmantle.com/

Specifications

Keyboard	prologue-16: 61 keys (natural touch keyboard, velocity sensitive) prologue-8: 49 keys (natural touch keyboard, velocity sensitive)
Sound generator	Analog sound generator + Multi digital sound generator
Maximum Polyphony	prologue-16: 16 voices prologue-8: 8 voices
Programs	500 (250 preset programs and 250 user programs as the factory-set default) Each program includes Voice mode and timbre settings. Features program sort and live set functions.
Voice modes	4 (POLY, MONO, UNISON, CHORD) The VOICE MODE DEPTH knob can used to change parameters that differ for each mode.
Timbres	Max. of 2 timbres (main timbre, sub-timbre) Layer, crossfade and split settings can be made.
Arpeggiator	6 types (Manual, Rise, Fall, Rise Fall, Random, Poly Random) Tempo and sound range can be changed.
Sound generating system	2 VCO (square wave, triangle wave, sawtooth wave), MULTI ENGINE (noise generator, VPM oscillator, user oscillator), 1 VCF, 2 EG, 1 LFO, 1 VCA
Effects	Mod Effects (Chorus, Ensemble, Phaser, Flanger, User), Delay/Reverb, L.F. COMP. (only on prologue-16)
Display	Main: Organic EL (electro-luminescence) display with oscilloscope function MULTI ENGINE section: 7-segment LED, 6 characters x 1 line
Input/output jacks	Headphones jack (ø6.3mm stereo phone jack) OUTPUT L/MONO and R jacks (ø6.3mm stereo phone jack, TS unbalanced) SYNC IN jack (ø3.5 mm stereo mini-phone jack, 20V maximum input level) SYNC OUT jack (ø3.5 mm stereo mini-phone jack, 5V output level) MIDI IN connector MIDI OUT connector USB B connector EXPRESSION jack DAMPER jack (half-damper not supported)
Power	AC Power Supply terminal
Power consumption	prologue-16: 38 W prologue-8: 23 W

Dimensions (W x D x H)	prologue-16: 874 × 348 × 118 mm / 34.41 × 13.70 × 4.65 inches prologue-8: 709 × 348 × 118 mm / 27.91 × 13.70 × 4.65 inches
Weight	prologue-16: 9.1 kg / 20.05 lbs. prologue-8: 7.5 kg / 16.53 lbs.
Included items	Power cord Quick Start Guide
Options	DS-1H damper pedal PS-1 pedal switch PS-3 pedal switch XVP-20 volume/expression pedal XVP-10 expression/volume pedal EXP-2 foot controller

- * Specifications and appearance are subject to change without notice for improvement.
- * Since the side panels of this instrument uses natural wood, there will be individual differences in the wood grain, surface texture and color.
- * All product names and company names are the trademarks or registered trademarks of their respective owners.

MIDI Implementation Chart

Function...		Transmitted	Recognized	Remarks
Basic Channel	Default Change	1-16 1-16	1-16 1-16	Memorized
Mode	Default Messages Altered	X X *****	3 X	
Note Number	True Voice	0-127 *****	0-127 0-127	
Velocity	Note On Note Off	O 9n, V=1-127 X 8n, V=64	O 9n, V=1-127 X	
After Touch	Key's Channel	X X	X X	
Pitch Bend		O	O	*1
Control Change	0, 32	O	O	BANK SELECT(MSB, LSB) *2
	85, 86, 8	O	O	TIMBRE EDIT/TYPE/BALANCE *2
	5	O	O	PORTAMENTO *2
	14, 27	O	O	VOICE SPREAD/VOICE MODE DEPTH *2
	50, 48, 34, 36	O	O	VCO1 WAVE/OCTAVE/PITCH/SHAPE *2
	51, 49, 35, 37	O	O	VCO2 WAVE/OCTAVE/PITCH/SHAPE *2
	53, 52, 54	O	O	MULTI TYPE/OCTAVE/SHAPE *2
	39, 40, 33	O	O	MIXER VCO1/VCO2/MULTI *2
	43, 44, 45	O	O	CUTOFF/RESONANCE/EG-INT *2
	84, 82, 83	O	O	CUTOFF DRIVE/LOWCUT/KEYTRACK *2
	16, 17, 18, 19	O	O	AMP-EG A/D/S/R *2
	20, 21, 22, 23	O	O	EG A/D/S/R *2
	57, 58, 24	O	O	LFO WAVE/MODE/RATE *2
	26, 56	O	O	LFO INT/TARGET *2
	88, 28, 29	O	O	MOD FX TYPE/SPEED/DEPTH *2
89, 30, 31	O	O	DELAY REVERB TYPE/TIME/DEPTH *2	
81, 42	O	O	PITCH EG/PITCH EG INT *2	
80, 41	O	O	RING-SYNC/CROSS MOD DEPTH *2	
92, 94	O	O	MOD FX ON-OFF/DELAY REVERB ON-OFF *2	
64	O	O	Damper *2	
120, 121	O	O	All sound off, Reset all Controllers *2	
Program Change	True Number	O 0-99 *****	O 0-99 0-99	*3
System Exclusive		O	O	
System Common	Song Position Song Select Tune Request	X X X	X X X	
System Real Time	Clock Commands	O O	O O	*4
Aux Meassages	Local On/Off All Notes Off Active Sense System Reset	X X O X	O O O X	
Notes *1: When the Global setting is "MIDI Rx Pitch Bend=On", the prologue will receive signals; and when the Global setting is "MIDI Tx Pitch Bend=On", the prologue will transmit signals. *2: When the Global setting is "MIDI Rx CC=ON", the prologue will receive signals; and the when Global setting is "MIDI Tx CC=On", the prologue will transmit signals. *3: When the Global setting is "MIDI Rx Pirog Chg=ON", the prologue will receive signals; and when the Global setting is "MIDI Tx Prog Chg=On", the prologue will transmit signals. *4: When the Global setting is "Clock Source=Internal", the prologue will not receive signals. The prologue will receive signals when set to "Auto (MIDI)" or "Auto (USB)".				

Mode 1: Omni On, Poly
 Mode 3: Omni Off, Poly

Mode 2: Omni On, Mono
 Mode 4: Omni Off, Mono

O: Yes
 X: No

Consult your local Korg distributor for more information on MIDI implementation.

KORG INC.

4015-2 Yanokuchi, Inagi-City, Tokyo 206-0812 JAPAN
© 2017 KORG INC.

www.korg.com
Published 6/2018