

WORK

Pa4X | User Manual

ENGLISH | OS Version 2.0 | MAN0010102

E 13

Important safety instructions

- Read these instructions.
 - Keep these instructions.
 - Heed all warnings.
 - Follow all instructions.
 - Do not use this apparatus near water.
 - Clean only with dry cloth.
 - Do not block any ventilation openings. Install in accordance with the manufacturer's instructions.
 - Do not install near any heat sources such as radiators, heat registers, stoves, or other apparatus (including amplifiers) that produce heat.
 - No naked flame sources, such as lighted candles, should be placed on the apparatus.
 - Do not defeat the safety purpose of the polarized or grounding-type plug. A polarized plug has two blades with one wider than the other. A grounding type plug has two blades and a third grounding prong. The wide blade or the third prong are provided for your safety. If the provided plug does not fit into your outlet, consult an electrician for replacement of the obsolete outlet.
 - Protect the power cord from being walked on or pinched particularly at plugs, convenience receptacles, and the point where they exit from the apparatus.
 - Only use attachments/accessories specified by the manufacturer.
 - Use only with the cart, stand, tripod, bracket, or table specified by the manufacturer, or sold with the apparatus. When a cart is used, use caution when moving the cart/apparatus combination to avoid injury from tip-over.
 - Unplug this apparatus during lightning storms or when unused for long periods of time.
 - Refer all servicing to qualified service personnel. Servicing is required when the apparatus has been damaged in any way, such as power-supply cord or plug is damaged, liquid has been spilled or objects have fallen into the apparatus, the apparatus has been exposed to rain or moisture, does not operate normally, or has been dropped.
 - **WARNING** - This apparatus shall be connected to a mains socket outlet with a protective earthing connection.
 - Turning off the standby switch does not completely isolate this product from the power line, so remove the plug from the socket if not using it for extended periods of time, or before cleaning. Please ensure that the mains plug or appliance couple remains readily accessible.
 - Mains powered apparatus shall not be exposed to dripping or splashing and that no objects filled with liquids, such as vases, shall be placed on the apparatus.
 - Install this product near the wall socket and keep the power plug easily accessible.
 - Do not install this equipment in a confined space such as a box for the conveyance or similar unit.
- CAUTION** - Pa4X is for use only with KORG ST-SV1-BK stand. Use with other stands is capable of resulting in instability causing possible injury.
- ATTENTION** - Le Pa4X est conçu pour être utilisé avec le support KORG ST-SV1-BK. L'utilisation avec d'autres supports peut causer une déstabilisation du Pa4X et provoquer des blessures.





WARNING - Do not ingest battery, chemical burn hazard. This product contains a coin/button cell battery.

If the coin/button cell battery is swallowed it can cause severe internal burns in just 2 hours and can lead to death.

Keep new and used batteries away from children. If the battery compartment does not close securely, stop using the product and keep it away from children.

If you think the battery may have been swallowed or placed inside any part of the body seek immediate medical attention.

- **WARNING** - Date/time Lithium button cell battery inside. Danger of explosion if the battery is incorrectly replaced. Replace only with the same or equivalent type. The internal date/time Lithium button cell battery is user replaceable.
- Do not expose batteries to excessive heat, such as direct sunshine, fire or the like.
- Dispose of used batteries according to the battery manufacturer's instructions.

WARNING:

TO REDUCE THE RISK OF FIRE OR ELECTRIC SHOCK DO NOT EXPOSE THIS PRODUCT TO RAIN OR MOISTURE.



The lightning flash with arrowhead symbol within an equilateral triangle, is intended to alert the user to the presence of uninsulated "dangerous voltage" within the product's enclosure that may be of sufficient magnitude to constitute a risk of electric shock to persons.



The exclamation point within an equilateral triangle is intended to alert the user to the presence of important operating and maintenance (servicing) instructions in the literature accompanying the product.

Other notices

Automatic power-off

To avoid wasting power, Pa4X will by default automatically enter standby mode after two hours of non-active use (playing, pressing buttons or using the touch-screen). Please save your data (Keyboard Sets, Styles, Songs, and so on) before taking a prolonged pause.

Data handling

Data in memory may sometimes be lost due to incorrect user action. Be sure to save important data to the internal memory or to an external USB device. KORG will not be responsible for damages caused by data loss.

Display handling

Be very careful not to force the display when tilting it. Fully lower the display before carrying the instrument. Also, be very careful not to apply too much pressure on the display while carrying the instrument, or it might break.

Cleaning

If the exterior becomes dirty, wipe it with a clean, dry cloth. Do not use liquid cleaners such as benzene or thinner, or cleaning compounds or flammable polishes.

Use a soft cotton cloth to clean the display. Some materials, such as paper towels, could cause scratches and damage it. Computer wipes are also suggested, provided they are specifically designed for LCD screens.

Do not spray any liquid on the LCD screen directly. Always apply the solution to your cloth first, then clean the screen.

Example screens

Some pages of the manuals show snapshots of the screen along with an explanation of functions and operations. All sound, style, song or parameter names, as well as shown values, are merely examples and may not always match the actual display you are working on.

Trademarks

Acrobat and PDF are registered trademarks of Adobe Systems Incorporated. Mac and iOS are registered trademarks of Apple, Inc. Android is a trademark of Google Inc. MS-DOS and Windows are

registered trademarks of Microsoft Corporation. TC-Helicon is a registered trademark of TC-Helicon Vocal Technologies Ltd. MaxxAudio, MaxxEQ, MaxxBass, MaxxTreble, MaxxStereo, MaxxVolume are trademarks of Waves Audio Ltd. All other trademarks or registered trademarks are the property of their respective holders.

Open source notice

Portions of this product's software are copyright ©2007 "The FreeType Project" (www.freetype.org). All rights reserved.

Disclaimer

The information contained in this manual have been carefully revised and checked through. Due to our constant efforts to improve our products, the specifications might differ to those in the manual. KORG is not responsible for any differences found between the specifications and the contents of the instruction manual - all specifications being subject to change without prior notice.

Liability

KORG products are manufactured under strict specifications and voltages required by each country. These products are warranted by the KORG distributor only in each country. Any KORG product not sold with a warranty card or carrying a serial number disqualifies the product sold from the manufacturer's/distributor's warranty and liability. This requirement is for your own protection and safety.

Service and user's assistance

For service, please contact your nearest Authorized KORG Service Center. For more information on KORG products, and to find software and accessories for your keyboard, please contact your local Authorized KORG distributor. For up-to-date information, please point your web browser to our [web site](#).

Keep your keyboard up-to-date

Your instrument can be constantly updated as new versions of the operating system are released by KORG. You can download the operating system from our [web site](#). Please, read the instructions supplied with the operating system.

Copyright © 2017 KORG Italy SpA

Contents

Part I	1	Let's start!
	3	Introduction
	3	Welcome to Pa4X!
	7	Before starting to play...
	9	Overview of the instrument
	16	Setting up the pedals and audio connections
	16	Connecting the pedals
	17	Connecting the EC5 multiswitch
	17	Connecting the headphones
	17	Connecting the audio outputs
	18	Powering up
	18	Turning the instrument on
	19	Calibrating the touch screen
	20	Adjust the display brightness
	20	Tilting the display
	21	Listening to the Demo Songs
	22	Interface basics
	22	The main page
	23	The user interface in detail
	31	Navigating through the pages
	34	Selecting the musical resources
Part II	35	Playing and singing
	37	Playing the Sounds
	37	Choosing your preferred set of Sounds
	39	Choosing the Keyboard Sets
	45	Playing and controlling the Sounds
	47	Tempo and Metronome
	47	Tempo
	49	Metronome
	51	Playing the Styles
	51	Choosing the Styles
	57	Playing a manual accompaniment (Bass & Lower Backing)
	58	Playing the automatic accompaniment
	64	Adjusting the accompaniment volume
	66	Manually playing the Bass line
	67	Playing the Pads
	67	Choosing the Pad sets
	68	Playing the Pads

69	Playing the Songs
69	Choosing the Songs
74	Playing a Song
76	Mixing two Songs
78	Playing along with the Song
80	Adjusting the volume levels
81	Playing all the Songs in a folder
83	Playing a Jukebox list
86	Lyrics, chords, markers and score
86	Choosing one of the Players
87	Reading the lyrics and chords contained in a Song
89	Reading the lyrics and chords loaded as a text file
91	Reading the lyrics and chords loaded as a CDG file
92	Moving through a Song with the markers
95	Reading the music score
99	Searching for files and other items
99	Using the Search function

Part III **105 SongBook**

107	Using the SongBook
107	Choosing the SongBook Entries
116	Using the Set Lists
120	Editing the SongBook
120	Creating and editing the SongBook Entries
130	Creating and editing the Set Lists
134	Deleting all the SongBook Entries and Set Lists
135	Using the SongBook with a personal computer

Part IV **137 Customizing and editing the Sound sets**

139	Customizing the Keyboard Sets
139	Playing different Sounds with the left and right hand
143	Playing two or three Sounds at the same time
144	Choosing different Sounds
146	Mixing the Keyboard Sounds
149	Transposing the Upper Sounds to a different octave
150	Using the Ensemble to add harmony
153	Advanced editing of the Sound sets
153	The editing procedure
156	Mixing the Sounds
158	Adding effects
169	Equalizing the Sounds
172	Octave transpose and fine tuning
173	Programming the sound routing and polyphony
176	Quick editing of Drum Kits

- 179 Quick editing of Sounds
- 181 Programming the key and velocity range
- 182 Editing the Digital Drawbars
- 186 Writing the Sound sets**
- 186 Writing the Keyboard Sets to the library
- 188 Writing Keyboard Sets into a Style
- 190 Writing Keyboard Sets into a SongBook Entry
- 193 Writing Style Settings, Song Settings and MIDI Song Sounds

Part V

195 Customizing, recording and editing the Styles and Pads

- 197 Customizing the Styles**
- 197 Setting the Chord Recognition
- 201 Automatically holding chords and Lower notes (Memory)
- 203 Recognizing the root note (Bass Inversion)
- 204 Setting how velocity controls the accompaniment
- 205 Mixing the grouped Accompaniment Sounds
- 207 Editing the Style Settings**
- 207 Mixing the individual Accompaniment Sounds
- 211 Changing the Sounds of the accompaniment parts
- 214 Setting the Style controls
- 219 Choosing and mixing the Pads
- 222 Writing the Style Settings**
- 222 Writing the Style Settings
- 224 The Chord Sequencer**
- 224 Recording Chord Sequences
- 226 Playing back a Chord Sequence
- 227 Managing the Chord Sequences
- 230 Recording the Styles and Pads**
- 230 How are Styles and Pads made?
- 236 Programming the Style Settings, then recording the musical sequences
- 237 Accessing the Style/Pad Record mode
- 239 Listening to the recorded Style
- 240 Setting the recording parameters
- 245 Assigning Sounds to the Style Element and Pads
- 248 Choosing the original key/chord and the note transposition table
- 251 Recording a Style or Pad in Realtime Record
- 254 Recording a Style or Pad in Step Record
- 259 Recording a Guitar track
- 269 Editing the Styles and Pads**
- 269 Editing the track parameters
- 275 Editing the Chord Table
- 276 Checking the available Chord Variations
- 277 Editing the track type, trigger, tension
- 279 Editing the Style/Pad sequences

- 290 Editing the MIDI events
- 294 Copying the Style track settings
- 295 Importing and exporting the Styles and Pads**
- 295 Importing a Standard MIDI File to a Chord Variation
- 298 Importing a Standard MIDI File to a Style
- 301 Importing a MIDI Groove to a Style or Pad
- 302 Exporting a Chord Variation
- 304 Converting a MIDI Song to a Style**
- 304 The Style Creator Bot
- 306 Writing the new/edited Style or Pad**
- 306 Writing the Styles
- 308 Writing the Pads

Part VI

309 Customizing, recording and editing the Songs

- 311 Customizing the Songs**
- 311 How to play a Song - Song Play vs. Sequencer mode
- 312 Special tracks (Melody, Drum & Bass), Fast Play
- 314 Mixing the Song Sounds
- 318 Changing the Sounds of the MIDI Song tracks
- 319 Writing the Song Play Settings**
- 319 Writing the default Players' settings
- 320 Listening the MIDI Songs in Sequencer mode**
- 320 Loading and listening a MIDI Song
- 323 Recording MIDI Songs**
- 323 Multitrack Recording a Song
- 330 Step Recording a Song
- 335 Quick Recording a Backing Sequence Song
- 343 Step Recording a Backing Sequence Song
- 348 Editing the MIDI Songs**
- 348 Editing the Song tracks
- 359 Editing the MIDI events
- 363 Saving MIDI Songs**
- 363 Saving the MIDI Song
- 365 Recording MP3 Songs**
- 365 Recording and saving an MP3 Song
- 369 Creating text files (lyrics)**
- 369 Creating text files on a personal computer

Part VII

375 Customizing and editing the Sounds

- 377 Listening and customizing the Sounds**
- 377 Accessing the Sound mode
- 378 Listening to individual Sounds

- 379 Customizing the Sound
- 382 Editing the Sounds**
 - 384 Setting the Sound's basic parameters
 - 390 Setting the oscillator's basic parameters
 - 397 Programming the Damper pedal
 - 401 Equalizing the Sound
 - 402 Setting the Drum Kit's basic parameters
 - 406 Equalizing the Drum Kit
 - 408 Mixing the Drum Kit layers
 - 409 Mixing and retriggering the drum samples
 - 411 Modulating pitch
 - 416 Programming the pitch envelope (Pitch EG)
 - 420 Programming the filters
 - 423 Modulating the filters
 - 428 Programming the filter envelope (Filter EG)
 - 432 Programming amplitude and pan
 - 434 Modulating amplitude
 - 437 Programming the amplitude envelope (Amp EG)
 - 441 Programming the LFO
 - 446 Adding effects to the Sound
 - 449 Sound Edit utilities
 - 451 AMS (Alternate Modulation Sources)
- 454 Writing the Sounds**
 - 454 Writing the edited Sound
- 456 Making new sounds with Sampling**
 - 458 Loading samples and multisamples
 - 462 Recording samples or audio grooves
 - 464 Editing the samples
 - 468 Editing the loop
 - 471 Getting information on the Sampling memory
 - 473 Writing, exporting or deleting the samples
 - 477 Creating multisamples
 - 481 Writing, exporting or deleting the multisamples
 - 484 Creating new Sounds from multisamples
 - 485 Creating new Drum Kits from percussive samples
 - 486 Assigning the new Sound or Drum Kit to a part/track
 - 487 Creating Audio Groove Slices with Time Slicing
 - 493 Writing the Audio Groove Slices
 - 494 Using the Audio Groove Slices in a Style or Pad
 - 496 Using the Audio Groove Slices in other Sounds

Part VIII

- 497 Audio In/Out and the Voice Processor**
 - 499 Setting the audio outputs and the final effects
 - 499 Connecting the audio outputs
 - 500 Choosing the audio outputs for the microphone and line audio inputs

- 501 Sending Sounds and Drum Kits to the audio outputs
- 503 Choosing the audio outputs for the metronome click
- 504 Programming the MAXX mastering effects
- 510 Connecting the audio inputs**
- 510 Connecting a line audio device
- 512 Connecting a microphone
- 516 Shaping the sound of the lead voice
- 525 Talking with your audience**
- 527 Using the voice effects and harmonization**
- 527 Choosing a Voice Preset
- 530 Harmonizing your voice
- 532 Doubling your voice
- 533 Using the effects
- 534 Editing the Voice effects**
- 534 Choosing, enabling and balancing the effects
- 535 Mixing the lead voice and the effects
- 536 Editing the harmony voices
- 543 Editing the Double voice
- 544 Editing the Filter effect
- 546 Editing the Hard Tune effect
- 547 Editing the μ Mod effect
- 549 Editing the Delay effect
- 551 Editing the Reverb effect
- 553 Writing a Voice Preset

Part IX**555 Effects for the Sounds**

- 557 The effects**
- 557 Editing the effects
- 561 Adapting reverb to the room size
- 562 Effects list
- 564 Effect parameters**
- 564 REV (Reverbs)
- 575 DEL (Delay)
- 611 MOD (Modulation)
- 658 DYN (Dynamics)
- 670 AMP (Amplifier)
- 709 FILT (EQ and Filters)
- 738 FREQ (Frequency)
- 752 MISC (Miscellaneous)
- 797 DMS (Dynamic Modulation Sources)

Part X**799 KAOSS Effects**

- 801 Using the KAOSS effects**
- 801 The KAOSS page

- 803 Choosing the KAOSS Presets
- 805 KAOSS Preset list
- 808 Using the KAOSS effects

Part XI**811 Controllers****813 Hand controllers**

- 813 Programming the joystick
- 815 Programming the keyboard's velocity and aftertouch
- 817 Programming the ribbon controller
- 819 Programming the assignable sliders
- 822 Programming the assignable switches

825 Foot controllers

- 825 Programming the damper pedal
- 826 Programming the assignable pedal/footswitch
- 833 Calibrating the pedal and setting its polarity
- 835 Programming the EC5 multiswitch

Part XII**839 Global settings and preferences****841 Customizing the user interface**

- 841 Display and control panel preferences
- 843 Program Change and activity indicators

845 Automatic selection and locking

- 845 Automatically choosing Styles and Keyboard Sets
- 847 Locking parameters to prevent changes

851 System preferences

- 851 Setting the date and time for file saving
- 852 Automatic power off

853 Master Transpose and Tuning

- 853 Master Tuning
- 854 Master Transpose

859 Scale

- 859 Main Scale
- 861 Sub-Scale
- 865 Quarter Tone Sub-Scale (Scale Presets)
- 870 Retuning the Style while playing

Part XIII**873 MIDI****875 Connecting MIDI devices**

- 875 Introduction to MIDI
- 880 Connecting via the MIDI interface
- 881 Connecting via the USB DEVICE port
- 883 Quick settings using MIDI Presets
- 888 Synchronizing Tempo with other instruments
- 890 MIDI data routing, processing and transposing

- 896 Programming the MIDI channels
- 900 Connecting Pa4X to a personal computer or tablet
- 901 Control Change messages
- 904 Controlling the Arranger and Players via MIDI

Part XIV**907 File management**

- 909 Managing files in the internal memory**
- 909 Copying, renaming and deleting
- 911 The Direct Styles, Keyboard Sets, SongBook
- 915 Renaming the Favorite/User/Direct banks
- 916 Managing files**
- 916 Overview on file management
- 921 Loading musical resources and settings
- 927 Saving musical resources and settings
- 931 Copying files and folders
- 934 Deleting files and folders
- 935 Selecting more items at once
- 937 Exporting playlists
- 940 Managing media**
- 940 Formatting storage devices
- 942 Backing up and restoring musical resources
- 946 Connecting one of the internal drives to a personal computer
- 948 Storage device organization
- 951 Changing the media display preferences
- 952 Protecting storage devices and files
- 954 Care of storage devices

Part XV**955 Appendix**

- 957 Musical Resources**
- 958 Styles
- 967 Keyboard Set Library
- 975 Sounds
- 1005 DNC Sounds and controls
- 1010 Drum Kits
- 1013 Multisamples
- 1028 Drum Samples
- 1061 Pads
- 1066 Recognized chords**
- 1068 Connecting an external display**
- 1070 Installing the options**
- 1070 Assembling the amplification system (PaAS)
- 1076 Assembling the music stand
- 1078 Assembling the stand (ST-SV1 BK)
- 1084 Replacing the clock backup battery

- 1087 Installing a microSD card
- 1091 Installing an additional internal drive
- 1095 Shortcuts
- 1096 Troubleshooting
- 1098 Specs

PART I: LET'S START!

01 Introduction

Welcome to Pa4X!

Many thanks, and congratulation on purchasing the KORG Pa4X Professional Arranger! We're sure it'll give you countless hours of great tones that will feel as good as they sound.

Slim, powerful and easy to use

With the elegant aluminum cabinet, Pa4X provides a professional and stylish look, that will be much appreciated on stage or at home. The main panel's logical layout ensures easy access to sliders, buttons, knobs and all controls.

Using your Pa4X is easy, thanks to the touch screen and the clean, clearly laid-out, modern user interface, based on icons reproducing real objects in the real world. The tilting display will make access easy under any circumstances.

The real solo and band experience

Pa4X has been designed to assist you equally well during live performance and songwriting. The detailed natural sounds and finely crafted styles have been created by some of the finest musicians in the music industry. You will feel you are playing in a real band - no matter what your musical tastes are.

The naturally responsive 76- and 61-note semi-weighted keyboards are designed for musicians of all levels, from beginners to demanding keyboard players, and gives you a completely authentic feel and full control of expression.

More than just recorded sounds

The huge, realistic collection of classic and contemporary keyboard, band and orchestral sounds, includes two new multi-layer stereo grand pianos (with damper and body resonance) and new electric pianos; a new pipe organ, accordion and bandoneon; new wind instruments, basses and stunning acoustic and electric guitars; plus new digital drawbars with leakage and key on/off noises.

Sounds have been recorded with the most up-to-date technologies, and KORG's own proprietary EDS-X (Enhanced Definition Synthesis-eXpanded) sound engine allows for fine detail to be accurately reproduced. The integrated sampler and sound editor allows to fill the vast user memory with newly created or imported sounds.

All these authentic sounds become alive with KORG's DNC (Defined Nuance Control) system, allowing the performer to accurately and expressively introduce the most subtle nuances and sound articulation. For example, the joystick, ribbon controller and assignable switches can introduce the growl of a saxophone, breath elements found in trumpet, clarinet and harmonica, and add authenticity to the pizzicato and bowed sounds of a string section. You will even hear keys opening when saxophone notes are going up, and closing when going down!

Listen the natural way

Each Pa4X sound go through separate EQs and studio-quality effect processors, that further refine your sound before coming through high-quality stereo audio outputs. Effects run from the standard reverbs and delays through to the more unusual effects (like a Vocoder), realistic amp simulators and carefully recreated vintage effects.

The final effects are the result of KORG's long term cooperation with Waves Audio®, the world reference in studio mastering effects. The included Waves MAXX AUDIO suite of effects delivers sound that is louder, clearer, fuller, and more polished.

For super high-fidelity, you can add the optional PaAS Amplification System, that has been specifically designed to connect directly to the keyboard. Useful for both home use and on-stage monitoring, the PaAS requires no additional support, no cables, no power supply to deliver crisp, clean full range sound. The sound is clear and detailed even at the lowest volume level, for the pleasure of the late-night rehearsing musician.

As good in tour or at home

Pa4X is a compact, lightweight arranger workstation that you can comfortably take with you on stage. But add the optional modern, stylish dedicated stand, and you will be able to have it anywhere in your home - a stylish piece of modern furniture.

The built in programmable metronome can be used as a guide while practicing at home. But send the click through the separate outputs to the stage monitors or an headphone amplifier, and it will be used as a guidance by the other band's members.

A band always ready to play with you

Ultra-realistic sounds in the Pa4X are always ready to play along with you, in the music style best fitting your music. The high number of included Styles will satisfy any music genre, but can also be expanded by adding new Styles. You may also create your Styles, customize the existing ones, or easily convert MIDI Songs to Styles.

There are eight accompaniment parts which will follow your chords. The Auto Fill function will automatically choose a Fill for you. You can play in the simplest way or with the rich harmonization of a competent jazz player. We have programmed them to sound natural, and give you the feeling of a real band, ready to play with you at any time.

The convenient Chord Sequencer function records your chord progressions on-the-fly allowing the users to immediately play along with their own chord sequence, which is useful not only for practice, but for freeing up a hand while performing live. Chord Sequences can also be saved in Styles and SongBook Entries for easy recall.

Play and write songs

Play Songs in MID and MP3 formats with KORG's patented XDS Crossfade Dual Sequencer/Player. With both Songs and Styles, you can show lyrics for your singer and chords for your fellow guitarist. Any MIDI Song track can be converted into a readable score. Markers allow for jumping back to a passage you wish to repeat, for example in a piece you are studying or rehearsing.

Use the video output to display lyrics or score on an external monitor, making it perfect for karaoke or band leading.

You can record a MIDI Song using a full-featured Sequencer, or by using the Styles to record your live performance. Even easier, just record what you sing and play (including MP3 Songs) as an MP3 file, and listen to it anywhere you like.

Your music book

What is a huge collection of Styles and Songs, without an effective form of organization? Pa4X has the one most known to musicians: the SongBook, a music database allowing for fast song retrieving based on name, artist, genre or tempo. Styles and Songs are easily recalled by the SongBook.

Particularly useful for live use, the SongBook can assign songs from any custom Set List to dedicated buttons on the control panel. Your entire show will be under your fingers, with immediate access to any Style, Song and Sounds needed for your performance.

The SongBook can even be edited from a personal computer through our free editor. It can also be synchronized with most modern tablets to become your handy external digital music sheet reader (third-party software needed).

Sing naturally

Connect a condenser or dynamic microphone, and let the Adaptive Mic Setting automatically adjust parameters such as the Adaptive Gate, EQ, Compression and the De-Esser to make the vocals sound smooth and studio-produced.

For years, KORG has teamed with TC•Helicon®, the world leaders in vocal harmonies, to create and constantly improve the included Voice Processor. TC•Helicon's Voice Processor ensures that your vocals have the highest possible sound quality, and adds up to four realistic voices to your voice.

To ensure professional vocal performance, 3 knobs and 3 buttons controlling the most important vocal functions have been added to the top panel within easy reach.

Creative control with the KAOSS effects

KAOSS effects give you creative control on your performance. From subtle morphing between Variations and Drum Kit types, fine mixing between accompaniment Sounds, live reshaping of ongoing rhythms, to the most radical note-crunching effects of DJ heritage, to tape delay and arpeggios, you can add 'liquid mixing' to any Style or MIDI Song with the aid of easy-to-use computer-assisted composition features. Break the boundaries of preset music!

Open to the world, ready to the future

The use of standard file formats, like MID or MP3 for songs, or WAV and AIFF for samples, opens a world of possibilities when exchanging files. The USB ports allow for connecting Pa4X to any external storage device or personal computer, smartphone or tablet without the need for a dedicated MIDI interface. However, you can connect Pa4X to any existing MIDI musical instrument, thanks to its complete set of programmable MIDI ports.

Even more!

There is more, much more, but to know more, you need to explore Pa4X in depth. Pa4X is the most evocative, powerful, easy-to-use complete Arranger ever produced. Enjoy your musical life with the new Pa4X!

Before starting to play...

What's in the box

After you get your Pa4X, please check that all the following items are included in the package. If any of the following items is missing, please contact your KORG dealer immediately.

- Pa4X
- Music stand
- AC power cable
- Quick Guide

What you can add

After having purchased Pa4X, you might want to add these other fine options:

- The elegant KORG ST-SV1-BK keyboard stand, recommended for safety and comfort, perfectly matching your arranger design.
- The PaAS Amplification System, adding a three-way amplification system, a pair of integrated speakers and a bass-reflex box.
- One of the sturdy pedals and footswitches from the KORG catalogue.
- For Pa4X-61: The HDIK-3 kit, to install an (optional) hard disk drive.

Contacts

Your KORG dealers not only deliver this instrument, but also carry hardware and software accessories, as well as useful information on how to use these products. Ask them for any help you should eventually need.

Our international web site is www.korg.com. A list of all KORG Distributors can be found in our dedicated web page (www.korg.com/us/corporate/distributors/).

Making a safety copy of your data

In case you like to customize your musical resources, we suggest you use the **Media > Utility > Full Resources Backup** command to make frequent backup copies into compact and easy-to-store archives.

Also, you can use the **Media > Save All** command to save individual files that you can separately reload one by one.

Restoring a safety copy

To restore a backup, use the **Media > Utility > Resources Restore** command.

If you saved your data with the **Media > Save All** command, use the **Media > Load** operations to reload them.

Restoring the original factory data

In case you want to restore the original factory data, use the **Media > Utility > Factory Restore** command.

Warning: This operation will overwrite all the **Factory, Local, Favorite and User data!**

Loading the Operating System

Your Pa4X can be constantly updated as new versions of the operating system are released by KORG. You can download the most up-to-date operating system from our web site. Please, read the instructions supplied with the operating system on the site.

You can see which version of the operating systems is installed in your Pa4X by going to the **Media > Utility** page.

Warning: Do not install an OS other than the official OS supplied by KORG for the Pa4X. Trying to install an OS created for different models or downloaded from unofficial web sites may cause data loss and permanent damage to the instrument. KORG is not responsible for any damage caused by improper installation of the OS.

Overview of the instrument

The following pages show the functional areas of the front and rear panels.

Front panel

The front panel is where you can find the instrument's controls, the (optional) loudspeakers and the music stand.

Guide for the music stand and
PaAS amplification system

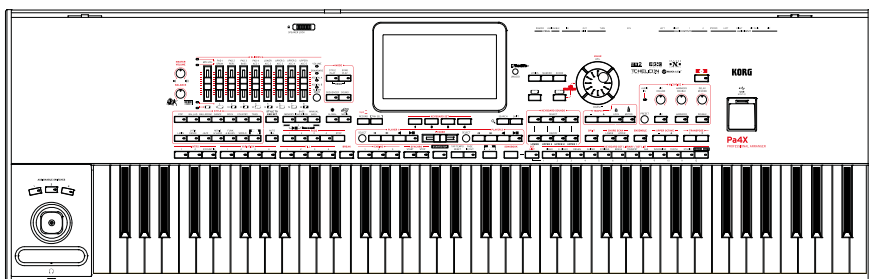
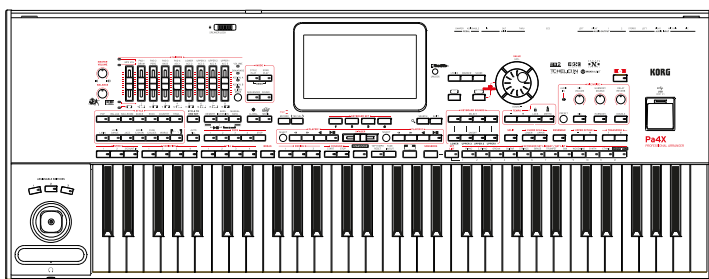

Headphones

Keyboard

PaAS amplification system

You can install the (optional) PaAS amplification system (see page 1070 for assembly instructions). When installed, control the output volume of the speakers via the **MASTER VOLUME** knob.

The speakers are automatically deactivated when connecting the headphones. You can also manually deactivate them by deselecting the **Speakers** checkbox in the **Global > Audio & Video > MP3/Speakers** page.

Music stand

A music stand is included with your Pa4X (see page 1076 for assembly instructions).

Headphones connector

Connect a pair of headphones to this output. You can use headphones with an impedance of 16-200 Ohms (50 Ohms suggested).

Keyboard

Use the keyboard to play notes and chords. Depending on the status of the SPLIT indicator, the keyboard may be joint or split between different sounds.

Control panel

The control panel is the part of the front panel where you can find the instrument's controls.

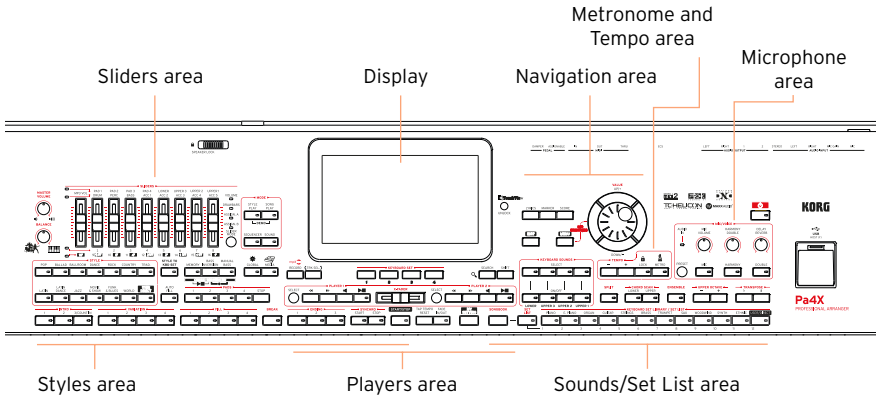

Display

Use this touchscreen display to interact with the instrument. The display can be tilted for optimal visualization. There are controls around the display, to help you select the various elements. (See page 20).

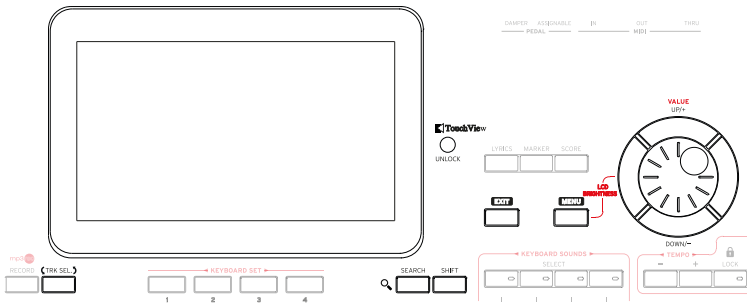

Navigation area

Use these controls to go through the menus, pages and parameters, and search for the various musical resources (see page 22).

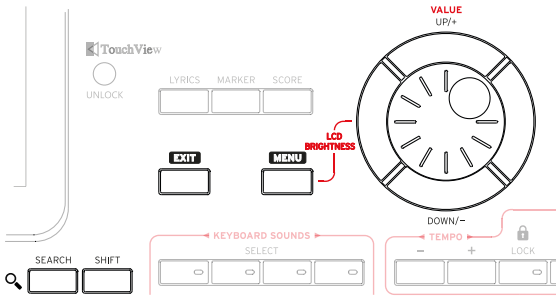

Sounds (and Set Lists) area

Sounds are what you can play on the keyboard (see page 3). Here you can choose Sound sets saved as Keyboard Sets in a dedicated library. Or you can choose Set Lists from the SongBook, that are collections of Sound sets with an associated Style or Song.

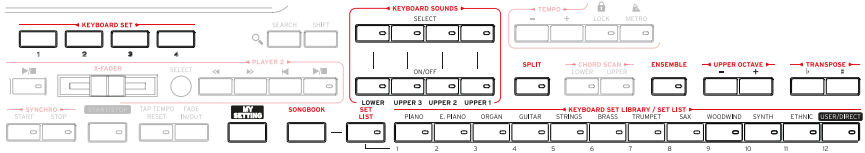

Styles (and Pads) area

Styles supply the automatic accompaniment with a virtual band. You can play Sounds (selected via the Keyboard Sets) and Pads along with the automatic accompaniment. (See page 51).

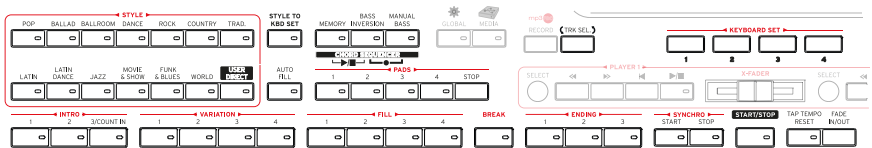

Players area

Songs can be played back by the two onboard Players. You can play Sounds (selected via the Keyboard Sets) and Pads along with the Songs. (See page 69).

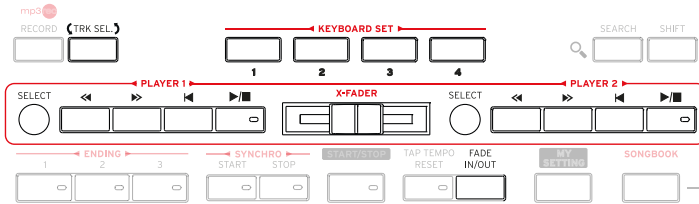

Metronome and Tempo area

Use these controls to practice with the metronome and control the Tempo of the metronome, the Styles and the Songs (see page 47).

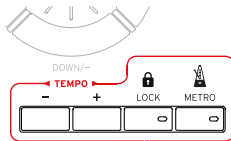

Microphone controls

Here you will control the microphone input and the voice effects and harmonization (see page 510).

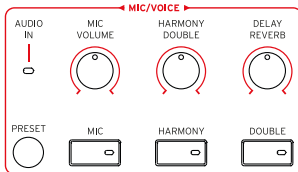

USB connector

Use this connector to connect an USB memory device, like an USB pendrive (HOST-F), or other musical instruments to be used as controllers. You can also use it to attach a small USB lamp and illuminate the control panel or the music stand.

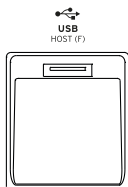

Rear panel

The rear panel is where you can find the various connections (see page 16).

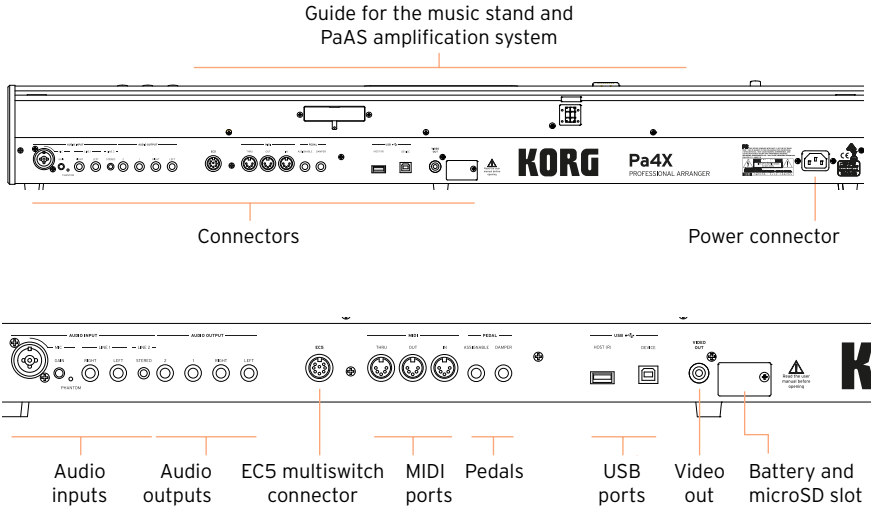

Audio inputs

Use these connectors to connect a microphone or another musical instrument. The handy STEREO minijack can be used to directly connect the audio output of a media player, a smartphone or a tablet.

Audio outputs

Use these connectors to send the audio signal (sound) to a mixer, a PA system, a set of powered monitors, or your hi-fi system.

EC5 connector

You can connect an (optional) Korg EC5 multiswitch pedalboard, to control many functions in realtime.

MIDI ports

Use these ports to connect Pa4X to external controllers (master keyboard, MIDI guitar, wind controller, MIDI accordion, MIDI pedalboard...), to a series of expanders, or to a computer with a MIDI interface.

Pedal connectors

Use the **DAMPER** connector to connect a damper pedal, and the **ASSIGNABLE** connector to connect either a continuous pedal or footswitch.

USB ports

Use these connectors to connect your Pa4X to a personal computer or a tablet (**DEVICE**) or to connect an USB memory device, like an USB pendrive, or another musical instrument to be used as a controller (**HOST-R**).

Video out

Connect Pa4X to a TV or video monitor, to read lyrics and chords on a bigger display.

Battery and microSD slot

This opening contains the clock battery and the microSD card slot.

Power connector

Use this socket to plug in the supplied IEC power cable.

02 Setting up the pedals and audio connections

Connecting the pedals

Connecting the damper pedal

Use the PEDAL > DAMPER connector to connect a damper pedal, like the (optional) KORG PS1, PS3 or DS1H. The DS1H pedal supports all the nuances of half-pedaling on some acoustic piano sounds. You can experiment how it works by gradually pressing it down, and gradually releasing it, while playing the Concert Grand Sound.

If you need to change the pedal's polarity and calibrate it, go to the Global > Controllers > Foot page.

Connecting a pedal or footswitch

Use the PEDAL > ASSIGNABLE connector to connect a footswitch pedal like the (optional) KORG PS1, PS3 or DS1H, or a continuous pedal like the (optional) KORG XVP-10 Volume pedal or EXP-2 Expression pedal.

By default, this connector will work as an Expression pedal. If you want to change the assigned function, or you need to change the pedal's polarity and calibrate it, go to the Global > Controllers > Foot page.

What if the pedals do not behave correctly?

If needed, you might want to recalibrate the pedals. Or you might need to reverse the pedal's polarity. See how to do in [Calibrating the pedal and setting its polarity](#) on page 833.

Connecting the EC5 multiswitch

Use the EC5 connector to connect the (optional) KORG EC5 multiswitch. With this programmable controller you can control various functions.

By default, the first switch acts as an automatic accompaniment's Start/Stop command, while each of the remaining four switches select one of the four Style Variations. If you want to change the assigned functions, go to the [Global > Controllers > EC5](#) page.

Connecting the headphones

Connect a pair of headphones to the PHONES connector. You can use headphones with an impedance of 16-200 Ohms (50 Ohms suggested). When connecting the headphones, the PaAS speakers are automatically deactivated.

Adjust the output level with the MASTER VOLUME knob.

Connecting the audio outputs

Use the AUDIO OUTPUT connectors to send the audio output to a mixer, a set of powered monitors, or an audio amplification system. These are balanced/unbalanced (TRS) 6.35 mm, or 1/4", jack connectors.

When using a home audio amplifier, connect the other end of the cable to the CD, LINE IN or TAPE/AUX input of your audio system. Don't use the PHONO inputs of your audio system!

- Use the LEFT and RIGHT connectors as the main stereo outputs. Connect either of them to output a mono signal. Adjust the output level with the MASTER VOLUME knob.
- Use the 1 and 2 connectors as the separate sub-outputs. These can be used for a stereo sub-mix, or to output just a single Sound to be mixed alone, or to be processed or amplified externally. The Sounds are sent to these outputs with no effects. Adjust their volume with the mixer's or external speaker's level controls.

If installed, the (optional) PaAS amplification system will work in parallel with the main audio outputs.

03 Powering up

Turning the instrument on

Connecting the power cable

Plug the supplied power cable into the POWER socket on the back of the instrument, and the cable plug into a wall power socket.

When the cable is connected, the instrument is in standby.

Warning: When the instrument is in standby, it is still connected to the power line. Accessing the inside of the instrument can be dangerous. To completely disconnect the instrument from the power, unplug the power plug from the power socket on the wall.

Turning the power on or off

Turn the instrument on

- Press the POWER () button to turn the instrument on (that is, 'exit from standby'). After you turn the instrument on, wait for the welcome screen to disappear, then the main page of the Style Play mode will be shown in the display.

Turn the instrument off (standby)

- Keep the POWER () button pressed for about one second, then release it when the screen appears dimmed. The shutdown procedure will begin and last for a few seconds. Please do not disconnect the power cable during this procedure.

Calibrating the touch screen

Calibrating the display

It may happen (for example, after loading a new operating system) that the Color TouchView™ display has to be recalibrated, to make pointing more accurate.

Warning: Do not use sharp objects, or you will damage your screen!

- 1 Keep the GLOBAL button pressed, until the Touch Panel Calibration page appears.



- 2 First touch exactly inside the set of arrows in the upper left corner of the display.
 - 3 The arrows will subsequently move to the other corners of the display. Touch exactly inside them.
 - 4 Finally, touch Save to confirm the new calibration.
- In case you want to exit and cancel the calibration, press the EXIT button before completing the procedure.

Adjust the display brightness

Brightness can be adjusted to match the ambient's light.

- Keep the MENU button pressed, and use the VALUE controls to adjust the display brightness.

Tilting the display

For optimal visibility under any seating position, the display's tilt angle can be adjusted.

Lifting the display

- 1 Press the UNLOCK button to unlatch the display.
- 2 Keep the UNLOCK button pressed, and adjust the tilt angle.
- 3 Release the UNLOCK button to fix the display to the current position.

Closing the display

- 1 Keep the UNLOCK button pressed, and accompany the display down.
- 2 Release the UNLOCK button, and gently press the center of the top border of the display to lock it in the initial position.

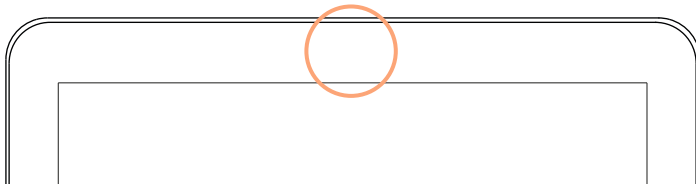

Listening to the Demo Songs

Access the Demo mode

- Press the DEMO buttons together.



Listen to all the Demo Songs

- After accessing the Demo mode, do not press any button. All the Demo Songs will be played back.

Choose a single Demo Song

- Touch one of the options on the display (Full Songs, Solo Instruments, Styles), then choose one of the Demo Songs.

Exit from the Demo mode

- Press any of the MODE buttons.

04 Interface basics

The main page

The Main page of the Style Play mode appears when turning the instrument on. You can return to this page by pressing the EXIT button while in Style Play mode, or the STYLE PLAY button when in a different mode.

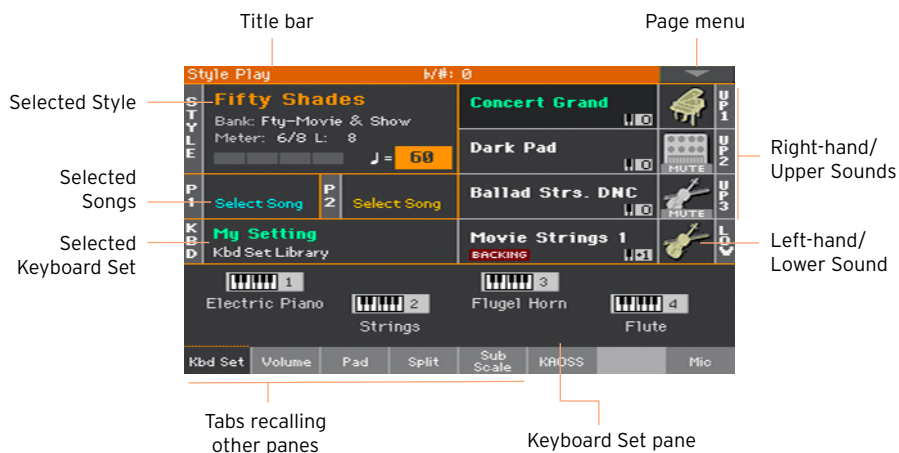

The user interface in detail

Display and user interface elements

Color TouchView graphical user interface

Pa4X features our exclusive easy-to-use TouchView™ graphic interface, based on a touch panel LCD screen. By touching items on the LCD screen, you can select pages, tabs, and parameters, and set parameter values via on screen menus and buttons.

Operative modes

The pages of Pa4X are grouped in various operating modes. Each mode is accessed by pressing the corresponding button in the **MODE** section on the control panel.

Each operating mode is marked with a different color code, that helps you understand where you are at first sight.

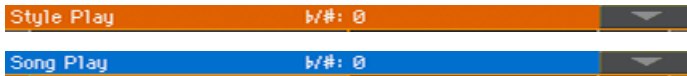

Two special modes (Global and Media) overlap the current operating mode, that remains active in the background.

The Record mode can be accessed from the Style Play, Sequencer and Sound modes, and allows for creating new Styles, Pads, Songs or Samples.

Edit menus and sections

Pages are grouped into sections, to be selected by touching the corresponding buttons in the edit menu that opens up when you press the **MENU** button.



Pages and tabs

Parameters are grouped into separate pages, to be selected by touching the corresponding tabs in the lower area of the display.



Overlapping windows

Several windows, like the Style Select or Sound Select, the Global, the Media, or the Lyrics, overlap the current window. After you select an item in the window, or press the EXIT button, the window closes, and the underlying page is shown again. (The following example is the Keyboard Set Select window).



Dialogs

Similar to selecting windows, dialogs overlap the underlying page. Touch one of the buttons on the display to give Pa4X an answer, and the dialog will close.

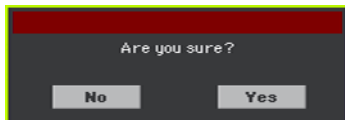

Page menus

Touch the down-pointing arrow icon in the upper right corner of each page, and a menu with commands relevant to the current page will appear.

Touch one of the available commands to select it. (Or, touch anywhere else on the screen to make it disappear, with no command selected).

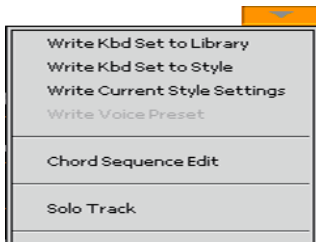

Pop-up menus

When a down-pointing arrow appears next to a parameter name, touch the arrow to open the **pop-up menu** and choose an option from there (by touching the option, or scrolling the list with the **VALUE** controls). As an alternative, touch the parameter name and use the **VALUE** controls to scroll the list of options.

If you want to make the menu disappear without selecting anything, touch anywhere else on the display.

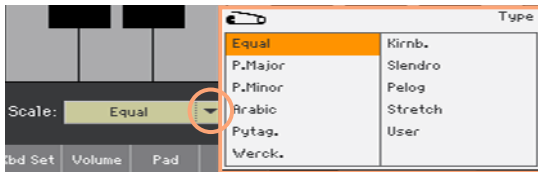

Lists and scrollbars

Files on storage media, as well as other kinds of data, are shown as lists. Use the **scrollbar** to scroll the list content. Also, you can use the **VALUE** controls to scroll.

When the Name label is selected on top of a list, keep the SHIFT button pressed while touching one of the arrows on the scrollbar, to jump to the next or previous alphabetic section.

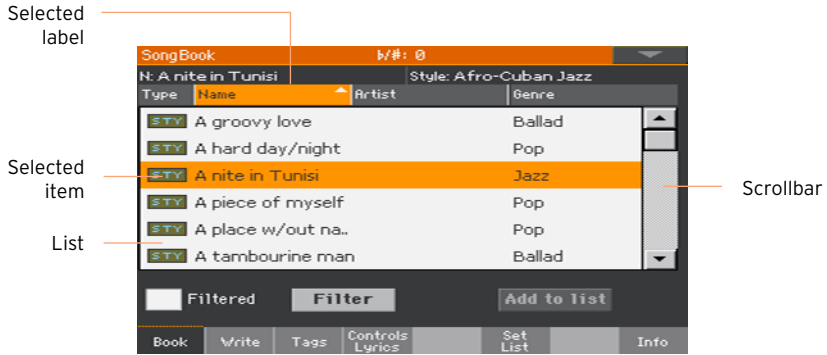

Parameters

Checkboxes

This kind of parameters are on/off switches. Touch them to change their status.



Editable names

When the Text Edit (**T**) button appears next to a name, touch it to open the Text Edit window and edit the name.

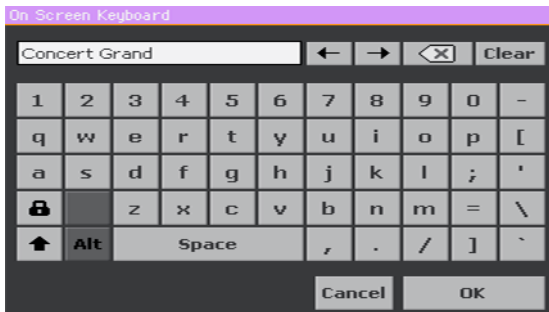

The virtual keyboard works exactly as a personal computer's keyboard. Some of the symbols are context-sensitive, and only appear when they can actually be used.

Numeric fields

When a numeric value can be edited, touch it a second time to open the Numeric Keypad.

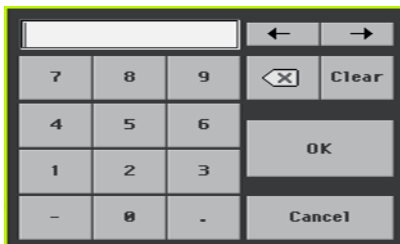



The virtual numeric keypad works exactly as the numeric keypad of a personal computer.

As an alternative, touch a numeric field and keep it held. Then move your fingers up (or right) to increase the value, or move it down (or left) to decrease it.

This also includes the Tempo numeric field in various pages.

Icons

Various icons help identifying the type of a file, a folder, a Song. For example:

Icon	Meaning
	Folder
	File of Style bank
	MID file

Selected, highlighted items

Any operation on parameters, data or list entries, is executed on highlighted items. First touch the parameter or item to select it, then execute the operation. Most parameters can be edited with the **VALUE** controls.



Non-available, dimmed parameters

When a parameter or command is not currently available, it is shown dimmed on the display. This means it cannot be selected, but may become available when a different option is selected.



Virtual controllers

Virtual sliders

To change a virtual slider's position, touch it and keep it held, then slide up or down to change its position. As an alternative, touch it, then use the **VALUE** controls to change its position.

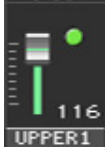

Depending on the status of the **SLIDER MODE** indicator, the position of the virtual sliders might match that of the **SLIDERS**.

Virtual knobs

To change a virtual knob's position, touch it and keep it held, then slide your finger up (or right) to rotate it clockwise, or slide it down (or left) to rotate the knob counter-clockwise. As an alternative, touch it, then use the **VALUE** controls to change its position.



Virtual drawbars

To change a virtual drawbar's position, touch it and keep it held, then slide it up or down to change its position. As an alternative, touch it, then use the **VALUE** controls to change its position.



Shortcuts

Some commands or pages can be recalled by keeping the **SHIFT** button pressed, and pressing other buttons or elements in the display. See **Shortcuts** on page 1095 for a list of the available shortcuts.

Navigating through the pages

Going to a page

Through this manual, page addresses are shown as in the following example:

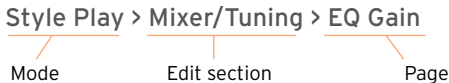

Here is how the above works:

- 1 Press the STYLE PLAY button to go to the Style Play mode. When the instrument turns on, it is already in this mode (this the Main page of the Style Play mode).

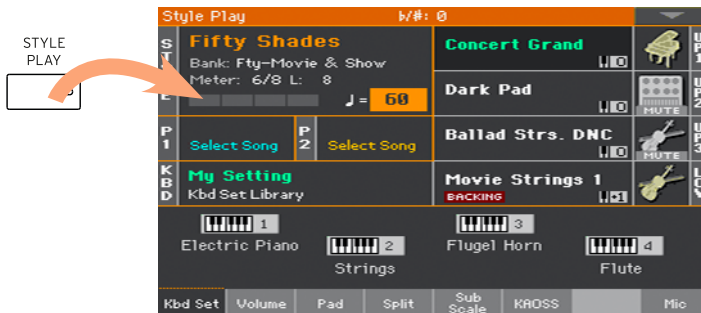

- 2 Press the MENU button on the control panel to see the edit menu of the Style Play mode.



- 3 Touch the Mixer/Tuning button in the edit menu to choose the Mixer/Tuning section.

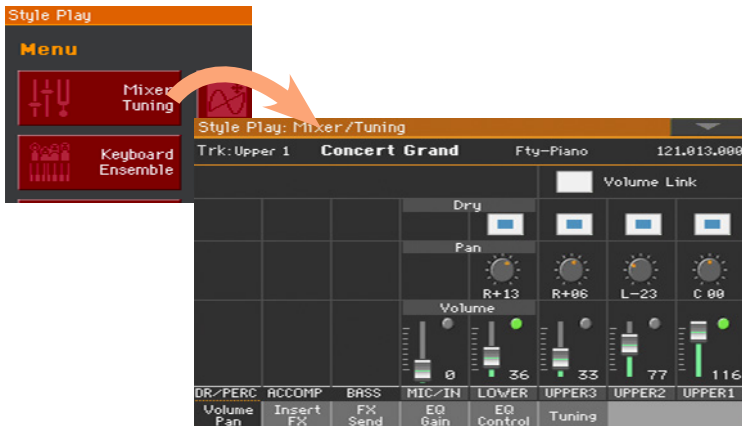

The selected edit section is always shown in the title bar:

Style Play: Mixer/Tuning

Mode

Edit section

- 4 If the page is not yet shown in the display, touch the EQ Gain tab to choose the EQ Gain page.

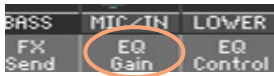

- 5 Edit the parameters.

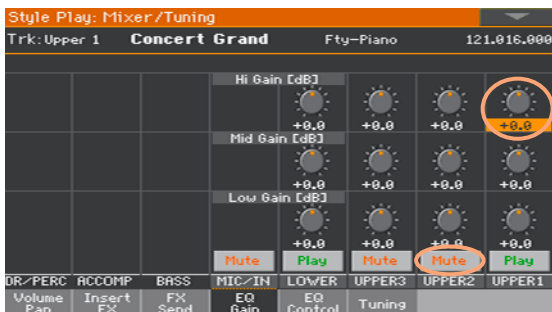

- 6 Try a different page in the same edit section. Touch the Volume/Pan tab to go to the Volume/Pan page, and edit the parameters.

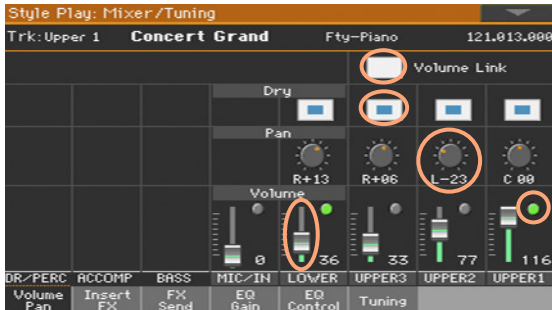

- 7 Press the EXIT button to return to the main page of the Style Play mode.



If you were in Song Play mode, pressing EXIT would have returned to the main page of the Song Play mode.

Selecting the musical resources

Opening a Select window

When you press one of the **STYLE**, **SOUND SELECT**, or one of the **KEYBOARD SET LIBRARY** buttons, the corresponding Select window appears. For example, this is the Sound Select window:

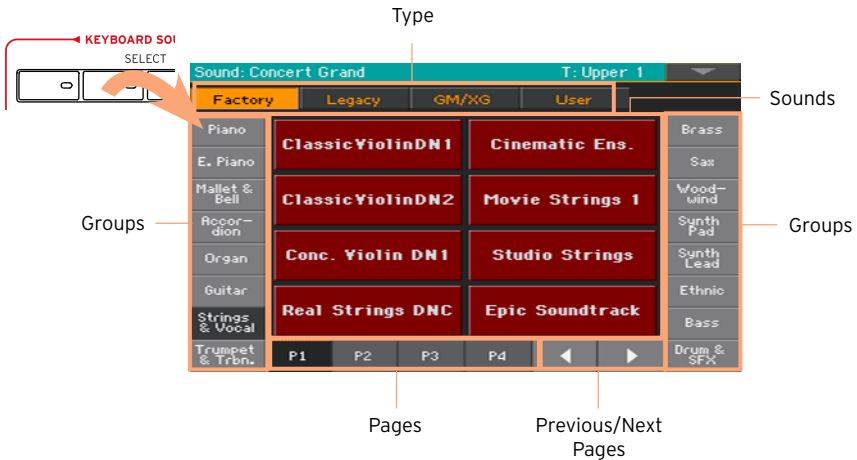

The Select window can also be opened by touching the name of the corresponding element in the display.

You can always exit from this window by pressing the **EXIT** button.

In Pa4X, Select windows stay always open until you press the **EXIT** button. If you prefer they automatically close after a few seconds, or after you select something, turn the **Display Hold** parameter off (see **Display Hold** on page 44).

PART II: PLAYING AND SINGING

05 Playing the Sounds

Sounds and Keyboard Sets

Sounds are the basic element of what you hear from your instrument. Pa4X contains Sounds from any instrumental family (pianos, strings, synthesizers...). A set of Sounds playing together on the keyboard can be memorized as a Keyboard Set.

To automatically recall Sounds and settings, you usually select a Keyboard Set. A Keyboard Set is a single memory location that can remember the Keyboard Sounds and all their transposition, effects, etc...

Keyboard Sets are individually contained in the Keyboard Set Library (KEYBOARD SET LIBRARY buttons). They are also associated to a Style or SongBook Entry; a group of four Keyboard Sets is recalled each time you select a Style or SongBook Entry (KEYBOARD SET buttons under the display).

Choosing your preferred set of Sounds

Choosing the 'My Setting' Keyboard Set

- Press the MY SETTING button to choose your preferred Sounds.

This is a special Keyboard Set, that is automatically selected when the instrument is turned on.

The My Setting Keyboard Set

My Setting is a special Keyboard Set, where you can save your preferred settings for things like Keyboard Sounds, Effects, Assignable Switches, a Style to be selected on startup. This Keyboard Set is automatically chosen when the instrument is turned on, and will automatically configure the instrument for you.

Writing the My Setting Keyboard Set

Keep the MY SETTING button pressed for about one second, until the Write dialog appears, then touch the OK button to confirm saving to memory.

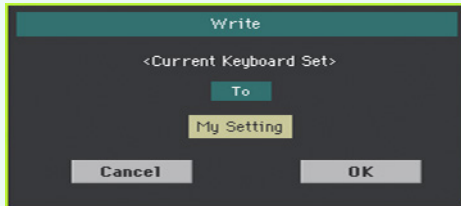

Choosing the Keyboard Sets

Choosing a Keyboard Set from the library

Keyboard Sets are contained in a dedicated library, that you can access from the control panel or from the display.

Open the Keyboard Set Select window from the control panel

- 1 Be sure the SET LIST indicator is turned off.
- 2 Press one of the buttons of the KEYBOARD SET LIBRARY section. You will notice that each of them has an instrument family name printed over it.

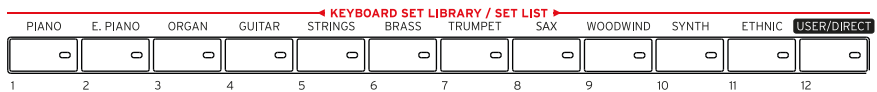

Open the Keyboard Set Select window from the display

- While in the Main page, touch the name of the selected Keyboard Set.



As soon as you press the button or touch the display, the Keyboard Set Select window appears.



Select a Keyboard Set

- 1 To choose one of the available types of Keyboard Sets, touch the buttons at the top of the window.

Type of Kbd Set	Meaning
Factory	Keyboard Sets included at the factory, that cannot be modified.
User	Locations where you can load new Keyboard Sets from an external device, or save new or edited Keyboard Sets.
Direct	User Keyboard Sets accessed directly from a storage device, without first having to load them.

The type of Keyboard Set will appear under its name.

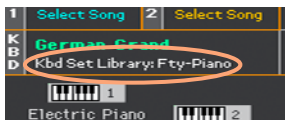

Label	Meaning
Keyboard Set's container	
Kbd Set Library	Keyboard Set from the Library (Factory/User/Direct)
Style Kbd1...4	Keyboard Set from the selected Style
SBook [song name] Kbd1...4	Keyboard Set from the selected SongBook Entry
Bank type	
Fty	Factory
Usr	Internal User
Dir	Direct User

- 2 In case you want to choose a different group of Keyboard Sets, either press a different button in the KEYBOARD SET LIBRARY section, or touch one of the tabs on the sides of the Keyboard Set Library Select window.



- 3 To choose one of the available pages in the selected Keyboard Set group, either touch one of the P1...P6 tabs at the bottom of the window, or repeatedly press the button of the selected group of Keyboard Sets in the KEYBOARD SET LIBRARY section of the control panel.

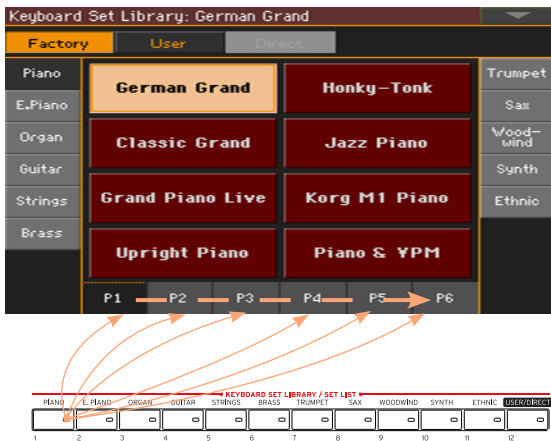

- 4 Touch the name of the Keyboard Set you want to choose.



- 5 If you want to close the Keyboard Set Library Select window (and it does not close by itself), press the EXIT button.

In the end, you will see the name of the selected Keyboard Set in the dedicated area of the Main page. The Sounds assigned to the keyboard (shown in the right half of the display) will change.



Choosing a Keyboard Set from a Style or a SongBook Entry

There are four matched Keyboard Sets in each Style or SongBook Entry, fine-tuned for the containing Style or SongBook Entry. You can choose them from the control panel or from the display.

Choose a Keyboard Set from the control panel

- Press one of the buttons in the KEYBOARD SET section under the display.



Select a Keyboard Set from the display

- 1 While in the Main page, be sure the Kbd Set pane is selected. If it isn't, touch the Kbd Set tab to select it.



- 2 Touch one of the Keyboard Set names in the display to select it.

You will see the name of the selected Keyboard Set highlighted in the dedicated area of the Main page. The Sounds assigned to the keyboard (shown in the right half of the display) will change.

Digital Drawbars

You will notice that some Keyboard Sets in the Organ group of the library contain the 'DWB' abbreviation in their name. These Keyboard Sets contain Digital Drawbars Sounds, that are simulations of electro-mechanical organs of the past.

When you choose one of them, the SLIDER MODE indicator goes to DRAWBARS. Use the sliders to control the drawbars and the corresponding footage of the organ sound.

Display Hold

You may prefer to leave a Select window open after you have chosen a Sound, Keyboard Set or Style, to continue trying other elements in that window. Or, you may prefer it automatically closes after you have completed your choice. This is determined by the Display Hold parameter.

Turn the Display Hold parameter on or off

- 1 Go to the **Global > General Controls > Interface** page.
- 2 Turn the Display Hold parameter on or off:
 - Select the **Display Hold On** checkbox to turn it on. Sound, Keyboard Set, Style, Pad or Voice Preset Select windows will remain open on the display, until you press the EXIT button.
 - Deselect the **Display Hold On** checkbox to turn it off. Sound, Keyboard Set, Style, Pad or Voice Preset Select windows will automatically close after you choose an element.
- 3 Press the EXIT button to return to the previous page.

Factory, User, Favorite, Direct

Across the pages, you will find words like Factory, User, Favorite, Direct. These terms refer to the type of protection from writing, or how much you can customize them.

- **Factory** (Keyboard Sets, Sounds, Styles, Pads, Voice Presets) are elements that you cannot normally overwrite or modify. They are meant to warrant that musical resources (like SongBook Entries) will always find linked musical resources (like Styles).
- **User** (Keyboard Sets, Sounds, Styles, Pads, Voice Presets) are elements that you can write, modify or overwrite. User Keyboard Set and Pad banks (the side tabs) can be renamed to create your own categories.
- **Favorite** (Styles) are User elements, where you can put a selection of preferred items. You are free to rename these banks (the side tabs) to create your own categories.
- **Direct** (Keyboard Sets, Styles, SongBook Entries) are User/Favorite elements that you can directly access from a storage device.

Playing and controlling the Sounds

Playing the keyboard

The instrument's keyboard is like a piano keyboard. Just play it!

With some Sounds, you can press the keys while they are down, and the sound might vary (for example, you might hear more vibrato).

Using the pedals

Pedals do different things depending on how they are programmed. The Damper pedal is just that - a damper pedal, sustaining notes until you release the pedal. The Assignable pedal (or footswitch) may change depending on how it is programmed in the **Global > Controllers > Foot** page.

Using the assignable sliders

Depending on the chosen Keyboard Set, the sliders can control different things, like volume levels of the different Sounds, the organ drawbars or some assignable functions. How they work is shown by the **SLIDER MODE** button's indicator.

Using the assignable switches

Depending on the chosen Keyboard Set and the assigned DNC functions, these controllers can do different things. The switches can either 'book' a function, that will be triggered while playing, or enable (or disable) it by pressing the button to 'toggle' it.

Indicator status	Meaning
Off	No DNC function assigned.
Red steady	Booking DNC function available.
Red blinking	Booking DNC function waiting to be executed. Then, it will return steady.
Green steady	Toggle DNC function available.
Green blinking	Toggle activated. Press it again to disable it.

Using the joystick

Moving the joystick left of right usually changes the Sound's pitch. Moving it forward usually trigger modulation, but this depends on the selected Sounds. With the electro-mechanical organs, pushing the joystick forward changes the rotary speaker's speed. What it does when pulled back depends on the selected Sounds. Just experiment!

Using the ribbon controller

Sweeping left of right on the ribbon controller usually changes the brilliance of the Sounds and/or the pitch, but how it works depends on the selected Sounds.

06 Tempo and Metronome

Tempo

Setting the Tempo value

While an optimal Tempo value is saved with each Style or Song, you can freely adjust it at your will. This will also set the Tempo for the Metronome.

Adjust the Tempo value from the control panel

- Use the TEMPO controls to adjust the Tempo value (or the speed of the MP3 Song).

As an alternative, for bigger Tempo changes, keep the SHIFT button pressed and use the VALUE controls.

Adjust the Tempo value from the display

- 1 If it is not highlighted, touch the Tempo value in the display.

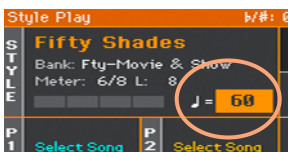

- 2 Use the VALUE controls to adjust the Tempo value.

As an alternative, touch the Tempo field again to open the numeric keypad, and enter the Tempo value as a number.

Reset the Tempo value

- Press both TEMPO buttons at the same time.

The Tempo value memorized in the Style or the MIDI Song will be recalled. With MP3 Songs, the original speed of the Song will be restored.

Visual Tempo count while the Style is not playing

While the accompaniment is not playing, the current Tempo is still beaten by the indicator of the START/STOP button.

Tapping the Tempo value

In Style Play mode, you can 'tap' (beat) the Tempo value.

- While the accompaniment is not playing, beat the Tempo on the TAP TEMPO button. Beat as many times as indicated by the Meter numerator (for example, three times in 3/4).

At the end, the accompaniment will start playing with the 'tapped' Tempo.

Locking the Tempo value

You can prevent the Tempo value from automatically changing when choosing a different Style or MIDI Song. MP3 Songs are not affected by this 'lock', and will always play at the recorded Tempo.

You are free to continue setting the Tempo manually, including beating the Style's Tempo with the Tap Tempo function. Please note that there is a separate Tempo for the Style Play and Song Play modes.

Prevent the Tempo value from changing

- Press the TEMPO > LOCK (🔒) button to light up its indicator. The Tempo value will not change when choosing a different Style or Song. You can still manually change the Tempo value (as seen above).

Let the Style or Song change the Tempo value

- Press the TEMPO > LOCK (🔒) button again to turn its indicator off. When choosing a different Style or Song, the memorized Tempo value will be recalled.

Tempo Change events found in the Style pattern or the MIDI Song may still change the Tempo.

Metronome

Turning the metronome on and off

Turn the metronome on

- Press the METRO () button to turn its indicator on. The Metronome window will open, and the metronome will start playing, beating the current Tempo.

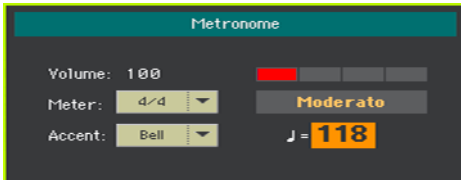

Turn the metronome off

- Press the METRO () button to turn its indicator off. The metronome will stop.

Setting the meter, accent and volume

You can mark the beginning of the measure, by setting the meter and accent.

Open the Metronome window

- Press the METRO () button.

Set the meter (time signature)

- Choose the meter (time signature) by using the Meter parameter.

Turn the accent on or off

- Choose the accent by using the **Accent** parameter.

Accent	Meaning
Off	No accent.
On	The first beat of each measure is accented.
Bell	A bell sound is heard at the first beat of each measure.

Adjust the metronome volume

- Adjust the metronome volume by using the **Volume** parameter.

Exit the Metronome window

- Press the **METRO** button to exit the window and stop the metronome.
- Press the **EXIT** button to exit the window without stopping the metronome. Then, press the **METRO** button to stop the metronome.

07 Playing the Styles

Choosing the Styles

Choosing a Style

You can choose a Style from the control panel or from the display.

Go to the Style Play mode

- When turning the instrument on, you are already in Style Play mode. If you are not, press the STYLE PLAY button in the control panel.
- If you are not in the Main page of the Style Play mode, press the EXIT button to return there.



Open the Style Select window from the control panel

- Press one of the buttons in the STYLE section.

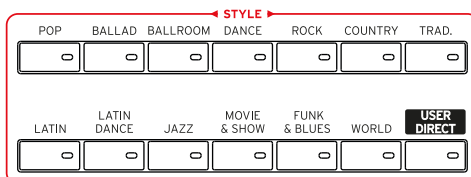

Open the Style Select window from the display

- Touch the name of the Style in the display.

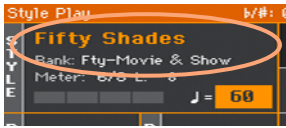

Choose a Style

- 1 Browse through the Styles in the Style Select window.



- To choose one of the available types of Styles, touch the buttons at the top of the window.

Type of Styles	Meaning
Factory	Styles included at the factory, that cannot be modified.
User	Locations where you can load new Styles from an external device, or save new or edited Styles. The name of these banks can be edited in order to create custom banks.
Favorite	Locations where you can load your favorite Styles from an external device, or save new or edited Styles. The name of these banks can be edited in order to create custom banks.
Direct	Styles accessed directly from a storage device, without first having to load them.

The type of Style will appear under its name.



Label	Meaning
Fty	Factory
Usr	Internal User/Favorite
Dir	Direct User/Favorite

- To choose a different group of Styles, touch one of the tabs on the sides of the window.

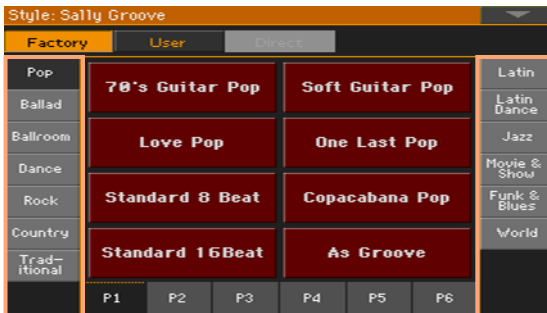

- To choose one of the available pages in the selected Style group, touch one of the P1...P6 tabs at the bottom of the window.



As an alternative, press again the same STYLE button.

- Touch the name of the Style you want to choose.
- If you want to close the Style Select window (and it does not close by itself), press the EXIT button. (When a window does not close by itself, it means the Display Hold is turned on. See Display Hold on page 44).

In the end, you will see the name of the selected Style in the dedicated area of the main screen.

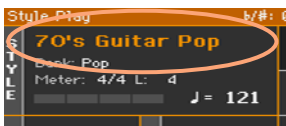

What is a Style?

Styles are collections of musical patterns in a particular music genre - or 'musical style' - offering an eight-parts automatic accompaniment, similar to an eight-member band playing with you. Chords you play on the keyboard will be recognized and will adapt the patterns to suit the music. Different sections can be selected to let you create a complete song in realtime.

Accompaniment parts

Accompaniment parts are like the members of a band. With Pa4X you get five pitched instrument players (for example: guitar, piano, strings, synthesizers), a bass player, a percussion player, and a drum player.

Chords and patterns

Accompaniment patterns are repeating musical sequences (like a bass groove, a guitar riff or a piano chord progression) that are dynamically adapted to match the recognized chords. They may vary depending on the type of chord (like C Major, C minor, or 7th).

Sections

Songs are made of different sections (Intro, Verse 1, Bridge, Chorus 1 and so on). There are different patterns for each song section, and they are collected under the Style Element buttons (INTRO, VARIATION, FILL, BREAK, ENDING). While the name of the Intro, Fill, Break and Ending are the same as the name of the corresponding song section, Variations can be used either for Verse, Bridge, Chorus or Special sections. The arrangement becomes denser the higher the element numbers go.

Intro Verse Fill Chorus Break / Verse Fill Chorus Ending

Intro 1 Fill 1 Break Fill 3 Ending 3
 Variation 1 Variation 2 Variation 3 Variation 4

Auto Fill

Pa4X can automatically match each Variation with a Fill. When the **AUTO FILL** indicator is on, when going from a Variation to a different one a Fill is automatically selected, without having to press one of the FILL buttons.

Making the accompaniment sparser

You can easily turn off any of the accompaniment groups by using the Play/Mute buttons in the Main > Volume pane. For example, you may want to mute the ACCOMP (Accompaniment) group to play with the backing of the drums and bass alone.



Letting Styles choose the Keyboard Sounds

Choosing a Style might automatically choose Keyboard Sounds. This depends on the STYLE TO KBD SET indicator (KBD SET = Keyboard Set).

STYLE TO KBD SET indicator	Meaning
Off	Styles do not select a Keyboard Set.
On	When choosing a Style, Keyboard Set 1 is automatically selected.
Blinking	Choosing a Variation automatically recalls the corresponding Keyboard Set (1 - 4) inside the Style. For example, choose Variation 2, and Keyboard Set 2 will be automatically recalled; choose Variation 3, and Keyboard Set 3 will be automatically recalled.

Programming the Style to Keyboard Set function

You can program how the STYLE TO KBD SET button works.

- 1 Go to the Global > Mode Preferences > Style 1 page.

As an alternative, keep the SHIFT button pressed and press the STYLE PLAY button to open the Style 1 page.



- 2 Use the Style to Kbd Set Mode menu to choose how the button works.

Style to Kbd Set Mode	Meaning
Next Measure	When you choose a Style, the new Keyboard Set will not be automatically selected until the first beat of the next measure is reached.
Immediate	When you choose a Style, the new Keyboard Set will be immediately selected.

- 3 Press the EXIT button to return to the previous page.

Playing a manual accompaniment (Bass & Lower Backing)

You can play a simple manual accompaniment, where the chord you play with your left hand is split between the Bass (chord root) and Lower (the remaining notes) Sounds.

Playing the manual accompaniment

- 1 Be sure the Bass & Lower Backing function is active. When it is, the Backing icon appears in the Lower Sound's area.

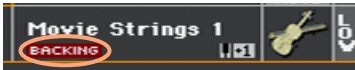

If the icon does not appear, see below how to activate it.

- 2 Be sure the SPLIT indicator is turned on, and the automatic accompaniment is not running.
- 3 Play a chord sequence with your left hand.

Notice how the chord root is played by the Bass Sound, while the remaining chord notes are played by the Lower Sound (even if it is muted).

Turning the Bass & Lower Backing function on or off

- 1 Go to the Global > Mode Preferences > Style 2 page.

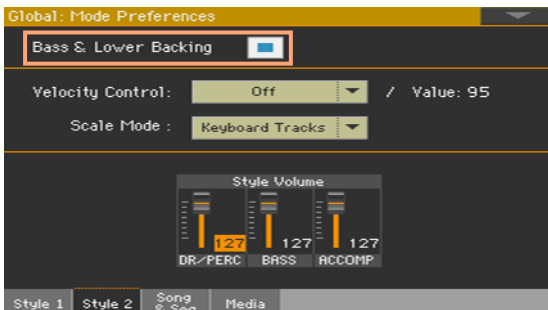

- 2 Select or deselect the Bass & Lower Backing checkbox to activate or deactivate the function.

Playing the automatic accompaniment

Starting and stopping the accompaniment

You can manually start and stop the accompaniment.

Start the accompaniment

- 1 Press the **START/STOP** button.
- 2 Play some chords with your left hand, while playing a melody with your right hand.

On the **START/STOP** button, a red indicator will mark the first beat, while a green indicator will mark the other beats of the measure.

While the accompaniment is playing, please note the various indicators in the display.

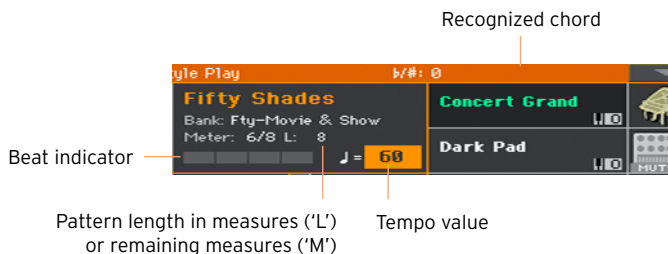

Stop the accompaniment

- Press again the **START/STOP** button.

Automatic start and stop

You can let the accompaniment automatically start or stop by just playing on the keyboard, without having to press the **START/STOP** button. This leaves your hands free for playing.

Make the accompaniment start automatically (Synchro Start)

- 1 Press the **SYNCHRO > START** button to light up its indicator.
- 2 Play a chord, and see how the accompaniment will start automatically.
- 3 Stop the accompaniment by pressing the **START/STOP** button.

Make the accompaniment start and stop automatically (Synchro Start and Stop)

- 1 Be sure the **SYNCHRO > START** indicator is turned on.
- 2 Press the **SYNCHRO > STOP** button, to light up both the **START** and **STOP** indicators.
- 3 Play a chord to start the accompaniment, and keep the keys pressed.
- 4 Lift your hands from the keyboard, and see how the accompaniment will automatically stop.

Make the accompaniment stop automatically (Synchro Stop)

- 1 Press the **SYNCHRO > START** button again to turn it off, and leave only the **SYNCHRO > STOP** indicator lightened.
- 2 Press the **START/STOP** button to start the accompaniment, then play a chord and keep the keys pressed.
- 3 Lift your hands from the keyboard, and see how the accompaniment will automatically stop.

Deactivate the Synchro Start/Stop functions

- Press the **SYNCHRO > START** and/or **SYNCHRO > STOP** buttons to turn both indicators off.

Choosing an Intro

An Intro is the introduction of the song. To choose the right Intro for your song, please note that **Intro 1** plays a short sequence with a prerecorded chord sequence and melody, while **Intro 2** plays on the chord recognized on the keyboard. **Intro 3** is usually a one-bar Count In.

Style Element	Suggested use
Intro 1	Intro with prerecorded chord sequence and melody.
Intro 2	Intro with chord recognized on the keyboard.
Intro 3/Count In	One-measure Count In.

- 1 Press one of the **VARIATION** buttons on the control panel to choose the Variation you want to use for the first verse. The button's indicator will be on, meaning the Variation is waiting to start.
- 2 Press one of the **INTRO** buttons on the control panel to 'book' one of the Intro sections. The button's indicator will be on, meaning the Intro is waiting

to start. The button's indicator on the selected **VARIATION** button will be flashing, meaning it is booked after the Intro.

- 3 Start the accompaniment.

Choosing a Variation to play a Verse or Chorus

Variations can be used for verses, choruses, bridges or specials. To choose the right Variation for your verse, please note that Variations are of growing 'density' and 'loudness'. This means that **Variation 1** will be the 'sparsest' and the 'quietest' of the arrangements, while **Variation 4** will be the 'densest' and 'loudest' of them. Usually, you will use Variation 1 for the first verse, Variation 4 for the last chorus.

Style Element	Suggested use
Variation 1	Verse, Bridge, Chorus or Special (lowest density)
Variation 2	Verse, Bridge, Chorus or Special (medium-low density)
Variation 3	Verse, Bridge, Chorus or Special (medium-high density)
Variation 4	Verse, Bridge, Chorus or Special (highest density)

- Wait for the Intro to end playing, and then the selected Variation will start playing. The selected **VARIATION** indicator will stay lit.
- As an alternative, you can start the Variation before the end of the Intro. While the Intro is playing, press one of the **VARIATION** buttons. The Variation will start at the next measure.

Choosing a Fill

Fills are phrases that can be used for smoothly bridging between different sections of a song. Their density is similar to that of the same numbered Variations.

Style Element	Suggested use
Fill 1	Fill (lowest density)
Fill 2	Fill (medium-low density)
Fill 3	Fill (medium-high density)
Fill 4	Fill (highest density)

- When the musical situation requires a change, press one of the **FILL** buttons to choose the Fill you want to play. The button's indicator will be on while the Fill is playing.
- If you want, choose a different Variation before the end of the Fill.

Choosing a Break

A break introduces a short pause in your song, creating a suspension and a sense of surprise.

Style Element	Suggested use
Break	One-measure break

- When the Variation is nearing its end, press the **BREAK** button to play a short musical break.

Choosing an Ending

To choose the right Ending for your song, please note that **Ending 1** plays a sequence with a prerecorded chord sequence and melody, while **Ending 2** plays on the chord recognized on the keyboard.

Style Element	Suggested use
Ending 1	Ending with prerecorded chord sequence and melody. If selected near the end of the measure, it will only start at its end.
Ending 2	Ending with the chord recognized on the keyboard. If selected near the end of the measure, it will only start at its end.
Ending 3	Two-measure Ending, starting immediately, without waiting for the measure to end.

- When it is time to end the song, press one of the **ENDING** buttons on the control panel to 'book' one of the Ending sections.
After the Ending, the Style will automatically stop.

Automatically choosing a Fill

If you like, you can let Pa4X automatically choose a Fill when you choose a Variation.

Turn the Auto Fill function on

- Press the **AUTO FILL** button to light up its indicator.

Automatically play a Fill, then a Variation

- Press one of the **VARIATION** buttons. A Fill will be automatically selected.

Turn the Auto Fill function off

- When you no longer need this function, press the AUTO FILL button again to turn the indicator off.

Programming the Auto Fill

You can program how the Auto Fill works.

- 1 Go to the Global > Mode Preferences > Style 1 page.

As an alternative, keep the SHIFT button pressed and press the STYLE PLAY button to open the Style page.

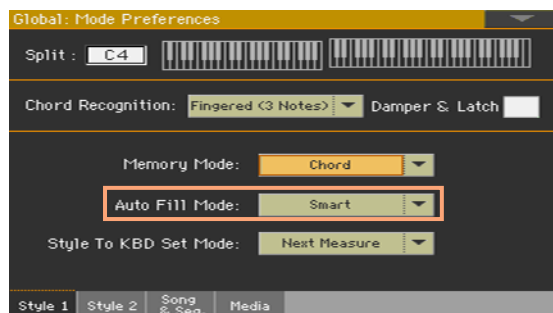

- 2 Use the Auto Fill menu to choose the Auto Fill mode.

Auto Fill Mode	Meaning
Current Variation	The Fill with the same number of the previous Variation will be automatically selected. For example, if you are going from Variation 2 to Variation 3, Fill 2 will be automatically selected.
Target Variation	The Fill with the same number of the target Variation will be automatically selected. For example, if you are going from Variation 2 to Variation 3, Fill 3 will be automatically selected.
Smart	Auto Fill tries to make the transition smoother. For example, if you are going from Variation 1 to Variation 4, Fill 3 will be automatically selected.

- 3 Press the EXIT button to return to the previous page.

Looping sections

If you feel that an Intro, a Fill, a Break or Ending should last longer than the recorded pattern, you can put it in a cycling loop.

Set a Style Element to loop

- Press twice the button of the Intro, Fill, Break or Ending to put in loop.

The indicator on the button will start flashing, and the pattern will start repeating.

Exit from the loop

Do one of the following:

- Press the same Style Element button again, or
- Select a different Style Element.

Keep a Style Element looping while its button is pressed

- Keep an Intro, Fill, Break or Ending button pressed to loop it. Release it when you want the Style Element to exit from the loop.
- If the **Auto Fill** function is turned on, keep a Variation button pressed to loop the corresponding Fill. Release it when you want the Fill to exit from the loop, and the Variation to start playing.

Fade In/Out

You can start and/or stop your playing with a smooth fade-in or fade-out.

Fade in

- While the accompaniment is not playing, press the **FADE IN/OUT** button to light up its indicator and start the accompaniment with a smooth fade-in.

The accompaniment will start. When the maximum volume is reached, the indicator will turn off.

Fade out

- When the song is approaching its end, press the **FADE IN/OUT** button to stop the accompaniment with a smooth fade-out.

Setting the Fade time

- Go to **Global > General Controls > Basic** to set the Fade In and Fade Out time.

Adjusting the accompaniment volume

Balancing the accompaniment against the keyboard

While playing, you may want to balance the Keyboard Sounds against the Accompaniment Sounds, to make the soloist stand out of the background or go back in the mix.

Balance the Accompaniment against the Keyboard Sounds

- While the accompaniment is playing, use the **BALANCE** knob to balance between the Accompaniment (Style) and the Keyboard (Keyboard Set) Sounds.

Adjusting the volume level of the Accompaniment Sounds only

If you wish, you can change how the **BALANCE** knob works, and transform it into a volume control for the Accompaniment Sounds only.

Program the **BALANCE** knob

- 1 Go to the **Global > Controllers > Hand** page.
- 2 In the **Balance Control** section, touch the **Accompaniment/Song Volume** option to choose it. Now, the **BALANCE** knob will work as the Style (and Song) volume only.
To go back to the default way of working, choose the **Accompaniment/Song - Keyboard Balance** option.
- 3 Press the **EXIT** button to close the Global page and return to the main screen.

Adjust the volume level of the Accompaniment Sounds

- While the accompaniment is playing, use the **BALANCE** knob to adjust the level of the Accompaniment Sounds.

The volume of the Keyboard Sounds will not change.

Making the accompaniment sparser

You can easily turn off any of the accompaniment groups by using the Play/Mute buttons in the Main > Volume pane. For example, you may want to mute the ACCOMP (Accompaniment) group to play with the backing of the drums and bass alone.



If you only want to listen to Drums and Percussions, press the CHORD SCAN buttons on the control panel to turn their indicators off. Press them again to reactivate all the accompaniment sounds.

Manually playing the Bass line

You can play the Bass Sound with your left hand, freeing it from the automatic accompaniment.

Turn the Manual Bass function on

- Press the **MANUAL BASS** button to turn its indicator on.

The automatic accompaniment will stop playing (except for the Drum and Percussion Sounds), and you can manually play the Bass line on the Lower part of the keyboard.

When in Manual Bass mode, the volume level of the Bass Sound will be automatically increased.

Turn the Manual Bass function off

- Press the **MANUAL BASS** button to turn its indicator off.

When turning the Manual Bass mode off, the volume level of the Bass Sound will be automatically set back to the original value.

08 Playing the Pads

Choosing the Pad sets

Choose the Pads by selecting a Style

- Choose a Style. The four Pads it contains will be selected.

Choose the Pads by selecting a SongBook Entry

- Choose a SongBook Entry. The four Pads it contains will be selected.

What is a Pad?

Pads are single-track hits or sequences, that you can instantly play with the dedicated **PADS** buttons. They can either play single sounds or short, cycling sequences that play in time with the Style or the MIDI Song. In Style Play mode, sequences are transposed according to the recognized chords.

Playing the Pads

Starting and stopping the Pads

You can play up to four Pads at the same time, by using the dedicated PADS buttons on the control panel.

Play the Pads

- Press one or more PADS buttons to trigger the Pads.
- Play some chords, and transpose any Pad of the Sequence type.

Stop a single Pad

- Press a PADS button to stop the corresponding Pad.

Stop all Pads at the same time

- Press the PADS > STOP button to stop all the Pads.

Stop all the Pads and the Style at the same time

- Press the START/STOP button, or one of the ENDING buttons.

Stop all the Pads and start a Song

- Press the PLAY/STOP button to start a Song. All the Pads will stop playing.

Pads of the One Shot type automatically stop at the end of the sequence. Pads of the Loop type continue cycling until you don't press the PADS > STOP button.

Changing Tempo

In Style Play mode, Pads are synchronized to the Style's Tempo. Change the Style's Tempo, and the Pads' Tempo will change accordingly.

In Song Play mode, Pads are synchronized to the latest MIDI Song's Tempo. Since Pads cannot be synchronized with MP3 Songs, the Tempo of the latest MIDI Song will be considered when playing MP3 Songs.

09 Playing the Songs

Choosing the Songs

Choosing a Song

Switch to the Song Play mode

Press the SONG PLAY button.

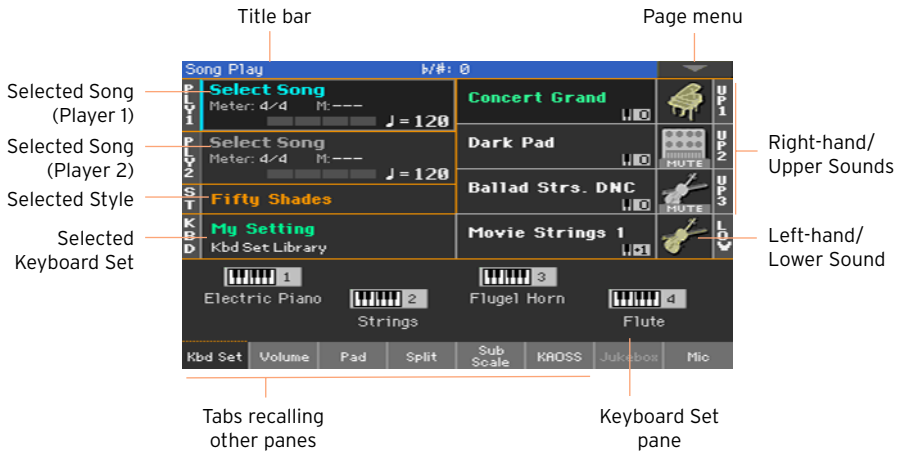

Open the Song Select window from the control panel

- Press the SELECT button in the PLAYER 1 or PLAYER 2 section.

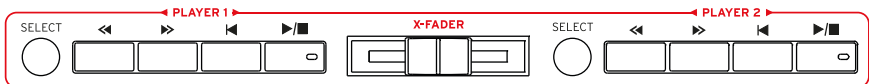

Open the Song Select window from the display

- Touch the name of the Song on the display. You can choose either Player 1 (PLY1) or Player 2 (PLY2) to play the Song.

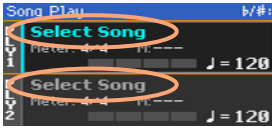

Browse through the Songs

While in the Song Select window, browse through the files to find the Song you are looking for.



- Choose a storage device by using the Device menu.

If the Song is contained in an external USB device, connect the device to one of the USB HOST port.

Device	Type
DISK	Internal drive
HD	Internal HD (optional in Pa4X-61)
SD	Optional internal microSD
USB-F	Optional device connected to the front (F) USB HOST port
USB-R	Optional device connected to the rear (R) USB HOST port

The actual name (label) of the device will appear between square brackets.

- Scroll the list by using the scrollbar. As an alternative, use the VALUE controls (if the focus is on the Device selector, touch any item in the list before using the dial).
- Open the selected folder/directory by touching the Open button.
- Go to the upper folder/directory by touching the Close button.

- Jump to the folder/directory, containing the Song currently assigned to the Player, by touching the Locate button.

Jump to a different alphabetical section

- 1 If it is not selected, touch the Name label on top of the list.
- 2 Keep the SHIFT button pressed and touch one of the arrows of the scrollbar to jump to the previous or next alphabetical section.

Change the list sorting

- Reorder the items according to a different criterion (Type, Name, Size, Date) by touching the corresponding label on top of the list.
- By touching the label again, the order of the files will switch between ascending and descending.

Select the Song

- 1 Touch the name of the Song you want to choose to highlight it.
- 2 Touch the Select button. If a Song is already playing, it will stop, and the new Song will be ready to play. You will return to the Main page of the Song Play mode.

When a Song has been selected, it will appear in the Song area.

- MIDI Song selected:



- MP3 Song selected:

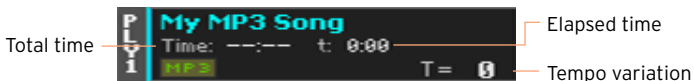

What is a MIDI Song

MIDI Songs' jargon name is Standard MIDI File, often abbreviated as SMF. The filename extension is .mid. The Standard MIDI File is the industry standard format for songs, and is used by Pa4X as the native file format when playing or recording MIDI Songs.

The MIDI Karaoke File (.kar) is an extension of the SMF format, and is also supported. It always contains lyrics.



MIDI
Song



MID file
on disk



KAR file
on disk

What is an MP3 Song

MP3 Songs' real name is even funnier: MPEG Layer-3, usually abbreviated as MP3. The filename extension is .mp3. This is a compressed audio file, used to store recorded songs in the smallest amount of space, without losing too much audio quality. At the highest quality, MP3 files are usually impossible to distinguish from non-compressed audio files. Pa4X can play and record MP3 files.



MP3
Song



MP3 file
on disk

Choosing a Song by ID number

Each Song in a folder on a device has a progressive ID number assigned (up to 9,999). When the ID numbers are shown in the Song Select window, you can enter this number to select the corresponding Song.

To help you find a Song by ID number, you can export a song list using the Export Song List command in the Song Select window, and print it.

Showing the ID number

- 1 Open the Song Select window.
- 2 Touch the page menu icon to open the menu, then touch the Show Song Number item to show (or hide) the ID numbers.

The Song's ID number will appear before each Song's name in the Song Select window.

 0007 CANYON.MID

Choosing a Song by number

- 1 Open the numeric keypad.
 - While in the Song Select window, press the SELECT button.
 - While in any page of the Song Play (or Style Play) mode, press the SELECT button twice.
- 2 Enter the ID number (included in the 0001~9999 range) corresponding to the Song to be selected, then touch the OK button to confirm. The Song will be selected.

If no Song corresponds to the number entered, a message will warn that the Song is not available.

Viewing the Song's filename extension

While you can recognize the type of files from the self-explanatory icons next to their names, you may prefer to also see the filename extension.

Make the filename extension appear

- 1 Open the Song Select window.
- 2 Touch the page menu icon, then touch the Show Song Extension menu item to make the checkmark appear next to it.

The filename extension will appear at the end of each file.

Make the filename extension disappear

- Deselect the Show Song Extension menu item.

Playing a Song

Starting, stopping and controlling the Player

Pa4X features two sets of Player controls, one for **PLAYER 1** and the other for **PLAYER 2**. Use the one or the other depending on the Player the Song is assigned to.

Set the right mix

- Move the **X-FADER** fully toward the Player you want to listen to. Move it fully to the left for Player 1, to the right for Player 2.

Start the Player

- Press the **PLAY/STOP (▶/■)** button.

While the Song is playing, the indicators in the display will show the current position.

Fast Forward the Song

- Press the **FAST FORWARD (⏩)** button once to jump to the next measure (MIDI Song) or to the next second (MP3 Song).
- Keep the **FAST FORWARD (⏩)** button pressed to scroll the Song continuously. Release it when you have reached the desired location.

Rewind the Song

- Press the **REWIND (⏪)** button once to jump to the previous measure (MIDI Song) or to the previous second (MP3 Song).
- Keep the **REWIND (⏪)** button pressed to scroll the Song continuously. Release it when you have reached the desired location.

Pause and resume playback

- Press the **PLAY/STOP (▶/■)** button to stop the Song at the current position. The button's indicator will turn off.
- Press the **PLAY/STOP (▶/■)** button again to resume playback. The indicator will turn on again.

Stop the Player and return to the beginning of the Song

- Press the HOME (◀) button to stop the Player and move to the beginning of the Song. The button's indicator will turn off.

Fade In/Out

You can start and/or stop a Song with a smooth fade-in or fade-out.

Fade in

- While the Song is not playing, press the FADE IN/OUT button to light up its indicator and start with a smooth fade-in.

The Song will start. When the maximum volume is reached, the indicator will turn off.

Fade out

- When the Song is approaching its end, press the FADE IN/OUT button to end it with a smooth fade-out.

Setting the Fade time

- Go to Global > General Controls > Basic to set the Fade In and Fade Out time.

Mixing two Songs

Assign a Song to each of the Players

- Either use the **SELECT** buttons in the **PLAYER 1** or **PLAYER 2** sections, or touch the name of the **Song** in the display.

The full procedure is described above.

Start both Players at the same time

- Keep the **SHIFT** button pressed, and press any of the two **PLAY/STOP** (▶/■) buttons to start both Players at the same time.

Mix the two Players

- During playback, move the **X-FADER** slider to mix the two Songs.
- Move the **X-FADER** slider fully to the left to only listen to Player 1, fully to the right to only listen to Player 2. Move it to the center to balance the two Players.

Separately control each Player

- During playback, control each Player by using the dedicated **PLAYER** controls on the control panel.

Stop the Players

- Press the relevant **PLAY/STOP** (▶/■) button to stop the corresponding Player.

Fade between songs

Instead of starting both Songs together, you can start them one after the other, and fade between them.

- 1 Assign a first Song to Player 1, a second Song to Player 2.
- 2 Move the **X-FADER** slider fully to the left, to only listen to Player 1.
- 3 Start Player 1.
- 4 When the Song is nearing the end, start Player 2.
- 5 Gently move the **X-FADER** slider toward the right, to fade out the first Song and fade in the second Song.

- 6 While Player 2 is playing, assign a third Song to Player 1, and repeat the above procedure (by reversing the X-FADER direction) to fade out Player 2 and fade in Player 1.

Playing along with the Song

Playing the keyboard

Play along with the Song

- While the Song is playing, play on the keyboard.

Choose different Sounds from the Keyboard Set Library



- Choose a different Keyboard Set from the **KEYBOARD SET LIBRARY** section of the control panel, or by touching the **KBD** area in the Main page.

Choose different Sounds from the Style or SongBook Entry

- The latest Style or SongBook Entry you selected contain up to four Keyboard Set. Choose a different Keyboard Set from the **KEYBOARD SET** section under the display, or from the **Kbd Set** pane of the Main page.

Muting the melody

Mute the melody if you are going to play or sing live. This will avoid overlapping between your playing or singing and the internal Sounds.

- 1 Go to the **Song Play > Volume** pane.
- 2 Use the **TRACK SELECT** button to see the Sound you want to mute.
- 3 Touch the **Play** () icon in the mixer channel corresponding to the Sound you want to mute. The **Mute** () icon will appear.

Saving the Play/Mute status

To make the Play/Mute status of the Song Sounds permanent for all the subsequent MIDI Songs, write it to memory.

- Go to the **Global > Mode Preferences > Song & Sequencer** page, and choose the **Write Song Play Track & FX** command from the page menu.

Muting a Song's Sound with an assignable switch or footswitch

You can mute the melody track of a Song by assigning the Melody Mute function to an assignable switch, footswitch or EC5 switch. This function mutes a track defined as the melody track. If the Song has the melody part assigned

to the same track number, you can mute or unmute it by using the assigned switch or footswitch.

- To choose a Song Melody track, go to **Global > Mode Preferences > Song & Sequencer** page.
- To program the assignable switch, go to the **Style Play** or **Song Play > Pads/ Switches > Switches** page.
- To program the footswitch, go to the **Global > Controllers > Foot** page.
- To program an EC5 switch, go to the **Global > Controllers > EC5** page.

Please note that programming an assignable switch will tie the page scroll command to a particular Keyboard Set or SongBook Entry. On the contrary, programming the footswitch or EC5 switch will offer a global option, that will not change when choosing a different Keyboard Set or SongBook Entry.

Transpose the Songs to play in an easier key

You may want to play on the keyboard in an easier key, and transpose a Song in the same key, without transposing the keyboard.

Activate transposition on the Players only

- 1 Go to the **Global > Tuning > Transpose Control** page.
- 2 Activate Transpose on the Player, and deactivate it on the Style and Keyboard tracks.

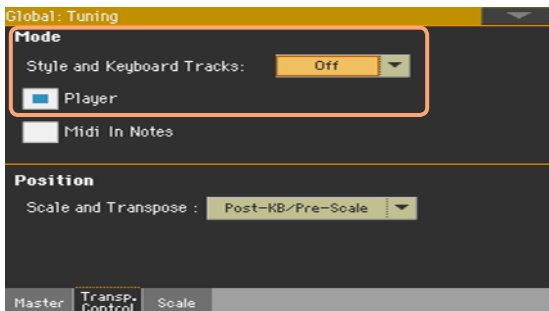

Transpose the Songs

- Use the **TRANPOSE** buttons on the control panel.

Adjusting the volume levels

Balancing the Songs against the keyboard

While playing, you may want to balance the Keyboard Sounds against the Songs, to make the soloist stand out of the background or go back in the mix.

Balance the Songs against the keyboard

- While the Songs are playing, use the **BALANCE** knob to balance between the Songs and the Keyboard (Keyboard Set) Sounds.

Controlling the volume of the MP3 Songs

You can adjust the volume of the MP3 Songs during playback.

- 1 Be sure the selected **SLIDER MODE** is **VOLUME**.
- 2 Use the first slider to adjust the volume of the MP3 Song.

Setting the general volume of the MP3 Songs

You can balance the volume of MP3 Songs against that of MIDI Songs and Styles.

- 1 Go to the **Global > Audio & Video > MP3/Speakers** page.
- 2 Use the **MP3 Player > Volume** parameter to set the maximum volume of the MP3 Player.

MP3 Volume	Meaning
0 ... 100	Max volume in percentage

Choosing the audio outputs for the MP3 Songs

You can send the MP3 Songs to a separate audio output (or output pair), for separate mixing.

- 1 Go to the **Global > MP3/Speakers** page.
- 2 Use the **MP3 Player > Audio Out** pop-up menu to choose an audio output (or output pair) for the MP3 Songs.

Playing all the Songs in a folder

When playing all the Songs in a folder, use the PLAYER 1 controls.

Open the Song Select window from the control panel

- Press the SELECT button.

Open the Song Select window from the display

- Touch the name of the Song in the display.



Select the folder containing the Songs to play

- 1 Browse through the files, until you find the folder containing the Songs to play, and open it.
- 2 Touch the Play All button to pre-select all the Songs in the folder.

A Jukebox file will be automatically generated and assigned to Player 1. The order in which the Songs will be played back will depend on how they appear in the Song Select window.

Play the list of Songs

- 3 Start and stop the Songs by pressing the PLAY/STOP (▶/■) button.
- 4 Use the standard PLAYER 1 controls to play, pause, stop, fast forward and rewind the Songs.

Move through the Songs

- Jump to the next Song in the list by keeping the SHIFT button pressed and pressing the FAST FORWARD (⏭) button.
- Jump to the previous Song by keeping the SHIFT button pressed and pressing the REWIND (⏮) button.

- Press the HOME (⏪) button to go back to the beginning of the current Song.

Save the list as a Jukebox file

- If you want to save the list, go to the Song Play > Jukebox Editor edit page and save it as a JBX file. (See below for more information).

Playing a Jukebox list

Creating and editing a Jukebox list

Create a Jukebox list

- 1 Go to the Song Play > Jukebox Editor page.

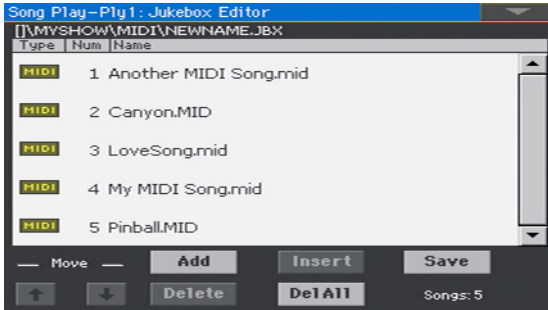



- 2 If a list of Songs already exists (because you selected an existing Jukebox file, or used the Song Select > Play All function), touch the Del All button to delete all from the list.
- 3 Touch the Add or Insert button to open the Song Select window.
 - Add will append a Song at the end of the list.
 - Insert will insert a Song between the selected item and the previous one.
- 4 While in the Song Select window, browse the MID, KAR and MP3 files in the folder, and select the Songs to be added.

If you like, you can choose another Jukebox (JBX) file, and add all its Songs to the Jukebox list you are editing.

- 5 Confirm by touching the OK button.
- 6 Continue adding Songs to the list.

Please note that you can only add Songs from the same folder, and that a Jukebox list can only include up to 127 Songs.

Edit the Jukebox list

- Use the Move > Down () and Move > Up () buttons on the display to move the selected Song to a different position in the list.
- Touch the Delete button to delete the selected Song from the list.

- Touch the Del All button to delete all Songs from the list.

Save the Jukebox list

- 1 Touch the Save button to open the Save Jukebox File dialog.

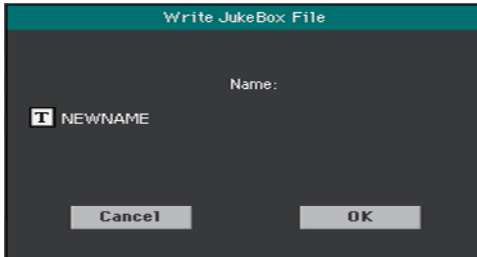

Please note that you can only save the JBX file in the same folder containing the Song files included in the list. The Jukebox file and Songs will have to be in the same folder.

- 2 While in the Save Jukebox File dialog, touch the Text Edit (**T**) button if you want to assign the Jukebox file a new name.

If you are saving a new list, the NEWNAME.JBX name is automatically assigned, and you can edit it.

Otherwise, the existing name is proposed. If the existing name is not edited, the old Jukebox file will be overwritten.

- 3 When done, touch the OK button to confirm.

Playing a Jukebox list

Instead of single Songs, you can assign a Jukebox file to Player 1.

Open the Song Select window from the control panel

- Press the SELECT button in the PLAYER 1 section.

Open the Song Select window from the display

- Touch the name of the Song in the display.

Select the Jukebox file

- Browse through the files, until you find the Jukebox (.jbx) file, and open it. You can quickly locate Jukebox files by their icon ().

The selected Jukebox list contains pointers to Songs residing in the same folder as the Jukebox file. Please do not move nor delete the Songs, nor disconnect any connected USB storage device containing the Songs.

Play the Jukebox list

- 1 While in the Main page of the Song Play mode, touch the Jukebox tab to show the Jukebox pane and see the list of Songs contained inside the selected Jukebox list.
- 2 Touch the name of the Song you want to start from, then touch the Select button to assign it to the Player.
- 3 Start and stop the Songs by pressing the PLAY/STOP (▶/■) button.

All the Songs in the list will continue playing one after the other, until you don't stop them.

- 4 Use the standard PLAYER 1 controls to play, pause, stop, fast forward and rewind the Songs.

Move through the Songs

- Touch a different Song in the list, then touch the Select button to jump to that Song.
- Jump to the next Song in the list by keeping the SHIFT button pressed and pressing the FAST FORWARD (») button.
- Jump to the previous Song by keeping the SHIFT button pressed and pressing the REWIND («) button.
- Press the HOME (◀) button to go back to the beginning of the current Song.

What if a Song in the list is missing?

If a Song in the list is missing, the Player will stop and a warning message will appear in the display. Go to the Song Play > Jukebox pane, and select a different Song.

10 Lyrics, chords, markers and score

Choosing one of the Players

- While in the Lyrics, Score or Markers page, you can touch either the Player 1 or Player 2 button in the title bar to select the corresponding Player.
- As an alternative, move the X-FADER slider fully to the left to only listen to and see the lyrics, chords, score or markers of Player 1. Move it fully to the right to only listen to and see the lyrics, chords, score or markers of Player 2.

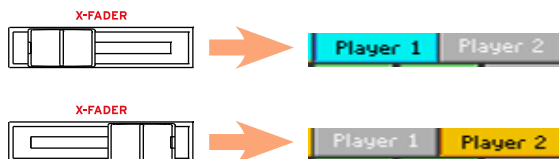

Where are lyrics and chords contained?

- Inside the MIDI Songs. Lyrics and chords may be contained inside MIDI Songs as MIDI events.
- Inside the MP3 Songs. Lyrics may be contained into MP3 Songs as ID3/Lyrics3 and ID3/Frames tags.
- In TXT files associated to MIDI or MP3 Songs. Lyrics and chords may be contained in a TXT file having the same name of a MIDI Song or an MP3 Song, and residing in the same folder. You can even load a text file while playing a Song or a Style.
- In CDG files associated to MP3 Songs. Lyrics and chords may be contained in a CDG file having the same name of an MP3 Song, and residing in the same folder.
- In TXT files linked to a SongBook Entry. A TXT file can be linked to a SongBook Entry.

Reading the lyrics and chords contained in a Song

Reading lyrics and chords

Open the Lyrics page

- Press the LYRICS button on the control panel. The Lyrics page will appear, and you will see the lyrics assigned to the selected Player.



Read the lyrics

- While the Song is playing, lyrics contained in a MIDI or MP3 Song will automatically scroll in the display, in time with the music. Lyrics at the current position will be highlighted.

Exit from the Lyrics page

- When done with the lyrics, press either the LYRICS or the EXIT button.

Changing the text size

You can choose between two text sizes.

- Use the AA button in the Lyrics page to change the font size.

Showing chords

You can show or hide the chord symbols that might be included as Lyrics events in the MIDI Songs.

- Be sure the **Chord** button appears pressed in the **Lyrics** page to see the chord symbols. Chord symbols (if any) will appear above the lyrics, in time with the music.
- Be sure the **Chord** button doesn't appear pressed in the **Lyrics** page to hide the chord symbols.

Chord transposition

When transposing the Song, chord symbols will usually be automatically transposed. However, be sure **Transpose** is activated on the **Player**.

Activate chord transposition on the Player

- 1 Go to the **Global > Tuning > Transpose Control** page.
- 2 Activate **Transpose** on the **Player**.

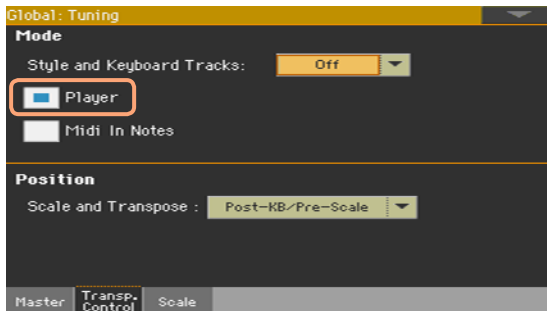

You might want to transpose the chords data in a MIDI Song, by using the **Transpose** edit function in **Sequencer** mode.

Reading the lyrics and chords loaded as a text file

If the text has been linked or loaded as a text (TXT) file, it will not scroll automatically while the Song is playing back. You can manually scroll it in one of the following ways.

Scroll the text on the display

- Scroll the text by using the VALUE controls or the vertical scrollbar.

Scroll the text with a footswitch or EC5 switch

- 1 Go to the **Global > Controllers > Foot** page, or the **Global > Controllers > EC5** page, and assign the **Text Page Next** commands to the footswitch or EC5 switch.
- 2 Return to the **Lyrics** page, and scroll the text by using the programmed footswitch or EC5 switch.

Scroll the text with a switch

- 1 Go to the **Style Play or Song Play > Pads/Switches > Switch** page, and assign the **Text Page Next** commands to one of the assignable switches.
- 2 Write the changes to the a Keyboard Set.
- 3 Return to the **Lyrics** page, and scroll the text by using the programmed assignable switch.

Please note that programming an assignable switch will tie the page scroll command to a particular Keyboard Set or SongBook Entry, dedicated to a particular Song based on an external text file. On the contrary, programming the footswitch or EC5 switch will offer a global option, that will not change when choosing a different Keyboard Set or SongBook Entry.

Loading a text file with the same name of the Song

Lyrics and chords may be contained in a TXT file having the same name of a MIDI Song or an MP3 Song. For example, if a 'MySong.txt' file exists in the same folder as the 'MySong.mid' file or 'MySong.mp3' file, loading this latter will load the TXT Lyrics file as well.

See **Creating text files (lyrics)** on page 369 for more information on how to create correctly formatted text files.

Linking text files to SongBook Entries

Lyrics and chords may be contained in a TXT file linked to a SongBook Entry. The same formatting rules described above apply. See [Linking text files to SongBook Entries](#) on page 90 for more information.

On-the-fly loading of Lyrics and chords from an external text file

When no lyrics or chords are contained or associated to the Style or Song, you can load a text (TXT) file after having chosen a Style or Song.

Load a TXT file on-the-fly

An empty Lyrics page with a message will appear when you press the LYRICS button in one of the following cases:

- You are in Style Play mode.
- The Song does not contain lyrics and chords.
- No external file is associated to the Style or the Song.

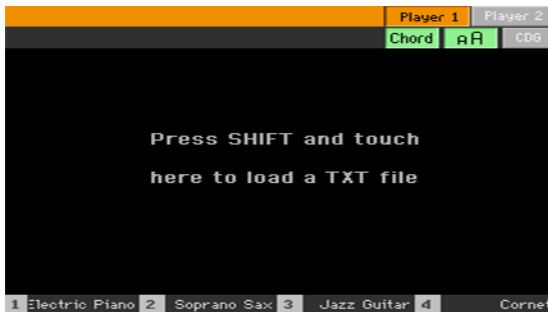

In this case, do the following:

- Keep the SHIFT button pressed and touch the center of the display. The file selector will appear, and will let you choose a TXT file to be loaded.

Reading the lyrics and chords loaded as a CDG file

CDGs are graphic files that change in time with the associated MP3 Song.

Read the lyrics and chords in the CDG file

- Be sure the CDG button appears pressed in the Lyrics page.

Loading a CDG file with the same name of the Song

Lyrics and chords may be contained into MP3 Songs as a CDG graphic file with the same name of an MP3 Song (MP3+G Song format). For example, if a “MySong.cdg” file exists in the same folder as the “MySong.mp3” file, loading this latter will load the CDG Lyrics file as well.

Moving through a Song with the markers

Using the markers

Song Marker events that might be contained in a MID file (that is, a MIDI Song) can be read by Pa4X. They are immediately shown in the Markers page.

Open the Markers page

- While in Song Play mode, press the MARKER button.

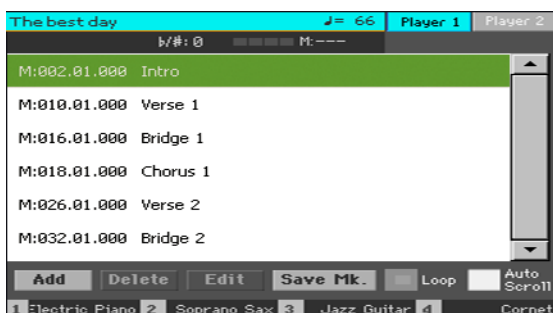

Jump to a marker

- 1 If you like, start the Player by pressing the PLAY/STOP (▶/■) button. You can jump to a marker even if the Player is not running.
- 2 When you want to jump to a marker, touch it in the markers list. At the beginning of the next measure, the Song will jump to the saved position.

Make the markers list scroll automatically

Select the Auto Scroll parameter, to let the markers list scroll automatically, and always let the current marker be shown in the display.

Loop the current section

You can use the markers to repeat a passage you need practicing.

- 1 Start the Player.
- 2 When you reach the beginning of the point you need practicing, touch the Add button to create a first marker.

Usually, you will create the marker one or two measures before the actual starting point.

- 3 When you reach the end of the point you need practicing, touch the **Add** button to create a second marker.
- 4 Select the first marker, then select the **Loop** checkbox to repeat (loop) between the first and second marker.
- 5 If you no longer need them, delete the markers. In any case, they will be automatically removed when choosing a different Song or turning off the instrument.

Creating and editing markers

You can add your own marker points to a MIDI Song, then save them into the MID file.

Open the Markers page

- While in Song Play mode, press the **MARKER** buttons.



Add markers

- 1 Start the Player by pressing the **PLAY/STOP** (▶/■) button.

Markers can be added even while the Player is not running, but adding them while the Song is running is easier.
- 2 When you reach the position you want to save as a marker, touch the **Add** button.
 - If you touch **Add** within the early beats of the measure, the beginning of the current measure is saved as a marker.
 - If you touch **Add** within the last beat of the measure, the beginning of the following measure is saved as a marker.

- 3 Do the same for any following marker.
- 4 Stop the Player by pressing the PLAY/STOP (▶/■) button.

Delete markers

- 1 Touch the marker to be deleted in the markers list.
- 2 Touch the Delete button to delete the selected marker.
- 3 Save the markers (as described below).

Edit the name and position of a marker

- 1 Touch the marker to be edited in the markers list.
- 2 Touch the Edit button to start editing the marker. The Edit Marker window will appear.

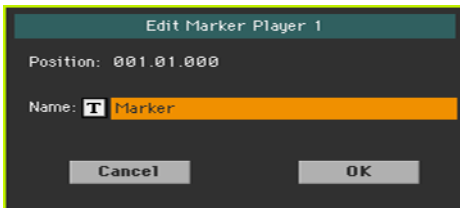

- 3 While in the Edit Marker window, edit the position and name of the selected marker.
- 4 Save the markers (as described below).

Save the markers

- Touch the Save Mk button to save all the markers into the MID file.
- If you are not in the Markers page, choose the Save Song Marker command from the page menu.

Reading the music score

Creating and reading the music score

Create the music score

- 1 Choose a MIDI Song to play with the selected Player.
- 2 Press the **SCORE** button to open the Score page. A score of the selected track will be generated.

Depending on the content of the track, either notes or chords are shown in the staff.

The screenshot displays a music score interface for the song "The best day". At the top, the song name "The best day" is shown, along with a tempo of 66 and two selected players, "Player 1" and "Player 2". The score is presented on two staves. The top staff shows a treble clef and a key signature of one sharp (F#). The bottom staff also shows a treble clef and a key signature of one sharp (F#). The lyrics are "Somebody's hardly said ___ Don't try ___ Sliding tables instead". Chord symbols are displayed above the notes: Gsus/D, D, Bm9, Bm9, Bm7, Asus/D, D, Gsus/D, D. The interface includes a "Current staff" indicator on the left, a "Lyrics" label pointing to the lyrics text, and a "View options" menu at the bottom left with options for "Lyrics", "Chord", "Note", and "Treble". A "Clef" menu is at the bottom center, showing "Treble". A "Selected track" menu is at the bottom right, showing "Play" and "Trk 1".

Choose a different track

- Choose a different track to be seen as music score by using the Trk menu. Usually, the melody is track #4.

Choose the clef

- Choose a different clef by using the Clef menu. Usually, the correct clef is automatically assigned by the score generator.

Clef	Meaning
Treble	Standard Treble clef.
Treble+8	Treble clef with transposition one octave upper.
Treble-8	Treble clef with transposition one octave lower.
Bass	Standard Bass clef.
Bass-8	Bass clef with transposition one octave lower.

Exit from the Score page

- When done with the score, press either the SCORE or the EXIT button.

Intelligent display of the score

Score generation is smart enough to 'clean-up' a track with automatic quantization, syncopation, key and clef generation. Even non-quantized tracks will be shown in a very readable way.

If a Key Signature event is found at the beginning of the Song (position '001.01.000' of the Song's Master track), the correct key signature is also shown.

Following the Song

You can always see where you are in the score by watching at these indicators:

- A red vertical line, showing indicating the current staff in play.
- A red triangle, showing the current position.

Showing lyrics, chords, note names

Read the Lyrics

- Touch the Lyrics button to make the lyrics (if available) appear or disappear.

Read the chords

- Touch the Chord button to make the chord symbols (if available) appear or disappear.

Read the note names

- Touch the Note button to make the note name appear or disappear next to each note.

Choosing the chords and note names language

Chords and note names are shown either according to the English (A, B, C...) or Italian (Do, Re, Mi...) system, depending on the selected language.

- Go to the Global > General Controls > Interface page, and use the Language parameter to change the language.

Muting the selected track

Mute the selected track

- Touch the Play/Mute ( / ) button to listen or mute the selected track.

Mute the track if you are going to play or sing it live. This will avoid overlapping between your playing or singing and the internal Sounds.

Saving the Play/Mute status

To make the Play/Mute status of the Song tracks permanent for all the subsequent MIDI Songs, write it to memory.

- Go to the Global > Mode Preferences > Song & Sequencer page, and choose the Write Song Play Track & FX command from the page menu.

Music score and transposition

The Score page shows the actual MIDI notes. Using the **TRANPOSE** buttons or transposing the selected track does not affect the music score.

11 Searching for files and other items

Using the Search function

Searching

Depending on the page, you can search for different types of data. For example, while in the Media pages you can only search for files, while in Style Play or Song Play mode you can search for several different types of data (Styles, Songs, Lyrics...).

The Search function is also available while the Keyboard Set, Sound, Style, Pad, Voice Preset, Sample, Multisample, Drum Sample or File Selector is open. It is not available in all pages, since sometimes there are no relevant data to search for a particular page (for example, the Global pages).

Access the Search window

- Press the SEARCH (🔍) button to open the Search window.

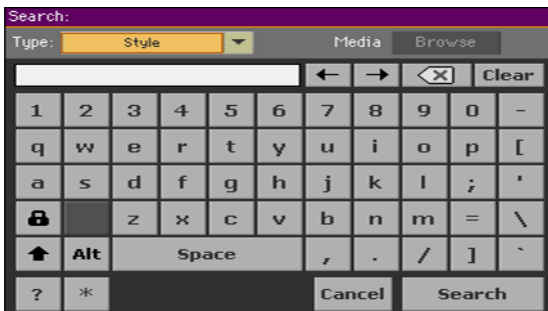

Choose the type of data to look for

- If needed, use the Type menu to choose the type of item you are looking for.



Choose a storage device and folder

When searching for Files, Songs or Lyrics, you can choose a storage device and folder where to focus your search. When one of the above types are chosen, the Browse button will be activated.

- 1 Touch the Browse button to open the File Selector.

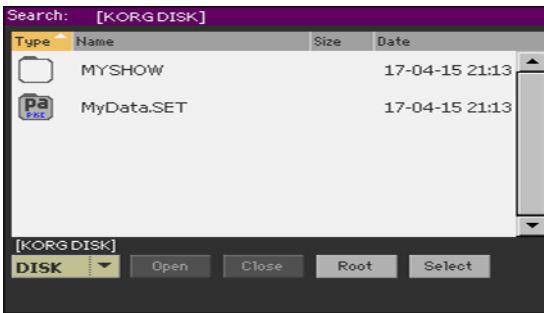

- 2 Use the Device menu to choose the storage device containing the file you are looking for. Use the Open and Close buttons to open and close the selected folders. Use the Root button to return to the top level of the device.
- 3 When you see the folder containing the file you are looking for, touch it, then touch the Select button to select it and close the File Selector. The name of the selected folder will be shown in the title bar of the Search window.

Type the name and start searching

- 1 Type the name of the item you are looking for. There is no difference between upper and lower cases (“LOVE” is the same as “Love” or “love”).

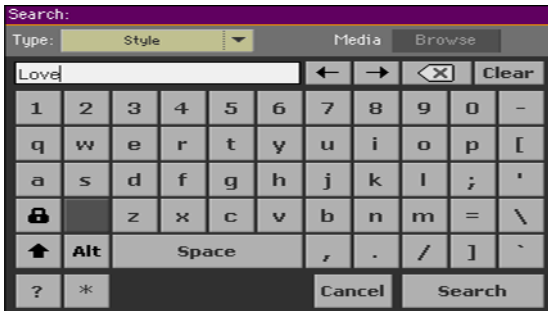

- 2 When finished entering the name, touch the Search button. After a while, the list of items found will start showing on the display.

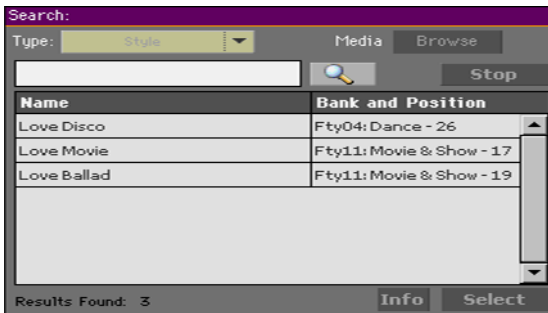

The time needed to complete a search depends on the type and size of the device(s) and the number of items.

Only one search at a time can be carried on. Please wait for the current search to be completed, or touch the Stop button to stop the current search and do a new one.

Stop the Search operation

- After you touch the Search button, its name changes to Stop. Touch this button to stop the ongoing search before all results are found. The name of the button will revert to Search. Any item found will remain on the display, until you do a new search.

Exit from the Search window without stopping the Search operation

- Touch the **Cancel** button in the display, or press the **EXIT** or **SEARCH** (🔍) button on the control panel, to exit from the Search window and carry on other operations. The search will continue in the background.

Ask info for an item

- Touch one of the items found to select it, then touch the **Info** button to see relevant information.

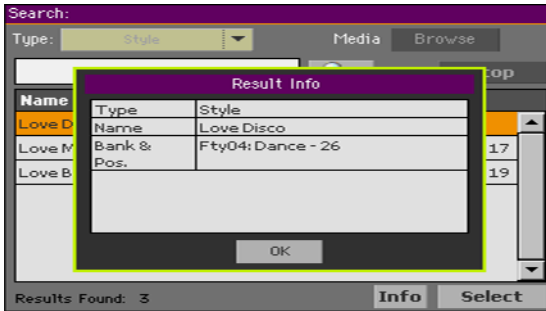

Touch **OK** to close the Info dialog.

Restart the Search operation

- Touch the **Search** (🔍) icon to return to the main Search page and start searching again.

Select the item found

- 1 If you have found what you were looking for, touch its name and then touch the **Select** command.
- 2 If you want to close the Search window without selecting anything, press the **EXIT** button. (When a window does not close by itself, it means the **Display Hold** is turned on. See **Display Hold** on page 44).

A note about searching: the wildcards

While searching, the string entered will be searched as a whole word or as part of a word. For example, if you entered “love”, the function will find “Love” and “LoveSong”, or any other word containing the string “love”.

You can use the wildcards “?” (any single character) and “*” (any sequence of characters) to search exactly for that string. For example, “*love” will find “MyLove”, but not “LoveSong”. “??love” will find “Mylove” but not “AllLove”.

Also, if you are looking for words that can be spelled in a slightly different way, you can use the “?” wildcard to find all occurrences; “gr?y” will find out both “gray” and “grey”.

PART III: SONGBOOK

12 Using the SongBook

Choosing the SongBook Entries

What is the SongBook?

The basic idea behind the SongBook is that you always start from a song. By choosing an Entry from the SongBook, you choose a template for that song. Everything you need (style, song, sounds, voice effects, lyrics, key, tempo value) is there at the touch of a single button.

In other words, the SongBook is the onboard music database, allowing you to organize the Styles and Songs for easy retrieving. Each Entry of this database (a 'song') may include information like the artist, title, genre, number, key, tempo, and meter (time signature) of a specified song. When choosing one of the Entries, the associated Style, MIDI or MP3 Song - as well as the Style Play or Song Play mode - is automatically recalled. The Master Transpose value is automatically set. A Voice Preset might also be recalled.

In addition to helping you organize your shows, the SongBook allows you to assign up to four Pads, and up to four Keyboard Sets to each Entry. Also, you can link a TXT file to any Entry, to be used as the Lyrics of a song, even if there are no Lyrics inside the associated MID or MP3 file, or if you prefer to play the song live with the backing of the Styles.

You can add your own Entries to the SongBook, as well as edit the existing ones. KORG already supplies some hundred Entries as standard. Furthermore, the SongBook allows you to create various Set Lists, that are collections of Entries that will suit your different types of show, and you can choose with the dedicated buttons on the control panel.

Internal and Direct SongBook

In addition to the internal SongBook, residing in your Pa4X, you can also choose Entries and Set Lists from an external, Direct SongBook, that will extend your internal database on the fly. How to select it is explained in [Creating the Direct SongBook](#) on page 913.

Choosing the SongBook Entries from the Book list

A large database is already included with the instrument. You may browse through this database and choose a SongBook Entry.

Choose a SongBook Entry

- 1 While you are in Style Play or Song Play mode, press the SONGBOOK button to open the Book page.



- 2 Browse through the Entries.

Use the scrollbar or the VALUE controls to scroll.

Keep the SHIFT button pressed and touch one of the arrows of the scrollbar to jump to the previous or next alphabetical section.

- 3 When the Entry you are looking for appears in the display, touch it to assign it to the Arranger or the Player.

After choosing the Entry, its name will appear just under the title bar (N:), next to the name of the associated Style or Song. The name of the Entry in the list will appear highlighted.





The associated Style or Song will be recalled. The Song will be assigned to Player 1, unless it is already playing (in this case, it will be assigned to Player 2).

Pads and Keyboard Sets will also be recalled. Keyboard Set #1 will be selected. Any TXT file associated with the Entry will be shown in the Lyrics page. A Voice Preset will also be recalled.

- 4 Use the **START/STOP** or **PLAY/STOP** (▶/■) button to start and stop playback of the selected Style or Song.

Identifying the type of Entry

The icons in the Type column will help you identify the Entry.

Type	Meaning
	Style-based Entry. When chosen, it will select a Style and switch to the Style Play mode.
	MIDI Song-based Entry. When chosen, it will select a Song and switch to the Song Play mode.
	MP3 Song-based Entry. When chosen, it will select a Song and switch to the Song Play mode.

Sorting by label/column

On top of the list you can find some labels, each one corresponding to a column of data (Type, Name, Genre, Key, Bpm, Meter...). You can choose one of the labels to sort the list according to that type of data.

Change the order of the list

- Reorder the items according to a different criterion (Type, Name, Genre, Key, Bpm, Meter...) by touching the corresponding label on top of the list.
- By touching the label again, the order of the items will switch between ascending and descending.

Choosing the columns seen in the page

Due to space constraints, not all labels can be seen on top of the lists. You can decide what to show in the SongBook lists.

Please note that the Artist and Key fields of all the supplied Entries have been intentionally left empty.

Choose one of the label combinations

- 1 Choose the Preferences command from the page menu to open the Preferences dialog.

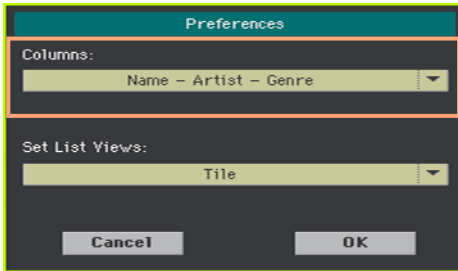

- 2 Use the Columns menu to choose the set of columns to be shown.
- 3 When done, touch the OK button to close the dialog.

Filtering the Entries

When you are looking for a particular artist, genre or other categories, you may 'filter' the list to only see the type of Entries you are looking for. Please note that you can also find items inside the SongBook database by pressing the SEARCH button on the control panel, but while the Search function only searches for names, the Filter function allows for a more refined search on multiple parameters at the same time.

Open the Filter dialog

- While in the SongBook > Book page, touch the Filter... button to open the Filter dialog.

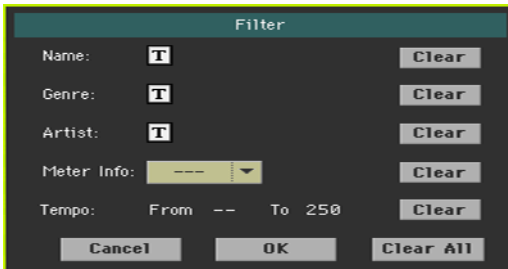

Edit the filter criteria and activate the filters

- 1 Touch the Text Edit (**T**) icon next to the field you want to edit, to open the virtual keyboard and type the text string you are looking for.

For example, you may want to find all songs containing the word 'love' in the title (in any position in the string). If so, select the Name criterion, and enter the word 'love'. Capitals are not relevant for the search.

When done editing the name, confirm by touching the OK button under the virtual keyboard.

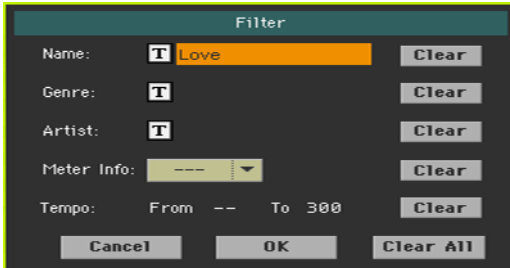

- 2 Repeat the above step for all the fields you want to include in your filter.
- 3 If you like, select a Meter and/or a range of Tempo values to be included in your filter criteria.

Delete the filter criteria you don't need

- Touch the Clear button to delete the text string or reset the parameter to a default value.
- Touch the Clear All button to reset all filter criteria.

Confirm the filters

- When done editing the filter parameters, touch the OK button to close the Filter dialog and return to the Book page.

The Filtered checkbox will be automatically selected, and the filter will be activated. Only the Entries matching the entered criteria will be seen in the Book list.



Remove the filters and see all the Entries again

- Touch the Filtered checkbox to deselect it.

Getting information on the SongBook Entries

You can see some statistical information on the selected SongBook Entry, to see the name of the Entry, the associated Style or Song, the total number of Entries in the SongBook database, the number of filtered Entries in the Book page, the number of available Set Lists, and the number of Entries in the selected list.

- 1 While in the SongBook, choose an Entry.
- 2 Go to the SongBook > Info page.

If you selected a Style-based Entry:

Name of the selected Entry	→	N: A nite in Tunisi						
Associated Style	→	Style: Afro-Cuban Jazz						
		Songs: 384						
		Songs after filtering: 384						
		Set Lists: 10						
		Songs in current Set List: 77						
		<table border="1" style="width: 100%; text-align: center;"> <tr> <td>Book</td> <td>Write</td> <td>Tags</td> <td>Controls Lyrics</td> <td>Set List</td> <td>Info</td> </tr> </table>	Book	Write	Tags	Controls Lyrics	Set List	Info
Book	Write	Tags	Controls Lyrics	Set List	Info			

If you selected a Song-based Entry:

Name of the Entry assigned to Player 1	→	N: The best day	P1: The best day	→	Song assigned to Player 1						
Name of the Entry assigned to Player 2	→	N: - - -	P2: LoveSong	→	Song assigned to Player 2						
		Songs: 519									
		Songs after filtering: 519									
		Set Lists: 6									
		Songs in current Set List: 25									
		<table border="1" style="width: 100%; text-align: center;"> <tr> <td>Book</td> <td>Write</td> <td>Tags</td> <td>Controls Lyrics</td> <td>Set List</td> <td>Info</td> </tr> </table>		Book	Write	Tags	Controls Lyrics	Set List	Info		
Book	Write	Tags	Controls Lyrics	Set List	Info						

If the Selected Entry (N:) area is blank (---), the selected Entry has been modified, or no Entry has been selected.

Choosing the SongBook Entries by Song Number

You can select a SongBook Entry by entering its unique Song ID Number. Numbers associated with each Entry can be programmed in any of the SongBook Entry edit pages. (See [Editing the Song Selection Number](#) on page 126 for more information).

To help you find a SongBook Entry by ID number, you can export a song list using the **Export as Text File** command from the page menu, and print it.

- 1 To see the numbers while in the Book page, be sure the Num column is shown.

If it is not shown, choose the **Preferences** command from the page menu, then use the **Columns** menu to choose one of the options including the Num column.

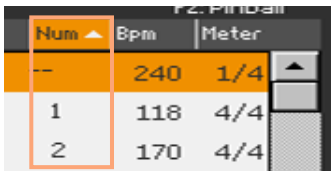

Num	Bpm	Meter
--	240	1/4
1	118	4/4
2	170	4/4

- 2 To select a SongBook Entry by entering its ID number, press the **SONGBOOK** button again while you are in any page of the SongBook. The numeric keypad will appear, allowing you to enter the ID number corresponding to the desired Entry.
- 3 If a Direct SongBook has been selected, and the same number exists in both lists, you are asked to choose between the **Internal** and **Direct** SongBook. Choose an option and touch **OK** to confirm.

Choosing the SongBook Entries via MIDI

SongBook Entries can be remotely selected via MIDI. In addition, MIDI messages can be sent via MIDI when choosing a SongBook Entry. This is useful to synchronize Pa4X to an external editor or digital music sheet reader (for example, a dedicate app running on a tablet).

Choosing the Tablet MIDI Preset

The **Tablet MIDI Preset** programs MIDI channel #16, so that it is used to send MIDI messages when selecting the SongBook Entries, or to receive MIDI messages to selecting them from an external device.

- Go to the **Global > MIDI > General Controls** page and choose the **Tablet MIDI Preset**.

Editing an existing MIDI Preset

You can program or edit your own MIDI Preset for selecting SongBook Entries. A special MIDI channel used as the Control channel is needed to send MIDI messages to select the SongBook Entries, or to receive MIDI messages when selecting them.

Configure the Control channel

- 1 Go to the **Global > MIDI > General Controls** page and choose a MIDI Preset to be used as a starting point.
- 2 Go to the **Global > MIDI > Midi In Channel** page, and assign the Control option to one of the sixteen available MIDI channels (usually one of the higher-numbered ones, for example #16).
- 3 Go to the **Global > MIDI > Midi Out Channel** page, and assign the Control option to one of the sixteen available MIDI channels (the same as on the MIDI IN will work fine).
- 4 When done, save these settings to a new or existing MIDI Preset, by choosing the **Write Midi Preset** command from the page menu.

Selecting SongBook Entries via MIDI

When you are ready to remotely select SongBook Entries, switch to the Style Play or Song Play mode.

At this point, Pa4X must receive on the special Control channel the NRPN Control Change messages #99 (MSB, with value 2) and #98 (LSB, with value 64) in fast succession, as an initialization string. This string must be sent only once, unless another NRPN control is sent on the same MIDI channel before selecting a different SongBook Entry.

After the initialization string has been sent, you must send the selection string, made of two Control Change messages: CC#06 (Data Entry MSB) for the thousands and hundreds, and CC#38 (Data Entry LSB) for the tens and units. The range of the Data Entry controls, in this case, is 0~99 (instead of the typical 0~127).

The following examples show some typical situations.

- Send the following string to select SongBook Entry #77:

Data 1	Data 2	
NRPN MSB	2	Initialization string (CC#99, 98)
NRPN LSB	64	
DataEnt MSB	0	Thousands and hundreds (00xx)
DataEnt LSB	77	Tens and units (xx77)

- Send the following string to select SongBook Entry #100:

Data 1	Data 2	
NRPN MSB	2	Initialization string (CC#99, 98)
NRPN LSB	64	
DataEnt MSB	1	Thousands and hundreds (01xx)
DataEnt LSB	0	Tens and units (xx00)

- Send the following string to select SongBook Entry #2563:

Data 1	Data 2	
NRPN MSB	2	Initialization string (CC#99, 98)
NRPN LSB	64	
DataEnt MSB	25	Thousands and hundreds (25xx)
DataEnt LSB	63	Tens and units (xx63)

Sending MIDI messages when selecting SongBook Entries

When the special Control channel is assigned to one of the MIDI OUT channels, MIDI messages are sent on this channel when choosing a SongBook Entry. The messages sent when selecting a SongBook Entry are the following:

- An initialization string, made of the NRPN Control Change messages #99 (MSB, with value 2) and #98 (LSB, with value 64) in fast succession.
- A selection string, made of the two Control Change messages CC#06 (Data Entry MSB) for the thousands and hundreds, and CC#38 (Data Entry LSB) for the tens and units. The range of the Data Entry controls, in this case, is 0~99 (instead of the typical 0~127).

Using the Set Lists

What are the Set Lists?

Set Lists are selections from the full Book list. They allow for smaller, customized lists, suitable for a single gig or your own music preferences. We already included some example lists, that you can use for your own shows.

Choosing either the Tile View or List View

Set Lists can be used in Tile View or in List View. In Tile View, songs are shown as pages of tiles, and assigned to the SET LIST buttons on the control panel. In List View, all songs are shown in a plain list.

Switch between Tile View and List View

- 1 While in any SongBook page, choose the Preferences command from the page menu to open the Preferences dialog.

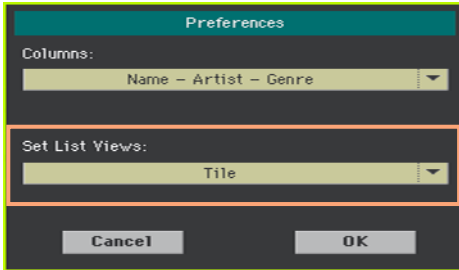

- 2 Use the Set List Views menu to switch between the Tile View and List View.
- 3 When done, touch the OK button to close the dialog.

Playing a Set List from the Tile View

The Tile View shows the selected Set List as a set of songs assigned to the SET LIST buttons on the control panel. Each tile in the display corresponds to the same numbered button.

Select the Set List

- 1 Go to the SongBook > Set List page. You can press the SET LIST button to open this page.

- Be sure you are in Tile View, otherwise choose the Preferences command from the page menu to open the Preferences dialog, and select it.

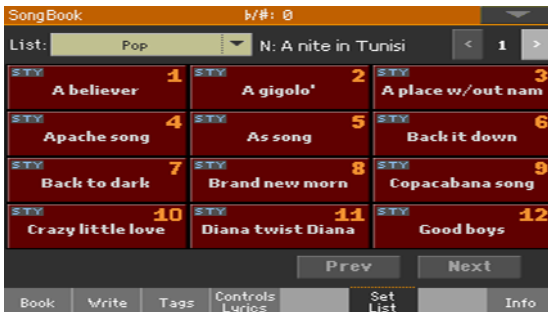

- Use the List pop-up menu to select one of the available Set Lists. The songs in the selected set are assigned to the SET LIST buttons on the control panel.

Choose a page

The songs in the selected Set List are organized in 'pages' of twelve (each page matches the SET LIST buttons).

- Use the page indicator in the top right corner of the page to go to a different page inside the selected Set List.



Choose the Set List from the control panel

- Be sure the SET LIST indicator is turned on.
- Use the SET LIST buttons to choose the corresponding song from the selected Set List page.

Songs are assigned to the buttons whose indicator is turned on. Each row of tiles corresponds to a group of three buttons. The indicator on the selected song blinks.

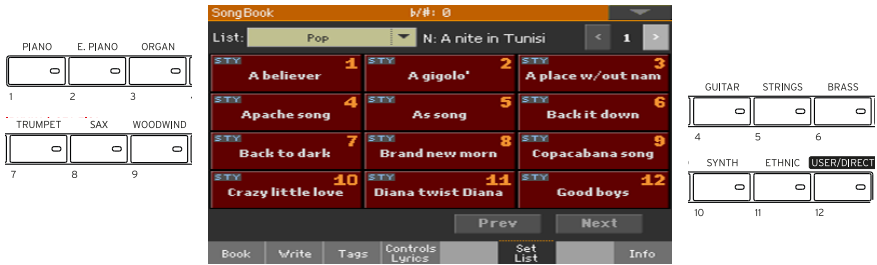

Indicator status	Meaning
Off	No song assigned.
On	Song assigned.
Blinking	Song selected.

Choose the Set List from the display

- 1 Be sure you are in the SongBook > Set List page.
- 2 Touch one of the tiles in the display, to choose the corresponding song.

Play the Set List

- 1 Use the START/STOP or PLAY/STOP (▶/■) button to start and stop playback of the selected Style or Song.
- 2 Use the standard Arranger or Player controls to start, pause or stop the Styles or Songs, or to fast forward and rewind the Songs.
- 3 Move to the previous or next song by touching the Prev(ious) or Next button. Move to any other song by pressing a different SET LIST button, or by touching a different tile.

Playing a Set List from the List View

The List View shows the selected Set List as a plain list of songs.

Select the Set List

- 1 Press the SET LIST button to open the SongBook > Set List page.
- 2 Be sure you are in List View, otherwise choose the Preferences command from the page menu to open the Preferences dialog, and select it.



- 3 Use the List pop-up menu to select one of the available Set Lists.

The list of songs in the selected Set List will appear. (Contrary to the Tile View, the songs are NOT assigned to the SET LIST buttons on the control panel.)

Play the Set List

- 1 Browse through the Entries in the list.
- 2 Touch the name of the Entry you want to start from to assign it to the Arranger or the Player.
- 3 Use the START/STOP or PLAY/STOP (▶/■) button to start and stop playback of the selected Style or Song.
- 4 Use the standard Arranger or Player controls to start, pause, stop, fast forward and rewind the Styles or Songs.
- 5 Move to the previous or next song by touching the Prev(ious) or Next button. Move to any other song by touching a different Entry in the list.

13 | Editing the SongBook

Creating and editing the SongBook Entries

Creating a new SongBook Entry

You can add your own Entries to the SongBook database.

Choose the Style or Song

- 1 Go to the Style Play or Song Play mode, depending on the type of Entry you want to add to the SongBook database.
- 2 Select the Style or Song to be added to the SongBook.

Assign the Song to Player 1 (only Songs assigned to Player 1 will be saved to the SongBook Entry).

Choose the Sounds, the Effects and the Pads

- Choose the Keyboard Sounds, the Effects, the Pads, and adjust any relevant parameter the way you prefer for your performance.

A snapshot of the current situation will be saved into the Entry. Keyboard and Accompaniment Sounds and Effects, Volume levels, Play/Mute status, the Split status and position, the Octave and Master Transpose, the selected Style Element, the selected Keyboard Sets and Pads, the Voice Preset (and its Global status) will be saved in the Entry.

The current Keyboard Sounds and their settings will become Keyboard Set #1.

Please note that changes to a MIDI Song's Sounds will not be saved in the SongBook Entry. Only the data included in the MID file will be used. To edit the Song, edit the MID file in Sequencer mode.

Create a new SongBook Entry

- 1 Keep the **SONGBOOK** button pressed for about one second to create a new SongBook Entry. The Write Song dialog will appear.

As an alternative, go to one of the SongBook Entry edit pages, and touch the New Song button, then the Write button.

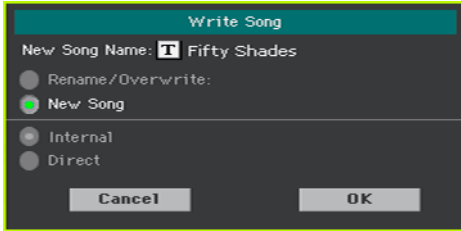

- 2 While in the Write Song dialog, touch the Text Edit (**T**) icon if you want to edit the name of the Entry, then touch OK to save the Entry to the SongBook database.

Editing an existing SongBook Entry

Choose an existing SongBook Entry

- 1 Choose a SongBook Entry from the SongBook > Book or SongBook > Set List page.



Change the Sounds, the Effects and the Pads

- Press the EXIT button to exit the SongBook, and choose different Keyboard Sounds, Effects and Pads. Adjust any relevant parameter the way you prefer for your performance. Choose a different Voice Preset if you like, and select the Global checkbox if you want to use the Global preset.

Save over the existing SongBook Entry

- 1 Go to one of the SongBook Entry edit pages, and touch the Write button to save the settings into the selected SongBook Entry.



Touch to Write the SongBook Entry

- 2 Choose the Rename/Overwrite option to write over the selected Entry. If you prefer to create a new Entry, choose the New Song option instead.

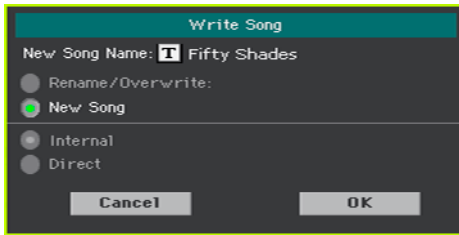

- 3 If you want to change the Entry's name, while in the Write Song dialog touch the Text Edit (**T**) icon, then touch OK to save the Entry to the SongBook database.

Saving different Styles or Songs

With each SongBook Entry, a reference to a Style or Song is saved. When editing an Entry, you can change it with a different Style or Song.

- 1 Choose the SongBook Entry to be edited.
- 2 Go to the SongBook > Write page, and touch the Style/Song > Select button to open the Style Select or Song Select window.

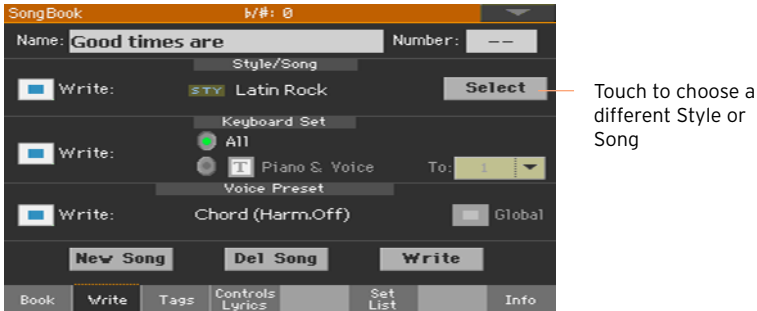

- 3 Choose a different Style or Song.

The Style/Song area will show the Style or Song you just selected.

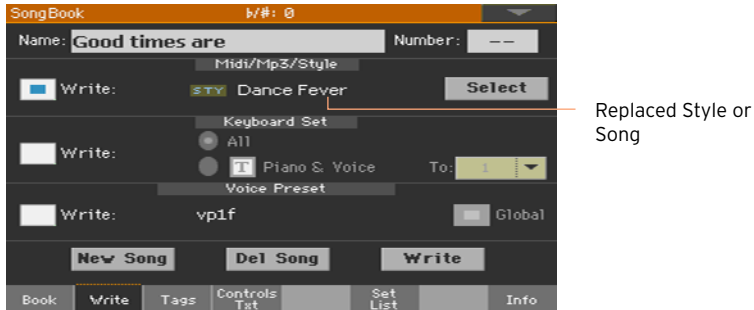

- 4 Be sure the Style/Song > Write checkbox is selected, to save the new Style or Song and replace the older one.
- 5 If you don't want to replace the Keyboard Sets or Voice Preset, be sure the other Write checkboxes are not selected.
- 6 Touch the Write button to save over the existing SongBook Entry.

Saving different Keyboard Sets

With each SongBook Entry, up to four Keyboard Sets are saved. When editing an Entry, you can replace the older Keyboard Sets with new ones.

- 1 Choose the SongBook Entry to be edited, and press the EXIT button to exit the SongBook.
- 2 Edit the Keyboard Sounds.
- 3 Go to the SongBook > Write page.



- 4 Select the Keyboard Set > Write checkbox to save the new Keyboard Sets instead of the older ones.
- 5 Choose a single Keyboard Set location to save the Keyboard Sounds to the selected Keyboard Set inside the SongBook Entry. After choosing the target location you can give the Keyboard Set a new name.
- 6 If you don't want to replace the Style or Song, or the Voice Preset, be sure the other Write checkboxes are not selected.
- 7 Touch the Write button to save over the existing SongBook Entry.
- 8 If you want to save more Keyboard Sets, repeat the above procedure for the other Keyboard Set locations inside the SongBook Entry.

Saving a different Voice Preset

With each SongBook Entry, a reference to a Voice Preset is saved. When editing an Entry, you can replace it.

- 1 Choose the SongBook Entry to be edited, and press the EXIT button to exit the SongBook.
- 2 Go to the Style Play/Song Play > Mic pane and choose a Voice Preset. Select the Global checkbox if you want to use the Global preset.

- Go to the SongBook > Write page. You will see the Voice Preset has been replaced.



- Select the Voice Preset > Write checkbox to save the new Keyboard Sets instead of the older ones.
- If you don't want to replace the Style or Song, or the Keyboard Sets, be sure the other Write checkboxes are not selected.
- Touch the Write button to save over the existing SongBook Entry.

Saving different Pads

With each SongBook Entry, a reference to four Pads is saved. When editing an Entry, you can save or replace the selected Pads.

- Choose the SongBook Entry to be edited, and press the EXIT button to exit the SongBook.
- Go to the Style Play/Song Play > Pads pane to choose up to four Pads.
- Go to the SongBook > Write page.
- If you don't want to replace the Style or Song, the Keyboard Sets, or the Voice Preset, be sure the Write checkboxes are not selected.
- Touch the Write button to save over the existing SongBook Entry.

Editing the Song Selection Number

Each SongBook Entry can have a unique ID number (up to 9,999). You can type them to quickly recall an Entry (see [Choosing the SongBook Entries by Song Number](#) on page 113 for more information).

To help you find a SongBook Entry by ID number, you can export a song list using the Export as Text File command from the page menu, and print it.

Edit the Song Selection Number

- Go to the SongBook > Write page (or any other SongBook Entry edit page), and edit the Number field.



Assigning a number is not mandatory, but may help in organizing the Entries. For example, you may use the different 100s to create a different way of categorizing your entries by genre or age.

Editing the database tags

The SongBook is a database. You can add to each SongBook Entry special archival data, or tags, that will later help in retrieving specific types of songs by using the SongBook > Book > Filter function.

- 1 Choose the SongBook Entry to be edited.
- 2 Go to the SongBook > Tags page.

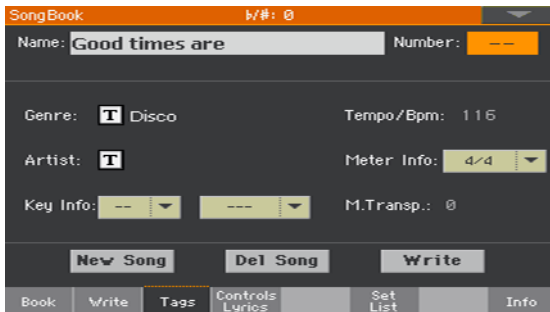

- 3 Edit the SongBook Entry's database tags.

Tag	Style-based Entry	MID-based Entry	MP3-based Entry
Genre	Music genre associated with the Entry.		
Artist	Name of the artist of the song associated with the Entry.		
Key Info	Original key of the Entry. The first field is the Root, the second one is the Major/minor mode.		
Tempo/BPM	Song's Tempo. This may change, if a Tempo Change event is included within the associated resource. You can manually change this value by using the TEMPO buttons on the control panel. Any change will only be shown after saving the Entry.		
	Original Tempo of the Style.	Original starting Tempo of the MID file.	Always zero (original Tempo of the MP3 Song).
Meter Info	Song's Meter (or 'Time Signature'). This may change, if a Meter Change event is included within the associated resource.		
M.Transp. (Master Transpose)	Song's Master Transpose value. When the Entry is selected, the Master Transpose of the whole instrument is automatically changed. The Master Transpose value saved in the SongBook Entry overrides any Master Transpose setting contained in the associated resource. You can manually change this value by using the TRANSCOPE buttons on the control panel. Any change will only be shown after saving the Entry.		

- 4 Touch the Write button to save over the existing SongBook Entry.

Editing the Style controls (Synchro/Memory)

With Style-based Entries, you can memorize the status of the Style's Synchro and Memory function status.

- 1 Choose the SongBook Entry to be edited.
- 2 Go to the SongBook > Controls/Lyrics page.



- 3 Edit the SongBook Entry's Style controls.

Syncro Start / Synchro Stop / Memory status	Meaning
Unchanged	When choosing this SongBook Entry, the status of the corresponding function will be left unchanged.
Off	When choosing this SongBook Entry, the status of the corresponding function will be turned off.
On	When choosing this SongBook Entry, the status of the corresponding function will be turned on.

- 4 Touch the Write button to save over the existing SongBook Entry.

Linking a text file to the SongBook Entry

You can add Lyrics to any Entry as a linked TXT file. Since there is no automatic synchronization between this type of Lyrics and the associated Style or Song, you must scroll them manually (as explained in [Reading the Lyrics and chords loaded as a text file on page 89](#)).

Link Lyrics as a TXT file

- 1 Choose the SongBook Entry to be edited.
- 2 Go to the SongBook > Controls/Lyrics page.

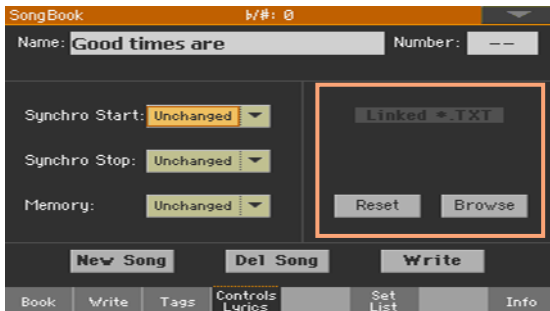

- 3 Touch the Browse button to open the file selector, and choose a TXT file to be linked to the current SongBook Entry.

After selection, the name of the linked text file will appear in the Linked *.TXT area.

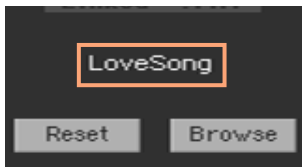

Unlink the TXT file

- While in the same page, touch the Reset button.

Deleting a SongBook Entry

- 1 While in the SongBook > Book page, select the song to be deleted.
- 2 Go to any of the SongBook Entry edit pages, and touch the Del Song button to delete the selected song.

Creating and editing the Set Lists

Enabling Set List editing

Editing the Set Lists is not usually available, to protect Set Lists from accidental changes.

Enable Set List editing

- While in the SongBook, select the Enable Set List Edit command from the page menu.
- If you will prefer to protect the Set Lists again after editing, deselect the Enable Set List Edit command from the menu.

When the list can be edited, a new set of buttons will appear at the bottom of the page.

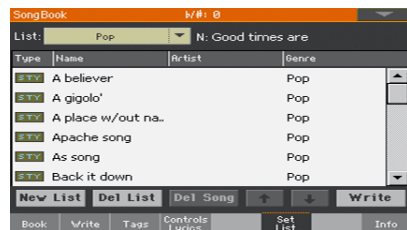
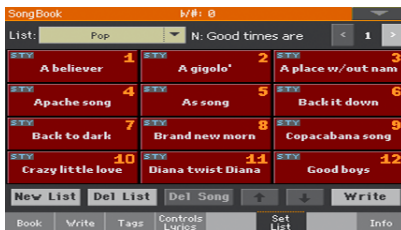

Creating or editing a Set List

Create a new, blank Set List

- 1 Go to the SongBook > Set List page, then touch the New List button.
- 2 If a Direct SongBook has been selected, you are asked to choose between the Internal and Direct SongBook. Choose an option and touch OK to confirm.

The Internal Set Lists will use Internal Entries, while the Direct Set Lists will only use Direct Entries. This way, the list will always find the associated Entries.

The new list will be automatically selected.

Select a Set List for editing

- 1 Go to the SongBook > Set List page. Choose either the List View or Tile View.
- 2 Use the List pop-up menu to select the Set List to edit.



Add Songs to the selected Set List

- 1 Go to the SongBook > Book page.
- 2 Browse through the songs in your SongBook database.
- 3 When you see the song you are looking for, touch it, then touch the Add to list button to add it to the selected Set List.





Move or delete songs from the selected Set List

- 1 Go to the SongBook > Set List page, and touch the song you want to move or remove from the list.





- 2 Edit the list.

- Use the Move > Down () and Move > Up () buttons on the display to move the selected Song to a different position in the list.
- Touch the Del Song button to delete the selected song from the Set List (the song will not, however, be deleted from the Book list).

Save the Set List

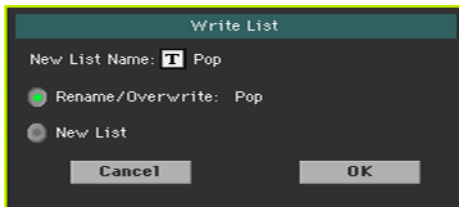
- 1 While in the SongBook > Set List page, touch the Write button to open the Write List dialog.



- 2 While in the Write List dialog, touch the Text Edit () icon if you want to assign the Set List a new name. When done editing the name, confirm by touching the OK button under the virtual keyboard.
- 3 Choose the Rename/Overwrite option to write over the selected Set List. If you prefer to create a new Set List, choose the New List option instead.
- 4 Touch the OK button to confirm saving.

Deleting a Set List

- 1 While in the SongBook > Set List page, use the List pop-up menu to select the Set List to delete.
- 2 Touch the Del List button to delete the selected Set List (the songs it contains will not be deleted from the Book list).

Deleting all the SongBook Entries and Set Lists

You may want to create you own Book list, removing all the default Entries and Set Lists.

- 1 Go to any of the SongBook pages.
- 2 Choose the **Initialize SongBook** command from the page menu, and confirm.

Please note that this operation will permanently delete all the Entries and the Set Lists. To restore the original factory data, use the **Factory Restore** command in the **Media > Utility** page, and only select the SongBook.

Using the SongBook with a personal computer

Additional software has been created to work together with the SongBook.

Editing the SongBook with SongBook Editor

You can use KORG's own SongBook Editor to edit single Entries, the SongBook database and the Set Lists on a Windows PC. With SongBook Editor you can comfortably view and edit a SongBook file on your PC.

Using a tablet as a SongBook extension

You can synchronize Pa4X to an external editor or digital music sheet reader (like BauM Software's SongBook+ for the iPad or ZuberSoft's MobileSheets for Windows and MobileSheetsPro for Android). Please refer to the developer's documentation for further information about these software applications.

**PART IV:
CUSTOMIZING
AND EDITING
THE SOUND
SETS**

14 Customizing the Keyboard Sets

Playing different Sounds with the left and right hand

Splitting the keyboard

Split the keyboard into a Lower (left hand) and Upper (right hand) part

- Press the **SPLIT** button on the control panel to light up its indicator. The keyboard will be divided into a Lower (left hand) and Upper (right hand) part.



Remove the split and play the Upper Sounds over the full keyboard range

- Press the **SPLIT** button again to turn its indicator off. The Upper Sounds will play on the full keyboard range, as in an acoustic piano.



Split, Keyboard modes, Sounds

When changing the SPLIT status, the number of Sounds you hear may change.

SPLIT indicator	Keyboard mode	Left hand (Lower) Sounds	Right hand (Upper) Sounds
Off	Full	No Lower Sound	Up to three Upper Sounds assigned to the full extension of the keyboard
On	Split	A single Lower Sound assigned to the left hand	Up to three Upper Sounds assigned to the right side of the keyboard.

Changing the local (or temporary) split point

You can choose a different point where the keyboard is split into an Upper and a Lower part. This is called the split point.

Change the local (or temporary) split point from the control panel

- 1 Keep the SPLIT button pressed to open the Split Point dialog.

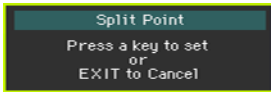

- 2 Play the lowest note of the Upper (right hand) part on the keyboard.

Change the local (or temporary) split point from the display

- 1 While in the Main page, touch the Split tab to see the Split pane.



- 2 Touch the keyboard diagram in the display, then play the lowest note of the Upper (right) part on the keyboard.

As an alternative, touch the Split Point parameter to select it, and use the VALUE controls to select the new split point.

When you change the split point, the Global parameter is automatically de-selected (see 'Global' and 'local' (or temporary) split point on page 142).

Memorize the local split point

The local split point can be memorized into a Keyboard Set. Each Keyboard Set associated to a Style or SongBook Entry can have a different split point.

- Write the changes to a Keyboard Set.

Changing the global split point

The global split point is both the general setting you use when there is no 'local' split, and a 'template' from which to start setting the various local split points saved into the Keyboard Sets. You can change it and use it as the main split point of the instrument. Some Keyboard Sets might override the global split point with their memorized local split points.

Change the global split point

- 1 Go to the Global > Mode Preferences > Style page.

As an alternative, keep the SHIFT button pressed and press the STYLE PLAY button to open the Style page.



- 2 Touch the keyboard diagram in the display, then play the lowest note of the Upper (right hand) part on the keyboard.
As an alternative, touch the Split Point parameter to select it, and use the VALUE controls to select the new split point.
- 3 Press the EXIT button to return to the previous page.

'Global' and 'local' (or temporary) split point

You can choose a 'global' split point that is not changed when choosing a different Keyboard Set. Or you can choose a 'local' split point that is better suited to the individual Keyboard Set, and can change when selecting it. The 'local' split point is just temporary, and only becomes permanent when you write a Keyboard Set.

To change the type of split point, select or deselect the Global parameter in the Split Point dialog.



Global Split	Split type	Meaning
On (Selected)	Global	Leave this box checked to use the global split point. This is the general setting from which you can start programming the local settings.
Off (Deselected)	Local	This box is automatically deselected when you start programming a local split point in the Main page. The local split point can be written into a Keyboard Set. Use it when you need a particular split point for a particular Sound set.

Parts, tracks, channels

On the keyboard, Sounds are assigned to one of the keyboard parts (Upper, Lower). Linked to a part there is a track. In Styles and MIDI Songs, Sounds are directly assigned to tracks. Tracks are the equivalent of recorder tracks (with the associated mixer channels). In fact, Pa4X does include a recorder and a digital mixer!

Keyboard Parts	Rec/Seq Tracks	Mixer Channels
Upper <small>1,2,3</small>	→ Upper <small>1,2,3</small>	→ Upper <small>1,2,3</small>
Lower	→ Lower	→ Lower
	→ Accomp. <small>Bs,Dr,Acc1...5</small>	→ Accomp. <small>Bs,Dr,Acc1...5</small>
	→ Song <small>1,2,3...16</small>	→ Song <small>1,2,3...16</small>

Playing two or three Sounds at the same time

You can play up to three layered Sounds on the keyboard. This is useful to add, for example, a layer of Strings or Synth Pads to a Grand Piano sound. The Sounds will be assigned to the Upper part of the keyboard.

When the SPLIT button indicator is turned off (Full Keyboard mode), the Upper parts will play on the full range of the keyboard, as it happens on an acoustic piano. Otherwise (Split Keyboard mode), you will play the Upper Sounds with the right hand.

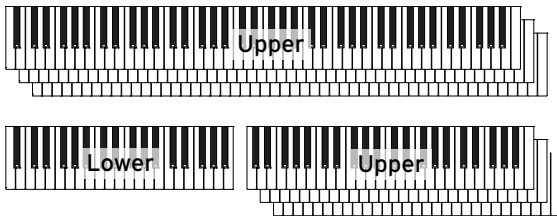

Turn a Sound on or off from the control panel

- Use the ON/OFF buttons in the KEYBOARD SOUNDS section to turn the corresponding Sounds on or off.

Turn the selected Sound on or off from the display

- If the Sound you want to mute is in Play, touch the Play/Mute icon to set it to Mute.



- If the Sound you want to hear is in Mute, touch the Play/Mute icon to set it to Play.



Memorize the Sound status

- Write the changes to a Keyboard Set.

Choosing different Sounds

You can assign different Sounds to the keyboard. The new combination of Sounds can then be written into a Keyboard Set.

Follow the same procedure when choosing Sounds for the other Sound sets (Accompaniment and MIDI Song tracks, that can be written into the Style Settings or a MIDI Song).

Open the Sound Select window from the control panel

- Press the **KEYBOARD SOUNDS > SELECT** button corresponding to the Sound you want to change.

Open the Sound Select window from the display

- 1 Be sure to be in the main page of the Style Play or Song Play mode. If you are not there, press either the **STYLE PLAY** or the **SONG PLAY** buttons in the control panel.
- 2 Touch the name of the Sound you want to change to select it.
- 3 Touch a second time the name of the Sound you want to change.

Choose a Sound

- 1 Browse through the Sounds in the Sound Select window.



- To choose one of the available types of Sound, touch the buttons at the top of the window.

Type of Sound	Meaning
Factory	Standard Pa4X Sounds, that cannot normally be modified. These are the richest, most modern Sounds of the whole collection.
Legacy	Legacy Sounds allowing for greater compatibility with older Pa-Series instruments.
GM/XG	Sounds allowing for full compatibility with MIDI Songs based on General MIDI and XG Sounds and Drum Kits.
User	Locations where you can load new Sounds and Drum Kits from an external device, or save new or edited Sounds and Drum Kits.

- To choose a different group of Sounds, touch one of the tabs on the sides of the window.
 - To choose one of the available pages in the selected Sound group, touch one of the P1...Px tabs at the bottom of the window.
- 2 Touch the name of the Sound you want to choose.
 - 3 If you want to close the Sound Select window (and it does not close by itself), press the EXIT button. (When a window does not close by itself, it means the Display Hold is turned on. See Display Hold on page 44).

Memorize the assigned Sounds

- Write the changes to a Keyboard Set.

Mixing the Keyboard Sounds

Adjusting the Sound's volume

At its core, Pa4X is a mixer. As with any mixer, you can adjust the volume level of each Sound, therefore changing the balance between the different Sounds on the keyboard.

Adjust the Sound's volume from the control panel

- 1 While in any page, be sure the lighted SLIDER MODE indicator is VOLUME.
- 2 Be sure the uppermost SLIDER indicator (PAD1 ... UPPER 1) indicator is turned on, otherwise press the TRACK SELECT button to turn it on.

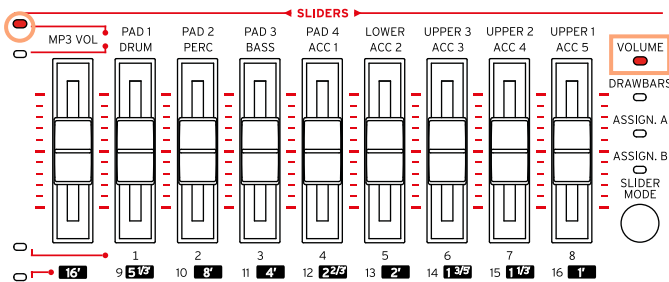

- 3 Use the sliders to adjust the volume of the corresponding Sounds.
- 4 Keep the SHIFT button pressed, and move any of the sliders to proportionally change the volume of all the similar Sounds.

For example, moving any of the UPPER sliders proportionally changes the volume of all the Upper Sounds; moving one of the sliders corresponding to an Accompaniment Sound proportionally changes the volume of all the Accompaniment Sounds.

Adjust a Sound's volume from the display

- 1 While in the Main page, touch the Volume tab to select the Volume pane.



Accompaniment
Groups

Keyboard Sounds

- 2 Touch the mixer channel whose volume level you want to change.
- 3 Keep the virtual volume slider held on the screen, and drag it to the desired level.

As an alternative, use the VALUE controls to change the volume level of the selected channel.

Memorize the Sound's mix

- Write the changes to a Keyboard Set.



Turning the Sounds on or off from the Volume pane

Sounds can be muted, in case you don't want to hear them in the mix.



Select the mixer channel

- Select the mixer channel to turn on or off.

Turn a channel off (Mute)

- Touch the Play icon () in the mixer channel corresponding to the Sound to mute ().

Turn a channel on (Play)

- Touch the Mute icon () in the mixer channel corresponding to the Sound to play ().

Memorize the Sound status

- Write the changes to a Keyboard Set.

Soloing a Sound

You can listen to a single Sound in solo, to understand how it sounds out of the mix.

Solo a Sound

- While the Volume pane is shown, keep the SHIFT button pressed, and touch the mixer channel that you want to listen in solo.

In any page where it appears, you can touch the mixer channel corresponding to the Sound to isolate.

When this function is activated, the 'Solo' warning will flash on the page header.



Solo a Sound via menu command

As an alternative, you can solo a Sound using a menu command.

- 1 While in any page where the name of the Sound or the mixer channel corresponding to the Sound to listen in solo appears, touch it to select it.
- 2 Choose the Solo Track command from the page menu.

Deactivate Solo

Do one of the following:

- While in any page where the mixer channels appear, keep the SHIFT button pressed, and touch the mixer channel that is currently in solo.
- Choose the Solo Track command from the page menu to deselect it.

Transposing the Upper Sounds to a different octave

All Upper Sounds can be transposed to an upper or lower octave at the press of a single button.

Transpose the Upper Sounds one octave up

- Press the UPPER OCTAVE + button on the control panel.

Transpose the Upper Sounds one octave down

- Press the UPPER OCTAVE - button on the control panel.

Reset the octave transposition

- Press both UPPER OCTAVE buttons together.

Memorize the Sound transposition

- Write the changes to a Keyboard Set.

Using the Ensemble to add harmony

There are several types of Ensemble, but with most of them what you play with your right hand will be harmonized with the chords you play with your left hand.

Turning the Ensemble on or off

Turn the Ensemble function on

- 1 Be sure the SPLIT indicator is turned on.
- 2 Press the ENSEMBLE button to light up its indicator.

Play chords with your left hand, and a melody with your right hand. You will hear the chord notes added to the melody.

Turn the Ensemble function off

- Press the ENSEMBLE button again to turn its indicator off.

Choosing an Ensemble type

Select a different harmonization style

- 1 Go to the Style Play > Keyboard/Ensemble > Ensemble page.

As an alternative, keep the SHIFT button pressed, and press the ENSEMBLE button to open the Ensemble page.

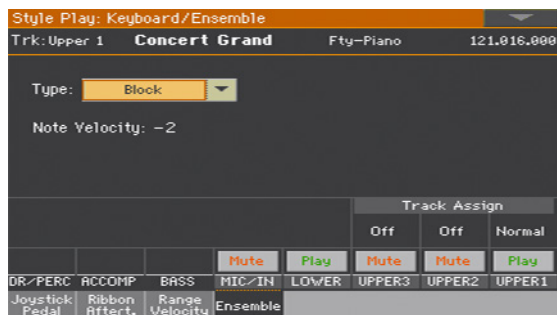

2 Use the Type parameter to choose an Ensemble type.

Ensemble type	Meaning
Duet	Adds a single note to the melody.
Close	Adds a closed-position chord to the melody.
Open 1	Adds an open-position chord to the melody.
Open 2	As the above, but with a different chord shape.
Block	Block harmonization - very typical of jazz music.
Power Ensemble	Adds a fifth and an octave to the melody, as heard in hard rock.
Third Up	This option adds a third over the melody note (depending on the recognized chord).
Fourths LO	Typical of jazz, this option adds two perfect fourths under the melody.
Fourths UP	As the above, but with notes added over the melody.
Fifths	This adds two fifths below the original note.
Octave	Adds an octave to the melody.
Dual	This option adds to the melody line a second note, at a fixed interval set with the "Note" parameter. When selecting this option, a transposition value appears (-24...+24 semitones to the original note).
Brass	Typical Brass section harmonization.
Reed	Typical Reed section harmonization.
Trill	When two notes are played on the keyboard, this option trills them. If three or more notes are played, only the last two are trilled. You can set the trill speed by using the Tempo parameter (see below).
Repeat	The played note is repeated in sync with the Tempo parameter (see below). When playing a chord, only the last note is repeated.
Echo	As the Repeat option, but with the repeated notes fading away after the time set with the Feedback parameter (see below).
AutoSplit1	If more than a single Upper Sound is in play, the Upper 1 Sound plays the melody in mono, while the other Upper Sounds play the chord notes. If only the Upper 1 Sound is in play, it plays polyphonically all the chord notes.
AutoSplit2	Similar to AutoSplit1, but the Upper 1 Sound always plays the uppermost note.

3 When they appear, adjust the additional parameters.

Additional parameters	How it works	Value
Note Velocity	Velocity (dynamics) difference between the melody played with your right-hand and the added harmonization notes.	-10...0
Tempo	Note duration for the Trill, Repeat or Echo Ensemble options. This is in sync with the Tempo value.	1/23...4/4
Feedback	Repetitions of the original note/chord when the Echo option is selected.	1...8

4 Use the Ensemble Track Assign parameter to set the Ensemble function for each of the Upper Sounds.

Ensemble Track Assign	Meaning
Off	No harmonization
Normal	This Sound is included in the harmonization
Mute	This Sound only plays the Ensemble notes, but not the original note.

Exit the Ensemble settings page

- Press the EXIT button to return to the previous page.

Memorize the Ensemble settings

- Write the changes to a Keyboard Set.

15 Advanced editing of the Sound sets

The editing procedure

A - Choose a Sound set

Sound sets are groups of Sounds that are selected all at the same time.

Sound set	Type
Keyboard Sets (from the library)	Sounds assigned to the keyboard, saved in the KEYBOARD SET LIBRARY.
Keyboard Sets (from a Style)	Sounds assigned to the keyboard, saved in the KEYBOARD SET section and selected with the Styles.
Keyboard Sets (from a SongBook Entry)	Sounds assigned to the keyboard, saved in the KEYBOARD SET section and selected with the SongBook Entry.
Style Settings	Sounds for the Accompaniment tracks, selected with the Style.
MIDI Song (in Song Play mode)	Sounds manually assigned to the tracks of any MIDI Song selected in Song Play mode. You can select these Sounds, but not save them.
MIDI Song (in Sequencer mode)	Sounds selected by the Program Change messages contained inside a MIDI Song. You can edit and save these messages in Sequencer mode.

Choose from the library a Keyboard Set whose Sounds and settings to edit

- Press either the STYLE PLAY or SONG PLAY button, then choose from the KEYBOARD SET LIBRARY section the Keyboard Set whose Sounds you want to edit.

Choose from a Style the Keyboard Set whose Sounds and settings to edit

- Press the STYLE PLAY button, then choose a Style, then the Keyboard Set (from the KEYBOARD SET section) whose Sounds you want to edit.

Choose from a SongBook Entry the Keyboard Set whose Sounds and settings to edit

- Press the **SONGBOOK** button and choose a SongBook Entry; or press one of the **SET LIST** buttons to choose the corresponding SongBook Entry. Then choose the Keyboard Set (from the **KEYBOARD SET** section) whose Sounds you want to edit.

Choose a Style whose Sounds and settings to edit

- Press the **STYLE PLAY** button, then choose the Style whose Sounds you want to edit.

Choose Sounds for the Song Play mode

- Press the **SONG PLAY** button, then choose any **MIDI Song** from disk. These changes will not be saved to the Song, and will only serve for on-the-fly customization.

Choose a MIDI Song whose Sounds and settings to edit

- Press the **SEQUENCER** button to go to the Sequencer mode, then choose from disk (or create by recording it) the **MIDI Song** whose Sounds you want to edit.

B - Access editing

- 1 Press the MENU button to access editing and see the edit menu.
- 2 Choose an edit section and edit page to access the parameters.

C - Choose a Sound to edit

Most editing is to be done on the selected Sounds.

Switch between the Keyboard and Style or Song Sounds

- Repeatedly press the TRACK SELECT button. The display will cycle between the Keyboard and the Style or Song Sounds.

Select the track/channel to edit

- Touch the individual track/channel to select it.



D - Save the changes

- When finished editing, write the changes to a Sound set. This will be explained at the end of the relevant chapters.

Mixing the Sounds

The Volume/Pan page is the internal digital mixer of the instrument.

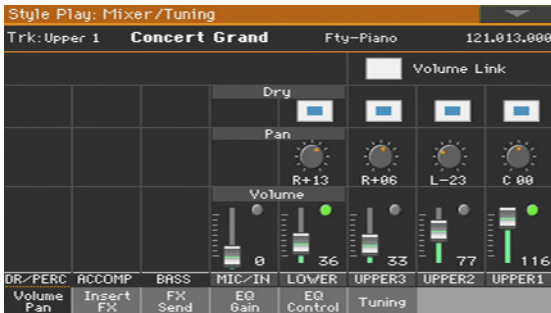

Setting the Volume and Play/Mute status

Adjust the Sound's volume from the control panel

- 1 While in any page, be sure the lighted SLIDER MODE indicator is VOLUME.
- 2 Use the TRACK SELECT button to choose the row of parts/tracks to modify (look at the SLIDER indicators or the labels in the Main page > Volume pane).
- 3 Use the sliders to adjust the volume.

Access the Volume/Pan page

- Go to the Mixer/Tuning > Volume/Pan page, and find the Volume and Play/Mute controls.



Set the individual Sound's Volume

- Keep a virtual volume slider held on the screen, and drag it to the desired level.

As an alternative, use the VALUE controls to change the volume level of the selected mixer channel.

Volume	Meaning
0...127	Volume level in MIDI values

Change the play/mute status of the individual Sound

- Repeatedly touch the Play (🟢) or Mute (🟡) icon in the mixer channel corresponding to the Sound whose status to change.

Linking the Upper Sound volume sliders

The Upper Sound volume sliders can be linked together, to proportionally change all Upper Sounds with a single slider.

- Go to the Mixer/Tuning > Volume/Pan page.
- Select or deselect the Upper Volume Link checkbox.

Upper Volume Link	Meaning
On	When you change the volume of one of the Upper Sounds, the volume of the other Upper Sounds is changed proportionally.
Off	You only move a single volume slider.

Setting the Pan

The Pan (panorama) is the Sound's position in the stereo field.

- Go to the Mixer/Tuning > Volume/Pan page, and find the Pan controls.



- Keep the Pan knob held on the screen, and move it to the desired level.

As an alternative, use the VALUE controls to change the value of the selected knob.

Pan	Meaning
L-64 ... L-1	Left
C 00	Center
R+1 ... R+63	Right

Adding effects

The FX processors

Pa4X includes both insert and master effects ('effect' is often abbreviated as FX).

- Insert effects (IFX) are assigned to a single Sound, and process the whole signal passing through. The most common insert effects are amp simulators, chorus or flanger, overdrive and distortion pedals, compressors, etc. Insert effects are pre-fader, so the volume level of the mixer channel will not change the level of the signal entering the effect.
- Master effects (MFX) are effects shared by several different Sounds, that can be mixed in at different levels. The most common master effects are delays and reverbs. Master effects are post-fader, so the volume level of the mixer channel will change the level of the signal entering the effect.

Each group of Sounds/channels can go to a different group and number of effects.

Sound/Channel	FX Group	Insert FX	Master FX
Keyboard	FX B	One (1), assigned to a single Sound.	Two (2), shared between all Sounds.
Accompaniment	FX A	Up to four (4), freely assignable to any Sound. Up to two (2) effects can be assigned to a single Sound.	Three (3), shared between all Sounds.
Drum Families (DF)	FX A	Up to four (4), freely assignable to any Drum Family. Up to two (2) effects can be assigned to a single Drum Family. Drum Families can be processed by their own Insert FXs. The Drum Kit can then be further processed by its channel's Insert FXs. The total number of Insert FXs available for Drum Families, the Drum Kit and the other Accompaniment Sounds is four (4).	Three (3), shared between all Sounds. Drum Families can set their own send level to the Master FXs. Then, the Drum Kit has its own send levels.
Pad	FX A	-	Three (3), shared between all Sounds.

Sound/Channel	FX Group	Insert FX	Master FX
MIDI Song	FX A	Up to four (4), freely assignable to any Sound. Up to two (2) effects can be assigned to a single Sound.	Three (3), shared between all Sounds.
MIDI Song made with a Pa4X or a KORG Pa-Series instrument	FX A,B	Depends on the selected FX group. FX A and B groups behave as described above.	

You can assign to the master effect processors any type of available effects, but we found it convenient to arrange them, most of the times, in the following way:

Master FX	Type of effect
A1	Reverb processor for the Accompaniment and MIDI Song Sounds
A2	Modulating FX processor for the Accompaniment and MIDI Song Sounds
A3	Delay processor for the Accompaniment and MIDI Song Sounds
B1	Reverb processor for the Keyboard Sounds
B2	Modulating FX processor for the Keyboard Sounds

All the effects in Pa4X

Pa4X includes a powerful multi-effect processor for the internal Sounds. These effects contribute to make the final sound of the instrument, adding vibe and a sense of the space. There are up to five insert and five master effects, to which the Sounds can be sent from their internal mixer channel.

At the end of the audio path there are Waves Audio's MAXX EQ and Master effects, used to process both Sounds and MP3 Songs, and give more punch and refinement to the final, produced sound going to the audience.

In addition to the above, Pa4X also includes a multi-effect processor for the microphone, called the Voice Processor. This incredible effect is the joint effort of KORG and TC•Electronic, whose acclaimed voice processing technology can be accessed directly from the control panel of this instrument, without having to patch-in any external effect processor.

Choosing (and viewing) the FX group

In Style Play and Song Play mode, the FX group is fixed and cannot be changed (you can only see it). In Sequencer mode you can freely choose it for each Song track.

- 1 Go to the Mixer/Tuning > Insert FX or FX Send page.

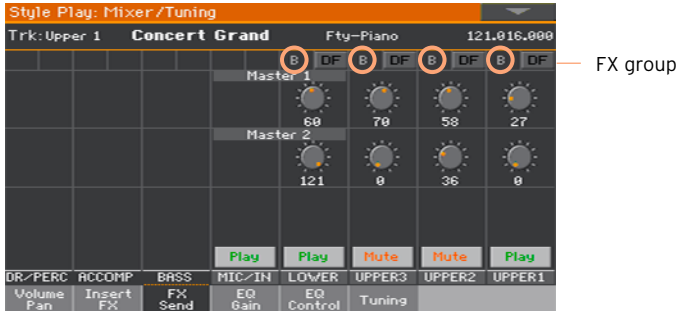

- 2 See, or choose the FX group (this latter is only possible in Sequencer mode).

Activating and choosing the insert effects

Each Sound can go to one or more insert effect processors.

Activate the insert effects

- 1 Go to the Mixer/Tuning > Insert FX page.

Style Play: Mixer/Tuning
Trk: Upper 1 **Concert Grand** Fty: Piano 121.013.000

Insert FX1

Off Off Off **On**

x x x **AMP**

Play Play Mute Mute Play

DR/PERC ACCOMP BASS MIC/IN LOWER UPPER3 UPPER2 UPPER1
Volume Pan Insert FX FX Send EQ Gain EQ Control Tuning

FX group
FX on/off
Selected FX type

- 2 Turn on or off the insert effect(s) assigned to a Sound.

Choose the insert effects

- 1 While in the Insert FX page, touch the name of the selected effect type, or the 'x' symbol under the On/Off button, to open the FX Edit page.

FX Edit

B **IFX 1** AMP: GuitarAmp + Cabinet **On**

Amp Type: VOX AC30 Drive Gain: 91
Volume: 33 Src: Off Amt: +0
Bass: 70 Middle: 80 Treble: 50 Presence: 40

Cab Type: VOX AC30 - 2x12
Cab Trim: 100
Cab Air: 50

Wet/Dry: Wet Src: Off Amt: +0

Volume Pan Insert FX FX Send EQ Gain EQ Control Tuning

Selected FX
FX edit parameters
FX mix and modulation

- 2 Use the pop-up menu on top of the page to choose an effect.
- 3 If needed, edit the effect parameters, as described in the part of the manual dedicated to the Effects.

You can adjust the Wet/Dry mix of the insert effects, but we suggest not to touch it, unless you are editing the effects.

- 4 When finished editing, press the EXIT button to return to the previous page.

Activating and choosing the insert effects for the Drum Families

On Drum tracks, you can access a separate Drum mixer, and add insert effects to each Drum Family. The Drum channel is then sent to the main mixer, and can use the channel's insert effects.

- 1 Go to the Mixer/Tuning > Insert FX page.
- 2 Press the TRACK SELECT button to cycle between the tracks, and find the Drum track.



- 3 Touch the DF button to access editing the Drum Families of the corresponding Drum track.



- 4 On each Drum Family strip, use the various controls to activate/deactivate and select the insert effects.
- 5 When finished editing, touch the DF button again to exit the editing page.

Activating and choosing the master effects

Each Sound can send its audio signal to one or more master effects.

Activate the master effects

- 1 Go to the Master Effects pages, and choose either the FX group A (Accompaniment, Pads, Song) or B (Keyboard).

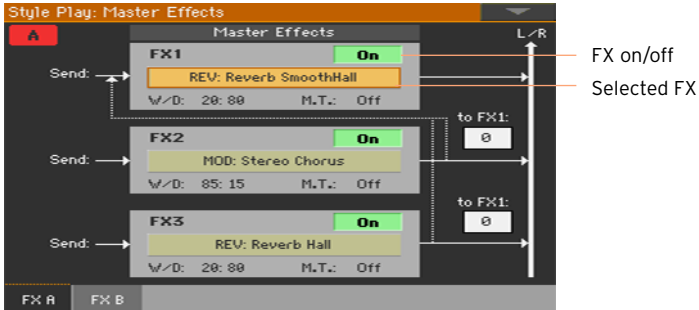

- 2 Turn on or off the master effect(s). Please keep in mind that master effects are assigned to all the Sounds of the same group.

Choose the master effects

- 1 While in the FX A or FX B page, touch the name of the assigned effects to open the FX Edit page.



- 2 Use the pop-up menu on top of the page to choose an effect.
- 3 If needed, edit the effect parameters, as described in the part of the manual dedicated to the Effects.

You can adjust the Wet/Dry mix of the master effects, but we suggest not to touch it, unless you are editing the effects. To set the amount of effect, use the individual channels' send level instead (as explained below).

- 4 When finished editing, press the EXIT button to return to the previous page.

Adjusting the send level to the master effects

You can adjust the level of the direct (dry) signal sent from each Sound/channel to the master effects.

- 1 Go to the Mixer/Tuning > FX Send page.



- 2 On each mixer channel, use the Master knobs to control the level of the direct (dry) signal sent to the corresponding FX processor (inside the selected FX group).

Master 1, 2, 3	Meaning
0...127	FX Send level in MIDI values

Adjusting the send to the master effects for the Drum Families

On Drum/Percussion tracks, you can access a separate Drum/Percussion mixer, and adjust the level of the direct (dry) signal sent from each Drum Family to separate master effects. The Drum/Percussion channel is then sent to the main mixer, and can use the channel's master effects.

Since the Drum Families will be processed by two sets of master processors, we suggest to lower to zero the Drum/Percussion send level in the main mixer.

- 1 Go to the Mixer/Tuning > FX Send page.
- 2 Press the TRACK SELECT button to cycle between the tracks, and find the Drum and Percussion tracks.



- 3 Touch the DF button to access editing the Drum Families of the corresponding Drum or Percussion track.



- 4 On each Drum Family strip, use the Master knobs to control the level of the direct (dry) signal sent to the corresponding FX processor (inside the selected FX group).

Master

Meaning

0...127

FX Send level in MIDI values

- 5 When finished editing, touch the DF button again to exit the editing page.

Including the dry (direct) signal in the master effects

The dry (or 'direct') signal is the raw sound, without the effects. It should be normally included in the signal coming out from the master effects, to give a sense or presence of the sound's source.

This parameter is not needed for the insert effects, since they always include the dry signal.

- 1 Go to the Mixer/Tuning > Volume/Pan page.
- 2 Select or deselect the Dry checkbox corresponding to the Sound you want to include or exclude.

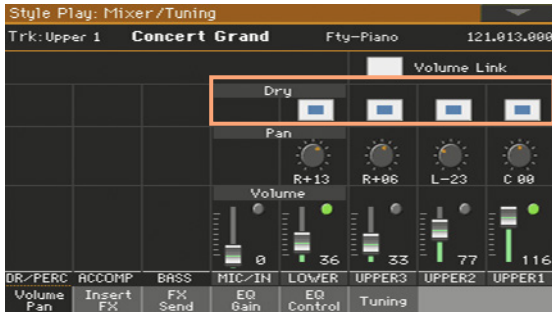

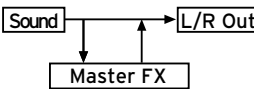
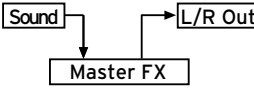
Dry	Meaning
On	<p>The direct signal is sent to the outputs, mixed with the master effects.</p> 
Off	<p>The direct signal is removed from the audio outputs, that will only contain the effected signal. With stereo effects, the effected signal will still be positioned according to the Pan value.</p> <p>This will work in a way similar to an insert effect, where all the dry signal is always processed.</p> 

Copying the effects

To speed up programming, you can copy a single insert or master effect, or all the effects of an FX group (FXA or FXB). You can copy them between different elements (for example, between Styles and Song, or Keyboard Sets and Sounds).

The Copy/Paste operation only copies the parameters of the FX Edit page. Parameters contained in other pages, like Dry or FX Send, are not copied.

Copying a single effect

Copy the effect

- 1 Select the source element (Keyboard Set, Style, Song or Sound).
- 2 Go to the Mixer/Tuning > Insert FX page to copy an insert effect, or to the Master Effects > FX A/B page to copy a master effect.
- 3 Touch the name of the effect to be copied, to open the relevant FX Edit page.
- 4 Choose the Copy Effect command from the page menu.
- 5 Press the EXIT button to exit.

Paste the effect

- 1 Select the target element (Keyboard Set, Style, Song or Sound).
- 2 Go to the Mixer/Tuning > Insert FX page to paste an insert effect, or to the Master Effects > FX A/B page to paste a master effect.
- 3 Touch the name of the effect to be pasted, to open the relevant FX Edit page.
- 4 Choose the Paste Effect command from the page menu.
- 5 Press the EXIT button to exit.

Copying all the master effects in an FX group

Copy the effects

- 1 Select the source element (Keyboard Set, Style, Song or Sound).
- 2 Go to the **Master Effects > FXA/B** page showing the group to be copied.
- 3 Choose the **Copy FX** command from the page menu.

Paste the effects

- 1 Select the target element (Keyboard Set, Style, Song or Sound).
- 2 Go to the **Master Effects > FXA/B** page showing the group to be pasted.
- 3 Choose the **Paste FX** command from the page menu.

If you are copying a group of three effects over two effects, or a group of two effects over three effects, only the first two will be copied.

Equalizing the Sounds

The Channel Equalizer

Pa4X includes three-band equalization (EQ) on each individual mixer channel. Each Sound can be individually equalized.

Setting the EQ gain

- 1 Go to the Mixer/Tuning > EQ Gain page.

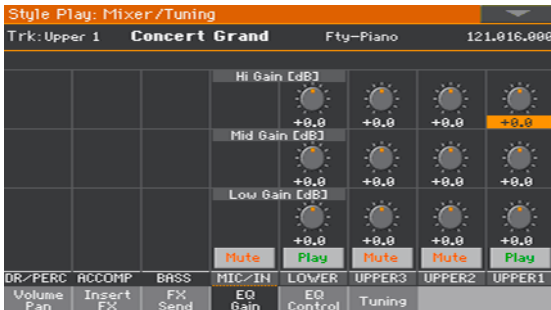

- 2 Keep the Gain knob held on the screen, and move it to the desired level. As an alternative, use the VALUE controls to change the value of the selected knob.

EQ Gain	Meaning
Hi (High) Gain	
-18 ... +18dB	High frequencies equalization. This is a shelving curve filter.
Mid (Middle) Gain	
-18 ... +18dB	Middle frequencies equalization. This is a bell curve filter.
Low Gain	
-18 ... +18dB	Low frequencies equalization. This is a shelving curve filter.

Adjusting the EQ input sensitivity

Extreme equalization gains can overload the audio circuits and lead to distortion. You can however trim the input to avoid overloading.

- 1 Go to the Mixer/Tuning > EQ Control page.

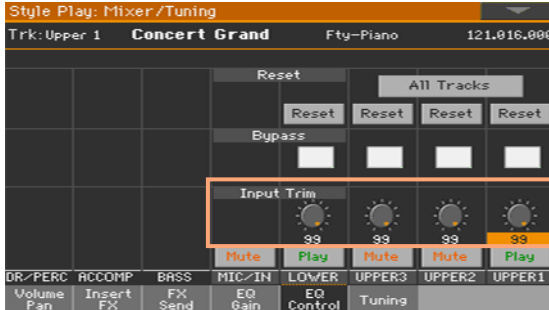

- 2 Use the Input Trim knobs to attenuate the level of the signal passing through the equalizer.

Input Trim	Meaning
0 ... 99	Attenuation value.

Bypassing the EQ

Each EQ can be momentarily bypassed, to check its effect while programming.

- 1 Go to the Mixer/Tuning > EQ Control page.

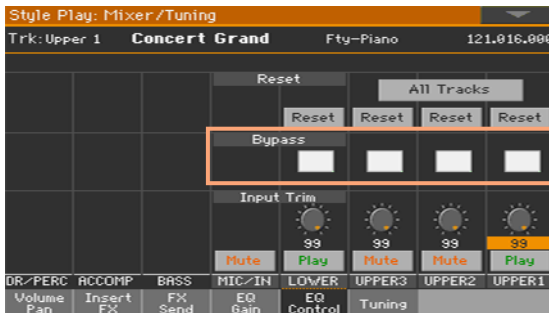

- 2 Select the Bypass checkbox on the mixer channel you want to exclude from equalization. Deselect it to activate the EQ again.

Resetting the EQ

You can reset the EQ to the default (that is, 'flat') status.

- 1 Go to the Mixer/Tuning > EQ Control page.

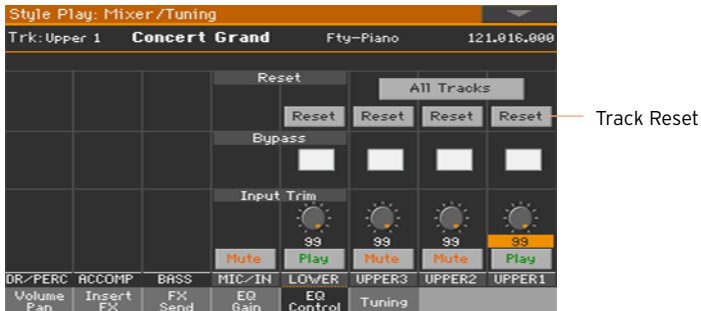

- 2 Reset all the EQs, or a single EQ.

Reset the EQ on a single track/channel

- Touch the Track Reset button corresponding to the channel whose EQ you want to reset.

Reset the EQ on all tracks/channels

- Touch the Reset All Tracks button.

Octave transpose and fine tuning

You can set the octave transpose and fine tuning of each Sound.

Access the Tuning page

- Go to the Style Play/Song Play > Mixer/Tuning > Tuning page.

As an alternative, keep the SHIFT button pressed and press one of the UPPER OCTAVE buttons to open the Tuning page.

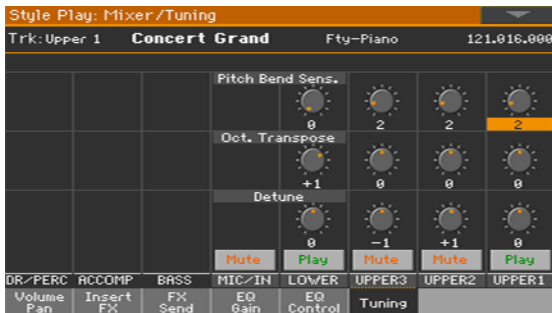

Set the octave transpose

- Use the Oct. Transpose knobs to set the octave transpose for each Sound.

Octave Transpose	Meaning
0	Standard tuning.
-3 ... +3	Octave Transpose value (in octaves).

Set the fine tuning

- Use the Detune knobs to set the fine tuning for each Sound.

Detune	Meaning
0	Standard tuning.
-64 ... +63	Sound pitch (in cents of a semitone).

Programming the sound routing and polyphony

Using the internal or external Sounds

Usually, the Keyboard, Arranger and Players play the internal Sounds. However, you can choose to let them play an external sound generator.

- 1 Go to the Track Control > Mode page.

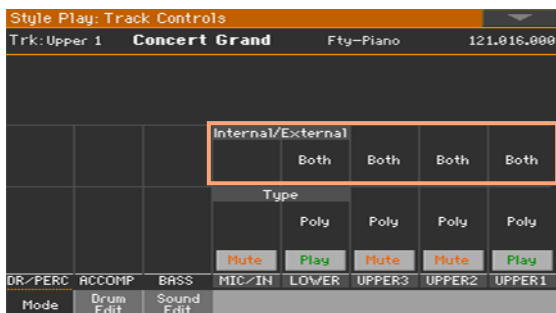

- 2 Use the Internal/External parameter to connect the corresponding part/track to the internal and/or external sound generation.

Int/Ext	Meaning
Both	The part/track plays both the internal sounds and an external instrument connected to the MIDI OUT or USB DEVICE port.
Internal	The part/track only plays the sounds generated by the internal sound generator.
External	The part/track only plays an external instrument connected to the MIDI OUT or USB DEVICE port. The connected device must receive data on the MIDI channel associated with this part/track on Pa4X.

External Sounds and Program Change messages

A part/track set to the External status cannot play the internal sounds. Instead of the assigned Sound name, the <E: aaa.bbb.ccc> indicator is shown on a track's area in the Main page:



Control Change/
Program Change area

This indicator begins with a remark saying the track is in External ('E') mode, and continues with a strings of transmitted Control Change and Program Change data. This will let you know what the track is transmitting. In the following example, CC#0 is the Control Change 0 (Bank Select MSB), CC#32 is the Control Change 32 (Bank Select LSB), PC is the Program Change:

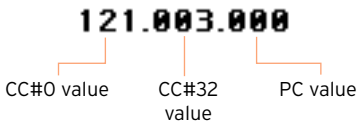

When touching the Sound area, the numeric keypad appears, instead of the Sound Select window. You can enter the Control Change/Program Change bundle shown above, separating the three parts with a dot (.).

Choosing the polyphony type (Mono, Poly, Drum)

Sounds can play polyphonically or monophonically, or behave as Drum Kits.

- 1 Go to the Track Control > Mode page.

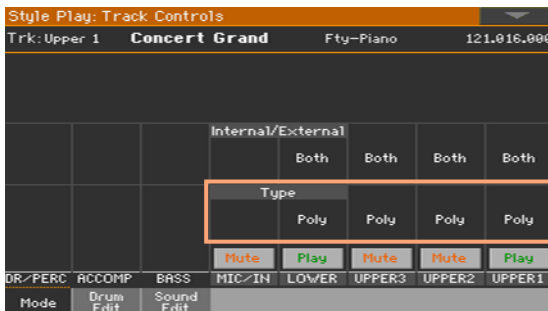

2 Use the Type parameter to choose the polyphony mode.

Type	Meaning
Drum	<p>Drum/Percussion track. This is typically assigned to the Drum and Percussion tracks of the Accompaniment and MIDI Songs.</p> <p>Set a Keyboard Sound to Drum mode, if you don't want it to be transposed (it will behave as a Drum Kit, even if it is an ordinary Sound). Also, set it to Drum mode if you wish to separately adjust the volume and set a different output for each percussive family of a Drum Kit.</p> <p>Drum Kits are never transposed, whichever the type of track they are assigned to.</p> <p>This parameter cannot be edited, if the track has already been set to Drum or Percussion mode in Style Record mode.</p>
Poly	Tracks/parts of this kind are polyphonic, meaning they can play more than one note at the same time.
Mono	Tracks/parts of this kind are monophonic, meaning each new note stops the previous note.
Mono Right	A Mono track/part, with priority assigned to the rightmost (highest) note.
Mono Left	A Mono track/part, with priority assigned to the leftmost (lowest) note.

Quick editing of Drum Kits

You can adjust the volume and edit the main parameters for each family of Drum and Percussion instrument for the selected track. A list of families is shown below.

These parameters can be accessed only on tracks set to the Drum mode in the Track Controls > Mode page. Use them on tracks with a Drum Kit assigned, or you will not be able to hear any change.

Edit the Drum Kits

- 1 Go to the Track Controls > Drum Edit page.



- 2 If you like, start the Style or Song to listen to the changes during playback.
- 3 If you like, solo the track you are editing, to isolate it from the other tracks.
- 4 Use the Select buttons to select a track set to Drum mode (usually, the Drum and Percussion tracks).

After selecting a track set in Drum mode, the parameters in the page can be selected (otherwise, they remain dimmed).

- 5 Select one of the Drum families, by using the Drum Family icons on top of the page.

Drum family icon	Drum family
	Kick drums
	Snare drums
	Toms
	Hi-Hat cymbals
	Ride, Crash and other cymbals
	Low-pitched percussions
	High-pitched percussions
	Special effects

- 6 Check the value of the selected parameter for all the Drum families. An overview of the current parameter can be seen under the icons of the Drum families. This will let you compare the value of the selected family with all the others. The values appear dimmed (non editable).



- 7 Select and edit the parameters. All values are offsets referred to the value of the original Drum Kit.

Sound parameter	Meaning	Value
Volume	Instrument's family volume.	0 ... 127
Attack	Attack time. This is the time during which the sound goes from zero (at the moment when you strike a key) to it's maximum level.	-64 ... +63 (offset)
Decay	Decay time. Time to go from the final Attack level to the minimum level.	
Cutoff	Filter cutoff. This sets the sound brightness.	
Resonance	Use the Filter Resonance to boost the cutoff frequency.	
Fine Tune	Fine instrument tuning.	
Coarse Tune	Coarse instrument tuning.	
EQ Hi	Equalization, High band.	
EQ Mid	Equalization, Middle band.	
EQ Low	Equalization, Low band.	
Ambience Vol	Volume of the Ambience effects (environment and mechanical noise).	
Ambience Time	Length of the Ambience effects (environment and mechanical noise).	

Resetting a Drum family

- Touch the Reset Family button to reset all edited values.

Resetting a track

- Touch the Reset Track button to reset all changes to the selected track.

Quick editing of Sounds

You can edit the main Sounds parameters. These changes will be saved in a Sound set, and not be part of the internal parameters of the Sounds (that you can edit in Sound Edit mode).

Edit the Sounds

- 1 Go to the Track Controls > Sound Edit page.



- 2 If you like, start the Style or Song to listen to the changes during playback.
- 3 If you like, solo the Sound you are editing, to isolate it from the other tracks.
- 4 Use the Select buttons to select the Sound to edit.
- 5 Use the knobs to edit the corresponding parameters. All values are offsets referred to the value of the original Sound.

Sound parameter	Meaning	Value
Attack	Attack time. This is the time during which the sound goes from zero (at the moment when you strike a key) to it's maximum level.	-64 ... +63 (offset)
Decay	Decay time. Time to go from the final Attack level to the minimum level.	
Release	Release time. This is the time during which the sound goes from the sustaining phase, to zero. The Release is triggered by releasing a key.	
Cutoff	Filter cutoff. This sets the sound brightness.	
Resonance	Use the Filter Resonance to boost the cutoff frequency.	
LFO Depth	Intensity of the Vibrato (LFO).	
LFO Speed	Speed of the Vibrato (LFO).	
LFO Delay	Delay time before the Vibrato (LFO) begins, after the sound starts.	

Setting Portamento

Portamento is a smooth sliding transition from a note to the following one.

- Select the **Portamento** checkbox to turn portamento on, or uncheck it to turn it off.
- Use the **Portamento > Time** knob to adjust the speed of portamento.

Resetting a track

- Touch the **Reset Track** button to reset all changes to the selected track.

Resetting all tracks

- Touch the **Reset Family** button to reset all edited values.

Programming the key and velocity range

You can program a key and velocity zone for each of the Keyboard Sounds.

Key range is useful to create a set of Keyboard Sounds playing in different zones of the keyboard. For example, you may have French Horns and Woodwinds playing in the center range of the keyboard, while only Woodwinds play on the higher range.

Velocity range is useful to create a sound made of up to three dynamic layers, assigning each of the Upper Sounds to a different velocity zone. As an example, you may choose El.Piano 1 as the Upper 1 Sound, and El.Piano 2 as the Upper 2 Sound. Then, set Upper 1 to Bottom=0, Top=80, and Upper 2 to Bottom=81, Top=127. The El.Piano 1 will play when playing softer, the El.Piano 2 when playing louder.

Access the Range/Velocity page

- Go to the Keyboard/Ensemble > Range/Velocity page.

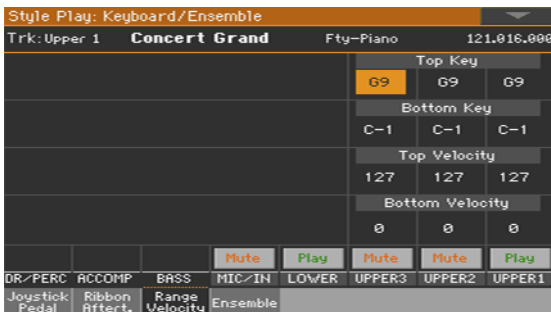

Set the Key Range

- Use the Top Key and Bottom Key parameters to set the Top and Bottom limits of the Sound's Key zone.

Key	Meaning
C-1 ... G9	Selected key. The Top value is always higher than the Bottom value.

Set the Velocity Range

- Use the Top Vel. and Bottom Vel. parameters to set the Top and Bottom limits of the Sound's Velocity zone.

Velocity	Meaning
0 ... 127	Velocity value. The Top value is always higher than the Bottom value.

Editing the Digital Drawbars

Digital Drawbars are special Sounds emulating the classic tonewheel organs. Settings for the Digital Drawbars are memorized in a Keyboard Set, the Style Settings or in a MIDI Song, and may be considered the equivalent of an organ's preset.

A single Digital Drawbars Sound can be assigned to the keyboard, and only one to the accompaniment. A single Digital Drawbars Sound can be assigned to tracks 1-8, and a single one to tracks 9-16 or a MIDI Song.

You can assign the same Sound to different tracks in the same block (for example, two different Acc tracks in a Style). Also, you can use the different blocks to record the different manuals of a classic organ (for example, record the Upper manual in one of the tracks 1-8, and the Lower manual in one of the tracks 9-16).

Choosing a Digital Drawbars Sound

Open the Sound Select window from the control panel

- Press one of the KEYBOARD SOUNDS > SELECT buttons.

Open the Sound Select window from the display

- While in the Main page, touch one of the Sound names to open the Sound Select window.

Choose the Digital Drawbars Sound

- 1 Use the side tabs to select the Organ group.



- 2 Choose the DRAWBARS Sound. The Drawbars Setting page will appear.

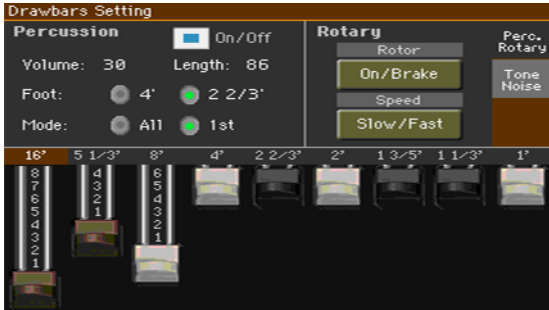

- 3 If you want to close this window, press the EXIT button.

Editing the Digital Drawbars

Access Digital Drawbars editing

- 1 While in the Main page, touch the DRAWBARS Sound to open the Sound Select window.
- 2 Touch the selected DRAWBARS Sound to open the Drawbars Setting page.

Changing the footage

Change the footage (harmonic content of the sound) from the control panel

- 1 Be sure the selected SLIDER MODE is DRAWBARS.
- 2 Use the sliders to change the corresponding footages.

Change the footage (harmonic content of the sound) from the display

- Drag the virtual sliders to change the corresponding footages.

Changing the Percussive/Rotary settings

Go to the Percussive/Rotary page

- In case it is not selected, touch the Percussive/Rotary tab to show the Percussive/Rotary page.

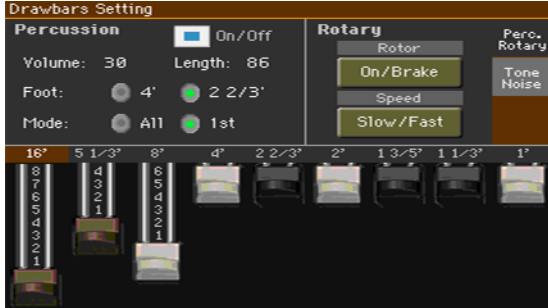

Program the Percussion parameters

Percussion adds a percussive sound to the attack segment of the organ sound.

Percussion parameters	Meaning	Value
On/Off	Turns percussion on or off.	
Foot	Selects a percussion register.	
Mode	If All , the percussive attack is played on all notes of a chord. If 1st , the percussive attack is played only on the first note of a chord or a group of held notes. Release all notes to trigger the percussion again.	All, 1st
Volume	Volume level of the percussive sound.	
Length	Decay speed of the percussive sound.	

Program the Rotary parameters

Rotary adds the effect of a rotating speaker. The rotation speed can be controlled by pulling back the joystick.

Rotary parameters	Meaning
Rotor On/Brake	Touch this button to start or stop the rotating speaker.
Speed Slow/Fast	Touch this button to switch the rotating speaker's speed (from slow to fast, or vice-versa).

Changing the Tone/Noise settings

Go to the Tone/Noise page

- Touch the Tone/Noise tab to show the Tone/Noise page.

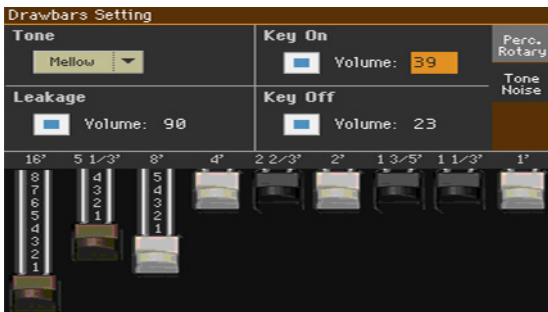

Program the Tone parameter

Tone is the waveshape of the drawbars, producing the raw timbre.

Tone option	Meaning
Mellow	A mellow-sounding wave.
Hard	A harder-sounding wave.

Program the Leakage parameter

- Increase Leakage from adjacent tonewheels, to make the sound richer.

Program the Key On and Key Off parameters

- Use the Key On and Key Off parameters, to add the noise of keypress or key release.

16 Writing the Sound sets

Writing the Keyboard Sets to the library

Keyboard Sets can store the Keyboard Sounds and settings. The library is where you organize them by type and family. You can recall these Keyboard Sets by using the KEYBOARD SET LIBRARY buttons.

Note: All changes will be lost when choosing a different Keyboard Set, unless you write them. Changes can normally only be saved onto the User or Direct Keyboard Sets.

Writing a Keyboard Set

Open the Write Keyboard Set to Library dialog from the control panel

- While in Style Play or Song Play mode, keep any of the KEYBOARD SET LIBRARY buttons pressed for about one second.

Open the Write Keyboard Set to Library dialog from the display

- While in Style Play or Song Play mode, choose the Write Kbd Set to Library command from the page menu.

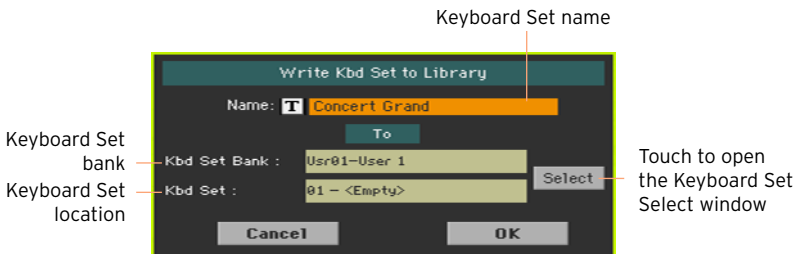

Write over the same User Keyboard Set

- If you want to overwrite the current User Keyboard Set, just touch the OK button.

Write to a different Keyboard Set location

- 1 If you want to save onto a different location, touch the **Select** button and open the **Keyboard Set Library Select** window. Choose a location as if you were choosing a Keyboard Set. Blank locations are shown as a series of dashes ('---').
- 2 When back at the **Write Keyboard Set** dialog, you may change the name of the Keyboard Set. Touch the **Text Edit** () icon to open the **virtual keyboard** and edit the name.

When done editing the name, confirm by touching the **OK** button under the virtual keyboard.

- 3 When back at the **Write Keyboard Set** dialog, confirm the Write operation by touching the **OK** button.

Writing Keyboard Sets into a Style

Keyboard Sets can store Keyboard Sounds and settings inside a Style. When choosing a Style, four Keyboard Sets matching the selected Style are automatically selected. You can recall these Keyboard Sets by using the **KEYBOARD SET** buttons under the display.

Note: Changes can normally only be saved onto Favorite, User and Direct Styles.

Writing the Keyboard Set to the current Style

Open the Write Keyboard Set to Style dialog from the control panel

- While in Style Play or Song Play mode, keep any of the **KEYBOARD SET** buttons under the display pressed for about one second.

Open the Write Keyboard Set to Style dialog from the display

- While in Style Play or Song Play mode, choose the Write Kbd Set to Style command from the page menu.

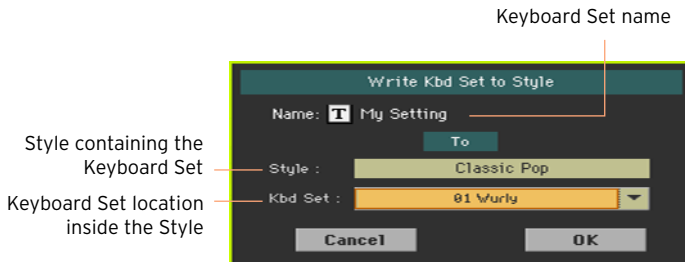

Write the Keyboard Set

- If you want to overwrite the current Keyboard Set, just touch the **OK** button.
 - If you want to write the Keyboard Set to a different location inside the same Style, touch the arrow next to the Kbd Set parameter to open a pop-up menu and choose a different location.
- You may change the name of the Keyboard Set. Touch the Text Edit (**T**) icon to open the virtual keyboard and edit the name.

When done editing the name, confirm by touching the **OK** button under the virtual keyboard.

- When back at the Write Kbd Set to Style dialog, confirm the Write operation by touching the **OK** button.

Writing the Keyboard Set to a different Style

- 1 Choose the Style containing the original Keyboard Set.
- 2 Edit the Keyboard Set.
- 3 Be sure the **STYLE TO KBD SET** indicator is turned off.
If this indicator was turned on, choosing a Style would also select a different Keyboard Set.
- 4 Choose the Style where you want to copy the modified Keyboard Set.
- 5 Write the Keyboard Set into the preferred location, by following the procedure seen above.

Writing Keyboard Sets into a SongBook Entry

You can write the changes to the Keyboard Sounds and settings into one of the Keyboard Sets. When choosing a SongBook Entry, four Keyboard Sets matching the selected Entry are automatically selected. You can recall these Keyboard Sets by using the **KEYBOARD SET** buttons under the display.

Saving Keyboard Sets to a new SongBook Entry

You can create a new SongBook Entry, and at the same time save the current Keyboard Sets with it.

- 1 While you are in **Style Play** or **Song Play** mode, choose the Style or Song the SongBook Entry will be based on. The Style includes up to four Keyboard Sets.
- 2 If you want, edit the Keyboard Sounds and their settings (split point, octave transposition, volume...). This will be Keyboard Set #1.
- 3 When finished editing, keep the **SONGBOOK** button pressed for one second to open the Write Song page.



- 4 If a Direct SongBook has been selected, choose between the **Internal** and **Direct** SongBook.
- 5 Touch the **New Song Name** parameter and assign the Entry a name.
- 6 Touch the **OK** button to save the new SongBook Entry.

Together with the Keyboard Sets, all the current settings are saved into the new SongBook Entry (including the selected Style or the selected Song).

If you edited the Keyboard Sounds, they will be saved as the Keyboard Set #1.

Saving a Keyboard Set to the selected SongBook Entry

You can save the Keyboard Sounds as a Keyboard Set inside the selected SongBook Entry.

- 1 Before editing the Keyboard Sounds, go to the **SongBook > Book or Set List** page, and choose the SongBook Entry where to save them.
- 2 Press the **EXIT** button to exit the SongBook.
- 3 Edit the Keyboard Sounds.
- 4 Go to the **SongBook > Write** page.



- 5 Select the **Keyboard Set > Write** checkbox, and select the name of the single Keyboard Set.
- 6 Choose a single Keyboard Set location to save the Keyboard Sounds to the selected Keyboard Set inside the SongBook Entry. After choosing the target location you can give the Keyboard Set a new name.
- 7 Touch the **Write** button to make the **Write Song** dialog appear.

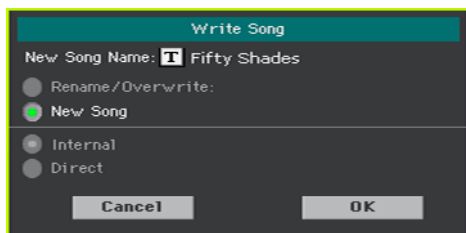

- 8 If a **Direct** SongBook has been selected, choose between the **Internal** and **Direct** SongBook.
- 9 Choose whether to overwrite an existing Entry, or create a new one:

- To overwrite the current SongBook Entry, choose **Rename/Overwrite**.
 - To create a new SongBook Entry, choose **New Song**.
- 10 Touch the **New Song Name** line if you want to edit the SongBook Entry's name.
 - 11 Touch **OK** to save the SongBook Entry.
 - 12 If you want to save more Keyboard Sets, repeat the above procedure for the other four Keyboard Set locations inside the SongBook Entry.

Writing Style Settings, Song Settings and MIDI Song Sounds

The Sounds' configuration can also be written into other elements.

- To edit additional Style parameters, and save the Style Settings, see the pages starting from **Customizing the Styles** on page 197.
- To edit additional parameters of the Song Play mode, and save the Song Play Settings, see the pages starting from **Customizing the Songs** on page 311. Please remember that changes made in Song Play mode are temporary, and will be discarded when playing a Song.
- To edit additional MIDI Song parameters and save them into a Standard MIDI File, see the pages starting from **Editing the MIDI Songs** on page 348.

**PART V:
CUSTOMIZING,
RECORDING
AND EDITING
THE STYLES
AND PADS**

17 Customizing the Styles

Setting the Chord Recognition

Choosing where to play chords (Chord Scan area)

You can play chords with your left or right hand separately, or with both hands. You can choose the recognition area, depending on the song you are playing and your preferred playing style.

The area where chords are recognized depends on the status of the **CHORD SCAN** indicators.

CHORD SCAN	Where to play chords (Chord Scan area)	Notes to play
LOWER	Left hand (Lower area of the keyboard)	Depends on the Chord Recognition mode
UPPER	Right hand (Upper area of the keyboard)	Three or more
LOWER+UPPER	Both hands (full keyboard)	Three or more
Off	No chord recognized	-

Make chords be recognized when played with your left hand

- Press the **CHORD SCAN > LOWER** button to turn its indicator on.

The number of notes to be played, for a chord to be recognized, depends on the Chord Recognition mode (see below).

Make chords be recognized when played with your right hand

- Press the **CHORD SCAN > UPPER** button to turn its indicator on.

Always play three or more notes to let the arranger recognize a chord.

Make chords be recognized when played with both hands

- Press both the **CHORD SCAN (LOWER+UPPER)** buttons to turn their indicators on.

Always play three or more notes to let the arranger recognize a chord.

Deactivate chord recognition

- Press both the CHORD SCAN (LOWER+UPPER) buttons to turn their indicators off.

Only the Drum and Percussion tracks will continue to play.

Memorize the Chord Scan area

- Write a Keyboard Set.

Choosing how to play chords (Chord Recognition mode)

You can play chords in the simplest (even simplified), or the most sophisticated way. It's at you how chords have to be played to be recognized.

- 1 Go to the Global > Mode Preferences > Style 1 page.

As an alternative, keep the SHIFT button pressed and press the STYLE PLAY button to open the Style 1 page.

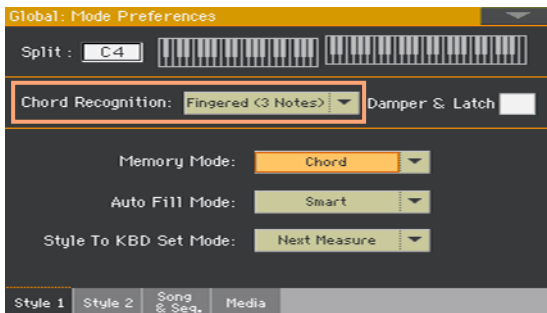

2 Choose how to play chords by using the Chord Recognition menu.

Chord Recognition	How to play chords
One Finger	<p>This mode is only available when the SPLIT indicator is turned on. If you turn it off, the mode will automatically switch to Fingered (3 Notes).</p> <p>With this mode, you can compose a chord using a simplified chord playing technique:</p> <ul style="list-style-type: none"> • Play a single note for a Major chord to be recognized. • Play the root note, plus a white key on the left, for a 7th. For example, play C3 + B2 for a C7. • Play the root note, plus a black key on the left, for a Minor chord. For example, play C3 + Bb2 for a C minor. • Play the root note, plus a white and a black key on the left, for a Minor 7th. For example, play C3 + B2 + Bb2 for a C min 7.
One Finger Plus	<p>This mode works like One Finger. However, if you play complete chords, it will recognize them as if you were in Fingered (3 Notes). This way, you can play chords that One Finger cannot recognize.</p>
Fingered (1 Note)	<p>When the SPLIT indicator is turned on, play one or more notes to compose a chord. A full Major chord will be recognized even if only a single note is played.</p> <p>When the SPLIT indicator is turned off, play at least three notes to compose a chord.</p>
Fingered (3 Notes)	<p>Always play three or more notes for a chord to be recognized.</p>
Advanced	<p>When the SPLIT indicator is turned on, play one or more notes for a chord to be recognized. If you play a single note, a 'root+8ve' will be played. If you play a fifth, a 'root+5th' chord will be played.</p> <p>When the SPLIT indicator is turned off, play at least three notes to compose a chord.</p> <p>With this mode, you can play rootless and slashed chords, often used in jazz, fusion or modern pop. You don't always need to play the root note, that would otherwise double the note already played by the bassist.</p>

3 Press the EXIT button to return to the previous page.

Keeping a chord in memory by pressing the Damper pedal

You can choose to keep the recognized chord in memory while the Damper pedal is kept pressed. In this case, you can freely play any chord on the keyboard, and the arranger will still play the 'latched' chord. This is especially useful when playing in Full Keyboard mode (with the SPLIT indicator turned off), and all the notes you play on the keyboard could be recognized as a new chord.

- 1 Go to the Global > Mode Preferences > Style 1 page.

As an alternative, keep the SHIFT button pressed and press the STYLE PLAY button to open the Style 1 page.

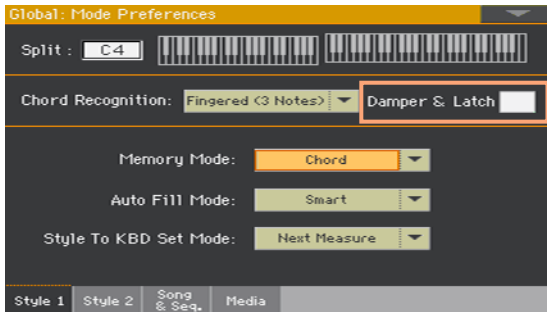

- 2 Select the Damper&Latch checkbox, to make the recognized chord be held for as long as the Damper pedal is kept pressed.

At this point, play a chord for the arranger. Press the Damper pedal and keep it pressed to keep the recognized chord in memory. Release the Damper pedal when you want to play another chord to be recognized by the arranger.

Automatically holding chords and Lower notes (Memory)

Using the Memory function

You can keep the chords and/or Lower notes in memory even after raising your hand from the keyboard. How this function works depends on the settings of the Memory Mode parameter (see below).

- Press the MEMORY button to turn its indicator on, and keep the chords and/or Lower notes in memory.
- Press the MEMORY button to turn its indicator off. The chords and/or Lower notes are released as soon as you raise your hand from the keyboard.

Choosing the Memory Mode

Set how the MEMORY button works according to your preferences.

- 1 Go to the Global > Mode Preferences > Style 1 page.

As an alternative, keep the SHIFT button pressed and press the STYLE PLAY button to open the Style 1 page.



- 2 Use the Memory Mode parameter to choose the way the MEMORY button works.

Memory Mode	Meaning
Chord	When the MEMORY indicator is on, recognized chords are held even when raising your hand from the keyboard. When the indicator is off, chords are reset when raising your hand.
Chord + Lower	When the MEMORY indicator is on, recognized chords and the Lower Sound are held until the next note or chord is played. When the indicator is off, both the chord (therefore the accompaniment) and Lower Sound are cut when raising the hand from the keyboard.
Fixed Arr. + Lower	When the MEMORY indicator is on, recognized chords and the Lower Sound are held until the next note or chord is played. When the indicator is off, the Lower Sound is cut when raising the hand from the keyboard, while the chord is held (the accompaniment will continue to play).

Recognizing the root note (Bass Inversion)

The instrument's internal arranger recognizes chords by analyzing all the notes you play in the chord recognition area, and considering their function in a chord. You can however always force the lowest (leftmost) note of the chord to be considered, for example the chord's root of a slashed chord (such as 'C/E' or 'F/C').

- Press the **BASS INVERSION** button to turn its indicator on. The lowest note of a chord will always be detected as the root note.
- Press the **BASS INVERSION** button to turn its indicator off. The lowest note will be scanned together with the other chord notes, and will not always be considered as the root note.

Setting how velocity controls the accompaniment

You can play stronger than a set velocity value to trigger an accompaniment control.

- 1 Go to the Global > Mode Preferences > Style 2 page.

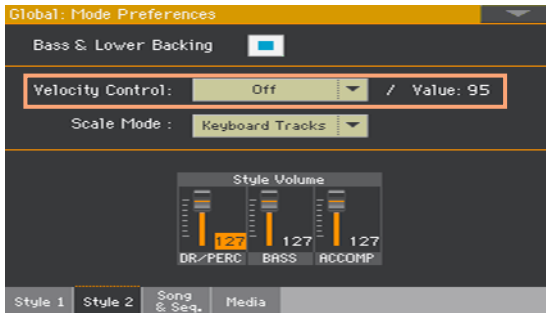

- 2 Use the Velocity Control parameter to choose the function to be controlled when playing strongly.

Velocity Control	Meaning
Off	The function is turned off.
Break	When playing with a velocity higher than the trigger value on the Lower track, the Break is automatically triggered.
Start/Stop	You can start or stop the automatic accompaniment by playing harder on the keyboard.
Bass Inversion	When playing with a velocity higher than the trigger value, the Bass Inversion function will be activated or deactivated.
Memory	When playing with a velocity higher than the trigger value, the Memory function will be activated or deactivated.

- 3 Use the Value parameter to set the velocity trigger value.
- 4 Before using this function, be sure the SPLIT indicator is turned on.

Mixing the grouped Accompaniment Sounds

Grouped Accompaniment Sounds

As in a mixer, the Accompaniment Sounds can be grouped together. For example, instead of separately muting the guitar and the strings parts in the Accompaniment, you can mute the Accompaniment (ACCOMP) group by touching a single button.

Grouped Accompaniment Sounds can be accessed directly from the Main page > Volume pane:

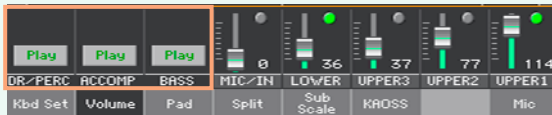

Muting grouped Accompaniment parts

Turn a group of Accompaniment Sounds off (Mute)

- If the group you want to mute is in Play, touch the Play/Mute icon to set it to Mute.



Turn a group of Accompaniment Sounds on (Play)

- If the group you want to hear is in Mute, touch the Play/Mute icon to set it to Play.



Adjusting the (global) Accompaniment groups volume

Groups volume is a global setting, that is not meant to change when you select a different Style. To avoid abrupt changes in the volume level of the Accompaniment Sounds during a show, we moved the volume settings to a safer area than the Main page.

- 1 Go to the Global > Mode Preferences > Style 2 page.

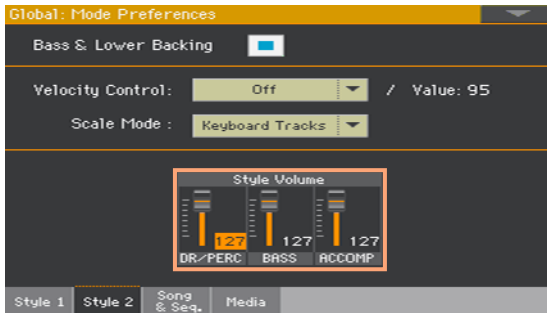

- 2 In the Style Volume section, touch the mixer group channel whose volume level you want to change.

Grouped part name	Meaning
DR/PERC	Grouped Drum and Percussion parts (volume offset)
ACCOMP	Grouped Accompaniment parts (Acc1-5) (volume offset)
BASS	Bass part (volume offset)

- 3 Keep the virtual volume slider held on the screen, and drag it to the desired level.

As an alternative, use the VALUE controls to change the volume level of the selected channel.

As it happens with the groups of a mixer, these levels are not the actual channel level, but a global offset added to the separate channels. Therefore, the resulting level will depend on the individual level of each channel, summed to this group's offset.

If you like, you can finely mix the various groups. For example, if you prefer Drums and Bass to be more prominent to let them have more 'punch', you can lower the grouped Accompaniment Sounds to leave more room to the rhythm section.

If you wish to permanently mute a group, just move its volume to zero.

The (relative) volume level of grouped tracks will remain the same for all the subsequent Styles you will choose during your performance.

- 4 Press the EXIT button to return to the previous page.

18 Editing the Style Settings

Mixing the individual Accompaniment Sounds

Adjusting the volume of the individual Accompaniment Sounds

As you can do with the Keyboard Sounds, you can adjust the volume of the individual Accompaniment Sounds. This will allow for finer balancing between Accompaniment Sounds.

Please note that in the **Global > Mode Preferences > Style** page you can adjust the volume of the grouped Style tracks as a general setting, as if you were adjusting the levels of the mixer groups.

Note: Changes can normally only be saved onto Favorite, User or Direct Styles. They cannot be saved onto Factory Styles.

Adjust the Accompaniment Sounds' volume level from the control panel

- 1 While in any page, be sure the lighted SLIDER MODE indicator is VOLUME.
- 2 Be sure the second-from-top SLIDER indicator (DRUM ... ACC5) is turned on, otherwise press the TRACK SELECT button to turn it on.

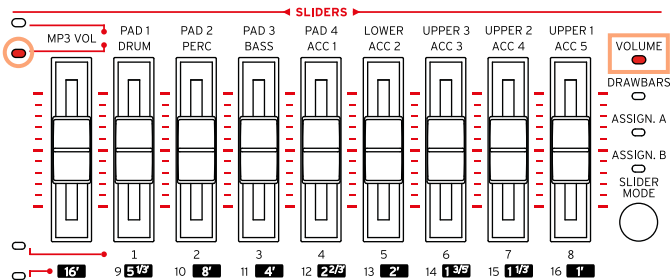

- 3 Use the sliders to adjust the volume of the corresponding Sounds.

- Keep the **SHIFT** button pressed, and move any of the sliders to proportionally change the volume of all similar Sounds.

For example, moving any of the **UPPER** sliders proportionally changes the volume of all the Upper Sounds; moving one of the sliders corresponding to a Style track, proportionally changes the volume of all the Style tracks.

Style tracks	Meaning
DRUM	Drum part
PERC	Percussion part
BASS	Bass part
ACC1-5	Five separate instrumental accompaniment parts (Acc1-5). These may freely be melodic or chordal parts

Adjust an Accompaniment Sound's volume level from the display

- See the Accompaniment parts mixer.

While in the Main page, touch the **Volume** tab to select the Volume pane, then press the **TRACK SELECT** button to switch to the Accompaniment Sounds.



As an alternative, you can adjust the levels in the **Style Play** or **Style Record** > **Mixer/Tuning** > **Volume/Pan** page.

- Touch the mixer channel whose volume level you want to change.
- Keep the virtual slider held on the screen, and drag it to the desired level.

As an alternative, use the **VALUE** controls to change the volume level of the selected channel.

- Keep the **SHIFT** button pressed, and drag any of the virtual sliders to proportionally change the volume of all similar Sounds.
- Return to the Main page

When done, press the **TRACK SELECT** button again to switch back to the Main page and see the grouped parts.

Memorize the volume level

- Write the Style Settings.

Turning the individual Accompaniment Sounds on or off

Sounds can be muted, in case you don't want to hear them in the mix. As an example, the accompaniment might contain a piano part, and you want to play it live on the keyboard.

Note: Changes can normally only be saved onto Favorite, User or Direct Styles. They cannot be saved onto Factory Styles.

See the Accompaniment parts mixer



- While in the Main page, touch the Volume tab to select the Volume pane, then press the TRACK SELECT button to switch to the Accompaniment Sounds.



Accompaniment parts

As an alternative, you can access these parameters in the Style Play or Style Record > Mixer/Tuning > Volume/Pan page.

Turn a channel on (Play) or off (Mute)

- Select the mixer channel, then touch the Play () or Mute () icon to turn the corresponding Sounds on or off.

Return to the Main page

- When done, press the TRACK SELECT button again to switch back to the Main page and see the grouped parts.

Memorize the play/mute status

- Write the Style Settings.

Soloing an Accompaniment Sound

You can solo an Accompaniment Sound exactly as you would do with the Keyboard Sounds.

Solo a Sound

- While the Volume pane is shown, keep the SHIFT button pressed, and touch the mixer channel that you want to listen in solo.

In any page where it appears, you can touch the mixer channel corresponding to the Sound to isolate.

When this function is activated, the 'Solo' warning will flash on the page header.



Solo a Sound via menu command

As an alternative, you can solo a Sound using a menu command.

- 1 While in any page where the name of the Sound or the mixer channel corresponding to the Sound to listen in solo appears, touch it to select it.
- 2 Choose the Solo Track command from the page menu.

Deactivate Solo

Do one of the following:

- While in any page where the mixer channels appear, keep the SHIFT button pressed, and touch the mixer channel that is currently in solo.
- Choose the Solo Track command from the page menu to deselect it.

Changing the Sounds of the accompaniment parts

Style vs. Style Element Sounds

You can assign Accompaniment Sounds to the whole Style (saved in the Style Settings), that will not change when changing Style Element (for example, going from Variation 1 to Variation 2). Or you can assign Accompaniment Sounds to each Style Element, to let them change when choosing a different Style Element.

Choosing Sounds for the whole Style

You may prefer to assign Sounds to the accompaniment tracks that will not change when choosing a different Style Element (Intro, Variation...). The new combination of Sounds can be written into the current Style Settings.

This is like having a band playing the same instruments for the whole song, as it usually happens. It is also much quicker to program.

Choose Sounds for the Accompaniment parts

- 1 While in the Main page, touch the Volume tab to select the Volume pane.
- 2 Press the TRACK SELECT button to switch to the Accompaniment Sounds (Style Tracks View).



Sounds of the
Accompaniment parts

- 3 Be sure the Original Sound Set checkbox is not selected. In any case, it will be automatically deselected when choosing a Sound.

This will make the Style choose the Sounds assigned to the Style Settings, instead of the Sounds assigned to the Style Elements (the 'original' Sounds).

- 4 Choose Sounds by touching the Sound icon on each track.



These Sounds will become part of the Style Settings. They will remain the same for the whole Style, and will not change when choosing different Style Elements.

Memorize the assigned Sounds

- Write the Style Settings.

Changing Sounds for each Style Element

You can assign Sounds to each accompaniment part of each Style Element (Intro, Variation...). This option requires editing the Style in Style Record mode, since the events are recorded into the Style sequence. Please see the relevant chapter.

To use these Sounds, be sure the **Original Sound Set** checkbox is selected.

Drum Kits

Drum Kits (including Percussion Kits) are special Sounds, where each note of the keyboard is a different percussive instrument. To preserve the kit's mapping, Drum Kits are not affected by transposition.

Choose the Drum and Percussion accompaniment parts

Usually, you will assign Drum Kits to the DRUM part, and Percussion Kits to the PERC part.

Choose Drum Kits

Choose Drum Kits as any other Sound. Drum Kits are contained in the banks whose name includes Drums.

Digital Drawbars and the accompaniment parts

Digital Drawbars are special Sounds emulating the classic tonewheel organs. Settings for the Digital Drawbars assigned to the accompaniment tracks are memorized in the Style Settings, and may be considered the equivalent of an organ's preset. You can have a single Digital Drawbars Sound for all the accompaniment parts.

Setting the Style controls

Remapping Drum Kit instruments

You can remap Drum Kit instruments to add variety to the percussive part. Select different Maps and Designations while listening to the Style, and see how they affect the final result.

- 1 Go to the Style Play > Style Controls > Drum/Fill page.



As an alternative, you can access these parameters in the Style Record > Style Tracks Controls > Drum Map page.

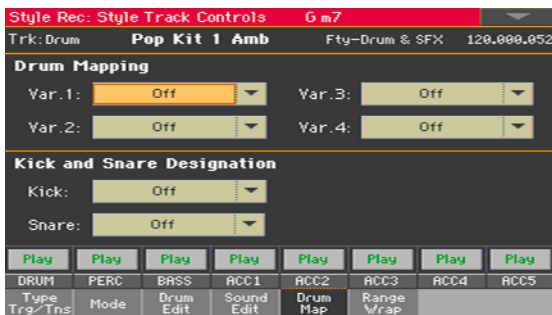

- 2 Use the Drum Mapping > Var pop-up menus to choose an alternative arrangement of percussive instruments for the selected Drum Kit, without any additional programming. Just select a Drum Map for each Variation, and some percussive instruments will be replaced with different instruments.

Drum Mapping	Meaning
Off	Standard mapping
Drum Mapping 1...7	Drum Mapping number. Mapping 1 is 'soft-sounding', while mapping 7 is 'loud-sounding'.

- 3 Use the Kick and Snare Designation > Kick pop-up menu to replace the original Kick (Bass Drum) sound with a different Kick of the same Drum Kit.
- 4 Use the Kick and Snare Designation > Snare pop-up menu to replace the original Snare Drum sound with a different Snare of the same Drum Kit.

Designation	Meaning
Off	Original Kick or Snare
Type 1...3	Kick or Snare replacing the original one

Memorize the Drum Kit mapping

- Write the Style Settings.

Choosing a Fill Mode for each Fill/Break

The Fill Mode parameters allow for automatically choosing a Variation at the end of each Fill, after having pressed one of the FILL or BREAK buttons. These settings can be saved to the Style Settings or a SongBook Entry, so you can have a different Fill Mode configuration for each Style or SongBook Entry.

- 1 Go to the Style Play > Style Controls > Drum/Fill page.

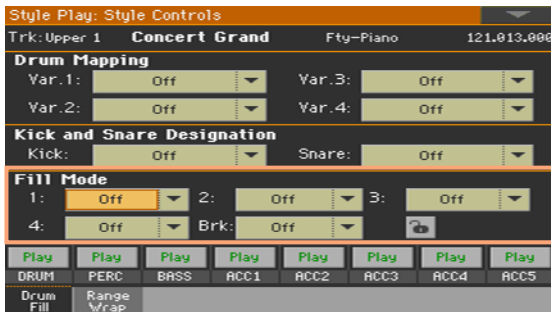

- 2 Use the Fill Mode > 1...5/Brk pop-up menus to choose a Fill Mode for the corresponding Fill/Break.

Fill Mode	Meaning
Off	The same Variation, playing before selecting a Fill, will be selected again.
V1&V2 ... V3&V4	The specified Variations will be alternatively selected, when one of them is selected. For example, with the V1&V2 option, if Variation 1 is selected, Variation 1 and Variation 2 will be alternatively selected after the end of the Fill.
Var.Up/Var.Down	The next higher/lower numbered Variation is selected, in cycle. After Variation 4, an Up command will select Variation 1. After Variation 1, a Down command will select Variation 4.
Var.Inc/Var.Dec	The next higher/lower numbered Variation is selected. When Variation 4 is reached, an Inc command will select Variation 4 again. When Variation 1 is reached, a Dec command will select Variation 1 again.
To Var.1 ... To Var.4	Fill to Variation (->1, ->2, ->3, ->4) automatically selects one of the four available Style Variations at the end of the fill.

Auto Fill and Fill Mode

Auto Fill and Fill Mode can interact, by doing strictly related things:

- When the Auto Fill is enabled (AUTO FILL indicator on), you can choose a Variation by pressing one of the VARIATION buttons. This will automatically select a Fill, then the chosen Variation. This is the easiest way to select the Variation best fitting the next song section, and let the instrument automatically choose a Fill for you.
- When the Fill Mode is programmed in a Style or SongBook Entry, you can choose a Fill or Break by pressing one of the FILL or BREAK buttons. The chosen Fill or Break will be played back, then the programmed Variation will be automatically selected. This is a sophisticated way of creating complex sequences of Fills and Variations.

Please note that, while Auto Fill is a Global setting, Fill Mode is tied to a Style or SongBook Entry.

Turning the key range on/off and setting the wrap-around point

Accompaniment Sounds, like the acoustic instruments they imitate, sound better in their natural range. When the accompaniment pattern exceeds this range, or goes over the wrap-around point, it can be transposed to fall in the best range.

- 1 Go to the Style Play > Style Controls > Range/Wrap page.

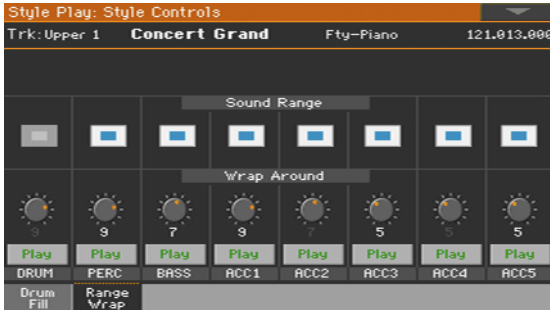

As an alternative, you can access these parameters in the Style Record > Style Tracks Controls > Range/Wrap page.



- 2 Use the Sound Range On/Off checkbox to turn the Key Range on/off for each Sound.

A preferred range is set in the Style Record > Element Track Controls > Range page for each track of each Style Element. You can turn it on/off for the whole Style.

Kbd Range	Meaning
On	The Sound's Key Range is considered. When a track goes over the lower or higher Key Range point, it is automatically transposed, to remain inside the programmed range.
Off	No Sound's Key Range considered. The track plays the real note.

- 3 Use the Wrap Around knob to set a wrap-around point.

The wrap-around point is the highest key for the accompaniment track. When the detected chord's pitch is too high, the Style pattern might be transposed to a range that is too high, therefore sound unnatural. So, when the pattern reaches the wrap-around point, it will jump to a lower octave.

It is advisable to set different wrap-around points for each track, to avoid that all tracks 'jump' to a different octave at the same time. For more realistic results, we suggest to consider the actual range of the real instrument.

Wrap Around	Meaning
1 ... 12	Maximum transposition (in semitones) of the track, referred to the original Key/Chord of the Style pattern.

Memorize the key range and wrap-around

- Write the Style Settings.

Choosing and mixing the Pads

You can assign four Pads to each Style. The new combination of Pads can then be written into the Style Settings.

Choosing the Pads

Open the Pad Select window

- 1 Be sure to be in the main page of the Style Play or Song Play mode. If you are not there, press either the STYLE PLAY or the SONG PLAY buttons in the control panel.
- 2 Select the Pad pane by touching the corresponding tab.

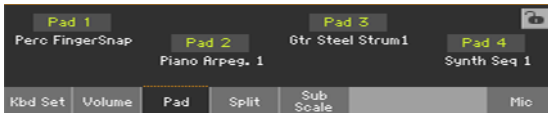

- 3 Touch the name of the Pad you want to change to open the Pad Select window.

Choose a Pad

- 1 Browse through the Pads in the Pad Select window.



- To choose one of the available types of Pads, touch the buttons at the top of the window.

Pad type	Meaning
Hit	While they are mostly used as non-transposing events, they can also be transposing notes or chords. Basically, they are single-note or single-chord Sequences (see below).
Sequence	Single-track patterns, that can be transposed by playing different chords on the keyboard - exactly as a Style track.
User	Freely available locations to save your own Pads (created or edited in Pad Record).

- To choose a different group of Pads, touch one of the tabs on the sides of the window.
 - To choose one of the available pages in the selected Pad group, touch one of the P1...P6 tabs at the bottom of the window.
- 2 Touch the name of the Pad you want to choose.
 - 3 If you want to close the Pad Select window (and it does not close by itself), press the EXIT button. (When a window does not close by itself, it means the Display Hold is turned on. See Display Hold on page 44).
 - 4 Repeat the above procedure for the other Pads.

Memorize the assigned Pads

- Write the Style Settings.

Pads can also be memorized into a SongBook Entry. See the instructions dedicated to the SongBook.

Mixing the Pads

Access the Pad page

- Go to the Style Play or Song Play > Pad/Switch > Pad page.

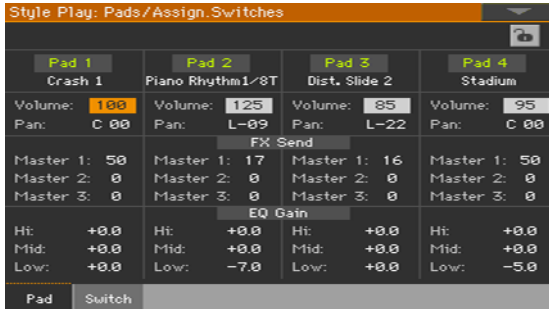

Choose the Pads

- While in this page, you can choose different Pads by touching the Pad name, and following the procedure seen above.

Adjust the volume and pan

- Use the Volume parameter to set the level of each Pad.
- Use the Pan parameter to set the position of each Pad in the stereo panorama.

Adjust the send level to the master effects

- Use the Master parameters to adjust the amount of the signal sent to the FX A Master effects.

Equalize the sound

- Use the EQ Gain controls to set the three-band equalizer for each Pad.

Memorize the Pad settings

- Write the Style Settings.

19 Writing the Style Settings

Writing the Style Settings

Style Settings can save Accompaniment Sounds and settings into a Style.

Note: Changes can normally only be saved onto Favorite, User or Direct Styles, and onto SongBook Entries. They cannot be saved onto Factory Styles.

Writing the Style Settings while in Style Play mode

Open the Write Current Style Settings dialog from the control panel

- While in Style Play mode, keep one of the STYLE buttons pressed for about one second.

Open the Write Current Style Settings dialog from the display

- While in Style Play mode, choose the Write Current Style Settings command from the page menu to open the Write Current Style Settings dialog.

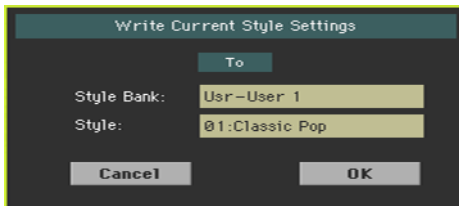

Write the Style Settings

- To write the current settings into the selected Style, touch the OK button.

Writing the Style Settings while in Style Record mode

In Style Record mode, you can write the Style Settings together with the Style.

- While in Style Record mode, choose the Write Style command from the page menu. Its Styles Settings are automatically saved. See Writing the Styles on page 306.

20 The Chord Sequencer

Recording Chord Sequences

You can record a Chord Sequence, that will play the chords for you. This will be useful, for example, when you have to play a repeated sequence, and prefer to use your left hand to play a solo on the keyboard, or to select the DNC controllers.

Recording a Chord Sequence while the Accompaniment is playing

You can start recording while the Arranger is playing.

- 1 Press the **START/STOP** button to start the automatic accompaniment.
- 2 Press the **CHORD SEQUENCER > RECORD (●)** buttons to start recording.

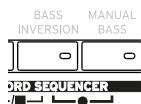

While in record, you will see the red Chord Record icon flashing in the display.



- 3 At the beginning of the next measure, start recording your Chord Sequence.
- 4 When the Chord Sequence is done, press the **CHORD SEQUENCER > RECORD (●)** buttons together again to stop recording.

The red Chord Record icon will disappear from the display.

The **CS** icon will appear next to the name of the Style, to show a Chord Sequence is available.

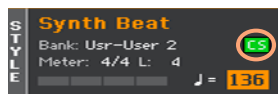

The Chord Sequence will remain in memory until you record a new Chord Sequence, choose a different Style or SongBook Entry, or turn the instru-

ment off. If the sequence is locked, it will not change when choosing a different Style or SongBook Entry.

Recording a Chord Sequence while the Accompaniment is not playing

- 1 Press the **CHORD SEQUENCER > RECORD (●)** buttons to enter recording mode.

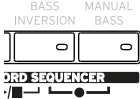

While in this mode, you will see the red Chord Record icon flashing in the display.



- 2 Play a chord, then start the automatic accompaniment in one of these ways:
 - Press the **START/STOP** button.
 - If the **SYNCHRO START** indicator is turned on, the accompaniment will start as soon as you play a chord.

The red Chord Record icon will continue flashing in the display.

- 3 Record your Chord Sequence.
- 4 When the Chord Sequence is done, press the **CHORD SEQUENCER > RECORD (●)** buttons together again to stop recording.

The red Chord Record icon will disappear from the display.

The Chord Sequence will remain in memory until you record a new Chord Sequence, choose a different Style or SongBook Entry, or you turn the instrument off. If the sequence is locked, it will not change when choosing a different Style or SongBook Entry.

Playing back a Chord Sequence

When the **CS** icon appears next to the name of the Style, a Chord Sequence is available in the selected Style or SongBook Entry.

Starting the Chord Sequence while the Accompaniment is playing

- 1 While the accompaniment is playing, press the **CHORD SEQUENCER > PLAY/STOP (▶/■)** buttons together to start the Chord Sequence.

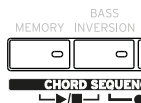

The indicators of the two buttons will start flashing. The Chord Sequence will be played back in loop starting from the next measure.

- 2 Play your solo part, while the Chord Sequence plays the chords for you.
During Chord Sequence looping, you can freely select any Fill or Variation, as if you were playing chords with your hands.
- 3 Press the **CHORD SEQUENCER > PLAY/STOP (▶/■)** buttons together again to stop the Chord Sequence. The button indicators will stop flashing.
If you stop the automatic accompaniment, the Chord Sequence is also stopped.

Starting the Chord Sequence with the Accompaniment

- 1 While the accompaniment is not playing, press the **CHORD SEQUENCER > PLAY/STOP (▶/■)** buttons together to start the Chord Sequence.

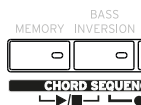

The indicators of the two buttons will start flashing.

- 2 Start the accompaniment. The Chord Sequence will immediately start playing.
- 3 Play your solo part, while the Chord Sequence plays the chords for you.
During Chord Sequence looping, you can freely select any Fill or Variation, as if you were playing chords with your hands.
- 4 Press the **CHORD SEQUENCER > PLAY/STOP (▶/■)** buttons together again to stop the Chord Sequence (or stop the accompaniment). The button's indicators will stop flashing.

Managing the Chord Sequences

Writing a Chord Sequence

The Chord Sequence can be memorized to the Style Settings or a SongBook Entry.

- Write the Style Settings or a SongBook Entry, and the Chord Sequence in memory will be automatically saved.

For information on how to write the Style Settings, see [Writing the Style Settings](#) on page 222. For information on how to write a SongBook Entry, see the [Editing the SongBook](#) on page 120.

Recalling a Chord Sequence

Each Style or SongBook Entry may contain a Chord Sequence.

- Choose a different Style or SongBook Entry to recall the memorized Chord Sequence.

If there is no Chord Sequence memorized, the one already in memory will be deleted.

Locking the Chord Sequence

If you prefer to keep the current Chord Sequence in memory, without letting a Style or SongBook Entry recall the memorized one, select the Chord Sequence lock.

- Go to the **Global > General Controls > Lock > Style** page, and select the Chord Sequence checkbox.

Deleting a Chord Sequence

To start anew, you can delete the Chord Sequence from memory.

- 1 Open the **Chord Sequence** dialog by choosing the **Chord Sequence Edit** command from the page menu.

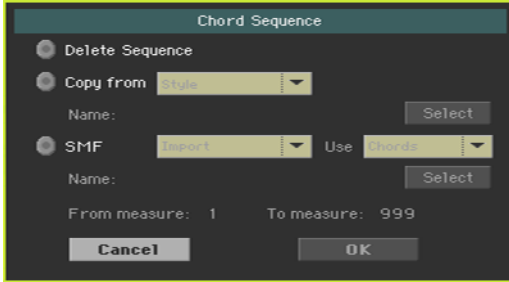

- 2 Choose the **Delete Sequence** option, and touch the **OK** button to confirm deletion.

At this point, you can save the Style Settings or SongBook Entry again, and the Chord Sequence will be gone from them.

Copying a Chord Sequence

You can copy a Chord Sequence from a different Style or SongBook Entry.

- 1 Open the **Chord Sequence** dialog by choosing the **Chord Sequence Edit** command from the page menu.
- 2 Choose the **Copy from** option, and use the pop-up menu to choose either a Style or SongBook Entry as the source.
- 3 Touch the **Select** button to choose the source Style or SongBook Entry.
- 4 When back to the **Chord Sequence** dialog, touch the **OK** button to confirm copying.

At this point, you can save the Style Settings or SongBook Entry again, and the copied Chord Sequence will be saved.

Importing a Chord Sequence from a Standard MIDI Files

You can import a Chord Sequence from a Standard MIDI File (MIDI Song, that is a MID file).

- 1 Open the **Chord Sequence** dialog by choosing the **Chord Sequence Edit** command from the page menu.
- 2 Choose the **SMF** option, and use the pop-up menu to choose the **Import** option.
- 3 Use the **Use** pop-up menu to choose between importing **Chords** (Chord events you might have recorded with a Backing Sequence Song, or included in a Standard MIDI Files as Lyrics events) or **Notes** (ordinary notes, recognized as chords).
- 4 Touch the **Select** button to choose the source Standard MIDI Files (MID file).
- 5 When back to the **Chord Sequence** dialog, use the **From** measure and **To** measure parameters to set a measure range from which to import from.

For example, you may want to only import the verse or chorus chords.

- 6 Touch the **OK** button to confirm importing.

At this point, you can save the **Style Settings** or **SongBook Entry** again, and the imported Chord Sequence will be saved.

Exporting the Chord Sequence

You can export a Chord Sequence to a Standard MIDI File (MID file), to be used in a MIDI Song.

- 1 Open the **Chord Sequence** dialog by choosing the **Chord Sequence Edit** command from the page menu.
- 2 Choose the **SMF** option, and use the pop-up menu to choose the **Export** option.
- 3 Touch the **OK** button to confirm exporting.
- 4 When the file selector appears, choose a folder where to save the exported file.

21 | Recording the Styles and Pads

How are Styles and Pads made?

KORG supplies a huge amount of professionally crafted Styles and Pads with Pa4X. However, you are free to customize them, or create totally new Styles and Pads on your own.

Styles and Pads share most of the same structure and recording/editing operations. Here is how they are made.

How Styles are made

Style Elements

Styles are music sequences automatically played by the Pa4X's arranger when you play a chord, to give you a realtime backing. A Style is made of a series of Style Elements (Intro, Variation, Fill, Ending...), each one corresponding to a section of a song. The Style Elements can be directly selected by using the corresponding buttons on the control panel (or selected by the Auto Fill function).

Chord Variations

Each Style Element is made of smaller units, called the Chord Variations. When you play in the chord recognition area, the arranger scans the keyboard and detects which chord you are playing. Then, depending on the selected Style Element, it chooses the right Chord Variation to be played for the recognized chord.

Which Chord Variation corresponds to each scanned chord is decided by the Chord Variation Table. Each Style Element contains a Chord Variation Table, whose general structure is the following:

Recognized Chord	Chord Variations (CV)	
	Variation 1-4	Intro 1-2, Count-In, Fill 1-4, Break, Ending 1-3
Major	CV1 - CV6	CV1 - CV2
6		
M7, M7 ^(b5)		
sus, sus2, M7sus		
m		
m6		
m7, m7 ^(b5) , m ^(M7)		
7, 7 ^(b5) , 7sus4		
dim, dim ^(M7)		
#5		
7 ^(#5) , M7 ^(#5)		
1+5, 1+8		
b5		
dim7		

Key/Chord

After deciding what CV to play, the arranger triggers the right sequence for each track. Since each sequence is written in a particular key (for example, CMajor, GMajor or Emin), the arranger transposes it according to the scanned chord. Notes in the sequence are carefully transposed, to make them work fine with all the recognized chords.

Tracks and Patterns/Sequences

Each Chord Variation is made of eight different tracks. DRUM and PERC are used for drum and percussion sequences, BASS for bass and ACC1-5 are for instrumental accompaniment sequences (string, guitar, piano or other accompaniment instruments).

What happens when you play a chord

To summarize, when you play a chord in the chord recognition area, the arranger determines which Style Element is in use, then determines which Chord Variation should be used for the recognized chord, then Style sequences for every track of that Chord Variation are transposed from the original chord to the recognized chord, and so on every time you play a chord.

Ordinary, Guitar and Drum tracks

There are different types of tracks, and each of them is treated in a different way by the arranger:

Track type	Meaning
Acc (Accompaniment)	When a chord is recognized, the programmed chord notes are transposed to a suitable scale, according to the Note Transposition Tables (NTT) The NTT table allows you to record just some Chord Variations, and have all the notes play in the right place, avoiding dissonances and transposing the pattern notes to the notes of the recognized chord.
Bass	It behaves like the Acc tracks, but playing the chord's root.
Drum	No transposition is applied. The original pattern plays always.
Perc (Percussion)	
Gtr (Guitar)	When a chord is recognized, the arranger triggers single notes, strumming and arpeggios on a 'virtual guitar', keeping care of how notes are played on the guitar fretboard. Please note that inside a Guitar track you can also find some sequence typical of an Acc track - a useful addition for short 'free-form' passages, like a short lead solo.

What to record in a Style

Recording a Style means recording tracks, inside a series of Chord Variations, inside a series of Style Elements, inside the Style itself.

You don't have to record all Chord Variations for all Style Elements. Often you only need to record a single Chord Variation for each Style Element. Exceptions are the Intro 1 and Ending 1, where we suggest to record both a Major and minor Chord Variations.

The Style structure

To explain the Style structure, we can use a tree structure, as shown in the following diagram:

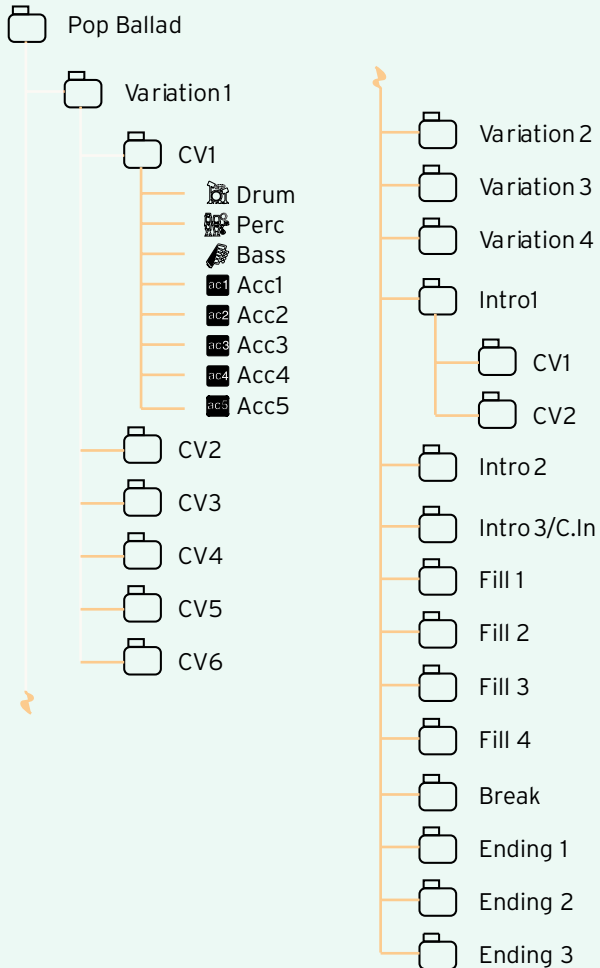

How Pads are made

The Pads

A Pad is basically a single-track, single Style Element Style. Most of what applies to Style recording also applies to Pad recording. There are two different categories of Pads: Hit and Sequence.

Pad type	Meaning
Hit	While they are mostly used as non-transposing events, they can also be transposing notes or chords. Basically, they are single-note or single-chord Sequences (see below).
Sequence	Single-track patterns, that can be transposed by playing different chords on the keyboard - exactly as a Style track.

Each Pad is made up of up to six smaller units, called Chord Variations (CV). Each Chord Variation is made of a single track (the Pad track).

Exactly as with the Styles, when playing a chord in the chord recognition area, the corresponding Chord Variation is recalled. Recognized chords are associated to a Chord Variation by means of the Chord Variation Table. Each Pad contains a Chord Variation Table.

The Pad structure

The Pad structure is the same of a single-track Style Element, as shown in the following diagram:

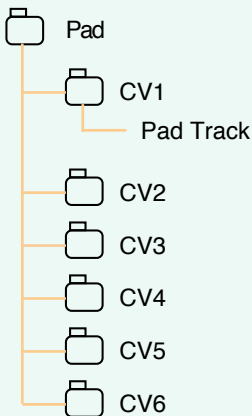

What to record in a Pad

Recording a Pad means recording a single track, inside a series of Chord Variations, inside the Pad itself.

You don't need to record all Chord Variations. It is often only needed to record just a single Chord Variation.

Recorded MIDI data

When recording Styles and Pads, non-supported events are filtered out. Here are the allowed events.

Recorded MIDI data	CC#
Note On	
RX Noise On	
Pitch Bend	
Channel After Touch	
Modulation	01
Breath	02
Pan	10
Expression	11
CC#12	12
CC#13	13
Ribbon	16
Damper (Hold 1)	64
Filter Resonance (Harmonic Content)	71
Low Pass Filter Cutoff (Brightness)	74
CC#80 (Sound Controller 1)	80
CC#81 (Sound Controller 2)	81
CC#82 (General Purpose #7)	82

Programming the Style Settings, then recording the musical sequences

The accompaniment track parameters are to be programmed separately from the actual recording of the musical sequences.

- 1 While in Style Play or Style Record mode, program the Style Settings as described in the previous pages and the pages dedicated to the more general Sound sets. You will program the containing track's parameters (like Volume, Pan, Octave Transpose, FX settings...). You will also choose and mix the Pads.

After having edited the track parameters in Style Play mode, save them to the Style Settings by choosing the **Write Current Style Settings** command from the page menu of the Style Play mode.

Editing done in Style Record mode can be saved by choosing the **Write Style** command from the page menu of the Style Record mode; the Style Settings will be automatically saved with the Style.

- 2 Go to the Style Record or Pad Record mode to create or edit the music sequences.

After having created or edited music sequences in Style/Pad Record mode, save them by choosing the **Write Style** or **Write Pad** command from the page menu of the Style/Pad Record mode.

Accessing the Style/Pad Record mode

Accessing Style Record

- 1 Press the STYLE PLAY button to go to the Style Play mode.
- 2 If you want to edit an existing Style, choose a Style to edit.
You can normally only edit Favorite, User or Direct Styles. To edit Factory Styles, you must first unprotect them, or copy them to a Favorite or User location.
- 3 Press the RECORD button. The Select Record Mode dialog will appear.



- Select Record/Edit Current Style to edit the current Style.
 - Select Record New Style to start from a new, empty Style. Default Style Settings will be recalled.
- 4 The main page of the Style Record mode will appear.

Accessing Pad Record

- 1 Press the STYLE PLAY button to go to the Style Play mode.
- 2 Press the RECORD button. The Select Record Mode dialog will appear.
 - Select Record/Edit Pad to edit an existing Pad.
 - Select Record New Pad to start from a new, empty Pad. Default Pad Settings will be recalled.
- 3 The main page of the Pad Record mode will appear.

The main Style Record page

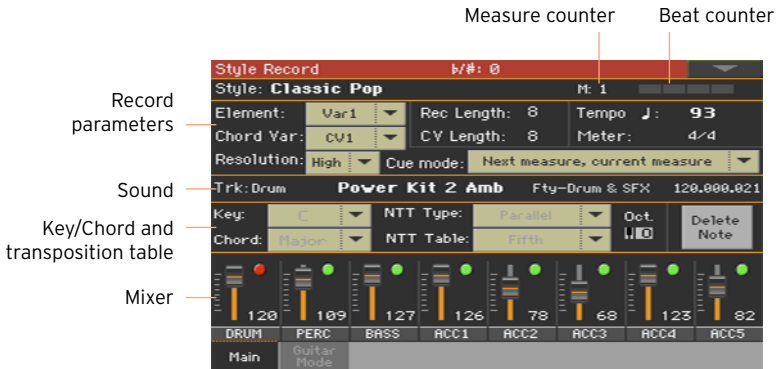

The main Pad Record page

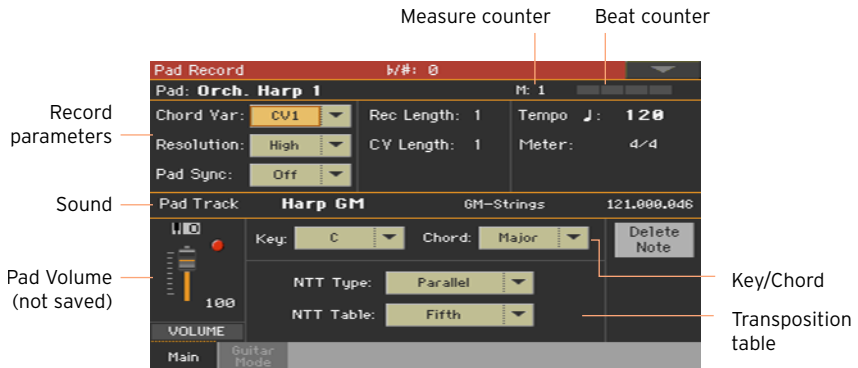

Exiting Style/Pad Record

- While in the Style/Pad Record mode, choose the Exit from Record command from the page menu, or press the RECORD button again.

Listening to the recorded Style

Testing chords

While in Style/Pad Record, the keyboard can play chords to drive the recorded musical patterns, and a piano sound to help you test the patterns. How chords are recognized depends on the status of the **SPLIT** indicator.

SPLIT indicator	Lower	Upper
On	Lower chord scan	Piano sound
Off	Full chord scan, piano sound	
Blinking	Full chord scan, no sound	

Listening to the results

- 1 Press the **START/STOP** button to check how the musical pattern works.
- 2 Play a chord, and test the patterns.
- 3 Press **START/STOP** again to stop playback.

Setting the recording parameters

Choosing what to record

Choosing the Style Element and Chord Variation

With Styles, you record a Chord Variation, inside a Style Element, inside a Style. This is the musical sequence you listen when playing a chord.

Pads are made of a single Style Element, so you only have to choose the Chord Variation.

- Go to the Style/Pad Record > Main page to choose the Chord Variation to be recorded, and set the recording parameters.

The parameters are in the Record Parameters box.

With Styles:

Element:	Var1	Rec Length:	8	Tempo ♩:	93
Chord Var:	CV1	CV Length:	8	Meter:	4/4
Resolution:	High	Cue mode:	Next measure, current measure		

With Pads:

Chord Var:	CV1	Rec Length:	1	Tempo ♩:	120
Resolution:	High	CV Length:	1	Meter:	4/4
Pad Sync:	Off				

- Use the Element pop-up menu to choose a Style Element.

Each Style Element corresponds to a button on the control panel carrying the same name. After selecting a Style Element, select a Chord Variation for actual editing (see below).

Style Element	Meaning
Var1 ... End3	Selected Style Element

- Use the Chord Var pop-up menu to choose a Chord Variation inside the selected Style Element (or Pad).

When an asterisk (*) appears next to the abbreviation (CV1* ... CV6*), the Chord Variation is empty.

Style Element	Chord Variation
Var1, Var2, Var 3, Var4	CV1 ... CV6
Intro1, Intro2, Intro3 (CountIn), Fill1, Fill2, Fill3, Fill4, Break, Ending1, Ending2, Ending3	CV1 ... CV2

Adjusting the total Chord Variation length

- Use the **CV Length** (Chord Variation Length) parameter to set the length of the Chord Variation (in measures).

The overall length of the selected Chord Variation can be 32 measures. When playing a Style or Pad, this will be the overall length of the musical sequence, when the corresponding chord is recognized on the keyboard.

Be careful not to decrease the Chord Variation length after recording, or any measure after the selected length will be deleted.

Adjusting the track's recording length

- Use the **Rec Length** (Recording Length) parameter to set the length (in measures) of the selected track (the one with the Record icon ()).

The value of this parameter is always equal to, or a divider of, the Chord Variation Length.

This is not the total length of the Chord Variation, just that of the current track. For example, you may want to record a Chord Variation eight measures long, with a drum pattern repeating every two measures. If so, set the **CV Length** parameter to 8, and the **Rec Length** parameter to 2 before starting to record the Drum track. When playing back the Style, saving it or executing any edit operation on the Style, the 2-measures pattern will be extended to the full 8-measures length of the Chord Variation.

If you assign to **CV Length** a value lower than **Rec Length**, the value of **Rec Length** is not immediately updated in the display. Therefore, you are still free of changing the value of **CV Length**, before the measures exceeding its value are deleted.

However, when you start recording the real **Rec Length** value is changed to the new one, even if the display still shows the old value.

For example, you may have **CV Length** = 4 and **Rec Length** = 4. If you set **CV Length** to 2, and press **START/STOP** to begin recording, **Rec Length** is still shown as 4, but it is in reality set to 2, and recording will cycle for just 2 mea-

tures. After you press START/STOP to stop recording, Rec Length is updated to 2, and all measures after the second measure are deleted.

Tempo, Meter, Resolution

Setting the recording Tempo

While recording, you might want to use a different Tempo than the one saved in the Style Settings. This alternative value will allow you, for example, to record at a slower speed, or to experiment with different values while listening what you recorded.

When playing Pads, the Tempo is always the one of the most recently selected Style or MIDI Song.

- Use the Tempo parameter to set the recording Tempo value.

As an alternative, use the TEMPO buttons to change the recording Tempo.

This value will not be saved in the Style or Pad.

Hint: In case you want to create Tempo variations in a Style, insert Tempo Change events in the Master Track (Style Record > Event Edit page). Pads always take Tempo values from the Style or Song.

Choosing the Meter of the Style Element or Pad

- Use the Meter parameter to set the meter (time signature) of the Style Element or Pad.





You can only edit this parameter if the Style Element or Pad is still empty.

Choosing the Resolution

- Use the Resolution parameter to set quantization during recording.

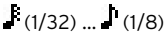
Quantization is a way of correcting timing errors; notes played too soon or too late are moved to the nearest axis of a rhythm grid, set with this parameter, thus playing perfectly in time.

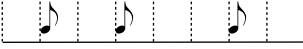
To quantize after recording, use the **Style/Pad Record > Style/Pad Edit > Quantize** function.

Resolution	Meaning
High	No quantization applied
 (1/32) ...  (1/8)	<p>Grid resolution, in musical values. For example, when you select 1/16, all notes are moved to the nearest 1/16 division. When you select 1/8, all notes are moved to the nearest 1/8 division. A '3' after the quantization value means triplet.</p> <p>No quantization </p> <p>1/16 </p> <p>1/8 </p>

Synchronizing

Cue mode for the Style Element

You can decide how a Variation or Fill Style Element will enter after having been selected.

- Go to the **Style Record > Main** page, and use the Cue mode pop-up menu to choose the way the Style Element will enter.

Cue mode	Meaning
Immediate, first measure	The Style Element enters immediately, and begins from the first measure. Only available on Fills.
Immediate, current measure	The Style Element enters immediately, and begins from the current measure. Only available on Fills.
Next measure, first measure	The Style Element enters at the beginning of the next measure, and begins from the first measure of the new pattern. Available on both Fills and Variations.
Next measure, current measure	The Style Element enters at the beginning of the next measure, and begins from the current measure. Only available on Variations.

Pad Sync

You can decide how the Pad will synchronize to the current Tempo.

- Go to the Pad Record > Main page, and use the Pad Sync pop-up menu to choose the way the Pad will synchronize.

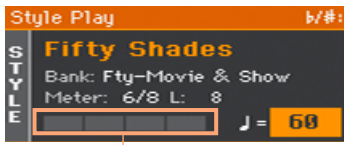
Pad Sync	Meaning
Off	No synchronization. The sequence will start as soon as you press the PAD button.
Continued	<p>Like a Fill, the pattern will start immediately, in sync with the Arranger's or active Player's Tempo. Depending on the current position of the beat counter, it might not start from its very beginning; instead, it will continue from the current position.</p> <p>For example, if the Arranger's or Player's beat counter shows the third beat, and is playing tick 91, the Pad will start from its third beat, at tick 91.</p>  <p>Beat counter</p>
Beat	The sequence will start at the next beat, in sync with the Arranger's or Player's Tempo. It will start from its very beginning (that is, tick 1 or measure 1).

Assigning Sounds to the Style Element and Pads

While in Style Record, you can assign different Sounds to each Style Element. These Sounds are used when the Original Sound Set parameter (that you can access in the Style Play > Main > Volume pane, when the accompaniment tracks are shown) is checked. Sounds assigned to the Style Settings are ignored.

Assigning different Sounds to each Style Element can be useful when you want, for example, to play a song's section or a single part with a different set of instruments.

Pads only have a single Style Element and track, so there is a single Sound for the whole Pad.

Assigning a Sound to a track of the Style Element

Choosing a Sound from the main record page

- 1 Go to the Style Record > Main page.
- 2 Choose a Style Element.
- 3 Touch the track to select in the mixer area.

The selected track will show the Record icon (). Information about the assigned Sound will appear in the dedicated area.

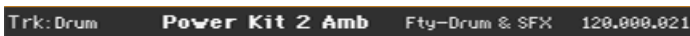

Selected track

Assigned
Sound

Sound bank

Program Change
sequence

- 4 Touch the name of the Sound to open the Sound Select window, and choose a Sound.

Choosing a Sound from other edit pages

- 1 Go to the Style Record > Main page.
- 2 Choose a Style Element.

- Go to any page of the Element Track Controls edit section, for example the Style Record > Element Track Controls > Expression page.



- Touch the icon of the Sound to be replaced, to open the Sound Select window, and choose a Sound.

Testing the Sounds

- Press the START/STOP button to check how the changes work. Press START/STOP again to stop playback.

Assigning a Sound to the Pad track

- Go to the Pad Record > Main page.
- Touch the name of the Sound to open the Sound Select window, and choose a Sound.

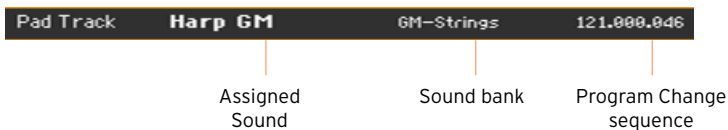

Transposing the Sounds while recording

While recording, you can transpose the accompaniment tracks, to make recording of low or high keyboard ranges easier. You can set a separate transpose value for each track.

- 1 Go to the main page of the Style/Pad Record mode.
- 2 Touch the corresponding mixer channel to choose a Style track.
- 3 Use the **UPPER OCTAVE** buttons on the control panel to transpose the selected track. The current value will appear in the **Oct** indicator.



Choosing the original key/chord and the note transposition table

You will record the musical sequences in a particular key (say, C), matching a chord shape (say, Major). You will then choose a transposition table according to which they will be transposed and transformed when a different key and a slightly different chord will be recognized.

Accessing the key/chord and note transposition table

- Go to the Style/Pad Record > Main page to choose the chord and transposition table.

The parameters are in the Record Parameters box.

With Styles:

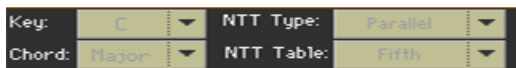

With Pads:

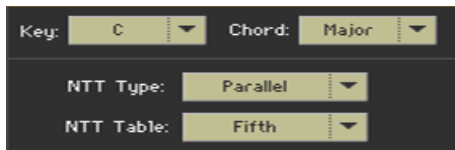

Choosing the Original Key/Chord for the selected track

- Use the Key and Chord pop-up menus to define the original key/chord root and chord type for the selected Style track (or the Pad track) in the current Chord Variation.

When playing this exact chord, the recorded patterns will play without any transformation. No transposition, no processing will be applied.

When you select a track, the original key/chord assigned to the selected track will be shown. All recorded tracks will play back on that same key/chord. For example, if the original key/chord for the Acc1 track is A7th, when selecting the Acc1 track all the other tracks will play on the A7th key/chord.

In the example above, you will record the Acc1 track in the AMajor key, with notes pertaining to the A7th scale. This exact pattern will be recalled when an A7th chord will be recognized.

These Key/Chord parameters don't apply to Guitar tracks, controlled by different transformation rules.

Hint: To conform to KORG specifications, it is advisable to record both the Major and minor Chord Variations for the Intro 1 and Ending 1 Style Elements.

Choosing an NTT table for the selected track

- Use the NTT Type and NTT Table parameters to choose an NTT table (Note Transposition Table) for the selected Style track (or the Pad track) of the current Chord Variation.

An NTT table is a set of sophisticated algorithms that allows KORG arrangers to convert recognized chords into musical patterns. The NTT table determines how the arranger will transpose pattern notes, when a chord is recognized that does not exactly match the original chord of a Chord Variation.

For example, if you only recorded a Chord Variation for the CMaj chord, when a CMaj7 is recognized on the keyboard the arranger must transpose some notes to create the missing 7th.

NTT parameters are not used by Drum and Percussion tracks, and are therefore dimmed when selecting these tracks.

There are two general types of NTTs:

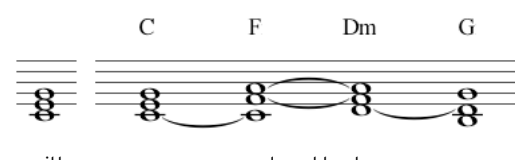
NTT Type	Description
Parallel	Notes are transposed inside the area set by the Wrap Around parameter. These tables are ideally suited to melody parts. 
Fixed	The arranger moves as few notes as possible, making legato lines and chord changes more natural. They are ideally suited to chord tracks (strings, piano etc...) 

These are the NTT Type/Table combinations:

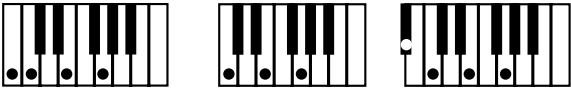
NTT Type/Table	Description
Parallel/Root	The root note (in CMaj = C) is transposed to the missing notes.
Parallel/Fifth	<p>The 5th note (in CMaj = G) is transposed to the missing notes.</p> <p>As recorded with NTT = Root or 5th (Key/Chord = C)</p> <p>When you play a C7 with NTT = Root</p> <p>When you play a C7 with NTT = 5th</p> 
Parallel/i-Series	<p>All original patterns must be programmed on the "Maj7" or "min7" chords. When loading old KORG i-Series Styles, this option is automatically selected.</p> <p>As recorded with NTT = i-Series (Key/Chord = CM7)</p> <p>When you play a C with NTT = i-Series</p> <p>When you play a C7 with NTT = i-Series</p> 
Parallel/No Transpose	The chord shape is not modified, and is moved to the new key unchanged. The pattern plays exactly the recorded notes, and is moved to the new key as it is. This is the standard setting of Intro 1 and Ending 1 in KORG's original Styles (where a chord progression is usually recorded).
Fixed/Chord	This table moves as few notes as possible, making legato lines and chord changes more natural. It is ideally suited to chord tracks (strings, piano etc...). Contrary to the Parallel mode, the programmed chord is not transposed according to the Wrap Around parameter, but always stays around its original position, looking for common notes between the chords.
Fixed/No Transpose	The programmed notes can only be transposed by the Master Transpose. They are never transposed when chords are changed.

To conform to KORG specifications, it is advisable to set the NTT table to 'No Transpose' on the Intro 1 and Ending 1.

Recording a Style or Pad in Realtime Record

After having chosen the Style Element and Chord Variation in the Main page, go on recording.

Using the metronome

- Press the METRONOME () button to turn the metronome on or off while recording.

Realtime recording

Select the Style track to record



- While in the Style Record > Main page, touch a track to enable it for recording. The Record icon () will appear.

Track	Description
Drum	Drum track
Perc	Percussion track
Bass	Bass track
Acc 1...5	One of the five instrumental Accompaniment tracks

Select the Pad track to record

Be sure the Pad track is enabled for recording. The Record icon () should appear.

Practice before recording

- 1 Mute the track to record, by repeatedly touching its status icon in the mixer channel. The Mute icon () will appear. Be sure any track already recorded is showing the Play () icon.
- 2 Press the START/STOP button to let any previously recorded track play back, and practice on the keyboard.
- 3 When you have finished practicing, press START/STOP to stop the arranger.

- 4 Set the track to record again, by repeatedly touching its status icon. The Record icon () will appear again.

Record

- 1 Press the **START/STOP** button to begin recording.

A 1-measure precount will play before the recording actually begins. When it begins, record freely.

While recording, the track's Keyboard Range is ignored, and notes can be recorded and played back over the full keyboard range. The Local Control parameter is also automatically set to On, to allow playing on the keyboard.

- 2 Recording will happen in cycle. The sequence will last for some measures, according to the **Rec Length** value, then start again from the beginning.

At any subsequent cycle, you can add notes and overdub the previous recording. This is very useful, for example, to record different percussive instruments at any cycle on a Drum or Percussion track.

- 3 When finished recording, press **START/STOP** to stop the arranger.

Record other tracks of the Chord Variation

- While the arranger is not running, select a different Style track and go on recording all the tracks of the current Chord Variation.

Record other Chord Variations of the Style Element or Pad

- When finished recording the Chord Variation, select a different Chord Variation to complete the Style Element or Pad.

Record other Style Elements of the Style

- When finished recording the Style Element, record the other Style Elements to complete the Style.

Deleting notes

Use the **Delete Note** button to delete a single note or a single percussive instrument from a track. For example, to delete a snare, keep the D2 note (corresponding to the snare) pressed.

- 1 Select a Style track.
- 2 Touch the **Delete Note** button, and keep it pressed.
- 3 Press **START/STOP** to start the sequence.

- 4 When you reach the passage containing the note to be deleted, play the note on the keyboard. Keep it pressed, up to the last note to be deleted.
If the note is at the beginning of the sequence, press the note before starting it.
- 5 When finished, release the **Delete Note** button and the note to be deleted, and press **START/STOP** again to stop the sequence.

Listening to the results

- Press the **START/STOP** button to check how it works. Press **START/STOP** again to stop playback.

Saving the Style or Pad

- When finished recording the new Style or Pad, choose the **Write Style** or **Write Pad** command from the page menu to save it.

Exiting the Style/Pad Record mode without saving

- To exit the Style/Pad Record mode without saving any change, choose the **Exit from Record** command from the page menu, or press the **RECORD** button.

Recording a Style or Pad in Step Record

Step Recording allows you to create a new Style or Pad by entering single notes or chords in each track one step at a time. This is very useful when transcribing an existing score, or in need of a higher degree of detail, and is particularly suitable to create drum and percussion tracks.

Step recording

Access Step Recording

- While in the Style/Pad Record > Main page, choose the Overdub Step Recording command from the page menu, to access step recording on the selected Style track (or the Pad track).

Style Element / Chord Variation Current position

Event list

Chord Variation Current position

Event list

Position the input pointer

- The Pos parameter shows the current position. This is where you will insert the next event.
- If you do not want to insert a note or chord at the current position, insert a rest instead, as shown below.
- To jump to the next measure, filling the remaining beats with rests, touch the Next M. button.

Choose a step value

- Use the Step Time values to choose the step value.

Choose the relative note duration

- Use the Duration parameter to set the relative note duration. The percentage is always referred to the step value.

Duration	Meaning
50%	Staccato
85%	Ordinary articulation
100%	Legato

Choose the note velocity

- Use the Velocity parameter to set the velocity or playing strength of the event to be inserted.

Velocity	Meaning
Kbd	Keyboard. Select this parameter by turning the VALUE controls completely counter-clockwise. When this option is selected, the playing strength of the played note is recognized and recorded.
1 ... 127	Velocity value. The event will be inserted with this velocity value, and the actual playing strength of the note played on the keyboard will be ignored.

Insert a note or rest at the current position

- To insert a single note, play it on the keyboard. The inserted note length will match the step length. You may change the velocity and relative duration of the note, by editing the Duration and Velocity parameters.
- To insert a rest, touch the Rest button. Its length will match the step value.

- To tie the note to be inserted to the previous one, touch the Tie button. A note will be inserted, tied to the previous one.

Insert a chord

- Play a chord instead of a single note. The event name will be the first note of the chord you pressed, followed by the '...' indicator.

Insert a chord made of notes with different velocity values

You can make the upper or lower note of a chord, for example, louder than the remaining ones, to let the most important note stand out from the chord.

- 1 Edit the first note's Velocity value.
- 2 Press the first note and keep it pressed.
- 3 Edit the second note's Velocity value.
- 4 Press the second note and keep it pressed.
- 5 Edit the third note's Velocity value.
- 6 Press the third note, then release all notes.

Insert a second voice

You can insert passages where one note is kept pressed, while another voice moves freely.

A few examples:

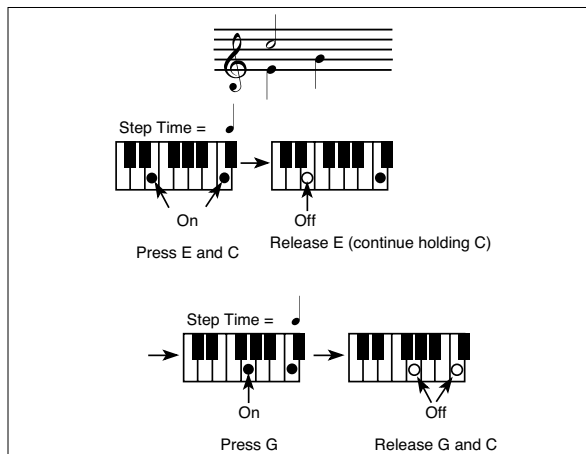

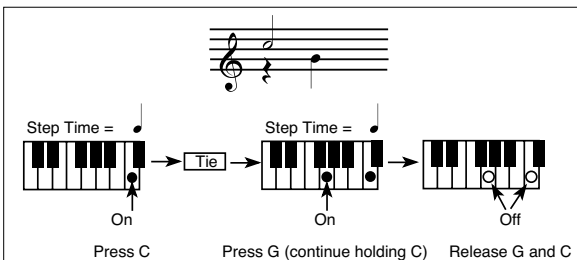
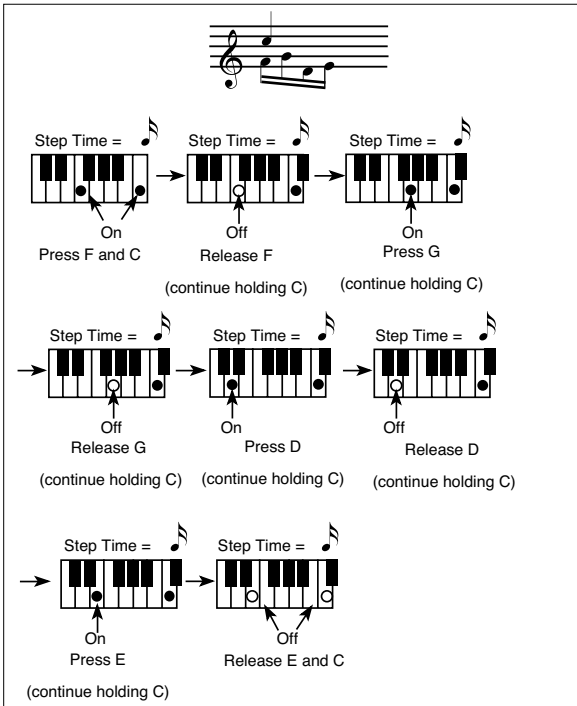

Go back

- If you want to go back, touch the Back button. This will delete the previously inserted event, and set the step in edit again.

Overdub recording

When the end of the pattern is reached, the 'End of Loop' event is shown, and the recording restarts from the '001.01.000' position. Any note exceeding the pattern length, inserted at its end, will be reduced to fit the total length of the pattern.

At this point, you may go on, inserting new events in overdub mode (the previously inserted events will not be deleted). This is very useful when programming a drum or percussion track, where you may want to program the bass drum on a first phase, the snare drum on a second phase, and the hi-hat and cymbals during the following phases.

Exit from record

- 1 When finished recording, touch the **Done** button to exit the Step Record mode.
- 2 A dialog box will appear, asking you to either cancel, discard or save the changes. Touch **Cancel** to continue editing, **No** to exit from the Step Record without saving, or **Yes** to save and exit Step Record.

Listen to your Style or Pad

- When back to the main page of the Style/Pad Record mode, you may turn all tracks to the play status, then press **START/STOP** to listen to the Style or Pad. Press **START/STOP** again to stop the playback.

Saving the Style or Pad

- When finished recording the new Style or Pad, choose the **Write Style** or **Write Pad** command from the page menu to save it.

Exiting the Style/Pad Record mode without saving

- To exit the Style/Pad Record mode without saving any change, choose the **Exit from Record** command from the page menu, or press the **RECORD** button.

Recording a Guitar track

Simulating a real guitar

Guitar Mode allows for easy creation of realistic rhythm guitar parts, without the artificial, unmusical playing typical of MIDI programming of guitar parts. Just record a few measures, and you will end up with realistic rhythm guitar tracks, where each chord is played according to its real position on the guitar, and not generated by simply transposing a written pattern.

Recording a Guitar track is unlike recording the other tracks, where you play exactly all the notes of a melody line or all the chords of an accompaniment part. With Guitar tracks you can either:

- Play the keys corresponding to the strumming modes.
- Play an arpeggio using the six keys corresponding to the six guitar strings (and the special keys corresponding to the root and fifth notes).
- Play RX Noises to add realism to the pattern.
- Add regular patterns, for short melodic passages without wasting an Acc track.
- Use the finest MIDI programming to select Chord Shapes, and recreate any nuance of a guitar performance.

Listening to the recorded pattern

While in Style/Pad Record, you can listen to the selected Chord Variation at the original Key/Chord.

When in Style Play mode, the recorded Guitar pattern is transposed according to the chord recognized on the keyboard. The way it is transposed depends on the programmed pattern, with the chosen positions, strumming mods, etc...

Preliminary settings

Accessing Guitar Mode in Style Record

- 1 While in the Style Record > Main page, select a track set to the Guitar type. This type of track is usually one of the Acc1...5 Style tracks.
To set a track to the Guitar type, go to the Style Record > Style Track Controls > Type/Trigger/Tension page.
After having selected a Guitar track, the Style/Pad Record > Guitar Mode page will become available.
- 2 Go the Style Record > Guitar Mode page.

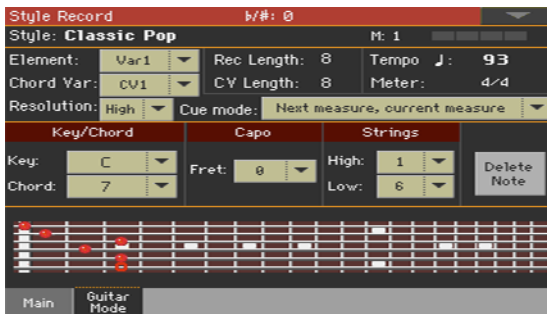

Accessing Guitar Mode in Pad Record

- 1 While in the Pad Record > Main page, set the Pad track to the Guitar type.
To set a track to the Guitar type, go to the Pad Record > Track Controls > Settings page.
After having selected a Guitar track, the Pad Record > Guitar Mode page will become available.
- 2 Go the Pad Record > Guitar Mode page.

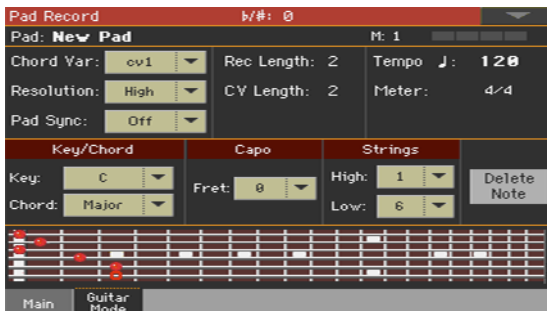

Reading the fingerboard diagram

You can see how a chord is composed on the fingerboard diagram. Here is the meaning of the various symbols:

Symbol	Meaning
Red dot	Fingered string (i.e., played note).
White dot	Fifth, playing on the D#2 key.
X	Non played or muted note.
Light grey bar	Barré (a finger crossing all the strings, like a mobile capo).
Dark grey bar	Capo.

Choosing a Key/Chord

The **Key/Chord** parameter pair works in a different way on Guitar tracks than on other track types. While with other tracks this is always the reference key used for NTT transposition, with Guitar tracks there is a difference, whether you are recording a Chord Variation contained in an Intro 1 or Ending 1 Style Element, or a Chord Variation contained in any other Style Element (or a Pad):

- On Intro 1 and Ending 1, this chord will be used as the reference key for the chord progression.
- On all the other Style Elements (or Pad), this chord will be used only for listening during recording. During playback, the chord will follow chord recognition.

With Intro 1 and Ending 1 (both Chord Variation 1 and 2) you may also want to enter a chord progression, to be played on the lowest MIDI octave (from C-1 to B-1). Chord types are inserted by using velocity values, as shown in the following table:

Vel.	Chord Type	Vel.	Chord Type
1	Major	2	Major 6th
3	Major 7th	4	Major 7th flatted 5th
5	Suspended 4th	6	Suspended 2nd
7	Major 7th suspended 4th	8	Minor
9	Minor 6th	10	Minor 7th
11	Minor 7th flatted 5th	12	Minor major 7th
13	Dominant 7th	14	7th flatted 5th
15	7th suspended 4th	16	Dimished

Vel.	Chord Type	Vel.	Chord Type
17	Diminished major 7th	18	Augmented
19	Augmented 7th	20	Augmented major 7th
21	Major w/o 3rd	22	Major w/o 3rd and 5th
23	Flatted 5th	24	Diminished 7th

As an example, a typical C Major progression will be entered as follows:

Chord	Root Note	Velocity
C Major	C-1	1
A Minor	A-1	8
D Minor	D-1	8
G Dominant 7th	G-1	13
C Major	C-1	1

Selecting a Capo

A capo (from the Italian 'capotasto', 'head of fingerboard') is a movable bar attached to the fingerboard of the guitar, to uniformly raise the pitch of all the strings. Its use makes the strings shorter, therefore changing the timbre and position of the chords (but not their shape).

This might prevent some strings to sound, depending on the chord position.

- Use the **Capo > Fret pop-up** menu to choose a Capo ('capotasto').

Capo	Meaning
0	Open string - no capo.
I ... XII	Position of the capo over the fingerboard (i.e., "I" corresponds to the first fret, "II" to the second one, and so on).

Selecting the lowest and highest strings

- Use the **Strings > High/Low** parameter pair to choose the highest and lowest strings to play. This is like playing only some of the strings.

String	Meaning
1 ... 6	Selected string. The pattern will be played between these strings.

Recording strummings

- Press one of the keys in the octave from C1 to B1 to select a strumming type. By pressing these keys, you play fast strumming samples.

Note	Strum
C1	Full Down
C#1	Full Down Mute
D1	Full Up
D#1	Full Up Mute
E1	Full Down Mute Body
F1	Full Down Slow
F#1	Full Down Slow Mute
G1	Full Up Slow
G#1	Up Mute 4-Strings
A1	Down 4-Strings
A#1	Down Mute 4-Strings
B1	Up 4-Strings



Recording single strings

- Press one of the keys in the octave from C2 to B2 to select single strings (one or more).

By pressing these keys, you can play arpeggios or power chords. You can either play a free arpeggio with the six guitar chords assigned to the keys from C to A, or play one of the faster arpeggios on the higher keys.

The root note is always available on the C# key, while the fifth note is always assigned to the D# key; with them, you can always play the lowest notes of an arpeggio.

This octave also includes an 'all mute' key (F#).

Note	String(s)
C2	VI String (E)
C#2	Recognized Chord Root
D2	V String (A)
D#2	Recognized Chord Fifth
E2	IV String (D)
F2	III String (G)
F#2	All Mute
G2	II String (B)
G#2	Power Chord
A2	I String (e)
A#2	Full Down/Up
B2	Down/Up 4-Strings



Recording RX Noises

RX Noises are noises generated on the guitar during a performance. They allow for increased realism.

- Press one of the keys in the octave from C7 to B8 to trigger RX Noises. In some cases, the RX zone may extend over this range.

Note	RX Noise
C7 and up	RX Noises (depending on the Sound)

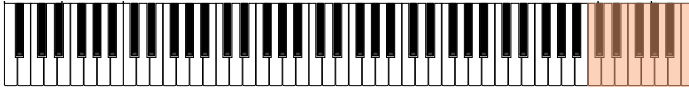

Recording a regular pattern

Together with strums and arpeggios, you can record regular patterns, exactly as if the track was of the Acc type. This will save an Accompaniment track, when all you need is just to record some short melodic passages (for example, the closing of a strumming pattern, or a lead solo during an Intro or Ending).

You can record the pattern by playing in the range from C3 to B6, as shown by the diagram.

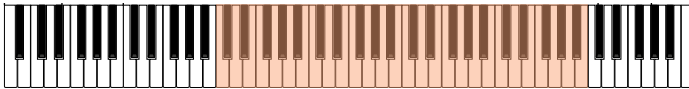

Recording a Chord Shape

You can finely choose Chord Shapes by using MIDI messages. When you play a CO note with the velocity value shown in the following table, a chord is played in a particular position and on a certain number of strings.

Playing the same chord with different positions in the same pattern will simulate the typical behaviour of a guitar player.

Vel.	Range	from Str.	to Str.	Position
0	6 Strings	I	VI	0
1	6 Strings	I	VI	0
2	6 Strings	I	VI	1
3	6 Strings	I	VI	2
4	6 Strings	I	VI	3
5	6 Strings	I	VI	4

Vel.	Range	from Str.	to Str.	Position
6	6 Strings	I	VI	5
7	5 Strings Bass	II	VI	0
8	5 Strings Bass	II	VI	1
9	5 Strings Bass	II	VI	2
10	5 Strings Bass	II	VI	3
11	5 Strings Bass	II	VI	4
12	5 Strings Bass	II	VI	5
13	5 Strings Treble	I	V	0
14	5 Strings Treble	I	V	1
15	5 Strings Treble	I	V	2
16	5 Strings Treble	I	V	3
17	5 Strings Treble	I	V	4
18	5 Strings Treble	I	V	5
19	4 Strings Bass	III	VI	0
20	4 Strings Bass	III	VI	1
21	4 Strings Bass	III	VI	2
22	4 Strings Bass	III	VI	3
23	4 Strings Bass	III	VI	4
24	4 Strings Bass	III	VI	5
25	4 Strings Middle	II	V	0
26	4 Strings Middle	II	V	1
27	4 Strings Middle	II	V	2
28	4 Strings Middle	II	V	3
29	4 Strings Middle	II	V	4
30	4 Strings Middle	II	V	5
31	4 Strings Treble	I	IV	0
32	4 Strings Treble	I	IV	1
33	4 Strings Treble	I	IV	2
34	4 Strings Treble	I	IV	3
35	4 Strings Treble	I	IV	4
36	4 Strings Treble	I	IV	5
37	3 Strings Bass	IV	VI	0
38	3 Strings Bass	IV	VI	1
39	3 Strings Bass	IV	VI	2

Vel.	Range	from Str.	to Str.	Position
40	3 Strings Bass	IV	VI	3
41	3 Strings Bass	IV	VI	4
42	3 Strings Bass	IV	VI	5
43	3 Strings MiddleBas	III	V	0
44	3 Strings MiddleBas	III	V	1
45	3 Strings MiddleBas	III	V	2
46	3 Strings MiddleBas	III	V	3
47	3 Strings MiddleBas	III	V	4
48	3 Strings MiddleBas	III	V	5
49	3 Strings MiddleTreble	II	IV	0
50	3 Strings MiddleTreble	II	IV	1
51	3 Strings MiddleTreble	II	IV	2
52	3 Strings MiddleTreble	II	IV	3
53	3 Strings MiddleTreble	II	IV	4
54	3 Strings MiddleTreble	II	IV	5
55	3 Strings Treble	I	III	0
56	3 Strings Treble	I	III	1
57	3 Strings Treble	I	III	2
58	3 Strings Treble	I	III	3
59	3 Strings Treble	I	III	4
60	3 Strings Treble	I	III	5
61	2 Strings Bass	V	VI	0
62	2 Strings Bass	V	VI	1
63	2 Strings Bass	V	VI	2
64	2 Strings Bass	V	VI	3
65	2 Strings Bass	V	VI	4
66	2 Strings Bass	V	VI	5
67	2 Strings MiddleBas	IV	V	0
68	2 Strings MiddleBas	IV	V	1
69	2 Strings MiddleBas	IV	V	2
70	2 Strings MiddleBas	IV	V	3
71	2 Strings MiddleBas	IV	V	4
72	2 Strings MiddleBas	IV	V	5
73	2 Strings Middle	III	IV	0

Vel.	Range	from Str.	to Str.	Position
74	2 Strings Middle	III	IV	1
75	2 Strings Middle	III	IV	2
76	2 Strings Middle	III	IV	3
77	2 Strings Middle	III	IV	4
78	2 Strings Middle	III	IV	5
79	2 Strings MiddleTreble	II	III	0
80	2 Strings MiddleTreble	II	III	1
81	2 Strings MiddleTreble	II	III	2
82	2 Strings MiddleTreble	II	III	3
83	2 Strings MiddleTreble	II	III	4
84	2 Strings MiddleTreble	II	III	5
85	2 Strings Treble	I	II	0
86	2 Strings Treble	I	II	1
87	2 Strings Treble	I	II	2
88	2 Strings Treble	I	II	3
89	2 Strings Treble	I	II	4
90	2 Strings Treble	I	II	5

22 Editing the Styles and Pads

Editing the track parameters

For each Style Element, and the Pad, you can edit various track parameters.

Hint: In the edit pages where the Style Element abbreviation appears, you can choose a Style Element by pressing the corresponding button on the control panel (VARIATION1 ... ENDING3).

Selected Style Element



Style Element/Pad relative volume (Expression)

You can set different Expression (CC#11) values for each of the Style Element tracks. Since Expression is a relative volume control, you can use it to lower the level compared to the overall volume of the Style. This is especially useful when different Sounds are assigned to the same track in different Style Elements, and the level of these Sounds is different.

With Pads, Expression can help balancing the Pads between them.

- 1 Go to the Style Record > Element Track Controls > Expression page.

Selected Style Element



You set the Expression value for the Pad in the Pad Record > Pad Track Controls > Settings page.

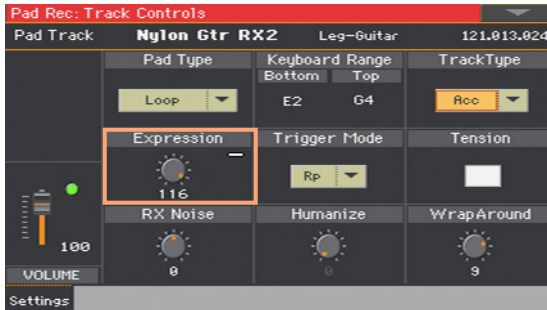

- 2 Press the corresponding button on the control panel to select one of the Style Elements (VARIATION1 ... ENDING3).
- 3 Use the Expression Monitor indicators to check if Expression (CC#11) messages are contained in the tracks.

Press the **START/STOP** button to start playback, and look at the indicators. When one of them lights up, you can enter Event Edit on the corresponding track, and edit or remove the Expression messages.

- 4 Use the Expression knobs to set the Expression (CC#11) value for the corresponding track. This value can be seen at the beginning of the Event Edit list.

Adjusting Expression

You can quickly and easily adjust the Expression level of all tracks in a Style Element. This allows for a more precise control over the volume level of all Style Element.

- 1 While in this page, select one of the Style Elements by pressing its button in the control panel.
- 2 Keep the **SHIFT** button pressed, and press the **TEMPO +** button to increase the Expression value of all the Style Element's tracks, **TEMPO -** to decrease it.
- 3 Release the **SHIFT** button.
- 4 Repeat the above operation with all the desired Style Elements.

A track's volume may be changed by an Expression event contained in a track. To check if any of these events exist in a track, let the Style Element play and look at the Expression Monitor in this same page. If one or more Expression events are found, go to the Event Edit page and delete or edit them.

- 5 Press the **START/STOP** button and play some chords to check how it works. Select any Style Element using the control panel button. Press **START/STOP** again to stop playback.

Keyboard Range

Setting the Keyboard Range automatically transposes any sequence note that would otherwise play too high or too low in pitch, compared to the original acoustic instrument's natural range, when transposed by the arranger. This will result in more natural sounding instruments.

For example, the standard lower limit for a concert flute is C4. If you play a chord under the C4, the transposed pattern could exceed this limit, and sound unnatural. A Bottom limit set to C4 for the flute track will solve the problem.

Different Keyboard Range values can be set for each Style Element. This will help forcing a preferred range in a particular section of the song, to simulate a particular piano comping style, or to avoid overlapping of instruments over different tracks.

- 1 Go to the **Style Record > Element Track Controls > Range** page.

Selected Style Element

Keyboard Range

Instrument	Top	Bottom
DRUM	C8	A0
PERC	G4	E1
BRSS	C8	A0
ACC1	E5	E2
ACC2	E5	E2
ACC3	E5	E2
ACC4	E5	E2
ACC5	C8	A0

Volume

Instrument	Volume
DRUM	120
PERC	109
BRSS	127
ACC1	126
ACC2	78
ACC3	68
ACC4	123
ACC5	82

DRUM Expression
PERC Range
BRSS Guitar Noise
ACC1 Scale

You set the Keyboard Range for the Pad in the Pad Record > Pad Track Controls > Settings page.

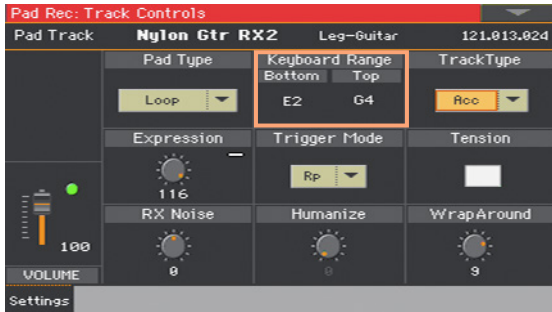

- 2 Press the corresponding button on the control panel to select one of the Style Elements (VARIATION1 ... ENDING3).
- 3 Use the Top and Bottom parameters to set the bottom and top limit of the keyboard range for the corresponding track of the selected Style Element.
While recording, the Keyboard Range is ignored. It will be used when playing back the Style.
- 4 Press the START/STOP button and play some chords to check how it works. Select any Style Element using the control panel button. Press START/STOP again to stop playback.

RX Noise/Guitar

In the Noise/Guitar page you can set the RX Noise level and the 'human feel' of the Guitar tracks.

- 1 Go to the Style Record > Element Track Controls > Guitar/Noise page.

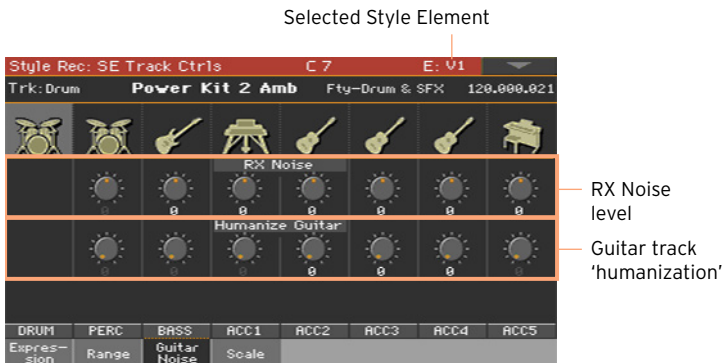

You set the RX Noise and Humanize parameters for the Pad in the Pad Record > Pad Track Controls > Settings page.

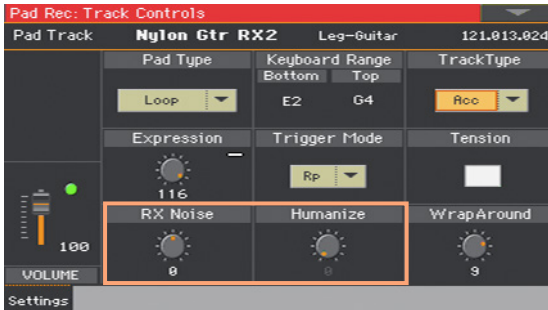

- 2 Press the corresponding button on the control panel to select one of the Style Elements (VARIATION1 ... ENDING3).
- 3 Use the RX Noise knobs to adjust the volume of RX Noises in the corresponding tracks. This control applies to all types of tracks (provided the Sound contains RX Noises).
- 4 Use the Humanize Guitar knobs to apply a random value to the position, velocity and length of notes of Guitar tracks. This only works on tracks set to the Gtr type in the Style Record > Style Track Controls > Type/Trigger/Tension page, or the Pad Record > Pad Track Controls > Settings page.
- 5 Press the START/STOP button and play some chords to check how it works. Select any Style Element using the control panel button. Press START/STOP again to stop playback.

Pad type

When triggered, Pads can play once or loop until you stop them.

- 1 Go the Pad Record > Pad Track Controls > Settings page.

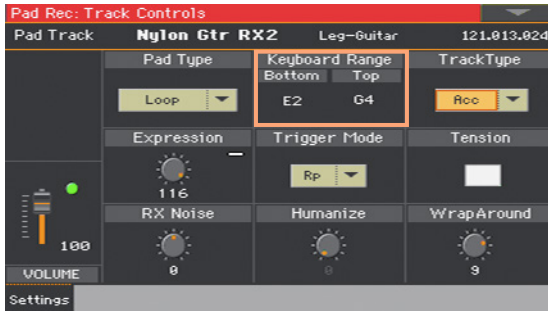

- 2 Use the Pad Type pop-up menu to choose the type of Pad.

Pad Type	Meaning
One Shot	When you press one of the PAD buttons, the corresponding Pad is only played once. This is useful for playing Hits or Sequences that must only play once.
Loop	When you press one of the PAD buttons, the corresponding Pad plays up to the end, then continues playing from the start. Press STOP in the PAD section to stop it playing. This is useful for playing cyclic sequences.

Please note that, while in Pad Record, the pattern is always played back in loop, even if this parameter is set to One Shot.

Editing the Chord Table

You can assign a Chord Variation to each of the main recognized chord. When a chord is recognized, the assigned Chord Variation will be automatically selected by the arranger to play the accompaniment.

- 1 Go to the Style Record > Chord Table & Variation > Chord Table page.

Selected Style Element

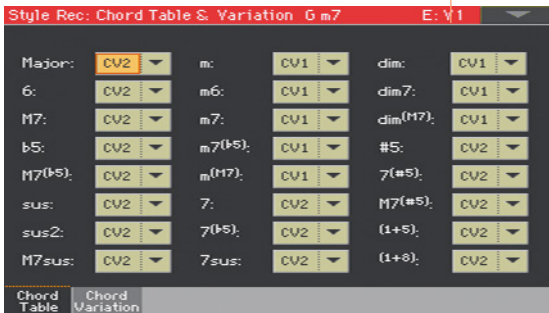

With a Pad, go to the Pad Record > Pad Chord Table > Chord Table page.

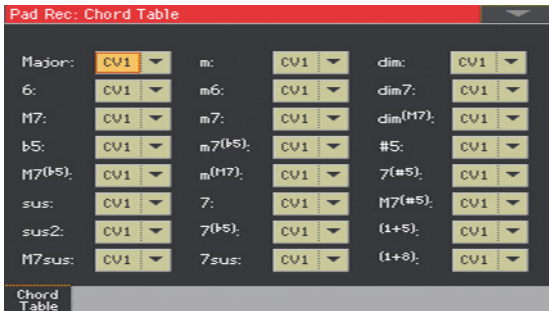

- 2 Press the corresponding button on the control panel to select one of the Style Elements (VARIATION1 ... ENDING3). Pads have no Style Elements.
- 3 Use the Chord / Chord Variation parameters to assign a Chord Variation to each of the chords.
- 4 Press the **START/STOP** button and play some chords to check how it works. Select any Style Element using the control panel button. Press **START/STOP** again to stop playback.

Checking the available Chord Variations

You can see which Chord Variations have been recorded (or imported) in the current Style.

- Go to the Style Record > Chord Table & Variation > Chord Variation page.

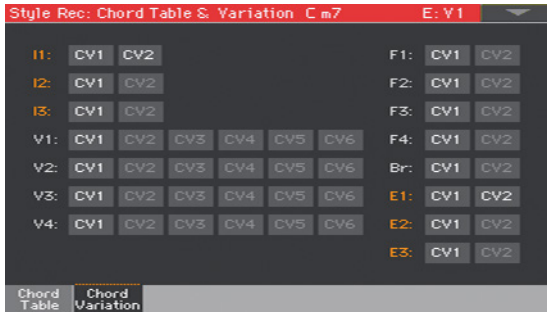

Dimmed Chord Variations are empty.

While in the Chord Table page you can see which Chord Variations have been used in the current Style Element, this page lets you see which Chord Variations are contained in the whole Style. If there are unused Chord Variations, you may choose to delete them to make the Style file lighter, or to assign them to a chord.

Editing the track type, trigger, tension

You can edit the track type, its response to retriggering, and add harmonic tension.

- 1 Go to the Style Record > Style Track Controls > Type/Trigger/Tension page.

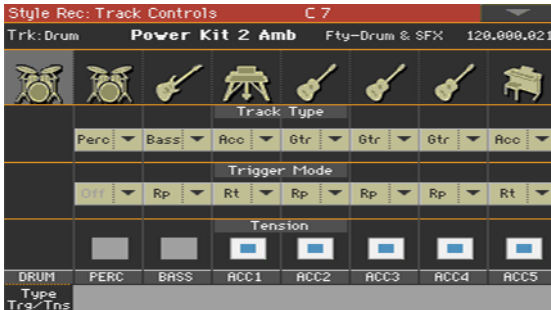

You can access these parameters for the Pad in the Pad Record > Pad Track Controls > Settings page.

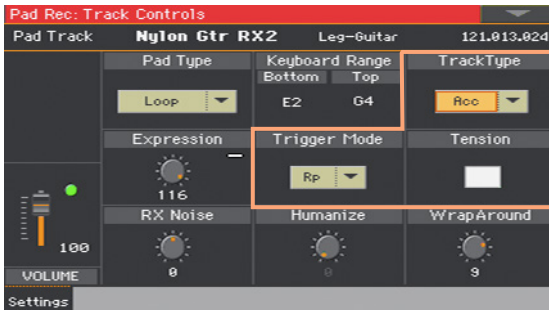

- 2 Press the corresponding button on the control panel to select one of the Style Elements (VARIATION1 ... ENDING3).

3 Use the Track Type parameter to set the type of the corresponding track.

Track Type	Meaning
Drum	Drum track. This type of track is not transposed by the arranger, and is used for Drum Kits made of Drum Sounds. It can be affected by Drum Mapping. With Pads, this is used for both Drum and Percussion sounds.
Perc	Percussion track. This type of track cannot be transposed, and is used for Drum Kit made of Percussion sounds. It is NOT affected by the Drum Mapping. (Not available with Pads.)
Bass	Bass track. This type of track always plays the root when changing chord.
Acc	Accompaniment track. This type of track can be used freely, for melodic or harmonic accompaniment patterns.
Gtr	Guitar track. This type of track uses Guitar Mode to create guitar strumming or arpeggios.

4 Use the Trigger Mode parameter to define how Bass and Acc-type tracks are retriggered when the chord is changed.

Trigger Mode	Meaning
Off	Each time you play a new chord, current notes will be stopped. The track will remain silent until a new note will be encountered in the pattern.
Rt (Retrigger)	The sound will be stopped, and new notes matching the recognized chord will be played back.
Rp (Repitch)	New notes matching the recognized chord will be played back, by repitching notes already playing. There will be no break in the sound. This is very useful on Guitar, Bass, Strings and Brass tracks.

5 Use the Tension checkbox to make the accompaniment's harmony richer and more interesting, by adding tension.

Tension adds notes (a 9th, 11th and/or 13th) that have actually been played to the accompaniment, but haven't been written in the Style pattern.

6 Press the START/STOP button and play some chords to check how it works. Select any Style Element using the control panel button. Press START/STOP again to stop playback.

Editing the Style/Pad sequences

You can edit the Style/Pad sequence data in the Style/Pad Record > Style/Pad Edit section. With Pads, you cannot select a track or Style Element to edit.

Quantizing

The quantize function may be used to correct any timing mistake after recording, or to give the pattern a 'groovy' feeling.

- 1 Go to the Style/Pad Record > Style/Pad Edit > Quantize page.

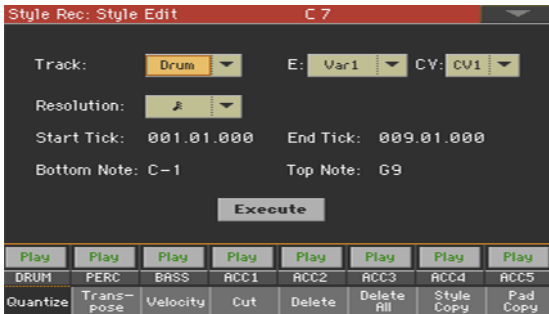

- 2 Select the Track, Style Element (E) and Chord Variation (CV) to edit.

Track	Meaning
All	All tracks selected
Drum ... Acc5	Selected track

- 3 Use the Resolution pop-up menu to choose the quantize resolution.

Resolution	Meaning
♩ (1/32) ... ♩ (1/4)	Grid resolution after recording, in musical values. For example, when you select 1/16, all notes are moved to the nearest 1/16 division. When you select 1/8, all notes are moved to the nearest 1/8 division. A 'b...' character added after the value means swing-quantization. A '3' after the quantization value means triplet.
No quantization	
1/16	
1/8	

- 4 Use the **Start Tick** and **End Tick** parameters to set the beginning and ending of the passage to be quantized.

If a Chord Variation is four measures long, and you want to select it all, the Start will be positioned at 1.01.000, and the End at 5.01.000.

- 5 Use the **Bottom Note** and **Top Note** parameters to set key range to edit.

These parameters are only available when a Drum or Percussion track is selected. If you select the same note as the Bottom and Top parameters, you can select a single percussive instrument in a Drum Kit.

- 6 After having set the various parameters, touch **Execute**.
- 7 Press the **START/STOP** button to check how it works. Press **START/STOP** again to stop playback.

Transposing

The transpose function may be used to transpose the selected track(s).

After transposing, please don't forget to readjust the **Key/ Chord** parameter in the main page of the **Style/Pad Record** mode.

- 1 Go to the **Style/Pad Record > Style/Pad Edit > Transpose** page.



- 2 Select the **Track**, **Style Element (E)** and **Chord Variation (CV)** to edit.

Track	Meaning
All	All tracks selected, apart for the tracks set in Drum mode (like the Drum and Percussion tracks). The whole selected Chord Variation will be transposed.
Drum ... Acc5	Selected track.

- 3 Use the **Value** parameter to choose the transpose value.

Value	Meaning
-127 ... 127	Transpose value (in semitones)

- 4 Use the **Start Tick** and **End Tick** parameters to set the beginning and ending of the passage to be transposed.

If a Chord Variation is four measures long, and you want to select it all, the Start will be positioned at 1.01.000, and the End at 5.01.000.

- 5 Use the **Bottom Note** and **Top Note** parameters to set key range to edit.

If you select the same note as the Bottom and Top parameters, you can select a single percussive instrument in a Drum Kit. Since in a Drum Kit each instrument is assigned to a different note of the scale, transposing a percussive instrument means assigning the part to a different instrument.

Selective transpose can also be used to avoid transposing RX Noises (transposing only notes under C7).

- 6 After having set the various parameters, touch **Execute**.
- 7 Press the **START/STOP** button to check how it works. Press **START/STOP** again to stop playback.

Editing Velocity data

You can change the velocity (dynamics) value of notes in the selected track.

When an RX Sound is assigned to the track being edited, the resulting sound may change, since this kind of Sounds is made of several different layers triggered by different velocity values.

Also, a fade-out may result in the level 'jumping' up next to the zero, since a higher-level layer may be selected by low velocity values.

- 1 Go to the Style/Pad Record > Style/Pad Edit > Velocity page.



- 2 Select the Track, Style Element (E) and Chord Variation (CV) to edit.

Track	Meaning
All	All tracks selected. The velocity for all notes of the whole selected Chord Variation will be changed.
Drum ... Acc5	Selected track.

- 3 Use the Velocity Value parameter to choose the transpose value.

Value	Meaning
-127 ... 127	Velocity change value (in MIDI value)

- 4 If you want to use the advanced parameters, allowing you to select a velocity curve and create fade-ins or fade-outs, select the **Advanced** checkbox.

When this parameter is selected, the **Intensity**, **Curve**, **Start Velocity Value** and **End Velocity Value** parameters become accessible.

- Use the **Intensity** parameter to specify the degree to which the velocity data will be adjusted toward the curve you specify with **Curve**.

Intensity	Meaning
0 ... 100%	Intensity value. With a setting of 0%, the velocity will not change. With a setting of 100%, the velocity will be changed the most.

- Use the **Curve** parameter to select one of the six curves, and specify how the velocity will change over time.

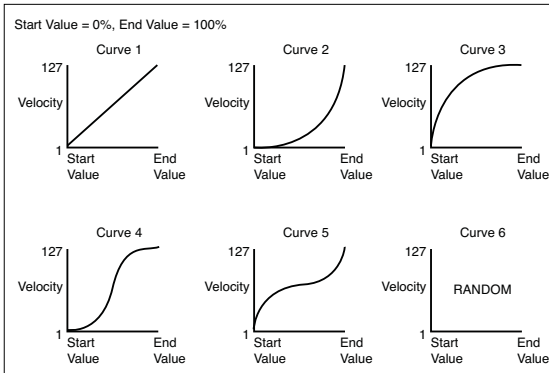

- Use the **Start Vel. Value** and **End Vel. Value** to change the velocity value at the starting and ending of the selected curve.

Intensity	Meaning
0 ... 100%	Velocity change in percentage

- 5 Use the **Start Tick** and **End Tick** parameters to set the beginning and ending of the passage to be edited.

If a Chord Variation is four measures long, and you want to select it all, the Start will be positioned at 1.01.000, and the End at 5.01.000.

- 6 Use the **Bottom Note** and **Top Note** parameters to set key range to edit.

If you select the same note as the Bottom and Top parameters, you can select a single percussive instrument in a Drum Kit. Selecting a range can also be used to only edit RX Noises (from C7) or ordinary notes (under C7).

- 7 After having set the various parameters, touch **Execute**.

- 8 Press the **START/STOP** button to check how it works. Press **START/STOP** again to stop playback.

Cutting out measures

You can delete a selected measure (or a series of measures) from the selected Chord Variation. All following events will be moved back, to replace the cut measure(s).

- 1 Go to the Style/Pad Record > Style/Pad Edit > Cut page.

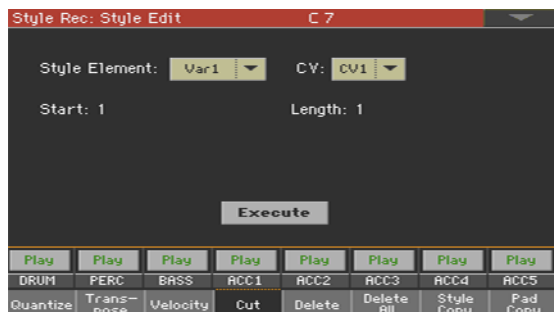

- 2 Select the Track, Style Element (E) and Chord Variation (CV) to edit.

Track	Meaning
All	All tracks selected
Drum ... Acc5	Selected track

- 3 Use the Start parameter to select the first measure to be cut.
- 4 Use the Length parameter to choose the number of measures to be cut.
- 5 After having set the various parameters, touch Execute.
- 6 Press the START/STOP button to check how it works. Press START/STOP again to stop playback.

Deleting data from measures

The Delete page is where you delete MIDI events out of the Style. This function does not remove measures from the pattern. To remove whole measures, use the Cut function instead.

- 1 Go to the Style/Pad Record > Style/Pad Edit > Delete page.



- 2 Select the Track, Style Element (E) and Chord Variation (CV) to edit.

Track	Meaning
All	All tracks selected. After deletion, the selected Chord Variation will remain empty.
Drum ... Acc5	Selected track.

3 Use the Event pop-up menu to choose the type of event to delete.

Event	Meaning
All	All events. The measures are not removed from the Chord Variation.
Note	All notes in the selected range.
Dup.Note	All duplicate notes. When two notes with the same pitch are encountered on the same tick, the one with the lowest velocity is deleted.
After Touch	After Touch events.
Pitch Bend	Pitch Bend events.
Prog.Change	Program Change events, excluding the bundled Control Change #00 (Bank Select MSB) and #32 (Bank Select LSB). This kind of data is automatically removed during recording.
Ctl.Change	All Control Change events, for example Bank Select, Modulation, Damper, Soft Pedal...
CC00/32 ... CC127	Single Control Change events. Double Control Change numbers (like 00/32) are MSB/LSB bundles. Some CC data are automatically removed during recording.

4 Use the Start Tick and End Tick parameters to set the beginning and ending of the passage to be deleted.

If a Chord Variation is four measures long, and you want to select it all, the Start will be positioned at 1.01.000, and the End at 5.01.000.

5 Use the Bottom Note and Top Note parameters to set key range to edit.

These parameters are available only when the All or Note option is selected. If you select the same note as the Bottom and Top parameters, you can select a single percussive instrument in a Drum Kit. Selecting a range can also be used to only edit RX Noises (from C7) or ordinary notes (under C7).

6 After having set the various parameters, touch Execute.

7 Press the START/STOP button to check how it works. Press START/STOP again to stop playback.

Deleting Style Elements, Chords Variations or a whole Style

You can delete a selected Style Element or Chord Variation, or the whole Style.

- 1 Go to the **Style/Pad Record > Style/Pad Edit > Delete All** page.



- 2 Select the Track to delete.

Track	Meaning
All	All tracks of the selected Style, Style Element or Chord Variation.
Drum ... Acc5	Single track of the selected Style, Style Element or Chord Variation.

- 3 Select the Style Element (E) and Chord Variation (CV) to delete.

E/CV	Meaning
All	All Style Elements, i.e. the whole Style. When E/Track=All and CV=All, the whole Style is deleted.
Var1 ... CountIn	Single Style Element.
V1-CV1 ... C1-CV2	Single Chord Variation.

- 4 After having set the various parameters, touch **Execute**.
- 5 Press the **START/STOP** button and play some chords to check how it works. Select any Style Element using the control panel button. Press **START/STOP** again to stop playback.

Copying from a Style

You can copy a track, Chord Variation or Style Element from the same or a different Style. Be warned that copying will overwrite all data at the target location.

- 1 Go to the Style/Pad Record > Style/Pad Edit > Copy from Style page.

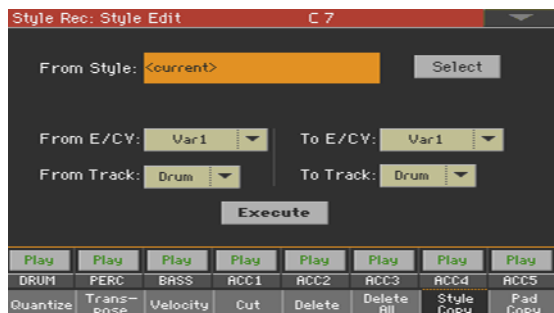

- 2 Use the From Style parameter to choose the source Style. Touch the **Select** button to open the **Style Select** window and select the source Style from there. Touch the **Current** button to select the current Style as the copy source.
- 3 Use the From E/CV pop-up menu to choose the source Style Element (E) and Chord Variation (CV), and the To E/CV pop-up menu to choose the target.

E/CV	Meaning
All	All Style Elements, i.e. the whole Style. You can't change the target, that is automatically set to All.
Var1 ... End2	Single Style Element.
V1-CV1 ... C1-CV2	Single Chord Variation.

Due to the different structure, you can only copy over similar Style Elements, for example from a Variation to another Variation.

- 4 Use the From Track pop-up menu to choose the source track, and the To Track pop-up menu to choose the target.

Track	Meaning
All	All tracks of the selected Style, Style Element or Chord Variation.
Drum ... Acc5	Single track of the selected Style, Style Element or Chord Variation.

- 5 After having set the various parameters, touch **Execute**.

When you copy over an existing Chord Variation, Program Change data is not copied, to leave the original Sounds unchanged for that Chord Variation. If you copy a complete Style Element (Var1, End1... etc.), Program Changes are also copied.

Copying from a Pad

You can copy a Chord Variation or all of a Pad's Chord Variations. Be warned that copying will overwrite all data at the target location.

- 1 Go to the Style/Pad Record > Style/Pad Edit > Copy from Pad page.

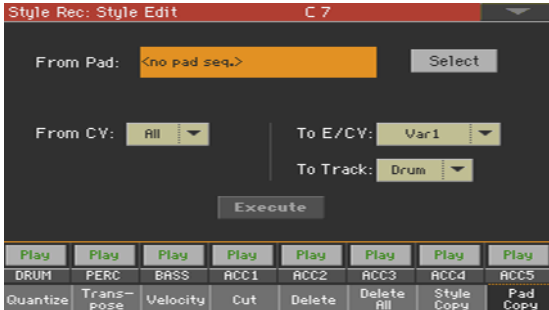

- 2 Use the From Pad parameter to choose the source Pad. Touch the Select button to open the Pad Select window and select the source Pad from there.
- 3 Use the From CV pop-up menu to choose the source Chord Variation (CV), and the To E/CV pop-up menu to choose the target.

E/CV	Meaning
Var1 ... End2	Single Style Element.
V1-CV1 ... CI-CV2	Single Chord Variation.

- 4 Use the To Track pop-up menu to choose the target in the Style where to copy the Pad track.

Track	Meaning
All	All tracks of the selected Style, Style Element or Chord Variation.
Drum ... Acc5	Single track of the selected Style, Style Element or Chord Variation.

- 5 After having set the various parameters, touch Execute.

When you copy over an existing Chord Variation, Program Change data is not copied, to leave the original Sounds unchanged for that Chord Variation.

Editing the MIDI events

The Event Edit is the page where you can edit each single MIDI event of the selected Chord Variation. You can, for example, replace a note with a different one, or change its playing strength (that is, velocity value).

The Event Edit page

- Go to the Style/Pad Record > Event Edit > Event Edit page.

a. Touch here to choose the track to edit

Position	Type	Value1	Value2	Length
M:001.01.000	Ctrl	11	100	
M:001.01.000	Note	B1	119	D:000.00.001
M:001.01.000	Note	F#2	78	D:000.00.001
M:001.01.192	Note	F#2	39	D:000.00.001
M:001.02.000	Note	E1	71	D:000.00.001

b. Edit the events

The Event Edit procedure

Here is the general procedure to follow for the event editing.

Choose the Style or Pad and access editing

- 1 While in **Style Play** mode, access recording by pressing the **RECORD** button and choosing one of the options (create or edit a Style or Pad).
- 2 While in the **Style/Pad Record > Main** page, select the Style Element (Style only) and Chord Variation to edit.
- 3 Go to the **Style/Pad Record > Event Edit > Event Edit** page.

Listen to the patterns

- Press the **START/STOP** button to listen to the selected Chord Variation. Press **START/STOP** again to stop it.

Filter the events shown

- Go to the **Style/Pad Record > Event Edit > Filter** page to select the events to hide.

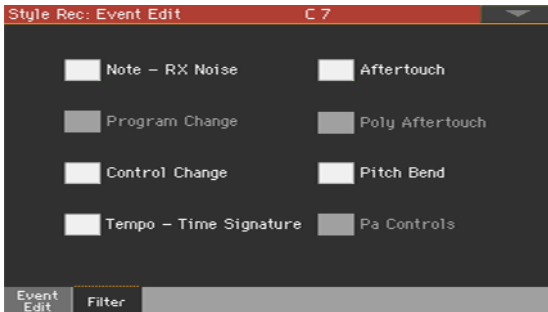

Filter	Meaning	
Note/RX Noise	Notes and RX Noises	
Program	Program Change	
Control	Control Change events. Only the following Control Change numbers are allowed with Styles.	
	Control function	CC#
	Modulation 1	1
	Modulation 2	2
	Pan	10
	Expression ^(a)	11
	CC#12	12
	CC#13	13
	Ribbon	16
	Damper	64
	Filter Resonance	71
	Low Pass Filter Cutoff	74
	Sound Controller 1 (CC#80)	80
	Sound Controller 2 (CC#81)	81
	CC#82	82
(a). Expression events cannot be inserted at the starting Position (001.01.000). An Expression value is already among the default 'header' parameters of the Style Element or Pad.		
Tempo/Meter	Tempo and Meter (time signature) changes (Master Track only).	
Pitch Bend	Pitch Bend events.	
Pa Controls	Messages exclusive to the Pa-Series instruments.	

Edit the events

- 1 Go back to the **Style/Pad Record > Event Edit > Event Edit** page.
- 2 Use the **Track** pop-up menu to select the track to edit in a Style. The Pad track is already selected.

The list of events contained in the selected track (inside the selected Chord Variation) will appear in the display. Some events on the beginning of the Chord Variations, as well as the 'EndOfTrk' event (marking its ending point) cannot be edited, and appear dimmed.

- 3 Scroll though the various events by using the scrollbar.

- 4 Touch the event to be edited, and edit it.

M:001.01.000	Note	C#2	64	D:000.00.096
Measure/Position	Type	Value 1	Value 2	Duration/Length

- Select the **M (Measure)**, and use the **VALUE** controls to change event's position.
- Select the **Type** parameter, and use the **VALUE** to change the event type.
- Select the **Value 1** and **Value 2** parameters, and use the **VALUE** controls to edit them. In case of numeric values, you can also touch them twice to open the numeric keypad.
- If a **Note** event is selected, select the **D (Duration/Length)** parameter, and use **VALUE** controls to change the event's length.

Jump to a different measure

- 1 Touch the **Go Meas.** button to go to a different measure. The **Go To Measure** dialog will appear.
- 2 Enter a target measure and touch **OK** to confirm. The first event available in the target measure will be selected.

Insert events

- Touch the **Insert** button to insert an event at the current **Position (M)**. A **Note** event with default values will be inserted.

Delete events

- Select an event, then touch the **Delete** button to delete it.

Edit other tracks

- When editing is complete, select a different track to edit.

Exit Event Edit

- When finished editing the selected **Chord Variation**, press the **EXIT** button to go back to one of the **Style Record > Record** pages, then select a different **Chord Variation** to edit.

Copying the Style track settings

Once you have edited a Style track, you can copy and paste its settings to another track, Chord Variation or Style Elements.

- 1 Choose the Copy command from the page menu to open the Copy Track Settings dialog.

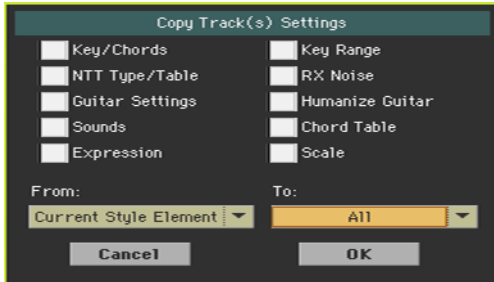

- 2 Check all the track settings you want to copy.
- 3 Use the From pop-up menu to choose the source Style Element.

Style Element	Meaning
Current Style Element	Settings will be copied from all the tracks of the current Style Element to all the tracks of the target Style Element(s).
Current Track	Settings will be copied from the selected track of the current Style Element to the same track of the target Style Element(s).

- 4 Use the To pop-up menu to choose the target Style Element.

Style Element	Meaning
All	Settings will be copied to all the Style Elements (whole Style).
All Var	Settings will be copied to all the Variation Style Elements.
All Fill/Break	Settings will be copied to all the Fill/Break Style Elements.
All Intro/Ending	Settings will be copied to all the Intro/Ending Style Elements.
Var1 ... End3	Settings will be copied to the selected Style Element.

23 Importing and exporting the Styles and Pads

Importing a Standard MIDI File to a Chord Variation

You can import Standard MIDI Files created on your preferred external sequencer, and transform them to a Chord Variation.

Preparing the MID file

The Standard MIDI File to be imported must be programmed as if it was one of Pa4X's Chord Variations. Here are the rules.

Importing Style Element / Chord Variation parameters

When importing an SMF, parameters like CV Length, Meter, Tempo Changes, Program Changes and Expression are recognized.

- The Chord Variation length is the same as the imported SMF. You can change length by changing the value of the CV Length parameter in the Style/Pad Record > Main page.
- Key/Chord, Chord Table, Expression, and any other Style Element parameter, must be manually programmed in the relevant Style/Pad Record pages.
- The starting Tempo, and each track's Volume, must be programmed as Style Settings data, and then saved in the Style Settings.
- Meter (Time Signature) Change is not allowed, therefore not recognized.

MIDI events

When importing, only the events allowed for recording are imported (as shown in the table on page 235). Some controllers are reset at the end of the pattern.

Sounds

Sounds assigned to each track are imported, provided the Program Change, Bank Select MSB and LSB events are on the first 'tick' of the SMF. These will be the 'original' Sounds of the Style Element, that you can access from the **Style Record > Main** page, or the **Style Record > Element Track Controls > Expression** page. These data are also the Sound of the Pad track.

These Sounds can be overridden by Sounds assigned to the Style Settings, when the **Original Style Sound** parameter in the **Style Play > Main > Volume** pane (accompaniment tracks shown) is not checked.

Note length

If a note extends beyond the last measure of the Chord Variation, an additional measure is appended (for example, if a note extends after the end of the fourth measure in a 4-measure pattern, a 5-measure Chord Variation will be generated). If so, change the CV Length value to reset the Chord Variation length. The exceeding note will be cut, to fit the new sequence length.

MIDI channels

When programming a Chord Variation on an external sequencer, please assign each Style track to the correct MIDI channel (In and Out), according to the following table.

Style Track	MIDI Channel
Bass	09
Drum	10
Percussion	11
Accompaniment 1	12
Accompaniment 2	13
Accompaniment 3	14
Accompaniment 4	15
Accompaniment 5	16

The Pad track is to be assigned to MIDI channel #10.

Importing a Standard MIDI File into a Chord Variation

- 1 Go to the Style/Pad Record > Import/Export > Import SMF page.

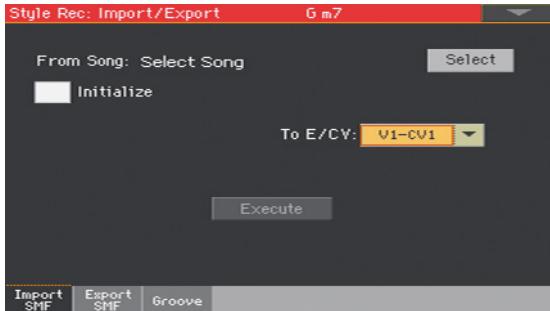

- 2 Use the From Song parameter to choose a MIDI file to import. Touch the Select button to open the file selector.
Only Standard MIDI Files in format 0 can be loaded.
- 3 Select the Initialize checkbox if you want all settings of the target Style Element or Pad (like Key/Chord, Chord Table, Sounds...) to be reset when loading the SMF.
It is a good idea to select the Initialize parameter when importing the first Chord Variation of a Style Element or Pad, and deselect it when importing the subsequent Chord Variations. This way, the initial parameter will be reset only once.
- 4 Use the To E/CV pop-up menu to choose a target Chord Variation (CV) inside a Style Element (E) or Pad.
- 5 After having set all the parameters in this page, touch the Execute button to import the Standard MIDI File into the target Chord Variation.

Importing a Standard MIDI File to a Style

Preparing a Standard MIDI File ‘separated by markers’

As an alternative to importing individual Chord Variations, you can convert a Standard MIDI File ‘separated by markers’ into a Style. This is a single Standard MIDI File containing all the Chord Variations and Style Elements (Variation 1, Variation 2, etc.) each one separated by a marker (the same events used in Song Play mode).

All the rules described in the section devoted to importing an individual Chord Variation apply. Style Tracks and MIDI Channels must be matched as in the previous table, as per KORG’s standard Style format definition. Tracks/MIDI Channels other than the above mentioned are ignored during the import procedure.

Importing a Standard MIDI File into a Style

- 1 Go to the Style/Pad Record > Import/Export > Import SMF page.



- 2 Use the From Song parameter to choose a MID file to import. Touch the Select button to open the file selector.
Only Standard MIDI Files in format 0 can be loaded.
- 3 Select the Initialize checkbox if you want all settings of the target Style Element or Pad (like Key/Chord, Chord Table, Sounds...) to be reset when loading the SMF.

When creating a new Style, we suggest to check the Initialize checkbox. Do not check it if the SMF you are loading was previously exported from a Style to be edited; in this case, it is very important to keep all the previous settings.

- 4 After having set all the parameters in this page, keep the **SHIFT** button pressed and touch the **Execute** button to import the Standard MIDI File.

Imported MIDI events

When importing, only the events allowed for recording are imported (as shown in the table on [page 235](#)). Some controllers are reset at the end of the pattern.

The following events are stripped off the sequence, and automatically transferred to the Style Element or Pad header during the import procedure:

- Time signature (this event is mandatory)
- Control Change bundle #00-32 (Bank Select MSB/LSB)
- Program Change

Control Change #11 (Expression), Control Change 00, Control Change 32 and Program Change messages must be placed at the very beginning of each Chord Variation (tick 0).

Whenever they are not saved in the SMF, Program Change, Control Change 00, 11 and 32, can be still programmed in Style Record mode, by using the edit features available.

Naming conventions

The naming structure for the markers inside the SMF is 'EnCVn', whose single components are shown in the following table:

Component	Meaning
E	Style Element ('v' = Variation, 'i' = Intro, 'f' = Fill, 'e' = Ending)
n	Style Element number ('1'~'4' for Variations, '1'~'2' for all other Style Elements)
CV	Chord Variation ('cv' = Chord Variation - no other choices allowed)
n	Chord Variation number 1~6 for Variations, 1~2 for all others]

It is mandatory not to use capital letters in marker names. Some examples of valid names:

- 'i1cv2' = Intro1 - Chord Variation 2
- 'v4cv3' = Variation 4 - Chord Variation 3

Examples of non accepted names:

- 'V1cv2', 'v1CV2', 'intro i1cv2', 'v1cv1 chorus'

The order of the Chord Variations inside the SMF is not relevant. They can be freely placed inside the SMF.

Pads always use names of this type: 'v1c1v' (they always start with 'v1').

Below, you can find a screenshot of a test file created in Steinberg Cubase, just as an example of how a SMF separated by markers can look like. Considering analogies between actual workstations, it will not look much different in other applications like Digital Performer, Logic Pro, Pro Tools or Sonar.

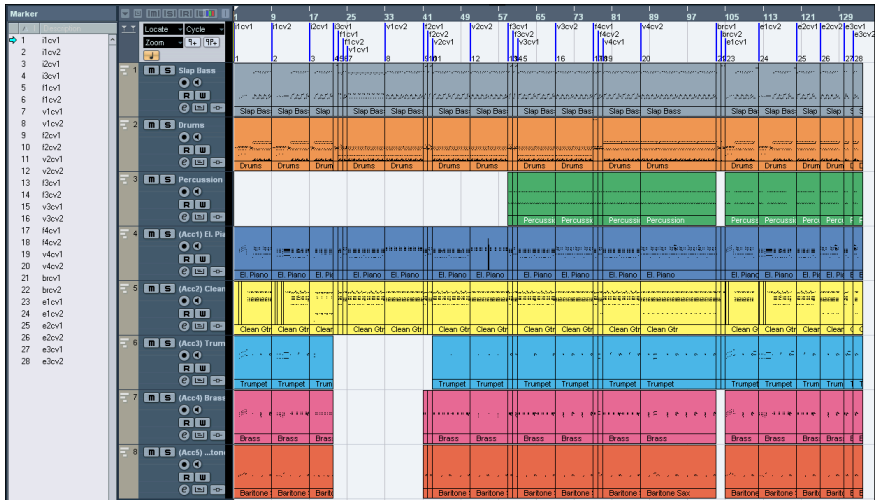

Importing a MIDI Groove to a Style or Pad

You can import a MIDI Groove created with the Time Slicing operation (in the Sampling). Importing a MIDI Groove is a step in the general procedure of creating an Audio Groove from an audio sample. You can find the procedure described on page 487. The Import Groove operation is described on page 494.

Exporting a Chord Variation

You can export a Chord Variation as a Standard MIDI File (MIDI file), then edit it on your preferred external sequencer.

Exporting a Chord Variation to a Standard MIDI File

- 1 Go to the Style/Pad Record > Import/Export > Export SMF page.



The (non editable) **To Song** parameter shows the name of the Standard MIDI File that will be generated. This (automatically assigned) name will be the same of the exported Chord Variation.

- 2 Use the **To E/CV** pop-up menu to choose the source Chord Variation (CV) from a Style Element (E) or the Pad.
- 3 After having set all the parameters in this page, touch the **Execute** button to export it as a Standard MIDI File. A standard file selector will appear. Select the target device and directory, then touch **Save**. A dialog box will appear, letting you assign a name to the file.

Exporting a Style to a Standard MIDI File 'separated by markers'

As an alternative to exporting single Chord Variations to individual Standard MIDI Files, you can export a whole Style as an SMF separated by markers, that is, a single SMF containing all the Chord Variations and Style Elements (Variation 1, Variation 2, etc.) each one separated by a marker (the same events used in Song Play mode).

- 1 Go to the Style/Pad Record > Import/Export > Export SMF page.



The (non editable) **To Song** parameter shows the name of the Standard MIDI File that will be generated.

- 2 Keep the **SHIFT** button pressed and touch the **Execute** button to export it as a Standard MIDI File. A standard file selector will appear. Select the target device and directory, then touch **Save**. A dialog box will appear, letting you assign a name to the file.

This operation will create, in the selected device, an SMF format 0 (Zero), containing all the MIDI data included in the selected Style or Pad, with each Chord Variation starting from a different marker (named as per the naming convention explained in the Import section above).

Each Chord Variation will include, at the very beginning (tick 0), the following informations:

- Time Signature
- Control Change bundle #00-32 (Bank Select MSB/LSB)
- Program Change
- Control Change #11 (Expression)

24 Converting a MIDI Song to a Style

The Style Creator Bot

You can convert any commercially or freely available MIDI Song (in Standard MIDI File format) into a complete Pa4X Style. While Pa4X includes a state-of-the-art converter of this type, and will most of the times result in a careful recreation of the original song, the quality of results may vary depending on the source song.

- 1 Press the STYLE PLAY button to switch to the Style Play mode.
- 2 Press the RECORD button to open the Style Record Mode Select dialog.

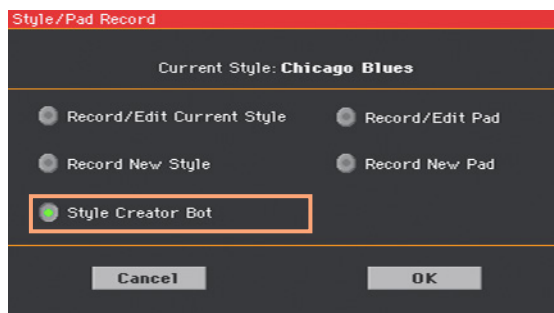

- 3 Choose the Style Creator Bot option and touch OK to open the file selector.



- 4 Select the source MIDI Song (.mid file), and confirm by touching Select.

- 5 When the conversion is complete, you are asked to write the new Style into a Style location. See the procedure in the next page.
- 6 After writing, the new Style is automatically selected. Fine-tune it with the functions seen in this part of the manual.

In the end, you will get a Style including all the Style Elements, the four Pads, the four Keyboard Sets and a Chord Sequence containing the chords recognized in the source MIDI Song.

25 Writing the new/edited Style or Pad

Writing the Styles

Styles can be saved into a Style memory location (usually, Favorite, User or Direct). When saving a Style, its Style Settings are automatically saved.

- 1 While in Style Record mode, choose the Write Style command from the page menu to open the Write Style dialog.

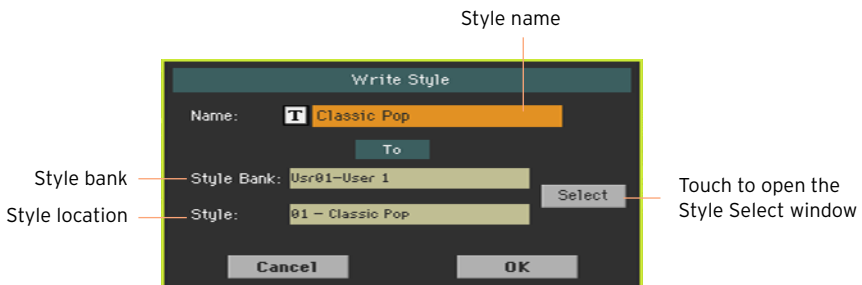

- 2 You may change the name of the Style. Touch the Text Edit (**T**) icon to open the virtual keyboard and edit the name.
When done editing the name, confirm by touching the OK button under the virtual keyboard.
- 3 When back to the Write Style dialog, if you want to save onto a different location touch the Select button and open the Style Select window. Choose

a location as if you were choosing a Style. Blank locations are shown as a series of dashes ('---').



- 4 When back at the Write Style dialog, confirm the Write operation by touching the OK button.

Creating the Favorite Style banks

You can create the Favorite Style banks in one of the following ways.

Load Styles into the Favorite Style locations

- While in the Media > Load page, you can load any Style into the Favorite banks.

Copy & paste onto Favorite Style locations

- While in the Style Select window, choose the Copy and Paste command from the page menu, to copy & paste any Style into the Favorite banks.

Save a recorded or edited Style into a Favorite Style location

- While in Style Record, choose the Write Style command from the page menu, and write the new or edited Style onto the Favorite banks.

Writing the Pads

Pads can be saved into a Pad memory location. After saving the Pads, assign up to four of them to a Style or SongBook Entry, that will recall them.

- 1 While in Pad Record mode, choose the Write Pad command from the page menu to open the Write Pad dialog.

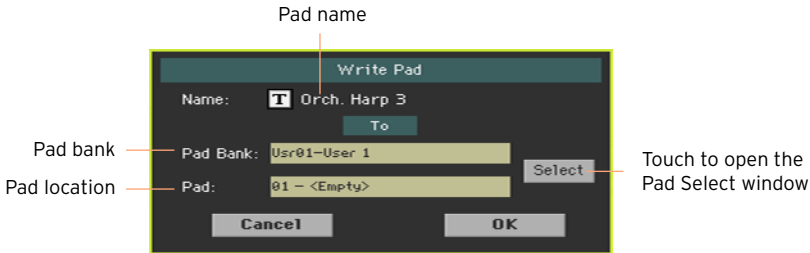

- 2 You may change the name of the Pad. Touch the Text Edit (**T**) icon to open the virtual keyboard and edit the name.

When done editing the name, confirm by touching the OK button under the virtual keyboard.

- 3 When back to the Write Pad dialog, if you want to save onto a different location touch the Select button and open the Pad Select window. Choose a location as if you were choosing a Style. Blank locations are shown as a series of dashes ('---').



- 4 When back at the Write Pad dialog, confirm the Write operation by touching the OK button.

**PART VI:
CUSTOMIZING,
RECORDING
AND EDITING
THE SONGS**

26 Customizing the Songs

How to play a Song - Song Play vs. Sequencer mode

The Players are just that - players. So, to prevent undesired changes to the file, no changes made in Song Play mode can be saved. To save changes to a MIDI Song, load and edit it in Sequencer mode.

However, you can do on-the-fly edits to the MIDI Song Sounds exactly as you would with the Keyboard Sounds. See the [Customizing and editing the Sound sets](#) section for more information.

In the following pages, you will find quick information on how to set the Sound volume and the play/mute status of the Song tracks.

Special tracks (Melody, Drum & Bass), Fast Play

Choosing the Melody track

You might want to define a Player's track as the Melody track. You will then be able to mute it by using the Song Melody - Mute function, that you can assign to a switch, footswitch or EC5 switch. See the **Controllers** part for information on how to program the controllers.

- 1 Go to the Global > Mode Preferences > Song & Seq page.
- 2 Use the SMF Melody Track pop-up menu to choose one of the Song tracks to be used as the Melody track.

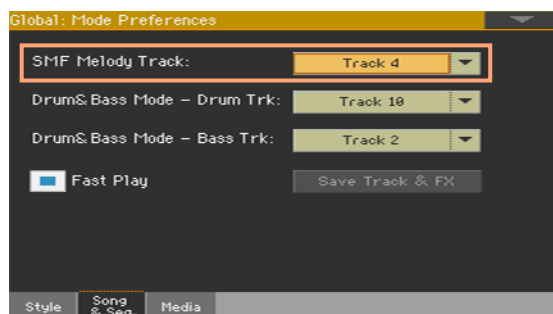

Choosing the Drum & Bass tracks

You can define two MIDI Song's tracks as the Drum and Bass tracks. These tracks will play when selecting the Drum&Bass function, that you can assign to a switch, footswitch or EC5 switch. See the **Controllers** part for information on how to program the controllers.

- 1 Go to the Global > Mode Preferences > Song & Seq page.
- 2 Use the Drum & Bass Mode - Drum pop-up menu to choose one of the Song tracks to be used as the Drum track.

- Use the Drum & Bass Mode - Bass pop-up menu to choose one of the Song tracks to be used as the Bass track.

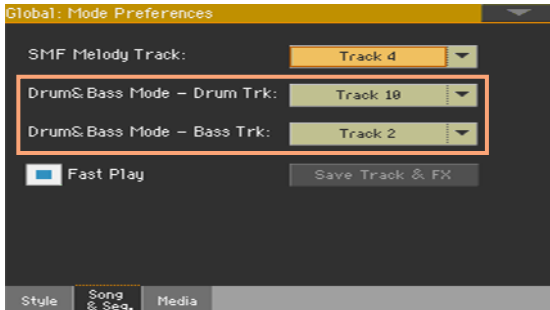

Letting a MIDI Song start immediately

MIDI Songs (MID and KAR files) may contain a silent setup measure at the beginning. You can skip this measure and let the Song start immediately.

- Go to the Global > Mode Preferences > Song & Seq page.
- Select the Fast Play checkbox to let the MIDI Songs ignore the silent setup measure at the beginning.

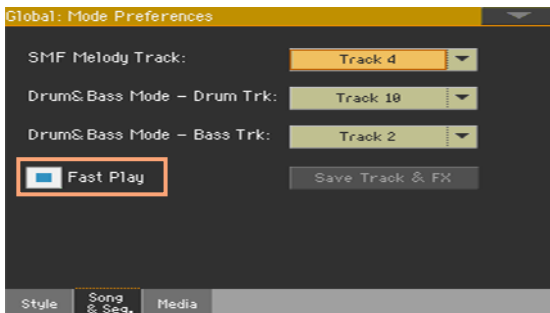

While the beats are skipped, setup data they may contain are read and considered.

Please note that MP3 Songs, being audio data, are not affected by this option.

Mixing the Song Sounds

Adjusting the volume of the individual MIDI Song Sounds

As you can do with the Keyboard Sounds, you can adjust the volume of the individual MIDI Song Sounds. However, since MIDI Songs are already dynamically mixed by the original creators, their volume may automatically change during playback.

The volume of the MIDI Song tracks will be reset when choosing a different Song.

Adjust the Sound volume levels from the control panel

- 1 While in any page of the Song Play mode, be sure the lighted SLIDER MODE indicator is VOLUME.
- 2 Use the X-FADER slider to select the active Player.
- 3 Be sure one of the SLIDER indicators under the sliders (1...8 or 9...16) is turned on, otherwise press the TRACK SELECT button to turn it on.

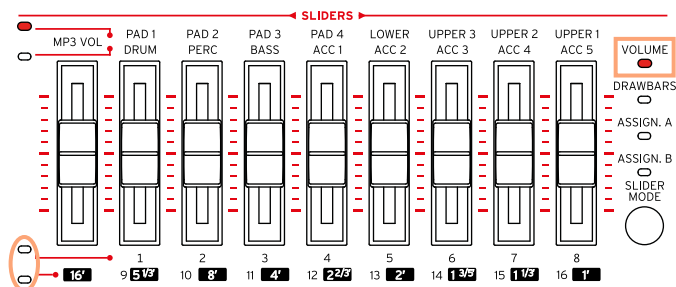

- 4 Use the sliders to adjust the volume of the corresponding Sounds.
- 5 Keep the SHIFT button pressed, and move any of the sliders to proportionally change the volume of all the MIDI Song Sounds.
- 6 When done, press the TRACK SELECT button again to switch back to controlling the Keyboard Sounds.

Adjust the Sound volume levels from the display

- 1 While in the main page of the Song Play mode, touch the Volume tab to select the Volume pane.



Here, you can adjust the volume of the Keyboard Sounds.

- 2 Use the X-FADER slider to select the active Player.
- 3 Press the TRACK SELECT button to switch to Song tracks 1-8. Press it again to see Song track 9-16.

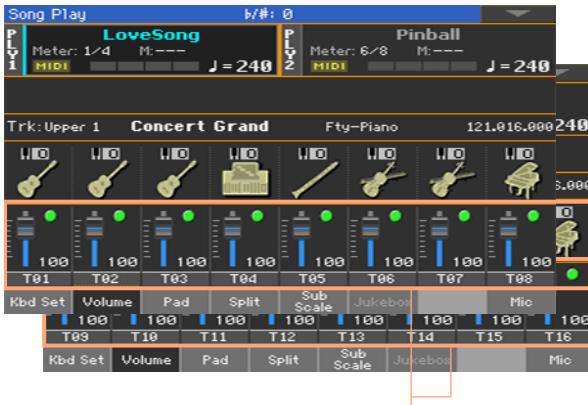

Song tracks

- 4 Touch the mixer channel whose volume level you want to change.
- 5 Keep the virtual volume slider held on the screen, and drag it to the desired level.

As an alternative, use the VALUE controls to change the volume level of the selected channel. Also note that, while in these pages, the physical sliders will continue to work as usual.

- 6 When done, press the TRACK SELECT button again to switch back to the main page.

Muting the individual MIDI Song Sounds

As you can do with the Keyboard Sounds, you can mute/unmute the individual MIDI Song Sounds. Mute the Song track that you will want to play or sing live (the melody track in a MIDI Song is usually #04).



See the Song tracks

- While in the Main page, touch the Volume tab to select the Volume pane, then press the TRACK SELECT button a first time to switch to Song tracks 1-8, a second time for Song tracks 9-16.



Song tracks

Mute/unmute the Song tracks

- Touch the Play () or Mute () icon in the mixer channel to turn the Sounds on or off.

Return to the Main page

- When done, press the TRACK SELECT button again to switch back to the Main page and see the Keyboard Sounds.

Memorize the track status

- Write the Song Play Settings.

Soloing a MIDI Song Sound

You can solo a MIDI Song Sound exactly as you would do with a Keyboard Sound.

- While the **Volume** pane is shown, or while in any page where the digital mixer appears, keep the **SHIFT** button pressed, and touch the mixer channel that you want to listen in solo.
- As an alternative, while in any page where the name of the **Sound** or the mixer channel appears, select it and choose the **Solo Track** command from the page menu.

Changing the Sounds of the MIDI Song tracks

Changing the MIDI Song Sounds

You can assign different Sounds to the current MIDI Song. These Sounds will be reset when choosing a different Song.

Choose a different Sound for a Song track

- 1 While in the main page of the Song Play mode, touch the Volume tab to select the Volume pane.
- 2 Press the TRACK SELECT button to switch to Song tracks 1-8. Press it again to see Song track 9-16.
- 3 Touch the name of the Song track whose Sound you want to change.



- 4 Touch a Sound icon to select the corresponding track.
- 5 Touch it again, to open the Sound Select window, then choose a Sound.

Transposing the MIDI Song Sounds

If needed, set the Octave Transpose for each track.

- 1 Go to the Mixer/Tuning > Tuning page.

You can go to this page by keeping the SHIFT button pressed, and pressing one of the UPPER OCTAVE buttons.

- 2 Use the Oct. Transpose knobs to set the octave.

27 Writing the Song Play Settings

Writing the default Players' settings

When you choose a different Song, switch to a different mode or turn the instrument off, all changes to the Song will be reset. If you want to preserve the current configuration for all the subsequent MIDI Songs, write it to memory.

Write the Song Play Settings

- Go to the Global > Mode Preferences > Song & Seq. page, and choose the Write Song Play Track & FX command from the page menu.

The following parameters will be saved:

- Play/Mute status of the Song tracks
- Internal/External status of the Song tracks
- Default FX A Group effect settings
- EQ settings for the Song tracks

When loading MIDI Songs created on a KORG Pa-Series instrument (or the HAVIAN 30 digital ensemble piano), these settings might be changed by the special data they contain.

28 Listening the MIDI Songs in Sequencer mode

Loading and listening a MIDI Song

Listening MIDI Songs in the Sequencer mode is especially useful when you want to check the results of any editing carried on on the Song tracks, without having to switch to the Song Play mode.

Loading a MIDI Song

- 1 Press the SEQUENCER button to go to the main page of the Sequencer mode.

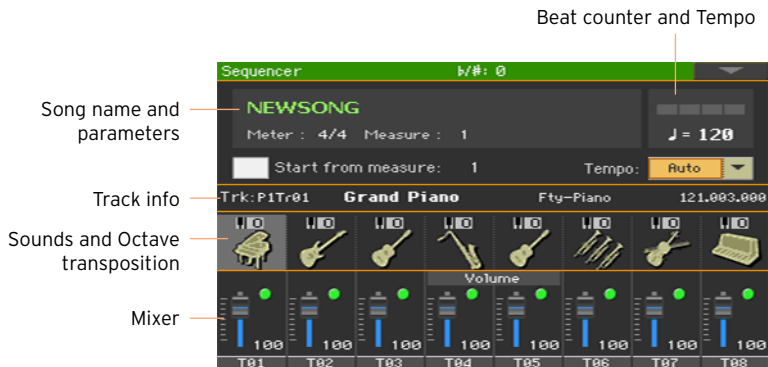

- 2 Touch the name of the Song to open the Song Selection window.

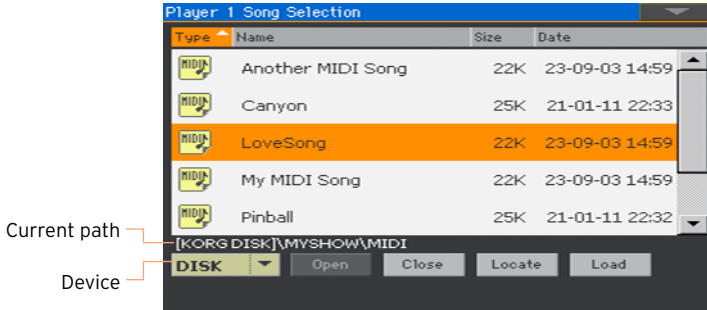

- 3 Browse through the files and folders. When you see the MIDI Song (.mid, .kar) you want to load, touch it, then touch the Load button to load it.

Importing a MIDI Song without initializing the current settings

While in the Sequencer mode, you can import a MIDI Song without initializing the current Sequencer settings. This is useful when you are, for example, programming a Song on an external sequencer, and at the same time editing the Sounds, Effects, EQ, Volume Levels, Pan values, Drum Family parameters, etc., right on the Pa4X. Importing the MID file will not reset these settings.

- 1 Press the SEQUENCER button to go to the main page of the Sequencer mode.
- 2 Choose the Import command from the page menu, and open the Song Selection window.
- 3 Browse through the files and folders. When you see the MIDI Song (.mid, .kar) you want to import, touch it, then touch the Select button to import it.

Playing the MIDI Song

The main page of the Sequencer mode shows the Song playback controls.

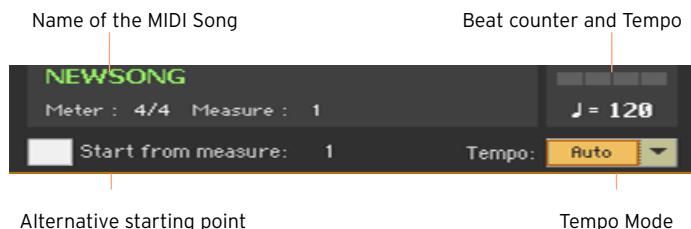

Transport controls

While in the main page of the Sequencer mode, use the PLAYER 1 section's PLAY/STOP (▶/■), HOME (◀), FAST FORWARD (≫) and REWIND (≪) controls.

Alternative starting position

- 1 Set the **Start from measure** number to choose the alternative starting position from where to start playback.
- 2 Select the **Start from measure** checkbox to activate the alternative starting position.

When pressing the HOME (◀) button, or using the REWIND (≪) button to go back to the beginning, the Song will return to this point.

Choosing the Tempo mode

- Use the Tempo pop-up menu to choose a Tempo mode.

Tempo Mode	Meaning
Manual	In this mode, you can change the Tempo value by using the TEMPO buttons, or by touching it and using the VALUE controls or the numeric keypad. The Song will be played back using the manually selected Tempo.
Auto	The Tempo recorded in the Song will be used.

29 Recording MIDI Songs

Multitrack Recording a Song

In Multitrack Sequencer mode, you will record a MIDI Song by playing live over up to 16 MIDI tracks.

Accessing Multitrack Sequencer Recording

- 1 Press the **SEQUENCER** button to switch to the Sequencer mode. The main page of the Sequencer mode will appear.
- 2 Press the **RECORD** button to open the Song Record Mode Select dialog.



- 3 Choose the **Multitrack Sequencer** option and touch **OK** to access the Multitrack Sequencer Record page.

Measure and Beat counter



Setting the recording parameters

When you enter the Multitrack Sequencer mode, you could simply start recording. However, there are some additional settings that you might want to do.

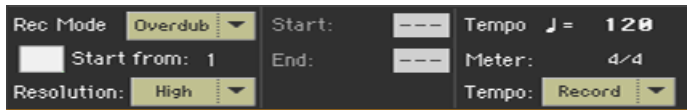

Select the recording mode

- Use the Rec Mode pop-up menu to choose the Overdub or Overwrite recording mode.

Recording Mode	Meaning
Overdub	The newly recorded events will be mixed to any existing events.
Overwrite	The newly recorded events will replace any existing events.
Auto Punch	Recording will automatically begin at the Start position, and stop at the End position. The Auto Punch function will not work on an empty Song. At least one track must already be recorded.
Pedal Punch	Recording will begin when pressing a pedal set to the Punch In/Out function, and will finish when pressing the same pedal again. The Pedal Punch function will not work on an empty Song. At least one track must already be recorded.

Set a starting point (left locator)





- Set the **Start from measure number** to choose the alternative starting position from where to start playback.

Select the **Start from measure** checkbox to activate the alternative starting position.

When pressing the **HOME** (◀) button, or using the **REWIND** (◀◀) button to go back to the beginning, the Song will return to this point.

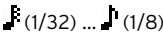
Choose a quantize resolution for recording

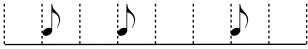
- Set the recording **Resolution**.

Resolution	Meaning
High	No quantization applied
 (1/32) ...  (1/8)	<p>Grid resolution, in musical values. For example, when you select 1/16, all notes are moved to the nearest 1/16 division. When you select 1/8, all notes are moved to the nearest 1/8 division. A '3' after the quantization value means triplet.</p> <p>No quantization </p> <p>1/16 </p> <p>1/8 </p>

Set the Tempo and Meter

- Change the **Tempo** value. Use the **Tempo** pop-up menu to choose the way Tempo events will be recorded.

Tempo Mode	Meaning
Manual	Manual reading. The latest manual Tempo setting (made using the TEMPO buttons) is considered the current Tempo value. No Tempo change events will be recorded. This is very useful when you want to record the Song at a much slower speed than the actual Tempo.
Auto	Auto reading. The Sequencer plays back all the recorded Tempo events. No Tempo change events are recorded.
Record	All Tempo changes made during recording will be recorded to the Master Track. Tempo is always recorded in overwrite mode (old data is replaced by the new data).

- Use the **Meter** parameter to set the basic meter (or time signature) of the Song. You can edit this parameter only when the Song is empty, that is, be-

fore you begin recording anything. To insert a meter change in the middle of the Song, use the Sequencer > Song Edit > Insert Measure function.

Choosing the Sounds and transpose

You choose the Sounds in the dedicated Sound area of the Record page.

Octave Transpose



Sound icon

Choose a Sound

- 1 Touch a Sound icon to select the corresponding track.
- 2 Touch it again, to open the Sound Select window and choose the Sound for the corresponding Song track.

Set the octave transposition

- 1 Go to the Mixer/Tuning > Tuning page.
You can go to this page by keeping the SHIFT button pressed, and pressing one of the UPPER OCTAVE buttons.
- 2 Use the Oct. Transpose knobs to set the octave.

Recording



Turn on the metronome

- Press the METRONOME () button to turn the metronome on or off while recording.

Select the track to record

- 1 Use the TRACK SELECT button to switch between Song Tracks 1-8 and Song Tracks 9-16.
- 2 Touch the track to record to select it. The Record icon () will appear.

Record

- 1 Press the PLAY/STOP () button to begin recording.
A 1-measure precount will play before the recording actually begins. When it begins, record freely.
- 2 When finished recording, press the PLAY/STOP () button to stop the sequencer.
- 3 Select a different track, and go on recording the whole Song.

While recording, you can see the current measure and current beat in the header. You can also check the free memory available for recording.

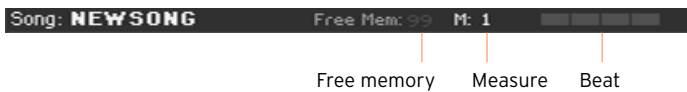

Exit from Record

- 1 When finished recording, choose the Exit from Record command from the page menu, or press the RECORD button to return to the main page of the Sequencer mode.
- 2 While in the main page of the Sequencer mode, press the PLAY/STOP () button to listen to the recorded Song.
- 3 Save the Song to a storage device, to avoid losing it when the instrument enters standby. This is explained later in this section.

Second-take recording

You may want to record additional events, or replace a previously recorded track. If so, repeat recording.

Prepare to record

- 1 Press the **RECORD** button to enter Record mode again. When the Song Record Mode Select dialog box appears, select **Multitrack Sequencer** again.
- 2 Select the track to record.
- 3 Choose the **Overwrite Rec Mode** if you want to replace recorded data, **Overdub** if you want to add events to the same track.

Overdub is useful, for example, when recording different percussive instruments in subsequent cycles.

Record

- 1 Set the **Start from** measure number to choose the alternative starting position from where to start playback.
Select the **Start from** checkbox to activate the alternative starting position.
- 2 Press the **PLAY/STOP (▶/■)** button to start recording the selected track.
- 3 After recording, press the **PLAY/STOP (▶/■)** button to stop recording.
- 4 Repeat the same procedure for any additional track or event to record.

Exit from Record

- When finished recording, choose the **Exit from Record** command from the page menu, or press the **RECORD** button to return to the main page of the Sequencer mode.



Punch-Recording

Punch recording allows for automatic or on-the-fly start and stop of recording. The Punch function will not work on an empty Song. At least one track must already having been recorded.

Auto Punch Recording

You can let the sequencer start and stop recording for you.

- 1 While in the **Multitrack Sequencer** page, use the **Rec Mode** parameter to choose the **Auto Punch** recording mode.

- 2 Use the **Start** and **End** locators to choose the start and end points for recording.
- 3 Touch a track to record to select it. The Record icon () will appear.
- 4 Press the **PLAY/STOP** () button to start playing back the selected track. Recording will automatically begin and end at the **Start** and **End** points.
- 5 Press the **PLAY/STOP** () button to stop recording.



PedalPunch Recording

You can use a footswitch or an EC5 switch to start and stop recording.

Program the footswitch or EC5 switch for Pedal Punch

- Go to the **Global > Controllers > Foot Controllers** page, or the **Global > Controllers > EC5** page, and assign the **Punch In/Out** function to the footswitch or EC5 switch.

Record

- 1 While back to the **Multitrack Sequencer** page, use the **Rec Mode** parameter to choose the **Pedal Punch** recording mode.
- 2 Touch the track to be recorded to select it. The Record icon () will appear.
- 3 Press the **PLAY/STOP** () button to start playing back the selected track.
- 4 When you want to start recording, press the footswitch.
- 5 When you want to end recording, press the footswitch again.
- 6 Press the **PLAY/STOP** () button to stop recording.

Saving the Song

- When finished recording the new Song, go to the main page of the **Sequencer** mode and choose the **Save Song** command from the page menu to save the Song.

More details are later in this section.

Step Recording a Song

Step Recording allows you to create a new Song by entering single notes or chords into each track. This is very useful when transcribing an existing score, or in need for a higher grade of detail, and is particularly suitable to create drum and percussion tracks.

In Overdub Step Recording mode you will add to existing events, while in Overwrite Step Recording mode you will overwrite all existing events.

Accessing Step Recording

- 1 While in the Multitrack Sequencer pages, touch a mixer channel to select the track to edit.
- 2 Choose either the Overdub Step Recording or Overwrite Step Recording command from the page menu, to access the Step Record mode.

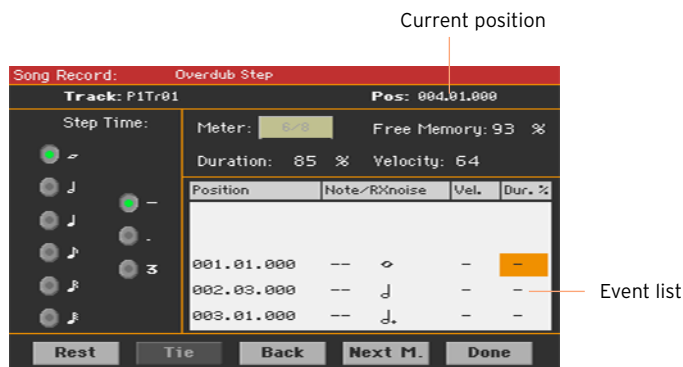

Recording

Position the input pointer

- The Pos parameter shows the current position. This is where you will insert the next event.
- If you do not want to insert a note or chord at the current position, insert a rest instead, as shown below.
- To jump to the next measure, filling the remaining beats with rests, touch the Next M. button.

Choose a step value

- Use the Step Time values to choose the step value.

Choose the relative note duration

- Use the Duration parameter to set the relative note duration. The percentage is always referred to the step value.

Duration	Meaning
50%	Staccato
85%	Ordinary articulation
100%	Legato

Choose the note velocity

- Use the Velocity parameter to set the velocity or playing strength of the event to be inserted.

Velocity	Meaning
Kbd	Keyboard. Select this parameter by turning the VALUE controls completely counter-clockwise. When this option is selected, the playing strength of the played note is recognized and recorded.
1...127	Velocity value. The event will be inserted with this velocity value, and the actual playing strength of the note played on the keyboard will be ignored.

Insert a note or rest at the current position

- To insert a single note, play it on the keyboard. The inserted note length will match the step length. You may change the velocity and relative duration of the note, by editing the Duration and Velocity parameters.
- To insert a rest, touch the Rest button. Its length will match the step value.
- To tie the note to be inserted to the previous one, touch the Tie button. A note will be inserted, tied to the previous one.

Insert a chord

- Play a chord instead of a single note. The event name will be the first note of the chord you pressed, followed by the "...” indicator.

Insert a chord made of notes with different velocity values

You can make the upper or lower note of a chord, for example, louder than the remaining ones, to let the most important note stand out from the chord.

- 1 Edit the first note's Velocity value.
- 2 Press the first note and keep it pressed.
- 3 Edit the second note's Velocity value.
- 4 Press the second note and keep it pressed.
- 5 Edit the third note's Velocity value.
- 6 Press the third note, then release all notes.

Insert a second voice

You can insert phrases where one note is kept pressed, while another voice moves freely.

A few examples:

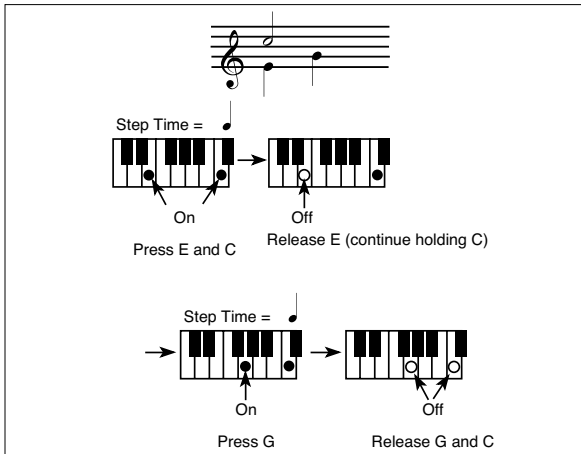

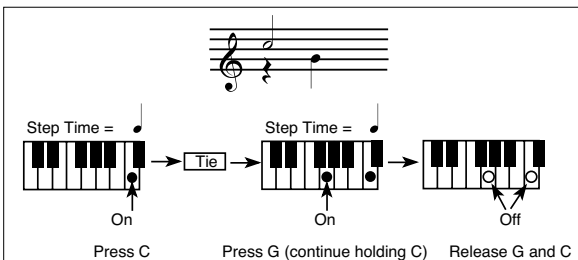
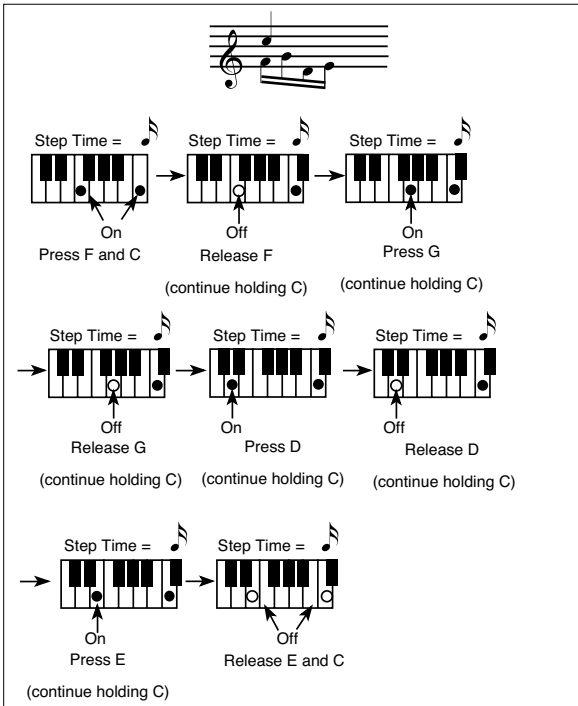

Go back

- If you want to go back, touch the **Back** button. This will delete the previously inserted event, and set the step in edit again.

Exit from Record

- 1 When finished recording, touch the Done button to exit the Step Record mode. A dialog box will appear, asking you to either cancel, discard or save the changes.

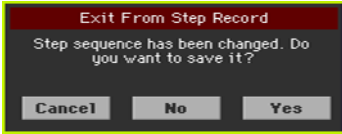

- 2 Touch Cancel to continue editing, No to exit from the Step Record without saving, or Yes to save and exit Step Record.

Saving the Song

- When finished recording the new Song, go to the main page of the Sequencer mode and choose the Save Song command from the page menu to save the Song.

More details are later in this section.

Quick Recording a Backing Sequence Song

What is a Backing Sequence Song?

MIDI Songs are made of up to sixteen 'tracks' - that is, separate parts, each one with a different Sound. Usually, MIDI Songs are recorded one track at a time: the drums first, then the bass, then the accompaniment guitar, then the strings...

Backing Sequence (Quick Record) makes this much easier and faster: you just record your live performance on the keyboard accompanied by the Styles. After saving, this 'quick song' will be converted into an ordinary sixteen-tracks MIDI Song, that you can play with the Players.

Choosing the Style and Sounds

Before accessing the Record mode, prepare the Style and Sounds with which to record your Song.

- 1 Go to the Style Play mode.
- 2 Choose a Style.
- 3 Choose a Keyboard Set.

Accessing the Backing Sequence (Quick Record) mode

- 1 Press the SEQUENCER button to switch to the Sequencer mode. The main page of the Sequencer mode will appear.
- 2 Press the RECORD button to open the Song Record Mode Select dialog.

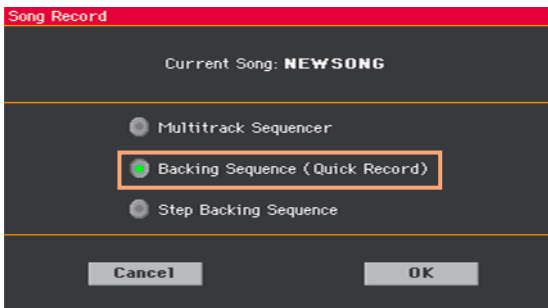

- Choose the Backing Sequence (Quick Record) option and touch OK to access the Backing Sequence Record page.

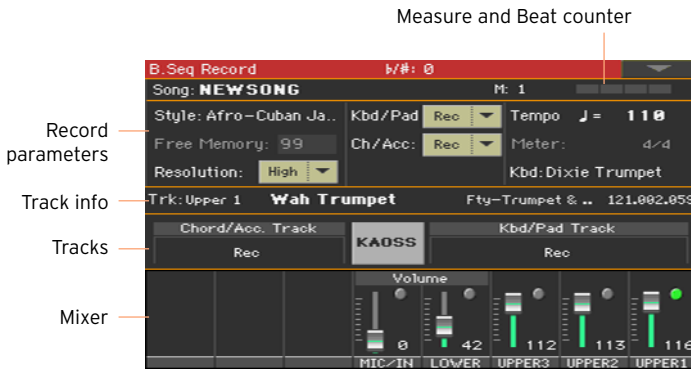

Setting the recording parameters

When you enter the Backing Sequence Record mode, the latest selected Style and Sounds are already selected, and all recorder's tracks are armed and ready to record. You could simply start recording as if you were playing with the Styles. However, there are some additional settings that you might want to do.

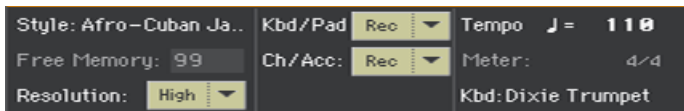

Choose the Style





- Touch the Style parameter (or press one of the STYLE buttons on the control panel) to open the Style Select window, and choose a different Style.

Choose the Sounds

- Touch the Kbd parameter (or use the KEYBOARD SET LIBRARY buttons) to open the Keyboard Set Select window, and choose a different set of Sounds for the keyboard. You can also use the KEYBOARD SET buttons under the display.

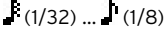
Choose a quantize resolution for recording

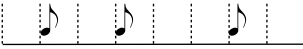
- Set the recording Resolution.

Resolution	Meaning
High	No quantization applied
 (1/32) ... (1/8)	<p>Grid resolution, in musical values. For example, when you select 1/16, all notes are moved to the nearest 1/16 division. When you select 1/8, all notes are moved to the nearest 1/8 division. A '3' after the quantization value means triplet.</p> <p>No quantization </p> <p>1/16 </p> <p>1/8 </p>

You cannot change the Meter (or Time Signature), because it has to match the Style's Meter.

Set the Tempo

- Change the Tempo. The Tempo value memorized in the Style is already selected, but you are free to change it.

Recording

Turn on the metronome

- Press the METRO () button to turn the metronome on or off while recording. The metronome click will not be recorded with the Song.

Select the tracks to record

- Select or deselect the Backing Sequence grouped tracks (**Chord/Acc** and **Kbd/Pad**). This status is reflected by the big status indicator above the track sliders.

Track status	Meaning
Rec	The Backing Sequence grouped track is in record. All previously recorded data will be deleted. After pressing the PLAY/STOP () button to start recording, the track will receive notes from the keyboard.
Play	The Backing Sequence track is set to play. If there are recorded data, they will be heard while recording the other Backing Sequence grouped track.
Mute	The Backing Sequence grouped track is muted. If this track has already been recorded, it will not be heard during recording of the other Backing Sequence track.

The **Chord/Acc** Backing Sequence track groups all the Style tracks, together with recognized chords and Style controls and Style Elements selection.

The **Kbd/Pad** Backing Sequence track contains the four Keyboard Sounds and the Pads.

Record

- 1 Select the Style Element you want to use before starting to play. Select any of the Variations before starting to record. Select one of the Intros to start with an introduction.
- 2 Start recording.
 - Press the **START/STOP** button to start recording with the automatic accompaniment.
 - Press the **PLAYER 1 > PLAY/STOP** () button to start recording without the automatic accompaniment. You will later be able to start the accompaniment by pressing the **START/STOP** button.

A 1-measure precount will play before the recording actually begins. When it begins, record freely.

3 Play as if you were performing live with the Styles.

During recording, select any Style Element (Intro, Variation, Fill, Break, Ending...) you like. While recording in Backing Sequence Record mode, you cannot use the Synchro, Tap Tempo, Manual Bass, Balance controls.

If you want to stop the accompaniment, press the **START/STOP** or one of the **ENDING** buttons; restart by pressing the **START/STOP** button again.

4 When finished recording your Song, press the **PLAYER 1 > PLAY/STOP** (▶/■) button to exit recording, and return to the main page of the Sequencer mode.

If you are recording the accompaniment, and you want to stop it, press the **START/STOP** or one of the **ENDING** buttons; restart by pressing the **START/STOP** button again. When finished recording, press the **PLAY/STOP** (▶/■) button to exit recording, and return to the main page of the Sequencer mode.

5 While in the main page of the Sequencer mode, press the **PLAYER 1 > PLAY/STOP** (▶/■) button to listen to the recorded Song.

Backing Sequence and MIDI Songs

After finishing recording, the Backing Sequence Song will be converted to an ordinary MIDI Song. Grouped tracks will be converted to Song tracks 9-16, as shown in the following table:

Grouped BS Track	Keyboard/Style Track	Song Track/Channel
Kbd/Pad	Upper 1	1
	Upper 2	2
	Upper 3	3
	Lower	4
	Pad 1	5
	Pad 2	6
	Pad 3	7
	Pad 4	8

Grouped BS Track	Keyboard/Style Track	Song Track/Channel
Chord/Acc	Bass	9
	Drum	10
	Percussion	11
	Accompaniment 1	12
	Accompaniment 2	13
	Accompaniment 3	14
	Accompaniment 4	15
	Accompaniment 5	16

Second-take recording (Overdubbing)

You may want to record an additional 'grouped' track, or replace a previously recorded track. A good idea may be to record all chords and Style Element changes during the first take, then record Keyboard track during the second take.

- 1 Press the **RECORD** button to enter Record mode again. When the Song Record Mode Select dialog box appears, select **Backing Sequence (Quick Record)** again.
- 2 If you are recording just one of the "grouped" tracks, set to Play the track to be preserved. For example, if you only want to record the Keyboard track again, set the **Kbd/Pad** track to **Rec**, and the **Chord/Acc** track to **Play**.
- 3 Press the **START/STOP** or **PLAYER 1 > PLAY/STOP (▶/■)** button to start recording the selected track. With the above example, chords will play as recorded; you can record what you play on the keyboard.

If you are recording the accompaniment, and you want to stop it, press the **START/STOP** or one of the **ENDING** buttons; restart by pressing the **START/STOP** button again.

- 4 When finished recording, press the **PLAYER 1 > PLAY/STOP (▶/■)** button to exit recording, and return to the main page of the **Sequencer** mode.
- 5 While in the main page of the **Sequencer** mode, press the **PLAYER 1 > PLAY/STOP (▶/■)** button to listen to the recorded Song.
- 6 Save the Song to a storage device, to avoid losing it when the instrument enters standby.

Using the KAOSS effects while recording

While recording, you can use the KAOSS effects as if you were using them live.

- 1 While in the Backing Sequence Record page, touch the KAOSS button to access the KAOSS page.



- 2 Choose one of the KAOSS Preset by using the Preset menu or the Favorite buttons.
- 3 Start recording.
- 4 If you want to return to the Backing Sequence Record page, while continuing to record, press the EXIT button.
- 5 End recording.

Saving the Song

- When finished recording the new Song, go to the main page of the Sequencer mode and choose the Save Song command from the page menu to save the Song.

More details are later in this section.

Step Recording a Backing Sequence Song

The Step Backing Sequence mode allows you to enter single chords, to create or edit the Style (Ch/Acc) part of a Song. This mode lets you enter chords even if you are not a keyboard player, or fix any error made playing chords or selecting Style controls, during a Backing Sequence (Quick Record) recording.

In this mode, you can only edit Songs created using the Backing Sequence (Quick Record) recording mode. When saving a Song created using the Backing Sequence (Quick Record) recording mode, all Ch/Acc data is preserved, and can be loaded later, to be edited again by using the Step Backing Sequence mode.

Accessing the Step Backing Sequence mode

- 1 Press the SEQUENCER button to switch to the Sequencer mode. The main page of the Sequencer mode will appear.
- 2 Press the RECORD button to open the Song Record Mode Select dialog.

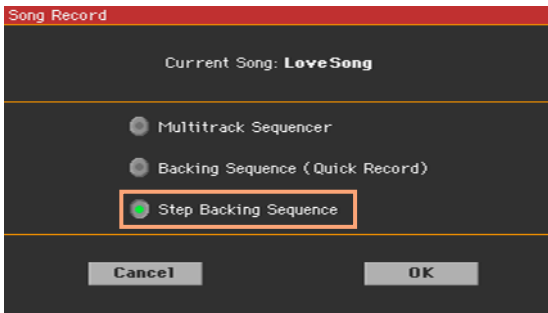

- 3 Choose the Step Backing Sequence option and touch OK to access the Step Backing Sequence page.

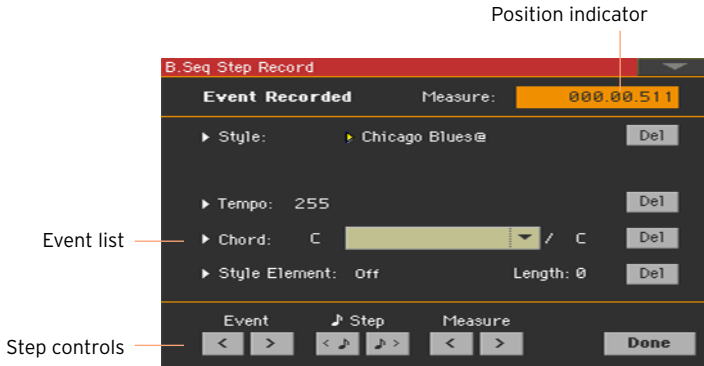

Recording

While in edit, the events at the current position are shown by the right-pointing arrowheads (▶) on the left of the event.

- 1 Use the Measure parameter to go to the desired position in the Song, by using the VALUE controls.

As an alternatively, you can move the locator by using the step controls in the lower area of the display.

Step control	Meaning
Event	Use these buttons to move to the previous or next recorded event.
Step	Use these buttons to go to the previous or next step (1/8, or 192 ticks). If an event is located before the previous or next step, the locator stops on that event. For example, if you are positioned on M001.01.000, and no event exists before M001.01.192, the > button moves to the M001.01.192 location. If an event exists on M001.01.010, the > button stops to the M001.01.010 location.
Measure	Use these buttons to move to the previous or following measure.

- 2 Select a parameter type (Style, Keyboard Set, Tempo...) to insert, edit or delete at the current position.
- 3 Use the VALUE controls to modify the selected event. Delete it by touching the Del button next to the event. When editing a parameter without the arrowhead (▶) next to it, a new event is inserted at the current position.
- 4 When finished editing, touch the Done button to exit from the Step Backing Sequence recording mode.

- 5 While in the main page of the Sequencer mode, press the **PLAY/STOP** (▶/■) button to listen to the recorded Song.

Event types

There are the events you can enter or edit.

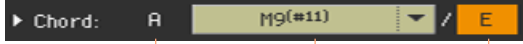
Event type	Meaning
Style	<p>Latest selected Style. To insert a Style change at the current position, touch the Style name to open the Style Select window.</p> <p>Any Style Change inserted after the beginning of the measure (i.e., to a position other than Mxxx.01.000) will be effective at the following measure. For example, if a Style Change event has been inserted at M004.03.000, the selected Style will be effectively selected at M005.01.000. (This works exactly as in Style Play mode).</p> <p>When inserting a Style Change, you may also insert a Tempo Change at the same position. A Style Change will not automatically insert the Style's Tempo.</p>
Keyboard Set	<p>Latest selected Keyboard Set. To insert a Keyboard Set change at the current position, touch the Keyboard Set name to open the Keyboard Set Select window, or follow the standard selecting procedure using the KEYBOARD SET LIBRARY section.</p>
Tempo	<p>This is the Tempo Change parameter. To insert a Tempo Change event at the current position, select this parameter and use the VALUE controls to change its value.</p>
Chord	<p>The chord parameter is divided in three separate parts:</p>  <p style="text-align: center;">Name Type Extension</p> <p>Select one of the parts, then use the VALUE controls to modify it. As an alternative, you can play a chord, and it will be automatically recognized. While recognizing a chord, the status of the Bass Inversion parameter will be considered.</p> <p>The lack of a chord (-) means that the accompaniment will not play at the current position (apart for the Drum and Percussion tracks). To select the "--" option, select the Name part of the Chord parameter, then use VALUE controls to select the very last value (C...B, Off).</p> <p>If you replace a chord with a different one, please remember that the Keyboard track (if recorded) will not be automatically changed, and may cause a dissonance against the accompaniment.</p>
Style Element	<p>This is the Style Element (i.e., a Variation, Fill, Intro, or Ending). The length of the selected Style Element is always shown by the "Length" parameter (see below).</p> <p>'Off' means that the accompaniment will not play at the selected position - only Keyboard and Pad tracks will play.</p> <p>Hint: Insert a Style Element Off event exactly where the automatic accompaniment must stop (at the end of the Song).</p>

Event type	Meaning
Length	This parameter will let you know where to place the following Style Element Change. For example, if you inserted an Intro event lasting for 4 measures, you can insert 4 empty measure after this event, and a Variation event at the end of the Intro, beginning at the 4th empty measure.

Inserting measures

- Choose the **Insert Measures** command from the **page menu**, to insert an empty measure starting from the current measure.

All Ch/Acc events contained in the current measure will be moved to the following measure. The event at the Mxxx.01.000 position (i.e., exactly at the beginning of the measure, like a Time Signature or Style change) will not be moved.

Cutting out measures

- Choose the **Cut Measure** command from the **page menu**, to delete the current measure.

All Ch/Acc event contained in the following measures will be moved one measure back.

Deleting everything from the current position

- Choose the **Delete All from Selected** command from the **page menu**, to delete events of all types, starting from the current position.

The events on the very first tick (M001.01.000), like Style, Tempo, Chord, Style Element selection, will not be deleted, since they are the setting parameters of the Song.

Deleting selected types of events

- To delete all events of a specified type starting at the current position, choose from the page menu the **Delete All ... from Selected** command corresponding to the type of event to delete (Styles, Style Elements, Chords, Tempos).

To delete all the events of the same type from the whole Song, go back to the M001.01.000 position, and select one of these commands.

The events on the very first tick (M001.01.000), like Perf, Style, Tempo, Chord, Style Element selection, will not be deleted, since they are the setting parameters of the Song.

Deleting single events

- Delete a single event by touching the **Del (Delete)** button next to it.

Exiting from record

- 1 When finished recording, touch the **Done** button to exit the Step Record mode. A dialog box will appear, asking you to either cancel, discard or save the changes.



- 2 Touch **Cancel** to continue editing, **No** to exit from the Step Record without saving, or **Yes** to save and exit Step Record.

Saving the Song

- When finished recording the new Song, go to the main page of the Sequencer mode and choose the **Save Song** command from the page menu to save the Song.

More details are later in this section.

30 Editing the MIDI Songs

Editing the Song tracks

You can edit the Song data in the Sequencer > Song Edit section.

After modifying something, press the PLAY/STOP (▶/■) button to listen to the edited Song. Use the transport controls to move through the Song.

Quantizing

The quantize function may be used to correct any timing mistake after recording, or to give the pattern a 'groovy' feeling.



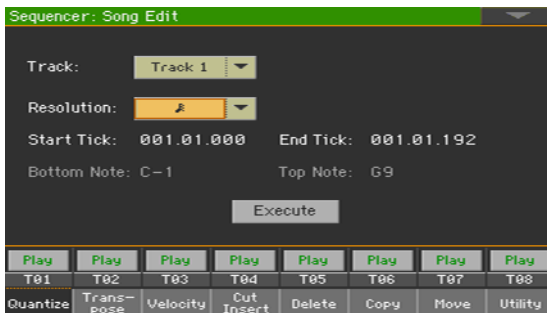

- 1 Go to the Sequencer > Song Edit > Quantize page.

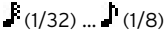

- 2 Select the Track to edit.

Track	Meaning
All	All tracks selected
Track 1... 16	Selected track

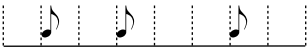
- 3 Use the Resolution pop-up menu to choose the quantize resolution.

Resolution	Meaning
 (1/32) ... (1/8)	<p data-bbox="393 229 1019 347">Grid resolution after recording, in musical values. For example, when you select 1/16, all notes are moved to the nearest 1/16 division. When you select 1/8, all notes are moved to the nearest 1/8 division. A "b...f" character added after the value means swing-quantization. A '3' after the quantization value means triplet.</p> <p data-bbox="393 371 537 395">No quantization</p>  <p data-bbox="501 424 537 448">1/16</p>  <p data-bbox="507 483 537 507">1/8</p> 

- 4 Use the **Start Tick** and **End Tick** parameters to set the beginning and ending of the phrase to be quantized.

If a phrase is four measures long, and you want to select it all, the Start will be positioned at 1.01.000, and the End at 5.01.000.

- 5 Use the **Bottom Note** and **Top Note** parameters to set key range to quantize.

These parameters are only available when a Drum or Percussion track is selected. If you select the same note as the Bottom and Top parameters, you can select a single percussive instrument in a Drum Kit.

- 6 After having set the various parameters, touch **Execute**.

Transposing

The transpose function may be used to transpose the selected track(s).

- 1 Go to the Sequencer > Song Edit > Transpose page.

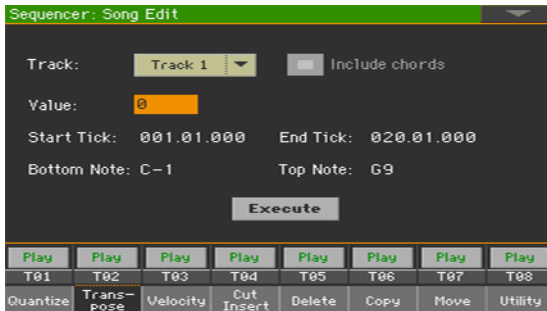

- 2 Select the Track to edit.

Track	Meaning
All	All tracks selected, apart for the tracks set in Drum mode (like the Drum and Percussion tracks).
Track 1 ... 16	Selected track.

- 3 Use the Value parameter to choose the transpose value.

Value	Meaning
-127 ... 127	Transpose value (in semitones)

- 4 Use the Start Tick and End Tick parameters to set the beginning and ending of the phrase to be transposed.

If a phrase is four measures long, and you want to select it all, the Start will be positioned at 1.01.000, and the End at 5.01.000.

- 5 Use the Bottom Note and Top Note parameters to set key range to transpose.

If you select the same note as the Bottom and Top parameters, you can select a single percussive instrument in a Drum Kit. Since in a Drum Kit each instrument is assigned to a different note of the scale, transposing a percussive instrument means assigning the part to a different instrument.

Selective transpose can also be used to avoid transposing RX Noises (transposing only notes under C7).

- 6 Select the **Include chords** checkbox if you want to also transpose the Chord events, for example those recorded with a Backing Song.

The Chord events will be shown in the **Lyrics** and **Score** pages, so we suggest to transpose them to match the notes and the chord abbreviations shown. However, be very careful if you want to read the resulting Standard MIDI File with a dedicated player, because saving the Chord events would change their format, and make them no longer compatible with some devices.

- 7 After having set the various parameters, touch **Execute**.

Editing Velocity data

You can change the velocity (dynamics) value of notes in the selected track(s).

When an RX Sound is assigned to the track being edited, the resulting sound may change, since this kind of Sounds is made of several different layers triggered by different velocity values.

Also, a fade-out may result in the level 'jumping' up next to the zero, since a higher-level layer may be selected by low velocity values.

- 1 Go to the **Sequencer > Song Edit > Velocity** page.

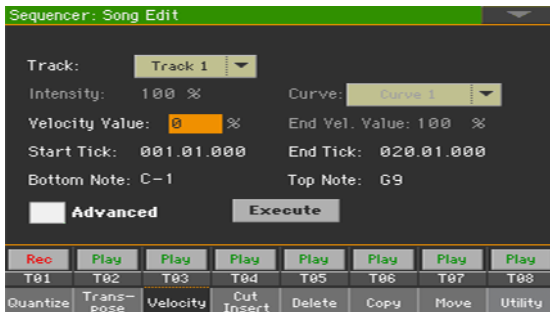

- 2 Select the Track to edit.

Track	Meaning
All	All tracks selected. The velocity for all notes will be changed.
Track 1 ... 16	Selected track.

- 3 Use the **Velocity Value** parameter to choose the velocity change value.

Value	Meaning
-127 ... 127	Velocity change value (in MIDI value)

- 4 If you want to use the advanced parameters, allowing you to select a velocity curve and create fade-ins or fade-outs, select the **Advanced** checkbox.

When this parameter is selected, the **Intensity**, **Curve**, **Start Velocity Value** and **End Velocity Value** parameters become accessible.

- Use the **Intensity** parameter to specify the degree to which the velocity data will be adjusted toward the curve you specify with **Curve**.

Intensity	Meaning
0 ... 100%	Intensity value. With a setting of 0%, the velocity will not change. With a setting of 100%, the velocity will be changed the most.

- Use the **Curve** parameter to select one of the six curves, and specify how the velocity will change over time.

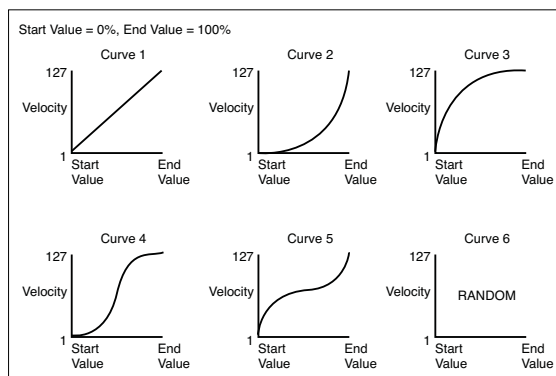

- Use the **Start Vel. Value** and **End Vel. Value** to change the velocity value at the starting and ending of the selected curve.

Intensity	Meaning
0 ... 100%	Velocity change in percentage

- 5 Use the **Start Tick** and **End Tick** parameters to set the beginning and ending of the phrase to be edited.

If a phrase is four measures long, and you want to select it all, the **Start** will be positioned at 1.01.000, and the **End** at 5.01.000.

- 6 Use the **Bottom Note** and **Top Note** parameters to set key range to change.

If you select the same note as the **Bottom** and **Top** parameters, you can select a single percussive instrument in a Drum Kit. Selecting a range can also be used to only edit RX Noises (from C7) or ordinary notes (under C7).

- 7 After having set the various parameters, touch **Execute**.

Cutting or inserting measures

You can delete a selected measure (or a series of measures), or insert new ones in the middle of the Song.

- 1 Go to the Sequencer > Song Edit > Cut/Insert page.

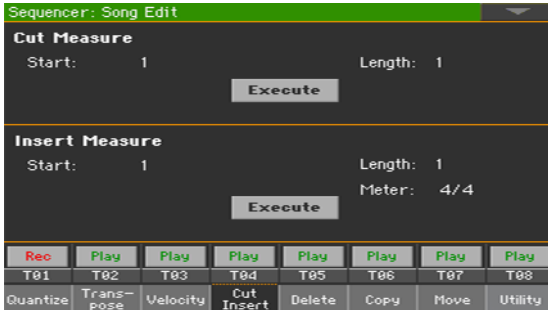

- 2 Use the Start parameter to select the first measure to be cut or inserted.
- 3 Use the Length parameter to choose the number of measures to be cut or inserted.
- 4 Use the Meter parameter to set the meter (time signature) of the measure to be inserted.
- 5 After having set the various parameters, touch Execute.

Deleting data from measures

The Delete page is where you delete MIDI events out of the Song. This function does not remove measures from the Song. To remove whole measures, use the Cut function instead.

- 1 Go to the Sequencer > Song Edit > Delete page.

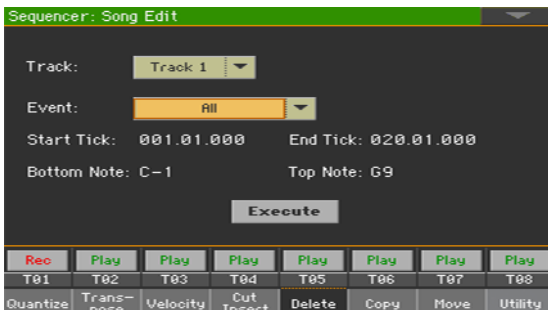

2 Select the Track to edit.

Track	Meaning
All	All tracks selected
Track 1 ... 16	Selected track
Master	Master track. This is where the Tempo, Scale and Effect events are recorded.

3 Use the Event pop-up menu to choose the type of event to delete.

Event	Meaning
All	All events. The measures are not removed from the Song.
Note	All notes in the selected range.
Dup.Note	All duplicate notes. When two notes with the same pitch are encountered on the same tick, the one with the lowest velocity is deleted.
After Touch	After Touch events.
Pitch Bend	Pitch Bend events.
Prog.Change	Program Change events, excluding the bundled Control Change #00 (Bank Select MSB) and #32 (Bank Select LSB).
Ctl.Change	All Control Change events, for example Bank Select, Modulation, Damper, Soft Pedal...
CC00/32 ... CC127	Single Control Change events. Double Control Change numbers (like 00/32) are MSB/LSB bundles.

4 Use the Start Tick and End Tick parameters to set the beginning and ending of the phrase to be deleted.

If a phrase is four measures long, and you want to select it all, the Start will be positioned at 1.01.000, and the End at 5.01.000.

5 Use the Bottom Note and Top Note parameters to set key range to delete.

These parameters are available only when the All or Note option is selected. If you select the same note as the Bottom and Top parameters, you can select a single percussive instrument in a Drum Kit. Selecting a range can also be used to only edit RX Noises (from C7) or ordinary notes (under C7).

6 After having set the various parameters, touch Execute.

Copying data

You can copy tracks or phrases.

- 1 Go to the Sequencer > Song Edit > Copy page.



- 2 Use the Mode parameter to choose a Copy mode.

Copy Mode	Meaning
Merge	Copied data are merged with the data at the target position.
Overwrite	Copied data replace all data at the target position.

- 3 Use the From Track parameter to choose the source track, and the To Track parameter to choose the target.

Track	Meaning
All	All tracks will be copied. The target track cannot be selected.
Track 1 ... 16	Selected track.

- 4 Use the Start Measure and End Measure parameters to set the beginning and ending of the phrase to be copied.
- 5 Use the To Measure parameter to choose the first of the target measures.
- 6 Use the Repeat Times parameter to choose the number of times the copy must be repeated consecutively.
- 7 After having set the various parameters, touch Execute.

Moving data

You can shift a track forward or backward by just a few ticks or whole measures.

- 1 Go to the Sequencer > Song Edit > Move page.

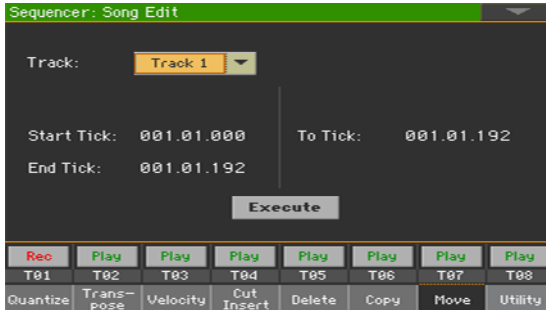

- 2 Use the Track parameter to choose the track to edit.

Track	Meaning
All	All tracks will be moved.
Track 1... 16	Selected track.

- 3 Use the Start Tick and End Tick parameters to set the beginning and ending of the phrase to be moved.

If a phrase is four measures long, and you want to select it all, the Start will be positioned at 1.01.000, and the End at 5.01.000.

Use the To Tick parameter to choose the point where the data will be moved.

- 4 After having set the various parameters, touch Execute.

Converting notes to RX Noises

You can go to the Utility page to convert notes of a Standard MIDI File into RX Noises, and vice-versa. This will help programming Songs on an external sequencer.

- 1 Go to the Sequencer > Song Edit > Utility page.

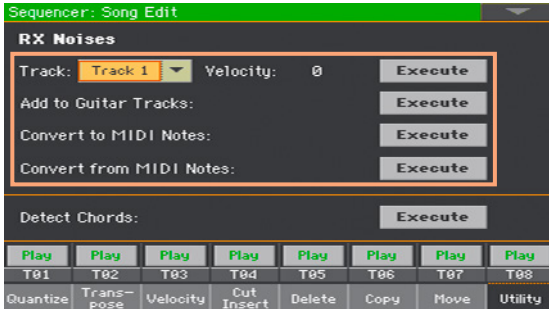

- 2 Edit the parameters, and choose the commands.
 - Use the Track parameter to choose a track, then use the Velocity parameter to set the volume level of the RX Noises in the selected track(s). When done, touch the Execute button.

Track	Meaning
All	All tracks.
Track 1 ... 16	Selected track.

- Touch the Execute button next to the Add to Guitar Tracks parameter to automatically analyze the Standard MIDI File, and add RX Noises to Guitar tracks.

This command scans the whole Standard MIDI File, looking for guitar strumming played by nylon, steel or electric guitars. After scanning, a suitable Guitar sound will be automatically assigned to the relevant tracks, and RX Noises automatically added where needed.

- Touch the Execute button next to the Convert to MIDI Notes parameter to convert the RX Noises to ordinary MIDI Notes.
- Touch the Execute button next to the Convert from MIDI Notes parameter to convert all the relevant MIDI Notes to RX Noises.

Converting MIDI Song's notes to chords

The Detect Chord function scans the MIDI Song's tracks to detect chords, and then saves them as Chords events, to be seen in the Lyrics or Score page.

- 1 Go to the Sequencer > Song Edit > Utility page.

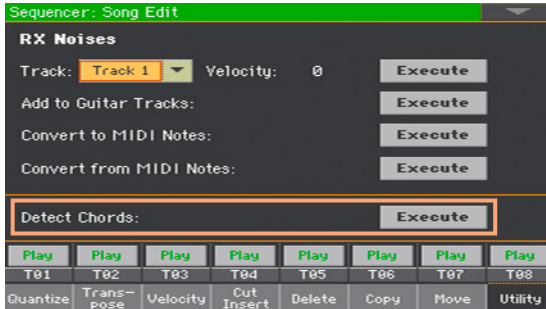

- 2 Touch the Execute button next to the Detect Chords parameter to automatically analyze the Standard MIDI File, and find chords.

This command scans the whole Standard MIDI File, looking for chords. After scanning, chords will be automatically saved in the file as Chords events.

Editing the MIDI events

The Event Edit is the page where you can edit each single MIDI event of the selected track. You can, for example, replace a note with a different one, or change its playing strength (that is, velocity value).

The Event Edit page

- Go to the Sequencer > Event Edit > Event Edit page.

The screenshot shows the 'Sequencer: Event Edit' interface for 'T: Track 1'. It features a table with the following data:

Position	Type	Value1	Value2	Length
M:001.01.000	Ctrl	100	0	
M:001.01.000	Ctrl	101	0	
M:001.05.188	Note	A3	99	D:000.00.065
M:001.06.060	Note	B3	82	D:000.00.062
M:001.06.163	Bend	0		

Callout 'a' points to the 'Track 1' dropdown menu. Callout 'b' points to the table of events.

The Event Edit procedure

Here is the general procedure to follow for the event editing.

Load the Song and access editing

- 1 Press the **SEQUENCER** button to go to the Sequencer mode.
- 2 Either record a new Song, or load an existing MIDI Song by choosing the **Load Song** command from the page menu.
- 3 Go to the Sequencer > Event Edit > Event Edit page.

Filtering the events shown

- Go to the Sequencer > Event Edit > Filter page to select the events to hide.

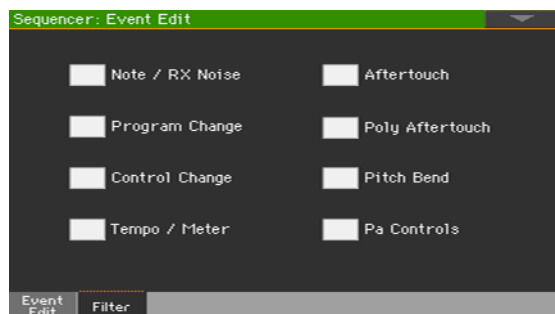

Filter	Meaning
Note/RX Noise	Notes and RX Noise events
Program Change	Program Change events
Control Change	Control Change events
Tempo/Meter	Tempo and Meter (time signature) changes (Master Track only)
Aftertouch	Mono (Channel) Aftertouch events
Poly Aftertouch	Polyphonic Aftertouch events
Pitch Bend	Pitch Bend events
Pa Controls	Messages exclusive to KORG Pa-Series instruments (and the HAVIAN 30 digital ensemble piano).

Edit the events

- Go back to the Sequencer > Event Edit > Event Edit page.
- Use the Track pop-up menu to select the track to edit.

The list of events contained in the selected track will appear in the display. Some events on the beginning of the track, as well as the 'EndOfTrk' event (marking its ending point) cannot be edited, and appear dimmed.

- Scroll through the various events by using the scrollbar.
- Touch the event to be edited, and edit it.



- Select the **M (Measure)**, and use the **VALUE** controls to change event's position.
- Select the **Type** parameter, and use the **VALUE** to change the event type.
- Select the **Value 1** and **Value 2** parameters, and use the **VALUE** controls to edit them. In case of numeric values, you can also touch them twice to open the numeric keypad.

Event Type	Value 1	Value 2
Ordinary tracks (1-16)		
Note	Note name	Velocity
RX Noise	Note name	Velocity
Prog	Program Change number	-
Ctrl	Control Change number	Control Change value
Bend	Bending value	-
Aftt	Mono (Channel) Aftertouch value	-
PAft	Note to which the Aftertouch is applied	Poly Aftertouch value
Master track		
Tempo	Tempo change	-
Volume	Master Volume value	-
Meter	Meter (time signature) change ^(a)	-
KeySign	Key Signature ^(b)	-
Scale	One of the available preset Scales	Root note for the selected Scale
UScale (User Scale)	Altered note	Note alteration ^(c)
QT (Quarter Tone)	Altered note	Note alteration (0, 50) ^(c)
QT Clear (Quarter Tone Clearing)	Reset of all Quarter Tone (QT) changes	-
<p>(a). Meter changes can't be edited or inserted separately from a measure. To insert a Meter change, use the Insert function in the Edit section and insert a series of measures with the new meter. Existing data can then be copied or entered to these measures</p> <p>(b). This is the key signature shown in the Score. If this event is missing, the Score will be shown as if it was in the key of C Major.</p> <p>(c). To edit User Scale and Quarter Tone settings, select the first value, then select the scale's degree to edit. Edit the second value to change the tuning of the selected note of the scale.</p>		

- If a **Note** event is selected, select the **D (Duration/Length)** parameter, and use the **VALUE** controls to change the event's length.

Jump to a different measure

- 1 Touch the **Go/Catch** button to go to a different measure. The Go To Measure dialog will appear:



- 2 Enter a target measure and touch **OK** to confirm. The first event available in the target measure will be selected.

Insert events

- Touch the **Insert** button to insert an event at the current **Position (M)**. A Note event with default values will be inserted.

Delete events

- Select an event, then touch the **Delete** button to delete it.

Edit other tracks

- When editing is complete, select a different track to edit.

Exit Event Edit

- When finished editing the Song, press the **EXIT** button to go back to the main page of the Sequencer mode, and listen to the Song.

31 Saving MIDI Songs

Saving the MIDI Song

The Song will be lost when the instrument is turned off, or you switch to a different mode. Save it after recording.

- 1 While in the main page of the Sequencer mode, choose the Save Song command from the page menu. The Save Song window will appear.



This window is very similar to the Media > Save page. Files are filtered, so that can only see MIDI Song files (.mid, .kar).

- 2 Use the Device pop-up menu to select a storage device, then choose a folder where to save your Song.

Use the Open and Close buttons to browse through the folders.

Use the scrollbar to see all Songs in the list. Keep the SHIFT button pressed and touch the Up/Down arrows to scroll to the next/previous alphabetic section. As an alternative, use the VALUE controls to scroll the list.

- 3 Choose an existing file, or create a new file.
 - To overwrite an existing Song, select it. In any case, you can change the name of the Song while saving, and the original file will not be overwritten.

If you select a .kar file, a file with the same name, but the .mid extension, will be created. The older file will not be overwritten.

- If no Song is selected, a new Song file will be created on the target device. To deselect a selected Song, touch anywhere else in the Song list, or select the same storage device again.

At this point, press the EXIT button if you prefer to exit without saving the Song.

- 4 Touch the Save button to save the Song into the current folder. The Save Song dialog box will appear.

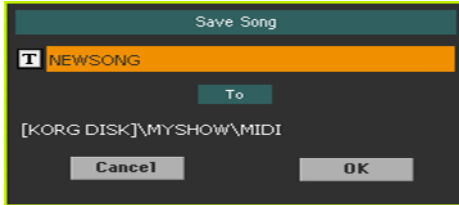

- 5 You may change the name of the Song. Touch the Text Edit (**T**) icon to open the virtual keyboard and edit the name. When done editing the name, confirm by touching the OK button under the virtual keyboard.

If you started from an existing file, changing the name will create a new file and will not overwrite the existing file.

- 6 When back to the Save Song dialog, touch the OK button to save the Song.

A Standard MIDI File format 0 (Zero) will be created in the target storage device. The file will have a .mid extension.

A setup measure, containing various Song initialization parameters, will be inserted at the beginning of the Song.

32 Recording MP3 Songs

Recording and saving an MP3 Song

Recording an MP3 Song

Prepare for recording

- Either choose a Style or Song, if you want to record them in the new Song. You can choose either MIDI or MP3 Songs.
- Choose a Keyboard Set to assign Sounds to the keyboard.
- Choose a Voice Preset to add effects to your voice.

Enter MP3 Record mode

- While in Style Play or Song Play mode, keep the RECORD button pressed for about one second to let the MP3 Record dialog appear.



Set the recording parameters

- Use the Quality pop-up menu to choose the preferred MP3 audio quality. The higher the sound quality, the larger the MP3 file that will be generated.

Please note that MP3 files recorded with lower sampling rates might not sound very good. With MP3 files there is always a trade-off between higher quality and smaller file size.

Quality	Meaning
Highest	256 kbps
High	192 kbps
Medium	128 kbps

- Use the **Device** pop-up menu to choose a location where to temporary store the recorded MP3 file.

This is not the final destination of your file, since you will be able to choose a different location after recording. However, be sure there is enough space for the temporary file, by checking the **Free space** parameter. The current file size is always shown by the **File length** parameter.

Record the MP3 Song

- 1 Touch the **Rec** button in the display to start recording.

The **Rec** button will change to **Stop**, and the **Recording** label will appear.



- 2 Start playing your song.

During recording, use the **MP3 Record** dialog to check the **Recording time**, **File length** and the **Free space** on the storage device.

Exit the MP3 Record dialog without stopping recording

- If you like, press the **EXIT** button to exit the **MP3 Record** dialog and navigate through the **Style Play** and **Song Play** pages, without stopping to record.
- To access the **MP3 Record** dialog again, and see the file length or stop recording, keep the **RECORD** button pressed for about one second again.

If you exit from the MP3 Record dialog while recording, a red recorder icon will continue flashing in the display.



Stop recording

- Touch the **Stop** button in the display to stop recording.
- As an alternative, press the **RECORD** button.

What can you record into an MP3 Song?

Everything you sing in the mic or play on the keyboard, the Styles and the MIDI or MP3 Songs performed by the Players, the events generated by the KAOSS effects, will be recorded.

Saving the MP3 Song

Save the MP3 Song

After having stopped recording, the MP3 Record dialog will allow you to choose a location for saving the MP3 file.

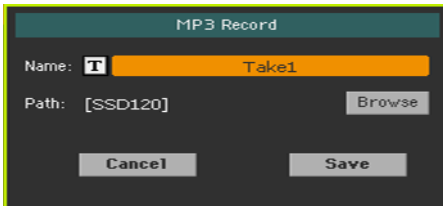

- 1 Touch the Text Edit (**T**) icon to give the MP3 file a name.
- 2 Touch the **Browse** button to select a storage device and folder where to save the file.
- 3 Touch the **Save** button to save the MP3 file.

After saving, you can listen to the MP3 Song in Song Play mode. The MP3 file can also be moved to a personal computer for listening or further editing.

Overdubbing MP3 Songs

MP3 Songs are compressed audio. Compression replaces the original audio stream with encoded audio, taking less space while preserving high sound quality. Overdubbing is the process of recording audio over existing audio.

When overdubbing an MP3 Song in MP3 Record mode, you recompress a compressed file, and artifacts will be amplified. If you transpose the MP3 Song, pitch-shifting artifacts will be added and further degrade the resulting audio.

It is suggested to compose using the internal Sounds and MIDI Songs. You can transpose and overdub MIDI Songs without any audio degradation. When done with your song, you can record it as an MP3 file.

33 Creating text files (lyrics)

Creating text files on a personal computer

Choosing the right language

Pa4X supports lyrics text in various languages. This however requires that you choose the right language in Pa4X, and save the TXT file with the correct text encoding from a personal computer.

To save a TXT file with the correct encoding, you can use a Windows PC or Mac with an advanced text editor. The two free applications we suggest you use are Don Ho's Notepad++ for Windows and Bare Bone's BBEEdit for Mac.

Language Text Encoding

Please find in the following table the text encodings corresponding to the various languages supported by Pa4X.

Language	Encoding (Notepad++)	Encoding (TextWrangler)
Dutch	Western European > Windows-1252	Western (Windows Latin 1)
English	Western European > Windows-1252	Western (Windows Latin 1)
Estonian	Baltic > Windows-1257	Baltic (Windows)
French	Western European > Windows-1252	Western (Windows Latin 1)
German	Western European > Windows-1252	Western (Windows Latin 1)
Greek	Greek > Windows-1253	Greek (Windows)
Italian	Western European > Windows-1252	Western (Windows Latin 1)
Polish	Central European > Windows-1250	Central European (Windows Latin 2)
Russian	Cyrillic > Windows-1251	Cyrillic (Windows)
Spanish	Western European > Windows-1252	Western (Windows Latin 1)
Turkish	Turkish > Windows-1254	Turkish (Windows Latin 5)

Setting the language on the Pa

To correctly read text on your Pa, be sure to set the **Language** parameter to your language. This can be done in the **Global > General Controls > Interface** page.

- 1 Since the instrument must be restarted at the end of this procedure, be sure to first save any unsaved data.
- 2 While in the **Interface** page, select a language from the popup menu.
- 3 The **Change** command will start flashing. Touch it.
- 4 A message will ask you to reboot the instrument. Touch **OK** to close the message window.
- 5 Turn the instrument off, then on again.

Editing the TXT file on a Windows PC

- 1 Launch Notepad++.
- 2 Open the original TXT file.
- 3 Choose **File > New** to open a new tabbed window containing the new TXT file.
- 4 Choose **Encoding > Character sets > [Your Language] > [Encoding]**.

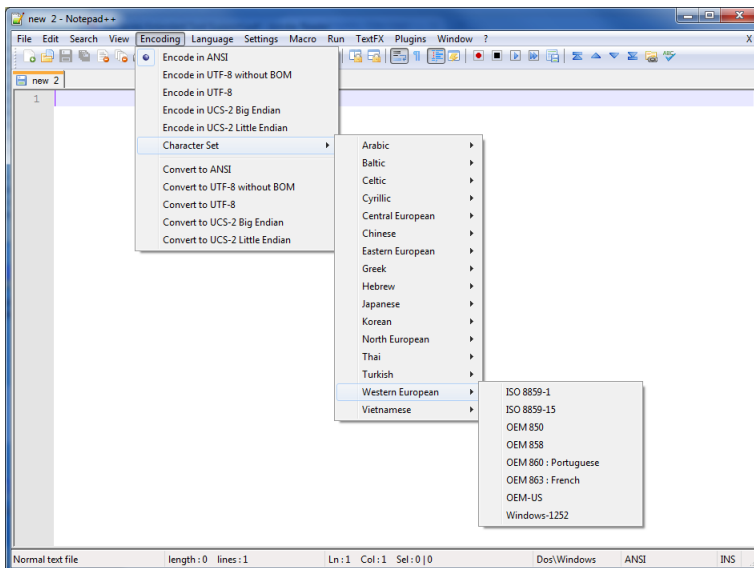

- 5 Click on the tab containing the original TXT file.

- 6 Select all and copy the selected text.
- 7 Click on the tab containing the new TXT file.
- 8 Paste the copied text.
- 9 Save and assign a name to the new TXT file.
- 10 Load the file into your instrument, and check it.

Editing the TXT file on a Mac

- 1 Launch BBEdit.
- 2 Open the original TXT file.
- 3 In the status bar (in the lower part of the window) find the Text Encoding parameter (it usually defaults to Unicode or Western ISO). Click it to open the popup menu, and choose Other....

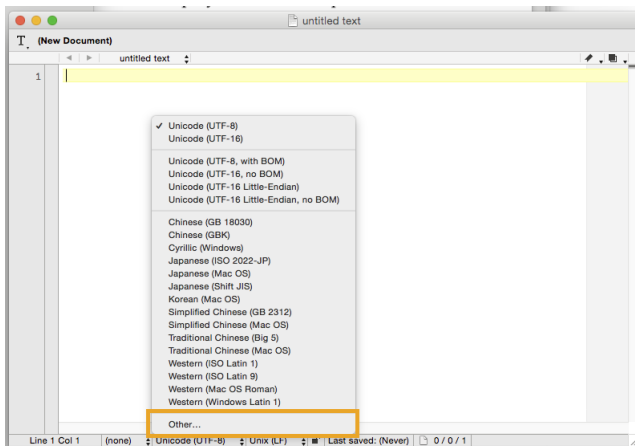

- 4 While in the dialog, choose your language encoding.

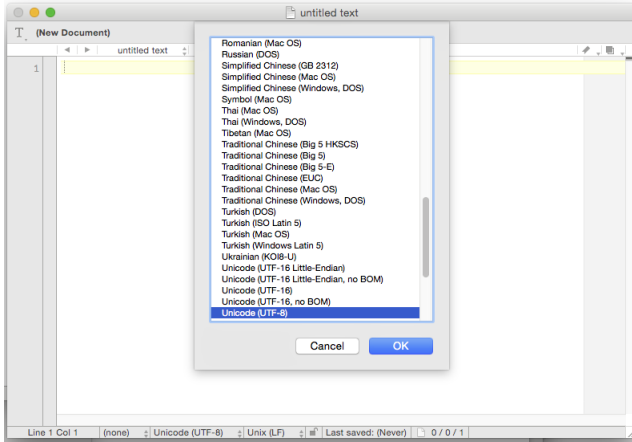

- 5 Next to it in the status bar, find the Line Break Type parameter, usually defaulting to Unix (LF). Click it to open the popup menu, and choose Windows (CRLF).

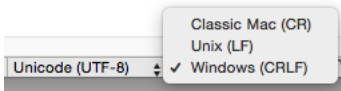

- 6 Save a copy of the file by choosing File > Save As. Give the new file a name, and be sure that the Save As dialog box shows the correct Line breaks and Encoding.
- 7 Load the file into your instrument, and check it.

Formatting text for the Pa-Series instruments

While in a text editor, text files must be formatted with non-proportional fonts (like Courier, Courier New, Letter Gothic, Lucida Sans, Menlo, Monaco, Vera Sans, or any other monospaced font). Up to 41 characters can fit a single line of text when using the smaller font size in the Pa, 24 when using the bigger font size.

- Small font in a text editor and the Pa:

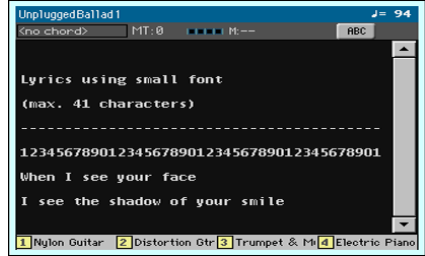
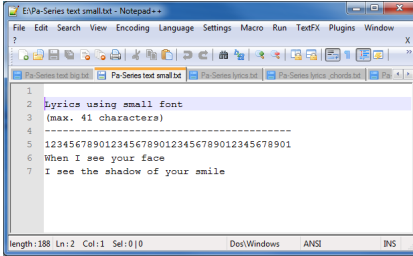

- Big font in a text editor and the Pa:

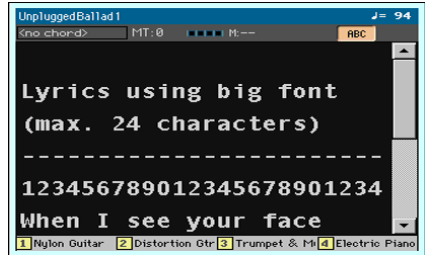
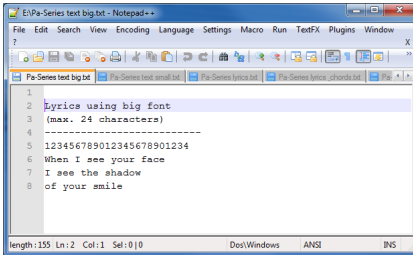

Using imported text as a memo

Importing text files may be useful not only to load Lyrics, but also to load notes on the show. Please find below an example of playlist and gig outline.

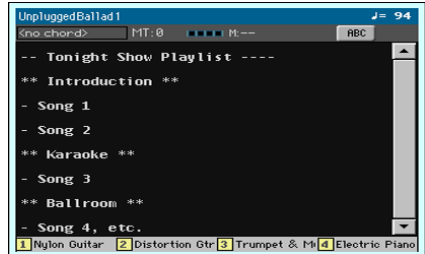
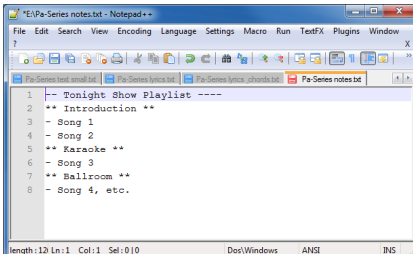

**PART VII:
CUSTOMIZING
AND EDITING
THE SOUNDS**

34 Listening and customizing the Sounds

Accessing the Sound mode

- Press the **SOUND** button in the **MODE** section of the control panel. The main page of the Sound mode will appear.



Listening to individual Sounds

While in the Sound mode, the selected Sound can always play across the full keyboard range. The split point will be ignored.

Choosing a Sound

- 1 While in the main page of the Sound mode, touch the name of the Sound to open the Sound Selection window.



- 2 Browse through the Sounds, and touch the Sound to select.

Choosing a Sound while in other modes

While in a different mode, you can easily 'send' a Sound to the Sound mode.

- Select the track/channel the Sound to be edited is assigned to, then keep the SHIFT button pressed and press the SOUND button.

Playing via MIDI

In Sound mode, Pa4X receives and transmits on the same channel as the Upper 1 part. If the Global channel is assigned to a MIDI channel, notes can also be received on this channel.

MIDI channels can be programmed in the Global > MIDI > MIDI IN Channels page.

Customizing the Sound

While in the main page of the Sound mode, you can edit some Sound parameters in realtime. This is useful both for on-the-fly adjustments, and for realtime sound manipulation.

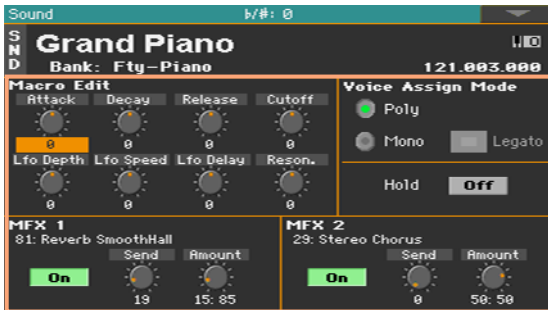

Using the Realtime Controls

- Use the Realtime Controls to edit the main parameters of the Sound.

All values are offset of the original values memorized in the Sound (they are added to or subtracted from the original values). The position of these controls is reset after you write the Sound, or choose a different Sound.

Realtime Control	Meaning
Attack	Attack time. This is the time during which the sound goes from the Start level (at the moment when you strike a key) to the Attack level.
Decay	Decay time. Time to go from the final Attack level to the beginning of the Sustain.
Release	Release time. This is the time during which the sound goes from the sustaining phase, to zero. The Release is triggered by releasing a key.
	<p style="text-align: center;">Amplifier EG</p>
Cutoff	Filter cutoff. This sets the sound brightness.
Resonance	Use the Filter Resonance to boost the part of the sound spectrum around the cutoff frequency.
LFO Depth	Intensity of the Vibrato (LFO).
LFO Speed	Speed of the Vibrato (LFO).
LFO Delay	Delay time before the Vibrato (LFO) begins, after the sound starts.

Setting the Voice mode

- Use the **Poly** and **Mono** radio buttons to choose whether the Sound will play polyphonically (playing chords) or monophonically (one voice at a time).
- Use the **Legato** checkbox to activate legato to a mono voice.

Legato will make the second note's attack smoother. Envelope and LFO will not be retriggered. This is particularly effective with wind instrument and analog synth-type sounds.

- Turn on the **Hold** parameter to keep the notes sustained even after releasing the keys.

Mixing the effects

Sounds are sent to two Master FX processors (**MFX 1** and **MFX 2**). The first one is usually a reverb, the second a modulating effect.

- Use the **On/Off** switch to turn on or off the corresponding effect.
- Use the **Send** knob to adjust the level of the dry sound sent to the corresponding effect.
- Use the **Amount** knob to mix between the dry and effected signal.

Writing the Sound

- When finished editing the Sound parameters in the **main page** of the Sound mode, choose the **Write Sound** command from the **page menu** to save the Sound. More details on writing Sounds at the end of this section.

35 | Editing the Sounds

You can edit each single parameter of a Sound. Pa4X is, at its core, a powerful sample-based synthesizer, with advanced analogue-like sound shaping features.

Sound generation

At the base of each Sound there are Samples, that are recordings of real sounds.

Each Sample is assigned to a separate zone of the keyboard together with other Samples to create a Multisample. One or two Multisamples are assigned to each Oscillator.

Up to twenty-four Oscillators can be put together to make a Sound. In a Sound, Oscillators are balanced, layered, and processed by the Effects.

Sounds are the basic unit of the Pa4X's timbre, and can be combined in Sound sets called Keyboard Sets. They can also be assigned to Style and Song tracks.

Accessing Sound editing

- 1 Press the **SOUND** button in the **MODE** section of the control panel to go to the corresponding mode.
- 2 Press the **MENU** button and touch any of the buttons in the edit menu to choose the **Sound Edit** section.

Choosing the oscillators (OSC)

While in an edit page requiring an oscillator to be selected for editing, use the vertical row of buttons on the right (1...24 max) to select one of the available oscillators. The number of available oscillators depends on the Oscillators Count parameter (in the Sound > Basic > Sound page).



If you cannot see the desired oscillator, touch the scroll arrow, until the hidden oscillator is shown in the display.

When oscillators cannot be selected, since the parameter contained in the current page are global and valid for the whole Sound, these buttons are dimmed, and cannot be selected.

Sounds, Drum Kits, Digital Drawbars

Pa4X features different types of Sounds:

- Ordinary Sounds. These are normal instrument Sounds, like pianos, strings, basses.
- Drum Kits. These are drum and percussion kits, where each note (key) of the keyboard is a different percussive instrument. You can find Drum Kits in the Drum & SFX and User DK banks.
- Digital Drawbars. These are Sounds simulating electromechanical organs. Their complex structure, and the special usage, require their settings to be saved into a Keyboard Set.

Before pressing the MENU button to access the edit pages, you should select a Sound of the type you wish to edit or create.

Setting the Sound's basic parameters

Before editing the oscillators, choose the number of oscillators in the Sound, the Sound's mono/poly mode, and the transpose and legato ranges.

- Go to the Sound > Basic > Sound page.

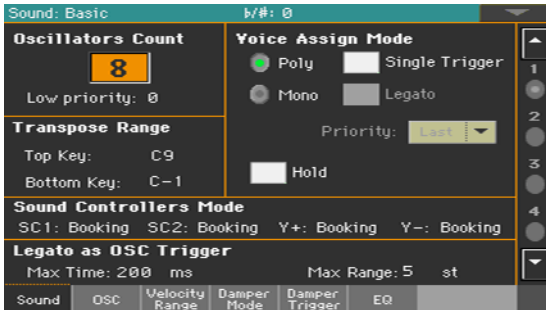

Setting the oscillators

The Oscillator Count section is where you choose how many voices will be used by a single Sound.

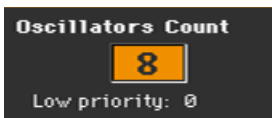

Choosing the number of oscillators

- Use the Oscillators Count parameter to choose the number of oscillators (up to 24) the Sound is based on.

The total polyphony varies depending on the number of oscillators used by the Sound (a maximum of 128 with only 1 oscillator per voice).

Limiting the number of oscillators when polyphony is low

- Use the **Low priority** parameter to allow the highest-numbered oscillators to be turned off when the instrument is short on voices. Keep in mind that, with a dense polyphony, missing oscillators might not even be heard.

Low Priority	Meaning
0	No oscillator will be turned off in any case.
1	The highest-numbered oscillator will be turned off, if needed.
2	The two highest-numbered oscillators can be turned off, one after the other, if needed.
[n]...24	The n-numbered oscillators (up to 24) can be turned off, one after the other, if needed.

Limiting transpose to a defined key range

Some parts of the Sound, in a keyboard range containing special effects, can fall out of the Transpose Range.

Transpose Range	
Top Key:	C9
Bottom Key:	C-1

- Use the **Transpose Range (Top Key and Bottom Key)** parameters to limit transposition to a defined key range. Notes will only be transposed if falling inside this range.

This is useful to avoid RX Sounds to be transposed (therefore reassigned to different sounds) when transposing a Sound. Set these values so that all RX Noises assigned to any oscillator will fall out of the Transpose Range. For example, if you assigned an RX Noise to a G7 on OSC1, and an RX Noise to an A7 on OSC2, set the Top Key value no higher than F#7 (just below the lowest RX Noise).

Polyphony, triggering, legato

The Voice Assign Mode section is where you choose polyphony, triggering and legato.



Choosing the mono/poly mode

- Use the Poly and Mono radio buttons to choose whether the Sound will play polyphonically (playing chords) or monophonically (one voice at a time).

Choosing triggering mode

- When the selected mode is Poly, use the Single Trigger checkbox to choose the triggering mode.

Single Trigger	Meaning
On	When the same note is played repeatedly, the previous note will be silenced before the next note is sounded, so that the notes do not overlap.
Off	When the same note is played repeatedly, the previous note will not be silenced before the next note is sounded.

Activating Legato

- When the selected mode is Mono, use the Legato checkbox to activate Legato.

Legato will make the second note's attack smoother. Envelope and LFO will not be retriggered. This is particularly effective with wind instrument and analog synth-type sounds.

Choosing the Mono note priority

- When the selected mode is Mono, use the **Priority** pop-up menu to specify which note will be given priority when two or more notes are played simultaneously.

Priority	Meaning
Low	The lowest note will take priority.
High	The highest note will take priority.
Last	The last note will take priority.

Holding notes

- Select the **Hold** checkbox to let the notes play even after releasing the keys. This is especially useful for percussive sounds, that you will trigger and let alone sounding.

Setting the Sound Controllers Mode

You can use the assignable switches, footswitch, EC5 switches and the joystick as DNC Sound Controllers. Depending on the Sound, these controllers can 'book' or 'toggle' a DNC function.

Sound Controllers Mode
 SC1: Booking SC2: Booking Y+: Booking Y-: Booking

You can program four controllers:

Sound Controller	Meaning
SC1/2	Two functions that can be assigned to an assignable switch, footswitch, or EC5 switch.
Y-	Backward joystick movement (pull).
Y+	Forward joystick movement (push).

The controller can work in two ways:

Sound Controller Mode	Meaning
Booking	Activate the controller to 'book' its function, then play. The controller will be automatically deactivated.
Toggle	Use the controller to 'toggle' its function between activated and deactivated.

The assigned controller type and status is shown by the indicators on the assignable switches.

Indicator status	Meaning
Off	No DNC function assigned.
Red steady	Booking DNC function available.
Red blinking	Booking DNC function waiting to be executed. Then, it will return steady.
Green steady	Toggle DNC function available.
Green blinking	Toggle activated. Press it again to disable it.

Detecting Legato

Two notes can be considered legato when there is very little or no time between them (and they can even be overlapping). You can adjust the instrument's sensitivity to detect legato.

Legato can be used as an oscillator trigger, when you assign one of the Legato triggers to the OSC Trigger Mode parameter (in the Sound Edit > Basic > OSC Basic page).

Legato as OSC Trigger

Max Time: 200 ms

Max Range: 5 st

Adjusting the time gap

- Use the **Max Time** parameter to set the delay between notes (1...999 ms), to consider them legato, even if there is a very small gap before them.

This is useful to avoid some notes in a chord are played legato, and some others staccato. Notes played with a small gap are still considered legato notes. A value of approx. 15 ms is usually considered effective when playing chords.

Adjusting the key note gap

- Use the **Max Range** parameter to set the range (1...127 semitones) within which notes can be considered legato. If you play a wider interval, the notes are always considered staccato.

This is typical of some acoustic instruments, where legato is only possible within a small interval, but not on wider ones.

As an example, please try the 'Jazz Sax DN1' sound, where the Max Range is 12 semitones. Play legato with intervals smaller than 12 semitones, and you will hear how smoother legato notes will become. Play legato with wider intervals, and legato smoothing will be lost.

Setting the oscillator's basic parameters

Each of the oscillators can play one or two different multisamples (High and Low layers), separated by a velocity switch.

- Go to the Sound > Basic > OSC page.



The multisamples

The OSC Multisample section contains the basic parameters of the assigned multisamples.

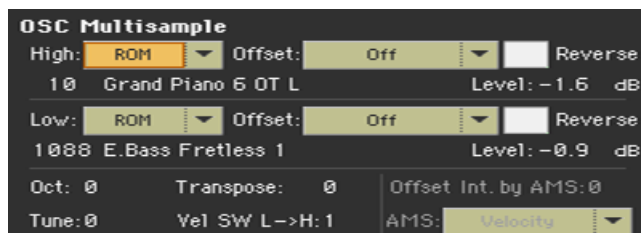

Choosing and setting the multisamples

- Use the **High** and **Low** pop-up menus to choose the multisample's bank (ROM or RAM).
- Use the numeric field next to the multisample name to choose the multisample inside the selected bank.

Bank	Meaning
ROM	Factory multisamples, supplied by KORG as standard.
RAM	User multisamples, loaded when loading some User Sounds.

The High multisample will be triggered by velocities equal or higher than the **Velocity SW L→H** value. If you do not want to use velocity switching, set the switch to a value of 001, and only assign the High multisample.

If you create a new Sound based on RAM samples, the RAM samples must be loaded from the internal drive or from a device connected to the **USB HOST** ports. In case samples are not loaded, no sound will be heard, even if the Sound or multisample can be selected and its name appears in the display.

- Use the **Offset** parameters to specify the point where the multisample(s) will start to play. With some multisamples this parameter is not available.

Offset	Meaning
Off	The sound will start from the beginning of the multisample waveform.
1st...6th	The sound will begin from the offset location predetermined for each sample.
No Attack	The initial portion of the multisample is ignored.
AMS	Activates the Alternate Modulation Source (see below).
PseudoRandom	(Only works when more than a single Offset point is available in the multisample). Randomly selects one of the available Offset points.

- Select the **Reverse** checkbox to reverse the samples in the multisample (reading starts from the end). This can only be activated on some multisamples.
- Use the **Level** parameters to specify the volume level of each multisample.

Depending on the multisample, high settings of this parameter may cause the sound to distort when a chord is played. If this occurs, lower the level.

Setting octave and fine tuning

- Use the **Oct(ave)** parameter to adjust the pitch of the selected oscillator in octave units (-2...+1). The normal octave is 0 (Zero).
- Use the **Transpose** parameter to adjust the pitch of the selected oscillator over a range of ± 1 octave (-12...+12 semitones).
- Use the **Tune** parameter to adjust the pitch of the sample over a range of ± 1 octave (-1200...+1200 cents of a semitone).

Setting the velocity switch between the Low and High layers

- Use the **Vel SW L->H** parameter to set the velocity value dividing the High and Low multisamples for the selected oscillator. Notes struck at this value or harder will be played by the High multisample.

Choosing an AMS (Alternate Modulation Source)

When the **AMS** option is assigned to the **Offset** parameter, the **Offset Intensity by AMS** and **AMS** parameters become available. A list of AMS sources can be found in the Appendix.

When the **Offset Intensity by AMS** parameter has a positive value, the selected **Offset** point will depend by the **AMS** value. For example, with the **Velocity AMS**, playing softly will select the **Off** or **1st Offset**, while playing loudly will select the **6th** or **No Attack Offset**.

When the **Offset Intensity by AMS** parameter has a negative value, the selection will happen in reverse (higher-numbered **Offsets** will be selected before the lowest-numbered ones).

Oscillator triggering

Triggering Mode is how the oscillator will start after pressing a key or a controller.

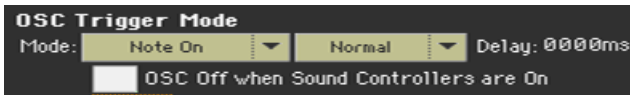

Choosing the oscillator triggering mode

- Use the first OSC Trigger Mode > Mode pop-up menu to choose the event triggering the selected oscillator.

Trigger Mode (What)	Meaning
Note On	The oscillator starts playing when a note is played.
Note Off (VOn)	The oscillator starts playing when a note is released. Note On Velocity is considered. This is useful to create sounds such as the 'click' that is heard when a harpsichord note is released. In this case, set the Sustain parameter to 0 (see the Amp > Amp EG page).
Note Off (VOff)	As the above, but Note Off Velocity is not considered.
Last Note Off (VOn)	The oscillator starts playing only when the last note of a chord or legato sequence is released. Note On Velocity is considered.
Last Note Off (VOff)	As the above, but Note Off Velocity is not considered.
Natural Release	The oscillator starts playing when a note is released. Its amplitude starts from the current amplitude level. If the sound's volume is already at zero, this oscillator is not retriggered.
After Touch	The oscillator starts playing when an After Touch message with a value of at least 90 is received. The Velocity value is the same as the latest Note On message. The oscillator will stop playing when the After Touch value falls back to zero. Hint: This (like the following Triggers) is especially useful to trigger harmonics or growls when a note is already playing.
Joystick Y+	As the above, but with the joystick, assigned as the Sound Controller, pushed at least half-way forward (value 64). This control is equivalent to a CC#01 (Modulation) Control Change message.
Joystick Y-	As the above, but with the joystick, assigned as the Sound Controller, pulled at least half-way back (value 64). This control is equivalent to a CC#02 (Breath Controller) Control Change message.

- Use the second **OSC Trigger Mode > Mode** pop-up menu to choose an additional condition before triggering the selected oscillator. For example, a Normal-triggered oscillator will always play, while a Legato-triggered oscillator will only play when a note is played legato.

Trigger Mode (How)	Meaning
Normal	The oscillator always plays when a key, or another triggering control chosen in the first menu, is pressed.
Legato	The oscillator only plays when the note is played 'legato'. The delay and pitch interval from the previous note are also to be considered, as set in the Sound > Basic > Sound page (Legato as OSC Trigger parameter).
Legato Up	Like Legato, but this is only activated when the second note is out of the Max Range value (as set in the Sound > Basic > Sound page) and it is higher than the first one.
Legato Down	Like Legato, but this is only activated when the second note is out of the "Max Range" value (as set in the Sound > Basic > Sound page) and it is lower than the first one.
Not Legato	The oscillator only plays when the note is NOT played legato (it is the opposite of the above choice). This only works if at least an oscillator is set to Legato; if there isn't, this behaves as a Normal trigger.
Sound Controller 1	<p>The oscillator only plays when a CC#80 (Sound Controller 1) message is received. Press and release the corresponding physical controller, and the next note will also trigger the selected oscillator. If you keep it pressed, the oscillator will continue to be triggered until you release the controller.</p> <p>Note: In Sequencer and Sound mode, the Assignable Switch 1 is automatically assigned to Sound Controller 1.</p> <p>Hint: This (like the following Sound Controllers) is especially useful to enable a different nuance to the following note(s).</p>
Sound Controller 2	<p>As the above, but with the CC#81 (Sound Controller 2) message.</p> <p>Note: In Sequencer and Sound mode, the Assignable Switch 2 is automatically assigned to Sound Controller 2.</p>
Sound Controller Y+	As the above, but with the joystick, assigned as the Sound Controller, pushed at least half-way forward (value 64). The controller is turned off when the joystick is released. This control is equivalent to a CC#01 (Modulation) Control Change message.
Sound Controller Y-	As the above, but with the joystick, assigned as the Sound Controller, pulled at least half-way back (value 64). The controller is turned off when the joystick is released. This control is equivalent to a CC#02 (Breath Controller) Control Change message.
Cycle 1	<p>All oscillators with this same trigger mode assigned will play in cycle. For example, if Oscillators 1, 2 and 4 are assigned the Cycle 1 trigger mode, the following note will trigger Oscillator 1, then 2, then 4, then 1 again.</p> <p>Hint: This is especially useful to trigger different sound nuances or create vector-like sound sequences.</p>

Trigger Mode (How)	Meaning
Cycle 2	As the above, for use with a different (and parallel) group of oscillators. Having two Cycle Trigger Modes allows for cycling stereo multisamples.
Random	As the above, but with a random selection of oscillators within the assigned group.

Choosing a delay before note start

- Use the Delay parameter to set a lapse (0...5000ms) between pressing a key (or in general triggering the oscillator) and hearing the beginning of the sound.

Reversing the controllers

- Select the OSC Off when Sound Controllers are On checkbox to reverse the way Sound Controllers work. With this parameter checked, the current oscillator will not play when one of the Sound Controllers (Sound Controller 1, Sound Controller 2, Sound Controller Y+, Sound Controller Y-) is activated.

It should be applied to oscillators with the After Touch, Joystick Y+, Joystick Y-, Normal, Legato, Legato Up, Legato Down, Not Legato, Cycle 1, Cycle 2, and Random trigger modes, that can be turned off by using a switch, foot-switch or the joystick programmed as a Sound Controller.

Setting the velocity and key zone

You can limit the selected oscillator to play inside a defined velocity zone and key range. This will allow for creating different key and velocity layers.

- Go to the Sound > Basic > Velocity/Range page.



Setting a velocity zone

- Use the Velocity Zone (Top and Bottom) parameters (0...127) to specify the velocity zone for the selected oscillator.

Setting a key range

- Use the Keyboard Range (Top Key and Bottom Key) parameters (C-1...G9) to specify the note range for the selected oscillator.

Scaling the received velocity values

- Use the Scaled Velocity (Top and Bottom) parameters (0...127) to scale the velocity values received by the oscillator. By using the Velocity Zone, an oscillator may be limited to a restricted range (say, 10 to 20), that may result in weak dynamics when the associated sample is triggered.

By assigning a different value to these parameters, the restricted range will be expanded to a wider range (for example, the lowest range value of 10 may be converted to a Scaled Velocity value of 0, and the highest range value of 20 may be converted to a Scaled Velocity value of 127). All values included between the minimum and maximum value are scaled accordingly.

As a consequence, you can create an RX Sound of guitar, by assigning the guitar fret noise to the 10~20 velocity range. When a dynamics value between 10~20 is received, the real velocity value is scaled to the Scaled Velocity values, and will play louder.

Programming the Damper pedal

Programming the pedal

Pa4X carefully recreates the way an acoustic piano Damper pedal works.

- Go to the Sound > Basic > Damper Mode page.



Choosing a Damper pedal mode

- Use the Damper Mode pop-up menu to choose how the Damper pedal will work on the selected oscillator.

Damper Mode	Meaning
Normal	The Damper pedal works as usual: by keeping it pressed, the note decay is lengthened, to simulate the longer note decay of an acoustic piano.
Damper Off	The Damper pedal is deactivated for the selected oscillator. Choose Damper Off, if you plan to use the selected oscillator in the Basic > Damper Trigger page to trigger sounds.
Resonance/Halo	The Damper pedal enables a multisample, normally used for the Piano Resonance/Halo effect. If the pedal is pressed when the note is already playing, the speed at which the multisample appears and disappears, and the volume it can reach, depend on the Resonance/Halo parameters programmed below. Hint: This Damper mode is much more realistic than the Normal mode, but also 'steals' more notes from the overall polyphony, and is especially suggested for solo piano playing. Note: Half-pedaling, as well as Damper messages received via MIDI (as Control Change #64), control the level of the Resonance/Halo effect.

Damper Mode	Meaning
Repedaling	<p>This mode acts as the Normal mode, but also enables the Damper pedal effect when the pedal is pressed after the note has been released (Note Off). In this case, the Damper effect starts from the current Release level, and decays slowly.</p> <p>Do not use Repedaling in Sounds used by Style tracks.</p>

Programming the Resonance/Halo

You can program the Resonance/Halo effect that is enabled by the Resonance/Halo Damper Mode (see above). These parameters only affect the Resonance/Halo that is enabled when pressing the Damper pedal down when a note is already playing.

- Use the **Attack Time** parameter to set the time needed to the Resonance/Halo to reach the maximum level after the Damper pedal has been pressed. Values (0...99) are relative to the current **Amp Env Attack** value.
- Use the **Release Time** parameter to set the time needed to the Resonance/Halo to fade out after the Damper pedal has been released. Values (0...99) are relative to the current **Amp Env Release** value.
- Use the **Volume Scaling** parameter to set the volume of the Resonance/Halo effect. Values (0...100%) are relative to the current level of the sound, as determined by the sum of the Multisample Volume, Velocity value and current **Amp Env** value. 0% is no volume at all.

Setting a key range without dampers

In an acoustic piano, the felt dampers can only dampen strings up to a certain note. Starting from that note (usually G6), it is as if the Damper pedal was always pressed down, and the dampers removed from the strings.

- When the Damper is in **Normal** mode (see above), use the **No Note Off Range > From Note** parameter to choose the note (C#-1...G9) starting from which notes are never dampened.

This parameter has no effect on the Resonance/Halo mode.

Triggering notes when pressing or releasing the Damper pedal

Special effects can be achieved by triggering notes with the Damper pedal.

- Go to the Sound > Basic > Damper Trigger page.

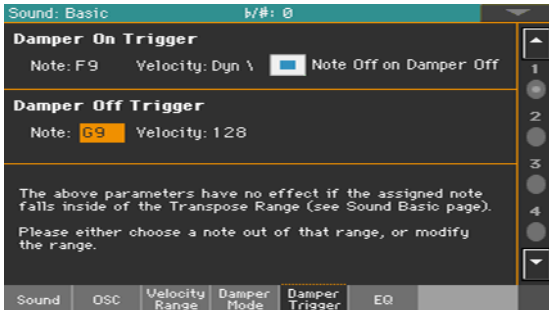

The parameters in this page apply to the Sound as a whole, and not to a single oscillator.

As warned by the message on the lower area of the display, triggered notes must fall out of the Transpose Range programmed in the Sound > Basic > Sound page. Please either choose a note out of that range, or edit the Transpose Range, so that the note is either higher or lower than that range.

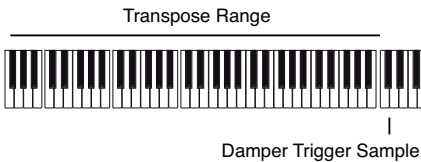

Playing a note when pressing the Damper pedal

The Damper On Trigger parameters allow to play a note when pressing the Damper pedal (Damper On).

This is useful when a special sample is assigned to a particular note (for example, pedal down squeaking in the Sound 'Grand Piano Demo', breathing in the 'Harmonica 1 DNC' Sound ...).

- Choose a Note, and set its Velocity.
- Select the Note Off on Damper Off checkbox to make the sound stop when the Damper pedal is released.

Playing a note when releasing the Damper pedal

The **Damper Off Trigger** parameters allow to play a note when releasing the Damper pedal (Damper Off).

Releasing the Damper pedal can play a special sample assigned to a particular note (for example, Damper pedal release noise in the 'Grand Piano Demo' Sound).

- Choose a Note, and set its Velocity.

Equalizing the Sound

You can use a three-band, semi-parametric equalizer on each oscillator.

- Go to the Sound > Basic > EQ page.



Activating the EQ

- Select the Enable checkbox to activate the equalizer on the selected oscillator.

Trimming and programming the EQ

- Use the Trim knob to limit the level of the signal passing through the equalizer (0...99). Extreme equalization values can overload the audio circuits and lead to distortion. This control lets you set equalization as desired, and at the same time avoid overloading.
- Use the EQ controls to create the equalization curve.

EQ Control	Meaning	Value
Low Gain	Low frequencies equalization. This is a shelving curve filter.	-18...+18dB
Mid (Middle) Gain	Middle frequencies equalization. This is a bell curve filter.	-18...+18dB
Mid (Middle) Freq	Centre frequency of the middle frequencies equalization.	0.100...10kHz
Hi (High) Gain	High frequencies equalization. This is a shelving curve filter.	-18...+18dB

Setting the Drum Kit's basic parameters

When editing a Drum Kit, you first choose and set the percussive samples assigned to each key and velocity layer.

- Go to the Sound > DrumKit > DrumKit page.

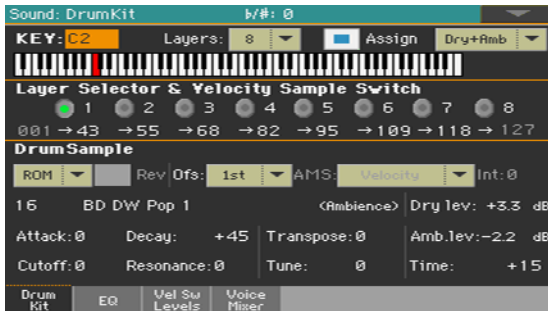

Selecting and setting a key

The key can be selected and programmed in the KEY section.



Choosing the key to edit

- Use the KEY parameter to select a key. As an alternative, select it by pressing a key on the keyboard.

Choosing the number of layers per key

Each key can have a variable number of velocity zones (layers). This allows for assigning different samples to different playing velocity strengths.

- Use the Layers pop-up menu to choose the number of layers assigned to the selected key. Depending on the number of selected layers, a different number of velocity switches will become available.

Turning the key on or off

- Use the Assign checkbox to turn the selected key on/off. When a key is not assigned, the next assigned key on the right will extend over it.

Selecting the dry or ambient portion of the sound

You can separately listen to the dry or ambient portion of the percussive samples while editing.

- Use the Dry+Amb menu to choose the dry and/or ambient portion of the sound.

Layer and velocity switch

After having selected a key to edit, choose the velocity layer.



Choosing the layer to edit

- Use the radio buttons in the Layer Selector & Velocity Sample Switch area to select the layer to edit. The available number of layers depend on the Layers pop-up menu above.

Editing the velocity switches

Each of the velocity switch values in the Layer Selector & Velocity Sample Switch area separates two adjacent layers of the selected key. Notes stricken harder than a velocity switch will be played by the layer on the right, while notes stricken softer are played by the layer on the left.

The first and last values are not editable, and are always 001 and 127 (respectively).

Choosing and setting the drum samples

Use the Drum Sample section to assign a percussive sample to the selected velocity layer inside the selected key.

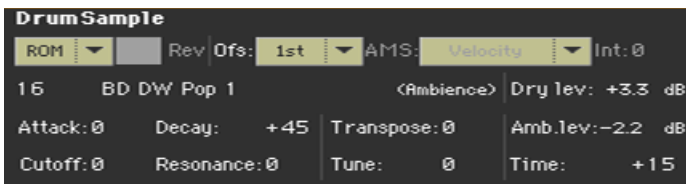

The available parameters depend on the selected sample.

Choosing a drum sample

- Use the **Drum Sample** parameters to assign a different drum sample to each layer. You can use velocity to switch between the available samples. **Offset** and **Level** can be adjusted independently for the various drum samples.

Use the pop-up menus to choose the bank (ROM or RAM).

Use the numeric field next to the sample name to choose the sample inside the selected bank.

Bank	Meaning
ROM	Factory samples, supplied by KORG as standard.
RAM	User samples, loaded when loading some User Drum Kits.

The sample you select for the current layer will be triggered by velocities higher than the value of the velocity switches. If you do not wish to use velocity switching, assign just one layer to the selected key, and assign a sample only to layer 1.

If you create a new Drum Kit based on RAM samples, the RAM samples must be loaded from the internal drive or from a device connected to the **USB HOST** ports. In case samples are not loaded, no sound will be heard, even if the Drum Kit can be selected and its name appears in the display.

- Select the **Rev (Reverse)** checkbox to play the sample in reverse (if this is allowed by the sample). In the case of samples that were originally specified to loop, the sample will be played back in one-shot reverse mode. If the sample was originally set to reverse, it will playback without change.

Setting a sample start offset

- Use the **Ofs (Offset)** parameter to specify the point where the sample will start to play.

Offset	Meaning
Off	The sound will start from the beginning of the sample.
1st...6th	The sound will begin from the offset location pre-determined for each sample.
NoAtk	The initial portion of the multisample is ignored.
AMS	Activates the Alternate Modulation Source (see below).
PseudoRandom	(Only works when more than one Offset point is available in the multisample). Randomly selects one of the available Offset points.

- Use the **AMS** and **Int(ensity)** parameters to choose the AMS modulation source and its intensity.

When the Intensity parameter has a positive value, the selected Offset point will depend on the AMS value. For example, with the Velocity AMS, playing softly will select the Off or 1st Offset, while playing loudly will select the 6th or No Attack Offset.

When the Intensity parameter has a negative value, the selection will happen in reverse (higher-numbered Offsets will be selected before the lowest-numbered ones).

Setting the sample level

- Use the **Level** parameter to specify the level of the sample.

Programming the sample envelope

- Use the **Attack** and **Decay** parameters to offset the selected sample's EG Attack and Decay segments.

Programming the filter

- Use the **Cutoff** and **Resonance** parameters to set the cutoff frequency and resonance for the filter applied to the selected sample.

Setting transpose and fine tuning

- Use the **Transpose** parameter (-64...+63 semitones) to transpose the selected sample. Use it to change the pitch of the selected key.
- Use the **Tune** parameter (-99...+99 cents of a semitone) to fine-tune the assigned sample.

Adjusting the ambient level and time

- Use the **Amb Level / Time** parameters to adjust the ambient level and pan.

These parameters are only available if the selected Drum sample is of the Ambient type. When these parameters are available, **Level** controls the volume of the direct (dry) sounds, while **Amb. Level** and **Time** control the volume and length of the ambience respectively.

Equalizing the Drum Kit

Each of the drum samples can be processed with a three-band, semi-parametric equalizer.

- Go to the Sound > DrumKit > EQ page.



Choosing the key to edit

- Use the Key parameter to select a key. As an alternative, select it by pressing a key on the keyboard.

The Layers and Assign parameters are the same of the Sample Setup page.

Trimming and programming the EQ

- Select the Enable checkbox to activate the equalizer on the selected layer.
- Use the Trim knob to limit the level of the signal passing through the equalizer (0...99). Extreme equalization values can overload the audio circuits and lead to distortion. This control lets you set equalization as desired, and at the same time avoid overloading.

- Use the EQ controls to create the equalization curve.

EQ Control	Meaning	Value
Low Gain	Low frequencies equalization. This is a shelving curve filter.	-18...+18dB
Mid (Middle) Gain	Middle frequencies equalization. This is a bell curve filter.	-18...+18dB
Mid (Middle) Freq	Centre frequency of the middle frequencies equalization.	0.100...10kHz
Hi (High) Gain	High frequencies equalization. This is a shelving curve filter.	-18...+18dB

Mixing the Drum Kit layers

You can see all the drum samples, dry/ambient levels, and velocity switches of the available layers in a single page. While in this page, you can see which layer is playing.

- Go to the Sound > DrumKit > Velocity Switch Levels page.

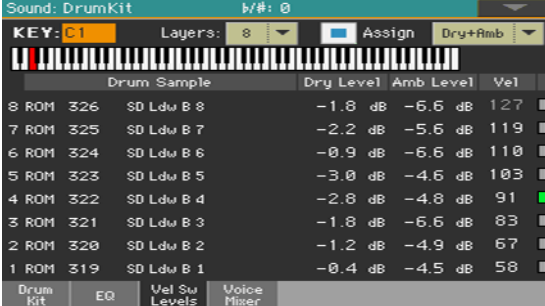

Drum Sample	Dry Level	Amb Level	Vel
8 ROM 326 SD Ldw B 8	-1.8 dB	-6.6 dB	127
7 ROM 325 SD Ldw B 7	-2.2 dB	-6.6 dB	119
6 ROM 324 SD Ldw B 6	-0.9 dB	-6.6 dB	110
5 ROM 323 SD Ldw B 5	-3.0 dB	-4.6 dB	103
4 ROM 322 SD Ldw B 4	-2.8 dB	-4.8 dB	91
3 ROM 321 SD Ldw B 3	-1.8 dB	-6.6 dB	83
2 ROM 320 SD Ldw B 2	-1.2 dB	-4.9 dB	67
1 ROM 319 SD Ldw B 1	-0.4 dB	-4.5 dB	58

View which layer is playing

- Play a note on the keyboard. Depending on the velocity, an indicator will turn on on the extreme right of the page, next to the layer that is playing.

Choose the drum sample

- Use the ROM/RAM parameter to choose the bank (ROM or RAM).
- Use the drum sample name parameter to assign a different drum sample to each layer.

Adjust the dry/ambient level

- Use the Dry Level and Amb Level parameters to adjust the level of the dry and ambient portion of the sound.

Adjust the velocity switch

- Use the Vel parameter to adjust the velocity switch between the layers.

Mixing and retriggering the drum samples

You can choose a triggering mode, and mix the key (usually a percussive sound with its different velocity layers) with the other keys. All layers of the selected key will get the same settings.

- Go to the Sound > DrumKit > Voice/Mixer page.

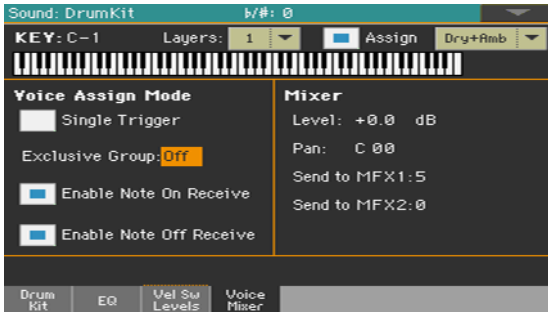

Choosing the key to edit

- Use the Key parameter to select a key. As an alternative, select it by pressing a key on the keyboard.

The Layers and Assign parameters are the same of the Sample Setup page.

Choosing polyphony, retriggering and legato

- Use the Single Trigger checkbox to choose the triggering mode.

Single Trigger	Meaning
On	When the same key (note) is played repeatedly, the previous note will be stopped before the new note is triggered, so that they will not overlap.
Off	When the same key (note) is played repeatedly, the previous note will not be stopped before the new note is triggered.

Creating exclusive groups

Exclusive Groups are sets of mutually exclusive keys, stopping each other. For example, if the Open Hi-Hat and Closed Hi-Hat are assigned the same Exclusive Group, playing an Open Hi-Hat will stop the Closed Hi-Hat playing.

Exclusive Group	Meaning
None	No Exclusive Group assigned. The selected key will not be stopped by any other key.
1...127	Exclusive Groups assigned to the selected key. When you play this key, all other keys assigned to the same Exclusive Group will be stopped, and this key will be stopped by other keys assigned to the same Exclusive Group.

Enabling Note On and Note Off

- Select the **Enable Note On Receive** checkbox to enable reception of the Note On (Key On) message.

If this parameter is not selected, the key will not play.

- Select the **Enable Note Off Receive** checkbox to enable reception of the Note Off (Key Off) message.

If this parameter is not selected, the sample will continue to play to the end of the sample.

Setting the Level, Pan and FX Send mixing parameters

- Use the **Level** parameter to set the level of the selected key.
- Use the **Pan** parameter to set the position of the selected key in the stereo panorama.
- Use the **Send to MFX1** and **Send to MFX2** parameters to set the MFX1 or MFX2 send level for the selected key.

Modulating pitch

Pitch can change depending on the note and the activated controllers. Pa4X also includes LFO generators that can modulate the pitch.

- Go to the Sound > Pitch > Pitch Mod page.

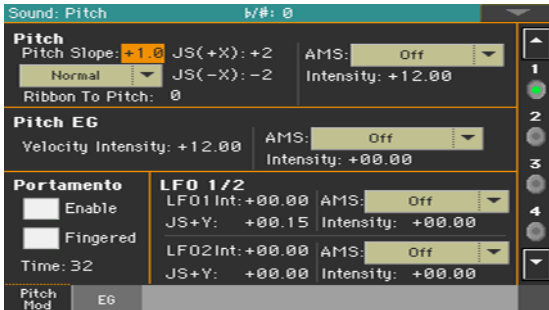

Controlling pitch

The oscillator's pitch can follow the natural scale, or a different pitch 'slope'.

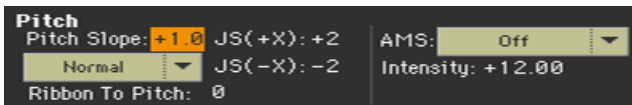

Setting the Pitch Slope

- Use the Pitch Slope parameter (-1.0...+2.0) to change pitch depending on the note position on the keyboard.

Normally you will leave this parameter at +1.0. Positive (+) values will cause the pitch to raise as you play higher notes, and negative (-) values will cause the pitch to fall as you play higher notes.

With a value of 0, there will be no change in pitch, and the C4 pitch will sound regardless of the keyboard location you play.

The diagram shows how the Pitch Slope and pitch are related:

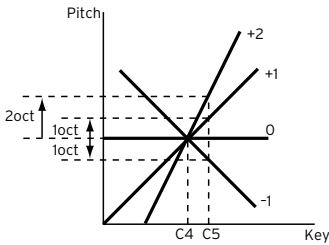

Controlling the pitch with physical controllers

- Use the Pitch Mode pop-up menu to set the Pitch Bend direction.

Pitch Mode	Meaning
Normal	Linear bending.
Fixed Scale	When this parameter is turned on on an oscillator, Pitch Bend and Sub Scale have no effect on its tuning. The relevant parameters are greyed out and non-selectable.
Highest Pitch Bend only	On this oscillator, Pitch Bend is only activated on the highest note currently playing on the keyboard.
Lowest Pitch Bend only	On this oscillator, Pitch Bend is only activated on the lowest note currently playing on the keyboard.

- Use the **Ribbon to Pitch** parameter to set the Pitch Bend range (-12...0...+12 semitones) controlled by the Ribbon Controller message (CC#16). The Ribbon Controller message can be received from MIDI or contained in a Standard MIDI File.
- Use the **JS (+X)** parameter to specify how the pitch will change when the joystick is moved all the way to the right (-60...+12 semitones). A setting of 12 produces 1 octave of change.

For example if you set this to +12 and move the joystick all the way to the right, the pitch will rise one octave above the original pitch.

- Use the **JS (-X)** parameter to specify how the pitch will change when the joystick is moved all the way to the left (-60...+12 semitones). A setting of 12 produces 1 octave of change.

For example, if you set this to -60 and move the joystick all the way to the left, the pitch will fall five octaves below the original pitch. This can be used to simulate the downward swoops that a guitarist produces using the tremolo arm.

Choosing a pitch modulation source

- Use the Pitch > AMS (Alternate Modulation Source) pop-up menu to select a modulation source for the pitch of the selected oscillator. A list of the available AMS sources is in the Appendix.

The Intensity parameter (-12.00...+12.00) specifies the depth and direction of the effect produced by the AMS. With a setting of 0, no modulation will be applied. With a setting of 12.00, the pitch will change up to one octave.

For example, if you choose the JS (-Y) AMS and move the joystick downwards, the pitch will rise if this parameter is set to a positive (+) value, or fall if this parameter is set to a negative (-) value. The range is a maximum of one octave.

Controlling the Pitch EG (Envelope Generator)

Use the Pitch EG parameters to controls the Pitch EG unique to all oscillators.

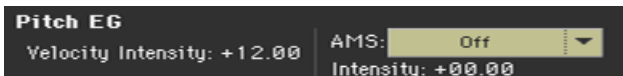

Linking pitch to the envelope

- The Velocity Intensity parameter (-12.00...+12.00) specifies the depth and direction of the Pitch EG modulation. With a setting of 12.00, the pitch will change a maximum of ± 1 octave.

Linking pitch to an AMS modulation

- Use the Pitch EG > AMS parameter to select a modulation source for the pitch EG of the selected oscillator. A list of the available AMS sources is in the Appendix.
- Use the Pitch EG > Intensity parameter to specify the depth and direction of the AMS. For example, if you choose the Velocity AMS and set this value to +12.00, the velocity will control the range of pitch change produced by the pitch EG in a range of ± 1 octave. As you play more softly, the pitch change will draw closer to the pitch EG levels.

The Pitch EG > AMS and Pitch EG > Intensity will be summed to determine the depth and direction of the pitch modulation applied by the pitch EG.

Pitch change (level)

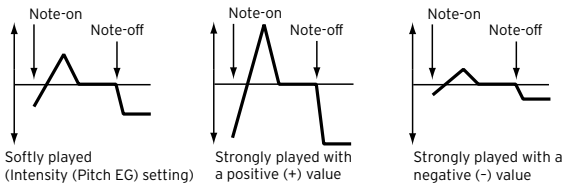

Programming Portamento

Portamento adds a slide between notes (a smooth change in pitch from one note to the next).

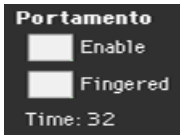

- Select the **Enable** checkbox to activate the portamento effect.

Portamento will also be switched on or off when the CC#65 (Portamento SW) message is received.

- Select the **Fingered** checkbox to make portamento restart when playing a note.

When Fingered is enabled, playing legato will turn Portamento on, while playing detached will turn it off again.

- Use the **Time** parameter to set the portamento time (000...127). Increasing the value will produce a slower change in pitch.

Controlling the LFO

Use the LFO 1/2 parameters to controls the LFO (Low Frequency Oscillation) on the selected oscillators. LFO generators are programmed in the Sound Edit > LFO > LFO 1 and LFO 2 pages.

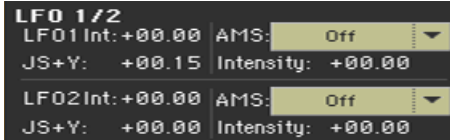

- Use the LFO 1/2 Int parameter to set the intensity (-12...0...+12) of the corresponding LFO. Negative values will invert the LFO shape.
- Use the JS+Y parameter to set the intensity (-12...0...+12) of the corresponding LFO when the joystick is pushed forward. Negative values will invert the LFO shape.
- Use the AMS and Intensity parameters to choose an AMS to modulate the corresponding LFO, and the intensity of the modulation.

Programming the pitch envelope (Pitch EG)

Pa4X includes a pitch envelope generator (Pitch EG) that can vary the pitch over time.

- Go to the Sound > Pitch > EG page.

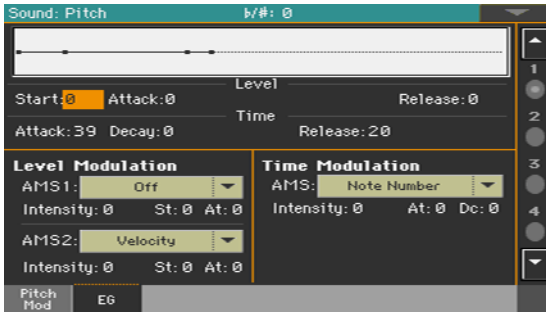

You can see the shape of the envelope in the diagram on top of the page.

Setting the Pitch EG levels and times

Pitch EG can be programmed by setting the Level and Time parameters of the envelope segments.

Time-varying pitch settings (when Pitch EG Intensity = +12.00)

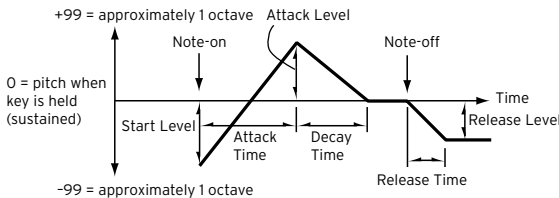

- Use the Level parameters (-99...+99) to specify the amount of pitch change.

EG Level	Meaning
Start	Amount of pitch change at note start.
Attack	Amount of pitch change when the attack time has elapsed.
Release	Amount of pitch change when the release time has elapsed.

The actual amount of pitch change will depend on the Pitch EG > Intensity parameters (see the Sound > Pitch > Pitch Mod page). For example, with an Intensity setting of +12.00, a Level setting of +99 would raise the pitch one octave, and a Level setting of -99 would lower the pitch one octave.

- Use the Time parameters (0...99) to specify the time over which the pitch change will occur.

EG Time	Meaning
Attack	Time over which the pitch will change from note-on until it reaches the pitch specified as the attack level.
Decay	Time over which the pitch will change after reaching the attack level until it reaches the normal pitch.
Release	Time over which the pitch will change from note-off until it reaches the pitch specified as the release level.

Modulating the Pitch EG

Modulating the Pitch EG levels

Use the Level Modulation > AMS 1/2 parameters to select a modulation source for the Pitch EG > Level parameters.

- Use the Level Modulation > Intensity parameters (-99...+99) to specify the depth and direction of the modulation generated by AMS1 or AMS2. With a setting of 0, the levels specified by the Level parameter will be used.

For example, if you choose the Joystick Y+ the AMS, moving the Joystick in the upper direction to turn it on will change the Level parameters of the Pitch EG. As the absolute value of Intensity is increased, the Pitch EG levels will change more when the Joystick is released. The direction of the change is specified by St (Start Level Swing) and At (Attack Level Swing). When the Joystick is released, the Pitch EG levels will return to their own settings.

If you choose the Velocity AMS, increasing the absolute value of Intensity will produce increasingly wider change in Pitch EG levels for strongly-played notes. The direction of the change is specified by St (Start Level Swing) and At (Attack Level Swing). As you play more softly, the pitch change will draw closer to the Pitch EG levels.

- Use the St (Start Level Swing) and the At (Attack Level Swing) parameters to specify the direction of change in Level > Start and Level > Attack caused by the AMS.

If the Intensity is a positive (+) value, a setting of + will increase the EG level, and a setting of - will decrease it. With a setting of 0 there will be no change.

Pitch EG change (level) (AMS=JS-Y/Velocity, Intensity= positive (+) value)

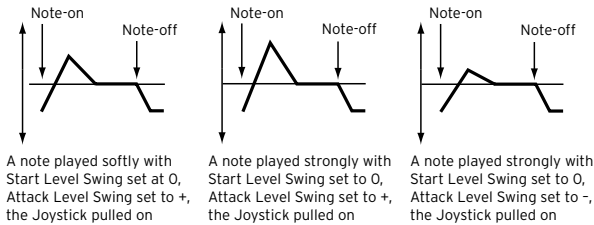

Modulating the Pitch EG times

Use the **Time Modulation > AMS** parameter to select a modulation source for the **Pitch EG > Time** parameters.

- Use the **Time Modulation > Intensity** parameters (-99...+99) to specify the depth and direction of the effect that AMS will have on the Time parameters. With a setting of 0, the pitch EG times will be just as specified by the Time settings.

The alternate modulation value at the moment that the EG reaches each point will determine the actual value of the EG time that comes next.

For example, the decay time will be determined by the alternate modulation value at the moment that the attack level is reached.

When this parameter is set to values of 16, 33, 49, 66, 82, or 99, the specified EG times will speed up as much as 2, 4, 8, 16, 32, or 64 times respectively (or slowed down to 1/2, 1/4, 1/8, 1/16, 1/32, or 1/64 of the original time).

For example, with the Velocity AMS, increasing the absolute value of Intensity will allow strongly-played notes to increase the changes in pitch EG Time values. The direction of the change is specified by At (Attack Time Swing) and Dc (Decay Time Swing). As you play more softly, the pitch EG times will more closely approach the actual settings of the pitch EG.

- Use the **At (Attack Time Swing)** and the **Dc (Decay Time Swing)** parameters to specify the direction in which AMS will affect the **Time > Attack** and **Decay** parameter. With positive (+) values of Intensity, a setting of + will cause the

time to be lengthened, and a setting of - will cause the time to be shortened. With a setting of 0 there will be no change.

Pitch EG changes (Time) (AMS = Velocity, Intensity = positive (+) value)

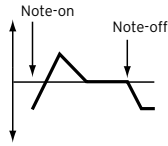

A note played softly with
Attack Time Swing set to + and
Decay Time Swing set to +

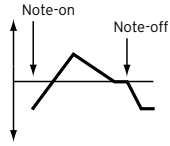

A note played strongly with
Attack Time Swing set to +
and Decay Time Swing set to +

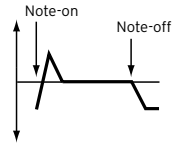

A note played strongly with
Attack Time Swing set to - and
Decay Time Swing set to -

Programming the filters

As in a subtractive analogue synthesizer, filters are the main agents of the sound's timbre quality. Envelope and modulation allow for timbral shift over time, making the sound alive.

Choosing the filters

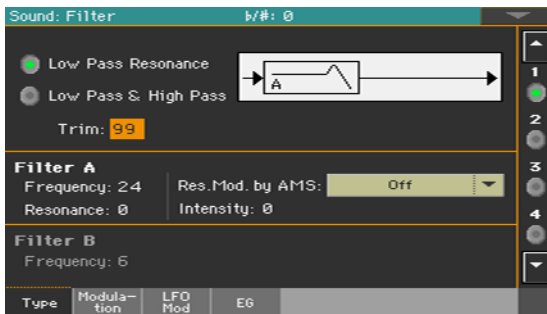

You can choose one of two filters for the selected oscillator.

- Go to the Sound > Filter > Filter Type page.



Choosing the filter type

- Use the Filter Type radio buttons to choose the type of filter for the selected oscillator.

Filter Type	Meaning
Low Pass Resonance	This is a 24db/oct filter. When the Low Pass filter type is selected, only filter A will be activated. 
Low Pass & High Pass	These are two 12dB/oct filters in series. When the Low Pass & High Pass filter type is selected, the filter B will be activated. 

Trimming the filter input

- Use the Trim parameter (00...99) to adjust the level at which the audio signal generated by the selected oscillator is input to filter A.

If this value is too high, the sound may distort when Resonance is set to a high value, or when you play a chord.

Programming the filters

Programming filter A

- Use the Filter A > Frequency parameter to set the cutoff frequency of filter A (00...99).

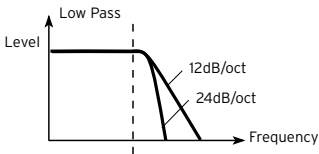

This is a filter that cuts the high-frequency region above the cutoff frequency. This is the most common type of filter, and is used to cut part of the overtone components, making an originally bright timbre sound more mellow (darker). When the "Filter Type" is Low Pass Resonance, the cutoff will have a steeper slope.

- Use the Filter A > Resonance parameter to set the resonance of filter A (00...99).

The resonance emphasizes the overtone components that lie in the region of the cutoff frequency specified by Frequency, producing a more distinctive sound. Increasing this value will produce a stronger effect.

- Use the Res. Mod. by AMS parameter to choose a modulation source for the Resonance parameter.

The effect of resonance

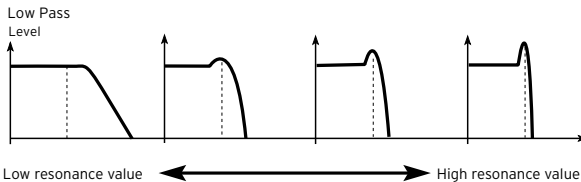

- Use the Intensity parameter (-99...+99) to specify the depth and direction of the effect that Res. Mod. by AMS will have on the resonance level specified by Resonance.

For example if Velocity has been selected, changes in keyboard velocity will affect the resonance.

With positive (+) values, the resonance will increase as you play more strongly, and as you play more softly the resonance will approach the level specified by the Resonance setting.

With negative (-) values, the resonance will decrease as you play more strongly, and as you play more softly the resonance will approach the level specified by the Resonance setting.

The resonance level is determined by summing the Resonance and Intensity values.

Programming filter B

When both filters are activated, you can also program filter B.

- Use the Filter B > Frequency parameter to set the cutoff frequency of filter B (00...99).

This parameter is only available when the selected filter type is Low Pass & High Pass.

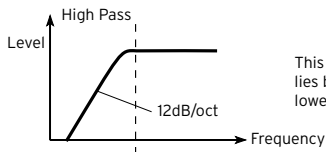

This filter cuts the low-frequency range that lies below the cutoff frequency. By cutting the lower overtones, it lightens the tone.

Modulating the filters

You can modulate the filter cutoff frequency of the selected oscillator. Modulation will add dynamic timbre variation.

Programming realtime filter modulation

- Go to the Sound > Filter > Modulation page.

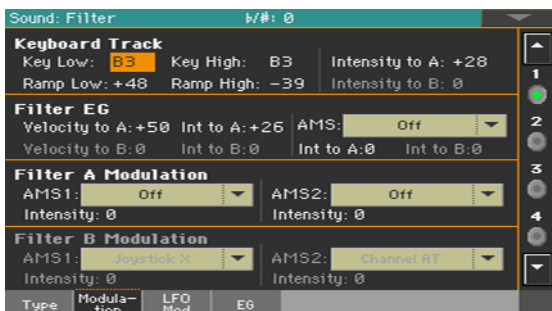

When the filter type is Low Pass Resonance, the parameters for filter B will not be editable (dimmed).

Tracking the cutoff frequency across the keyboard

Keyboard Tracking changes the timbre quality across the keyboard.

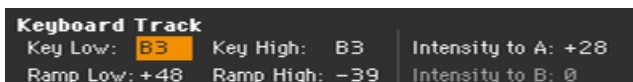

- Use the Key Low/High parameters (C-1...G9) to change the filter cutoff frequency across the keyboard for the selected oscillator.

Keyboard Tracking varies the cutoff frequency according to the position of the key on the keyboard. How the cutoff frequency is affected by the keyboard location can be specified by the Key Low, Key High, Ramp Low, Ramp High, and the Intensity to A/B parameters.

Keyboard tracking will apply to the range below the specified Low note number, and above the specified High note number.

- Use the **Ramp Low/High** parameters to specify the slope of the keyboard tracking (-99...+99).

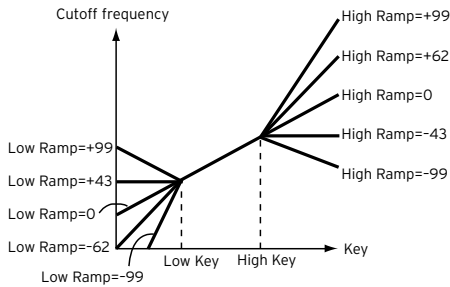

- Set the **Intensity to A** and **Intensity to B** parameters (-99...+99) to specify the depth and direction of the changes applied to filters A and B.

For the range of notes between Key Low and Key High, the cutoff frequency will change according to the keyboard location (pitch).

Modulating the Filter EG (Envelope Generator)

The filter envelope can be controlled while playing.

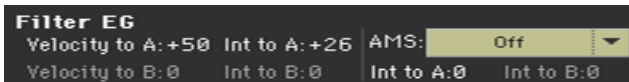

- Use the **Velocity to A/B** parameter (99...+99) to specify the depth and direction of the effect that velocity will have on the time-varying changes created by the filter EG (as set on Filter > Filter EG) to control the filter A/B cutoff frequency.

With positive (+) values, playing more strongly will cause the filter EG to produce greater changes in cutoff frequency. With negative (-) values, playing more strongly will also cause the filter EG to produce greater changes in cutoff frequency, but with the polarity of the EG inverted.

- Use the **Int to A/B** parameters (-99...+99) to specify the depth and direction of the effect that the time-varying changes created by the filter EG will have on the filter A/B cutoff frequency.

With positive (+) settings, the sound will become brighter when the EG levels set by Filter EG Level and Time parameters are in the '+' area, and darker when they are in the '-' area.

With negative (-) settings, the sound will become darker when the EG levels set by Filter EG Level and Time parameters are in the '+' area, and brighter when they are in the '-' area.

- Use the AMS pop-up menu to select a modulation source for the filter EG applied to the cutoff frequency of filters A and B.
- Use the Int to A/B parameters (-99...+99) to specify the depth and direction of the effect that the AMS will have on filter A/B.

The sum of the settings for Velocity to A/B, Intensity to A/B, and (AMS) Intensity to A/B will determine the depth and direction of the effect produced by the filter EG.

Changes in cutoff frequency

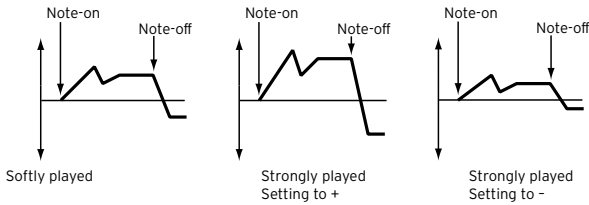

Modulating the filters cutoff frequency

You can control the filters with a modulation source.

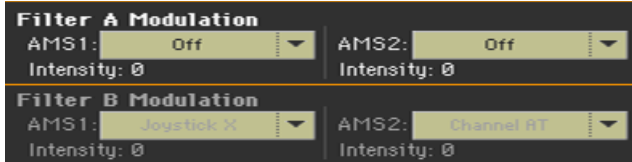

- Use the AMS 1/2 parameters to select a modulation source for the filter A/B cutoff frequency.
- Use the Intensity (AMS 1/2) parameters to specify the depth and direction of the AMS 1/2.

When AMS1 is JS X, a positive (+) value for this parameter will cause the cutoff frequency to rise when the joystick is moved toward the right, and fall when the joystick is moved toward the left. With a negative (-) value for this parameter, the opposite will occur.

This value is summed to the setting of the Filter A/B Frequency.

Applying LFO to the filters

You can use LFO to apply cyclic modulation to the cutoff frequency of the filters. This will create cyclical changes in tone on the selected oscillator.

- Go to the Sound > Filter > LFO Mod page.

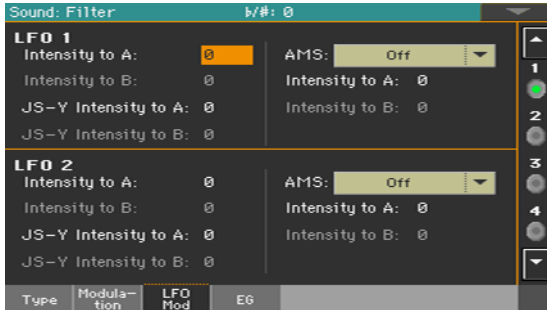

Modulating the filters with the LFOs

- Use the LFO 1/2 > Intensity to A/B parameters (-99...+99) to specify the depth and direction of the modulation that LFO 1/2 (set on Sound Edit > LFO > LFO 1 or LFO 2) will have on the cutoff frequency of filter A/B. Negative (-) settings will invert the phase.

Change in cutoff

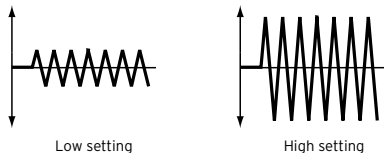

- Use the JS (Joystick) -Y Intensity to A/B parameters (-99...+99) to modulate LFO with the joystick pulled back.

By moving the joystick in the Y direction (toward yourself), you can control the depth at which LFO 1/2 modulates the cutoff frequency of filter A/B. This parameter specifies the depth and direction of the control.

Higher settings of this parameter will produce greater increases in the effect of LFO 1/2 on the filter when the joystick is moved toward yourself.

- Use the LFO 1/2 > AMS pop-up menus to select a modulation source for the cutoff frequency of both filters A and B.

The Intensity to A/B parameters (-99...+99) set the depth and direction of the effect that the AMS will have on filter A/B.

For example if the AMS is Joystick Y+, higher settings of this parameter will allow greater change to be applied to LFO 1/2 when you move the Joystick up in the Y axis.

Programming the filter envelope (Filter EG)

You can create an envelope to vary over time the cutoff frequency of the filters on the selected oscillator.

- Go to the Sound > Filter > EG page.

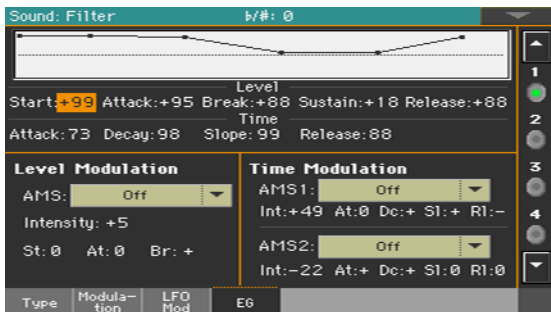

You can see the shape of the envelope in the diagram on top of the page.

Setting the Filter EG levels and times

Filter EG can be programmed by setting the Level and Time parameters of the envelope segments.

The result will depend on the filter type. For example, with the Low Pass Resonance filter, positive (+) values of EG Intensity will cause the tone to be brightened by positive (+) levels, and darkened by negative (-) levels.

Also, the effect of these settings on the filter cutoff frequency depends by the Velocity and Intensity parameters of the Filter > Modulation page.

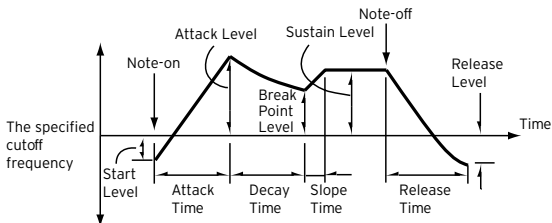

- Use the Level parameters (-99...+99) to specify the amount of cutoff frequency change.

EG Level	Meaning
Start	Change in cutoff frequency at the time of note-on.
Attack	Change in cutoff frequency after the attack time has elapsed.
Break (Break Point)	Change in cutoff frequency after the decay time has elapsed.
Sustain	Change in cutoff frequency that will be maintained from after the slope time has elapsed until note-off occur.
Release	Change in cutoff frequency that will occur when the release time has elapsed.

- Use the Time parameters (0...99) to specify the time over which the cutoff frequency change will occur.

EG Time	Meaning
Attack	Time over which the level will change from note-on until the attack level is reached.
Decay	Time over which the level will change from the attack level to the break point level.
Slope	Time over which the level will change after the decay time has elapsed until the sustain level is reached.
Release	Time over which the level will change after note-on occurs until the release level is reached.

Modulating the Filter EG

Modulating the Filter EG levels

- Use the **Level Modulation > AMS** parameter to select the source that will control the Level parameters of the filter EG.
- Use the **Level Modulation > Intensity** parameters (-99...+99) to specify the depth and direction of the AMS. With a setting of 0, the levels specified by the **Frequency** parameter will be used.

For example, if AMS is Velocity, and you set St (Start Level Swing), At (Attack Level Swing) and Br (Break Level Swing) to + and set Intensity to a positive (+) value, the EG levels will rise as you play more strongly. If Intensity is set to a negative (-) value, the EG levels will fall as you play harder.

- Use the **St (Start Level Swing)**, **At (Attack Level Swing)** and **Br (Break Level Swing)** parameters to specify the direction in which AMS will affect the Start, Attack and Break Point.

When Intensity has a positive (+) value, a setting of + for this parameter will allow the AMS to raise the EG level, and a setting of - will allow AMS to lower the EG level. With a setting of 0 there will be no change.

Filter 1 EG changes (level) (AMS = Velocity, Intensity = a positive (+) value)

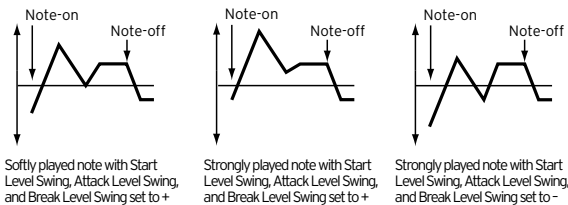

Modulating the Filter EG times

- Use the **Time Modulation > AMS 1/2** parameters to select a modulation source for the Time parameters of the filter EG.
- Use the **Time Modulation > Intensity** parameters (-99...+99) to specify the depth and direction of the effect that the AMS will have on the Time parameters. With a setting of 0, the filter EG times will be just as specified by the Time settings.

For example, if the AMS is set to FltKTr +/+, the EG Time parameters will be controlled by the Keyboard Tracking settings. With positive (+) values of this parameter, positive (+) values of Ramp Low/High will lengthen the EG times, and negative (-) values of Ramp Low/High will shorten the EG times. The direction of change is specified by At (Attack Time Swing), Dc (Decay Time Swing), Sl (Slope Time Swing), and Rl (Release Time Swing).

With a setting of 0, the times specified by the Frequency parameter will be used.

If the AMS is set to Velocity, positive (+) values of this parameter will cause EG times to lengthen as you play more strongly, and negative (-) values will cause EG times to shorten as you play more strongly.

- Use the **At (Attack Time Swing)**, **Dc (Decay Time Swing)**, **Sl (Slope Time Swing)** and **Rl (Release Time Swing)** parameters to specify the direction in which the AMS will affect the Time > Attack, Decay, Slope and Release parameters.

With positive (+) values of Intensity, a setting of + will cause the time to be lengthened, and a setting of - will cause the time to be shortened. With a setting of 0 there will be no change.

Filter 1 EG changes (Time) (AMS = Velocity, Intensity = a positive (+) value)

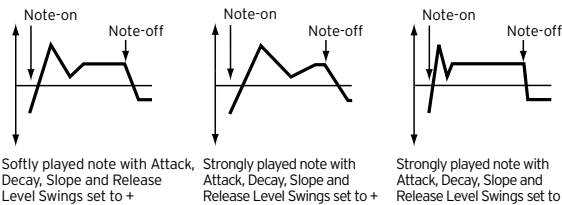

Programming amplitude and pan

You can program the amplitude and pan of each oscillator. Amplitude is the volume of the oscillators. Pan is the position of the oscillators in the stereo panorama. With amplitude envelope you can make the sound volume vary over time.

Setting the basic amplitude and pan values

You can set the basic volume and pan values of the selected oscillator.

- Go to the Sound > Amp > Level/Pan page.

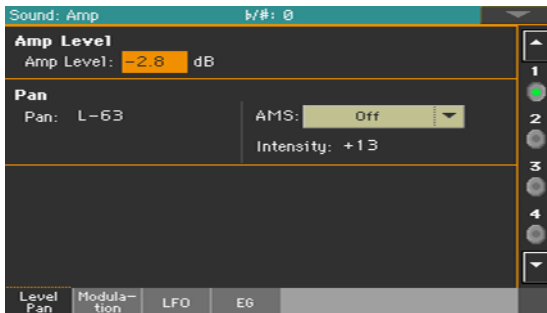

Setting the amplitude's basic level

- Use the Amp Level parameter (0...127) to set the volume of the selected oscillator.

The volume of a Sound can be controlled by CC#7 (Volume) and #11 (Expression). The resulting level is determined by multiplying the values of CC#7 and #11. The Global MIDI channel is used for control.

Setting the pan's basic position

- Use the Pan parameter to set the stereo position (panorama) of the selected oscillator.

This parameter is not available when editing a Drum Kit. Use the individual Pan control for each key instead.

Pan	Meaning
Random	The sound will be heard from a different location at each note-on.
L-63...C00...R+63	Sound placed from Left (L) to Right (R). A value of C00 is Center (C).

The pan of a Sound can be controlled by CC#10 (Pan). A CC#10 value of 0 or 1 will place the sound at the far left, a value of 64 will place the sound at the location specified by the Pan setting for each oscillator, and a value of 127 will place the sound at the far right.

Modulating the pan position

Modulating the pan position makes the sound live between the stereo channels.

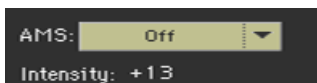

- Use the AMS pop-up menu to choose the modulation source that will modify the pan. This change will be relative to the Pan setting.

The Intensity parameter (-99...+99) specifies the depth of the effect produced by AMS. For example, if Pan is set to C064 and AMS is Note Number, positive (+) values of this parameter will cause the sound to move toward the right as the note numbers increase beyond the C4 note (i.e., as you play higher), and toward the left as the note numbers decrease (i.e., as you play lower). Negative (-) values of this parameter will have the opposite effect.

Modulating amplitude

Modulating the amplitude level of each oscillator makes the sound alive and ever-changing.

- Go to the Sound > Amp > Modulation page.



Tracking the amplitude across the keyboard

Use the Keyboard Track parameters to adjust the volume of the selected oscillator across the keyboard.

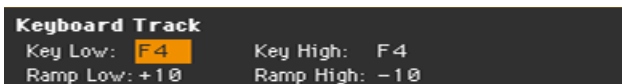

- Use the Key Low/High parameters (C-1...G9) to specify keyboard tracking for the note number at which keyboard tracking will begin to apply. The volume will not change between Key Low and Key High.

Keyboard tracking will apply to the range below the specified Low note number, and above the specified High note number.

- Use the Ramp Low/High parameters to specify the slope of the keyboard tracking (-99...+99).

With positive (+) values of the Ramp Low parameter, the volume will increase as you play notes below the Key Low note number. With negative (-) values, the volume will decrease.

With positive (+) values of the Ramp High parameter, the volume will increase as you play notes above the Key High note number. With negative (-) values, the volume will decrease.

Here is an example of volume changes produced by keyboard location and Ramp settings:

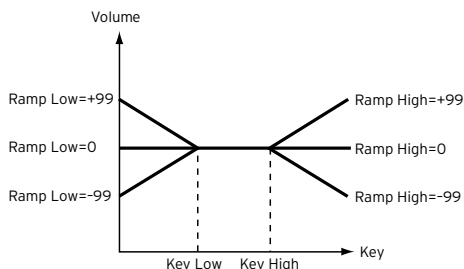

Modulating amplitude

Use the Amp Modulation parameters to specify how the volume of the selected oscillator will be affected by velocity.



- Use the Velocity Intensity parameter (-99...+99) to link velocity and volume.

With positive (+) values, the volume will increase as you play more strongly. With negative (-) values, the volume will decrease as you play more strongly.

Volume change (with positive (+) values of this parameter)

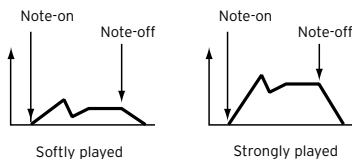

- Use the AMS pop-up to select a modulation source for the volume of the amp for the selected oscillator. Velocity cannot be selected as a source.

The Intensity parameter (-99...+99) specifies the depth and direction of the AMS. The actual volume will be determined by multiplying the value of the changes produced by the amp EG with the values of Alternate Modulation etc., and if the levels of the amp EG are low, the modulation applied by Alternate Modulation will also be less.

For example, if AMS is set to Joystick Y+, positive (+) values of this parameter will cause the volume to increase when you move the Joystick up in the Y

axis. However if the EG settings etc. have already raised the volume to its maximum level, the volume cannot be increased further.

With negative (-) values of this parameter, the volume will decrease when pressure is applied to the keyboard.

Modulating amplitude with the LFOs

LFO is a cyclic modulation. Applied to the amplitude it produces an effect usually called 'tremolo'.

- Go to the Sound > Amp > LFO page.

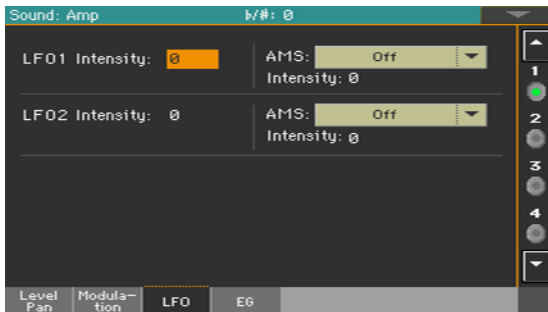

- Use the LFO 1/2 > Intensity parameters (-99...+99) to adjust the effect of the cyclic modulation that LFO 1/2 (set in the LFO > LFO 1 and LFO 2 pages) will apply on the amp EG. Negative (-) settings will invert the phase.

Change in cutoff

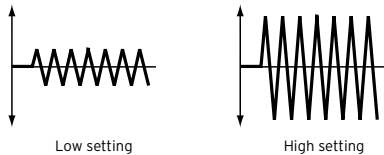

- Use the AMS pop-up to select a modulation source for the LFO Intensity volume of the amp for the selected oscillator.

The Intensity parameter (-99...+99) specifies the depth and direction of the AMS.

Programming the amplitude envelope (Amp EG)

You can create time-varying changes in the volume of the selected oscillator.

- Go to the Sound > Amp > EG page.

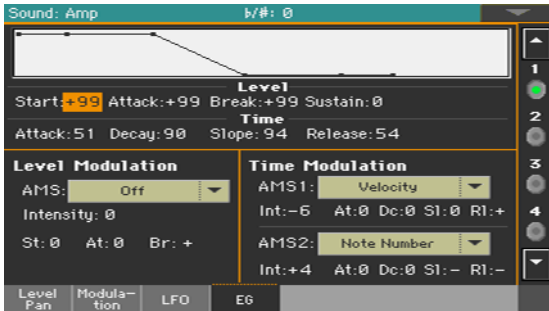

The diagram on top of the page shows the Amplitude envelope line.

Setting the Amp EG levels and times

Amp EG can be programmed by setting the Level and Time parameters of the envelope segments.

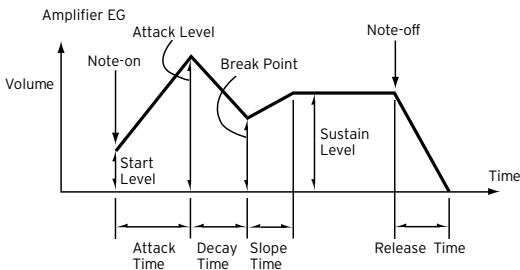

- Use the Level parameters (-99...+99) to specify the volume level that will be reached at the end of the segment.

EG Level	Meaning
Start	Volume level at note-on. If you want the note to begin at a loud level, set this to a high value.
Attack	Volume level that will be reached after the attack time has elapsed.
Break (Break Point)	Volume level that will be reached after the decay time has elapsed.
Sustain	Volume level that will be maintained from after the slope time has elapsed until note-off occur.

- Use the Time parameters (0...99) to specify the time over which the volume level is reached.

EG Time	Meaning
Attack	Time over which the volume will change after note-on until it reaches the attack level. If the start level is 0, this will be the rise time of the sound.
Decay	Time over which the volume will change from when it reaches the attack level until it reaches the break point level.
Slope	Time over which the volume will change from when it reaches the break point level until it reaches the sustain level.
Release	Time over which the volume will change after note-off until it reaches 0.

Modulating the Amp EG

Modulating the Amp EG levels

- Use the Level Modulation > AMS parameter to select a modulation source for the Level parameters of the Amp EG.
- Use the Level Modulation > Intensity parameters (-99...+99) to specify the depth and direction of the AMS.

For example, if the AMS is Velocity, setting St (Start Level Swing), At (Attack Level Swing) and Br (Break Point Level Swing) parameters to + and setting Intensity to a positive (+) value, will cause the amp EG volume levels to increase as you play more strongly. Setting Intensity to a negative (-) values will cause the amp EG volume levels to decrease as you play more strongly. With a setting of 0, the levels will be as specified on Amp > Amp EG.

- Use the St (Start Level Swing), At (Attack Level Swing) and Br (Break Level Swing) parameters to specify the direction in which AMS will affect the Level > Start, Attack and Break Point levels.

When Intensity has a positive (+) value, a setting of + for this parameter will allow the AMS to raise the EG level, and a setting of - will allow AMS to lower the EG level. With a setting of 0 there will be no change.

Amp 1 EG changes (Level) (AMS=Velocity, Intensity = a positive (+) value)

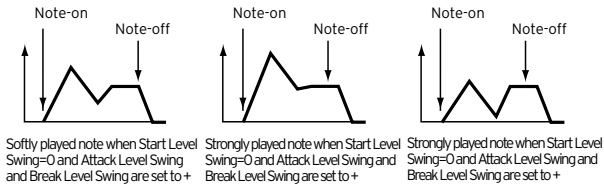

Modulating the Amp EG times

- Use the **Time Modulation > AMS 1/2** parameters to select a modulation source for the Time parameters of the Amp EG.
- Use the **Time Modulation > Intensity** parameters (-99...+99) to specify the depth and direction of the effect that the AMS will have on the Time parameters. With a setting of 0, the Amp EG times will be just as specified by the Time settings.

For example, if the AMS is Amp KTrk +/+, the (Amp) Keyboard Track settings (in the **Edit Sound > Amp > Amp Mod** page) will control the EG Time parameters. With positive (+) values of this parameter, positive (+) values of Ramp (Ramp Setting) will cause EG times to be lengthened, and negative (-) values of Ramp (Ramp Setting) will cause EG times to be shortened. The direction of the change is specified by the At (Attack Time Swing), Dc (Decay Time Swing), Sl (Slope Time Swing), and RI (Release Time) parameters.

If the AMS is set to Velocity, positive (+) values of this parameter will cause EG times to lengthen as you play more strongly, and negative (-) values will cause EG times to shorten as you play more strongly. With a setting of 0, the EG times will be as specified by the Level parameters.

- Use the **At (Attack Time Swing)**, **Dc (Decay Time Swing)**, **Sl (Slope Time Swing)** and **RI (Release Time Swing)** parameters to specify the direction in which the AMS will affect the Time > Attack, Decay, Slope and Release parameters.

With positive (+) values of Intensity, a setting of + will cause the time to be lengthened, and a setting of - will cause the time to be shortened. With a setting of 0 there will be no change.

Amp 1 EG changes (Time)
 (AMS=Amp K Trk +/-, Intensity = a positive (+) value
 (When Amp Keyboard Track "Low Ramp" = a positive (+) value, and
 "High Ramp" = a positive (+) value)

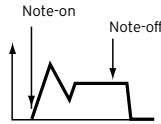
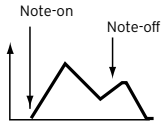
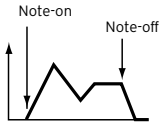

Low-pitched note played with Attack, Decay, Slope, and Release Time Swing at +

High-pitched note played with Attack, Decay, Slope, and Release Time Swing at -

Amp 1 EG changes (Time) (AMS=Velocity, Intensity= a positive (+) value)

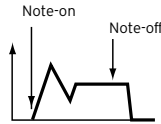
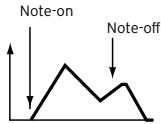
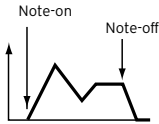

Softly played note with Attack, Decay, Slope and Release Time Swing at +

Strongly played note with Attack, Decay, Slope and Release Time Swing at +

Strongly played note with Attack, Decay, Slope and Release Time Swing at -

Programming the LFO

LFO (Low Frequency Oscillation) can be used to cyclically modulate the Pitch, Filter, and Amp of each oscillator. There are two LFO units for each oscillator (LFO 1 and LFO 2).

- Go to the Sound > LFO > LFO 1 or LFO 2 page, depending on the LFO to program.

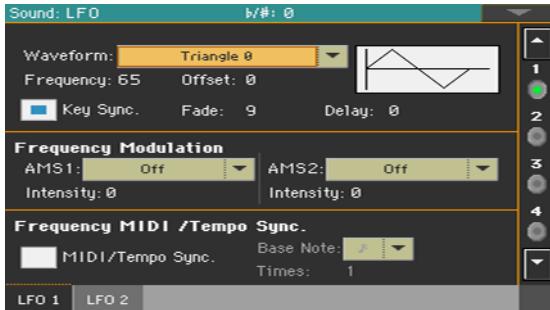

Choosing the LFO waveform and settings

You can choose the LFO waveform, program it and synchronize it.

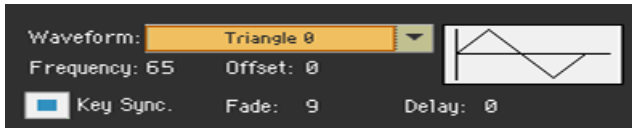

Choosing the LFO waveform and frequency

- Use the **Waveform** parameter to choose the LFO waveform. The numbers appearing on the right of some of the LFO waveforms indicate the phase at which the waveform will begin.

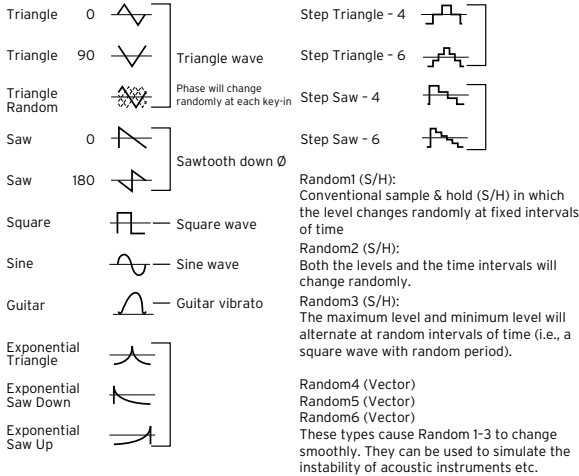

- Use the **Frequency** parameter to set the LFO frequency (00...99). This parameter adjusts the speed of the vibrato.
- Use the **Offset** parameter to specify the central value of the LFO waveform.

For example, with a setting of 0 as shown in the following diagram, the vibrato that is applied will be centered on the note-on pitch. With a setting of +99, the vibrato will only raise the pitch above the note-on pitch, in the way in which vibrato is applied on a guitar.

When the Waveform is Guitar, the modulation will occur only in the positive (+) direction even if you set the Offset to 0.

Here are offset settings and pitch change produced by vibrato:



Synchronizing the LFO with the key strokes

- Select the Key Sync checkbox to synchronize the LFO to the key strokes.

Key Sync	Meaning
On	The LFO will restart each time you play a note, and an independent LFO will operate for each note.
Off	The LFO effect that was started by the first-played note will continue to be applied to each newly-played note. (In this case, Delay and Fade will be applied only to the LFO when it is first started).

Fading the LFO

- Use the Fade parameter (00...99) to specify the time elapsed from the LFO start to its maximum amplitude. When Key Sync is Off, the fade will apply only when the LFO is first started.

Here is how Fade affects the LFO (when Key Sync is On):

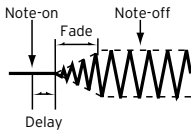

Delaying the LFO

- Use the Delay parameter (0...99) to specify the time elapsed from note-on to the LFO starting to apply. When Key Sync is Off, the delay will apply only when the LFO is first started.

Fading vibrato is typical of wind instruments, where vibrato enters gradually.

Modulating LFO frequency

Use the Frequency Modulation parameters to set the two alternate modulation sources to adjust the speed of the LFO for the selected oscillator.

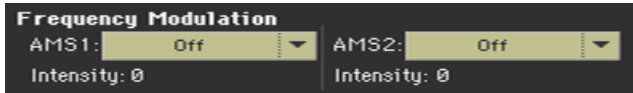

- Use the AMS 1/2 pop-up to choose the modulation sources that will adjust the frequency of the selected oscillator's LFO. LFO 1 can be modulated by LFO 2.
- Use the Intensity parameters (-99...+99) to set the modulation depth and direction.

This parameter specifies the depth and direction of the effect that the AMS will have. When this parameter is set to a value of 16, 33, 49, 66, 82, or 99, the LFO frequency being can be increased by a maximum of 2, 4, 8, 16, 32, or 64 times respectively (or decreased by 1/2, 1/4, 1/8, 1/16, 1/32, or 1/64 respectively).

For example, if the AMS is Note Number, positive (+) values of this parameter will cause the oscillator LFO to speed up as you play higher notes. Negative (-) values will cause the oscillator LFO to slow down as you play higher notes. This change will be centered on the C4 note.

If the AMS is set to JS +Y, raising the value of this parameter will cause the oscillator LFO 1 speed to increase as the joystick is moved away from yourself. With a setting of +99, moving the joystick all the way away from yourself will increase the LFO speed by approximately 64 times.

Synchronizing the LFOs

Use the Frequency MIDI/Tempo Sync parameters to synchronize the LFO to the Player's Tempo.

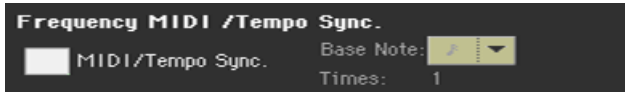

- Select the MIDI/Tempo Sync checkbox to synchronize the LFO to the Player's Tempo. The values specified in Frequency and Frequency Modulation will be ignored.
- Use the Base Note pop-up menu to choose a note length, and the Times parameter to choose a multiple of it. This will be the LFO frequency.

For example if Base Note is  (quarter note) and Times is 04, the LFO will perform one cycle every four beats.

These parameters are not available when editing a Drum Kit.

Adding effects to the Sound

You can send the Sound to the effects of the FX B Group (usually reserved to the Keyboard Sounds).

- Go to the Sound > Effects > FX B page.

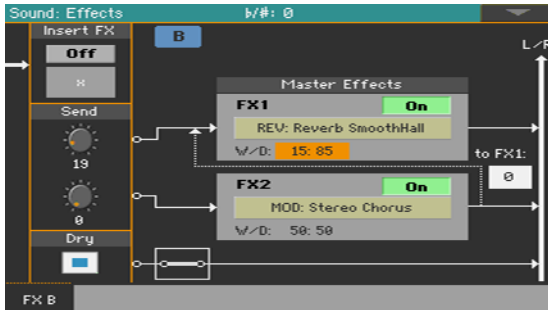

Activating and choosing the insert effects

Each Sound can go into an insert effect processor.

Activate the insert effects

- Use the Insert FX > On/Off button to turn on or off the insert effect.

Choose the insert effect

- 1 Touch the name of the selected effect type, or the 'x' symbol under the On/Off button, to open the FX Edit page.

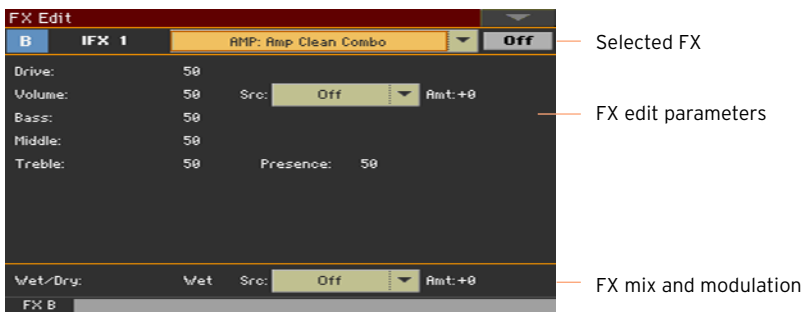

- 2 Use the pop-up menu on top of the page to choose an effect.
- 3 If needed, edit the effect parameters, as described in the part of the manual dedicated to the Effects.

You can adjust the Wet/Dry mix of the insert effects, but we suggest not to touch it, unless you are editing the effects.

- 4 When finished editing, press the EXIT button to return to the previous page.

Activating and choosing the master effects

Each Sound can send its audio signal to two master effects.

Activate the master effects

- Use the Master Effects > On/Off buttons to turn on or off the master effects.

Choose the master effects

- 1 Touch the name of the assigned effects to open the FX Edit page.



- 2 Use the pop-up menu on top of the page to choose an effect.
- 3 If needed, edit the effect parameters, as described in the part of the manual dedicated to the Effects.

You can adjust the Wet/Dry mix of the master effects, but we suggest not to touch it, unless you are editing the effects. To set the amount of effect, use the individual channels' send level instead (as explained below).

- 4 When finished editing, press the EXIT button to return to the previous page.

Setting the effect parameters

All the parameters in this page are the same seen for the Sound sets. Please check the [Customizing and editing the Sound sets](#) section.

- Use the **Send** controls (0...127) to set the level of the Sound signal going to the Master FXs.
- Select the **Dry > On** checkbox to add the dry signal to the effected signal. If this is not selected, only the effected signal will be heard.

Sound Edit utilities

Listening to a single oscillator

- Choose the Solo Oscillator command from the page menu to solo the selected oscillator, and mute the other oscillators.
- Choose it again to unmute all oscillators.

When this function is activated, the Solo OSC [n] indicator (n = oscillator number) blinks on the page header. While in this situation, you can select a different oscillator to be soloed.

Swapping the LFOs

- Choose the Swap LFO command from the page menu to replace LFO 1 with LFO 2, and vice-versa.

Copying the oscillators

You can copy all the settings of an oscillator onto the other oscillators.

- 1 Choose the Copy Oscillator command from the page menu. The Copy Oscillator dialog will appear.

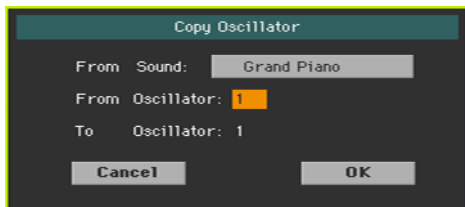

- 2 Touch the From Sound button to open the Sound Select window, and choose the source Sound.
- 3 Use the From Oscillator parameter to choose the source oscillator to copy from.
- 4 Use the To Oscillator parameter to choose the target oscillator where to copy the source settings onto.
- 5 Touch the OK button to confirm.

Copying Drum Kits

You can copy the Drum Kit from a different Drum Kit.

- 1 Choose the **Copy Drum Kit** command from the page menu. The Copy Drum Kit dialog will appear.

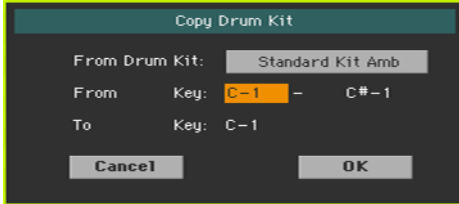

- 2 Touch the **From Drum Kit** button to open the **Sound Select** window, and choose the source Drum Kit.
- 3 Use the **From Key** parameters to choose the range of keys to copy from.
- 4 Use the **To Key** parameter to choose the key from which to start copying.
- 5 Touch the **OK** button to confirm.

Copying the effects

To speed up programming, you can copy a single effect, or both effects, to a different Sound. The procedure is the same explained for the Sound sets.

Initializing a Sound

- Choose the **Initialize Sound** command from the page menu to delete all parameters, and reset them to a default value.

Comparing with the original Sound

You can compare the Sound you are editing with the original Sound.

- Check the **Compare** item in the page menu to listen to the original Sound.
- Uncheck this item to recall the Sound in edit.

While this function is on, the **Compare** indicator blinks on the page header. You cannot edit the Sound while you are in Compare mode.

AMS (Alternate Modulation Sources)

When the AMS abbreviation is encountered, an Alternate Modulation can be applied to the corresponding parameter. Alternate Modulation allows for realtime control of the effect. The following table shows the available modulation sources.

AMS	Description	Note
Off	Do not use Alternate Modulation	
Pitch EG	Pitch EG	
Filter EG	Filter EG within the same oscillator	
Amp EG	Amp EG within the same oscillator	
LFO1	LFO1 within the same oscillator	
LFO2	LFO2 within the same oscillator	
Flt KTrk +/- (Filter Keyboard Track +/-)	Filter keyboard tracking within the same oscillator	<p>+/+ The direction of the effect will be determined by the sign (positive or negative) of the Ramp Low or Ramp High setting.</p> <p>+/- The direction of the effect will be determined by the sign of the Ramp Low setting, and by the opposite sign of the Ramp High setting (50 for a setting of +50, and +50 for a setting of 50).</p>
Flt KTrk +/- (Filter Keyboard Track +/-)		
Flt KTrk O/+ (Filter Keyboard Track O/+)		
Flt KTrk +/-O (Filter Keyboard Track +/-O)		
Amp KTrk +/- (Amp Keyboard Track +/-)	Amp keyboard tracking within the same oscillator	<p>O/+ Ramp Low will have no AMS effect. The sign of the Ramp High setting will determine the direction of its effect.</p> <p>+/O The sign of the Ramp Low setting will determine the direction of its effect. Ramp High will have no AMS effect.</p>
Amp KTrk +/- (Amp Keyboard Track +/-)		
Amp KTrk O/+ (Amp Keyboard Track O/+)		
Amp KTrk +/-O (Amp Keyboard Track +/-O)		
Note Number	Note number	
Velocity	Velocity	
Poly AT (Poly After Touch)	Polyphonic After Touch (received/transmitted via MIDI or contained in Standard MIDI Files)	
Channel AT (Channel After Touch)	After Touch (Channel After Touch)	
Joystick X	Joystick X (horizontal) axis	
Joystick +Y	Joystick +Y (vertical upward) direction (CC#01)	
Joystick Y	Joystick Y (vertical downward) direction (CC#02)	

AMS	Description	Note
JS+Y & AT/2 (Joy Stick +Y & After Touch/2)	Joystick +Y (vertical upward) direction and After Touch	The effect will be controlled by the joystick +Y (vertically upward) and by after touch. In this case, the effect of after touch will be only half of the specified intensity.
JS-Y & AT/2 (Joy Stick Y & After Touch/2)	Joystick Y (vertical downward) direction and After Touch	The effect will be controlled by the joystick Y (vertically downward) and by after touch. In this case, the effect of after touch will be only half of the specified intensity.
Assign. Pedal	Assignable foot pedal (CC#04)	
Ribbon Ctl.	Ribbon controller (CC#16)	
CC#18	CC#18	
CC#17	CC#17	
CC#19	CC#19	
CC#20	CC#20	
CC#21	CC#21	
CC#17 [+]	CC#17 positive values only	
CC#19 [+]	CC#19 positive values only	
CC#20 [+]	CC#20 positive values only	
CC#21 [+]	CC#21 positive values only	
Damper	Damper pedal (CC#64)	
CC#65	Portamento switch (CC#65)	
Sostenuto	Sostenuto pedal (CC#66)	
CC#80	Sound Controller 1 (CC#80)	
CC#81	Sound Controller 2 (CC#81)	
CC#82	General Purpose #7 (CC#82)	
CC#83	General Purpose #8 (CC#83)	
Tempo	Tempo value from Player 1 or external MIDI clock	
Velocity Plus	Key On and Key Off Velocity are used	
Velocity Exp	Velocity with Exponential curve (higher velocity notes are even louder)	
Velocity Log	Velocity with Logarithmic curve (higher velocity notes are weaker than with the linear Velocity)	

Diagrams of the AmpKTrk sources follow.

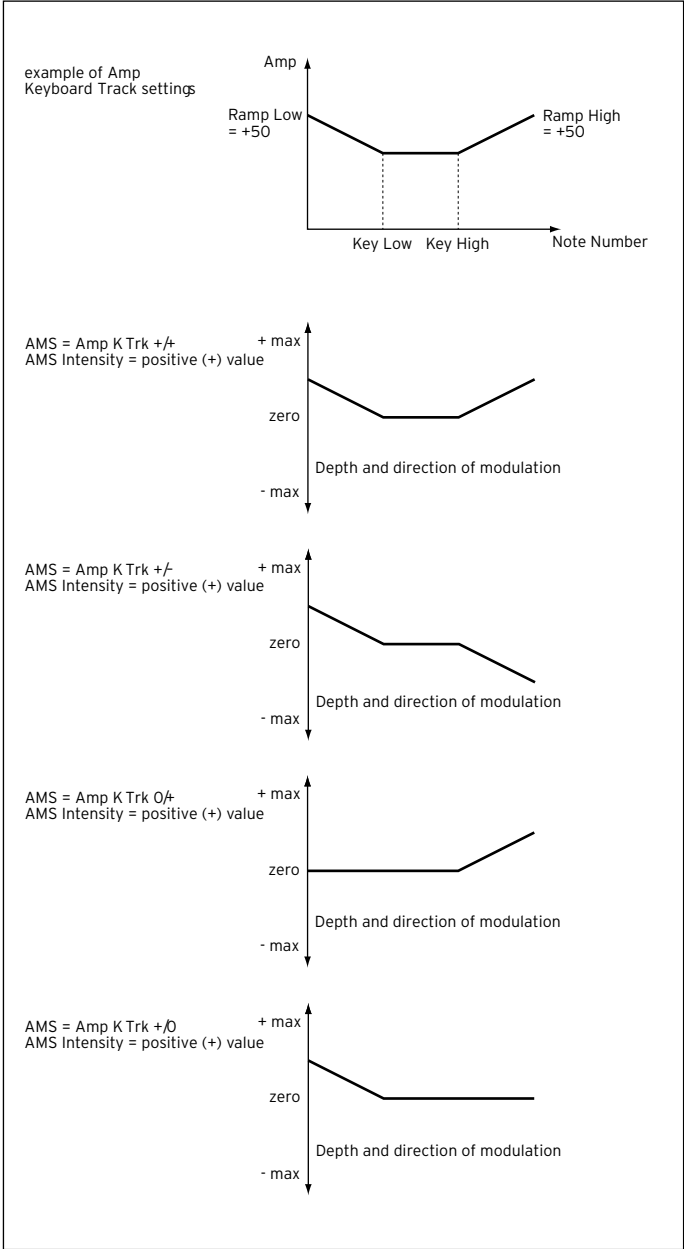

36 Writing the Sounds

Writing the edited Sound

After editing, you can save all the edited parameters into a User Sound location in memory.

Note: Changes can only be saved onto User Sounds.

- 1 While in Sound Edit mode, choose the Write Sound command from the page menu to open the Write Sound dialog.

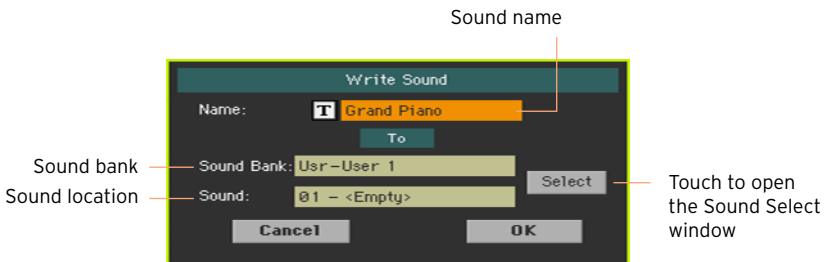

- 2 You may change the name of the Sound. Touch the Text Edit (**T**) icon to open the virtual keyboard and edit the name.

When done editing the name, confirm by touching the OK button under the virtual keyboard.

- 3 When back to the Write Sound dialog, if you want to save onto a different location touch the Select button and open the Sound Select window. Choose a location as if you were choosing a Sound. Blank locations are shown as a series of dashes ('---').
- 4 When back at the Write Sound dialog, confirm the Write operation by touching the OK button.

Some notes about writing the Sounds

- If you write over an existing Sound, the existing Sound will be deleted. Please save on a storage device any User Sound you don't want to lose.
- Ordinary Sounds cannot be written over Drum Kit locations. Drum Kits cannot be written over standard Sound locations.

- To save over a Factory Sound location, deselect the **Protect > Factory** checkbox in the **Global > Mode Preferences > Media** page.

When replacing a Factory Sound, please be warned that all Keyboard Sets, Styles and Songs making use of it will be modified as well. Use this feature with great care!

- To restore the original data, please use the **Factory Restore** command in the **Media > Utility** page.

37 Making new sounds with Sampling

Creating new Sounds or Audio Grooves

Pa4X includes a full-featured sampler, that allows you to create new Samples, new Multisamples and new synced Audio Grooves. In addition to recording, you can load Samples, Multisamples, Sounds and banks of Sounds from various formats.

Creating new ordinary or percussive Sounds

Sampling allows you to create new sounds, by recording from an external source (for example, a microphone or a CD player) connected to Pa4X's audio inputs, or by loading files from a storage device.

To be used, Samples must then be assigned to a Multisample or a Drum Kit. A Multisample allows you to arrange samples into separate zones of the keyboard. Drum Kits allows you to assign a different sample to each note of the keyboard, with up to six dynamic layers per note.

Multisamples can then be assigned to Sounds. Sounds created with this function can be used as any ordinary Sound, and assigned to any part/track.

Creating Audio Grooves

Another powerful feature of the Sampling mode is the Time Slice, that lets you add realism to MIDI tracks by creating Audio Grooves. Cycling rhythm samples, usually named 'audio grooves', can be 'sliced' into separate percussive instruments. Combined with MIDI tracks, the 'sliced' audio groove can be kept in sync with the Tempo, and can play slower or faster than the original groove.

Accessing and exiting the Sampling mode

- While in **Sound mode**, press the **RECORD** button to enter **Sampling mode**. Please note that no sound will be heard when you first enter **Sampling mode**.
- While in **Sampling mode**, choose the **Exit from Record** command from the page menu, or press the **RECORD** button to exit **Sampling mode**.

Loading samples and multisamples

Loading samples

You can load samples in the following formats.

Sample format	Meaning
KSF	KORG's native sample format, used by the Trinity and Triton series of workstations, as well as the Pa-Series arrangers. File names must have the .ksf extension.
AIFF	Apple Mac's preferred format for audio. File names must have the .aif extension.
WAVE	Microsoft Windows preferred format for audio. File names must have the .wav extension.

You can load samples (mono or stereo) in a 8 or 16-bit resolution, and a sampling frequency rate from 11,025 to 48,000Hz. Loaded samples always preserve their original resolution.

If the sample exceeds the maximum size allowed (1,048,576 samples, corresponding to 1 Megasample, either mono or stereo), it will be truncated. A warning will appear in the display.

Please be aware that, by loading new samples, the sample currently in edit will be lost if not saved. Before loading, use the *Write* command to save the sample in edit, if not yet saved.

As an alternative to loading individual samples, you can import sounds or multisamples and their assigned samples, as described later in this chapter.

- 1 While in the *Sample > Edit* page, choose the *Load Sample* command from the page menu, to open the *Load Sample* window.



While in this window, you can press the **SEARCH** button, and use the Search function to find samples in the various media.

- 2 Browse through the files, then select the sample to load, and touch the **Load** button.
- 3 After loading a sample, you can edit it in the other pages of the **Sample** section, then add it to a multisample. If it is an Audio Groove, continue editing it with the **Time Slice** function.

Loading compressed User Samples

Pa4X can read and play compressed User Samples (in Pa4X or Pa3X format). Load compressed User Samples exactly as you load the other samples.

Loading or recording other samples

To create an ordinary Sound, you need more samples to make a multisample. Load other samples, or record them (as described later).

Importing samples, multisamples and Sounds

You can import Sounds and multisamples (including the contained samples) in formats other than the native Pa-Series format.

You can import the following file formats.

File format	Meaning
PCG	KORG's native Program format, used by the Triton series of workstations. The file name has the .pcg extension. Note that Drum Kits cannot be imported.
KMP	KORG's native multisample format, used by the Trinity and Triton series of workstations. The file name has the .kmp extension.
SF2	Sound bank format by Creative Labs. The file name has the .sf2 extension. Multisample data are imported. Due to the deep differences with KORG's own format, some Instruments from the SF2 file could not be imported (for example, Instruments with overlapping zones).

- 1 While in any of the **Sample** or **Multisample** pages, choose the **Import** command from the page menu, to open the **Load Sample** window.

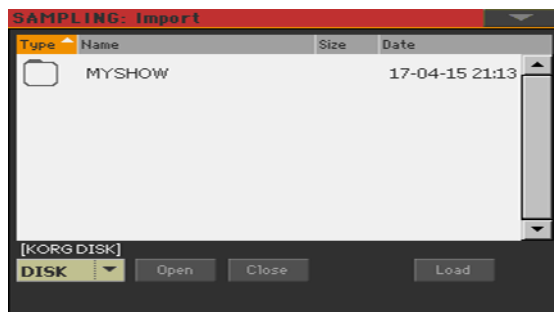

While in this window, you can press the **SEARCH** button, and use the Search function to find files in the various media.

- 2 Browse through the files, then select the one to load, and touch the **Load** button.

Imported Sounds, multisamples and sample are automatically stored in the internal memory, and will not be lost when turning the instrument off.

When importing a multisample, take note of its name; you will need it in Sound mode, when assigning the multisample to a new Sound.

Importing PCG files

When importing a PCG file, you can choose between a single Program or a whole bank:

- Choose **Program** to choose a single Program (corresponding to a Pa-Series Sound); touch the Program number and dial in the corresponding number. Choose a target Sound location where to load the imported Program.
- Choose **Bank** to import all the Programs from the selected bank. Touch the Sound Bank name to choose a target bank where to load the imported Programs.

Due to the differences between Pa4X and the older KORG instruments, some differences may arise during conversion. When reading a PCG file, Pa4X tries to use exactly the same multisamples as in Triton. If this is not possible, it looks for a similar multisample. If this is also not possible, an <empty> multisample will be selected. Go to the Sound mode, and select a multisample suitable for the imported Program.

Not all Triton's PCG data are imported. Insert FX, EQ, Arpeggio, Combi, Global and Drum Kit data are not loaded.

Importing SF2 files

When importing an SF2 file, you can choose between a single multisample or the whole bank:

- Choose **MultiSample** to choose a single Multisample (that is, SF2 Instruments); touch the multisample number and dial in the corresponding number.
- Choose **Complete bank** to import all the multisamples from the selected bank.

Check **Override Sample Names** if you want to assign the sample names a progressive number. In this case, when importing a multisample whose name is, for example, 'Piano', you will have all samples renamed as 'Piano_001', 'Piano_002', and so on.

Freeing memory

If you get a messages warning there isn't enough memory to load all samples or resources, return to the main Sampling page and choose the **Delete** command from the page menu to clean the sample memory, then retry. Please note that importing single multisamples is the safest way to avoid filling the memory with unnecessary data.

As an alternative, you can compress some or all the samples in memory, as described later in this chapter.

Recording samples or audio grooves

Connecting the sources and setting the levels

Before starting to record, prepare the sources to be sampled.

Connecting the source and accessing Sampling

- 1 With its MASTER VOLUME control set to zero, connect the source to be sampled (for example, a microphone or a CD player) to the relevant audio input(s) on the rear of the instrument. When the source has been connected, move the MASTER VOLUME control to a position other than zero.
- 2 Go to the **Global > Audio & Video > Audio In** page to set the signal routing for the input source, and turn the phantom power on in case a condenser microphone has been connected.
- 3 Press the **SOUND** button to access Sound mode, then press the **RECORD** button to access Sampling mode.
- 4 Go to the **Sample > Record** page.

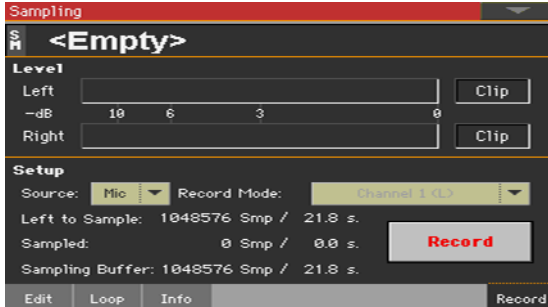

Enabling the source and adjusting the levels

- 1 Use the Source pop-up menu to choose the input source.
- 2 If you are recording from the line inputs, use the Record Mode pop-up menu to choose one or both stereo channels.
- 3 Adjust the source's volume. If you are recording with a microphone, use the **MIC > GAIN** knob of the back of the instrument. If you are sampling from a line source (like a CD player or another instrument), set the source's own output level. If possible, set the output level of the source to be sampled to the maximum.

Watch at the meters in the display to check the input level. Red means near distortion (signal clipping), so ideally, the meter bar should never go to red. When the **Clip** indicators turn red, the signal is too hot and is distorting.

Also, check the microphone level with the **AUDIO IN** indicator in the **MIC/VOICE** section on the control panel. It should never go to red, and stay to orange (green means too low an input signal).

Recording

Next, you'll record the sound or audio groove.

- 1 If you can, first start the source to be recorded, then touch the **Record** button in the display to start recording.

As an alternative, touch the **Record** button in the display, and immediately start the source to be recorded.

Sampling will happen at 16 bit, 48 kHz.

- 2 Touch the **Record** button in the display again to stop recording. When the memory is full, the sampling automatically stops. A maximum of 21.8 seconds is allowed for each sample.
- 3 Select a page other than **Record**, and play the keyboard to listen to the sampled sound.
- 4 If you are not satisfied with the recorded sound, return to the **Record** page and touch the **Record** button again, to repeat recording. Touch **Record** again to stop recording. A new sample will be automatically created.
- 5 When finished sampling your sound, you can write it to the internal memory. If it is part of an ordinary **Sound**, write it and add it to a multisample (as described later). If it is an **Audio Groove**, continue editing it with the **Time Slice** function.

Recording more samples

To create an ordinary **Sound**, you need more samples to make a multisample. The best strategy is to record samples at a fixed distance, for example at each octave, diminished fifth, minor third, major second. It is common practice to record the original note of an acoustic instrument near the highest note of the range (for example, A4 if the range is C4~C5).

- 1 Repeat the recording procedure to create other samples.
- 2 Save the samples.
- 3 When finished, go on creating a multisample.

Editing the samples

After recording, loading or importing, you can edit the samples.

- Go to the Sampling > Edit page.

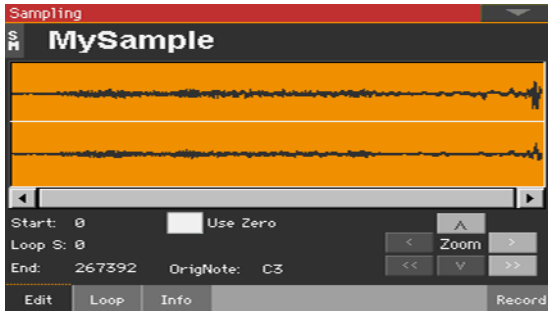

This page allows you to cut, trim or normalize a sample, as well as edit the loop points. The sample can be played over the full keyboard.

Choosing the sample to edit

- 1 Touch the name of the sample on top of the page to open the Sample Select window.

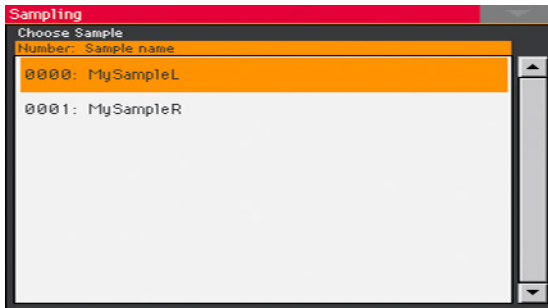

- 2 Touch the name of a sample to select it.

Reading the sample waveform diagram

The diagram shows the sample's waveform evolving during time (x-axis), and its changing amplitude (y-axis). It also shows the Start, End and Loop points. The area included between the Start and End points appears highlighted.

Use the **Zoom** controls to change the size of the waveform shown in the diagram. When a button is greyed-out, it means the maximum or minimum value has been reached.

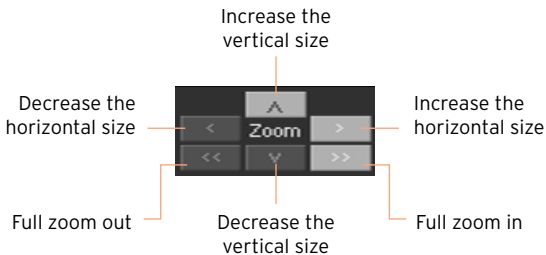

Changing the sample length

When recording, you may have included exceeding materials at the beginning and/or ending of the sample. You can cut them out of the sample.

- Use the **Start** parameter to edit the sample's start point (in samples). Match the start point with the actual attack of the sound you can see in the diagram.

If the Start point reaches the Loop Start point, this latter is also moved forward.

- Use the **End** parameter to edit the sample and loop end point (in samples). Match this point to the actual end of the sound you can see in the diagram.

When writing the edited sample, the segments exceeding the Start and End points will be permanently removed.

Changing the loop start

The loop is the cycling segment at the end of a sample, allowing for playing long notes while still using short recordings.

- Be sure the **Loop On** checkbox is selected in the **Sampling > Loop** page. Otherwise, moving the loop start point will have no effect.
- When back to the **Sampling > Edit** page, use the **Loop Start** parameter to adjust the Loop Start point. When you adjust this parameter, an audible click may appear, due to a pitch and/or level mismatch between the starting and ending points of the loop. Move the Loop Start and Loop/Sample End point, so that the click can no longer be heard.

When editing audio grooves, the Loop Start should match the Sample Start point. This parameter usually differs from the Sample Start in ordinary sounds (that is, a guitar, a piano, a voice...).

Forcing the use of 'zero' points

When the Use Zero checkbox is selected, the Start, Loop Start and End points always fall on the nearest zero-crossing point (that is, a point where the waveform crosses the x-axis, and goes from negative to positive, or from positive to negative values). This will make loops more accurate, and will reduce the risk of clicks.

Choosing the original note

- Use the OrigNote (Original Note) parameter to choose the sample's original pitch.

While this parameter has no immediate effect on the sound, it will be useful to identify the original pitch of the sample and when assigning a sample to the multisample.

For example, if you sample a C4, set this parameter to 'C4'. When the sample will be assigned to a keyboard zone of the multisample, it will be transposed (if needed) according to this parameter, to avoid a change of the original pitch.

Normalizing the sample

Normalization automatically rescales the level of the selected sample. Peaks will be raised to -0dB (that is, maximum volume before clipping), while the remaining parts of the sample will be proportionally raised.

This helps optimizing the sample's level relative to other samples, making all samples sound more uniformly. It also helps optimizing signal/noise ratio, by preventing further stages of amplification from increasing any residual noise.

- While in any Sample editing page, choose the Normalize command from the page menu.

Cutting away part of the sample

You can cut away the selected part of the sample.

- 1 While in the Edit page, use the Start and End points to choose the segment to cut away.
- 2 Choose the Cut command from the page menu.

Cutting away the unused parts of the sample (trimming/cropping)

You can cut away the non-selected parts of the sample.

- 1 While in the Edit page, use the Start and End points to choose the segment to preserve.
- 2 Choose the Trim/Crop command from the page menu.

Editing the loop

After editing the sample, you can fine-tune the loop.

- Go to the Sampling > Loop page.

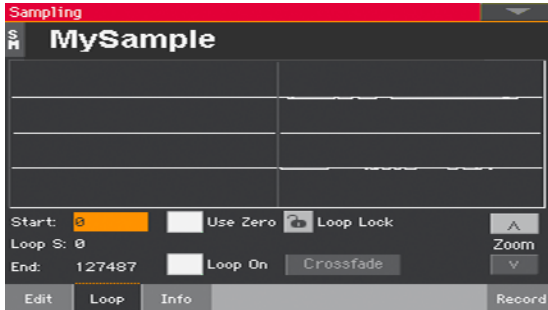

The loop is a cycling portion of a sampled sound. Looping is a technique used to reduce the sampling time, cycling a portion of the sound to create the sustaining phase of the sound. After the attack stage, most sounds repeat the same waveform during their sustain stage.

Reading the loop diagram

The diagram lets you fine tune the loop points, by watching at the Loop End (left half of the diagram) and Loop Start (right half of the diagram) points matching at the center of the diagram. A good-sounding loop is shown as a continuous, nonbreaking line.

Use the Zoom controls to change the size of the looping ends shown in the diagram. When a button is greyed-out, it means the maximum or minimum value has been reached.



Changing the loop points

- Be sure the Loop On checkbox is selected.
- Use the Loop Start parameter to adjust the Loop Start point.
- Use the End parameter to adjust the Loop End point (always matching the Sample End point).

Protecting the loop length

- Use the **Loop Lock** to fix the length of the loop being edited. When it is closed, moving the **Loop Start** automatically moves the **Loop/Sample End** point, or vice versa.

This is convenient when you are creating a rhythm loop to match a specific tempo.

Using crossfade looping

When looping the pitched sample of a complex sound such as strings or woodwinds to make the sound sustain, it is necessary to create a long loop to preserve the rich character of the sound. **Crossfade Loop** can be used to minimize the difference in pitch and level between the beginning and ending of the loop region, to create a natural-sounding loop. In order to solve such problems, **Crossfade Loop** causes the sound to change gradually from the end to the beginning of the loop.

In practice, here is how it works. A specific length (the **Crossfade Length** value) of the waveform immediately before the beginning of the loop is taken and mixed with the end portion. At this time, the waveform level of the portion immediately before the end (the length specified by **Crossfade Length**) will gradually decrease, and the waveform level immediately before the beginning of the loop will gradually increase as the two are mixed.

When the **Loop On** checkbox is selected, and the **Start** and **Loop S(tart)** parameters have different values, the **Crossfade** button becomes available.

- 1 Touch the **Crossfade** button to open the **Crossfade Loop** dialog:

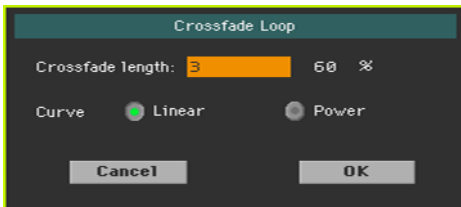

- 2 Use the **Crossfade Length** parameter to specify the length of the sample that you wish to crossfade. You can enter it either as the number of samples, or a percentage (%). If you set this as a percentage, the number of samples will be calculated automatically.

If you set this to 50%, crossfade will be performed on the second half of the region between loop start and loop end.

The **Crossfade Length** cannot be greater than the smaller length between the **Sample Start - Loop Start** points, or the **Loop Start - Sample End** points.

- 3 Use the **Curve** radio buttons to specify how the volume will change in the crossfaded region.

Curve	Meaning
Linear	The volume will change linearly.
Power	The volume will change non-linearly. Sometimes a setting of Linear will produce the impression that the volume has dropped in the middle of the crossfade curve. In such cases, use Power.

Getting information on the Sampling memory

In case you receive a message warning about not enough Sampling memory available, you can check what is filling it up. You will then be able to delete some data or compress the samples.

- Go to the Sampling > Info page.

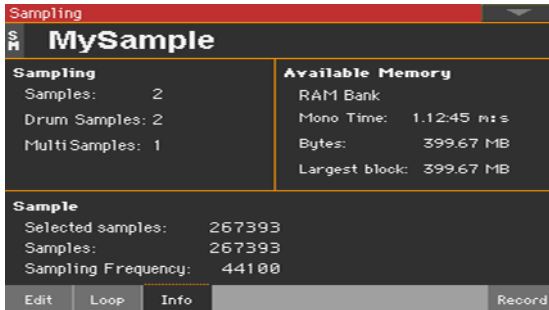

- Use the Sampling area to get information on the number of samples, drum samples and multisamples in the Sampling memory.

Parameter	Meaning
Samples	Number of samples in memory.
Drum Samples	Number of drum samples in memory.
MultiSamples	Number of multisamples in memory.

- Use the Available Memory area to get information on the Sampling memory (RAM) itself. Pa4X comes with 400 MB of RAM. This is the maximum amount of non-compressed samples that can be loaded or recorded. In case you need more Sampling memory, you can compress the samples and then load up to 800 MB of samples.

Parameter	Meaning
Mono Time	Remaining memory in seconds. This value is given for mono samples. With stereo samples, this time has to be halved.
Bytes	Remaining memory in Bytes. This value is given for mono samples. With stereo samples, this time has to be halved.
Largest block	Largest contiguous block of memory. This is the maximum size of a sample you can write to memory. Each time you turn the instrument on, this block is extended to match the Bytes parameter. In case you cannot save a sample, please export it, then import it after having restarted the instrument.

- Use the **Sample** area to get information on the selected sample and all the samples in memory.

Parameter	Meaning
Selected samples	Size of the selected sample (in samples).
Samples	Total size of the samples in memory (in samples).
Sampling frequency	Sampling frequency of the selected sample (in Hertz).

Writing, exporting or deleting the samples

Writing the sample

If you are creating an ordinary Sound or Drum Kit, write the sample to the internal memory.

- 1 While in any page of Sample editing section, choose the Write command from the page menu to open the Write Sample dialog.

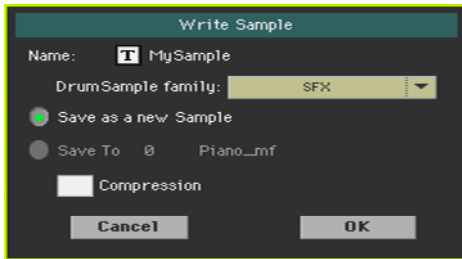

- 2 You may change the name of the sample. Touch the Text Edit (**T**) icon to open the virtual keyboard and edit the name.

When done editing the name, confirm by touching the OK button under the virtual keyboard.

- 3 If you are saving a percussive sample, use the Drum Sample family pop-up menu to choose a Drum Sample family.
- 4 Select an option to choose a location where to save the sample:
 - Choose Save as a new Sample to save to a new location.
 - Select Save to to overwrite an existing location. In this case, the existing sample will be deleted.
- 5 If you want to compress the sample, select the Compression checkbox. (Compression is explained later in this chapter).
- 6 Confirm the Write operation by touching the OK button.

Pa4X comes with 400 MB of RAM. This is the maximum amount of non-compressed samples that can be loaded or recorded. In case you need more Sampling memory, you can compress the samples and then load up to 800 MB of samples.

Exporting samples

You can export the sample in edit in one of two popular computer audio file formats (WAVE and AIFF).

- 1 While in any page of the **Sample** section, choose the **Export** command from the page menu, to open the **Export Sample** window.
- 2 Choose a target location, then touch the **Save** button to make the **Export Sample** dialog appear:



- 3 You may change the name of the sample. Touch the **Text Edit** (**T**) icon to open the virtual keyboard and edit the name.
When done editing the name, confirm by touching the **OK** button under the virtual keyboard.
- 4 When back to the **Export Multisample** dialog, use the **File Type** pop-up menu to choose the export format.
- 5 Confirm saving by touching the **OK** button.

Deleting samples

You can delete a sample, all the unused samples, or all the samples.

Accessing the Delete Sample dialog

- While in any page of Sample editing section, choose the Delete command from the page menu to open the Delete Sample dialog.



Deleting a sample

- Select the Selected option, choose the sample to be deleted, and touch OK to confirm.

Deleting all the unassigned samples

- Select the Not assigned to any Multisample/Drumkit option, and touch OK to confirm.

This command deletes only samples not yet assigned to any Multisample or Drum Kit. Use this option with care, since you may delete samples you would like to preserve, but have not yet been assigned.

Deleting all the samples, multisamples and drum samples

- Select the All Samples, Multisamples, Drum Samples option, and touch OK to confirm.

Select this command to delete all samples, multisamples and drum samples from the RAM memory. This operation completely resets the RAM, and may be used to clean-up any trouble with memory management.

Compressing the User Samples

Pa4X can read and play compressed User Samples. It can compress User Samples when saving them, or in batch. Sample compression allows for doubling the available Sampling memory.

Compressed samples can no longer be decompressed. If you want to keep the original samples, please save a copy before compressing them.

Compressing User Samples when writing them

You can compress a User Sample while writing it to the internal memory.

- 1 While in any page of **Sample editing** section, choose the **Write** command from the **page menu** to open the **Write Sample** dialog.

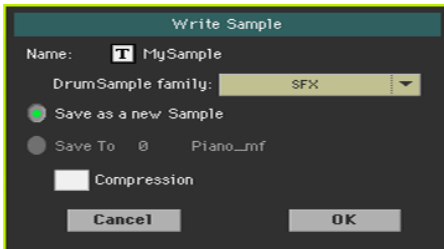

- 2 While in this dialog, select the **Compression** checkbox, to reduce the size of the sample up to a half of its original size. Please note that compression may require a long time.

Compressed samples will have an asterisk (*) added to their name.

Compressing all User Samples in memory

You can compress all the User Samples contained in the Sampling memory.

- 1 While in any page of **Sample editing** section, choose the **Compress all samples** command from the **page menu** to run compression.
- 2 A message appears, warning about the long times needed to compress all the samples. Touch **OK** to confirm.

Please do not turn the instrument off while compression is going on.

When finished, compressed samples will appear with an asterisk (*) added to their name.

Creating multisamples

After having recorded, loaded or imported all the needed samples, you can create a multisample. The multisample is a way of organizing several samples on the keyboard. Each sample is assigned to a Keyboard Zone (or Index), with a higher and a lower limit. Later, the multisample will be assigned to an oscillator in an ordinary Sound.

- Go to the Sampling > Multisample > Edit page.

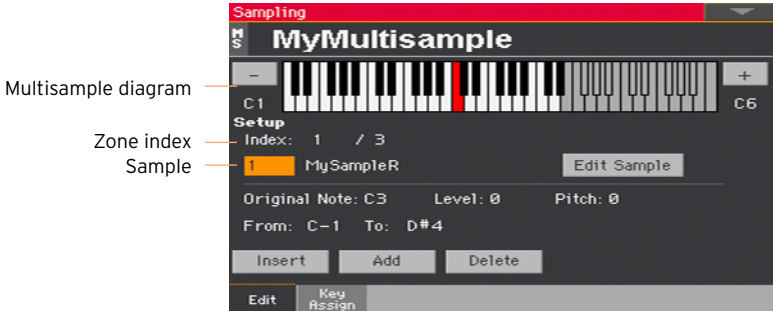

In this page you will assign the sample(s) to a multisample. Assign each sample to a different keyboard zone.

Choosing the multisample to edit

- 1 Touch the name of the multisample on top of the page to open the Multisample Select window.

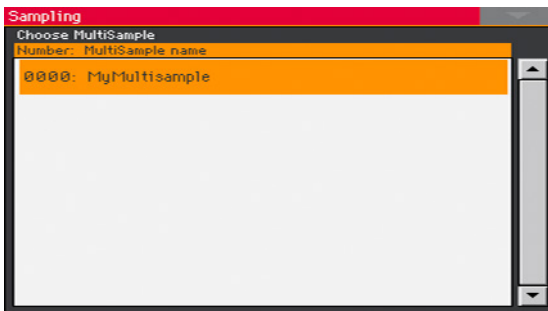

- 2 Touch the name of a multisample to select it.

Reading the multisample diagram

The keyboard diagram shows the selected Index/Zone (highlighted), and its Original Note (in red). Use the big '-' and '+' buttons on its side to scroll the diagram one octave lower or upper.

Assigning samples to the keyboard

Creating a new zone

By default, a new multisample contains a single zone.

- Touch the Insert button to split the current zone in half, and create a new zone (Index) on the left of the selected one.
- Touch the Add button to add a new zone (Index) after the last one.

Deleting a zone

You can delete zones, when no longer needed.

- Touch the Delete button to delete the selected zone (Index). The zone on the right of the deleted one is automatically extended to fill the gap.

Selecting a zone

- Play a note on the keyboard to select the corresponding zone (Index).

As an alternative, use the Index parameter to choose the corresponding zone.

The total number of zones in the multisample is shown by the second number of the Index parameter.

Adjusting the zone range

- Use the From ... To pair of parameters to adjust the range of the selected zone (Index).

The minimum size is one key. When reducing the range of a zone, the adjacent one is automatically increased to fill the gap.

Assigning a sample to the selected zone

A zone always corresponds to a single sample.

- Use the **Sample** parameter to choose a sample.

To create a silent zone, create it and assign no sample to it.

Editing the selected sample

- Touch the **Edit Sample** button to go to the **Sampling > Sample > Edit** page with the selected sample.

Setting the zone parameters

- Use the **Original Note** parameter to automatically transpose the assigned sample on the keyboard. When you play this note, the sample will sound exactly as it was recorded.

By default, this parameter will match the **OrigNote (Original Note)** value assigned when editing the sample in the **Sampling > Sample > Edit** page.

The note set with this parameter appears highlighted in the keyboard diagram.

- Use the **Level** parameter to adjust the relative level of the selected zone. This value can only be a negative offset to the overall volume of the multisample.
- Use the **Pitch** parameter to fine tune the selected sample in cents (1 cent = 1/100 of a semitone).

Overview of the assigned samples and zones

You can see the overall map of the samples assigned to the zones, and edit their range on the keyboard.

- Go to the Sampling > Multisample > Key Assign page.

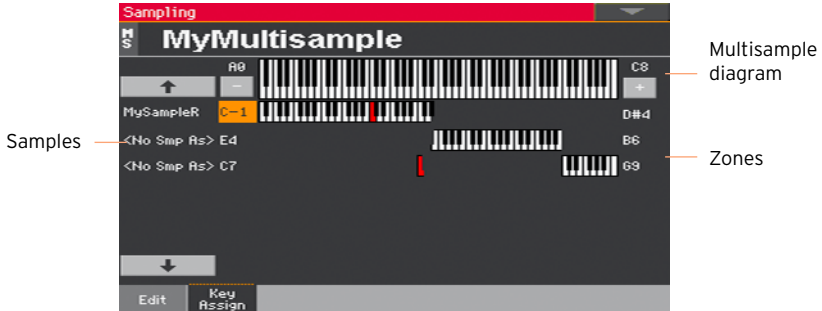

- Scroll the zones by using the list of samples on the left of the page. Use the big button with an arrow on top and to the bottom of the list to scroll the list up or down.
- Edit the zone range, when needed, by using the low and high zone limits appearing on the left and the right of the keyboard diagrams. The Original Note is shown in red.

Writing, exporting or deleting the multisamples

Writing the multisample

Before creating a Sound, save the multisample organizing the samples on the keyboard to the internal memory.

- 1 While in any page of Multisample editing section, choose the Write command from the page menu to open the Write Multisample dialog.

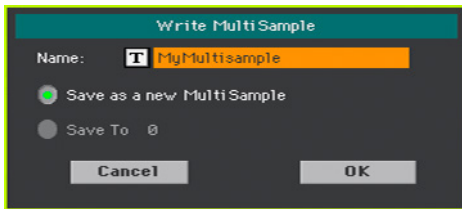

- 2 You may change the name of the multisample. Touch the Text Edit (**T**) icon to open the virtual keyboard and edit the name.

When done editing the name, confirm by touching the OK button under the virtual keyboard.

- 3 Select an option to choose a location where to save the multisample:
 - Choose **Save as a new Multisample** to save to a new location.
 - Select **Save to** to overwrite an existing location. In this case, the existing multisample will be deleted.
- 4 Confirm the Write operation by touching the OK button.

Exporting multisamples

You can export the multisample in edit, together with all the linked samples. The Export operation generates a KMP file (KORG's proprietary file format for multisamples), and a folder containing a series of KSF files (KORG's proprietary file format for samples) inside the same directory.

When exporting a stereo multisample, assign a different name to the Left and Right channel files, to avoid overwriting them. A '-L' and '-R' suffix is usually added after the name of this kind of files.

- 1 While in any page of the Multisample section, choose the Export command from the page menu, to open the Export Multisample window.

- 2 Choose a target location, then touch the Save button to make the Export MultiSample dialog appear:

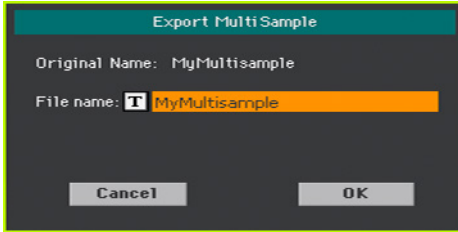

- 3 You may change the name of the multisample. Touch the Text Edit (**T**) icon to open the virtual keyboard and edit the name.

When done editing the name, confirm by touching the OK button under the virtual keyboard.

- 4 When back to the Export Multisample dialog, confirm saving by touching the OK button.

Deleting multisamples

You can delete a multisample, the samples left unused after deleting the multisample, all the multisamples, or all the samples and multisamples.

Accessing the Delete Multisample dialog

- While in any page of Multisample editing section, choose the Delete command from the page menu to open the Delete Multisample dialog.

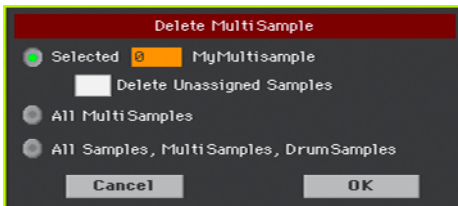

Deleting a multisample

- Select the Selected option, choose the multisample to be deleted, and touch OK to confirm.
- Select the Delete Unassigned Samples checkbox to also delete all the samples left free after deleting the multisample, and not used by other multisamples.

Use this option with care, since you may delete samples you would like to preserve, to be later used in new multisamples still to be created.

Deleting all the multisamples

- Select the All Multisamples option, and touch OK to confirm.

Deleting all the samples, multisamples and drum samples

- Select the All Samples, Multisamples, Drum Samples option, and touch OK to confirm.

Select this command to delete all samples, multisamples and drum samples from the RAM memory. This operation completely resets the RAM, and may be used to clean-up any trouble with memory management.

Creating new Sounds from multisamples

You can create a new Sound while in Sound mode.

- 1 Go to the Sound mode.
- 2 Choose a Sound similar to the one you are going to create.
If you prefer to start from a blank, default situation, choose the **Initialize Sound** command from the page menu.
- 3 Go to the **Sound > Basic > OSC** page.
- 4 Select one of the available **oscillators** from the radio buttons on the right side of the page.
- 5 Use the parameters in the **OSC Multisample** section to assign the multisample to the **High** or **Low** layer of the selected oscillator. Your new multisample can be found in the **RAM** bank of multisamples.
- 6 Go on editing the Sound, as shown in the pages dedicated to Sound editing.

Creating new Drum Kits from percussive samples

You can create a new Drum Kit while in Sound mode.

- 1 Go to the Sound mode.
- 2 Choose a Drum Kit similar to the one you are going to create.
If you prefer to start from a blank, default situation, choose the Initialize Sound command from the page menu.
- 3 Go to the Sound > DrumKit > DrumKit page.
- 4 Use the KEY parameter to select a key. As an alternative, select it by pressing a key on the keyboard.
- 5 Select one of the available layers from the radio buttons under the keyboard diagram.
- 6 Use the parameters in the Drum Sample section to assign a sample to the current layer or the selected oscillator. Your new sample can be found in the RAM bank of samples.
- 7 Go on editing the Drum Kit, as shown in the pages dedicated to Sound editing.

Assigning the new Sound or Drum Kit to a part/track

The new Sounds or Drum Kits are contained in the User banks. Assign them to the Keyboard, Accompaniment or Song tracks, as you would do with any other Sound or Drum Kit. Drum Kits are better suited for the Drum or Percussion track.

When done, save the Sound set (Keyboard Set, SongBook Entry, Style Settings, MIDI Song) to preserve your editing.

Creating Audio Groove Slices with Time Slicing

Creating separate samples from a sliced audio groove

After recording or loading an audio groove, you must 'slice' it to create a series of separate percussive samples, a multisample to organize them on the keyboard, and a MIDI Groove containing the original sequence converted to MIDI events. In the end, you will save it as a new Sound.

How it works

Time Slicing detects the attacks (that is, kick and snare shots) inside a rhythm audio groove, and automatically divides the audio groove into individual percussive samples. The sliced percussive samples will be automatically assigned to different keys in a multisample, and the multisample to a Sound.

Within the generated multisample, a separate sample is assigned to a different note on the keyboard, starting from C#3. By playing an ascending chromatic scale with this multisample, you could recreate the original audio groove.

A MIDI Groove will also be created, containing a sequence of notes triggering the sliced percussive samples in the same order as in the original audio groove. When you will import this MIDI Groove to a Style or Pad track, this sequence will let you adjust the groove's tempo without affecting the pitch of the percussive samples.

In addition to changing the groove's tempo without affecting its pitch, this will let you change the order in which the samples are played, change the timing, and edit the pattern to freely recreate a new rhythm loop.

Slicing

- 1 Go to the Sampling > Time Slice page.

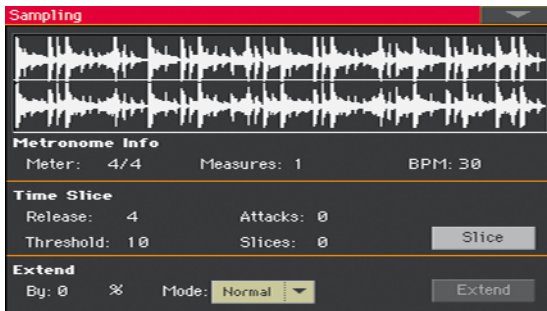

- 2 Use the Meter parameter to specify the Meter of the original sample.
- 3 Use the Measure parameter to specify the number of measures of the original sample. Usually, you will load a groove 1- or 2-measures long.
- 4 The BPM (Beats Per Minute) parameter specifies the tempo (in Beats Per Minute) of the original sample. This value is automatically calculated, based on the Start, End, Meter and Measures parameters.

If you know these data, manually enter the Meter, Measures and BPM parameters, to make the slicing more accurate. The BPM value can be only adjusted to values lower than the one automatically calculated. This can be useful, for example, when the actual sample is shorter than the entered Meter and Measures values.

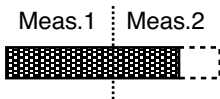

In the example above, the actual groove lasts only up to the first half of Measure 2. The recognized tempo is 130, while the real tempo is 100. Set the BPM value to 100, and a rest will be added to the end of the groove, to allow it to loop seamlessly.

- 5 Touch the Slice button to slice the original audio groove.

The generated multisample

Each individual sample generated from slicing the audio groove will be assigned to a different key.

Key	Assigned sample/pattern	Speed %
C2	Full pattern cycling at half the speed	50%
C#2	Full pattern cycling at various speeds	53%
D2		56%
D#2		60%
E2		63%
F2		67%
F#2		71%
G2		75%
G#2		80%
A2		84%
A#2		89%
B2		94%
C3	Full pattern cycling at the original speed	100%
C#3 and above	Separate sliced samples	-

The generated MIDI Groove

After slicing, a MIDI Groove with the original pattern will also be generated. The diagram will show the individual sliced samples separated by vertical lines:



Testing the generated Drum Kit

- To test the full pattern at different speed, play a note from C2 (half speed) to C3 (original speed). See table above.
- To test the single sliced samples, play notes from C#3 and above. If you play a full chromatic scale, you can play the original pattern.

If too many samples have been generated, and the keyboard can't fit them all, use the **UPPER OCTAVE** buttons to transpose the keyboard, and also listen to the samples exceeding the upper limit.

Adjusting the slicing parameters

- If the Slice procedure didn't produce satisfactory results, adjust the **Release** parameter, and touch the **Slice** button again.

Adjust the **Release** value changes the number of recognized attacks, by varying the speed needed to the Slice engine to start working again. For example, in the following example, if the **Release** value is too high (that is, too long), the second attack may be lost:

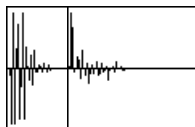

- If this, again, does not produce good results, try to also adjust the **Threshold** parameter, and touch the **Slice** button again.
- Since a **Tempo** value rounding happens during the Slice operation, and the loop may not be accurate, you may need to adjust both the **Start** and **End** parameters of the **Sample > Edit** page, to make the groove loop flawlessly. After editing these parameters, touch the **Slice** button again.

Go on experimenting different settings. Editing an audio groove is a pure matter of experimentation.

Extending the sample tails

When using the sliced grooves with a Tempo slower than the original, an annoying gap may be heard between a sample and the following one. The Extend function allows you to fix this problem by adding a 'tail' to all samples, making their decay smoother and more musical.

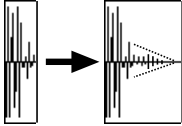

- 1 After slicing and testing the groove, use the Extend function if needed.
- 2 Go to the Sampling > Time Slice page.

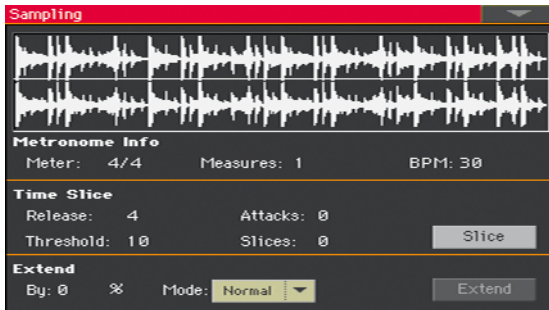

- 3 Adjust the Extend > By parameter to set the length of the 'tail' added to the samples (in percentage). A setting of 20-30% is usually suitable to most grooves.

Depending on the Tempo of the Style that will include this groove, use high or low values. If you will slow down the groove very much, assign higher values to this parameter, otherwise you may assign lower values.

Be careful with the higher By values, because the Extend function may add audible artifacts.

- 4 Use the **Extend Mode** pop-up menu to specify if the added 'tail' must decay in a linear way, or sustain for a longer time and then fall suddenly. Choose the **Extend** method suitable for the processed materials.

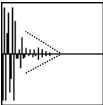
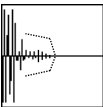
Extend Mode	Meaning	Shape
Normal	Most suitable for percussive sound with a short (but not immediate) decay. The 'tail' envelope is linear, and the level decays fast.	
Long	Most suitable for cymbals, whose sound should be sustained up until the next note. The 'tail' envelope is sustained and falls slowly, then falls suddenly next to the end.	

- 5 Touch the **Extend** button.
- 6 After the **Extend** operation is complete, test the pattern.
- To test the full pattern at different speed, play a note from C2 (half speed) to C3 (original speed). See table above.
 - To test the single sliced samples, play notes from C#3 and above. If you play a full chromatic scale, you can play the original pattern.
- 7 If the **Extend** operation didn't produce satisfactory results, change the settings and repeat it.

Writing the Audio Groove Slices

When the Time Slicing procedure is completed, you can save the data as a new Sound, together with a series of separate percussive samples, a multi-sample arranging them on the keyboard. A MIDI Groove containing the original sequence converted to MIDI events will also be created.

- 1 While in the Sampling > Time Slice page, choose the Write command from the page menu.

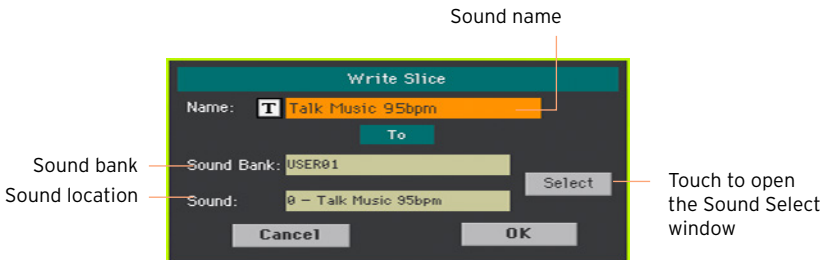

- 2 You may change the name of the Sound. Touch the Text Edit (**T**) icon to open the virtual keyboard and edit the name.

When done editing the name, confirm by touching the OK button under the virtual keyboard.

- 3 When back to the Write Slice dialog, if you want to save onto a different location touch the Select button and open the Sound Select window. Choose a location as if you were choosing a Sound. Blank locations are shown as a series of dashes ('---').
- 4 When back at the Write Slice dialog, confirm the Write operation by touching the OK button.

Together with the Sound and the associated samples and multisample, a MIDI Groove with the same name will also be saved to the RAM memory. This memory will be deleted when turning the instrument off. Therefore, immediately convert the MIDI Groove to a Style or Pad pattern, as explained in the following pages.

Using the Audio Groove Slices in a Style or Pad

After generating the Audio Groove Slices, you can use them in a Style or Pad, by importing the MIDI Groove to a track, and assigning the corresponding Sound to the same track.

Imported grooves can play at different Tempo values. However, please remember that they will not be transposed when playing different chords, since they are still audio data, that cannot be transposed by the Arranger.

Importing the MIDI Groove to a Style or Pad track

- 1 Go to the Style Play mode, and choose the User Style to which to assign the groove.
- 2 Press the RECORD button to access Style/Pad Record mode, and choose one of the Style or Pad recording options.
- 3 Go to the Style/Pad Record > Import/Export > Groove page.

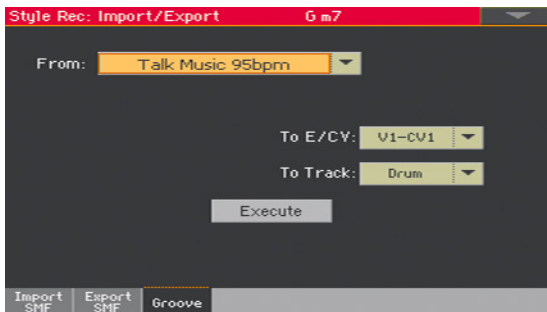

- 4 Use the From pop-up menu to choose the MIDI Groove. (This menu only appears if a MIDI Groove has been generated).
- 5 Use the To E/CV pop-up menu to choose a target Style Element and Chord Variation.
- 6 Use the To Track pop-up menu to choose a target track. We suggest the Percussion track, since the Drum track is still suitable for standard Drum Kit sounds (for count-ins, breaks, etc.).
- 7 Touch the Execute button to confirm.

Assigning the Sound to the Style or Pad track

After having imported the MIDI Groove, assign the Sound generated by the Time Slicing procedure to the track playing the MIDI Groove.

Assigning the Sound to a Style

- 1 Go to the Style Play mode, and choose the User Style to which to assign the Sound.
- 2 Go to the Style Play > Main page, and choose the Volume pane.
- 3 Use the TRACK SELECT button to see the accompaniment tracks (Style Tracks View).
- 4 Touch the icon of the track to which to assign the Sound (we suggest the Percussion track).
- 5 While the Sound Select window is open, choose the Sound (in the User bank).
- 6 Write the Style Settings.

Assigning the Sound to a Style Element track

- 1 Go to the Main page of the Style Record mode.
- 2 Select the track to which to assign the Sound (we suggest the Percussion track).
- 3 Touch the name of the Sound next to the Trk parameter.
- 4 While the Sound Select window is open, choose the Sound (in the User bank).
- 5 Write the Style.

Assigning the Sound to a Pad

- 1 Go to the Main page of the Pad Record mode.
- 2 Touch the name of the Sound next to the Pad Track parameter.
- 3 While the Sound Select window is open, choose the Sound (in the User bank).
- 4 Write the Pad.

Using the Audio Groove Slices in other Sounds

You can use the multisample and samples generated by a Time Slicing operation in other Sounds.

- 1 Go to the **Sound** mode, and choose a Sound similar to the one you want to assign the multisample to.
If you prefer to start from blank programming, choose the **Initialize Sound** command from the page menu.
- 2 Go to the **Sound > Basic > OSC** page, and select one of the oscillators.
- 3 Choose the new **multisample** from the **RAM** area, and assign it to one of the two layers (**High** or **Low**).
- 4 Choose the **Write Sound** command from the page menu, and save the Sound to an empty User location.

**PART VIII:
AUDIO IN/OUT
AND THE VOICE
PROCESSOR**

38 Setting the audio outputs and the final effects

Connecting the audio outputs

Connect the audio outputs as described in [Connecting the audio outputs](#) on page 17. If installed, the (optional) PaAS amplification system will work in parallel with the main audio outputs.

Choosing the audio outputs for the microphone and line audio inputs

You can send the signal entering the AUDIO INPUTS to the main outputs, or to the auxiliary sub-outputs. By default, the main LEFT and RIGHT audio outputs are selected.

- Go to the Global > Audio & Video > Audio In page, and use the Audio Out parameter to choose the audio output pairs.

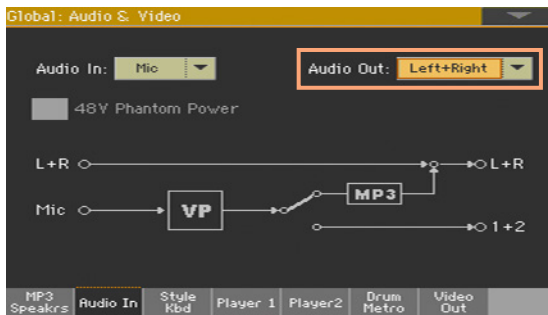

Audio Out	Meaning
Left+Right	Main LEFT and RIGHT outputs
Out1+2	Separate 1 and 2 sub-outputs

Sending the microphone or line audio input to the PaAS

To send the desired audio input signal to the PaAS do the following:

- Use the Audio In parameter to select the audio input.
- Use the Audio Out parameter to send the signal to the main Left+Right outputs.

Sending Sounds and Drum Kits to the audio outputs

Sounds from each part or track of the keyboard, the Style or MIDI Songs, as well as each Drum family, can be sent to a separate audio output. This routing is global, and will not change when choosing a different Keyboard Set, Style or Song.

Choosing the audio outputs for the Keyboard, Style, and the Players

The Keyboard, Style, and each of the Players's Sound can be sent to different audio outputs.

- 1 Go to the **Global > Style/Kbd, Player 1 or Player 2** page, depending on the Sound you want to route to an audio output.
- 2 Choose an audio output (or output pair) for each of the parts/tracks.

Audio Output	Meaning
Left+Right	The selected part/track is connected to the Left & Right outs, in stereo. It is also sent to the PaAS Amplification System, if installed. The part/track is also sent to the internal FX processors. You can use the MASTER VOLUME slider to adjust the volume.
Out1+2	The part/track is connected to the 1 & 2 sub-outs, in stereo. It is not sent to the internal FX processors. The MASTER VOLUME slider has no effect on it.
Out1, Out2	The selected part/track is connected to the sub-out 1 or 2. It is mixed to mono. It is not sent to the internal FX processors. The MASTER VOLUME slider has no effect on it.

Choosing the audio outputs for the Drum families

Drum Kits can be treated as ordinary tracks/Sounds, or as sets of separate percussive sounds that can be routed to different audio outputs.

Drum Kits treated as ordinary tracks

You can send the Drum Kit to an audio output (or output pair) as an ordinary track. All Drum families will be sent to the output chosen for the track the Drum Kit is assigned to.

- Go to the Global > Audio & Video > Drum/Metro page, and choose the Drum Kit Output > As Track option.

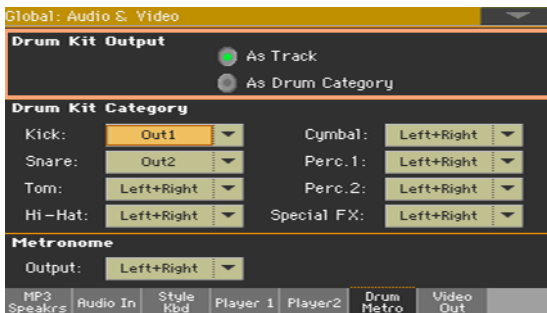

Drum Kits treated as separate Drum families

Each Drum family can be sent to a separate audio output (or output pair). This is useful if you want, for example, separately send the bass drum to an external compressor and sub-bass amplifier.

- Go to the Global > Audio & Video > Drum/Metro page, and choose the Drum Kit Output > As Drum Family option.

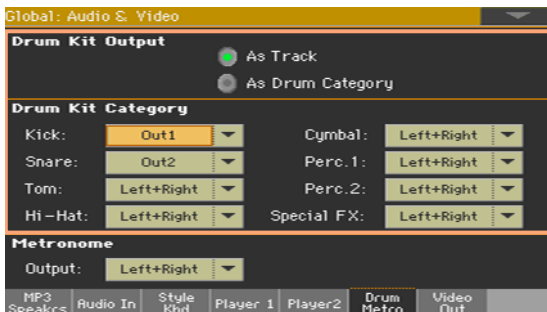

- Use the parameters in the Drum Kit Family section to choose a separate output (or output pair) for each percussive family of instruments.

Choosing the audio outputs for the metronome click

You can send the metronome click to any of the separate audio outputs (or output pairs). This will allow, for example, to send the click to the drummer's headphone amplifier only.

- 1 Go to the **Global > Drum/Metro** page.
- 2 Use the **Metronome > Output** pop-up menu to choose an audio output (or output pair) for the metronome click.

Programming the MAXX mastering effects

The result of KORG's long term cooperation with Waves Audio®, the MAXX AUDIO suite helps making the sound louder, clearer, fuller, and more polished. These effects apply to the final stage of the audio path, just before the audio outputs.

Choosing a MAXX Preset

You can quickly program the EQ and Master parameters by choosing a MAXX Preset.

- 1 Go to any page of the Global > MAXX Master EQ section.
- 2 Use the MAXXAUDIO pop-up menu on top of the page to choose a MAXX Preset.

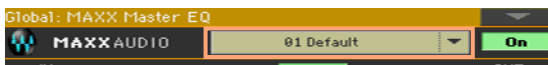

Choosing a default preset for the audio outputs, headphones and PaS amplification system

Pa4X can automatically select a MAXX Preset depending on the type of audio output. You can choose the default presets that will be automatically selected.

- 1 Go to the Global > MAXX Master EQ > Default Preset page.
- 2 Use the pop-up menu on top of the page to choose a MAXX Preset.

MAXX Preset	Meaning
Audio Output/ Headphones Preset	Only considered when no PaAs Amplification System is installed, or when the headphones are inserted.
Amplification System Preset	Only considered when the PaAs Amplification System is installed and no headphones are inserted.

Turning the MAXX effects on/off

You can turn the MAXX effects on or off, to quickly make the sound louder or flatter.

- 1 Go to any page of the Global > MAXX Master EQ section.
- 2 Use the On/Off button on top of the page to turn the MAXX effects on or off.

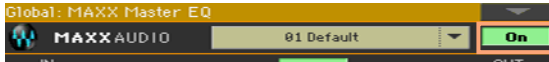

Please note that MP3 Songs are always recorded without the MAXX effects. This will avoid adding final processing to the processing already applied to the MP3 files.

Editing the MaxxEQ

MaxxEQ is a full spectrum frequency equalization, positioned at the end of the signal chain, just before the main audio outputs. It gives you the power to design EQ curves and shape your sound. Based on Waves professional audio equalizers, MaxxEQ features seven fully programmable bands with fully adjustable gain, frequency, and Q parameters.

Accessing the MaxxEQ

- Go to the Global > MAXX Master EQ > EQ page.



Turning the MaxxEQ on/off

- Use the MAXXEQ On/Off button to turn the EQ on/off.

Programming the EQ

- Look at the results of any edit in the diagram. The diagram shows the EQ curve. Its shape changes depending on the various parameter values.
- Use the Gain parameter to change the emphasis or attenuation of the corresponding band. Use it to make the frequencies stronger or weaker.
- Use the Freq parameter to change the center frequency of the corresponding band. Center it on the problematic frequency, or the harmonics you want to emphasize or attenuate.
- Use the Q parameter to adjust the 'quality' of the EQ filter; higher values correspond to narrower, more accurate filters. Use higher values for near-surgical correction on isolated frequencies, lower values for more musical, softer equalization.
- Use the On/Off buttons under each band to turn the corresponding bands on or off.

Editing the MaxxAUDIO Master

The MaxxAUDIO Master controls the MaxxBass, MaxxTreble, MaxxStereo and MaxxVolume effects. It is positioned at the end of the signal chain, just before the audio outputs, adds to the sound deeper, richer bass, and cleaner, warmer, more articulate treble with no loss of RMS (that is, average perceived volume). Processing also results in a stereo image that's wider and more accurate.

Please keep in mind that summing-up all levels could cause distortion in the PaAS Amplification System or in external amplification systems. Be careful not to max-out all sliders.

Accessing the MaxxAUDIO Master

- Go to the Global > MAXX Master EQ > Master page.



Turning the separate effects on/off

- Use the On/Off buttons on top of each slider to turn the corresponding effect on/off.

Programming the Master effects

- Use the IN/OUT indicators to check the level of the audio entering and coming out of the MaxxAUDIO processor. Be sure the indicators never go to the red area (since this means distortion).
- Use the virtual sliders to increase or decrease the level of the corresponding parameter.

If the input level is too high, decrease the level of the Sounds, Styles, Songs that are playing.

If the output level is too high, decrease the level of the various Maxx AUDIO controls (in particular, the Volume control).

MaxxBass

MaxxBass is for low frequency response beyond what your loudspeakers can deliver. You will hear low frequencies as much as 1.5 octaves below the limits of your loudspeakers.

MaxxBass isolates the low bass frequencies that can't be reproduced by the loudspeakers. The low frequencies are analyzed to create a complex set of higher frequency harmonics, which the loudspeakers can reproduce.

These harmonics are added back to the rest of the audio, replacing the original low frequencies. Your loudspeakers then reproduce the harmonic series, which are perceived by the brain as the original low frequencies. Finally, MaxxBass uses dynamic compression to focus and clarify the lower frequencies.

The result is larger, more powerful sound, with extended bass response up to 1.5 octaves below the roll-off frequency of the loudspeaker.

MaxxTreble

MaxxTreble is for enhanced high frequencies; it is ideal for one-way driver systems.

Using technologies originally developed for Waves professional audio plugins, MaxxTreble is a non-linear dynamic processor that enhances high frequency response, delivering a clean and pleasant high end, while minimizing distortion.

Using MaxxTreble technology you will be able to deliver louder, crisper and better defined high end without having to worry about clipping or peak-limiting.

MaxxStereo

MaxxStereo is for more realistic, wider stereo imaging. You will hear a wide, exciting stereo image, similar to what you'd hear in a modern movie theatre.

MaxxStereo spatial imaging technology improves the stereo separation of closely placed loudspeakers. With loudspeakers that are very close to the other (like in the optional PaAS Amplification System), MaxxStereo increases perceived separation for optimal imaging, with natural sound and a generous listening position.

MaxxVolume

MaxxVolume is for dynamics compensation. It increases (or decreases) RMS levels, delivering louder sound with no audible distortion.

It relies on Peak Limiting, that increases volume without clipping or audible distortion; Low Level Compression, that increases the clarity of soft sounds, especially in noisy environments and at quiet volumes; and Noise Gating, that eliminates background signal and system noise.

Writing a MAXX Preset

Open the Write Maxx Preset dialog

- 1 Go to the any page of the Global > Maxx Master EQ section.
- 2 Choose the Write Global Maxx Preset command from the page menu to open the Write Maxx Preset dialog.

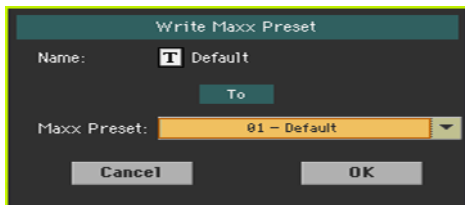

Write over the current Maxx Preset

- If you want to overwrite the current Preset, just touch the OK button.

Write to a different Maxx Preset location

- 1 If you want to choose a different location, use the Maxx Preset pop-up menu.
- 2 If you want to change the name of the Maxx Preset, touch the Text Edit (**T**) icon to open the virtual keyboard and edit the name.
- 3 When done editing the name, confirm by touching the OK button under the virtual keyboard.
- 4 When back at the Write Maxx Preset dialog, confirm the Write operation by touching the OK button.

39 | Connecting the audio inputs

Connecting a line audio device

Connecting the audio device

Use the AUDIO INPUT > LINE connectors to receive audio from an external device. These inputs are all line-level. Do not directly connect guitars, microphones or power amplifiers.

Warning: Connecting a power amplifier to these inputs will damage the instrument!

- Use the LINE 1 > LEFT and/or RIGHT connectors to connect the audio outputs of another keyboard, the outputs of a voice or guitar effect processor, the line outs of a stage mixer. Connect either of them to receive a mono signal. These are balanced (TRS) 6.35 mm, or 1/4", jack connectors.
- Use the LINE 2 > STEREO mini-jack (3.5 mm, or 1/8") connector to connect an external media player.

The line inputs are always enabled. They are always sent to the main LEFT and RIGHT audio outputs.

Setting the line input level

- Adjust the audio level from the external device.

Enabling the line audio input for MP3 recording

- Go to the Global > Audio & Video > Audio In page, and be sure the Audio In parameter is set to Line.
- In the same page, be sure the Audio Out parameter is set to L + R.

This will send the line inputs to the internal MP3 recorder, and disconnects the Mic input.

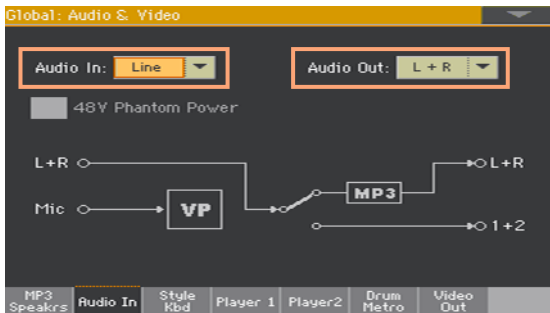

Connecting a microphone

Connecting the microphone

Use the MIC INPUT connector to connect a microphone. This is a combo connector, featuring an XLR and a 1/4" jack on the same connector. Use the balanced XLR jack to connect a condenser microphone, or the 1/4" jack to connect a dynamic microphone.

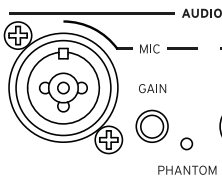

Enabling the microphone input

By default, the microphone input is enabled. In case it isn't, activate it.

- Go to the Global > Audio & Video > Audio In page, and be sure the Audio In parameter is set to Mic.



When the microphone input is enabled, it is also sent to the internal MP3 recorder.

Microphone types

There are two main types of microphones that you can connect to your Pa4X: dynamic and condenser.

Dynamic microphones do not require powering. They are usually conceived for live use, and have a narrow cardioid or hypercardioid pattern for better rejection of stage noise.

Condenser microphones require phantom powering supplied by Pa4X. Usually found in studio, these microphones usually come with a wider cardioid pattern, capturing more ambience and deeper basses. Wide-capsule condenser microphones are the preferred for studio voice applications.

Powering a condenser microphone

Condenser microphones require powering, supplied as a +48V phantom power current on the XLR MIC input.

Connect and turn on the microphone

- 1 Press the MIC button in the MIC/VOICE section to turn its indicator off. This will turn the microphone input off.
- 2 Connect a condenser microphone to the XLR MIC input.
- 3 Go to the Global > Audio & Video > Audio In page, and select the +48V Phantom Power checkbox.

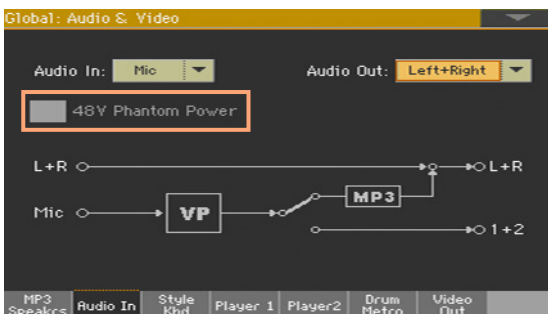

- 4 Press the MIC button again, to turn its indicator on. This will turn the microphone input on.
- 5 Sing into the microphone to check the input.

Disconnect and turn off the microphone

When disconnecting a microphone from the XLR jack, the phantom power is automatically turned off. Phantom power is also automatically turned off each time you turn the Pa4X off.

As an alternative, you can go to the **Global > Audio & Video > Audio In** page, and deselect the **+48V Phantom Power** checkbox.

Adjusting the microphone input gain

After connecting a microphone, you can adjust its input gain, mix level and output level.

- 1 Be sure the **MIC** indicator is turned on. Be sure the **HARMONY** and **DOUBLE** indicators are turned off.
- 2 Use the **GAIN** knob next to the **MIC INPUT** connector to adjust the input gain (from 20 to 55 dB). Check the level by watching at the **AUDIO IN** indicator on the control panel. Keep the level so that this indicator remains green most of the time, with orange appearing at signal peaks. Never go to red.

AUDIO IN color	Meaning
Off	No signal entering.
Green	Low- to mid-level signal entering. If the indicator turns off too often, the input gain is too low. Use the GAIN control to increase the input level.
Orange	Slight overload in the signal path. This is fine if it turns on only on signal peaks.
Red	Clipping is occurring in the signal path. Use the GAIN control to lower the input level.

For more accurate control of the microphone input, you can check the input level in the **Global > Mic Setup > EQ/Dynamics** page.

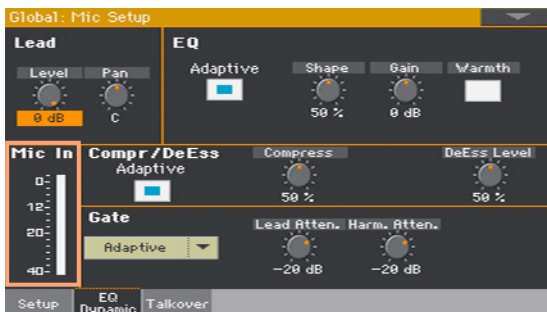

Turning the microphone on and adjusting the volume

The microphone can be quickly turned on or off, and its volume in the mix adjusted, right from the control panel. Please note that, for safety reasons, the input is always switched off when turning the instrument on.

- 1 Use the MIC button in the MIC/VOICE section in the control panel to turn the microphone on (or off).



- 2 Adjust the microphone volume by using the MIC VOLUME knob in the MIC/VOICE section.

You can see the volume of the Mic/In channel in the Main page of the Style Play or Song Play mode. Be sure it is not too low or muted.

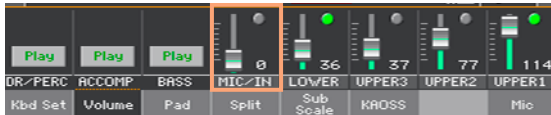

Start the automatic accompaniment or a Song to balance your voice against the Sounds.

Shaping the sound of the lead voice

The lead voice is your voice, or the one of your singer, entering the microphone input. You can apply effects and pitch correction, before sending it to the Voice Processor.

Setting the lead voice general controls

While in the Global > Mic Setup > Setup page, you can set the controls for the lead voice effects.

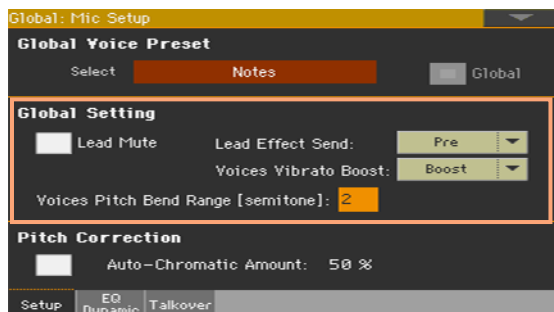

Turning the lead voice on/off

- While in the Global > Mic Setup > Setup page, use the Lead Mute checkbox to turn the lead voice on/off from the mix.

When the lead voice is turned off, you will only listen to the harmony voices and effects.

Lead Effect Send Pre/Post

- Use the Lead Effect Send pop-up menu to choose the pre/post status of the Lead Voice FX Send control.

The Lead Voice FX Send level is set with the Lead to controls in the Style Play/SongPlay > Voice Preset > FX Mixer page.

Lead Effect Send	Meaning
Pre	The Lead Voice effect will always be heard.
Post	The Lead Voice effect will depend on the channel level fader or mute switch.

Vibrato and bending

- While in the Global > Mic Setup > Setup page, use the Voices Vibrato Boost pop-up menu to specify how the Modulation message will affect vibrato.

Voices Vibrato Boost	Meaning
Boost	Adds more vibrato once the Modulation value reaches the corresponding amount of vibrato and then returns to the original amount at rest position.
Manual	Allows full range control of vibrato, once the Modulation message is received.

- While in the Global > Mic Setup > Setup page, use the Voices Pitch Bend Range parameter to set the bending range (in semitones) after receiving a Pitch Bend message.

Setting the lead voice pitch correction

While in the Global > Mic Setup > Setup page, you can activate and adjust the pitch correction on the lead voice.

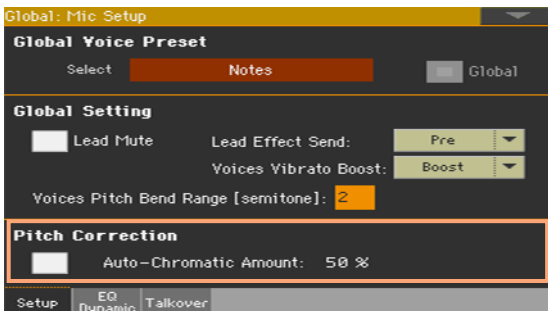

- Use the Pitch Correction checkbox to turn automatic chromatic pitch correction on/off.

For most applications, this is all that is required to set this feature. There is no need to set any Key or Scale parameter; all notes that you sing in the 12-tone Western chromatic scale are corrected to the nearest scale tone.

This type of vocal pitch correction is quite subtle at its factory setting of 50% but even the most highly skilled and on-pitch singers will hear a slight chorusing from the amplification system or monitors with it engaged.

- Use the Auto-Chromatic Amount parameter to adjust the pitch correction depth.

The factory default value is 50%. Changing the value towards 0% reduces the correction effect and changing towards 100% increases it. Above 50% the effect becomes more noticeable when you slide from note to note. This is the effect of faster transition speed between your input note and the closest scale tone as well as the fact that the algorithm is trying to pull you closer to the target.

Mixing the lead voice

- Go to the Global > Mic Setup > EQ/Dynamic page, and use the Level and Pan knobs to adjust the level and pan of the Lead Voice.

Parameter	Meaning	Value
Level	Level of the Lead Voice	-60dB...0dB
Pan	Position of the Lead Voice in the stereo panorama	L99 (Fully Left)... C0 (Center)... R99 (Fully Right)

Adding EQ, compression/de-esser and gate to the lead voice

While in the Global > Mic Setup > EQ/Dynamic page, you can program equalization, compression/de-esser and gate for the lead voice.

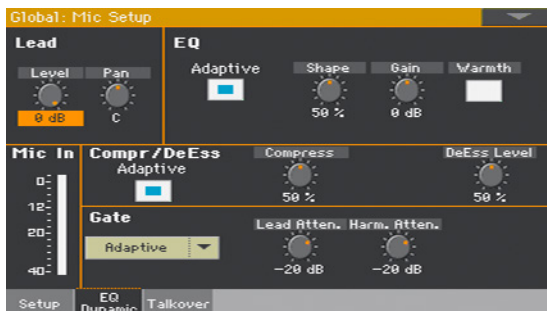

The EQ, Compression/DeEss and Gate sections work in a different way, depending on the Adaptive checkbox or menu status.

Programming the Adaptive EQ

When Adaptive is on, an automatic EQ algorithm is activated, and changes the control set for the EQ. Most of the adjustment is done automatically, so fewer controls are required.

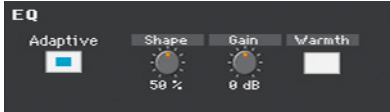

- Use the Shape knob to automatically adjust the Adaptive EQ. Shape processing offers an EQ curve that adds an airy brightness, or 'sizzle' to your voice while reducing 'mud' due to the proximity effect from singing closely into a cardioid microphone.

Adjusting the control from 0% to 50% reduces mud while increasing brightness to a useful range for your voice. Turning from 50% up to 100% adds more brightness.

- Use the Shape control to reduce mud.

For singers who have a voice with less bass frequencies, the 'mud' reduction may be less and perhaps not noticeable at all. This is a good thing - your voice is nicely balanced regarding bass frequencies. For the average male singer or women who sing closely on their mic, the reduction in bass will be noticeable and beneficial. When voices have too much bass, they tend to become lost in the other instruments that occupy those frequencies resulting in sonic clutter. Reducing bass has the natural effect of emphasizing mid and upper frequencies which allow the voice to cut through dense instrumentation.

Lastly, the term 'proximity effect' and 'cardioid' need to be clarified as they can cause bass build up. The typical microphone used by singers has a pickup pattern called 'cardioid' or heart-like, because it picks up less sound at the rear than at the front. This intends to reduce other instruments or sounds from getting into the front of the mic. A side effect of this that singing closely on a cardioid mic adds more bass frequencies than your voice actually has. This is called 'proximity effect' because it is caused by closeness to the mic. The adaptive Shape feature listens continually to your voice through your mic and adjusts to make your voice sound like it is professionally produced and balanced.

- Use the Shape control to add highs.

The other facet of the Shape feature is that it adds high frequencies, also known as 'air' or 'presence' without making your voice sound 'tinny'. The vocal sounds we hear on commercial recordings and the radio are not typically what you hear when you listen to a singer acoustically. Commercial vocal sounds are more of a hyper-reality designed to flatter the voice or voices and

make them cut through a group of instruments and thus make a larger impression on the listener. The Shape feature, used at moderate settings, emulates this sound through the average microphone and amplification system.

When making Shape adjustments, it's important to sing while listening to the amplification system your audience will hear rather than only judging by your monitor sound.

- Use the Gain knob to adjust the level after using the Shape control.
- Use the Warmth knob to return a narrow band of low frequencies for singers who prefer this sound. The majority of the 'mud' frequencies are still reduced automatically when using this control.

Programming the traditional EQ

When Adaptive is off, you can use traditional manual Parametric EQ controls.



There are three EQ bands:

- Low band shelving
- All band fully parametric peak/dip control
- High band shelving

The two Shelving EQs boost or cut all frequencies below or above the frequencies set by the Low and High controls respectively. These are most like the common Bass and Treble controls on a stereo system.

The Parametric EQ boosts or cuts the frequencies within a selected band that is defined by a center frequency (lower Mid knob) and a width control (center Mid knob). For vocals, the gain of a narrow parametric band is typically reduced to overcome room or voice resonances and smooth the sound although experienced users may boost a band felt to be missing in a particular voice as well.

The three Gain (upper) controls allow +/-12 dB of adjustment. The three Frequency (lower) controls range from 20 Hz to 20 kHz.

Programming the Adaptive Compressor

When Adaptive is on, an automatic Compressor algorithm is activated, and changes the control set. Most of the adjustment is done automatically, so fewer controls are required.



- Use the Compress control to reduce the range between louder and softer singing to produce more even-sounding vocals. It does so by listening to your singing over time (less than 30 seconds) and adjusting accordingly.

Typical compressors require multiple controls, knowledge and experience, and time spent testing and refining over a performance. With TC-Helicon's Adaptive Compress feature, these are not required.

The factory setting of 50% strikes a good balance between moderating dynamics in your singing without incurring feedback, a side effect of compression used in a live mic setting. If you have a high quality monitoring/amplification setup with a flat frequency response and you want more compression, by all means add more with the Compress control. Be aware though, that average quality systems have frequency peaks that may cause feedback with lots of compression combined with Adaptive Shape EQ.

- Compression basics

You may not notice this effect as easily as with Shape. It can be quite subtle until you educate your ears to compression. Following is a very brief description.

We typically sing dynamically, like this (capitals are used to show louder dynamics):

I LOVE to watch you WALK down the STREET

At acoustic singing levels with no, or very quiet instrumentation, this would sound fine. When amplified however, the loud words become strident and even worse, quiet words can be lost in the instrument sounds. The louder the amplification system and band the more pronounced the loud parts become. Compression seeks to do the following to your dynamics:

I LOVE to watch you WALK down the STREET

Applied appropriately, the difference between loud and soft is reduced without killing the interesting dynamics in your performance.

Programming the traditional Compressor

When Adaptive is off, you switch compression to manual control. Be sure to reduce the level of your amplification or switch to headphones when adjusting the manual compressor, because high settings can cause more gain and thus feedback.



- Use the **Threshold** control to set the singing level at and above which the amount of gain reduction (compression) specified by the **Ratio** control will occur. The range is 0 dB to -30 dB: 0 dB being the loudest input signal the Voice Processor can accept without distortion and -30 dB being a very quiet signal. If you sing consistently more quietly than the Threshold, you will not hear any compression. A good setting for experimentation is -10 dB.
- Use the **Ratio** control to set how much gain reduction you prefer when your voice level goes above the threshold. The range is from 1:1 (no gain reduction) to 4:1 (maximum vocal gain reduction). The default setting for Ratio is 4:1.

The number on the left side of the : (colon) symbol is how loud the peaks in your singing have to be in order to achieve a 1 dB gain increase. A brief example of how adjusting the ratio of compressor works is this: say a word you sang went 4 dB over the threshold when the Ratio was set to 4:1. The compressor would only allow it to go 1 dB louder.

Note that the Ratio control has to be set above 1.0 (1.0:1) to apply any compression regardless of the setting of the Threshold.

Also note that automatic makeup gain occurs depending on your combination of Threshold and Ratio. A side effect of compression is that it can reduce apparent level until makeup gain is applied to raise the overall level.

Programming the DeEsser

De-essing remains the same whether Adaptive is turned on or off.

- Use the **DeEss Level** control to adjust de-essing.

There is a side effect that comes from adding high frequencies and compression to your voice, and that's excessive sibilance. Sibilance can be described as the brief whistle that accompanies 'S', 'T' and 'D' syllables in your vocal performance. Again, when singing acoustically, there is no issue with these sounds. It's when you amplify and combine with boosted highs and compression that they can become piercing.

The DeEss Level control monitors the level of sibilance and, when it is detected, will quickly and transparently reduce it. Typically, it's only briefly re-

quired and it then gets out of the way allowing the silky brightness to remain on the voiced portion of your singing.

There is only the single DeEss Level control; no other manual adjustment settings are required. The factory setting of 50% gently reduces sibilance without becoming obvious. Higher settings of compression and Shape or a bright, sibilant voice may require a higher setting.

Programing Gate

If your musical accompaniment is loud or you hear feedback, the Gate control will enable you to make adjustments.

- Use the Gate pop-up menu on the left to select the Gate mode.

When the Gate mode is **Adaptive**, the Gate control helps in minimizing feedback, and reducing the amount of audible effects processing on sounds entering the mic other than your voice.

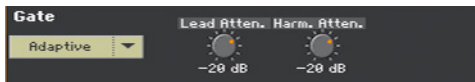

A typical, fixed gate works by shutting off, or reducing the level of any signal below a threshold that you set. When you sing louder than that threshold, the gate will open and your vocal will come through the amplification system. When you aren't singing, the gate will close and block sounds around you.

The Adaptive Gate works automatically with your singing style to provide the optimum balance between how loud you have to sing to open the gate and how much other noises are reduced.

For troublesome audio environments, or for those who are familiar with setting manual gate parameters, there is also a **Manual** setting.



You can also turn the gate to **Off** with good results if you are in a quiet, low volume musical environment.

- Use the **Lead Atten(uation)** knob to control how much your lead voice level is reduced (attenuated) when your voice falls below the Gate threshold and the Gate closes. This setting applies whether the Gate is set to Adaptive or Manual. The factory default setting of -3 dB (a reduction of 3 dB) is gentle enough that if your voice strays below the threshold, it is not cut off completely. If you are in a feedback-prone environment (loud monitors plus Shape and Compression) you can increase this to reduce more. A setting of

0 dB offers no gain reduction on your lead voice at all. Settings of -30 to Off effectively mute your voice when the Gate is on.

- Use the **Harm(ony) Atten(uation)** knob to set the amount of attenuation for the Harmony and Doubling voices when the Gate closes. They have a separate attenuation setting to reduce chatter caused by instrument sounds entering the mic and being harmonized when you aren't singing. The factory default attenuation amount of -10 dB should work well in many situations, but you can further reduce the level if you still hear harmonized instrumental chattering when you stop singing.
- Use the **Threshold** knob (only available with Manual Gate) to defines the minimum singing level you need to reach in order for the Gate to open and let your voice sound. The factory default setting of -40 dB is very sensitive to allow a wide range of singing levels but it may also allow more nearby instrumental sounds through when you are not singing. In this case, further adjustment from -39 dB and upward may be needed.

40 Talking with your audience

Soloing your voice (TalkOver)

- Go to the Main page > Mic pane, and touch the TalkOver button to talk to your audience.



The background music will be softened, and the voice effects switched off.

- Touch the same button again to turn the TalkOver function off.

Setting the Talk mode and level

- Go to the Global > Mic Setup > TalkOver page to set the TalkOver parameters.

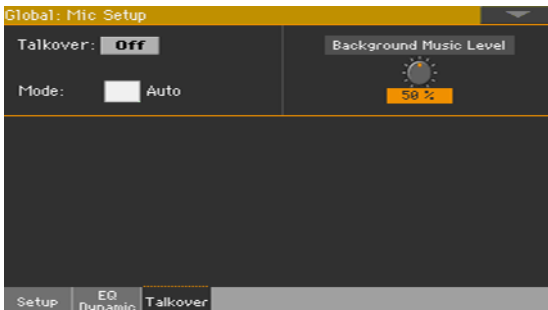

Choose between automatic and manual TalkOver

- While in this page, use the Mode > Auto checkbox to choose between Manual and Auto TalkOver.

When in Auto mode, TalkOver will be automatically engaged when the Arranger or Players are stopped. This way, you can talk to the audience between two songs, without the need to touch the TalkOver On/Off button.

- Use the **Background Music Level** control to set the level to which the volume of all Sounds (Keyboard, Style, Player, Pad...) will be reduced when TalkOver is engaged. 100% corresponds to no level reduction.

41 Using the voice effects and harmonization

Choosing a Voice Preset

Voice Presets contain settings for the voice effects and harmonization.

Choosing a Voice Preset from the library

Open the Voice Preset window from the control panel

- Press the PRESET button in the MIC/VOICE section.

Open the Voice Preset window from the display

- 1 While in the Main page, touch the Mic tab to see the Mic pane.
- 2 Touch the name of the selected Voice Preset.



Select a Voice Preset

As soon as you press the button or touch the display, the Voice Preset Select window appears.

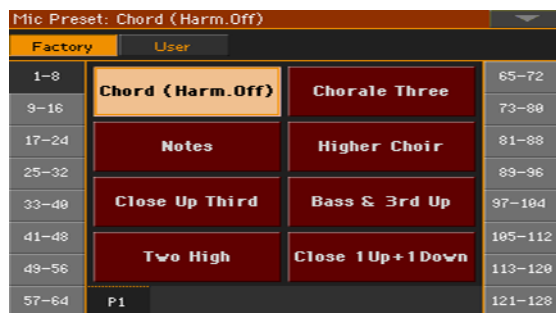

- 1 In case you want to choose a different group of Voice Presets, touch one of the tabs on the sides of the Voice Preset Select window.
- 2 Touch the name of the Voice Preset you want to choose.

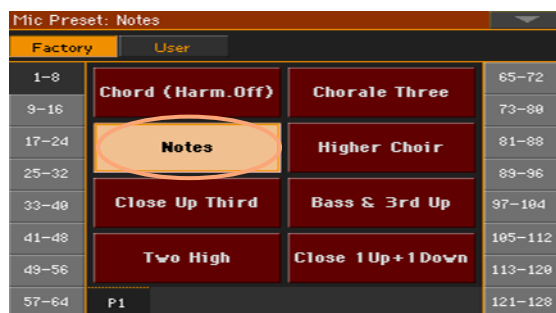

- 3 If you want to close the Voice Preset Select window (and it does not close by itself), press the EXIT button.

In the end, you will see the name of the selected Voice Preset in the dedicated area of the Mic pane. The voice effects and harmonization will change.



When changing the Voice Preset, the Global parameter is automatically deselected (see 'Global' and 'local' (or temporary) Voice Preset on page 529).

Choosing a Voice Preset with a SongBook Entry

When choosing a SongBook Entry, the Voice Preset might change. This will happen if the Global checkbox in the Main page > Mic tab is not selected.

Changing the global Voice Preset

The global Voice Preset is the general setting you use when there is no 'local' Voice Preset in a SongBook Entry. Some SongBook Entries might override the global Voice Preset with their memorized local Voice Presets.

Change the global Voice Preset

- 1 Go to the Global > Mic Setup > Setup page.

As an alternative, keep the SHIFT button pressed and press the MIC button to open the Setup page.

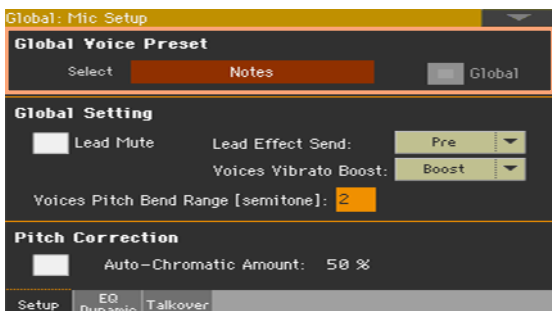

- 2 Touch the Select button in the Global Voice Preset area to open the Voice Preset window and choose the global Voice Preset.
- 3 Select the Global checkbox to use the global Voice Preset.

'Global' and 'local' (or temporary) Voice Preset

You can choose a 'global' Voice Preset that does not change when choosing a different SongBook Entry. Or you can choose a 'local' Voice Preset that is better suited to the individual SongBook Entry.

You can choose a Voice Preset from the library (Main page > Mic pane). This 'local' Voice Preset is just temporary, and only becomes permanent when you write a SongBook Entry.

To change the type of Voice Preset, select or deselect the Global parameter in the Main page > Mic pane. This parameter is saved with each SongBook Entry.



Harmonizing your voice

Harmonization adds a choir of voices to your lead voice.

Activating and setting the harmony voices

Choose a Voice Preset

- Press the **PRESET** button in the **MIC/VOICE** section, and choose a Voice Preset containing the desired harmonization type.

By default, these are some useful Presets to test harmonization:

Voice Preset	Harmonization Type
Chord (Harm. Off)	Chordal harmonization, especially meant for Styles. You are expected to play chords on the keyboard (the recognition zone depends on the Chord Scan section).
Notes	Polyphonic harmonization, especially meant for MIDI Songs. Notes are expected from the keyboard and/or from a track of the active MIDI Song (by default, track #5).

A Voice Preset can be automatically selected when choosing a SongBook Entry.

Turn harmonization on or off

- Use the **HARMONY** button to turn voice harmonization on or off.

Adjust the harmonization level

- Use the **HARMONY/DOUBLE** knob to adjust the harmony voices level.

Playing harmony

- 1 Play on the keyboard.

Depending on the chosen harmonization type, you will play chords or separate melody lines.

- 2 Sing along with the chords and melody lines you play on the keyboard.

Where do chords and notes come from?

Each Voice Preset contains settings to choose the source of the chords or notes. Depending on the preset, you will play on the keyboard, and/or let the MIDI Song send notes from a track selected from the preset.

You can find more information in the section dedicated to programming the Voice Presets.

Receiving chords or notes via MIDI

If you are using an external device (sequencer, master keyboard, MIDI accordion...) to send chords or notes to the Harmony section, you may want to set some MIDI parameters.

- 1 Go to the Global > MIDI > MIDI IN Controls page.
- 2 Use the Voice Processor > Midi In Channel parameter to choose a MIDI channel on which to receive chords or notes.

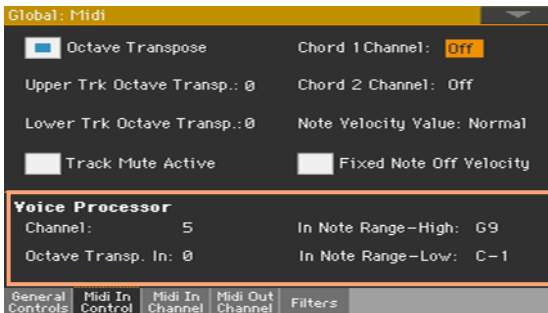

- 3 Use the Voice Processor > Octave Transpose In parameter to transpose the chords or notes received.
- 4 Use the Voice Processor > In Note Range High/Low parameters to set a range or notes to be sent to the Harmony section of the Voice Processor.

Doubling your voice

Doubling adds a second voice to your lead voice, making it thicker and stronger.

Choose a Voice Preset

- Press the **PRESET** button in the **MIC/VOICE** section, and choose a Voice Preset containing the desired doubling type.

A Voice Preset can be automatically selected when choosing a SongBook Entry.

Turn doubling on or off

- Use the **DOUBLE** button to turn doubling on or off.

Adjust the doubling level

- Use the **HARMONY/DOUBLE** knob to adjust the doubling voice level.

Playing double voice

- Just sing to hear your voice and the doubling voice.

Using the effects

Effects can add ambience, improve or transform your lead voice and the added voices. They are always included in any Voice Preset as separate FX blocks, that you can turn on/off or edit.

Turn the effects on or off

- 1 Go to the Main page > Mic pane.



- 2 Use the effect block buttons to turn each effect on or off.

Effect module	Meaning
Filter	Steep filters emulating the sound of radios, phones and devices that generally degrade the audio signal.
Hard Tune	Pitch corrector optimized to produce corrective pitch correction as well as obvious effects made popular by a number of artists.
μMod	Subtle thickening of the voice. This effect does a faithful job of emulating classic detune, chorus, flanger and thickening sounds.
Delay	Delay effect. The delay is similar to an echo, and can have short or long repetitions depending on the selected Voice Preset.

Adjust the effects level

- Use the DELAY/REVERB knob to adjust the effects level.

42 Editing the Voice effects

You can create your custom voice effects, to be saved into a Voice Preset and assigned to a SongBook Entry.

Accessing Voice Preset editing

- 1 Press the STYLE PLAY or SONG PLAY button in the MODE section of the control panel to go to the corresponding mode.
- 2 Press the MENU button and touch the Voice Preset button in the edit menu to choose the Voice Preset section.

Choosing, enabling and balancing the effects

While in the Voice Preset > Preset page, you can choose a Voice Preset, turn on/off the various effect blocks, choose the effects for each block, and mix them in the Voice Preset.



- Use the Select button to choose a different Voice Preset.
- Use the On/Off button to turn the effect block on/off. These switches are also found in all effect editing pages.
- Use the pop-up menus next to an effect block's name to choose a different effect for that effect block.
- Use the Level parameters to adjust the level of each effect block inside the Voice Preset.

Mixing the lead voice and the effects

While in the Voice Preset > FX Mixer page, you can set the master level of the effects, and internally route the effects.



- Use the Level control to adjust the level of each effect block inside the Voice Preset.
- Use the Del/Rev > Level control to adjust the level of the Delay and Reverb blocks. This corresponds to the DELAY/REVERB knob in the MIC/VOICE section of the control panel. This control is not memorized in the Voice Preset.
- Use the Lead to Mod/Delay/Rev controls to adjust the level of the lead voice going into the corresponding effect.
- Use the Harm/D to Mod/Delay/Rev controls to adjust the level of the harmony/double voices going into the corresponding effect.
- Use the Mod to Delay control to adjust the level of the μ Mod effect going into the Delay.
- Use the Delay to Rev control to adjust the level of the Delay effect going into the Reverb.

Editing the harmony voices

While in the Voice Preset > Harmony page, you can program the harmony voices.



Setting the general harmony parameters

The top area of the page contains general parameters.

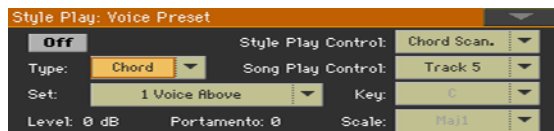

Choosing the Harmony set

- Use the Set pop-up menu to choose settings for the Harmony block.

Choosing the harmony type

- Use the Type pop-up menu to choose the type of harmonization.

Harmony Type	Meaning
Chord	Chords are to be played on the keyboard, received from a MIDI Song or via MIDI. When this type is selected, you can choose the source of the controlling chords (as explained below).
Scale	Harmony notes are adapted to the selected scale. When this type is selected, you can choose the Key/Scale (as explained below).
Shift	Harmony notes are exactly the indicated interval above or under the Lead voice.
Notes	Harmony voices play the notes played on the keyboard, received from a MIDI Song or via MIDI. When this type is selected, you can choose the source of the controlling notes (as explained below).

Choosing the source of chords or notes

- Use the **Style Play Control** pop-up menu to choose a source for chords or notes controlling harmony in the Style Play mode.

Control source (Style Play)	Meaning
Chord Scan	Play chords or notes in the area chosen with the CHORD SCAN buttons in the control panel.
Lower	Play chords or notes in the Lower area (under the split point).
Upper	Play chords or notes in the Upper area (above the split point).
Full	Play chords or notes over the full extension of the keyboard.

- Use the **Song Play Control** pop-up menu to choose a source for chords or notes controlling harmony in the Song Play mode.

Control source (Song Play)	Meaning
Off	No track sends chords notes to the Harmony module. Chords can still be received via MIDI.
Track 01...16	Chords or notes are received from one of the Player tracks.
Chord Scan	Play chords or notes in the area chosen with the CHORD SCAN buttons in the control panel.
Lower	Play chords or notes in the Lower area (under the split point).
Upper	Play chords or notes in the Upper area (above the split point).
Full	Play chords or notes over the full extension of the keyboard.

Choosing the Key and Scale

With Scale harmonization, all of the chords in an entire song and your melody can belong to a single key. You can input this key by using the Key parameter.

Use the Scale parameter to choose a type of scale for the harmony notes. You can choose between 3 Major and 3 Minor alternate scales that can be chosen if your harmony intervals sound incorrect at certain chord/melody combinations.

When the match of Key and song is correct, a Scale harmonization is nearly indistinguishable from recorded harmony. There are limitations however:

- Scale works for many, but not all songs.
- Scale works best with 3rd harmony intervals (Voice > Scale parameter); adding the 5th reduces the number of compatible songs.

You should be singing with musical backing and stay true to a A=440Hz reference. This could be a recorded song or other musicians. Choose a simple song to start with. Determine the key of your song; this is often the first or last chord in a song without extensions. For example G Major is a valid key, Gm7b5 is not.

If you're lucky the first time, you'll be rewarded with soaring harmony over your whole chorus or song. If not, you can try the following:

- Try a different Key, perhaps a 5th away from your first choice.
- Choose a different Major or Minor alternate Scale.
- Choose a Set with only the 3rd (High) interval.

Adjusting the level

- Use the Level parameter to adjust the level of the Harmony effect.

Setting portamento time

- Use the Portamento parameter to set the portamento time.

Portamento is a delayed response to the pitch movement of your singing voice. It is also referred to as 'Glide' in synthesizers. The range of values equals approximately how long the upwards or downwards slide will take to reach each new note.

Programming the individual harmony voices

The center area of the page contains parameters to program the individual voices. It is different, depending on the selected Harmony Type.

Harmony Type	Individual Voice Box
Chord	
Scale	
Shift	
Notes	

- Use the V1...V4 buttons to choose the harmony voice to program.

Choosing the Voicing for Chord-type harmonies

- Use the Voicing pop-up menu to specify the relation of the harmony note to the input note with respect to the current chord. In Chord mode presets, the harmony voices are always notes in the chord. A setting of Up1 will result in the harmony voice being the next note above the input voice in the chord. For instance, if the chord was C Major and the input note was an E, an Up1 setting would produce a G harmony voice, just above the input E.

Choosing the Scale for Scale-type harmonies

- Use the Scale pop-up menu to specify the interval of the harmony note with respect to the input note in the scale. The range of values goes from -2VE, which is 2 octaves below the input note, to +2VE which is two octaves above the input note. For example, a setting of +3 will result in a harmony voice a third above the input voice.

Choosing the Shift for Shift-type harmonies

- Use the **Shift** pop-up menu to choose the interval the harmony voice is shifted relative to the input note. The values range from -24 semitones to +24 semitones.

Programming the envelope for Notes-type harmonies

- Use the **Smooth** parameter to make the voice attack smoother and better in tune.

At low values, Smoothing acts like pitch correction for the harmony voices. With the voices corrected like this, some Portamento is usually required to help soften note to note transitions unless a robot-like effect is desired. Higher values offer progressively less correction. Like Portamento, setting each voice with a unique value of the Smoothing parameter helps the harmonies sound more natural. Please note that high values of smoothing will sound out of tune.

- Use the **Attack** parameter to add a gentle volume fade-in when you strike a note during a sustained sung note. The values range from 0 to 1000 milliseconds.
- Use the **Release** parameter to add a smooth fade-out if you release your note as you continue to sing. The values range from 0 to 2000 ms.

Choosing the individual voice's gender

- Use the **Gender** parameter to make timbre adjustment to the voice. Values below 0 lend each voice a more masculine and deeper effect and values above 0 lend a more feminine or thinner effect.

Adjusting the Level and Pan of the individual voices

- Use the **Level** parameter to control the relative volume of each voice. This is also where voices are turned on or off. The range of values goes from Off to 0 dB (Full). Typically all voices are set at the same level unless you want to highlight or minimize a particular voicing interval.
- Use the **Pan** parameter to set a unique pan position for each voice. There are 100 possible steps in each of the left and right pan positions.

When the Notes Harmony Type is selected, you can select between Narrow, Medium and Wide panning.

Programming the expression, EQ and internal mix

The bottom area of the page contains general parameters to control expression and mix the lead voice and effect.

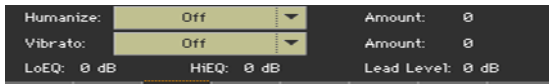

Humanizing the harmony voices

- Use the Humanize pop-up menu to choose a humanization style.

The term 'humanize' simply means the application of processes designed to increase realism. All harmony modes usually benefit from careful application of humanization styles that make each harmony voice respond with small pitch and timing variations different from your voice. Each Humanize Style configures each of the four voices differently; Voice 1 has slightly different parameter values than say Voice 4 in the same style but all four voices will work together to produce a useful overall effect.

The various Humanization styles consist of various amounts of the following modifiers:

Onset pitch events - This is also known as 'scooping' which adds a generated pitch trajectory for each new note that is different than the sung note.

Pitch modulation - A random wave generator wobbles the pitch in non-periodic ways to simulate even the finest singers' pitch variation.

Timing delay and modulation - Singers are unable to start notes at the same time with the exactness of a machine so this algorithm applies slight delays to the onset of notes and then adds modulated time variation to sustained portions of notes.

Level (volume) modulation - This effect is like a subtle tremolo with a non-periodic or semi random waveform that simulates the way different singers change note volumes as they sing.

- Use the Amount parameter to vary the amount of humanization for the harmony voices. All the styles except for the last one (Time & Pitch) were designed at middle values to allow you to add or remove effects as you see fit. Time & Pitch was designed so you can create wild special effects as you experiment with high values.

Adding vibrato

- Use the **Vibrato** pop-up menu to choose a vibrato style.

Vibrato assists in providing separation between your dry singing voice and the harmonies as well as to add some movement to the rigid pitch contour in Notes mode harmony. Even the smallest amount of vibrato applied to your harmony voices can achieve this. Like the Humanize effects, each voice is treated slightly differently by the Vibrato algorithm so the voices don't all sound exactly the same. There are 7 styles available in progressively more intensity as you browse down the list.

- Use the **Amount** parameter to vary the amount of vibrato intensity for the overall style with this parameter. All the styles were designed to be useful at middle values but you can add or remove vibrato as you like.

Equalizing the voices

- Use the **LoEQ** and **HiEQ** parameters to apply low-frequency and high-frequency equalization to all the harmony voices.

Mixing in the lead voice

- Use the **Lead Level** parameter to adjust the level of the lead voice mixed with the effect.

Editing the Double voice

While in the Voice Preset > Double page, you can program the Double voice.



The Double effect uses the same type of Humanization technology as in the Harmony effect to create up to two overdubbed versions of your voice. The two voices are set to unison intervals as opposed to the moveable intervals available for the harmony voices. Unlike simple detune or micro-shift techniques available with the μ Mod effect, Double simulates the sound of a vocalist overdubbing their vocal part multiple times. Many of the edit parameters for the Doubling page are the same as for Harmony page.

Choosing the Double set

- Use the Set pop-up menu to choose settings for the Double block.

Adjusting the level

- Use the Level parameter to adjust the level for the Double effect.

Editing the Humanize parameters

- Use the Humanize pop-up menu to choose a humanization style.

The term 'humanize' simply means the application of processes designed to increase realism. Contrary to the same parameter of the Harmony page, humanization is the same for all doubling voices.

- Use the Humanize Amount parameter to vary the amount of humanization for the harmony voices. It works exactly like the Amount parameter of the Harmony page.

Mixing in the lead voice

- Use the Lead Level parameter to adjust the level of the lead voice mixed with the effect.

Editing the Filter effect

While in the Voice Preset > Filter & Hard Tune page, you can program the Filter effect.



This effect uses steep filters to emulate the sound of radios, phones and devices that generally degrade the audio signal.

Choosing the Filter set

- Use the Set pop-up menu to choose settings for the Filter block. The Routing and Gate Threshold parameters are not part of the set.

Adjusting the level

- Use the Level parameter to adjust the level for the Filter effect.

Editing the filter parameters

- Use the **Routing** pop-up menu to specify where the Filter effect is inserted into the signal path.

Routing	Meaning
Off	No routing.
Lead	Filter is inserted on the Lead voice only. Harmonies and Doubling are unaffected.
Harm+Double	Filter is inserted on the Harmony+Double path only.
Voices	Filter is inserted on both the Lead, Harmony and Doubling voices.
Harmony FX	Filter is inserted on the Harmony send to the effects. Lead and Harmony voices will be clean.
Lead FX	Filter is inserted on the Lead send to the ←Mod, Delay and Reverb effect sends. Lead voice will be clean.

- Use the **Low Cut / Hi Cut** parameters to set the cut-off frequency for these very steep low and high shelving filters.
- Use the **Gate Threshold** parameter to prevent feedback.

This gate is separate from the main Gate applied to the microphone input, and is used to help prevent feedback when using the Filter with presence filtering that can introduce feedback in a live environment. This parameter sets how loud you must sing in order to open the gate.

Editing the Hard Tune effect

While in the Voice Preset > Filter & Hard Tune page, you can program the Hard Tune effect.

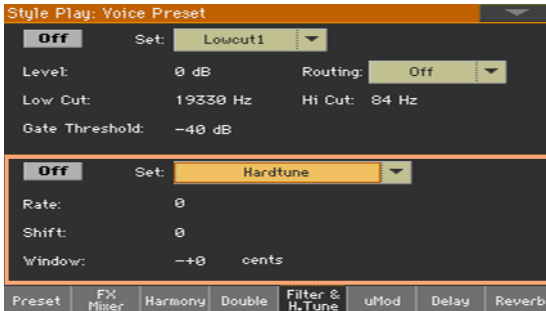

This effect is a pitch corrector that has been optimized to produce corrective pitch correction as well as obvious effects made popular by a number of artists. It only works when a chord is recognized.

Choosing the Hard Tune set

- Use the Set pop-up menu to choose settings for the Hard Tune block.

Editing the Hard Tune parameters

- Use the Rate parameter to specify how fast the algorithm pulls you toward scale tones. A value of 0 is off and a value of 100 is instant resulting in something like the infamous 'Cher' effect where the pitch correction effect is stair-stepped and obvious when using non-chromatic scales (those with at least a whole tone jump between most of the scale tones). Usually, values around 20 yield acceptable results for smooth, corrective pitch correction.
- Use the Shift parameter to set the relative shift in semitones above or below the input vocal. This is useful for transposing or creating character voices while simultaneously pitch correcting.
- Use the Window parameter to specify how close to a valid scale note you have to be before the algorithm corrects you. For example, a value of 80 cents means that only when you are singing within +/- 40 cents away from the target scale note will you be corrected. The maximum value is 600 cents. In a Major scale having no more than 100 cents on either side of any scale tone a setting of 200 would result in fulltime correction activity.

Editing the μ Mod effect

While in the Voice Preset > uMod page, you can program the micro-modulation effect.



μ Mod is short for micro-modulation. The μ Mod effect is capable of creating many different sounds that range from subtle but lush thickening to creatively destructive. It uses a combination of stereo pitch shifting (Detune), small amounts of stereo delay (Delay), and then a complex path of filtering, feedback, and modulation. μ Mod does a faithful job of emulating classic detune, chorus, flange and thickening sounds.

Choosing the μ Mod set

- Use the Set pop-up menu to choose settings for the μ Mod block.

Adjusting the level

- Use the Level parameter to adjust the level for the μ Mod effect.

Editing the μ Mod parameters

- Use the Speed parameter to set how fast the delay time modulation occurs. In order for this to be audible, the depth amount parameter has to be non-zero. The setting range is 10.00 Hz (very fast) to .05 Hz (very slow).
- Use the Detune L/R parameters to apply a small amount of pitch shift to the left or right sides independently. This setting is shown in cents and the maximum is +/- 25 cents.
- Use the Depth L/R parameters to set the amount of modulation of the delay time for the left and right delays. If one delay is set to 10mS, for example, a setting of 50% will vary the delay time between 15mS and 5mS at the rate set by the Speed parameter.

- Use the **Delay L/R** parameters to set the left and right delay times. Up to 50 ms of delay is available on the left and right delay lines to create effects from flange to slapback.
- Use the **Feedback L/R** parameters to re-introduces a portion of the audio output signal of the μ Mod block back to the input to create flanges, tube and chorus effects. Values above 90 add a high amount of gain and cause distortion and higher audio levels.

Mixing in the lead voice

- Use the **Lead Level** parameter to adjust the level of the lead voice mixed with the effect.

Editing the Delay effect

While in the Voice Preset > Delay page, you can program the delay effect.



The delay effect is a configurable echo. You can control how far apart the echoes occur (Delay Time), and whether the echoes fade out quickly or slowly or build on themselves. In addition, there are filtering and stereo controls that allow you to create many popular delay sounds.

Delays can be typically be categorized into the two listed categories below:

Short Delays: Initial reflections, Slaps

Long Delays (max stereo delay is 2500 ms or 2.5 sec.): Monotaps, Stereotaps, Syncopated taps, Ping-pongs (delays travelling from left to right).

Choosing the Delay set

- Use the Set pop-up menu to choose settings for the Delay block.

Adjusting the level

- Use the Level parameter to adjust the level for the Delay effect.

Editing the Delay parameters

- Use the Source parameter to specify which of the two methods you want to use to set delay times.

Source	Meaning
Time	This allows you to set the exact delay time for the left and right delay lines manually with the Time L and Time R controls.
MIDI	The unit can be set to derive its delay times from incoming MIDI clock signal.

- Use the **Quantize Left/Right** parameters, when the Source is set to MIDI, to divide the Tempo into even (e.g. 1/4 or quarter notes) or syncopated sub-beats (e.g. 1/4 triplets, 1/4 dotted notes) for the left and right delays.
- Use the **Time L/R** parameters to display the exact delay time and to allow editing with all Source settings. You may set from 0 to 2500ms (2.5 seconds) of delay for the left and right delay lines.
- Use the **Feedback L/R** parameters to re-introduces a portion of the audio output signal of the Delay block back to the input to add echo repeats.
- Use the **Hi Cut EQ / Low Cut EQ** parameters to add steep highpass (Low Cut) and low pass (Hi Cut) filters to control the bandwidth of the delays. Applying these filters to the delays can create the feeling of space while not obscuring the main vocal signal.
- Use the **Duck Amount** parameter to set how much attenuation (gain reduction) is applied to the delayed signal when a vocal is present. For ducking to not be too obvious, a slight reduction of -6 dB is best. The Ducking can also be turned Off with this parameter.

Mixing in the lead voice

- Use the **Lead Level** parameter to adjust the level of the lead voice mixed with the effect.

Editing the Reverb effect

While in the Voice Preset > Reverb page, you can program the reverb effect.



Reverb is arguably the most common vocal effect. It can add a spaciousness that softens the abrupt beginnings and endings of lyric phrases. Many reverb types are meant to imitate the natural sound of spaces like churches, clubs and halls but not all. Some reverb effects are recreations of electro-mechanical effects meant to imitate real spaces like plates and springs.

Reverbs are made up of early reflections and the longer reverberant sounds known as the tails. There are usually controls to control the balance of room level and tail. Additionally, a small delay can be added between the dry voice and the reverb signal that adds clarity by briefly separating the dry voice from its reverb. By far the most important control for reverb is the level. A single reverb patch can have a different result for the audience whether it is mixed quietly or boldly in the mix.

Choosing the Reverb set

- Use the Set pop-up menu to choose settings for the Reverb block.

Adjusting the level

- Use the Level parameter to adjust the level for the Reverb effect.

Editing the Reverb parameters

- Use the Decay parameter to set the length of the reverb tail from 10 ms to 20 seconds. Note that, due to the complex nature of Reverb algorithms, a decay time of 4 seconds may sound quiet different from one style to the next, even when the rest of the settings are identical.
- Use the Pre Delay parameter to introduces a short (up to 100 ms) delay between the dry audio signal and the onset of reverb to help simulate larger

spaces and to provide audio separation between the dry signal and the reverb effect.

- Use the **Hi Color / Lo Color** parameters to adjust the corresponding pre-set-frequency filters inserted into the Reverb feedback path that tailor the low and high frequency response and decay of the tails. Values toward -50 will cut response in its respective band and a values toward 50 increase response.
- Use the **Duck Amount** parameter to set the effect attenuation. When Ducking has a value other than Off, the Reverb block's output will be reduced while you are singing. At the end of a sung phrase, the effects return to the level you set, increasing the clarity of your vocals while still sounding very wet. This parameter sets the amount of attenuation for Ducking.

Mixing in the lead voice

- Use the **Lead Level** parameter to adjust the level of the lead voice mixed with the effect.

Writing a Voice Preset

Voice Presets can store the Voice effects settings for instant recall. The library is where you organize them by type.

Note: Changes can be saved onto User Voice Presets. They cannot normally be saved onto Factory Voice Presets.

Writing a Voice Preset

Open the Write Voice Preset dialog from the control panel

- While in any mode, keep the MIC/VOICE > PRESET button pressed for about one second.

Open the Write Voice Preset dialog from the display

- While in any of the Voice Preset pages, choose the Write Voice Preset command from the page menu.

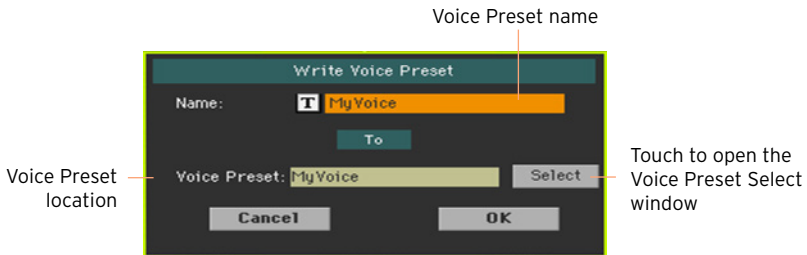

Write over the same Voice Preset

- If you want to overwrite the current Voice Preset, just touch the OK button.

Write to a different Voice Preset location

- 1 If you want to save onto a different location, touch the **Select** button and open the **Voice Preset Select** window. Choose a location as if you were choosing a Voice Preset. Blank locations are shown as a series of dashes ('---').
- 2 When back at the Write Voice Preset dialog, you may change the name of the Voice Preset. Touch the **Text Edit** (**T**) icon to open the virtual keyboard and edit the name.

When done editing the name, confirm by touching the **OK** button under the virtual keyboard.

- 3 When back at the **Write Voice Preset** dialog, confirm the **Write** operation by touching the **OK** button.

Saving a Voice Preset with a Keyboard Set, Style or Song

If you want to save the selected Voice Preset together with the Keyboard Sets, Styles or Songs, you can create a new SongBook Entry based on them. Choose the Voice Preset, together with the desired Keyboard Sets, Style or Song, then keep the **SONGBOOK** button pressed for about one second to create a new SongBook Entry.

**PART IX:
EFFECTS FOR
THE SOUNDS**

43 The effects

Editing the effects

Editing the insert effects (IFX)

- 1 Go to the Style Play or Song Play > Mixer/Tuning > Insert FX page.



- FX group
- FX on/off
- Selected FX type

- 2 While in the Insert FX page, touch the name of the selected effect type, or the 'x' symbol under the On/Off button, to open the FX Edit page.

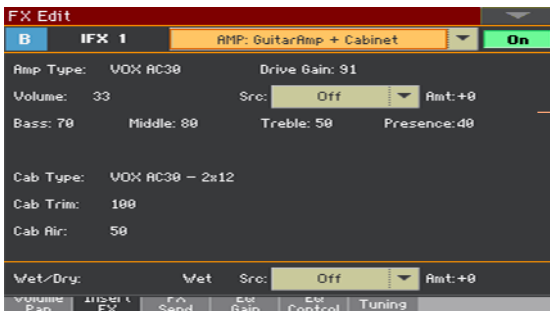

- Selected FX
- FX edit parameters
- FX mix and modulation

- 3 If you want, use the pop-up menu on top of the page to choose a different effect.
- 4 Edit the effect parameters, as described in the following pages.
- 5 When finished editing, press the EXIT button to return to the previous page.

Editing the master effects (MFX)

- 1 Go to the Master Effects > FX A/B page containing the master effect you want to edit.



- 2 While in the FX A or FX B page, touch the name of the assigned effects to open the FX Edit page.

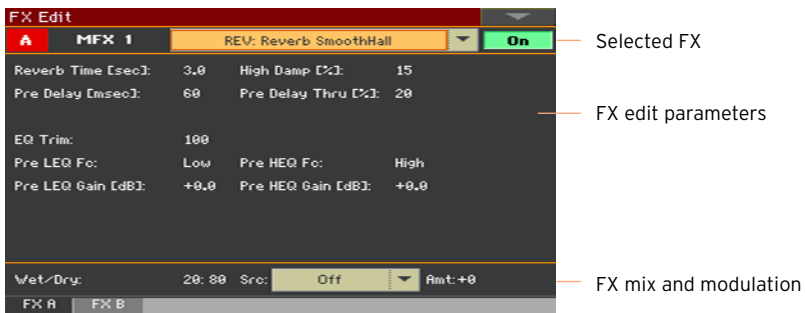

- 3 If you want, use the pop-up menu on top of the page to choose a different effect.
- 4 Edit the effect parameters, as described in the following pages.
- 5 When finished editing, press the EXIT button to return to the previous page.

Mixing the dry (direct) signal and the effects

- While in the FX Edit page, use the **Wet/Dry** parameter to set the balance between the Wet (effected) and Dry (direct) signal inside the corresponding FX processor.
- With master effects, you can set this value directly from the **W/D** parameters in the **Master Effects > FX** page.

We suggest not to change the insert effects' internal mix, unless you are trying to achieve a particular effect. Setting the direct signal of a modulating effect too low could, for example, cause phasing.

We suggest not to change the master effects' internal mix, unless you are fine-tuning it, because this is a general setting for the effect. To set the amount of effect applied to each Sound/channel, use the individual channels' send level instead.

Choosing a modulation source

You can modulate one of the effect parameters by using MIDI messages generated by the internal physical controllers or by MIDI data recorded in one of the Style or Song tracks.

Choose the modulation track

- With insert effects, the modulation is always received from the Sound/part/track they are assigned to. For example, if the insert effect is assigned to the Upper 1 part, it will be modulated by the Upper 1 part.
- With master effects, you must choose a modulating track. Go to the **Master Effects > FX A/B** page containing the master effect you want to edit, and use the **M.T. (Modulating Track)** parameter to choose the modulating Sound/part/track.

Choose the modulation source

- While in the FX Edit page (for both the insert or master effects), use the **Src (Source)** parameter to choose the physical controller or the type of MIDI data that will modulate the effect.

Pa4X uses the Dynamic Modulation Source (DMS) system, a highly flexible and powerful matrix of modulation. See below the list of available sources.

Set the modulation intensity

- While in the FX Edit page (for both the insert or master effects), use the Amt (Amount) parameter to set the intensity of modulation. This is an offset to the normal value received from the source.

Feeding the master effects back to the MFX1 input

Master effects are set in parallel, but you can set them in a serial chain by sending the output of the MFX2 or MFX3 processor back to the input of the MFX1 processor. This is useful, for example, to send a guitar amp simulator to the reverb and create an additional (post-fader) insert; or to send a delay into a reverb.

- While in the Master Effects > FX A/B page, use the to FX1 parameters to set the amount of the MFX2/MFX3 signal to be sent back to the MFX1 processor.

Adapting reverb to the room size

Pa4X includes a master offset for all the reverbs. Use it to adjust reverb tails to the room where you are playing. Use negative values when you are in a very reverberant room, positive values if the room is too dry.

- 1 Go to the Global > General Controls > Basic page.



- 2 Use the Reverb Offset parameter to change the reverb master.

Effects list

The following list contains all the Factory Effects. Detailed information on each effect's parameter are contained in the following pages.

REV (Reverb)

O-verb¹
 Reverb Hall
 Reverb SmoothHall
 Reverb Wet Plate
 Reverb Dry Plate
 Reverb Room
 ReverbBrightRoom
 Early Reflections
 Early Reflections Hi Dens²
 Reverb Spring
 Reverb - Gate

DEL (Delay)

L/C/R Delay
 Stereo/CrossDelay
 St. Multitap Delay
 St. Mod Delay
 St. Dynamic Delay
 St. AutoPanningDly
 Tape Echo
 Sequence BPM Dly
 L/C/R BPM Delay
 Stereo BPM Delay
 St.BPM Mtap Delay
 St.BPM Mod. Delay
 St.BPMAutoPanDly
 Tape Echo BPM
 Classic Tape Echo
 Hold Delay²
 L/C/R Long Delay²
 St/Cross Long Dly²
 LCR BPM Long Dly²
 St. BPM Long Dly²

MOD (Modulation)

Stereo Chorus
 Black Chorus/Flanger

St.HarmonicChorus
 Classic Chorus
 Multitap Cho/Delay
 Stereo Flanger
 St. Random Flanger
 St. Env. Flanger
 Classic Flanger
 Stereo Phaser
 St. Random Phaser
 St. Env. Phaser
 Orange Phaser
 Small Phaser
 Phaser - Cho/Flng
 St. Phaser + Trml
 Stereo Tremolo
 St. Env. Tremolo
 Classic Tremolo
 Ensemble
 Polysix Ensemble
 Stereo Vibrato
 U-Vibe
 St. Auto Fade Mod
 St. Biphase Mod
 Stereo Auto Pan
 St. Ring Modulator
 Organ Vib/Chorus
 Rotary Speaker
 Rotary SpeakerOD

DYN (Dynamics)

Stereo Compressor
 Dyn. Compressor
 Stereo Limiter
 Multiband Limiter
 St.Mltband Limiter
 St.MasteringLimtr
 Stereo Gate

AMP (Amplifier)

GuitarAmp + P4EQ
 GuitarAmp + Cabinet
 Amp Clean Combo
 Amp Clean Combo + Cab
 Amp California
 Amp California + Cab
 Amp Tweed
 Amp Tweed + Cab
 Amp Modded OD
 Amp Modded OD + Cab
 St. Guitar Cabinet
 Gtr. Cabinet + NR
 OD/HG - Amp Sim
 OD/Hi.Gain Wah
 OD/HyperGain Wah
 Comp - Amp Sim
 Comp - OD/HiGain
 Wah - Amp Sim
 Decimator - Amp
 AmpSim - Tremolo
 BassTubeAmp+Cab
 Bass Amp Model
 Bass Amp+Cabinet
 St. Bass Cabinet
 Tube PreAmp Model
 St. Tube PreAmp
 MicModel+PreAmp
 St. Mic + PreAmp

FILT (Filter)

St.Parametric4EQ
 St. Graphic 7EQ
 P4EQ - Exciter
 P4EQ - Wah
 St. Wah/Auto Wah
 St. Vintage Wah
 VOX Wah

St.Exciter/Enhncr
 Stereo Isolator
 St. Random Filter
 St. MultiModeFilter
 Talking Modulator
 2Voice Resonator
 Vox Treble Booster
 Vocoder³

FREQ (Frequency)

St. Sub Oscillator
 Grain Shifter
 Detune
 Pitch Shifter
 Pitch Shifter BPM
 Pitch Shift Mod
 St. Pitch Shifter
 St. PitchShift BPM

MISC (Miscellaneous)

Stereo Decimator
 St. Analog Record
 Doppler
 Scratch
 Auto Reverse
 P4EQ - Cho/FIng
 P4EQ - Phaser
 P4EQ - Mt. Delay
 Comp - Wah
 Comp - P4EQ
 Comp - Cho/FIng
 Comp - Phaser
 Comp - Mt. Delay
 Limiter - P4EQ
 Limiter-Cho/FIng
 Limiter - Phaser
 Limiter - Mt.Delay
 Exciter - Comp

Exciter - Limiter
 Exciter-Cho/FIng
 Exciter - Phaser
 Exciter - Mt.Delay
 OD/HG - Cho/FIng
 OD/HG - Phaser
 OD/HG - Mt.Delay
 Decimator - Comp
 Cho/FIng - Mt.Dly
 Multitap Cho/Delay
 PianoBody/Damper

Note:

1: MFX A/B1 only
 2: MFX A2/3, B2 only
 3: MFX A2/3, B2, IFX only

44 Effect parameters

REV (Reverbs)

O-verb

The O-verb features a high-quality, diffusion-based reverb core. In addition to setting the size of the room, you can model its shape and materials by adjusting the diffusion characteristics of both the initial reflections and the main reverberant wash, and via separate controls for the high, mid, and low decay times. The O-verb also includes randomization, for richer and smoother reverb timbres.

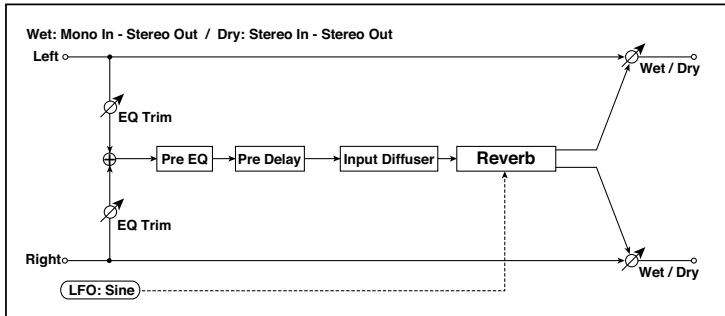

a	Trim	0...100	Sets the EQ input level.
b	Band1 Enable	On, Off	There are two fully parametric bands of peaking EQ, for adjusting the reverb timbre. These affect only the reverb, and not the dry signal. Both bands have identical parameters.
	Band1 Fc [Hz]	200...20.00k	
	Band1 Q	0.5...10.0	
	Band1 Gain [dB]	-18.0...+18.0	
c	Band2 Enable	On, Off	
	Band2 Fc [Hz]	200...20.00k	
	Band2 Q	0.5...10.0	
	Band2 Gain [dB]	-18.0...+18.0	

	Rolloff	0...100	This controls a lowpass filter on the output of the effect.
d	Pre Delay [msec]	0...1360	Sets the delay time from the dry sound
	Diffusion 1	0...100	Diffusion 1 and 2 soften the sound before it enters the reverb core, shaping the timbre of the initial reflections. Setting both diffusers to around 50 generally produces sufficient diffusion for smooth reverbs; extremely high levels may cause ringing. Some source material, such as vocals, may also benefit from lower settings of diffusion, allowing for more discrete echoes. Diffusion1 and Diffusion2 differ in how the reflections are spaced, and the balance between these two parameters will vary the character of the reverb.
	Diffusion 2	0...100	
e	Size	5...100	Sets the size of the space.
	Diffusion	0...100	This sets the density of reflections within the main reverb. Low settings will produce more discrete echoes, and high settings will produce a smoother reverb. Extremely high settings may cause ringing.
	Reverb Decay	0...100	This sets the main reverberation time. The Damping and Bass Gain parameters, below, let you adjust the decay times separately for the high and low frequencies, respectively.
f	Damping	0...100	This sets the cutoff of the high-frequency damping filter. If Damping is set to 100, the high frequencies will decay at the same rate as the low frequencies; at 0, the high frequencies will decay almost instantly. In real acoustic spaces, high frequencies generally decay somewhat faster than low frequencies, so moderate amounts of damping will create a more realistic sound.
	Bass Crossover [Hz]	20...24.00k	Sets the crossover frequency for the Bass Gain.
	Bass Gain [dB]	-12.0...+6.0	This lets you tailor the decay time of the reverb's low frequencies, using the frequency set by the Bass Xover. Negative settings make the low frequencies decay faster than the main reverb; positive settings make them decay more slowly.
g	Modulation Rate [Hz]	0.10...5.00	Speed of modulation.
	Modulation Depth	0...100	Depth of modulation.

i	Wet/Dry	Dry, 1:99...99:1, Wet	Balance between the wet and dry signal
	Src	Off...Tempo	See DMS (Dynamic Modulation Source)
	Amt	-100...+100	Amount of modulation source

e: Diffusion

Reverb Size, Time, and Diffusion:

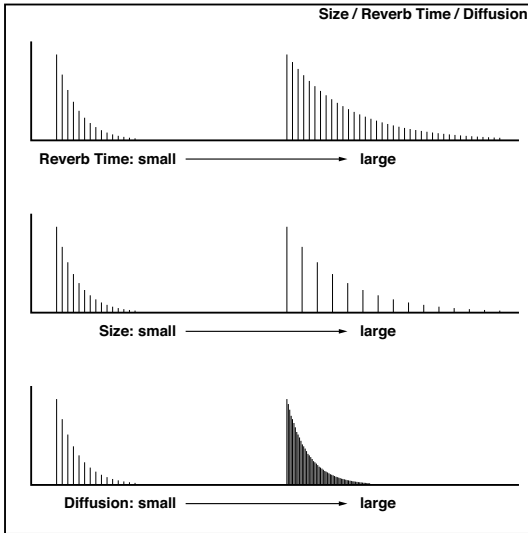

Reverb Hall

This hall-type reverb simulates the reverberation of mid-size concert halls or ensemble halls.

Reverb SmoothHall

This hall-type reverb simulates the reverberation of larger halls and stadiums, and creates a smooth release.

Reverb Wet Plate

This plate reverb simulates warm (dense) reverberation.

Reverb Dry Plate

This plate reverb simulates dry (light) reverberation.

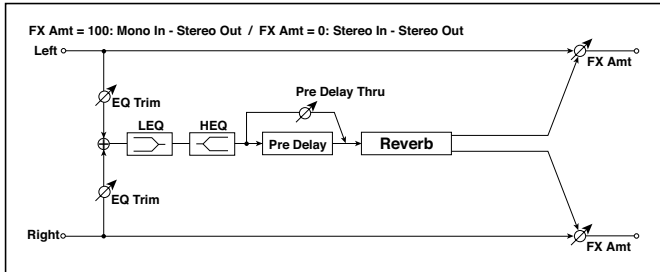

a	Reverb Time [sec]	0.1...10.0	Sets the reverberation time
	High Damp [%]	0...100	Sets the damping amount in the high range
b	Pre Delay [msec]	0...200	Sets the delay time from the dry sound
	Pre Delay Thru [%]	0...100	Sets the mix ratio of non-delay sound
c	EQ Trim	0...100	Sets the EQ input level
d	Pre LEQ Fc	Low, Mid-Low	Selects the cutoff frequency (low or mid-low) of the low-range equalizer
	Pre HEQ Fc	High, Mid-High	Selects the cutoff frequency (high or mid-high) of the high-range equalizer
e	Pre LEQ Gain [dB]	-15.0...+15.0	Sets the gain of Low EQ
	Pre HEQ Gain [dB]	-15.0...+15.0	Sets the gain of High EQ
f	Wet/Dry	Dry, 1:99...99:1, Wet	Balance between the wet and dry signal
	Src	Off...Tempo	See DMS (Dynamic Modulation Source)
	Amt	-100...+100	Amount of modulation source

b: Pre Delay [msec]

b: Pre Delay Thru [%]

The “Pre Delay” sets the delay time to the reverb input, allowing you to control spaciousness.

Using the “Pre Delay Thru” parameter, you can mix the dry sound without delay, emphasizing the attack of the sound.

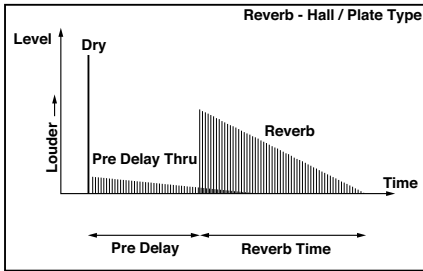

Reverb Room

This room-type reverb emphasizes the early reflections that make the sound tighter. Changing the balance between the early reflections and reverb sound allows you to simulate nuances, such as the type of walls of a room.

Reverb BrightRoom

This room-type reverb emphasizes the early reflections that make the sound brighter.

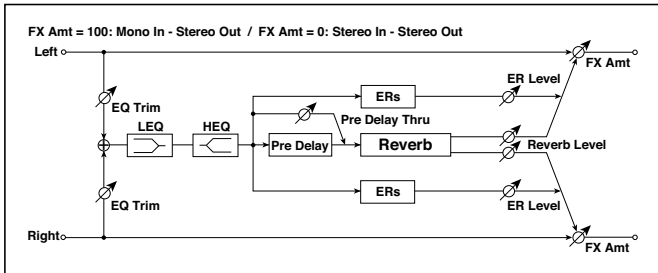

a	Reverb Time [sec]	0.1...3.0	Sets the reverberation time
	High Damp [%]	0...100	Sets the damping amount in the high range
b	Pre Delay [msec]	0...200	Sets the delay time from the dry sound
	Pre Delay Thru [%]	0...100	Sets the mix ratio of non-delay sound
c	ER Level	0...100	Sets the level of early reflections
d	Reverb Level	0...100	Sets the reverberation level

e	EQ Trim	0...100	Sets the EQ input level
f	Pre LEQ Fc	Low, Mid-Low	Selects the cutoff frequency (low or mid-low) of the low-range equalizer
	Pre HEQ Fc	High, Mid-High	Selects the cutoff frequency (high or mid-high) of the high-range equalizer
g	Pre LEQ Gain [dB]	-15.0...+15.0	Sets the gain of Low EQ
	Pre HEQ Gain [dB]	-15.0...+15.0	Sets the gain of High EQ
h	Wet/Dry	Dry, 1:99...99:1, Wet	Balance between the wet and dry signal
	Src	Off...Tempo	See DMS (Dynamic Modulation Source)
	Amt	-100...+100	Amount of modulation source

c: ER Level

d: Reverb Level

These parameters set the early reflection level and reverb level.

Changing these parameter values allows you to simulate the type of walls in the room. That is, a larger “ER Level” simulates a hard wall, and a larger “Reverb Level” simulates a soft wall.

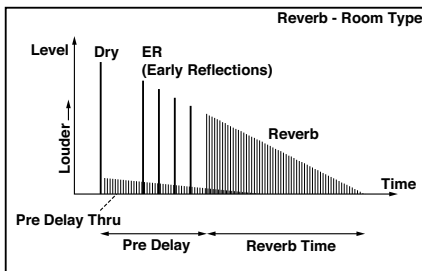

Early Reflections

This effect is only the early reflection part of a reverberation sound, and adds presence to the sound. You can select one of the four decay curves.

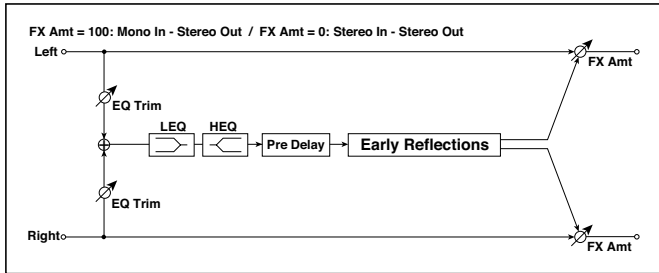

a	Type	Sharp, Loose, Modulated, Reverse	Selects the decay curve for the early reflection
b	ER Time [msec]	10..800	Sets the time length of early reflection
c	Pre Delay [msec]	0...200	Sets the time taken from the original sound to the first early reflection
d	EQ Trim	0...100	Sets the input level of EQ applied to the effect sound
e	Pre LEQ Fc	Low, Mid-Low	Selects the cutoff frequency (low or mid-low) of the low-range equalizer
	Pre HEQ Fc	High, Mid-High	Selects the cutoff frequency (high or mid-high) of the high-range equalizer
f	Pre LEQ Gain [dB]	-15.0...+15.0	Gain of the Low EQ
	Pre HEQ Gain [dB]	-15.0...+15.0	Gain of the High EQ
g	Wet/Dry	Dry, 1:99...99:1, Wet	Balance between the wet and dry signal
	Src	Off...Tempo	See DMS (Dynamic Modulation Source)
	Amt	-100...+100	Amount of modulation source

a: Type

This parameter selects the decay curve for the early reflection.

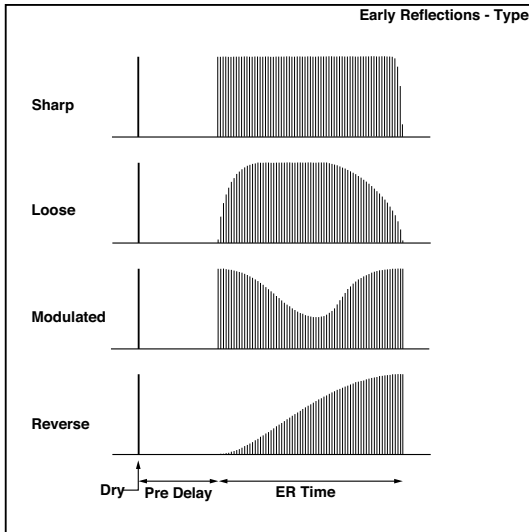

Early Reflections Hi Dens

This early reflection effect has more precise early reflections with twice the maximum length of a normal-size effect (Early Reflections). You can create a very smooth and dense sound.

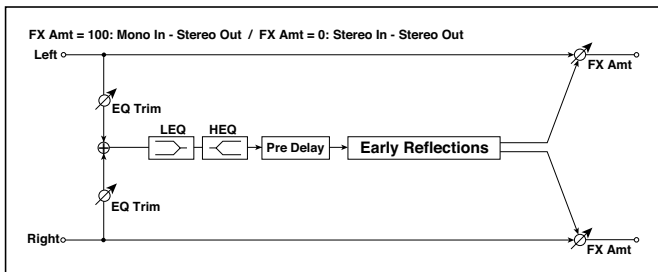

a	Type	Sharp, Loose, Modulated, Reverse	Selects the decay curve for the early reflection
b	ER Time [msec]	10...1600	Sets the time length of early reflection
c	Pre Delay [msec]	0...200	Sets the time taken from the original sound to the first early reflection

d	EQ Trim	0...100	Sets the input level of EQ applied to the effect sound
e	Pre LEQ Fc	Low, Mid-Low	Selects the cutoff frequency (low or mid-low) of the low-range equalizer
	Pre HEQ Fc	High, Mid-High	Selects the cutoff frequency (high or mid-high) of the high-range equalizer
f	Pre LEQ Gain [dB]	-15.0...+15.0	Sets the gain of Low EQ
	Pre HEQ Gain [dB]	-15.0...+15.0	Sets the gain of High EQ
g	Wet/Dry	Dry, 1:99...99:1, Wet	Balance between the wet and dry signal
	Src	Off...Tempo	See DMS (Dynamic Modulation Source)
	Amt	-100...+100	Amount of modulation source

Reverb Spring

The spring-type reverbs have a different sonic character than hall or room-type reverbs. They model the spring reverb systems built into some amps.

Reverb - Gate

This effect combines a mono reverb and a gate.

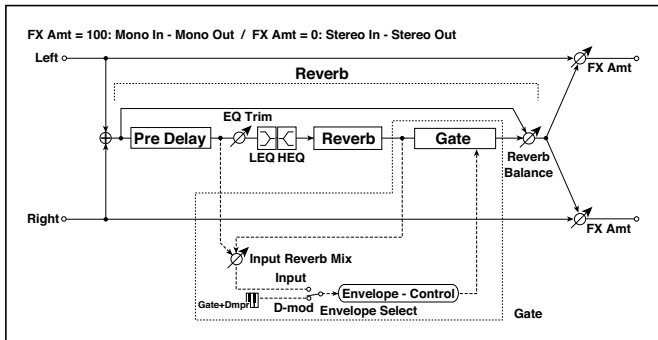

REVERB			
a	[R]Reverb Time [sec]	0.1...10.0	Sets the reverberation time
	High Damp [%]	0...100	Sets the damping amount in the high range

b	[R]Pre Delay [msec]	0...200	Sets the delay time of the reverb sound and gate control signal
c	[R]EQ Trim	0...100	Sets the EQ input level
	Reverb Balance	0...100	Sets the reverb effect balance
d	[R]PreLEQ Fc	Low, Mid-Low	Selects the cutoff frequency (low or mid-low) of the low-range equalizer
	Pre HEQ Fc	High, Mid-High	Selects the cutoff frequency (high or mid-high) of the high-range equalizer
e	[R]PreLEQ Gain [dB]	-15.0...+15.0	Sets the gain of Low EQ
	Pre HEQ Gain [dB]	-15.0...+15.0	Sets the gain of High EQ
GATE			
f	[G]Envelope Select	D-mod, Input	Switches between modulation source control and input signal control
	Src	Off...Tempo	Selects the modulation source that controls the gate when Envelope Select is set to D-mod
g	[G]Input Reverb Mix	0...100	Sets the balance between the dry and reverb sounds of the gate control signal
	Threshold	0...100	Sets the gate threshold level
h	[G]Polarity	+, -	Switches between non-invert and invert of the gate on/off state
i	[G]Attack	1...100	Sets the attack time
	Release	1...100	Sets the release time
j	Wet/Dry	Dry, 1:99...99:1, Wet	Balance between the wet and dry signal
	Src	Off...Tempo	See DMS (Dynamic Modulation Source)
	Amt	-100...+100	Amount of modulation source

f: [G]Envelope Select

f: Src

g: [G]Input Reverb Mix

g: Threshold

The “[G]Envelope Select” parameter enables you to select whether turning the gate on and off is triggered by the input signal level or controlled directly by the modulation source. You can select from Off to Tempo for the Src parameter to specify the modulation source.

When “[G]Envelope Select” is set to Input, the gate is controlled by the level of signals that are the combination of the dry sound and the reverb sound. When the signal level exceeds the threshold, the gate opens and the reverb sound is output.

Normally, set “[G]Input Reverb Mix” to Dry (the gate is controlled only by the dry sound). If you wish to extend the gate time, set the “[G]Input Reverb Mix” value higher and adjust the “Threshold” value.

DEL (Delay)

L/C/R Delay

This multitap delay outputs three Tap signals to the left, right, and center respectively. You can also adjust the left and right spread of the delay sound.

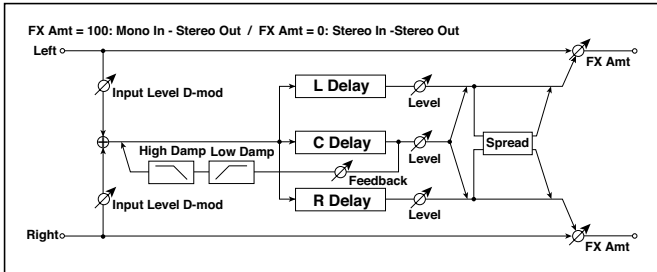

a	L Delay Time [msec]	0...2730	Sets the delay time of TapL	
	Level	0...50	Sets the output level of TapL	
b	C Delay Time [msec]	0...2730	Sets the delay time of TapC	
	Level	0...50	Sets the output level of TapC	
c	R Delay Time [msec]	0...2730	Sets the delay time of TapR	
	Level	0...50	Sets the output level of TapR	
d	Feedback (C Delay)	-100...+100	Sets the feedback amount of TapC	
	Src	Off...Tempo	Selects the modulation source of the TapC feedback amount	
	Amt	-100...+100	Sets the modulation amount of the TapC feedback amount	
e	High Damp [%]	0...100	Sets the damping amount in the high range	
	Low Damp [%]	0...100	Sets the damping amount in the low range	
f	Input Level Dmod [%]	-100...+100	Sets the modulation amount of the input level	
	Src	Off...Tempo	Selects the modulation source for the input level	
g	Spread	0...50	Sets the width of the stereo image of the effect sound	

h	Wet/Dry	Dry, 1:99...99:1, Wet	Balance between the wet and dry signal	
	Src	Off...Tempo	See DMS (Dynamic Modulation Source)	
	Amt	-100...+100	Amount of modulation source	

e: High Damp [%]

e: Low Damp [%]

These parameters set the damping amount of high range and low range. The tone of the delayed sound becomes darker and lighter as it feeds back.

g: Spread

This parameter sets the pan width of the effect sound. The stereo image is widest with a value of 50, and the effect sound of both channels is output from the center with a value of 0.

Stereo/CrossDelay

This is a stereo delay, and can be used as a cross-feedback delay effect in which the delay sounds cross over between the left and right by changing the feedback routing.

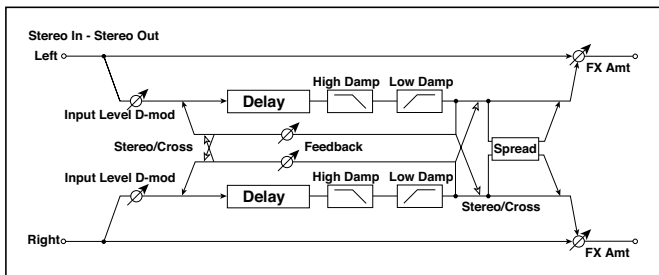

a	Stereo/Cross	Stereo, Cross	Switches between stereo delay and cross-feedback delay	
b	L Delay Time [msec]	0.0...1360.0	Sets the delay time for the left channel	
c	R Delay Time [msec]	0.0...1360.0	Sets the delay time for the right channel	

d	L Feedback	-100...+100	Sets the feedback amount for the left channel	
	Src	Off...Tempo	Selects the modulation source of feedback amount	
	Amt L	-100...+100	Sets the modulation amount of the left channel feedback	
e	R Feedback	-100...+100	Sets the feedback amount for the right channel	
	Amt R	-100...+100	Sets the modulation amount of the right channel feedback	
f	High Damp [%]	0...100	Sets the damping amount in the high range	
g	Low Damp [%]	0...100	Sets the damping amount in the low range	
h	Input Level Dmod [%]	-100...+100	Sets the modulation amount of the input level	
	Src	Off...Tempo	Selects the modulation source for the input level	
i	Spread	-50...+50	Sets the width of the stereo image of the effect sound	
j	Wet/Dry	Dry, 1:99...99:1, Wet	Balance between the wet and dry signal	
	Src	Off...Tempo	See DMS (Dynamic Modulation Source)	
	Amt	-100...+100	Amount of modulation source	

St. Multitap Delay (Stereo Multitap Delay)

The left and right Multitap Delays have two taps respectively. Changing the routing of feedback and tap output allows you to create various patterns of complex effect sounds.

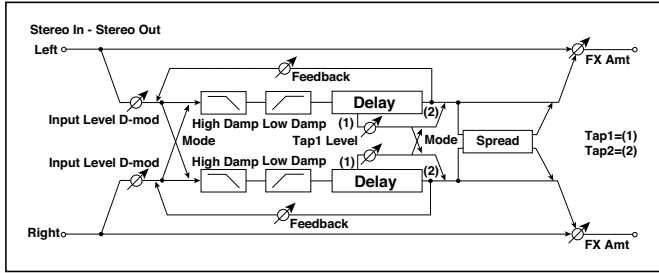

a	Mode	Normal, Cross Feedback, Cross Pan1, Cross Pan2	Switches the left and right delay routing
b	Tap1 Time [msec]	0.0...1360.0	Sets the Tap1 delay time
c	Tap2 Time [msec]	0.0...1360.0	Sets the Tap2 delay time
d	Tap1 Level	0...100	Sets the Tap1 output level
e	Feedback (Tap2)	-100...+100	Sets the Tap2 feedback amount
	Src	Off...Tempo	Selects the modulation source of the Tap2 feedback amount
	Amt	-100...+100	Sets the modulation amount of the Tap2 feedback amount
f	High Damp [%]	0...100	Sets the damping amount in the high range
g	Low Damp [%]	0...100	Sets the damping amount in the low range
h	Input Level Dmod [%]	-100...+100	Sets the modulation amount of the input level
	Src	Off...Tempo	Selects the modulation source for the input level
i	Spread	-100...+100	Sets the width of the stereo image of the effect sound
	Src	Off...Tempo	Selects the modulation source of the effect sound's stereo image width
	Amt	-100...+100	Sets the modulation amount of the effect sound's stereo image width

j	Wet/Dry	Dry, 1:99...99:1, Wet	Balance between the wet and dry signal	
	Src	Off...Tempo	See DMS (Dynamic Modulation Source)	
	Amt	-100...+100	Amount of modulation source	

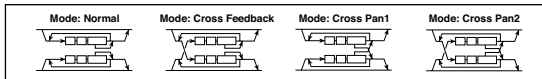

a: Mode

You can change how the left and right delay signals are panned by modifying the routing of the left and right delay as shown in the figure above. You need to input different sounds to each channel in order for this parameter to be effective.

d: Tap1 Level

This parameter sets the output level of Tap1. Setting a different level from Tap2 will add a unique touch to a monotonous delay and feedback.

St. Mod Delay (Stereo Modulation Delay)

This stereo delay uses an LFO to sweep the delay time. The pitch also varies, creating a delay sound which swells and shimmers. You can also control the delay time using a modulation source.

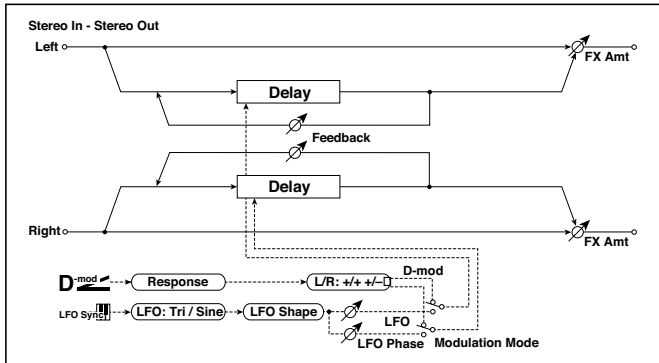

a	Modulation Mode	LFO, D-mod	Switches between LFO modulation control and modulation source control	
b	D-mod Modulation	L/R: +/+ , L/R: +/-	Reversed L/R control by modulation source	
	Src	Off...Tempo	Selects the modulation source that controls delay time	
	Response	0...30	Sets the rate of response to the modulation source	
c	LFO Waveform	Triangle, Sine	Selects the LFO Waveform	
	LFO Shape	-100...+100	Changes the curvature of the LFO Waveform	
d	LFO Sync	Off, On	Switches LFO reset off/on	
	Src	Off...Tempo	Selects the modulation source that resets the LFO	
e	LFO Frequency [Hz]	0.02...20.00	Sets the speed of the LFO	
f	MIDI Sync	Off, On	When this is on, the LFO speed is set by BPM, Base Note, and Times, instead of Frequency	
	BPM	MIDI, 40.00... 300.00	MIDI syncs to the system tempo; 40-300 sets the tempo manually for this individual effect	
	Base Note		Selects the type of notes that specify the LFO speed	
	Times	x1...x32	Sets the number of notes that specify the LFO speed	

g	L LFO Phase [deg]	-180...+180	Sets the phase obtained when the left LFO is reset	
	L Depth	0...200	Sets the depth of the left LFO modulation	
h	R LFO Phase [deg]	-180...+180	Sets the phase obtained when the right LFO is reset	
	R Depth	0...200	Sets the depth of the right LFO modulation	
i	L Delay Time [msec]	0.0...1000.0	Sets the delay time for the left channel	
	L Feedback	-100...+100	Sets the feedback amount of left delay	
j	R Delay Time [msec]	0.0...1000.0	Sets the delay time for the right channel	
	R Feedback	-100...+100	Sets the feedback amount of right delay	
k	Wet/Dry	-Wet, -1:99... Dry...99:1, Wet	Balance between the wet and dry signal	
	Src	Off...Tempo	See DMS (Dynamic Modulation Source)	
	Amt	-100...+100	Amount of modulation source	

b: D-mod Modulation

When the modulation source is used for control, this parameter reverses the left and right modulation direction.

d: LFO Sync

d: Src

g: L LFO Phase [deg]

h: R LFO Phase [deg]

If “LFO Sync” is On, the LFO will be reset by the modulation source that is received.

The “Src” parameter sets the modulation source that resets the LFO. For example, you can assign Gate as a modulation source so that the sweep always starts from the specified point.

“L LFO Phase” and “R LFO Phase” set the phase obtained when the left and right LFOs are reset. In this way, you can create changes in pitch sweep for the left and right channels individually.

 The effect is off when a value of the modulation source specified in the “Src” parameter is 63 or smaller, and the effect is on when the value is 64 or higher. The LFO is triggered and reset to the “L LFO Phase” and “R LFO Phase” settings when the value changes from 63 or smaller to 64 or higher.

St. Dynamic Delay (Stereo Dynamic Delay)

This stereo delay controls the level of delay according to the input signal level. You can use this as a ducking delay that applies delay to the sound only when you play keys at a high velocity or only when the volume level is low.

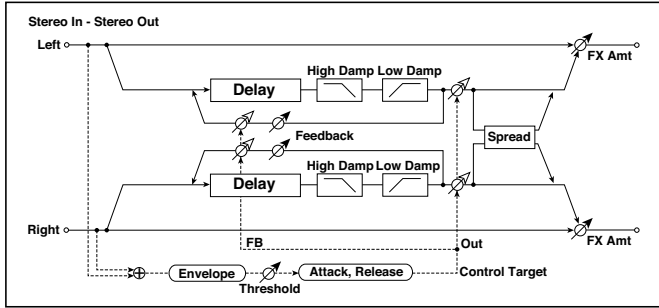

a	Control Target	None, Out, FB	Selects from no control, output, and feedback
	Polarity	+, -	Reverses level control
b	Threshold	0...100	Sets the level to which the effect is applied
	Offset	0...100	Sets the offset of level control
c	Attack	1...100	Sets the attack time of level control
d	Release	1...100	Sets the release time of level control
e	L Delay Time [msec]	0.0...1360.0	Sets the delay time for the left channel
f	R Delay Time [msec]	0.0...1360.0	Sets the delay time for the right channel
g	Feedback	-100...+100	Sets the feedback amount
h	High Damp [%]	0...100	Sets the damping amount in the high range
	Low Damp [%]	0...100	Sets the damping amount in the low range
i	Spread	-100...+100	Sets the width of the stereo image of the effect sound
j	Wet/Dry	Dry, 1:99...99:1, Wet	Balance between the wet and dry signal
	Src	Off...Tempo	See DMS (Dynamic Modulation Source)
	Amt	-100...+100	Amount of modulation source

a: Control Target

This parameter selects no level control, delay output control (effect balance), or feedback amount control.

a: Polarity

b: Threshold

b: Offset

c: Attack

d: Release

The “Offset” parameter specifies the value for the “Control Target” parameter (that is set to None), expressed as the ratio relative to the parameter value (the “Wet/Dry” value with “Control Target”=Output level, or the “Feedback” value with “Control Target”=Feedback).

When “Polarity” is positive, the “Control Target” value is obtained by multiplying the parameter value by the “Offset” value (if the input level is below the threshold), or equals the parameter value if the input level exceeds the threshold.

When “Polarity” is negative, Control Target value equals the parameter value if the input level is below the threshold, or is obtained by multiplying the parameter value by the “Offset” value if the level exceeds the threshold.

The “Attack” and “Release” parameters specify attack time and release time of delay level control.

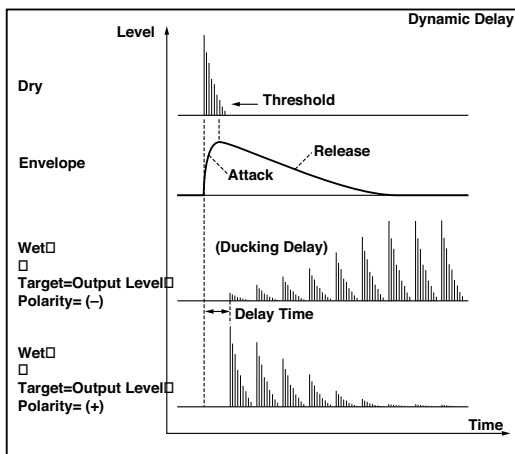

St. AutoPanningDly (Stereo Auto Panning Delay)

This stereo delay effect pans the delay sound left and right using the LFO.

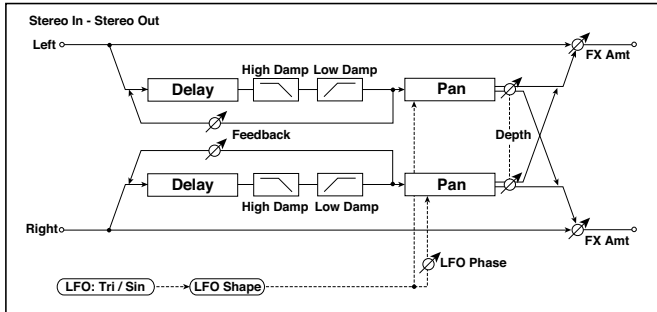

a	L Delay Time [msec]	0.0...1360.0	Sets the delay time for the left channel	
	L Feedback	-100...+100	Sets the feedback amount for the left channel	
b	R Delay Time [msec]	0.0...1360.0	Sets the delay time for the right channel	
	R Feedback	-100...+100	Sets the feedback amount for the right channel	
c	High Damp [%]	0...100	Sets the damping amount in the high range	
	Low Damp [%]	0...100	Sets the damping amount in the low range	
d	LFO Waveform	Triangle, Sine	Selects the LFO Waveform	
	LFO Shape	-100...+100	Changes the curvature of the LFO Waveform	
e	Phase [degree]	-180...+180	Sets the LFO phase difference between the left and right	
f	Panning Freq [Hz]	0.02...20.00	Sets the panning speed	
g	MIDI Sync	Off, On	Switches between using the frequency of the panning speed and using the tempo and notes	
	BPM	MIDI, 40.00...300.00	MIDI syncs to the system tempo; 40-300 sets the tempo manually for this individual effect	
	Base Note		Selects the type of notes to specify the delay time for the panning speed	
	Times	x1...x32	Sets the number of notes to specify the delay time for the panning speed	

h	Panning Depth	0...100	Sets the panning width
	Src	Off...Tempo	Selects the modulation source for the panning width
	Amt	-100...+100	Set the modulation amount of the panning width
i	Wet/Dry	Dry, 1:99...99:1, Wet	Balance between the wet and dry signal
	Src	Off...Tempo	See DMS (Dynamic Modulation Source)
	Amt	-100...+100	Amount of modulation source

Tape Echo

This effect simulates a tape echo unit with three playback heads. The distortion and tonal change typical of magnetic tape are also reproduced.

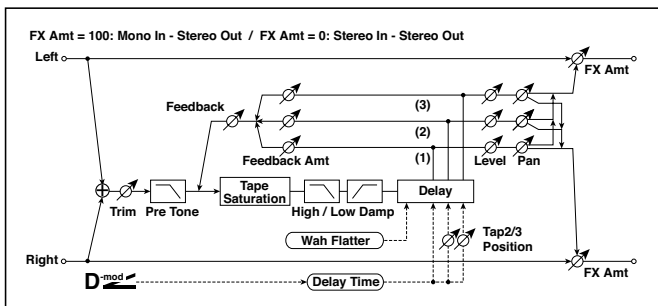

a	Delay (Tap1) [msec]	0...2700	Sets the delay time (tap1)
	Src	Off...Tempo	Selects the modulation source of the delay time
	Amt	-2700...+2700	Sets the modulation amount of delay time
b	Tap2 Position [%]	0...100	Sets the position of Tap 2 relative to the Tap 1 delay time the depth of pitch variation
c	Tap3 Position [%]	0...100	Sets the position of Tap 3 relative to the Tap 1 delay time the depth of pitch variation
d	Tap1 Level	0...100	Sets the Tap1 output level
	Pan	L, 1...99, R	Sets the stereo image of tap1
	FB Amt	-100...+100	Sets the Tap1 feedback amount

e	Tap2 Level	0...100	Sets the Tap2 output level
	Pan	L, 1...99, R	Sets the stereo image of tap2
	FB Amt	-100...+100	Sets the Tap2 feedback amount
f	Tap3 Level	0...100	Sets the Tap3 output level
	Pan	L, 1...99, R	Sets the stereo image of tap3
	FB Amt	-100...+100	Sets the Tap3 feedback amount
g	Feedback	0...100	Sets the amount of feedback for Taps 1, 2, and 3
	Src	Off...Tempo	Selects the modulation source of feedback amount
	Amt	-100...+100	Sets the feedback amount
h	High Damp [%]	0...100	Sets the damping amount in the high range
	Low Damp [%]	0...100	Sets the damping amount in the low range
i	Saturation	0...100	Sets the distortion amount
j	Input Trim	0...100	Sets the input gain
	Pre Tone	0...100	Sets the tone of the input
k	Wow Flutter [Hz]	0.02...1.00	Sets the frequency at which pitch variation will occur
	Wow Flutter depth	0...100	Sets the depth of pitch variation
l	Wet/Dry	Dry, 1:99...99:1, Wet	Balance between the wet and dry signal
	Src	Off...Tempo	See DMS (Dynamic Modulation Source)
	Amt	-100...+100	Amount of modulation source

a: Delay (Tap1) [msec]

a: Src

a: Amt

b: Tap2 Position [%]

b: Tap3 Position [%]

The delay time for Tap 2 and 3 is specified as a proportion (%) relative to "Delay (Tap1)." Even if you use dynamic modulation to control "Delay (Tap1)," Tap 2 and 3 will change at the same proportion.

- d: FB Amt
- e: FB Amt
- f: FB Amt
- g: Feedback

The feedback output from Tap 1, 2, and 3 is mixed according to the “FB Amt,” and then the final amount of feedback is specified by “Feedback.”

Sequence BPM Diy (Sequence BPM Delay)

This four-tap delay enables you to select a tempo and rhythm pattern to set up each tap.

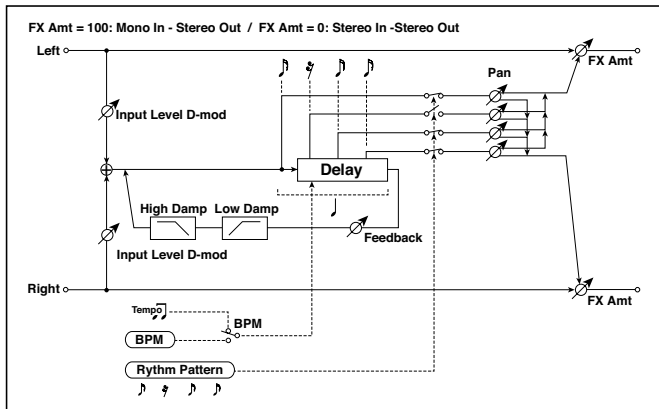

a	BPM	MIDI, 40.00... 300.00	MIDI syncs to the system tempo; 40-300 sets the tempo manually for this individual effect	
b	Rhythm Pattern		Selects a rhythm pattern	
c	Tap1 Pan	L, 1...99, R	Sets the panning of Tap1	
	Tap2 Pan	L, 1...99, R	Sets the panning of Tap2	
	Tap3 Pan	L, 1...99, R	Sets the panning of Tap3	
	Tap4 Pan	L, 1...99, R	Sets the panning of Tap4	
d	Feedback	-100...+100	Sets the feedback amount	
	Src	Off...Tempo	Selects the modulation source of feedback amount	
	Amt	-100...+100	Sets the feedback amount	

e	High Damp [%]	0...100	Sets the damping amount in the high range
	Low Damp [%]	0...100	Sets the damping amount in the low range
f	Input Level Dmod [%]	-100...+100	Sets the modulation amount of the input level
	Src	Off...Tempo	Selects the modulation source for the input level
g	Wet/Dry	Dry, 1:99...99:1, Wet	Balance between the wet and dry signal
	Src	Off...Tempo	See DMS (Dynamic Modulation Source)
	Amt	-100...+100	Amount of modulation source

a: BPM





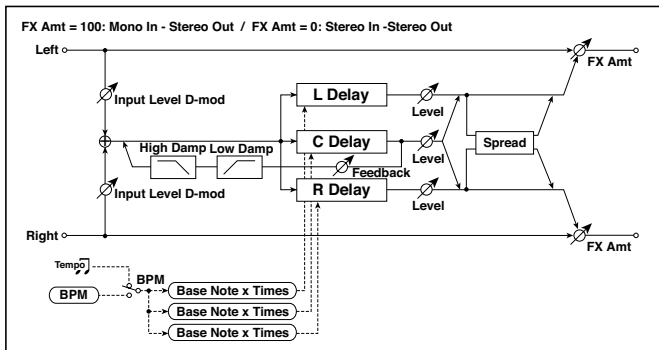

b: Rhythm Pattern

With the tempo specified by the “BPM” parameter (or the MIDI Clock tempo if “BPM” is set to MIDI), the length of one beat equals the feedback delay time, and the interval between taps becomes equal. Selecting a rhythm pattern will automatically turn the tap outputs on and off. When “BPM” is set to MIDI, the lower limit of the “BPM” is 44.

L/C/R BPM Delay

The L/C/R delay enables you to match the delay time with the song tempo. You can also synchronize the delay time with the arpeggiator or sequencer. If you program the tempo before performance, you can achieve a delay effect that synchronizes with the song in real-time. Delay time is set by notes.



a	BPM	MIDI, 40.00... 300.00	MIDI syncs to the system tempo; 40-300 sets the tempo manually for this individual effect	
	Time Over?	--, OVER!	Displays an error message when the delay time exceeds the upper limit	
b	L Delay Base Note		Selects the type of notes to specify the delay time for TapL	
	Times	x1...x32	Sets the number of notes to specify the delay time for TapL	
	Level	0...50	Sets the output level of TapL	
c	C Delay Base Note		Selects the type of notes to specify the delay time for TapC	
	Times	x1...x32	Sets the number of notes to specify the delay time for TapC	
	Level	0...50	Sets the output level of TapC	
d	R Delay Base Note		Selects the type of notes to specify the delay time for TapR	
	Times	x1...x32	Sets the number of notes to specify the delay time for TapR	
	Level	0...50	Sets the output level of TapR	
e	Feedback (C Delay)	-100...+100	Sets the feedback amount of TapC	
	Src	Off...Tempo	Selects the modulation source for the TapC feedback	
	Amt	-100...+100	Sets the modulation amount of the TapC feedback	
f	High Damp [%]	0...100	Sets the damping amount in the high range	
	Low Damp [%]	0...100	Sets the damping amount in the low range	
g	Input Level Dmod [%]	-100...+100	Sets the modulation amount of the input level	
	Src	Off...Tempo	Selects the modulation source for the input level	
h	Spread	0...50	Sets the width of the stereo image of the effect sound	
i	Wet/Dry	Dry, 1:99...99:1, Wet	Balance between the wet and dry signal	
	Src	Off...Tempo	See DMS (Dynamic Modulation Source)	
	Amt	-100...+100	Amount of modulation source	

a: Time Over?

You can set the delay time up to 5,460msec. If the delay time exceeds this limit, the error message “OVER!” appears in the display. Set the delay time parameters so that this message will not appear. “Time Over?” is only a display parameter.

Stereo BPM Delay

This stereo delay enables you to set the delay time to match the song tempo.

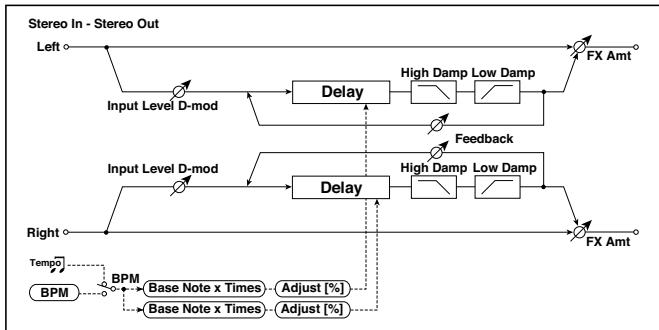

a	BPM	MIDI, 40.00... 300.00	MIDI syncs to the system tempo; 40-300 sets the tempo manually for this individual effect	
	Time Over? L	---, OVER!	Display the error message if the left channel delay time exceeds the upper limit	
	R	---, OVER!	Display the error message if the right channel delay time exceeds the upper limit	
b	L Delay Base Note		Selects the type of notes to specify the left channel delay time	
	Times	x1...x32	Sets the number of notes to specify the left channel delay time	
	Adjust [%]	-2.50... +2.50	Fine-adjust the left channel delay time	
c	R Delay Base Note		Selects the type of notes to specify the right channel delay time	
	Times	x1...x32	Sets the number of notes to specify the right channel delay time	
	Adjust [%]	-2.50... +2.50	Fine-adjust the right channel delay time	

d	L Feedback	-100...+100	Sets the feedback amount for the left channel	
	Src	Off...Tempo	Selects the modulation source of feedback amount	
	Amt L	-100...+100	Sets the modulation amount of the left channel feedback	
e	R Feedback	-100...+100	Sets the feedback amount for the right channel	
	Amt R	-100...+100	Sets the modulation amount of the right channel feedback	
f	High Damp [%]	0...100	Sets the damping amount in the high range	
g	Low Damp [%]	0...100	Sets the damping amount in the low range	
h	Input Level Dmod [%]	-100...+100	Sets the modulation amount of the input level	
	Src	Off...Tempo	Selects the modulation source for the input level	
i	Wet/Dry	Dry, 1:99...99:1, Wet	Balance between the wet and dry signal	
	Src	Off...Tempo	See DMS (Dynamic Modulation Source)	
	Amt	-100...+100	Amount of modulation source	

a: Time Over? L, R

You can set the delay time up to 2,730msec. If the delay time exceeds this limit, the error message "OVER!" appears in the display. Set the delay time parameters so that this message will not appear. "Time Over?" is only a display parameter.

St.BPM Mtap Delay (Stereo BPM Multi tap Delay)

This four-tap delay enables you to select a tempo and rhythm pattern to set up each tap.

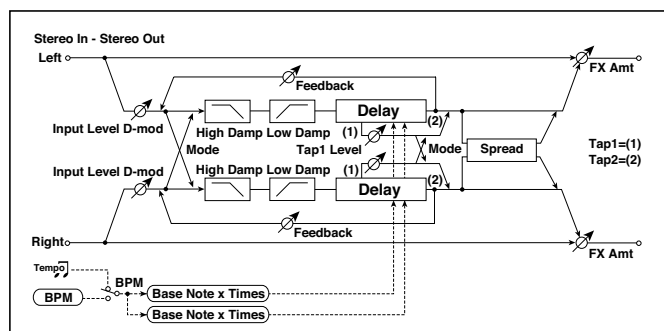





a	Mode	Normal, Cross Feedback, Cross Pan1, Cross Pan2	Switches the left and right delay routing	
b	BPM	MIDI, 40.00... 300.00	MIDI syncs to the system tempo; 40-300 sets the tempo manually for this individual effect	
	Time Over? 1	---, OVER!	Displays an error message when the delay time for Tap1 exceeds the upper limit	
	2	---, OVER!	Displays an error message when the delay time for Tap2 exceeds the upper limit	
c	Tap 1 Base Note		Selects the type of notes to specify the delay time for Tap1	
	Times	x1...x32	Sets the number of notes to specify the delay time for Tap1	
d	Tap 2 Base Note		Selects the type of notes to specify the delay time for Tap2	
	Times	x1...x32	Sets the number of notes to specify the delay time for Tap2	
e	Tap1 Level	0...100	Sets the Tap1 output level	
f	Feedback (Tap2)	-100...+100	Sets the Tap2 feedback amount	
	Src	Off...Tempo	Selects the modulation source of the Tap2 feedback amount	
	Amt	-100...+100	Sets the modulation amount of the Tap2 feedback amount	



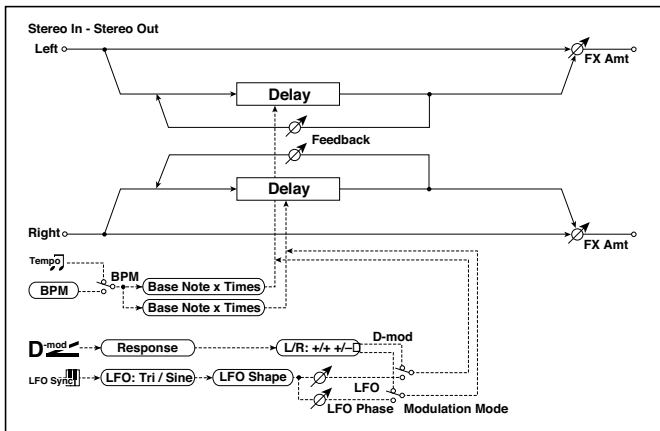

g	High Damp [%]	0...100	Sets the damping amount in the high range
	Low Damp [%]	0...100	Sets the damping amount in the low range
h	Input Level Dmod [%]	-100...+100	Sets the modulation amount of the input level
	Src	Off...Tempo	Selects the modulation source for the input level
i	Spread	-100...+100	Sets the width of the stereo image of the effect sound
	Src	Off...Tempo	Selects the modulation source of the effect sound's stereo image width
	Amt	-100...+100	Sets the modulation amount of the effect sound's stereo image width
j	Wet/Dry	Dry, 1:99...99:1, Wet	Balance between the wet and dry signal
	Src	Off...Tempo	See DMS (Dynamic Modulation Source)
	Amt	-100...+100	Amount of modulation source

St.BPM Mod. Delay (Stereo BPM Modulation Delay)

This is a stereo modulation delay that lets you synchronize the delay time to the tempo of the song.



a	Modulation Mode	LFO, D-mod	Switches between LFO modulation control and modulation source control	
b	D-mod Modulation	L/R:+/+, L/R:+/-	Reversed L/R control by modulation source	
	Src	Off...Tempo	Selects the modulation source that controls delay time	
	Response	0...30	Sets the rate of response to the modulation source	
c	LFO Waveform	Triangle, Sine	Selects the LFO Waveform	
	LFO Shape	-100...+100	Changes the curvature of the LFO Waveform	
d	LFO Sync	Off, On	Switches LFO reset off/on	
	Src	Off...Tempo	Selects the modulation source that resets the LFO	
e	LFO Frequency [Hz]	0.02...20.00	Sets the speed of the LFO	
f	MIDI Sync	Off, On	When this is on, the LFO speed is set by BPM, Base Note, and Times, instead of Frequency	
	BPM	MIDI, 40.00... 300.00	MIDI syncs to the system tempo; 40-300 sets the tempo manually for this individual effect	
	Base Note		Selects the type of notes that specify the LFO speed	
	Times	x1...x32	Sets the number of notes that specify the LFO speed	
g	L LFO Phase [deg]	-180...+180	Sets the phase obtained when the left LFO is reset	
	Depth	0...200	Sets the depth of the left LFO modulation	
h	R LFO Phase [deg]	-180...+180	Sets the phase obtained when the right LFO is reset	
	Depth	0...200	Sets the depth of the right LFO modulation	
i	BPM(Delay)	MIDI, 40.00... 300.00	MIDI syncs to the system tempo; 40-300 sets the tempo manually for this individual effect	
	Time Over? L	---, OVER!	Display the error message if the left channel delay time exceeds the upper limit	
	R	---, OVER!	Display the error message if the right channel delay time exceeds the upper limit	

j	L Delay Base Note		Selects the type of notes to specify the left channel delay time	
	Times	x1...x32	Sets the number of notes to specify the left channel delay time	
	Feedback	-100...+100	Sets the feedback amount of left delay	
k	R Delay Base Note		Selects the type of notes to specify the right channel delay time	
	Times	x1...x32	Sets the number of notes to specify the right channel delay time	
	Feedback	-100...+100	Sets the feedback amount of right delay	
l	Wet/Dry	-Wet, -1:99... Dry...99:1, Wet	Balance between the wet and dry signal	
	Src	Off...Tempo	See DMS (Dynamic Modulation Source)	
	Amt	-100...+100	Amount of modulation source	

i: Time Over? L, R



You can set the delay time up to 2,550msec. If the delay time exceeds this limit, the error message "OVER!" appears in the display. Set the delay time parameters so that this message will not appear. "Time Over?" is only a display parameter.

St.BPMAutoPanDly (Stereo BPM Auto Panning Delay)

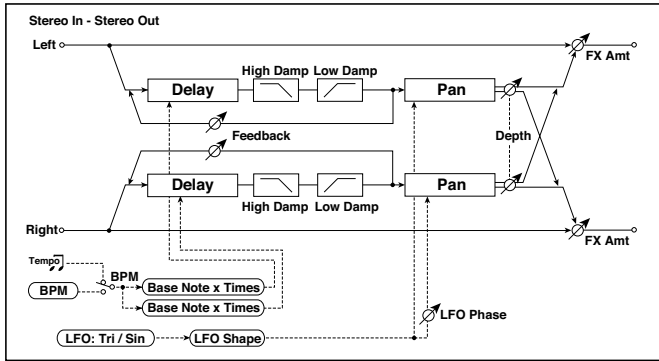
This stereo auto panning delay enables you to set the delay time to match the song tempo.



a	BPM	MIDI, 40.00... 300.00	MIDI syncs to the system tempo; 40-300 sets the tempo manually for this individual effect	
	Time Over? L	---, OVER!	Display the error message if the left channel delay time exceeds the upper limit	
	R	---, OVER!	Display the error message if the right channel delay time exceeds the upper limit	
b	L Delay Base Note		Selects the type of notes to specify the left channel delay time	
	Times	x1...x32	Sets the number of notes to specify the left channel delay time	
	Feedback	-100...+100	Sets the feedback amount for the left channel	
c	R Delay Base Note		Selects the type of notes to specify the right channel delay time	
	Times	x1...x32	Sets the number of notes to specify the right channel delay time	
	Feedback	-100...+100	Sets the feedback amount for the right channel	
d	High Damp [%]	0...100	Sets the damping amount in the high range	
	Low Damp [%]	0...100	Sets the damping amount in the low range	
e	LFO Waveform	Triangle, Sine	Selects the LFO Waveform	
	Shape	-100...+100	Changes the curvature of the LFO Waveform	
	LFO Phase	-180...+180	Sets the LFO phase difference between the left and right	

f	Panning Freq [Hz]	0.02...20.00	Sets the panning speed	
g	MIDI Sync	Off, On	When this is on, the pan LFO speed is set by BPM, Base Note, and Times, instead of Frequency	
	BPM	MIDI, 40.00...300.00	MIDI syncs to the system tempo; 40-300 sets the tempo manually for this individual effect	
	Base Note		Selects the type of notes to specify the delay time for the panning speed	
	Times	x1...x32	Sets the number of notes to specify the delay time for the panning speed	
h	Panning Depth	0...100	Sets the panning width	
	Src	Off...Tempo	Selects the modulation source for the panning width	
	Amt	-100...+100	Set the modulation amount of the panning width	
i	Wet/Dry	Dry, 1:99...99:1, Wet	Balance between the wet and dry signal	
	Src	Off...Tempo	See DMS (Dynamic Modulation Source)	
	Amt	-100...+100	Amount of modulation source	

Tape Echo BPM

This is a tape echo that lets you synchronize the delay time to the tempo of the song.

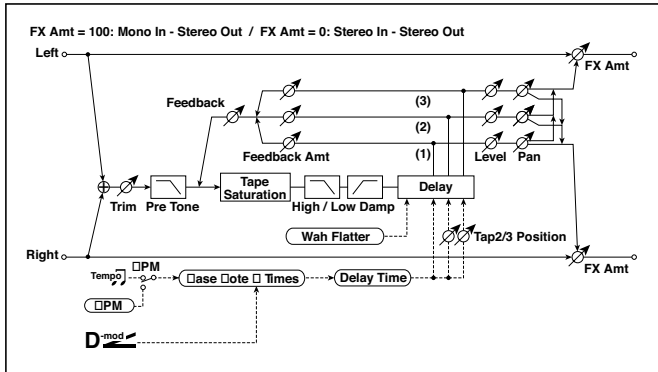

a	BPM (Delay)	MIDI, 40.00... 300.00	MIDI syncs to the system tempo; 40-300 sets the tempo manually for this individual effect	
	Tap1 Dmod Src	Off...Tempo	Selects the modulation source of the delay time	
b	Tap1 Delay Note		Selects the type of notes to specify the delay time (tap1)	
	Times	x1...x32	Sets the number of notes to specify the delay time (tap1)	
	Time Over?	---, OVER!	Displays an error message when the delay time exceeds the upper limit	
c	Tap1 Dmod Note		Selects the note value used to specify the delay time when the modulation is at maximum	
	Times	x1...x32	Specifies the number of notes used to specify the delay time when the modulation is at maximum	
d	Tap2 Position [%]	0...100	Sets the position of Tap 2 relative to the Tap 1 delay time the depth of pitch variation	
e	Tap3 Position [%]	0...100	Sets the position of Tap 3 relative to the Tap 1 delay time the depth of pitch variation	
f	Tap1 Level	0...100	Sets the Tap1 output level	
	Pan	L, 1...99, R	Sets the stereo image of tap1	
	FB Amt	-100...+100	Sets the Tap1 feedback amount	

g	Tap2 Level	0...100	Sets the Tap2 output level	
	Pan	L, 1...99, R	Sets the stereo image of tap2	
	FB Amt	-100...+100	Sets the Tap2 feedback amount	
h	Tap3 Level	0...100	Sets the Tap3 output level	
	Pan	L, 1...99, R	Sets the stereo image of tap3	
	FB Amt	-100...+100	Sets the Tap3 feedback amount	
i	Feedback	0...100	Sets the amount of feedback for Taps 1, 2, and 3	
	Src	Off...Tempo	Selects the modulation source of feedback amount	
	Amt	-100...+100	Sets the depth by which feedback amount will be modulated	
j	High Damp [%]	0...100	Sets the damping amount in the high range	
	Low Damp [%]	0...100	Sets the damping amount in the low range	
k	Saturation	0...100	Sets the distortion amount	
l	Input Trim	0...100	Sets the input gain	
	Pre Tone	0...100	Sets the tone of the input	
m	Wow Flutter [Hz]	0.02...1.00	Sets the frequency at which pitch variation will occur	
	Wow Flutter depth	0...100	Sets the depth of pitch variation	
n	Wet/Dry	Dry, 1:99...99:1, Wet	Balance between the wet and dry signal	
	Src	Off...Tempo	See DMS (Dynamic Modulation Source)	
	Amt	-100...+100	Amount of modulation source	

a: Tap1 Dmod Src

b: Tap1 Delay Note

b: Times

c: Tap1 Dmod Note

c: Times

If “Tap1 Dmod Src” is Off or the selected modulation is at 0, the delay time will be the length specified by “Tap1 Delay Note” and “Times.”

If “Tap1 Dmod Src” is other than Off, the delay time will change so that it will be as specified by “Tap1 Dmod Note” and “Times” when the maximum modulation is reached.

b: Time Over?

You can set the delay time up to 5,400msec. If the delay time exceeds this limit, the error message "OVER!" appears in the display. Set the delay time parameters so that this message will not appear. "Time Over?" is only a display parameter.

Classic Tape Echo

This models a famous analog tape echo unit. On the original device, "echo" was created by a playback head, and the "delay time" was specified by adjusting the speed of the motor. The warmth and subtlety of the echoes it generated made this "lo-fi" unit a favorite with many pro musicians.

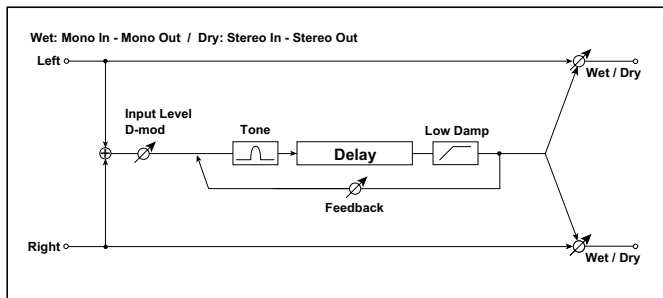



a	Time	0...2700	This parameter sets the delay time.	
	Src	Off...Tempo	Selects the modulation source of Time	
	Amt	-100...+100	Sets the depth by which Time will be modulated	
b	Feedback	0...100	Sets the amount of feedback	
	Src	Off...Tempo	Selects the modulation source of feedback amount	
	Amt	-100...+100	Sets the depth by which feedback amount will be modulated	
c	Tone	0...99	<p>Sets the tone of the input.</p> <p>This models the reduced high frequencies of an analog tape delay, before the saturation stage. Lower settings create a darker tone.</p> <p>This cuts the high frequencies in both the main output and the feedback. Higher settings create a brighter tone.</p>	

d	Low Damp [%]	0...100	Sets the damping amount in the low range	
e	Input Level Dmod	-100...+100	Amount of input level modulation	
	Src	Off...Tempo	Selects the modulation source of Input Level Dmod. See DMS (Dynamic Modulation Source)	
f	Wet/Dry	Dry, 1:99...99:1, Wet	Balance between the wet and dry signal	
	Src	Off...Tempo	See DMS (Dynamic Modulation Source)	
	Amt	-100...+100	Amount of modulation source	

Hold Delay

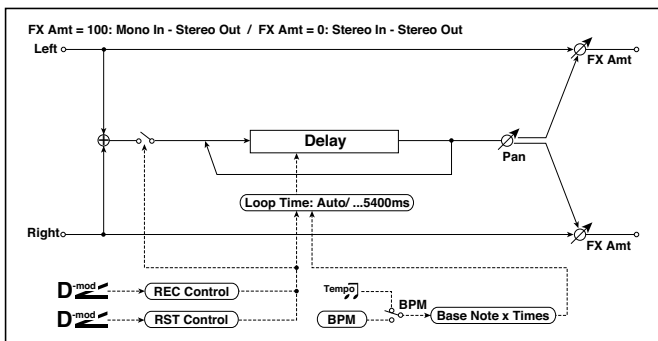
This effect records the input signal and plays it back repeatedly. You can control the start of recording and reset via a modulation source. Easy to use for real-time performances.



a	Loop Time [msec]	Auto, 1...10800	Sets Automatic loop time setup mode or specifies loop time	
b	Loop BPM Sync	Off, On	Specifies whether delay time is set in milliseconds, or as a note value relative to tempo	
c	BPM	MIDI, 40.00... 300.00	MIDI syncs to the system tempo; 40-300 sets the tempo manually for this individual effect	
	Time Over?	---, OVER!	An error indication that appears if delay time exceeds the upper limit when MIDI/Tempo Sync=On	

d	Loop Base Note		Selects the type of notes to specify the delay time
	Times	x1...x32	Sets the number of notes to specify the delay time
e	REC Control Src	Off...Tempo	Selects control source for recording
f	RST Control Src	Off...Tempo	Selects control source for reset
g	Manual REC Control	REC Off, REC On	Sets the recording switch
h	Manual RST Control	Off, RESET	Sets the reset switch
i	Pan	L100...L1, C, R1... R100	Sets the stereo image of the effect
	Src	Off...Tempo	Selects the modulation source of stereo image of the effect
	Amt	-100...+100	Sets the modulation amount of stereo image of the effect
j	Wet/Dry	Dry, 1:99...99:1, Wet	Balance between the wet and dry signal
	Src	Off...Tempo	See DMS (Dynamic Modulation Source)
	Amt	-100...+100	Amount of modulation source

a: Loop Time [msec]

With Auto, the loop time is automatically set. Otherwise, you can specify the loop time.

When Auto is selected, the Loop Time is automatically set to the time it takes for a performance recorded while the Modulation Source or “Manual REC Control” is on. However, if the time length exceeds 10,800msec, the loop time will be automatically set to 10,800msec.

c: Time Over?

You can set the delay time up to 10,800msec. If the delay time exceeds this limit, the error message “OVER!” appears in the display. Set the delay time parameters so that this message will not appear. “Time Over?” is only a display parameter.

b: Loop BPM Sync

c: BPM

d: Loop Base Note

d: Times

If "Loop BPM Sync" is on, the "Times" setting is ignored; the loop time is determined by "BPM," "Loop Base Note," and "Times." Even in this case, the delay time cannot exceed 10,800 msec.

"Hold" procedure (when Loop Time = Auto)

1 "Rec Src"JS +Y: #01

"Reset Src"JS -Y: #02

"Manual REC Control"REC Off

"Manual RST Control"RESET

"Loop Time [msec]"Auto

"MIDI/Tempo Sync"Off

It should be noted that all recordings will be deleted while Reset is On.

2 "Manual RST Control"Off

Reset is cancelled and the unit enters Rec ready mode.

3 Push the joystick in the +Y direction (forward) and play a phrase you wish to hold. When you pull the joystick to its original position, the recording will be finished and the phrase you just played will be held.

Loop Time is automatically set only for the first recording after resetting. If the time length exceeds 10,800msec, Loop Time will be automatically set to 10,800msec. (If you have set "Times" to 1-10,800msec, the specified loop time will be used regardless of the time taken from pushing the joystick forward until it is pulled back. However, the recording method remains the same. The phrase being played while the joystick is pushed forward will be held.)

4 If you made a mistake during recording, pull the joystick in the -Y direction (back) to reset. In this way, the recording will be erased. Repeat step 4. again.

5 The recorded phrase will be repeated again and again. You can use this to create an accompaniment.

6 By pushing the joystick in the +Y direction (forward), you can also overdub performances over the phrase that is being held.

e: REC Control Src

g: Manual REC Control

“REC Control Src” selects the modulation source that controls recording.

If this modulation is on, or if “Manual REC Control” is set to On, you can record the input signal. If a recording has already been carried out, additional signals will be overdubbed.

MIDI The effect is off when a value for the modulation source specified for the “REC Control Src” parameter is 63 or smaller, and the effect is on when the value is 64 or higher.

f: RST Control Src

h: Manual RST Control

The “RST Control Src” parameter specifies the modulation source that controls the reset operation.

When you set this modulation source to On, or “Manual RST Control” to RE-SET, you can erase what you recorded. If the Loop Time parameter has been set to Auto, the loop time is also reset.

MIDI The effect is off when a value for the modulation source specified for the “RST Control Src” parameter is 63 or smaller, and the effect is on when the value is 64 or higher.

L/C/R Long Delay

This multitap delay outputs three Tap signals to left, right and center respectively. You can set a maximum of 5,460msec for the delay time.

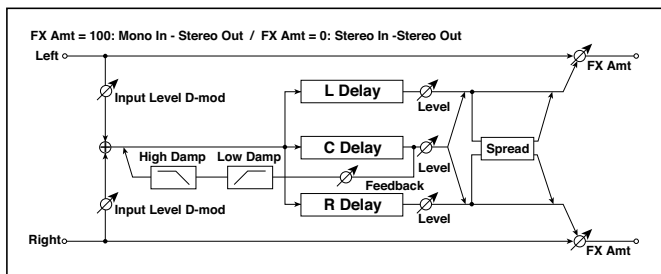

a	L Delay Time [msec]	0...5460	Sets the delay time of TapL
	Level	0...50	Sets the output level of TapL

b	C Delay Time [msec]	0...5460	Sets the delay time of TapC	
	Level	0...50	Sets the output level of TapC	
c	R Delay Time [msec]	0...5460	Sets the delay time of TapR	
	Level	0...50	Sets the output level of TapR	
d	Feedback (C Delay)	-100...+100	Sets the feedback amount of TapC	
	Src	Off...Tempo	Selects the modulation source for the TapC feedback	
	Amt	-100...+100	Sets the modulation amount of the TapC feedback	
e	High Damp [%]	0...100	Sets the damping amount in the high range	
	Low Damp [%]	0...100	Sets the damping amount in the low range	
f	Input Level Dmod [%]	-100...+100	Sets the modulation amount of the input level	
	Src	Off...Tempo	Selects the modulation source for the input level	
g	Spread	0...50	Sets the width of the stereo image of the effect sound	
h	Wet/Dry	Dry, 1:99...99:1, Wet	Balance between the wet and dry signal	
	Src	Off...Tempo	See DMS (Dynamic Modulation Source)	
	Amt	-100...+100	Amount of modulation source	

St/Cross Long Delay (Stereo/Cross Long Delay)

This is a stereo delay, and can be used as a cross-feedback delay effect in which the delay sounds cross over between left and right by changing the feedback routing. You can set a maximum of 2,730msec for the delay time.

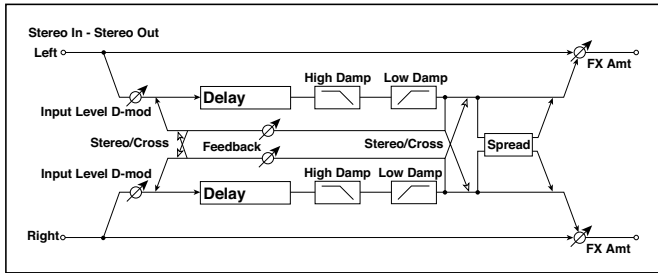

a	Stereo/Cross	Stereo, Cross	Switches between stereo delay and cross-feedback delay
b	L Delay Time [msec]	0.0...2730.0	Sets the delay time for the left channel
c	R Delay Time [msec]	0.0...2730.0	Sets the delay time for the right channel
d	L Feedback	-100...+100	Sets the feedback amount for the left channel
	Src	Off...Tempo	Selects the modulation source of feedback amount
	Amt	-100...+100	Sets the modulation amount of the left channel feedback
e	R Feedback	-100...+100	Sets the feedback amount for the right channel
	Amt	-100...+100	Sets the modulation amount of the right channel feedback
f	High Damp [%]	0...100	Sets the damping amount in the high range
g	Low Damp [%]	0...100	Sets the damping amount in the low range
h	Input Level Dmod [%]	-100...+100	Sets the modulation amount of the input level
	Src	Off...Tempo	Selects the modulation source for the input level
i	Spread	-50...+50	Sets the width of the stereo image of the effect sound

j	Wet/Dry	Dry, 1:99...99:1, Wet	Balance between the wet and dry signal
	Src	Off...Tempo	See DMS (Dynamic Modulation Source)
	Amt	-100...+100	Amount of modulation source

LCR BPM Long Diy

The L/C/R delay enables you to match the delay time with the song tempo.

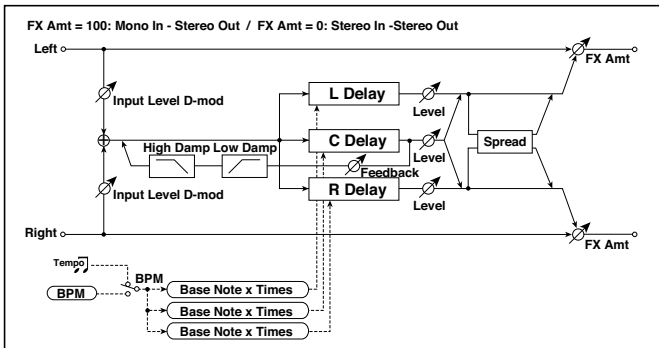

a	BPM	MIDI, 40.00... 300.00	MIDI syncs to the system tempo; 40-300 sets the tempo manually for this individual effect	
	Time Over?	---, OVER!	Displays an error message when the delay time exceeds the upper limit	
b	L Delay Base Note		Selects the type of notes to specify the delay time for TapL	
	Times	x1...x32	Sets the number of notes to specify the delay time for TapL	
	Level	0...50	Sets the output level of TapL	
c	C Delay Base Note		Selects the type of notes to specify the delay time for TapC	
	Times	x1...x32	Sets the number of notes to specify the delay time for TapC	
	Level	0...50	Sets the output level of TapC	
d	R Delay Base Note		Selects the type of notes to specify the delay time for TapR	
	Times	x1...x32	Sets the number of notes to specify the delay time for TapR	
	Level	0...50	Sets the output level of TapR	

e	Feedback (C Delay)	-100...+100	Sets the feedback amount of TapC	
	Src	Off...Tempo	Selects the modulation source for the TapC feedback	
	Amt	-100...+100	Sets the modulation amount of the TapC feedback	
f	High Damp [%]	0...100	Sets the damping amount in the high range	
	Low Damp [%]	0...100	Sets the damping amount in the low range	
g	Input Level Dmod [%]	-100...+100	Sets the modulation amount of the input level	
	Src	Off...Tempo	Selects the modulation source for the input level	
h	Spread	0...50	Sets the width of the stereo image of the effect sound	
i	Wet/Dry	Dry, 1:99...99:1, Wet	Balance between the wet and dry signal	
	Src	Off...Tempo	See DMS (Dynamic Modulation Source)	
	Amt	-100...+100	Amount of modulation source	

a: Time Over?

You can set the delay time up to 10,920msec. If the delay time exceeds this limit, the error message "OVER!" appears in the display. Set the delay time parameters so that this message will not appear. "Time Over?" is only a display parameter.

St. BPM Long Dly (Stereo BPM Long Delay)

The stereo delay enables you to match the delay time with the song tempo.

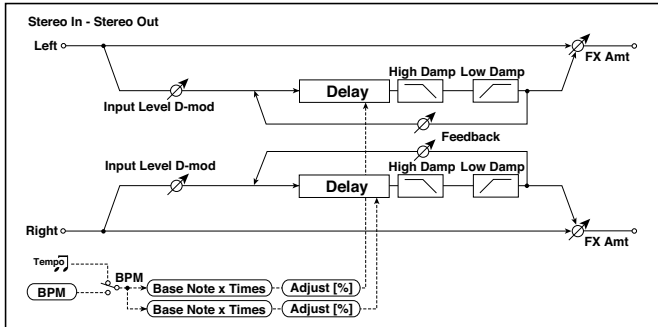

a	BPM	MIDI, 40.00... 300.00	MIDI syncs to the system tempo; 40-300 sets the tempo manually for this individual effect	
	Time Over? L	---, OVER!	Display the error message if the left channel delay time exceeds the upper limit	
	R	---, OVER!	Display the error message if the right channel delay time exceeds the upper limit	
b	L Delay Base Note		Selects the type of notes to specify the left channel delay time	
	Times	x1...x32	Sets the number of notes to specify the left channel delay time	
	Adjust [%]	-2.50...+2.50	Fine-adjust the left channel delay time	
c	R Delay Base Note		Selects the type of notes to specify the right channel delay time	
	Times	x1...x32	Sets the number of notes to specify the right channel delay time	
	Adjust [%]	-2.50...+2.50	Fine-adjust the right channel delay time	
d	L Feedback	-100...+100	Sets the feedback amount for the left channel	
	Src	Off...Tempo	Selects the modulation source of feedback amount	
	L Amt	-100...+100	Sets the modulation amount of the left channel feedback	

e	R Feedback	-100...+100	Sets the feedback amount for the right channel
	R Amt	-100...+100	Sets the modulation amount of the right channel feedback
f	High Damp [%]	0...100	Sets the damping amount in the high range
g	Low Damp [%]	0...100	Sets the damping amount in the low range
h	Input Level Dmod [%]	-100...+100	Sets the modulation amount of the input level
	Src	Off...Tempo	Selects the modulation source for the input level
i	Wet/Dry	Dry, 1:99...99:1, Wet	Balance between the wet and dry signal
	Src	Off...Tempo	See DMS (Dynamic Modulation Source)
	Amt	-100...+100	Amount of modulation source

a: Time Over? L, R



You can set the delay time up to 5,460msec. If the delay time exceeds this limit, the error message "OVER!" appears in the display. Set the delay time parameters so that this message will not appear. "Time Over?" is only a display parameter.

MOD (Modulation)

Stereo Chorus

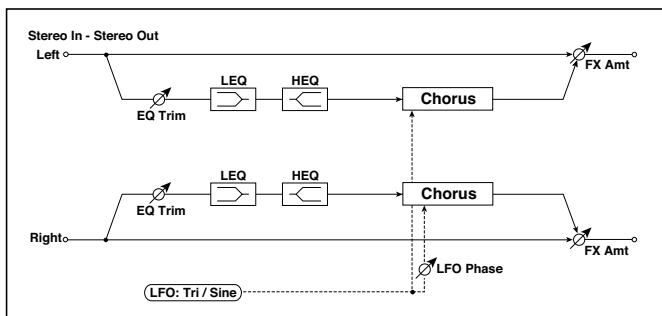
This effect adds thickness and warmth to the sound by modulating the delay time of the input signal. You can add spread to the sound by offsetting the phase of the left and right LFOs from each other.



a	LFO Waveform	Triangle, Sine	Selects the LFO Waveform	
	LFO Phase [degree]	-180...+180	Sets the LFO phase difference between the left and right	
b	LFO Frequency [Hz]	0.02...20.00	Sets the speed of the LFO	
	Src	Off...Tempo	Selects a modulation source for LFO speed	
	Amt	-20.00...+20.00	Sets the modulation amount of LFO speed	
c	MIDI Sync	Off, On	When this is on, the LFO speed is set by  BPM, Base Note, and Times, instead of Frequency	
	BPM	MIDI, 40.00...300.00	MIDI syncs to the system tempo; 40-300 sets the tempo manually for this individual effect	
	Base Note		Selects the type of notes that specify the LFO speed	
	Times	x1...x32	Sets the number of notes that specify the LFO speed	
d	L Pre Delay [msec]	0.0...50.0	Sets the delay time for the left channel	
	R Pre Delay [msec]	0.0...50.0	Sets the delay time for the right channel	

e	Depth	0...100	Sets the depth of LFO modulation
	Src	Off...Tempo	Selects the modulation source for the LFO modulation depth
	Amt	-100...+100	Sets the modulation amount of the LFO modulation depth
f	EQ Trim	0...100	Sets the EQ input level
g	Pre LEQ Fc	Low, Mid-Low	Selects the cutoff frequency (low or mid-low) of the low-range equalizer
	Pre HEQ Fc	High, Mid-High	Selects the cutoff frequency (high or mid-high) of the high-range equalizer
h	Pre LEQ Gain [dB]	-15.0...+15.0	Gain of the Low EQ
	Pre HEQ Gain [dB]	-15.0...+15.0	Gain of the High EQ
i	Wet/Dry	-Wet, -1:99... Dry...99:1, Wet	Balance between the wet and dry signal
	Src	Off...Tempo	See DMS (Dynamic Modulation Source)
	Amt	-100...+100	Amount of modulation source

d: L Pre Delay [msec]

d: R Pre Delay [msec]

Setting the left and right delay time individually allows you to control the stereo image.

Black Chorus/Flanger

This models a Danish-made stereo chorus + pitch modulator & flanger. Although this effect was originally intended for guitar, it was also used by numerous keyboard players. Used with electric piano, it produces a distinctive tone.

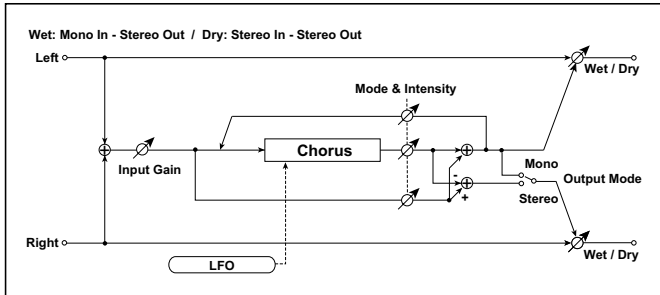

a	Speed [Hz]	0.10...10.0	Sets the LFO speed	
	Src	Off...Tempo	Modulation for the LFO speed. See DMS (Dynamic Modulation Source)	
	Amt	-10.00... +10.00	Sets the modulation amount of the LFO speed	
	Intensity	1...100	Sets the intensity of LFO modulation	
b	Mode	0, 1, 2	Select a mode 0: Chorus 1: Pitch Modulation 2: Flanger	
c	Width	0...2	Sets the LFO modulation depth	
d	Input Gain	1...100	Sets the input gain	
e	Output Mode	0, 1	Select a output mode 0: Mono 1: Stereo	
f	Wet/Dry	Dry, 1:99 ... 99:1, Wet	Balance between the wet and dry signal	
	Source	Off...Tempo	Selects a modulation source for Wet/Dry	
	Amount	-100 ... +100	Sets the modulation amount for Wet/Dry	

a: Intensity



b: Mode

Increasing the “Intensity” value will strengthen the modulation effect. This controls the effect, direct, and feedback values. The values that are controlled will depend on the “Mode” setting.

St.HarmonicChorus (Stereo Harmonic Chorus)

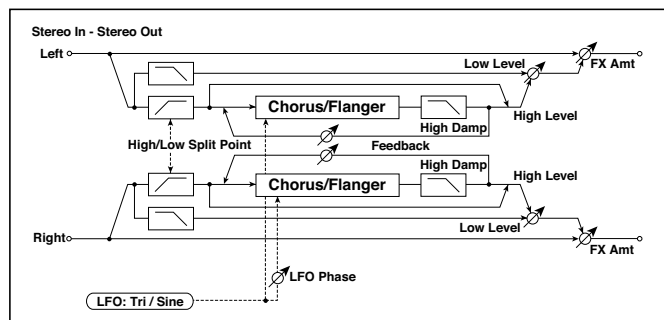
This effect applies chorus only to higher frequencies. This can be used to apply a chorus effect to a bass sound without making the sound thinner. You can also use this chorus block with feedback as a flanger.



a	LFO Waveform	Triangle, Sine	Selects the LFO Waveform	
	LFO Phase [degree]	-180...+180	Sets the LFO phase difference between the left and right	
b	LFO Frequency [Hz]	0.02...20.00	Sets the speed of the LFO	
	Src	Off...Tempo	Selects a modulation source for LFO speed	
	Amt	-20.00...+20.00	Sets the modulation amount of LFO speed	
c	MIDI Sync	Off, On	When this is on, the LFO speed is set by BPM, Base Note, and Times, instead of Frequency	
	BPM	MIDI, 40.00...300.00	MIDI syncs to the system tempo; 40-300 sets the tempo manually for this individual effect	
	Base Note		Selects the type of notes that specify the LFO speed	
	Times	x1...x32	Sets the number of notes that specify the LFO speed	
d	Pre Delay [msec]	0.0...50.0	Sets the delay time from the original sound	
e	Depth	0...100	Sets the depth of LFO modulation	
	Src	Off...Tempo	Selects the modulation source of the LFO modulation depth	
	Amt	-100...+100	Sets the modulation amount of the LFO modulation depth	
f	High/Low Split Point	1...100	Sets the frequency split point between the low and high range	

g	Feedback	-100...+100	Sets the feed back amount of the chorus block
	High Damp [%]	0...100	Sets the high range damping amount of the chorus block
h	Low Level	0...100	Sets the low range output level
	High Level	0...100	Sets the high range (chorus) output level
i	Wet/Dry	Dry, 1:99...99:1, Wet	Balance between the wet and dry signal
	Src	Off...Tempo	See DMS (Dynamic Modulation Source)
	Amt	-100...+100	Amount of modulation source

f: High/Low Split Point

This parameter sets the frequency that splits the high and low range. Only the high range will be sent to the chorus block.

g: Feedback

Sets the feedback amount of the chorus block. Increasing the feedback will allow you to use the effect as a flanger.

Classic Chorus

This models a famous chorus unit that was built into a guitar amp. Although it does not provide a chorus and vibrato select switch, you can use the “Wet/Dry” and “Bus” settings to produce their effect. The “Speed,” “Depth,” and “Manual” parameters allow an even wider range of sounds than the original unit.

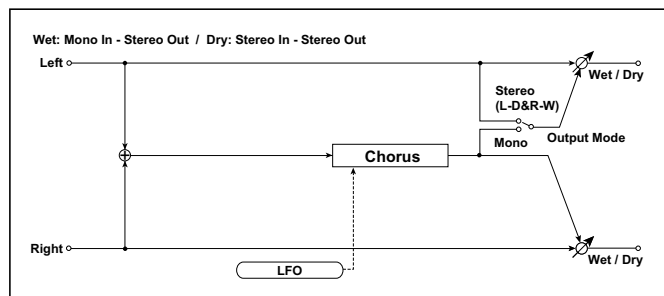

a	Speed [Hz]	0.10...10.0	Sets the LFO speed	
	Src	Off...Tempo	Modulation for the chorus speed. See DMS (Dynamic Modulation Source)	
	Amt	-10.00... +10.00	Sets the modulation amount of the chorus speed	
b	Depth	1...100	Sets the depth of LFO modulation	
	Src	Off...Tempo	Modulation for the chorus depth. See DMS (Dynamic Modulation Source)	
	Amt	-100 ... +100	Sets the modulation amount of the chorus depth	
c	Manual	0...99	Sets the delay time for chorus. If Depth is set to 100, Manual will not function.	
d	Output Mode	Mono, Stereo (L-Dry&R-Wet)	The output mode switches between vibrato and chorus. Mono is a vibrato, Stereo is a chorus.	
e	Wet/Dry	Dry, 1:99 ... 99:1, Wet	Balance between the wet and dry signal	
	Src	Off...Tempo	Selects a modulation source for Wet/Dry	
	Amount	-100 ... +100	Sets the modulation amount for Wet/Dry	

Multitap Cho/Delay (Multitap Chorus/Delay)

This effect has four chorus blocks with a different LFO phase. You can create a complex stereo image by setting each block's delay time, depth, output level, and pan individually. You can also fix some of the chorus blocks to combine the chorus and delay effects.

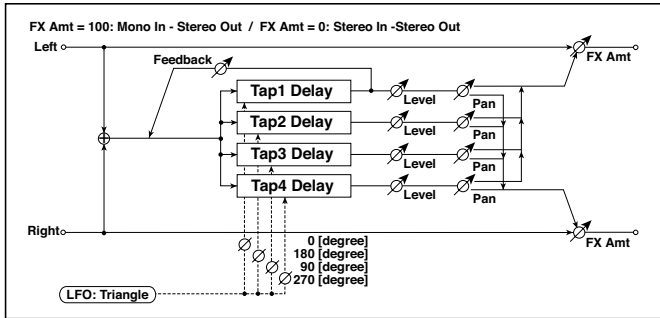



a	LFO Frequency [Hz]	0.02...13.00	Sets the speed of the LFO
b	Tap1 (000) [msec]	0...1000	Sets the Tap1 (LFO phase=0 degrees) delay time
	Depth	0...30	Sets the Tap1 chorus depth
	Level	0...30	Sets the Tap1 output level
	Pan	L6...L1, C, R1...R6	Sets the Tap1 stereo image
c	Tap2 (180) [msec]	0...1000	Sets the Tap2 (LFO phase=180 degrees) delay time
	Depth	0...30	Sets the Tap2 chorus depth
	Level	0...30	Sets the Tap2 output level
	Pan	L6...L1, C, R1...R6	Sets the Tap2 stereo image
d	Tap3 (090) [msec]	0...1000	Sets the Tap3 (LFO phase=90 degrees) delay time
	Depth	0...30	Sets the Tap3 chorus depth
	Level	0...30	Sets the Tap3 output level
	Pan	L6...L1, C, R1...R6	Sets the Tap3 stereo image

e	Tap4 (270) [msec]	0...1000	Sets the Tap4 (LFO phase=270 degrees) delay time
	Depth	0...30	Sets the Tap4 chorus depth
	Level	0...30	Sets the Tap4 output level
	Pan	L6...L1, C, R1... R6	Sets the Tap4 stereo image
f	Tap1 Feedback	-100...+100	Sets the Tap1 feedback amount
	Src	Off...Tempo	Selects the modulation source of Tap1 feedback amount and effect balance
	Amt	-100...+100	Sets the Tap1 feedback amount and modulation amount
g	Wet/Dry	Dry, 1:99...99:1, Wet	Balance between the wet and dry signal
	Src	Off...Tempo	See DMS (Dynamic Modulation Source)
	Amt	-100...+100	Amount of modulation source

Stereo Flanger

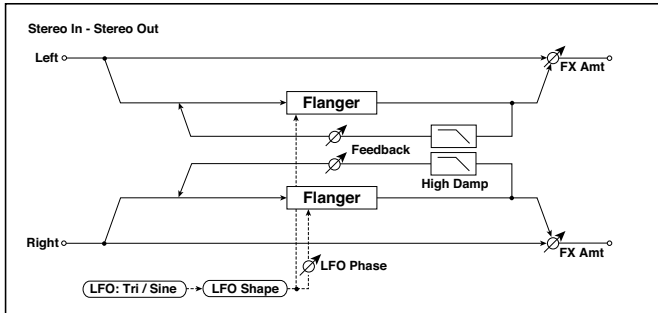
This effect gives a significant swell and movement of pitch to the sound. It is more effective when applied to a sound with a lot of harmonics. This is a stereo flanger. You can add spread to the sound by offsetting the phase of the left and right LFOs from each other.



a	Delay Time [msec]	0.0...50.0	Sets the delay time from the original sound	
b	LFO Waveform	Triangle, Sine	Selects the LFO Waveform	
	LFO Shape	-100...+100	Changes the curvature of the LFO Waveform	
c	LFO Phase [degree]	-180...+180	Sets the LFO phase difference between the left and right	
d	LFO Frequency [Hz]	0.02...20.00	Sets the speed of the LFO	
	Src	Off...Tempo	Selects a modulation source for LFO speed	
	Amt	-20.00...+20.00	Sets the modulation amount of LFO speed	
e	MIDI Sync	Off, On	When this is on, the LFO speed is set by BPM, Base Note, and Times, instead of Frequency	
	BPM	MIDI, 40.00...300.00	MIDI syncs to the system tempo; 40-300 sets the tempo manually for this individual effect	
	Base Note		Selects the type of notes that specify the LFO speed	
	Times	x1...x32	Sets the number of notes that specify the LFO speed	
f	Depth	0...100	Sets the depth of LFO modulation	

g	Feedback	-100...+100	Sets the feedback amount
	High Damp [%]	0...100	Sets the feedback damping amount in the high range
h	Wet/Dry	-Wet, -1:99... Dry...99:1, Wet	Balance between the wet and dry signal
	Src	Off...Tempo	See DMS (Dynamic Modulation Source)
	Amt	-100...+100	Amount of modulation source

g: Feedback

h: Wet/Dry

The peak shape of the positive and negative “Feedback” value is different. The harmonics will be emphasized when the effect sound is mixed with the dry sound if you set a positive value for both “Feedback” and “Wet/Dry”, and if you set a negative value for both “Feedback” and “Wet/Dry”.





g: High Damp [%]

This parameter sets the amount of damping of the feedback in the high range. Increasing the value will cut high-range harmonics.

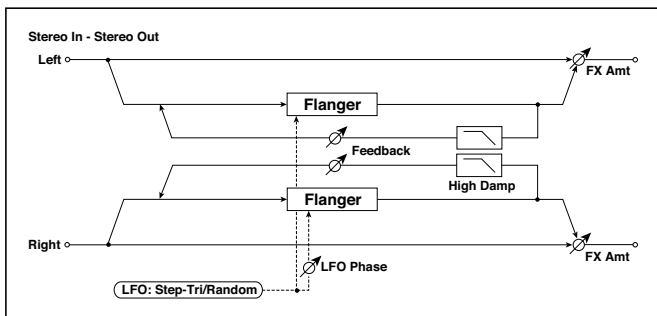
St. Random Flanger (Stereo Random Flanger)

The stereo effect uses a step-shape waveform and random LFO for modulation, creating a unique flanging effect.



a	Delay Time [msec]	0.0...50.0	Sets the delay time from the original sound	
b	LFO Waveform	Step-Tri, Random	Selects the LFO Waveform	
	LFO Phase [degree]	-180...+180	Sets the LFO phase difference between the left and right	
c	LFO Frequency [Hz]	0.02...20.00	Sets the speed of the LFO	
	Src	Off...Tempo	Selects the modulation source used for both LFO speed and step speed	
	Amt	-20.00... +20.00	Sets the modulation amount of LFO speed	
d	LFO Step Freq [Hz]	0.05...50.00	Sets the LFO step speed (speed that changes in steps)	
	Step Amt	-50.00... +50.00	Sets the modulation amount of LFO step speed	
e	MIDI Sync	Off, On	When this is on, the LFO speed is set by BPM, Base Note, and Times, instead of Frequency	
	BPM	MIDI, 40.00... 300.00	MIDI syncs to the system tempo; 40-300 sets the tempo manually for this individual effect	
	Base Note		Selects the type of notes that specify the LFO speed	
	Times	x1...x32	Sets the number of notes that specify the LFO speed	
f	Step Base Note		Selects the type of notes to specify the LFO step speed	
	Times	x1...x32	Sets the number of notes to specify the LFO step speed	
g	Depth	0...100	Sets the depth of LFO modulation	
h	Feedback	-100...+100	Sets the feedback amount	
	High Damp [%]	0...100	Sets the feedback damping amount in the high range	
i	Wet/Dry	-Wet, -1:99... Dry...99:1, Wet	Balance between the wet and dry signal	
	Src	Off...Tempo	See DMS (Dynamic Modulation Source)	
	Amt	-100...+100	Amount of modulation source	

St. Env. Flanger (Stereo Envelope Flanger)

This Flanger uses an envelope generator for modulation. You will obtain the same pattern of flanging each time you play. You can also control the Flanger directly using the modulation source.

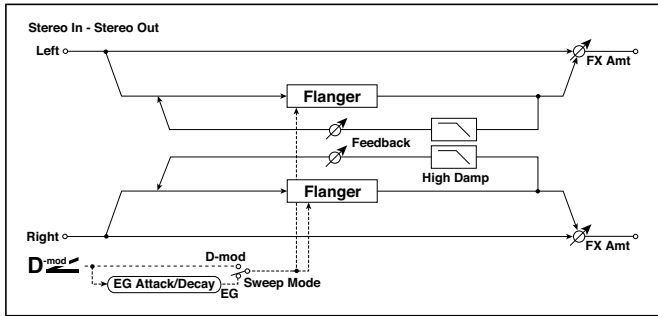

a	L Dly Bottom [msec]	0.0...50.0	Sets the lower limit of the left-channel delay time
	L Dly Top [msec]	0.0...50.0	Sets the upper limit of the left-channel delay time
b	R Dly Bottom [msec]	0.0...50.0	Sets the lower limit of the right-channel delay time
	R Dly Top [msec]	0.0...50.0	Sets the upper limit of the right-channel delay time
c	Sweep Mode	EG, D-mod	Determines whether the flanger is controlled by the envelope generator or by the modulation source
	Src	Off...Tempo	Selects the modulation source that triggers the EG (when Sweep Mode = EG), or the modulation source that causes the flanger to sweep (when Sweep Mode = D-mod)
d	EG Attack	1...100	Sets the EG attack speed
	EG Decay	1...100	Sets the EG decay speed
e	Feedback	-100...+100	Sets the feedback amount
f	High Damp [%]	0...100	Sets the feedback damping amount in the high range
g	Wet/Dry	-Wet, -1:99... Dry...99:1, Wet	Balance between the wet and dry signal
	Src	Off...Tempo	See DMS (Dynamic Modulation Source)
	Amt	-100...+100	Amount of modulation source

c: Sweep Mode**c: Src**

This parameter switches the flanger control mode. With “Sweep Mode” = EG, the flanger will sweep using the envelope generator. This envelope generator is included in the envelope flanger, and not related to the Pitch EG, Filter EG, or Amp EG.

The “Src” parameter selects the source that starts the envelope generator. If you select, for example, Gate, the envelope generator will start when the note-on message is received.

When “Sweep Mode” = D-mod, the modulation source can control the flanger directly. Select the modulation source using the “Src” parameter.

MIDI The effect is off when a value for the modulation source specified for the “Src” parameter is smaller than 64, and the effect is on when the value is 64 or higher. The Envelope Generator is triggered when the value changes from 63 or smaller to 64 or higher.

d: EG Attack**d: EG Decay**

Attack and Decay speed are the only adjustable parameters on this EG.

Classic Flanger

This models a classic analog flanger. It is highly effective for chording on clavi-type keyboards or electric piano.

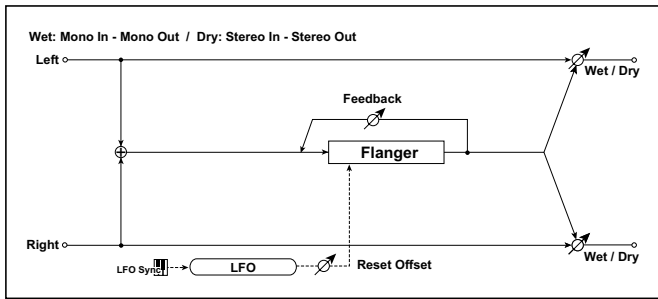



a	Speed [Hz]	0.10...10.0	Sets the speed of LFO
	Src	Off...Tempo	Selects a modulation source for LFO speed
	Amt	-10.00... +10.00	Sets the modulation amount of flanger speed
b	Depth	0...100	Sets the depth of flanger modulation
	Src	Off...Tempo	Selects the modulation source of the flanger modulation depth
	Amt	-100...+100	Sets the modulation amount of the LFO modulation depth
c	Resonance	0...100	Sets the resonance amount
d	Manual	0...100	Sets the sweep frequency. If Depth is set to 100, Manual will not function.
e	LFO Reset Src	Off...Tempo	Selects a modulation source for LFO reset
	Reset Offset	0...100	Sets the offset
f	Wet/Dry	-Wet, -1:99... Dry...99:1, Wet	Balance between the wet and dry signal
	Src	Off...Tempo	See DMS (Dynamic Modulation Source)
	Amt	-100...+100	Amount of modulation source

Stereo Phaser

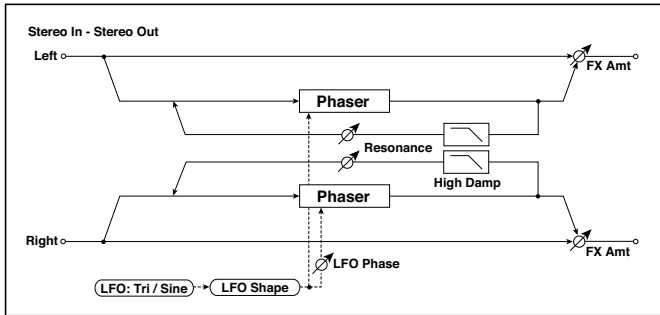
This effect creates a swell by shifting the phase. It is very effective on electric piano sounds. You can add spread to the sound by offsetting the phase of the left and right LFOs from each other.



a	LFO Waveform	Triangle, Sine	Selects the LFO Waveform	
	LFO Shape	-100...+100	Changes the curvature of the LFO Waveform	
b	LFO Phase [degree]	-180...+180	Sets the LFO phase difference between the left and right	
c	LFO Frequency [Hz]	0.02...20.00	Sets the speed of the LFO	
	Src	Off...Tempo	Selects a modulation source for LFO speed	
	Amt	-20.00...+20.00	Sets the modulation amount of LFO speed	
d	MIDI Sync	Off, On	When this is on, the LFO speed is set by BPM, Base Note, and Times, instead of Frequency	
	BPM	MIDI, 40.00...300.00	MIDI syncs to the system tempo; 40-300 sets the tempo manually for this individual effect	
	Base Note		Selects the type of notes that specify the LFO speed	
	Times	x1...x32	Sets the number of notes that specify the LFO speed	
e	Manual	0...100	Sets the frequency to which the effect is applied	
	Src	Off...Tempo	Selects the modulation source for the LFO modulation	
	Amt	-100...+100	Sets the modulation amount of the LFO modulation	

f	Depth	0...100	Sets the depth of LFO modulation
	Src	Off...Tempo	Selects the modulation source for the LFO modulation depth
	Amt	-100...+100	Sets the modulation amount of the LFO modulation depth
h	Resonance	-100...+100	Sets the resonance amount
	High Damp [%]	0...100	Sets the resonance damping amount in the high range
j	Wet/Dry	-Wet, -1:99... Dry...99:1, Wet	Balance between the wet and dry signal
	Src	Off...Tempo	See DMS (Dynamic Modulation Source)
	Amt	-100...+100	Amount of modulation source

h: Resonance

i: Wet/Dry

The peak shape of the positive and negative Feedback value is different. The harmonics will be emphasized when the effect sound is mixed with the dry sound, if you set a positive value for both "Resonance" and "Wet/Dry", and if you set a negative value for both "Resonance" and "Wet/Dry".





h: High Damp [%]

This parameter sets the amount of damping of the resonance in the high range. Increasing the value will cut high-range harmonics.

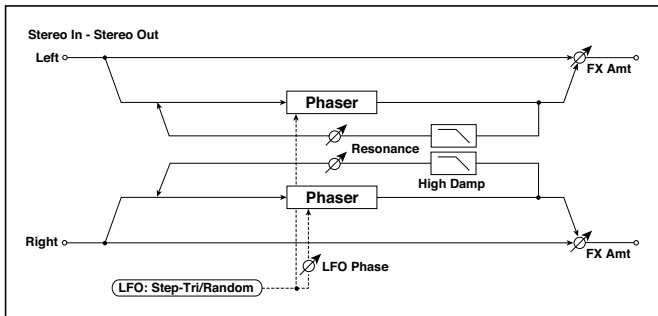
St. Random Phaser (Stereo Random Phaser)

This is a stereo phaser. The effect uses a step-shape waveform and random LFO for modulation, creating a unique phasing effect.



a	LFO Waveform	Step-Tri, Step-Sin, Random	Selects the LFO Waveform	
	LFO Phase [degree]	-180...+180	Sets the LFO phase difference between the left and right	
b	LFO Frequency [Hz]	0.02...20.00	Sets the speed of the LFO	
	Src	Off...Tempo	Selects the modulation source commonly used for LFO speed and step speed	
	Amt	-20.00...+20.00	Sets the modulation amount of LFO speed	
c	LFO Step Freq [Hz]	0.05...50.00	Sets the LFO step speed	
	Amt	-50.00...+50.00	Sets the modulation amount of LFO step speed	
d	MIDI Sync	Off, On	When this is on, the LFO speed is set by BPM, Base Note, and Times, instead of Frequency	
	BPM	MIDI, 40.00...300.00	MIDI syncs to the system tempo; 40-300 sets the tempo manually for this individual effect	
	Base Note		Selects the type of notes that specify the LFO speed	
	Times	x1...x32	Sets the number of notes that specify the LFO speed	
e	Step Base Note		Selects the type of notes to specify the LFO step speed	
	Times	x1...x32	Sets the number of notes to specify the LFO step speed	

f	Manual	0...100	Sets the frequency to which the effect is applied
	Src	Off...Tempo	Selects the modulation source for the LFO modulation
	Amt	-100...+100	Sets the modulation amount of the LFO modulation
g	Depth	0...100	Sets the depth of LFO modulation
h	Resonance	-100...+100	Sets the resonance amount
	High Damp [%]	0...100	Sets the resonance damping amount in the high range
i	Wet/Dry	-Wet, -1:99... Dry...99:1, Wet	Balance between the wet and dry signal
	Src	Off...Tempo	See DMS (Dynamic Modulation Source)
	Amt	-100...+100	Amount of modulation source

St. Env. Phaser (Stereo Envelope Phaser)

This stereo phaser uses an envelope generator for modulation. You will obtain the same pattern of phasing each time you play. You can also control the Phaser directly using the modulation source.

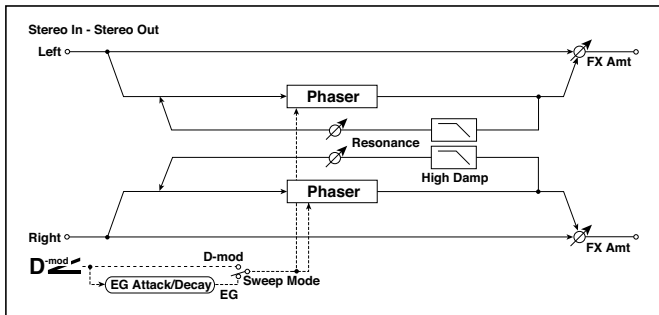

a	L Manu Bottom	0...100	Sets the lower limit of the frequency range for the effect on the left channel
	L Manu Top	0...100	Sets the upper limit of the frequency range for the effect on the left channel
b	R Manu Bottom	0...100	Sets the lower limit of the frequency range for the effect on the right channel
	R Manu Top	0...100	Sets the upper limit of the frequency range for the effect on the right channel

c	Sweep Mode	EG, D-mod	Determines whether the flanger is controlled by the envelope generator or by the modulation source
	Src	Off...Tempo	Selects the modulation source that triggers the EG (when EG is selected for Sweep Mode), or modulation source that causes the flanger to sweep (when D-mod is selected for Sweep Mode)
d	EG Attack	1...100	Sets the EG attack speed
	EG Decay	1...100	Sets the EG decay speed
e	Resonance	-100...+100	Sets the resonance amount
f	High Damp [%]	0...100	Sets the resonance damping amount in the high range
g	Wet/Dry	-Wet, -1:99... Dry...99:1, Wet	Balance between the wet and dry signal
	Src	Off...Tempo	See DMS (Dynamic Modulation Source)
	Amt	-100...+100	Amount of modulation source

Orange Phaser

This phaser pedal is a favorite on many recordings. It's useful for adding sparkle, animating chord passages, and widening and fattening the sound.

The original had only a speed control; this version adds depth, control of the center frequency, and more.

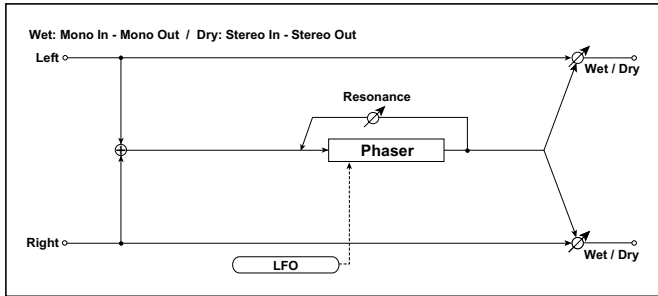

a	Speed	0.10...10.00	This controls the speed of the phaser's LFO.
	Src	Off...Tempo	Selects a modulation source for LFO speed
	Amt	-20.00... +20.00	Sets the modulation amount of LFO speed
b	Depth	0...100	Sets the depth of LFO modulation
	Src	Off...Tempo	Selects the modulation source for the LFO modulation depth
	Amt	-100...+100	Sets the modulation amount of the LFO modulation depth
c	Resonance	-100...+100	This controls the intensity of the phaser effect. The default is 26. Mixing the processed and dry signals via Wet/Dry will enhance the effect.
d	Manual	0...100	Sets the frequency to which the effect is applied
e	Wet/Dry	-Wet, -1:99... Dry...99:1, Wet	Balance between the wet and dry signal
	Src	Off...Tempo	See DMS (Dynamic Modulation Source)
	Amt	-100...+100	Amount of modulation source

Small Phaser

This classic phaser, made in New York City during the 70s, has a notably warm and rich tone with liquid transparency.

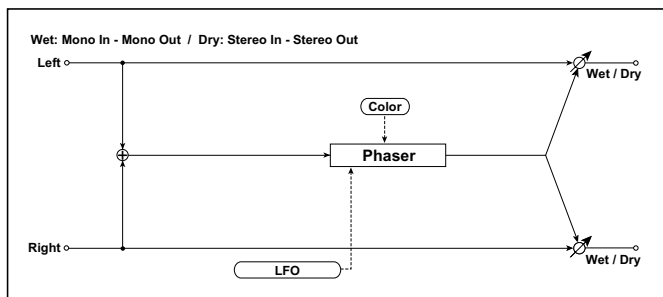

a	Speed	0.10...10.00	This controls the speed of the phaser's LFO. The default is 1.00 Hz.
	Src	Off...Tempo	Selects a modulation source for LFO speed
	Amt	-20.00... +20.00	Sets the modulation amount of LFO speed
c	Color	Off, On	This changes the sound of the phaser between a full and round phase shift when set to Off, and a more pronounced effect when set to On.
e	Wet/Dry	-Wet, -1:99... Dry...99:1, Wet	Balance between the wet and dry signal
	Src	Off...Tempo	See DMS (Dynamic Modulation Source)
	Amt	-100...+100	Amount of modulation source

Phaser - Cho/Flng (Phaser - Chorus/Flanger)

This effect combines a mono phaser and a chorus/flanger.

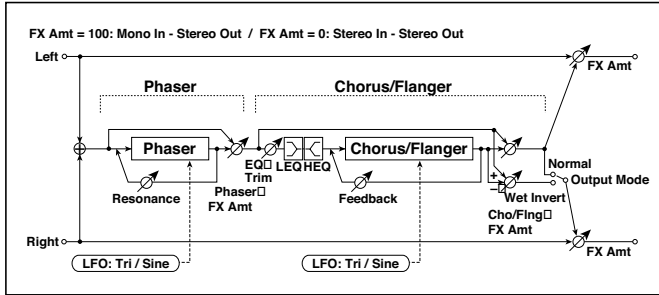

PHASER			
a	[P]LFO Frequency [Hz]	0.02...20.00	Sets the speed of the LFO
	LFO Waveform	Triangle, Sine	Selects the LFO Waveform
b	[P]Manual	0...100	Sets the frequency to which the effect is applied
	Depth	0...100	Sets the depth of LFO modulation
	Resonance	-100...+100	Sets the resonance amount
c	[P]Phaser Wet/Dry	-Wet, -1:99... Dry...99:1, Wet	Sets the phaser effect balance
CHORUS/FLANGER			
d	[F]LFO Frequency [Hz]	0.02...20.00	Sets the speed of the LFO
	LFO Waveform	Triangle, Sine	Selects the LFO Waveform
e	[F]Delay Time [msec]	0.0...1350.0	Sets the delay time
	Depth	0...100	Sets the depth of LFO modulation
	Feedback	-100...+100	Sets the feedback amount
f	[F]EQ Trim	0...100	Sets the EQ input level
g	[F]PreLEQ Gain [dB]	-15...+15	Sets the gain of Low EQ
	PreHEQ Gain [dB]	-15...+15	Sets the gain of High EQ
h	[F]Cho/Flng Wet/Dry	-Wet, -1:99... Dry...99:1, Wet	Sets the effect balance of the chorus/flanger
	Src	Off...Tempo	Selects the Wet/Dry modulation source for the chorus/flanger
	Amt	-100...+100	Sets the Wet/Dry modulation amount for the chorus/flanger



i	[F]Output Mode	Normal, Wet Invert	Selects the output mode for the chorus/flanger
j	Wet/Dry	Dry, 1:99...99:1, Wet	Balance between the wet and dry signal
	Src	Off...Tempo	See DMS (Dynamic Modulation Source)
	Amt	-100...+100	Amount of modulation source

St. Phaser + Trml (Stereo Phaser + Tremolo)

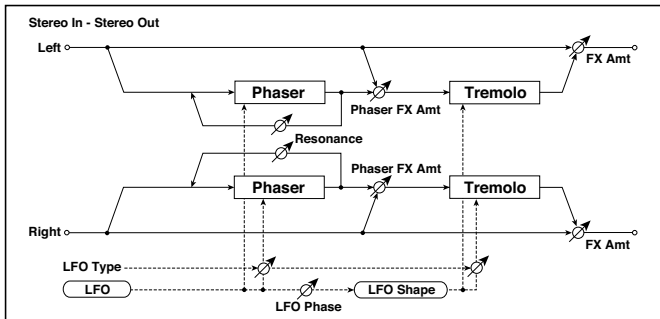
This effect combines a stereo phaser and tremolo, with linked LFOs. Swelling phaser modulation and tremolo effects synchronize with each other, creating a soothing modulation effect particularly suitable for electric piano.



a	Type	Phs - Trml, ... Phs LR - Trml LR	Selects the type of the tremolo and phaser LFOs Phaser - Tremolo, Phaser - Tremolo Spin, Phaser - Tremolo LR, Phaser LR - Tremolo, Phaser LR - Tremolo Spin, Phaser LR - Tremolo LR
	LFO Phase [degree]	-180...+180	Sets the phase difference between the tremolo and phaser LFOs
b	LFO Frequency [Hz]	0.02...20.00	Sets the speed of the LFO
	Src	Off...Tempo	Selects a modulation source for LFO speed
	Amt	-20.00... +20.00	Sets the LFO speed modulation amount

c	MIDI Sync	Off, On	When this is on, the LFO speed is set by BPM, Base Note, and Times, instead of Frequency	
	BPM	MIDI, 40.00... 300.00	MIDI syncs to the system tempo; 40-300 sets the tempo manually for this individual effect	
	Base Note		Selects the type of notes that specify the LFO speed	
	Times	x1...x32	Selects the number of notes that specify the LFO speed	
d	Phaser Manual	0...100	Sets the phaser frequency range	
	Resonance	-100...+100	Sets the phaser resonance amount	
e	Phaser Depth	0...100	Sets the phaser modulation depth	
	Src	Off...Tempo	Selects the modulation source for the phaser modulation depth	
	Amt	-100...+100	Sets the modulation amount for the phaser modulation depth	
f	Phaser Wet/Dry	-Wet, -2 : 98... Dry... 2 : 98, Wet	Sets the balance between the phaser effect and dry sounds	
g	Tremolo Shape	-100...+100	Sets the degree of the tremolo LFO shaping	
h	Tremolo Depth	0...100	Sets the tremolo modulation depth	
	Src	Off...Tempo	Selects the modulation source for the tremolo modulation depth	
	Amt	-100...+100	Sets the modulation amount of the tremolo modulation depth	
i	Wet/Dry	Dry, 1:99...99:1, Wet	Balance between the wet and dry signal	
	Src	Off...Tempo	See DMS (Dynamic Modulation Source)	
	Amt	-100...+100	Amount of modulation source	

a: Type**a: LFO Phase [degree]**

Select the type of phaser LFO and tremolo LFO for the “Type” parameter. How the effect sound moves or rotates depends on the type of LFO. Selecting “LFO Phase” enables you to offset the timing of the phaser peak and control a subtle movement and rotation of the sound.

f: Phaser Wet/Dry

i: Wet/Dry



PHASER Wet/Dry sets the balance between the phaser output and the dry sound. **OUTPUT Wet/Dry** sets the balance between the final phaser and tremolo output level and the dry sound.

Stereo Tremolo

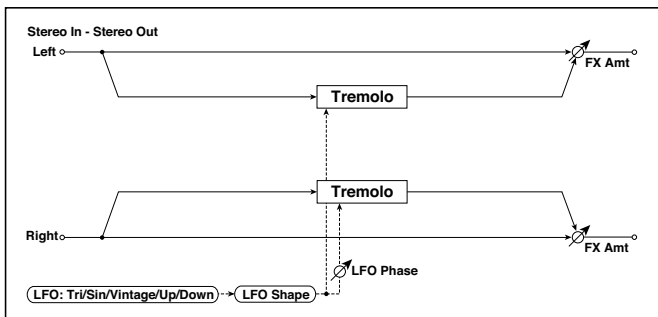
This effect modulates the volume level of the input signal. The effect is stereo, and offsetting the LFO of the left and right phases from each other produces a tremolo effect between left and right.



a	LFO Waveform	Triangle, Sine, Vintage, Up, Down	Selects the LFO Waveform
	LFO Shape	-100...+100	Changes the curvature of the LFO Waveform
b	LFO Phase [degree]	-180...+180	Sets the LFO phase difference between the left and right
c	LFO Frequency [Hz]	0.02...20.00	Sets the speed of the LFO
	Src	Off...Tempo	Selects a modulation source for LFO speed
	Amt	-20.00...+20.00	Sets the modulation amount of LFO speed

d	MIDI Sync	Off, On	When this is on, the LFO speed is set by BPM, Base Note, and Times, instead of Frequency 
	BPM	MIDI, 40.00... 300.00	MIDI syncs to the system tempo; 40-300 sets the tempo manually for this individual effect
	Base Note		Selects the type of notes that specify the LFO speed
	Times	x1...x32	Sets the number of notes that specify the LFO speed
e	Depth	0...100	Sets the depth of LFO modulation
	Src	Off...Tempo	Selects the modulation source of the depth of modulation
	Amt	-100...+100	Sets the modulation amount of the depth of modulation
f	Wet/Dry	Dry, 1:99...99:1, Wet	Balance between the wet and dry signal
	Src	Off...Tempo	See DMS (Dynamic Modulation Source)
	Amt	-100...+100	Amount of modulation source

a: LFO Waveform

This parameter sets the basic shape of the LFO. The **Vintage** waveform models classic guitar-amp tremolo.

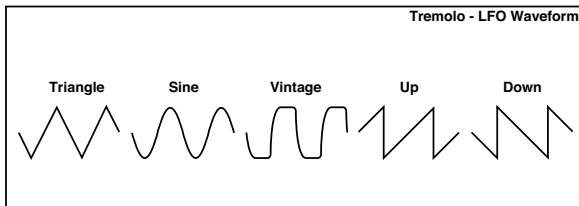

b: LFO Phase [degree]

This parameter determines the difference between the left and right LFO phases. A higher value will simulate the auto-pan effect in which the sound is panned between left and right.

St. Env. Tremolo (Stereo Envelope Tremolo)

This effect uses the input signal level to modulate a stereo tremolo (LFO volume modulation). For instance, you can create a tremolo effect that becomes deeper and faster as the input gets more quiet.

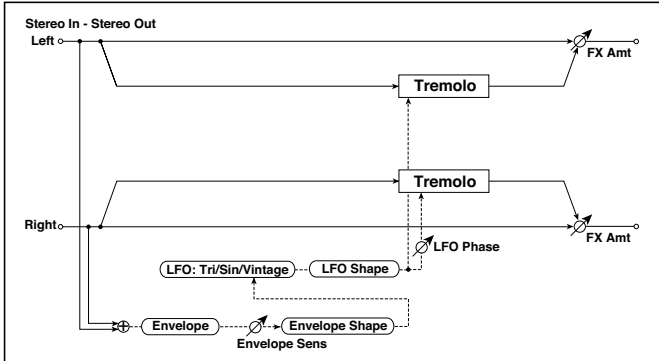

a	Envelope Sens	0...100	Sets the envelope's sensitivity to the input signal
	Envelope Shape	-100...+100	Sets the envelope's curvature
b	LFO Waveform	Triangle, Sine, Vintage	Selects the LFO Waveform
	LFO Shape	-100...+100	Changes the curvature of the LFO Waveform
c	LFO Phase [degree]	-180...+180	Sets the LFO phase difference between the left and right
d	LFO Frequency [Hz]	0.02...20.00	Sets the speed of the LFO
	Envelope Amount [Hz]	-20.00...+20.00	Sets the amount added to or subtracted from the Frequency when the envelope is at maximum
e	Depth	0...100	Sets the initial amount of tremolo
	Envelope Amount	-100...+100	Sets the amount added to or subtracted from the Depth when the envelope is at maximum
f	Wet/Dry	Dry, 1:99...99:1, Wet	Balance between the wet and dry signal
	Src	Off...Tempo	See DMS (Dynamic Modulation Source)
	Amt	-100...+100	Amount of modulation source

d: LFO Frequency [Hz]

d: Envelope Amount [Hz]

e: Depth

e: Envelope Amount

The graphic below shows an example of tremolo modulation with negative modulation of both **Depth** and **Frequency**. At the start of the note, the input is at maximum volume. This slows down the **LFO Frequency** to 1.0Hz, but also modulates the **Depth** to 0—so the tremolo doesn't have any effect.

As the input volume dies down, the **Frequency** speeds up; the **Depth** also increases, making the tremolo effect increasingly audible. When the input volume approaches silence, the **Depth** is at its maximum (100) and **Frequency** is at 8Hz.

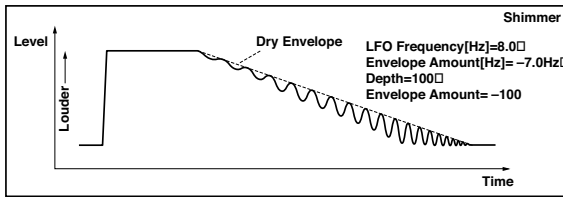

Classic Tremolo

Vintage Tremolo effect.

a	Speed	0.10...10.00	Sets the speed of the LFO	
	Src	Off...Tempo	Modulation for the tremolo speed. See DMS (Dynamic Modulation Source)	
	Amt	-10.00... +10.00	Sets the modulation amount of the tremolo speed	
b	Depth	0...100	Sets the initial amount of tremolo	
	Src	Off...Tempo	Modulation for the tremolo depth. See DMS (Dynamic Modulation Source)	
	Amt	-10.00... +10.00	Sets the modulation amount of the tremolo depth	
c	Spread	0...100	Sets the width of the stereo image of the effect sound	
d	Level Adjust	0...99	Level of the effect	

e	Wet/Dry	Dry, 1:99...99:1, Wet	Balance between the wet and dry signal	
	Src	Off...Tempo	See DMS (Dynamic Modulation Source)	
	Amt	-100...+100	Amount of modulation source	

Ensemble

This Ensemble effect has three chorus blocks that use LFO to create subtle shimmering, and gives three dimensional depth and spread to the sound, because the signal is output from the left, right, and center.

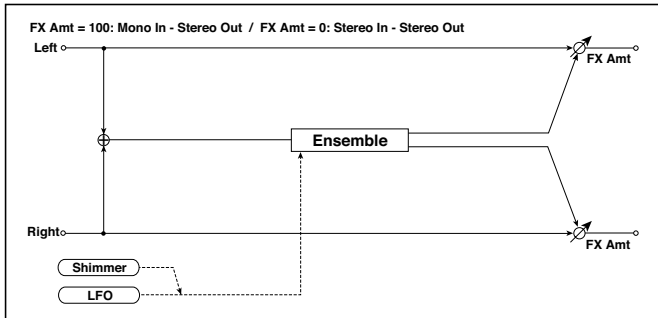

a	Speed [Hz]	1...100	Sets the speed of the LFO	
	Src	Off...Tempo	Selects a modulation source for LFO speed	
	Amt	-100...+100	Sets the modulation amount of LFO speed	
b	Depth	0...100	Sets the depth of LFO modulation	
	Src	Off...Tempo	Selects the modulation source of the LFO modulation depth	
	Amt	-100...+100	Sets the modulation amount of the LFO modulation depth	
c	Shimmer	0...100	Sets the amount of shimmering of the LFO waveform	
d	Wet/Dry	Dry, 1:99...99:1, Wet	Balance between the wet and dry signal	
	Src	Off...Tempo	See DMS (Dynamic Modulation Source)	
	Amt	-100...+100	Amount of modulation source	

c: Shimmer

This parameter sets the amount of shimmering of the LFO waveform. Increasing this value adds more shimmering, making the chorus effect more complex and richer.

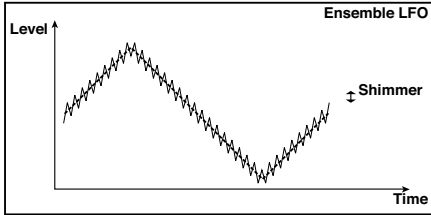

Polysix Ensemble

This models the ensemble effect built into the classic KORG PolySix programmable polyphonic synthesizer.

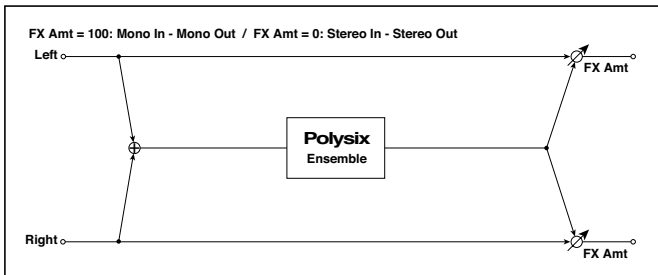



a	Depth	0...100	Sets the depth of the effect	
	Src	Off...Tempo	Selects the modulation source that will control the effect depth	
	Amt	-100...+100	Sets the amount by which the effect depth will be modulated	
b	Wet/Dry	Dry, 1:99...99:1, Wet	Balance between the wet and dry signal	
	Src	Off...Tempo	See DMS (Dynamic Modulation Source)	
	Amt	-100...+100	Amount of modulation source	

Stereo Vibrato

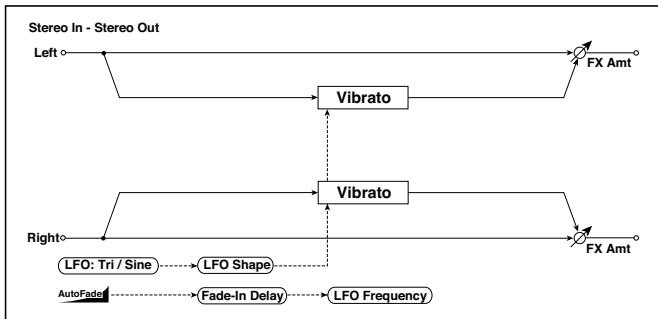
This effect causes the pitch of the input signal to shimmer. Using the AutoFade allows you to increase or decrease the shimmering speed.



a	Autofade Src	Off...Tempo	Selects the modulation source that starts AutoFade	
b	Fade-In Delay [msec]	00...2000	Sets the fade-in delay time	
	Fade-In Rate	1...100	Sets the rate of fade-in	
c	LFO Waveform	Triangle, Sine	Selects the LFO Waveform	
	LFO Shape	-100...+100	Changes the curvature of the LFO Waveform	
d	LFO Frequency Mod	D-mod, AUTOFADE	Switches between D-mod and AUTOFADE for the LFO frequency modulation	
e	LFO Frequency [Hz]	0.02...20.00	Sets the speed of the LFO	
	Src	Off...Tempo	Selects a modulation source for LFO speed	
	Amt	-20.00...+20.00	Sets the modulation amount of LFO speed	
f	MIDI Sync	Off, On	When this is on, the LFO speed is set by BPM, Base Note, and Times, instead of Frequency	
	BPM	MIDI, 40.00...300.00	MIDI syncs to the system tempo; 40-300 sets the tempo manually for this individual effect	
	Base Note		Selects the type of notes that specify the LFO speed	
	Times	x1...x32	Sets the number of notes that specify the LFO speed	

g	Depth	0...100	Sets the depth of LFO modulation
	Src	Off...Tempo	Selects the modulation source of the LFO modulation depth
	Amt	-100...+100	Sets the modulation amount of the LFO modulation depth
h	Wet/Dry	Dry, 1:99...99:1, Wet	Balance between the wet and dry signal
	Src	Off...Tempo	See DMS (Dynamic Modulation Source)
	Amt	-100...+100	Amount of modulation source

a: Autofade Src

b: Fade-In Delay [msec]

c: Fade-In Rate

d: LFO Frequency Mod

When “LFO Frequency Mod” is set to AUTOFADE, you can use the modulation source selected in “AUTOFADE Src” as a trigger to automatically fade in the modulation amount. When “MIDI Sync” is set to On, you cannot use this.

The “Fade-In Rate” parameter specifies the rate of fade-in. The “Fade-In Delay” parameter determines the time from AutoFade modulation source On until the fade-in starts.

The following is an example of fade-in where the LFO speed is increased from “1.0Hz” to “4.0Hz” when a note-on message is received.

AUTOFADE Src=Gate1, LFO Frequency Mod=AUTOFADE, LFO Frequency [Hz]=1.0, Amt=3.0

MIDI The effect is off when a value for the dynamic modulation source specified for the “AUTOFADE Src” parameter is smaller than 64, and the effect is on when the value is 64 or higher. The AutoFade function is triggered when the value changes from 63 or smaller to 64 or higher.

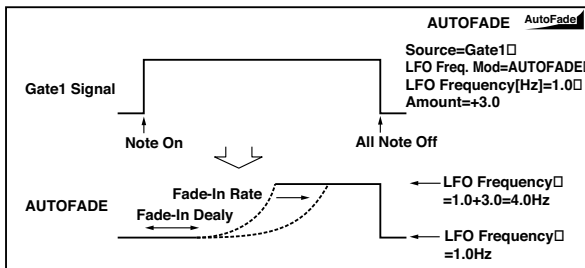

U-Vibe

Modeled on the most famous chorus/vibrato pedal effect unit. This effect simulates a rotating speaker and produces a wonderfully seductive and 'watery' tone. Interestingly enough, the guy responsible for this great pedal is also responsible for the birth of the KORG Nuvibe and Valve Reactor Technology.

a	Speed [Hz]	1...100	Sets the speed of the U-Vibe effect
	Src	Off...Tempo	Selects a modulation source for the U-Vibe effect
	Amt	-10.00... +10.00	Sets the modulation amount of the U-Vibe effect
b	Depth	0...100	Sets the depth of the U-Vibe effect
	Src	Off...Tempo	Selects the modulation source of the LFO modulation depth
	Amt	-100...+100	Sets the modulation amount of the LFO modulation depth
c	Mix	0...100	Sets the effect mix level
	Src	Off...Tempo	Selects the modulation source of the effect mix level
	Amt	-100...+100	Sets the modulation amount of the effect mix level
d	Wet/Dry	Dry, 1:99...99:1, Wet	Balance between the wet and dry signal
	Src	Off...Tempo	See DMS (Dynamic Modulation Source)
	Amt	-100...+100	Amount of modulation source

St. Auto Fade Mod. (Stereo Auto Fade Modulation)

This stereo chorus/flanger effect enables you to control the LFO speed and effect balance using auto fade, and you can spread the sound by offsetting the phase of the left and right LFOs from each other.

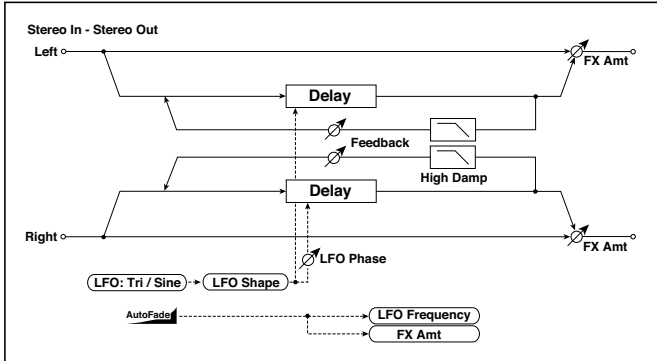

a	Autofade Src	Off...Tempo	Selects the modulation source that starts AutoFade
	Fade-In Delay [msec]	00...2000	Sets the fade-in delay time
	Rate	1...100	Sets the rate of fade-in
b	LFO Frequency Mod	D-mod, AUTOFADE	Switches between D-mod and AUTOFADE for the LFO frequency modulation
	Wet/Dry Mod	D-mod, AUTOFADE	Switches between D-mod and AUTOFADE for the effect balance modulation
c	LFO Waveform	Triangle, Sine	Selects the LFO Waveform
	LFO Shape	-100...+100	Changes the curvature of the LFO Waveform
d	LFO Phase [degree]	-180...+180	Sets the LFO phase difference between the left and right
e	LFO Frequency [Hz]	0.02...20.00	Sets the speed of the LFO
	Src	Off...Tempo	Selects a modulation source for LFO speed
	Amt	-20.00... +20.00	Sets the modulation amount of LFO speed
f	L Delay Time [msec]	0.0...500.0	Sets the left channel delay time
	R Delay Time [msec]	0.0...500.0	Sets the right channel delay time
g	Depth	0...200	Sets the depth of LFO modulation
h	Feedback	-100...+100	Sets the feedback amount
	High Damp [%]	0...100	Sets the feedback damping amount in the high range
i	Wet/Dry	-Wet, -1:99... Dry...99:1, Wet	Balance between the wet and dry signal
	Src	Off...Tempo	See DMS (Dynamic Modulation Source)
	Amt	-100...+100	Amount of modulation source

St. Biphase Mod. (Stereo Biphase Modulation)

This stereo chorus effect adds two different LFOs together. You can set the Frequency and Depth parameters for each LFO individually. Depending on the setting of these LFOs, very complex waveforms will create an analog-type, unstable modulated sound.

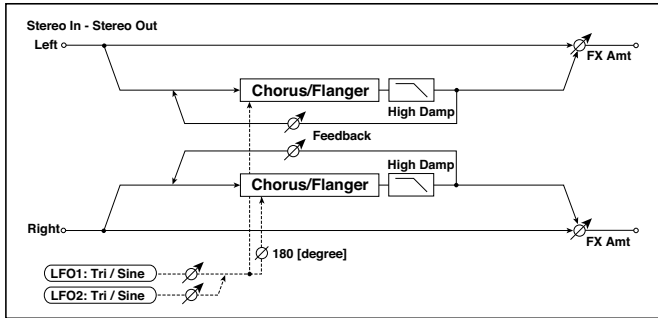

a	LFO1 Waveform	Triangle, Sine	Selects LFO1 waveform	
	LFO2	Triangle, Sine	Selects LFO2 waveform	
	Phase Sw	0 deg, 180 deg	Switches the LFO phase difference between left and right	
b	LFO1 Frequency [Hz]	0.02...30.00	Sets the LFO1 speed	
	Src	Off...Tempo	Selects the modulation source of LFO1&2 speed	
	LFO1 Amt	-30.00... +30.00	Sets the modulation amount of LFO1 speed	
c	LFO2 Frequency [Hz]	0.02...30.00	Sets the LFO2 speed	
	Amt	-30.00... +30.00	Sets the modulation amount of LFO2 speed	
d	Depth1	0...100	Sets the depth of LFO1 modulation	
	Src	Off...Tempo	Selects the modulation source of LFO1&2 modulation depth	
	Amt	-100...+100	Sets the modulation amount of LFO1 modulation depth	
e	Depth2	0...100	Sets the depth of LFO2 modulation	
	Amt	-100...+100	Sets the modulation amount of LFO2 modulation depth	

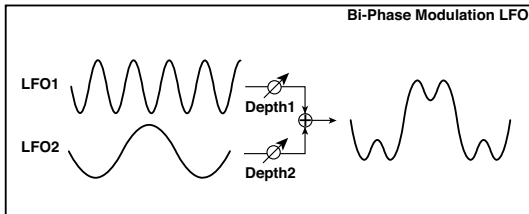

f	L Pre Delay [msec]	0.0...50.0	Sets the delay time for the left channel
	R Pre Delay [msec]	0.0...50.0	Sets the delay time for the right channel
g	Feedback	-100...+100	Sets the feedback amount
	High Damp [%]	0...100	Sets the damping amount in the high range
h	Wet/Dry	-Wet, -1:99... Dry...99:1, Wet	Balance between the wet and dry signal
	Src	Off...Tempo	See DMS (Dynamic Modulation Source)
	Amt	-100...+100	Amount of modulation source

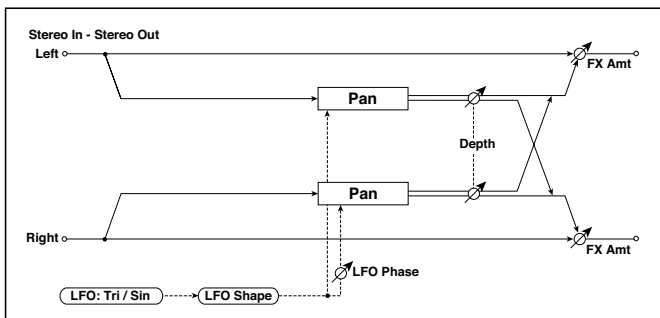

Stereo Auto Pan

This is a stereo-in, stereo-out auto-panner. The Phase and Shape parameters lets you create various panning effects, such as making the left and right inputs seem to chase each other around the stereo field.



a	LFO Waveform	Triangle, Sine	Selects the LFO Waveform	
	LFO Shape	-100...+100	Changes the curvature of the LFO Waveform	
b	LFO Phase [degree]	-180...+180	Sets the LFO phase difference between the left and right	
c	LFO Frequency [Hz]	0.02...20.00	Sets the speed of the LFO	
	Src	Off...Tempo	Selects a modulation source for LFO speed	
	Amt	-20.00...+20.00	Sets the modulation amount of LFO speed	
d	MIDI Sync	Off, On	When this is on, the LFO speed is set by BPM, Base Note, and Times, instead of Frequency	
	BPM	MIDI, 40.00...300.00	MIDI syncs to the system tempo; 40-300 sets the tempo manually for this individual effect	
	Base Note		Selects the type of notes that specify the LFO speed	
	Times	x1...x32	Sets the number of notes that specify the LFO speed	
e	Depth	0...100	Sets the depth of LFO modulation	
	Src	Off...Tempo	Selects the modulation source of the depth of modulation	
	Amt	-100...+100	Sets the modulation amount of the depth of modulation	
f	Wet/Dry	Dry, 1:99...99:1, Wet	Balance between the wet and dry signal	
	Src	Off...Tempo	See DMS (Dynamic Modulation Source)	
	Amt	-100...+100	Amount of modulation source	

a: LFO Shape

You can change the panning curve by modifying the LFO's **Shape**.

b: LFO Phase [degree]

This determines the phase difference between the left and right LFOs. When you gradually change the value away from 0, the sounds from the left and right channels will seem to chase each other around. If you set the parameter to +180 or -180, the sounds from each channel will cross over each other.

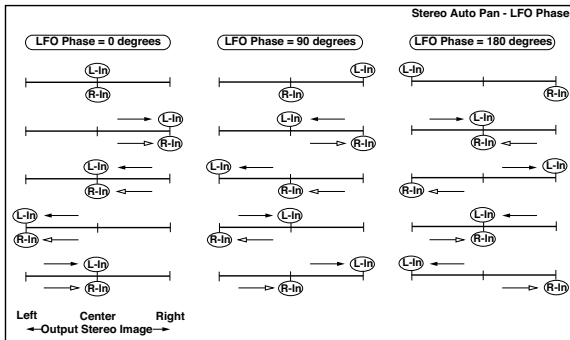

You'll only hear the effect of this parameter if the input is true stereo, with different signals in the left and right channels.

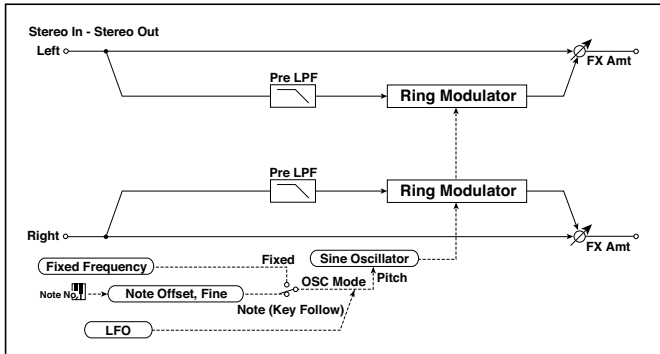

St. Ring Modulator (Stereo Ring Modulator)

This effect creates a metallic sound by applying the oscillators to the input signal. Use the LFO or Dynamic Modulation to modulate the oscillator to create a radical modulation. Matching the oscillator frequency with a note number will produce a ring modulation effect in specific key ranges.



a	OSC Mode	Fixed, Note (Key Follow)	Switching between specifying the oscillator frequency and using a note number	
	Pre LPF	0...100	Sets the damping amount of the high range input to the ring modulator	
b	Fixed Frequency [Hz]	0...12.00k	Sets the oscillator frequency when OSC Mode is set to Fixed	
	Src	Off...Tempo	Selects the modulation source for the oscillator frequency when OSC Mode is set to Fixed	
	Amt	-12.00k...+12.00k	Sets the modulation amount of the oscillator frequency when OSC Mode is set to Fixed	
c	Note Offset	-48...+48	Sets the pitch difference from the original note when OSC Mode is set to Note (Key Follow)	
	Note Fine	-100...+100	Fine-adjusts the oscillator frequency	
d	LFO Frequency [Hz]	0.02...20.00	Sets the speed of the LFO	
	Src	Off...Tempo	Selects a modulation source for LFO speed	
	Amt	-20.00...+20.00	Sets the modulation amount of LFO speed	
e	MIDI Sync	Off, On	When this is on, the LFO speed is set by BPM, Base Note, and Times, instead of Frequency	
	BPM	MIDI, 40.00...300.00	MIDI syncs to the system tempo; 40-300 sets the tempo manually for this individual effect	
	Base Note		Selects the type of notes that specify the LFO speed	
	Times	x1...x32	Sets the number of notes that specify the LFO speed	
f	LFO Depth	0...100	Sets the depth of LFO modulation for the oscillator frequency	
	Src	Off...Tempo	Selects the modulation source of the depth of modulation	
	Amt	-100...+100	Sets the modulation amount of the depth of modulation	
g	Wet/Dry	Dry, 1:99...99:1, Wet	Balance between the wet and dry signal	
	Src	Off...Tempo	See DMS (Dynamic Modulation Source)	
	Amt	-100...+100	Amount of modulation source	

a: OSC Mode

This parameter determines whether or not the oscillator frequency follows the note number.

a: Pre LPF

This parameter enables you to set the damping amount of the high range sound input to the ring modulator. If the input sound contains lots of harmonics, the effect may sound dirty. In this case, cut a certain amount of high range.

b: Fixed Frequency [Hz]

This parameter sets the oscillator frequency when “OSC Mode” is set to Fixed.

c: Note Offset**c: Note Fine**

These parameters for the oscillator are used when “OSC Mode” is set to Note (Key Follow). The “Note Offset” sets the pitch difference from the original note in semitone steps. The “Note Fine” parameter fine-adjusts the pitch in cent steps. Matching the oscillator frequency with the note number produces a ring modulation effect in the correct key.

Organ Vib/Chorus (Organ Vibrato/Chorus)

This effect simulates the chorus and vibrato circuitry of a vintage organ. The modulation speed and depth can be customized.

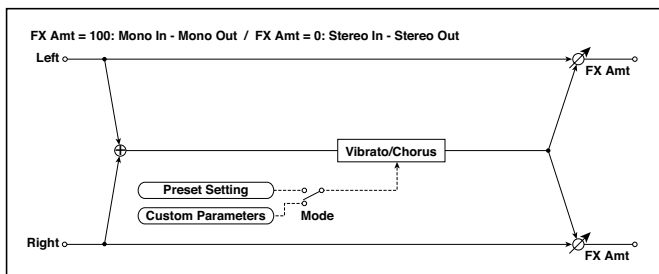

a	Input Trim	0...100	Sets the input level	
b	Control Mode	Preset, Custom	Selects either preset or custom settings	

c	Preset Type	V1, C1, V2, C2, V3, C3	Selects the effect type when Mode=Preset V1/V2/V3 are variations of vibrato, and C1/C2/C3 are variations of chorus
	Src	Off...Tempo	Selects the modulation source that will change the effect type
	Amt	-5...+5	Sets the modulation amount for changing the effect type
d	Custom Mix	Vibrato, 1:99...99:1, Chorus	Sets the mix level of the direct sound when Mode=Preset
	Src	Off...Tempo	Selects the modulation source that will control the mix level of the direct sound
	Amt	-100...+100	Sets the modulation amount for controlling the mix level of the direct sound
e	Custom Depth	0...100	Sets the vibrato depth
	Src	Off...Tempo	Selects the modulation source that will control vibrato depth
	Amt	-100...+100	Sets the modulation amount for controlling the vibrato depth
f	Custom Speed [Hz]	0.02...20.00	Sets the vibrato speed
	Src	Off...Tempo	Selects the modulation source for controlling the vibrato speed
	Amt	-20.00...+20.00	Sets the modulation amount for controlling the vibrato speed
g	Wet/Dry	Dry, 1:99...99:1, Wet	Balance between the wet and dry signal
	Src	Off...Tempo	See DMS (Dynamic Modulation Source)
	Amt	-100...+100	Amount of modulation source

b: Control Mode

c: Preset Type

d: Custom Mix

e: Custom Depth

f: Custom Speed [Hz]

If Control Mode=Preset, you can use c: Preset Type to select the effect. In this case, the Custom Mix/Depth/Speed settings are ignored. If Control Mode=Custom, the Custom Mix/Depth/Speed settings are valid, and the c: Preset Type setting is ignored.

c: Amt

If Preset Type=V1 and Src=JS+Y, you can set this to +5 and move JS +Y to control the effect in the order of V1>C1>V2>C2>V3>C3.

Rotary Speaker

This effect simulates a rotary speaker, and obtains a more realistic sound by simulating the rotor in the low range and the horn in the high range separately. The effect also simulates the stereo microphone settings.

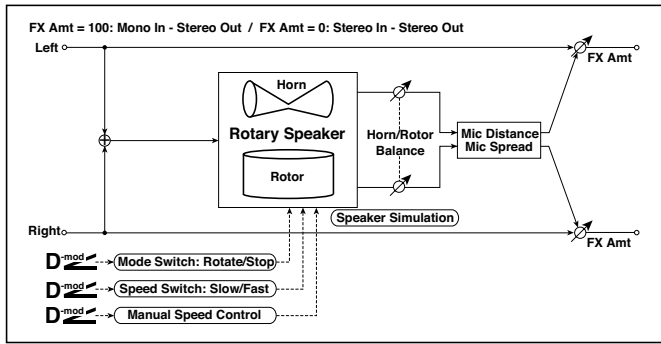

a	Mode Switch	Rotate, Stop	Switches between speaker rotation and stop	
	Src	Off...Tempo	Selects a modulation source for Rotate/Stop	
	Mode	Toggle, Moment	Sets the switch mode for Rotate/Stop modulation	
b	Speed Switch	Slow, Fast	Switches the speaker rotation speed between slow and fast	
	Src	Off...Tempo	Selects a modulation source for Slow/Fast	
	Mode	Toggle, Moment	Sets the switch mode for Slow/Fast modulation	
c	Manual Speed Ctrl	Off...Tempo	Sets a modulation source for direct control of rotation speed	
d	Hore Acceleration	0...100	How quickly the horn rotation speed in the high range is switched	
	Hore Ratio	Stop, 0.50...2.00	Adjusts the (high-range side) horn rotation speed. Standard value is 1.00. Selecting "Stop" will stop the rotation	

e	Rotor Acceleration	0...100	Determines how quickly the rotor rotation speed in the low range is switched
	Rotor Ratio	Stop, 0.50...2.00	Adjusts the (low-frequency) rotor speed. Standard value is 1.00. Selecting "Stop" will stop the rotation
f	Horn/Rotor Balance	Rotor, 1...99, Horn	Sets the level balance between the high-frequency horn and low-frequency rotor
g	Mic Distance	0...100	Sets the distance between the microphone and rotary speaker
	Mic Spread	0...100	Sets the angle of left and right microphones
h	Wet/Dry	Dry, 1:99...99:1, Wet	Balance between the wet and dry signal
	Src	Off...Tempo	See DMS (Dynamic Modulation Source)
	Amt	-100...+100	Amount of modulation source

a: Mode

This parameter sets how the modulation source switches between rotation and stop.

When **Mode = Toggle**, the speaker rotates or stops alternately each time you press the pedal or move the joystick. Via MIDI, rotation will switch between start and stop each time the modulation amount exceeds 64.

When **Mode = Moment**, the speaker rotates by default, and stops only when you press the pedal or move the joystick. Via MIDI, modulation values above 64 make the speaker rotate, and values below 64 make it stop.

b: Speed Switch

This parameter controls how the rotation speed (slow and fast) is switched via the modulation source.

When **Mode = Toggle**, the speed will switch between slow and fast each time you press the pedal or move the joystick. Via MIDI, the speed will switch each time the modulation amount exceeds 64.

When **Mode = Moment**, the speed is usually slow. It becomes fast only when you press the pedal or move the joystick. Via MIDI, modulation values above 64 set the speed to **Fast**, and values below 64 set it to **Slow**.

c: Manual Speed Ctrl

If you wish to control the rotation speed manually, instead of switching between Slow and Fast, select a modulation source in the **Manual Speed Ctrl** parameter. If you don't want to use manual control, set this to **Off**.

d: Horn Acceleration

e: Rotor Acceleration

On a real rotary speaker, the rotation speed accelerates or decelerates gradually after you switch the speed. The **Horn** and **Rotor Acceleration** parameters set the transition times between fast and slow speeds.

g: Mic Distance

g: Mic Spread

This is a simulation of stereo microphone settings.

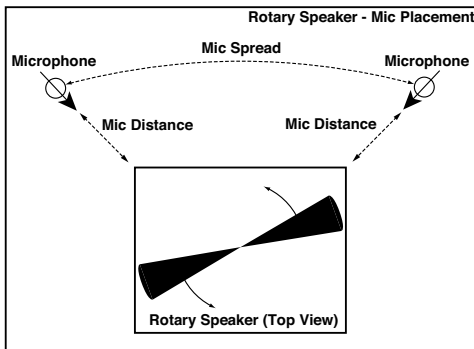

Rotary SpeakerOD (Rotary Speaker Overdrive)

This is a stereo rotary speaker effect. It has an internal speaker simulator that simulates overdrive (recreating the amp distortion) and characteristics of the rotary speaker, producing a very realistic rotary speaker sound.

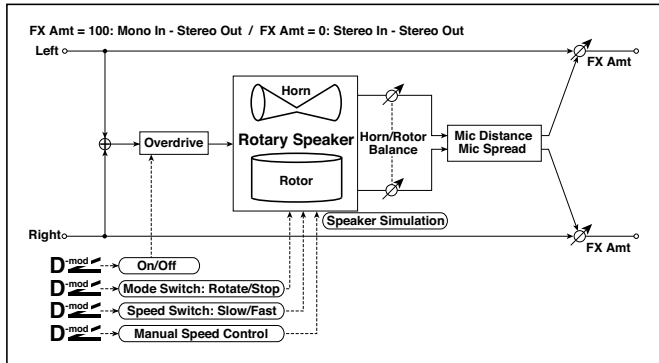

a	Overdrive	Off, On	Switches overdrive on/off
	Src	Off...Tempo	Selects a modulation source to switch overdrive on/off
	Sw	Toggle, Moment	Sets the switch mode for overdrive on/off modulation
b	Overdrive Gain	0...100	Determines the degree of distortion
	Overdrive Level	0...100	Sets the overdrive output level
c	Overdrive Tone	0...15	Sets the tonal quality of the overdrive
	Speaker Simulator	Off, On	Switches the speaker simulation on/off
d	Mode Switch	Rotate, Stop	Switches between speaker rotation and stop
	Src	Off...Tempo	Selects a modulation source for Rotate/Stop
	Sw	Toggle, Moment	Sets the switch mode for Rotate/Stop modulation
e	Speed Switch	Slow, Fast	Switches the speaker rotation speed between slow and fast
	Src	Off...Tempo	Selects a modulation source for Slow/Fast
	Sw	Toggle, Moment	Sets the switch mode for Slow/Fast modulation

f	Horn/Rotor Balance	Rotor, 1...99, Horn	Sets the volume balance between the high-range horn and low-range rotor
	Manual SpeedCtrl	Off...Tempo	Sets a modulation source for direct control of rotation speed
g	Horn Acceleration	0...100	Sets how quickly the horn rotation speed changes
	Horn Ratio	Stop, 0.50...2.00	Adjusts the (high-frequency) horn rotation speed. Standard value is 1.00. "Stop" stops the rotation
h	Rotor Acceleration	0...100	Sets how quickly the rotor speed changes
	Rotor Ratio	Stop, 0.50...2.00	Adjusts the (low-frequency) rotor rotation speed. Standard value is 1.0. "Stop" stops the rotation
i	Mic Distance	0...100	Distance between the microphone and rotary speaker
	Mic Spread	0...100	Angle of left and right microphones
j	Wet/Dry	Dry, 1:99...99:1, Wet	Balance between the wet and dry signal
	Src	Off...Tempo	See DMS (Dynamic Modulation Source)
	Amt	-100...+100	Amount of modulation source

a: Sw

This parameter determines how to switch on/off the overdrive via a modulation source.

When "Sw" = Toggle, overdrive is turned on/off each time the pedal or joystick is operated.

MIDI Overdrive will be switched on/off each time the value of the modulation source exceeds 64.

When "Sw" = Moment, overdrive is applied only when you press the pedal or operate the joystick.

MIDI Only when the value for the modulation source is 64 or higher, the overdrive effect is applied.

DYN (Dynamics)

Stereo Compressor

This effect compresses the input signal to regulate the level and give a “punchy” effect. It is useful for guitar, piano, and drum sounds. This is a stereo compressor. You can link left and right channels, or use each channel separately.

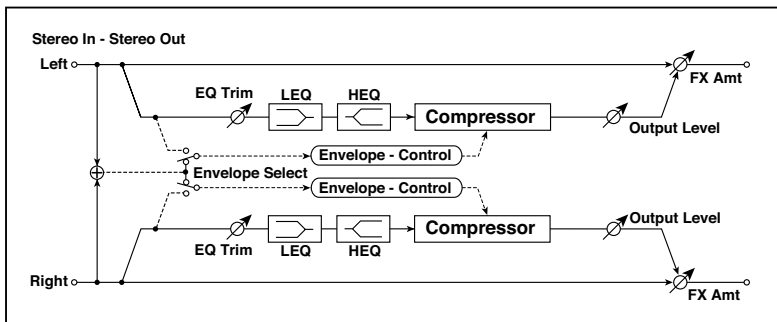

a	Envelope Select	L/R Mix, L/R Individually	Determines whether the left and right channels are linked or used separately
b	Sensitivity	1...100	Sets the sensitivity
c	Attack	1...100	Sets the attack level
d	EQ Trim	0...100	Sets the EQ input level
e	Pre LEQ Fc	Low, Mid-Low	Selects the cutoff frequency (low or mid-low) of the low-range equalizer
	Pre HEQ Fc	High, Mid-High	Selects the cutoff frequency (high or mid-high) of the high-range equalizer
f	Pre LEQ Gain [dB]	-15.0...+15.0	Sets the gain of the Low EQ
	Pre HEQ Gain [dB]	-15.0...+15.0	Sets the gain of the High EQ
g	Output Level	0...100	Sets the output level of the compressor
	Src	Off...Tempo	Selects the modulation source for the compressor output level
	Amt	-100...+100	Sets the modulation amount for the compressor output level

h	Wet/Dry	Dry, 1:99...99:1, Wet	Sets the Balance between the wet and dry signal
	Src	Off...Tempo	Selects a modulation source for Wet/Dry
	Amt	-100...+100	Sets the modulation amount for Wet/Dry

a: Envelope Select

This parameter selects whether the left and right channels are linked to control both signals simultaneously, or whether each channel is controlled independently.

b: Sensitivity

g: Output Level

The “Sensitivity” parameter sets the sensitivity of the compressor. If this parameter is set to a higher value, lower level sounds will be boosted. With a higher Sensitivity, the overall volume level is higher. To adjust the final volume level, use the “Output Level” parameter.

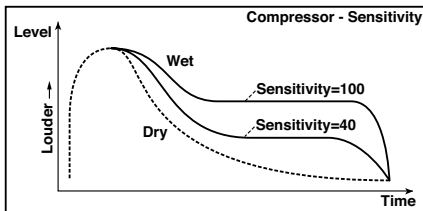

c: Attack

This parameter controls the attack level.

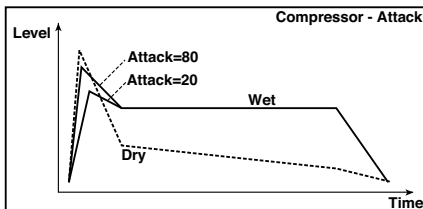

Dyn. Compressor (Dynamic Compressor)

This effect reduces the dynamic range of the input signal, to regulate the level and give a 'punchy' effect. It is useful for guitar, piano, and drum sounds. This is a true stereo effect; you can link the left and right channels, or use each channel separately.

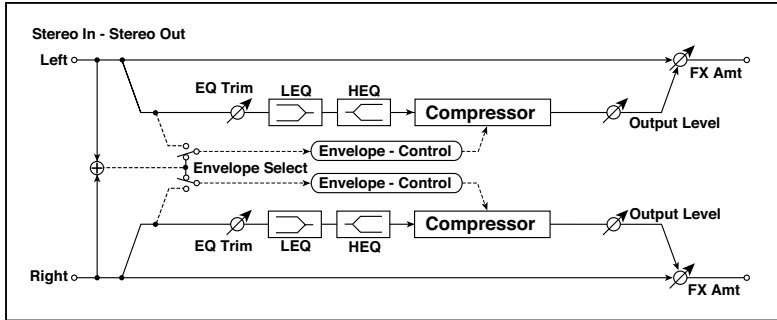

a	Sensitivity	1...100	This controls the amount of compression. Increasing the value boosts lower level sounds, and raises the overall volume. To adjust the final volume, use the Level parameter.
b	Attack	1...100	Sets the attack level
c	Level	0...100	Sets the output level of the compressor
	Src	Off...Tempo	Selects the modulation source for the compressor output level
	Amt	-100...+100	Sets the modulation amount for the compressor output level
d	Wet/Dry	Dry, 1:99...99:1, Wet	Sets the Balance between the wet and dry signal
	Src	Off...Tempo	Selects a modulation source for Wet/Dry
	Amt	-100...+100	Sets the modulation amount for Wet/Dry

Stereo Limiter

The Limiter regulates the input signal level. It is similar to the Compressor, except that the Limiter compresses only signals that exceed the specified level to lower unnecessary peak signals. The Limiter applies a peaking-type EQ to the trigger signal (which controls the degree of the Limiter effect), allowing you to set any band width to be covered. This effect is a stereo limiter. You can link left and right channels, or use each channel individually.

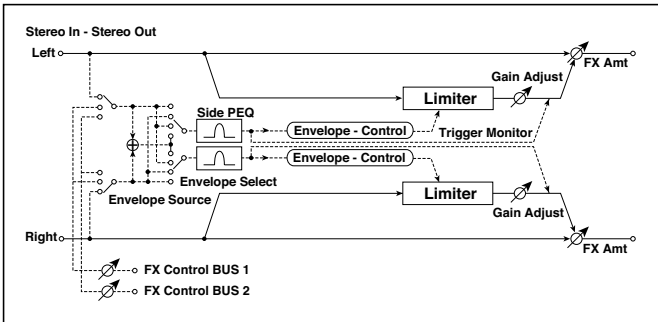

a	Envelope Select	L/R Mix, L Only, R Only, L/R Individually	Selects from linking both channels, controlling only from left channel, only from the right channel, or controlling each channel individually
b	Ratio	1.0 : 1... 50.0 : 1, Inf : 1	Sets the signal compression ratio
c	Threshold [dB]	-40...0	Sets the level above which the compressor is applied
v	Attack	1...100	Sets the attack time
	Release	1...100	Sets the release time
e	Gain Adjust [dB]	-Inf, -38...+24	Sets the output gain
	Src	Off...Tempo	Selects the modulation source for the output gain
	Amt	-63...+63	Sets the modulation amount of the output gain
f	Side PEQ Insert	Off, On	Toggles between on/off of the trigger signal's EQ
	Trigger Monitor	Off, On	Switches between effect output monitor and trigger signal monitor

g	Side PEQ Cutoff [Hz]	20...12.00k	Sets the EQ center frequency for the trigger signal
	Q	0.5...10.0	Sets the EQ bandwidth for the trigger signal
	Gain [dB]	-18.0...+18.0	Sets the EQ gain for the trigger signal
h	Wet/Dry	Dry, 1:99...99:1, Wet	Balance between the wet and dry signal
	Src	Off...Tempo	Dynamic Modulation sources
	Amt	-100...+100	Amount of modulation source

a: Envelope Select

When L/R Mix is selected for this parameter, the left and right channels are linked to control the Limiter using the mixed signal. If L Only (or R Only) is selected, the left and right channels are linked, and the Limiter is controlled via only the left (or right) channel.

With L/R individually, the left and right channels control the Limiter individually.

b: Ratio

c: Threshold [dB]

e: Gain Adjust [dB]

This parameter sets the signal compression "Ratio". Compression is applied only when the signal level exceeds the "Threshold" value.

Adjust the output level using the “Gain Adjust” parameter, since compression causes the entire level to be reduced.

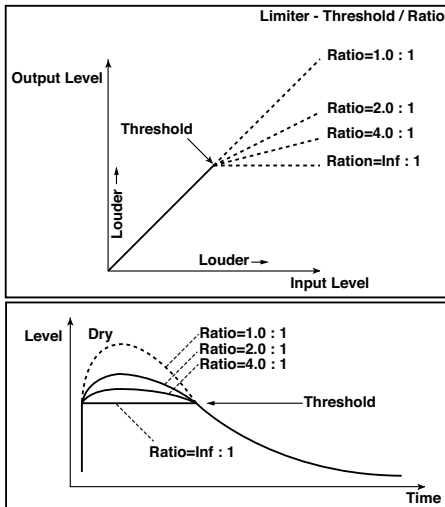

d: Attack

d: Release

These parameters set the attack time and release time. A higher attack time will cause the compression to be applied more slowly.

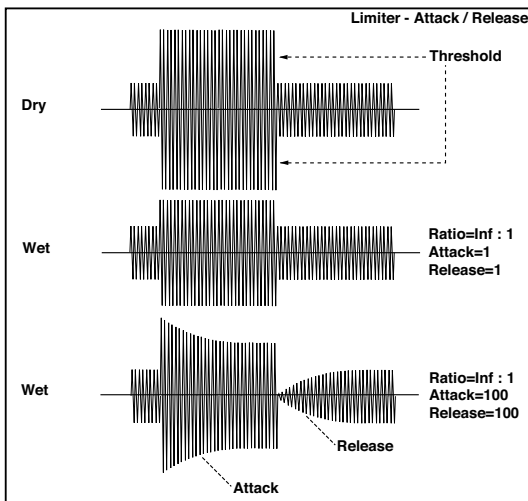

f: Trigger Monitor

Setting this parameter On will cause the trigger signal to be output, instead of the effect sound. Use this parameter to check the trigger signal with EQ applied.

Usually, set this to Off.

f: Side PEQ Insert

g: Side PEQ Cutoff [Hz]

g: Q

g: Gain [dB]

These parameters are used to set the EQ applied to the trigger signal.

The Limiter determines whether the compression is applied or not, based on the post-EQ trigger signal. Setting the equalizer allows you to set the Limiter to respond to any frequency band.

Multiband Limiter

This effect applies the Limiter to the low range, mid range, and high range of the input signal. You can control dynamics for each range to adjust the sound pressure of the low range, mid range, and high range in a different way from the EQ.

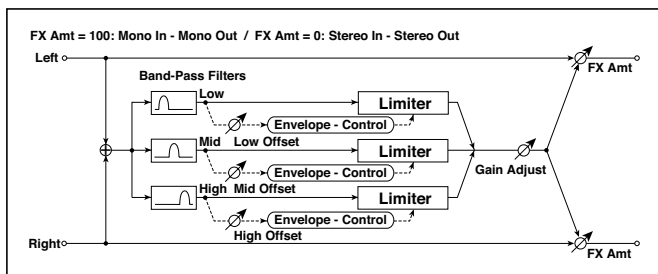

a	Ratio	1.0 : 1...50.0 : 1, Inf : 1	Sets the signal compression ratio	
b	Threshold [dB]	-40...0	Sets the level above which the compressor is applied	
c	Attack	1...100	Sets the attack time	
d	Release	1...100	Sets the release time	
e	Low Offset [dB]	-40...0	Gain of the low-range trigger signal	
f	Mid Offset [dB]	-40...0	Gain of the mid-range trigger signal	

g	High Offset [dB]	-40...0	Gain of the high-range trigger signal	
h	Gain Adjust [dB]	-Inf, -38...+24	Sets the output gain	
	Src	Off...Tempo	Selects the modulation source for the output gain	
	Amt	-63...+63	Sets the modulation amount of the output gain	
i	Wet/Dry	Dry, 1:99...99:1, Wet	Balance between the wet and dry signal	
	Src	Off...Tempo	See DMS (Dynamic Modulation Source)	
	Amt	-100...+100	Amount of modulation source	

e: Low Offset [dB]

f: Mid Offset [dB]

g: High Offset [dB]

These parameters set the gain of the trigger signal.

For example, if you do not want to apply compression to the high range, reduce the "High Offset" value down below the "Threshold" level. In this way, the high range limiter will not respond, and compression will not be applied.

St. Midband Limiter (Stereo Multiband Limiter)

This is a stereo multiband limiter.

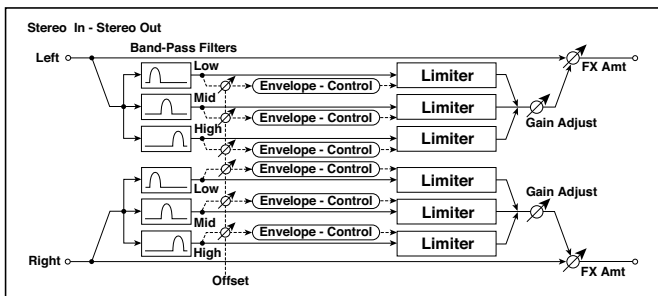

a	Ratio	1.0 : 1... 50.0 : 1, Inf : 1	Sets the signal compression ratio	
b	Threshold [dB]	-40...0	Sets the level above which the compressor is applied	
c	Attack	1..100	Sets the attack time	

d	Release	1...100	Sets the release time
e	Low Offset [dB]	-40...0	Sets the low range gain of trigger signal
f	Mid Offset [dB]	-40...0	Sets the mid range gain of trigger signal
g	High Offset [dB]	-40...0	Sets the high range gain of trigger signal
h	Gain Adjust [dB]	-Inf, -38...+24	Sets the output gain
	Src	Off...Tempo	Selects the modulation source for the output gain
	Amt	-63...+63	Sets the modulation amount of the output gain
i	Wet/Dry	Dry, 1:99...99:1, Wet	Balance between the wet and dry signal
	Src	Off...Tempo	See DMS (Dynamic Modulation Source)
	Amt	-100...+100	Amount of modulation source

St.Mastering Limitr (Stereo Mastering Limiter)

This is a stereo limiter that is optimized for mastering songs.

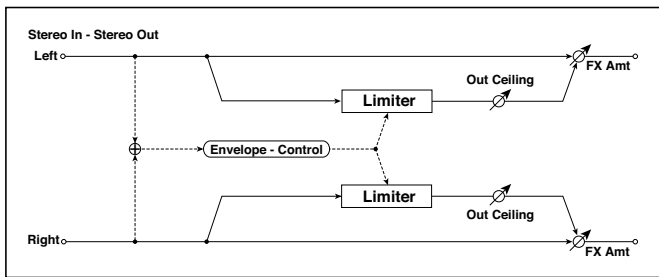

a	Threshold [dB]	-30.0...0.0	Sets the level above which the compressor is applied
b	Out Ceiling [dB]	-30.0...0.0	Sets the output gain
c	Release [msec]	0.50...1000.0	Sets the release time
d	Wet/Dry	Dry, 1:99...99:1, Wet	Balance between the wet and dry signal
	Src	Off...Tempo	See DMS (Dynamic Modulation Source)
	Amt	-100...+100	Amount of modulation source

Stereo Gate

This effect mutes the input signal when it falls below a specified level. You can also invert the on/off status of the gate, or use note-on/off messages to turn the gate on/off directly.

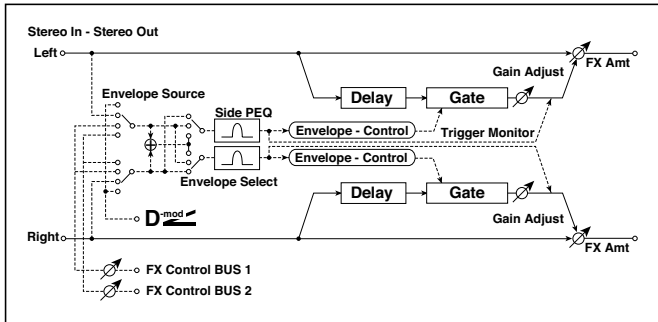

a	Envelope Source	D-mod, Input	Selects the source to control the gate: D-mod control, or use the input signal as a trigger
b	Envelope Select	L/R Mix, L Only, R Only	Selects the control signal: left and right linked, left only, or right only
	Src	Off...Tempo	Selects the source that will control the gate when Envelope Src = D-mod
c	Threshold	0...100	Sets the level at which gating is applied
	Polarity	+, -	Switches the polarity of gating
d	Attack	1...100	Sets the attack time
	Release	1...100	Sets the release time
e	Delay Time [msec]	0...100	Sets the delay time for the gate input
f	Side PEQ Insert	Off, On	Switches the trigger signal equalizer on/off
	Trigger Monitor	Off, On	Switches between monitoring the effect output and the trigger signal
g	Side PEQ Cutoff [Hz]	20...12.00k	Sets the center frequency of the equalizer for the trigger signal
	Q	0.5...10.0	Sets the bandwidth of the equalizer for the trigger signal
	Gain [dB]	-18.0...+18.0	Sets the gain of the equalizer for the trigger signal

h	Wet/Dry	Dry, 1:99...99:1, Wet	Balance between the wet and dry signal
	Src	Off...Tempo	See DMS (Dynamic Modulation Source)
	Amt	-100...+100	Amount of modulation source

c: Threshold

d: Attack

d: Release

“Threshold” specifies the level at which gating occurs when “Envelope Select” is set to L/R Mix, L Only, or R Only.

“Attack” and “Release” specify the attack time and release time of the gate.

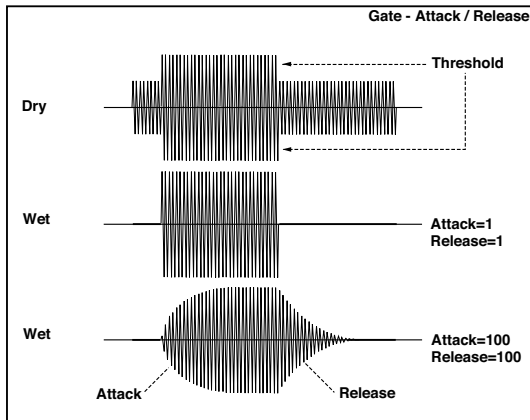
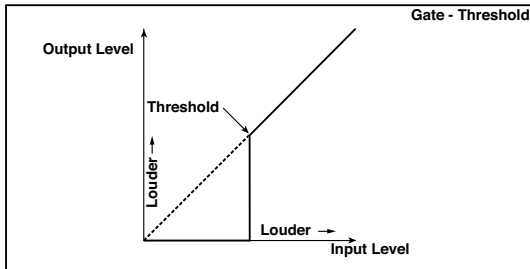

c: Polarity

This inverts the polarity of the gate on/off operation. With the “-” setting, the gate will close when the input signal exceeds the specified level. The direction in which the modulation source opens or closes the gate will also be reversed.

e: Delay Time [msec]

This sets the delay time for the input to the gate. When using shorter Attack Time settings, you can lengthen the Delay Time so that the sound is input after the gate opens.

AMP (Amplifier)

Pa4X includes accurate guitar and bass amplifier and cabinet modeling. Some of the effects combine an amplifier and a cabinet model.

Modelling amplifiers

Pa4X comes with a wide selection of the best amps, that offer the widest possible array of great tones. The operating mode of the preamp and power amp, the response of the tone controls, and their placement within the circuit will change depending on the type of amp you select, precisely replicating the exact gain and tonal character of the original amp. The all-important power amp stage (class A or AB) and negative-feedback circuit (or lack thereof) are also carefully simulated.

The volume controls

Two main controls affect the volume (or gain) and at the same time the tone of the amp: **Drive Gain** (controlling the preamp gain and the amount of preamp distortion) and **Volume** (controlling the preamp output level). Each control has its own specific job, and the sound of a particular amp model can vary over a very wide range just depending on the settings of these controls.

In addition, the **Cabinet Trim** control (a power attenuator) is placed between the output of your amp and the input of your speaker cabinet. At the end of the signal path, the **Wet/Dry** parameter in the **FX Edit** page, and the **Master knob** in the **Mixer/Tuning > FX Send** page, control the level of the final mix and allows you to balance all your presets to each other.

We have made the relationship between preamp and power amp work in the same way as in the original amps. Therefore, to obtain truly authentic tones, please use the **Pre/Drive Gain** parameter to control the preamp distortion, and the **Volume** parameter to control the distinctive distortion and warmth of the power amp stage.

Be advised that setting the **Drive Gain** too high will result in heavy distortion, and is not recommended.

Tube talk

'Tubes' is the name adopted in the USA, while 'valves' is the British equivalent. As all the amps we've modelled come from one of the two countries just mentioned, we will use the corresponding term in the following descriptions.

Also, please note that an **ECC83** preamp valve is the British version of a **12AX7** preamp tube used in the USA.

Modelling speaker cabinets

The accurate amp models can be paired with speaker cabinet models of the same quality. The output stage of a tube amp works in close harmony with the varying impedance curve of the speaker(s) it is driving. This intimate and vital relationship plays a major role in producing the warm, punchy sound and pleasing feel of tube amps.

Modelling a speaker cabinet is not just a case of frequency response, but is a combination of frequency response, transient response (how a speaker reacts to the strength of how a note is played), and the all-important interaction of the amps output to the speaker's impedance curve. In addition, other vitally important factors that have to be taken into account when modelling a cabinet are the actual physical dimensions of the enclosure (cabinet), the unique tonality of said enclosure (which will be affected by both the type and thickness of the wood it is made of) and whether it boasts an open, semi-open or closed-back design.

Amplifier types

These are the available amplifier types.

Amp Type	Meaning
VOX AC15	VOX AC15 manufactured in 1962
VOX AC15TB	VOX AC15TB (an AC15 modified by the addition of a top boost circuit).
VOX AC30	Normal channel of a VOX AC30TB
VOX AC30TB	Brilliant channel of a VOX AC30TB
UK BLUES	UK-manufactured vintage stack amp head
UK 70'S	High treble channel of a UK-manufactured 100W amp head from 1969
UK 80'S	UK-manufactured 100 Watt head from 1983
UK 90'S	Lead channel of a 100W dual channel head
UK MODERN	UK-manufactured 100W modern amp
US MODERN	High-gain amp with metal plate
US HIGAIN	1991 model 100W amp head covered in snake-skin
BOUTIQUE OD	Overdrive channel of a high-end 100W hand made amp
BOUTIQUE CL	Clean channel of a high-end, hand-made 100W amp
BLACK 2x12	2x12 combo amp indispensable for country or blues players
TWEED - 1x12	Combo amp covered in tweed cloth
TWEED - 4x10	4x10 combo amp designed for bass guitar

Cabinet types

When a cabinet can be chosen, these are the available types.

Cabinet Type	Meaning
TWEED - 1x12	Open-back cabinet with one 12" Alnico magnet speaker, typically used for blues. It is usually paired with the Tweed Amp.
TWEED - 4x10	Open-back cabinet with four 10" 8 Ohm Alnico magnet speakers, wired in parallel for a total of 2 Ohms impedance.
BLACK - 2x10	Open-back cabinet with two 10" ceramic magnet 35 Watt speakers.
BLACK - 2x12	American open-back cabinet with two 12" ceramic magnet speakers. They are 8 Ohm units wired in parallel for a 4 Ohm total load.
VOX AC15 - 1x12	Vox AC15 open-back cabinet with one 12" VOX Blue Alnico speaker, manufactured by Celestion in Ipswich, England.
VOX AC30 - 2x12	Vox AC30 open-back cabinet with two 12" VOX Blue Alnicos, wired in series for 16 Ohms.
VOX AD412 - 4x12	VOX AD412 closed-back cabinet with four 12" custom-designed Celestion speakers with Neodymium magnets.
UK H30 - 4x12	Closed-back classic cabinet with four 30W 12" speakers. Made in the late '60s by the same famous UK amp company as the UK T75 4x12.
UK T75 - 4x12	Closed-back cabinet loaded with four modern 75W 12" British speakers.
US V30 - 4x12	Closed-back cabinet with four 30W 12" speakers. This big cabinet uses four UK made Vintage named speakers and is known for its deep bass and high end detail.

Amp + Cabinet combinations

These are the recommended combinations of guitar amp models and cabinet simulators:

Amp Type	Cabinet Type
VOX AC15	VOX AC15 - 1x12
VOX AC15TB	VOX AC15 - 1x12
VOX AC30	VOX AC30 - 2x12
VOX AC30TB	VOX AC30 - 2x12
UK BLUES	UK H30 - 4x12
UK 70'S	UK H30 - 4x12
UK 80'S	UK T75 - 4x12
UK 90'S	UK T75 - 4x12
UK MODERN	UK T75 - 4x12, US V30 - 4x12
US MODERN	US V30 - 4x12
US HIGAIN	US V30 - 4x12, UK T75 - 4x12
BOUTIQUE OD	UK H30 - 4x12
BOUTIQUE CL	UK H30 - 4x12
BLACK 2x12	BLACK - 2x12
TWEED - 1x12	TWEED - 1x12
TWEED - 4x10	TWEED - 4x10

GuitarAmp + P4EQ (Guitar Amp Model + Parametric 4-Band EQ)

This combines a guitar amp simulation (which even faithfully replicates the distortion and tone control circuitry) with a four-band equalizer.

By using this in conjunction with St. Guitar Cabinet (Stereo Guitar Cabinet), you can obtain an even more realistic guitar sound that simulates a guitar amp + speaker cabinet.

In alternative, you can use the combined Guitar Amp + Cabinet effect, that does not include an EQ, but only takes a single FX slot.

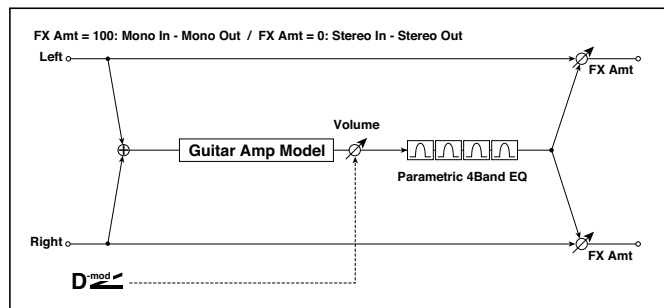

a	Amp Type	VOX AC15, VOX AC15TB, VOX AC30, VOX AC30TB, UK BLUES, UK 70'S, UK 80'S, UK 90'S, UK MODERN, US MODERN, US HIGAIN, BOUTIQUE OD, BOUTIQUE CL, BLACK 2x12, TWEED - 1x12, TWEED - 4x10	Selects the type of the amplifier
	Drive Gain	0...100	Sets the input gain
b	Volume	0...100	Sets the output level
	Src	Off...Tempo	Selects the modulation source for the output level
	Amt	-100...+100	Sets the modulation amount of the output level
c	Bass	0...100	Sets the bass (low range) level
	Middle	0...100	Sets the middle (mid range) level
d	Treble	0...100	Sets the treble (high range) level
	Presence	0...100	Sets the presence (high-frequency tone)

e	Post P4EQ	Thru, On	Selects through or on for the equalizer
f	Band1 Cutoff [Hz]	20...1.00k	Sets the center frequency of Band 1
	Q	0.5...10.0	Sets Band 1's bandwidth
	Gain [dB]	-18...+18	Sets the gain of Band 1
g	Band2 Cutoff [Hz]	50...5.00k	Sets the center frequency of Band 2
	Q	0.5...10.0	Sets Band 2's bandwidth
	Gain [dB]	-18...+18	Sets the gain of Band 2
h	Band3 Cutoff [Hz]	300...10.00k	Sets the center frequency of Band 3
	Q	0.5...10.0	Sets Band 3's bandwidth
	Gain [dB]	-18...+18	Sets the gain of Band 3
i	Band4 Cutoff [Hz]	500...20.00k	Sets the center frequency of Band 4
	Q	0.5...10.0	Sets Band 4's bandwidth
	Gain [dB]	-18...+18	Sets the gain of Band 4
j	Wet/Dry	Dry, 1:99...99:1, Wet	Balance between the wet and dry signal
	Src	Off...Tempo	See DMS (Dynamic Modulation Source)
	Amt	-100...+100	Amount of modulation source

a: Amp Type

d: Presence

If the Amp Type is VOX AC15...VOX AC30TB, this sets the attenuation of the high-frequency range. For other types, this sets the boost of the high-frequency range. This corresponds to the Cut knob control of amps made by the VOX Corporation.

e: Post P4EQ

By chaining this with 19: St.Guitar Cabinet you can simulate the combination of a guitar amp and speaker cabinet. In this case, we recommend that you set Post P4EQ to "Thru," but if necessary you can turn it "On" and adjust the tone.

GuitarAmp + Cabinet

As the above, minus the EQ, plus the cabinet.

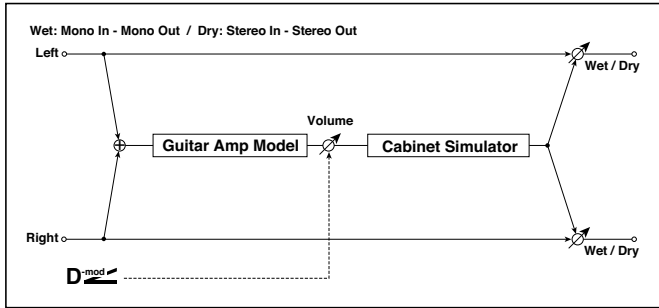

a	Amp Type	VOX AC15, VOX AC15TB, VOX AC30, VOX AC30TB, UK BLUES, UK 70'S, UK 80'S, UK 90'S, UK MODERN, US MODERN, US HIGAIN, BOUTIQUE OD, BOUTIQUE CL, BLACK 2x12, TWEED - 1x12, TWEED - 4x10	Selects the type of the amplifier	
b	Drive Gain	0...100	Sets the input gain	
c	Volume	0...100	Sets the output level	
	Src	Off...Tempo	Selects the modulation source for the output level	
	Amt	-100...+100	Sets the modulation amount of the output level	
d	Bass	0...100	Sets the bass (low range) level	
	Middle	0...100	Sets the middle (mid range) level	
	Treble	0...100	Sets the treble (high range) level	
	Presence/Cut	0...100	Sets the presence (high-frequency tone). With VOX amps, it simulates the Top Cut on the original AC30; with higher values, it cuts the high frequencies more.	

e	Cabinet Type	TWEED - 1x12, TWEED - 4x10, BLACK - 2x10, BLACK - 2x12, VOX AC15 - 1x12, VOX AC30 - 2x12, VOX AD412 - 4x12, UK H30 - 4x12, UK T75 - 4x12, US V30 - 4x12	Selects the cabinet type	
	Cabinet Trim	0...100	Sets the input level	
	Cabinet Air	0...100	Sets the mic position	
f	Noise Gate On/Off	On, Off	Switches Gate on/off	
	Threshold	0...100	Sets the level at which gating is applied	
	Attack	1...100	Sets the attack time	
	Release	1...100	Sets the release time	
g	Wet/Dry	Dry, 1:99...99:1, Wet	Balance between the wet and dry signal	
	Src	Off...Tempo	See DMS (Dynamic Modulation Source)	
	Amt	-100...+100	Amount of modulation source	

Amp Clean Combo

This models the clean channel of a amp that went on sale in 1975 and contained two 12" speakers. As the name suggests, it produces a clean tone with a tight sounding character, and a deep and compact low-end. When pushed hard the bass tends to crumble. The original amp doesn't have a Presence control but does have a Bright Switch. The Presence control on your Pa4X emulates this switch when Off and On, plus all points in-between.

a	Drive	0...100	Sets the input gain
b	Volume	0...100	Sets the output level
	Src	Off...Tempo	Selects the modulation source for the output level
	Amt	-100...+100	Sets the modulation amount of the output level
c	Bass	0...100	Sets the bass (low range) level
	Middle	0...100	Sets the middle (mid range) level
d	Treble	0...100	Sets the treble (high range) level
	Presence	0...100	Boosts the upper frequencies above the normal treble control range for added high-end
e	Wet/Dry	Dry, 1:99...99:1, Wet	Balance between the wet and dry signal
	Src	Off...Tempo	See DMS (Dynamic Modulation Source)
	Amt	-100...+100	Amount of modulation source

Amp Clean Combo + Cab

As the above, plus cabinet.

a	Drive	0...100	Sets the input gain	
b	Volume	0...100	Sets the output level	
	Src	Off...Tempo	Selects the modulation source for the output level	
	Amt	-100...+100	Sets the modulation amount of the output level	
c	Bass	0...100	Sets the bass (low range) level	
	Middle	0...100	Sets the middle (mid range) level	
d	Treble	0...100	Sets the treble (high range) level	
	Presence	0...100	Sets the presence (high-frequency tone)	
e	Cabinet Type	TWEED - 1x12, TWEED - 4x10, BLACK - 2x10, BLACK - 2x12, VOX AC15 - 1x12, VOX AC30 - 2x12, VOX AD412 - 4x12, UK H30 - 4x12, UK T75 - 4x12, US V30 - 4x12	Selects the cabinet type	
f	Cabinet Trim	0...100	Sets the input level	
g	Cabinet Air	0...100	Sets the mic position	
h	Noise Gate On/Off	On, Off	Switches Gate on/off	
	Threshold	0...100	Sets the level at which gating is applied	
	Attack	1...100	Sets the attack time	
	Release	1...100	Sets the release time	
i	Wet/Dry	Dry, 1:99...99:1, Wet	Balance between the wet and dry signal	
	Src	Off...Tempo	See DMS (Dynamic Modulation Source)	
	Amt	-100...+100	Amount of modulation source	

Amp California

This 45W American combo amp with four 10" speakers, produced in South California during the years 1963-1968, was known for its big, clean sound and its warm and husky sound when driven heavily. This amp's medium output and powerful sound was a favorite in clubs.

Original's tube compliment: 4 x 12AX7 in the preamp, 1 x 5AR4 rectifier tube, 2 x 6L6 tubes in the power amp, plus 2 x 12AT7 tubes.

a	Drive	0...100	Sets the input gain	
b	Volume	0...100	Sets the output level	
	Src	Off...Tempo	Selects the modulation source for the output level	
	Amt	-100...+100	Sets the modulation amount of the output level	
c	Bass	0...100	Sets the bass (low range) level	
	Middle	0...100	Sets the middle (mid range) level	
d	Treble	0...100	Sets the treble (high range) level	
	Presence	0...100	Sets the presence (high-frequency tone)	
e	Wet/Dry	Dry, 1:99...99:1, Wet	Balance between the wet and dry signal	
	Src	Off...Tempo	See DMS (Dynamic Modulation Source)	
	Amt	-100...+100	Amount of modulation source	

Amp California + Cab

As the above, plus cabinet.

a	Drive	0...100	Sets the input gain	
b	Volume	0...100	Sets the output level	
	Src	Off...Tempo	Selects the modulation source for the output level	
	Amt	-100...+100	Sets the modulation amount of the output level	
c	Bass	0...100	Sets the bass (low range) level	
	Middle	0...100	Sets the middle (mid range) level	
d	Treble	0...100	Sets the treble (high range) level	
	Presence	0...100	Sets the presence (high-frequency tone)	
e	Cabinet Type	TWEED - 1x12, TWEED - 4x10, BLACK - 2x10, BLACK - 2x12, VOX AC15 - 1x12, VOX AC30 - 2x12, VOX AD412 - 4x12, UK H30 - 4x12, UK T75 - 4x12, US V30 - 4x12	Selects the cabinet type	
f	Cabinet Trim	0...100	Sets the input level	
g	Cabinet Air	0...100	Sets the mic position	
h	Noise Gate On/Off	On, Off	Switches Gate on/off	
	Threshold	0...100	Sets the level at which gating is applied	
	Attack	1...100	Sets the attack time	
	Release	1...100	Sets the release time	
i	Wet/Dry	Dry, 1:99...99:1, Wet	Balance between the wet and dry signal	
	Src	Off...Tempo	See DMS (Dynamic Modulation Source)	
	Amt	-100...+100	Amount of modulation source	

Amp Tweed

This 40W American-made tweed-covered 1957 model combo amp with two 12" speakers is known for its rich, clean tone that is ideal for classic rock, blues, and country. By raising the volume you can also produce a powerful and punchy overdrive sound. It quickly became a favorite of the greatest bands of the '60s, and is what you can call 'the classic tone'. Its nickname came from the use of lacquered tweed fronted with vintage brown/gold grille cloth, that gave it that sophisticated look.

Original's tube compliment: 4 x 12AX7 in the preamp, 2 x 5U4 rectifier tube, 2 x 6X4 tubes in the power amp.

a	Drive	0...100	Sets the input gain	
b	Volume	0...100	Sets the output level	
	Src	Off...Tempo	Selects the modulation source for the output level	
	Amt	-100...+100	Sets the modulation amount of the output level	
c	Bass	0...100	Sets the bass (low range) level	
	Middle	0...100	Sets the middle (mid range) level	
d	Treble	0...100	Sets the treble (high range) level	
	Presence	0...100	Sets the presence (high-frequency tone)	
e	Wet/Dry	Dry, 1:99...99:1, Wet	Balance between the wet and dry signal	
	Src	Off...Tempo	See DMS (Dynamic Modulation Source)	
	Amt	-100...+100	Amount of modulation source	

Amp Tweed + Cab

As the above, plus cabinet.

a	Drive	0...100	Sets the input gain	
b	Volume	0...100	Sets the output level	
	Src	Off...Tempo	Selects the modulation source for the output level	
	Amt	-100...+100	Sets the modulation amount of the output level	
c	Bass	0...100	Sets the bass (low range) level	
	Middle	0...100	Sets the middle (mid range) level	
d	Treble	0...100	Sets the treble (high range) level	
	Presence	0...100	Sets the presence (high-frequency tone)	
e	Cabinet Type	TWEED - 1x12, TWEED - 4x10, BLACK - 2x10, BLACK - 2x12, VOX AC15 - 1x12, VOX AC30 - 2x12, VOX AD412 - 4x12, UK H30 - 4x12, UK T75 - 4x12, US V30 - 4x12	Selects the cabinet type	
f	Cabinet Trim	0...100	Sets the input level	
g	Cabinet Air	0...100	Sets the mic position	
h	Noise Gate On/Off	On, Off	Switches Gate on/off	
	Threshold	0...100	Sets the level at which gating is applied	
	Attack	1...100	Sets the attack time	
	Release	1...100	Sets the release time	
i	Wet/Dry	Dry, 1:99...99:1, Wet	Balance between the wet and dry signal	
	Src	Off...Tempo	See DMS (Dynamic Modulation Source)	
	Amt	-100...+100	Amount of modulation source	

Amp Modded OD

This models the Overdrive channel of a 100W boutique amp head produced in North Hollywood. Its beautifully deep and rounded low-end, delightfully transient midrange attack and sweet treble, with an harmonically rich overdrive, the lushest clean tone, woody attack and blooming sustain, make it an instant pleasure to play.

Original's tube compliment: 2 x 12AX7s in the preamp, 1 x 12AX7s rectifier, 4 x EL34s (or 6L6s) in the power amp.

a	Drive	0...100	Sets the input gain	
b	Volume	0...100	Sets the output level	
	Src	Off...Tempo	Selects the modulation source for the output level	
	Amt	-100...+100	Sets the modulation amount of the output level	
c	Bass	0...100	Sets the bass (low range) level	
	Middle	0...100	Sets the middle (mid range) level	
d	Treble	0...100	Sets the treble (high range) level	
	Presence	0...100	Sets the presence (high-frequency tone)	
e	Wet/Dry	Dry, 1:99...99:1, Wet	Balance between the wet and dry signal	
	Src	Off...Tempo	See DMS (Dynamic Modulation Source)	
	Amt	-100...+100	Amount of modulation source	

Amp Modded OD + Cab

As the above, plus cabinet.

a	Drive	0...100	Sets the input gain	
b	Volume	0...100	Sets the output level	
	Src	Off...Tempo	Selects the modulation source for the output level	
	Amt	-100...+100	Sets the modulation amount of the output level	
c	Bass	0...100	Sets the bass (low range) level	
	Middle	0...100	Sets the middle (mid range) level	
d	Treble	0...100	Sets the treble (high range) level	
	Presence	0...100	Sets the presence (high-frequency tone)	
e	Cabinet Type	TWEED - 1x12, TWEED - 4x10, BLACK - 2x10, BLACK - 2x12, VOX AC15 - 1x12, VOX AC30 - 2x12, VOX AD412 - 4x12, UK H30 - 4x12, UK T75 - 4x12, US V30 - 4x12	Selects the cabinet type	
f	Cabinet Trim	0...100	Sets the input level	
g	Cabinet Air	0...100	Sets the mic position	
h	Noise Gate On/Off	On, Off	Switches Gate on/off	
	Threshold	0...100	Sets the level at which gating is applied	
	Attack	1...100	Sets the attack time	
	Release	1...100	Sets the release time	
i	Wet/Dry	Dry, 1:99...99:1, Wet	Balance between the wet and dry signal	
	Src	Off...Tempo	See DMS (Dynamic Modulation Source)	
	Amt	-100...+100	Amount of modulation source	

St. Guitar Cabinet (Stereo Guitar Cabinet)

This simulates the acoustical character of a guitar amp’s speaker cabinet.

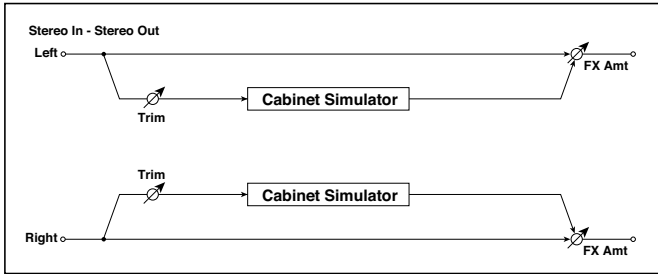

a	Trim	0...100	Sets the input level	
b	Type	TWEED - 1x12, TWEED - 4x10, BLACK - 2x10, BLACK - 2x12, VOX AC15 - 1x12, VOX AC30 - 2x12, VOX AD412 - 4x12, UK H30 - 4x12, UK T75 - 4x12, US V30 - 4x12	Selects the cabinet type	
c	Air	0...100	Sets the mic position	
d	Wet/Dry	Dry, 1:99...99:1, Wet	Balance between the wet and dry signal	
	Src	Off...Tempo	See DMS (Dynamic Modulation Source)	
	Amt	-100...+100	Amount of modulation source	

Gtr. Cabinet + NR (Guitar Cabinet + Noise Reduction)

Guitar cabinet and Noise Reduction.

	NR Sens	Off, 1...100	Noise Reduction sensitivity	
a	Trim	0...100	Sets the input level	
b	Type	TWEED - 1x12, TWEED - 4x10, BLACK - 2x10, BLACK - 2x12, VOX AC15 - 1x12, VOX AC30 - 2x12, VOX AD412 - 4x12, UK H30 - 4x12, UK T75 - 4x12, US V30 - 4x12	Selects the cabinet type	
c	Air	0...100	Sets the mic position	
d	Wet/Dry	Dry, 1:99...99:1, Wet	Balance between the wet and dry signal	
	Src	Off...Tempo	See DMS (Dynamic Modulation Source)	
	Amt	-100...+100	Amount of modulation source	

OD/HG - Amp Sim (Overdrive/Hi.Gain - Amp Simulation)

This effect combines a mono overdrive/high-gain distortion and an amp simulation. You can change the order of the effects.

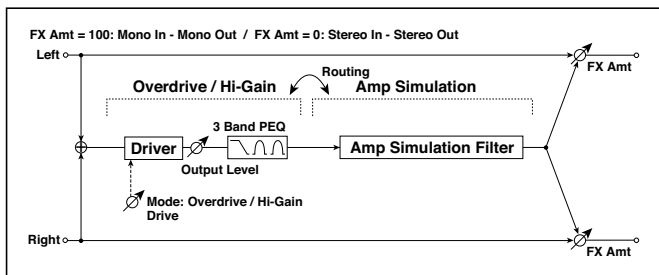

OD/HI-GAIN			
a	[O]Drive Mode	Overdrive, Hi-Gain	Switches between overdrive and high-gain distortion
	Drive	1...100	Sets the degree of distortion
b	[O]Output Level	0...50	Sets the overdrive output level
	Src	Off...Tempo	Selects the modulation source for the overdrive output level
	Amt	-50...+50	Sets the modulation amount of the overdrive output level
e	[O]Low Cutoff [Hz]	20...1.00k	Sets the center frequency for Low EQ (shelving type)
	Gain [dB]	-18...+18	Sets the gain of Low EQ
f	[O]Mid1 Cutoff [Hz]	300...10.00k	Sets the center frequency for Mid/High EQ 1 (peaking type)
	Q	0.5...10.0	Sets the band width of Mid/High EQ 1
	Gain [dB]	-18...+18	Sets the gain of Mid/High EQ 1
g	[O]Mid2 Cutoff [Hz]	500...20.00k	Sets the center frequency for Mid/High EQ 2 (peaking type)
	Q	0.5...10.0	Sets the band width of Mid/High EQ 2
	Gain [dB]	-18...+18	Sets the gain of Mid/High EQ 2
AMP SIM			
h	[A]Amplifier Type	SS, EL84, 6L6	Selects the type of guitar amplifie
i	Routing	OD/HG > Amp, Amp > OD/HG	Switches the order of the overdrive and amp
j	Wet/Dry	Dry, 1:99...99:1, Wet	Balance between the wet and dry signal
	Src	Off...Tempo	See DMS (Dynamic Modulation Source)
	Amt	-100...+100	Amount of modulation source

OD/Hi.Gain Wah (Overdrive/Hi.Gain Wah)

This distortion effect utilizes an Overdrive mode and a Hi-Gain mode. Controlling the wah effect, the 3-band EQ, and the amp simulation will allow you to create versatile distortion sounds. This effect is suitable for guitar and organ sounds.

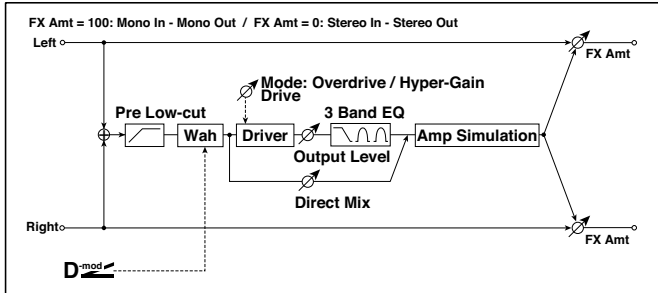

a	Wah	Off, On	Switches Wah on/off
	Src	Off...Tempo	Selects the modulation source that switches the Wah on and off
	Sw	Toggle, Moment	Selects the switching mode for the modulation source that switches the Wah on and off
b	Wah Sweep Range	-10...+10	Sets the range of Wah
	Wah Sweep Src	Off...Tempo	Selects the modulation source that controls the Wah
c	Drive Mode	Overdrive, Hi-Gain	Switches between overdrive and hi-gain distortion
d	Drive	1...100	Sets the degree of distortion
	Pre Low-cut	0...10	Sets the low range cut amount of the distortion input
e	Output Level	0...50	Sets the output level
	Src	Off...Tempo	Selects the modulation source for the output level
	Amt	-50...+50	Sets the modulation amount of the output level
f	Low Cutoff [Hz]	20...1.00k	Sets the center frequency for Low EQ (shelving type)
	Gain [dB]	-18...+18	Sets the gain of Low EQ

g	Mid1Cutoff [Hz]	300...10.00k	Sets the center frequency for Mid/High EQ 1 (peaking type)
	Q	0.5...10.0	Sets the band width of Mid/High EQ 1
	Gain [dB]	-18...+18	Sets the gain of Mid/High EQ 1
h	Mid2 Cutoff [Hz]	500...20.00k	Sets the center frequency for Mid/High EQ 2 (peaking type)
	Q	0.5...10.0	Sets the band width of Mid/High EQ 2
	Gain [dB]	-18...+18	Sets the gain of Mid/High EQ 2
i	Direct Mix	0...50	Sets the amount of the dry sound mixed to the distortion
	Speaker Simulation	Off, On	Switches the speaker simulation on/off
j	Wet/Dry	Dry, 1:99...99:1, Wet	Balance between the wet and dry signal
	Src	Off...Tempo	See DMS (Dynamic Modulation Source)
	Amt	-100...+100	Amount of modulation source

a: Wah

The Wah parameter switches the wah effect on/off.

a: Sw

This parameter sets how the wah effect is switched on and off via the modulation source.

When "Sw" = Moment, the wah effect is usually turned off. It is turned on only when you press the pedal or operate the joystick.

MIDI When a value for the modulation source is less than 64, "off" speed is selected, and when the value is 64 or higher, "on" is selected.

When "Sw" = Toggle, the wah effect is switched between on and off each time you press the pedal or operate the joystick.

MIDI The switch will be turned on/off each time the value of the modulation source exceeds 64.

b: Wah Sweep Range

b: Wah Sweep Src

This parameter sets the sweep range of the wah center frequency. A negative value will reverse the direction of sweep. The wah center frequency can

be controlled by the modulation source specified in the “Wah Sweep Src” parameter.

d: Pre Low-cut

Cutting the signal in the low range before it is input to the Distortion will create a sharp distortion.

d: Drive

e: Output Level

The degree of distortion is determined by the level of input signal and the setting of “Drive”. Raising the “Drive” setting will cause the entire volume level to increase. Use the “Output Level” parameter to adjust the volume level. The “Output Level” parameter uses the signal level input to the 3-Band EQ. If clipping occurs at the 3-Band EQ, adjust the “Output Level” parameter.

OD/HyperGain Wah (Overdrive/Hyper Gain Wah)

This distortion effect has two modes: overdrive and hyper-gain that produces a strong distortion. A higher high-gain setting is required for this effect relative to a normal-size effect.

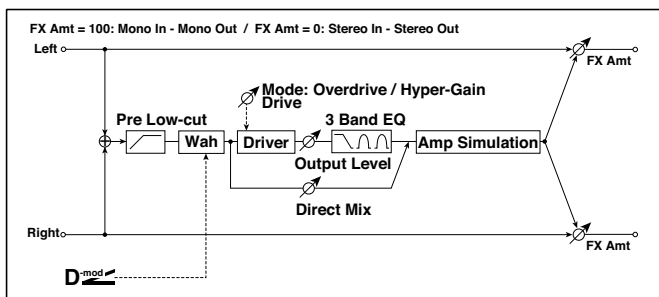

a	Wah	Off, On	Switches Wah on/off	
	Src	Off...Tempo	Selects the modulation source that switches the Wah on and off	
	Sw	Toggle, Moment	Selects the switching mode for the modulation source that switches the Wah on and off	
b	Wah Sweep Range	-10...+10	Sets the range of Wah	
	Wah Sweep Src	Off...Tempo	Selects the modulation source that controls the Wah	

c	Drive Mode	Overdrive, Hyper-Gain	Switches between overdrive and hi-gain distortion
d	Drive	1...120	Sets the degree of distortion
	Pre Low-cut	0...10	Sets the low range cut amount of the distortion input
e	Output Level	0...50	Sets the output level
	Src	Off...Tempo	Selects the modulation source for the output level
	Amt	-50...+50	Sets the modulation amount of the output level
f	Low Cutoff [Hz]	20...1.00k	Sets the center frequency for Low EQ (shelving type)
	Gain [dB]	-18...+18	Sets the gain of Low EQ
g	Mid1 Cutoff [Hz]	300...10.00k	Sets the center frequency for Mid/High EQ 1 (peaking type)
	Q	0.5...10.0	Sets the band width of Mid/High EQ 1
	Gain [dB]	-18...+18	Sets the gain of Mid/High EQ 1
h	Mid2 Cutoff [Hz]	500...20.00k	Sets the center frequency for Mid/High EQ 2 (peaking type)
	Q	0.5...10.0	Sets the band width of Mid/High EQ 2
	Gain [dB]	-18...+18	Sets the gain of Mid/High EQ 2
i	Direct Mix	0...50	Sets the amount of the dry sound mixed to the distortion
	Speaker Simulation	Off, On	Switches the speaker simulation on/off
j	Wet/Dry	Dry, 1:99...99:1, Wet	Balance between the wet and dry signal
	Src	Off...Tempo	See DMS (Dynamic Modulation Source)
	Amt	-100...+100	Amount of modulation source

Comp - Amp Sim (Compressor - Amp Simulation)

This effect combines a mono compressor and an amp simulation. You can change the order of the effects.

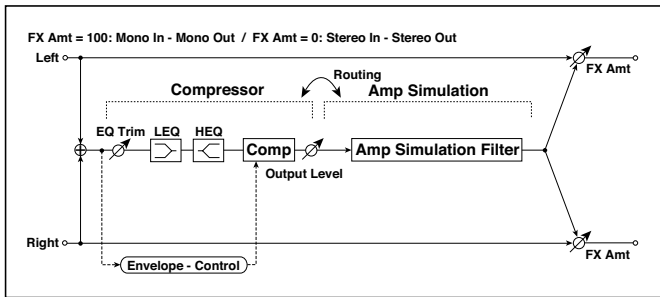

COMPRESSOR

a	[C] Sensitivity	1...100	Sets the sensitivity	
b	[C]Attack	1...100	Sets the attack level	
	Output Level	0...100	Sets the compressor output level	
c	[C]EQ Trim	0...100	Sets the EQ input level	
d	[C]Pre LEQ Gain [dB]	-15...+15	Sets the gain of Low EQ	
	Pre HEQ Gain [dB]	-15...+15	Sets the gain of High EQ	

AMP SIM

e	[A]Amplifier Type	SS, EL84, 6L6	Selects the type of guitar amplifier	
f	Routing	Comp > Amp, Amp > Comp	Switches the order of the compressor and amp simulation	
g	Wet/Dry	Dry, 1:99...99:1, Wet	Balance between the wet and dry signal	
	Src	Off...Tempo	See DMS (Dynamic Modulation Source)	
	Amt	-100...+100	Amount of modulation source	

Comp - OD/HiGain (Compressor - Overdrive/HiGain)

This effect combines a mono compressor and an overdrive/high-gain distortion. You can change the order of the effects.

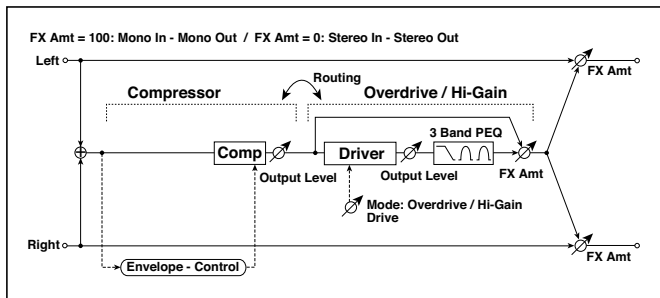

COMPRESSOR			
a	[C] Sensitivity	1...100	Sets the sensitivity
b	[C] Attack	1...100	Sets the attack level
	Output Level	0...100	Sets the compressor output level
OD/HI-GAIN			
c	[O] Drive Mode	Overdrive, Hi-Gain	Switches between overdrive and high-gain distortion
	Drive	1...100	Sets the degree of distortion
d	[O]Output Level	0...50	Sets the overdrive output level
	Src	Off...Tempo	Selects the modulation source for the overdrive output level
	Amt	-50...+50	Sets the modulation amount of the overdrive output level
e	[O]Low Cutoff [Hz]	20...1.00k	Sets the center frequency for Low EQ (shelving type)
	Gain [dB]	-18...+18	Sets the gain of Low EQ
f	[O]Mid1 Cutoff [Hz]	300...10.00k	Sets the center frequency for Mid/High EQ 1 (peaking type)
	Q	0.5...10.0	Sets the band width of Mid/High EQ 1
	Gain [dB]	-18...+18	Sets the gain of Mid/High EQ 1
g	[O]Mid2 Cutoff [Hz]	500...20.00k	Sets the center frequency for Mid/High EQ 2 (peaking type)
	Q	0.5...10.0	Sets the band width of Mid/High EQ 2
	Gain [dB]	-18...+18	Sets the gain of Mid/High EQ 2

h	[O]Wet/Dry	Dry, 1 : 99...99 : 1, Wet	Sets the overdrive effect balance	
	Src	Off...Tempo	Selects the Wet/Dry modulation source for the overdrive	
	Amt	-100...+100	Sets the Wet/Dry modulation amount for the overdrive	
i	Routing	Comp > OD/HG, OD/HG > Comp	Switches the order of the compressor and overdrive	
j	Wet/Dry	Dry, 1:99...99:1, Wet	Balance between the wet and dry signal	
	Src	Off...Tempo	See DMS (Dynamic Modulation Source)	
	Amt	-100...+100	Amount of modulation source	

Wah - Amp Sim (Wah - Amp Simulation)

This effect combines a mono wah and an amp simulation. You can change the order of the effects.

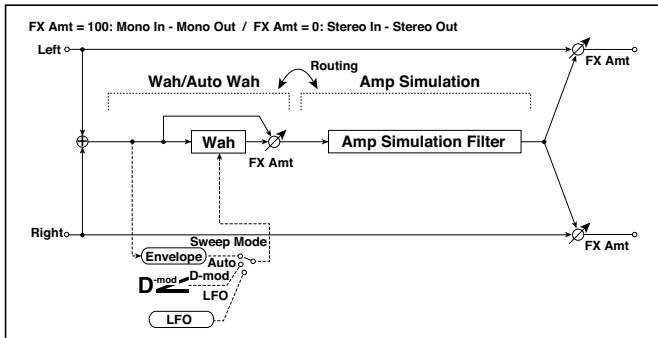

WAH				
a	[W]Frequency Bottom	0...100	Sets the lower limit of the wah center frequency	
	Frequency Top	0...100	Sets the upper limit of the wah center frequency	
b	[W]Sweep Mode	Auto, D-mod, LFO	Selects the control from auto-wah, modulation source, and LFO	
	Src	Off...Tempo	Selects the modulation source for the wah when Sweep Mode=D-mod	

c	[W]LFO Frequency [Hz]	0.02...20.00	Sets the speed of the LFO
	Resonance	0...100	Sets the resonance amount
	LPF	Off, On	Switches the wah low pass filter on and off
d	[W]Wet/Dry	Dry, 1:99...99:1, Wet	Sets the wah effect balance
	Src	Off...Tempo	Selects the Wet/Dry modulation source for the wah
	Amt	-100...+100	Sets the Wet/Dry modulation amount for the wah
AMP SIM			
e	[A]Amplifier Type	SS, EL84, 6L6	Selects the type of guitar amplifier
f	Routing	Wah > Amp, Amp > Wah	Switches the order of the wah and amp simulation
g	Wet/Dry	Dry, 1:99...99:1, Wet	Balance between the wet and dry signal
	Src	Off...Tempo	See DMS (Dynamic Modulation Source)
	Amt	-100...+100	Amount of modulation source

Decimator - Amp (Decimator - Amp Simulation)

This effect combines a mono decimator and an amp simulation. You can change the order of the effects.

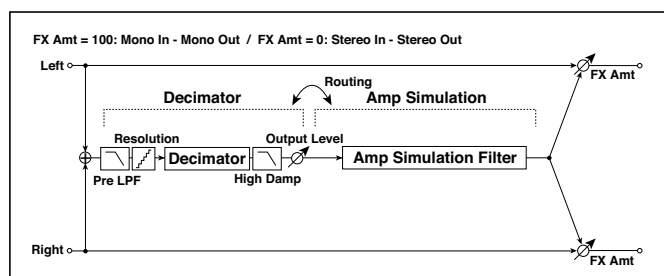

DECIMATOR			
a	[D]Pre LPF	Off, On	Turn the harmonic noise caused by lowered sampling on and off
	High Damp [%]	0...100	Sets the ratio of high-range damping

b	[D]Sampling Freq [Hz]	1.00k...48.00k	Sets the sampling frequency
	Resolution	4...24	Sets the data bit length
c	[D]Output Level	0...100	Sets the decimator output level
AMP SIM			
d	[A]Amplifier Type	SS, EL84, 6L6	Selects the type of guitar amplifier
e	Routing	Decimator > Amp, Amp > Decimator	Switches the order of the decimator and amp simulation
f	Wet/Dry	Dry, 1:99...99:1, Wet	Balance between the wet and dry signal
	Src	Off...Tempo	See DMS (Dynamic Modulation Source)
	Amt	-100...+100	Amount of modulation source

AmpSim - Tremolo (Amp Simulation- Tremolo)

This effect combines a mono amp simulation and a tremolo.

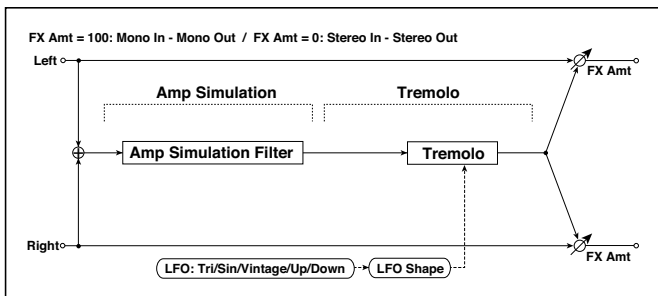

AMP SIM			
a	[A]Amplifier Type	SS, EL84, 6L6	Selects the type of guitar amplifier
TREMOLO			
b	[T]LFO Waveform	Triangle, Sine, Vintage, Up, Down	Selects the LFO Waveform
	LFO Shape	-100...+100	Changes the curvature of the LFO Waveform
c	[T]LFO Frequency [Hz]	0.02...20.00	Sets the speed of the LFO
d	[T]Depth	0...100	Sets the depth of LFO modulation

e	Wet/Dry	Dry, 1:99...99:1, Wet	Balance between the wet and dry signal
	Src	Off...Tempo	See DMS (Dynamic Modulation Source)
	Amt	-100...+100	Amount of modulation source

BassTubeAmp+Cab. (Bass Tube Amp Model + Cabinet)

This simulates a bass amp (with gain and drive) and speaker cabinet.

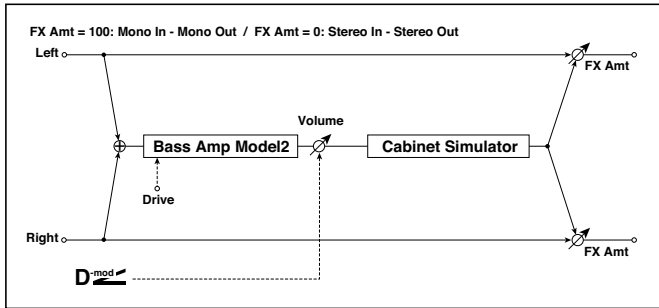

a	Amp Type		Selects the type of the amplifier	
		STUDIO COMBO	A tube combo ideal for the Motown sound	
		VOX AC100	A 100W tube amp AC100 made by Vox	
		UK MAJOR	A 200W tube amp made in the UK	
b	Drive Gain	0...100	Sets the input gain	
c	Volume	0...100	Sets the output level	
		Src	Off...Tempo	Selects the modulation source for the output level
		Amt	-100...+100	Sets the modulation amount of the output level
d	Bass	0...100	Sets the bass (low range) level	
e	Middle	0...100	Sets the middle (mid range) level	
f	Treble	0...100	Sets the treble (high range) level	
g	Presence	0...100	Sets the presence (high-frequency tone)	
h	Cabinet Simulator	Off, On	Switches the cabinet simulator on/off	

i	Cabinet Type	LA - 4x10, MODERN - 4x10, METAL - 4x10, CLASSIC - 8x10, UK - 4x12, STUDIO - 1x15, JAZZ - 1x15, VOX AC100 - 2x15, US - 2x15, UK - 4x15, LA - 1x18, COMBI - 1x12 & 1x18	Selects the cabinet type	
j	Wet/Dry	Dry, 1:99...99:1, Wet	Balance between the wet and dry signal	
	Src	Off...Tempo	See DMS (Dynamic Modulation Source)	
	Amt	-100...+100	Amount of modulation source	

a: Amp Type

i: Cabinet Type

Recommended Combinations of Bass Amp Models and Cabinets:

Amp Type	Cabinet Type
STUDIO COMBO	STUDIO - 1x15
AC100	VOX AC100 - 2x15
UK MAJOR	UK - 4x15, UK - 4x12

Bass Amp Model

This simulates a bass amp.

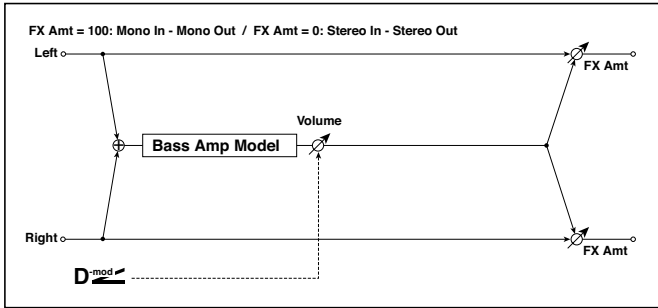

a	Amp Type		Selects the amplifier type	
		LA STUDIO	An amp that is typical of the LA sound.	
		JAZZ	A combo amp favored by jazz bassists.	
		GOLD PANEL	An amp distinctive for its eye-catching gold panel and clean sound.	
		SCOOPED	An amp typical of 80's sounds.	
		VALVE2	A tube amp suitable for rock.	
		VALVE	A tube amp with the ULTRA LO switch turned ON.	
b	Volume	0...100	Sets the output level	
		Src	Off...Tempo	Selects the modulation source for the output level
		Amt	-100...+100	Sets the modulation amount of the output level
c	Bass	0...100	Sets the bass (low range) level	
d	Middle	0...100	Sets the middle (mid range) level	
		Mid Range	0...4	Sets the mid-frequency range
e	Treble	0...100	Sets the treble (high range) level	
f	Presence	0...100	Sets the presence (high-frequency tone)	
g	Wet/Dry	Dry, 1:99...99:1, Wet	Balance between the wet and dry signal	
		Src	Off...Tempo	See DMS (Dynamic Modulation Source)
		Amt	-100...+100	Amount of modulation source

Bass Amp+Cabinet (Bass Amp Model+Cabinet)

This simulates a bass amp and speaker cabinet.

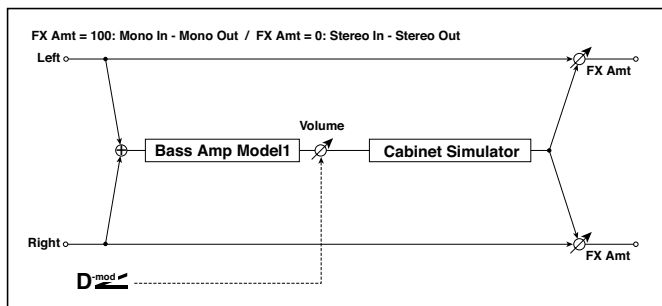

a	Amp Type	LA STUDIO, JAZZ, GOLD PANEL, SCOOPED, VALVE2, VALVE, CLASSIC	Selects the type of the amplifier
b	Volume	0...100	Sets the output level
	Src	Off...Tempo	Selects the modulation source for the output level
	Amt	-100...+100	Sets the modulation amount of the output level
c	Bass	0...100	Sets the bass (low range) level
d	Middle	0...100	Sets the middle (mid range) level
	Mid Range	0...4	Sets the mid-frequency range
e	Treble	0...100	Sets the treble (high range) level
f	Presence	0...100	Sets the presence (high-frequency tone)
g	Cabinet Simulator	Off, On	Switches the cabinet simulator on/off
h	Cabinet Type	LA - 4x10, MODERN - 4x10, METAL - 4x10, CLASSIC - 8x10, UK - 4x12, STUDIO - 1x15, JAZZ - 1x15, VOX AC100 - 2x15, US - 2x15, UK - 4x15, LA - 1x18, COMBI - 1x12 & 1x18	Selects the cabinet type

i	Wet/Dry	Dry, 1:99...99:1, Wet	Balance between the wet and dry signal
	Src	Off...Tempo	See DMS (Dynamic Modulation Source)
	Amt	-100...+100	Amount of modulation source

a: Amp Type

h: Cabinet Type

Recommended Combinations of Bass Amp Models and Cabinets:

Amp Type	Cabinet Type
LA STUDIO	LA - 4x10, LA - 1x18
JAZZ	JAZZ - 1x15
GOLD PANEL	MODERN - 4x10
SCOOPED	METAL - 4x10
VALVE2	CLASSIC - 8x10
VALVE	CLASSIC - 8x10
CLASSIC	COMBI - 1x12 & 1x18

St. Bass Cabinet (Stereo Bass Cabinet)

This simulates the acoustical character of a bass amp's speaker cabinet.

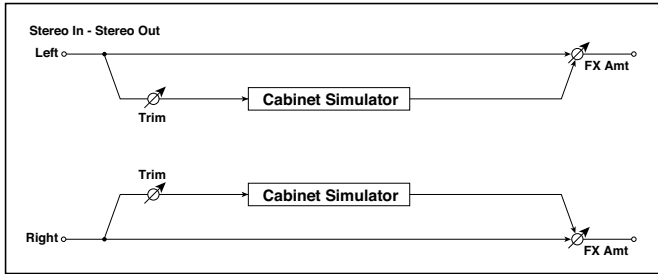

a	Trim	0...100	Sets the input level	
b	Cabinet Type		Selects the cabinet type	
		LA - 4x10	Four 10" speakers / LA sound cabinet	
		MODERN - 4x10	Four 10" aluminum-cone speakers / modern cabinet	
		METAL - 4x10	Four 10" aluminum-cone speakers / modern cabinet	
		CLASSIC - 8x10	Eight 10" speakers / classic cabinet	
		UK - 4x12	Four 12" speakers / UK-manufactured cabinet	
		STUDIO - 1x15	One 15" speaker / studio combo cabinet	
		JAZZ - 1x15	One 15" speaker / jazz combo cabinet	
		VOX AC100 - 2x15	Two 15" speakers / cabinet for Vox AC100	
		US - 2x15	Two 15" speakers / US-manufactured cabinet	
		UK - 4x15	Four 15" speakers / UK-manufactured cabinet	
		LA - 1x18	One 18" speaker / LA sound cabinet	
		COMBI - 1x12 & 1x18	One 12" and one 18" speaker combination cabinet	
c	Wet/Dry	Dry, 1:99...99:1, Wet	Balance between the wet and dry signal	
	Src	Off...Tempo	See DMS (Dynamic Modulation Source)	
	Amt	-100...+100	Amount of modulation source	

Tube PreAmp Model (Tube PreAmp Modeling)

This effect simulates a two-stage vacuum tube preamp. You can make individual settings for two vacuum tubes connected in series. This lets you create the warm sound typical of vacuum tubes.

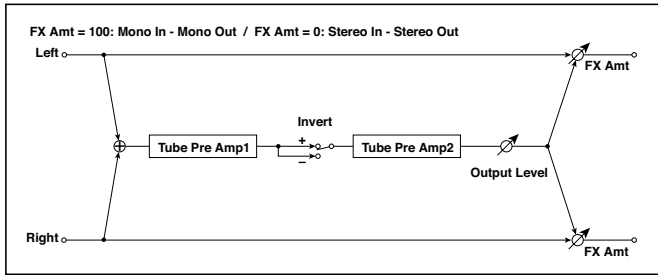

a	Tube1 Low Cut [Hz]	Thru, 21...8.00k	Sets the cutoff frequency for the low cut filter of stage 1
	High Cut [Hz]	53...20.00k, Thru	Sets the cutoff frequency for the high cut filter of stage 1
b	Tube1 Gain [dB]	-24.0...+24.0	Sets the input gain for stage 1
	Saturation [%]	0...100	Sets the input/output response for stage 1
c	Tube1 Bias	0...100	Sets the bias voltage for stage 1
d	Tube1 Phase	Normal, Wet Invert	Turns phase reversal on/off
e	Tube2 Low Cut [Hz]	Thru, 21...8.00k	Sets the cutoff frequency for the low cut filter of stage 2
	High Cut [Hz]	53...20.00k, Thru	Sets the cutoff frequency for the high cut filter of stage 2
f	Tube2 Gain [dB]	-24.0...+24.0	Sets the input gain for stage 2
	Saturation [%]	0...100	Sets the input/output response for stage 2
g	Tube2 Bias	0...100	Sets the bias voltage for stage 2
h	Tube2 Output Level [dB]	-48.0...+0.0	Sets the output level
i	Wet/Dry	Dry, 1:99...99:1, Wet	Balance between the wet and dry signal
	Src	Off...Tempo	See DMS (Dynamic Modulation Source)
	Amt	-100...+100	Amount of modulation source

b, f: Saturation [%]

With higher settings of this value, the waveform will change at high gain levels, tending to cause distortion. Lower settings of this value will produce linear response.

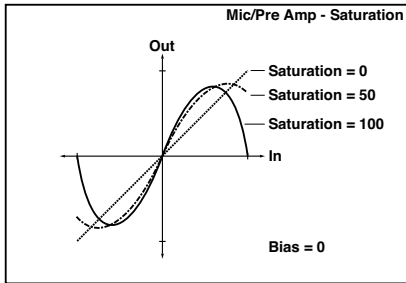
**c: Tube1 Bias**

This expresses the effect that changes in vacuum tube bias have on the distortion of the waveform. Higher settings of this value will produce distortion even at low gain levels. Since this will also change the overtone structure, you can use it to control the tonal character.

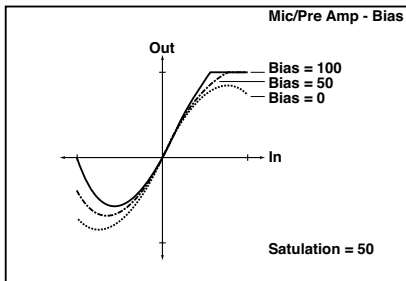
**d: Tube1 Phase**

With the Wet Invert setting, the phase of the signal will be inverted between stage 1 and stage 2. Since "Bias" is applied to the inverted signal in stage 2, this will change the tonal character.

St. Tube PreAmp (Stereo Tube PreAmp Modeling)

This is a stereo vacuum tube preamp simulator (Tube PreAmp Model (Tube PreAmp Modeling)).

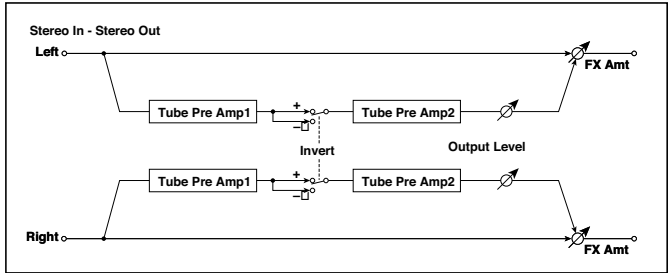

Mic Model+PreAmp (Mic Modeling + PreAmp)

This effect simulates a mic and vacuum tube preamp. You can choose from various types of mic and positions to create differing sonic characters.

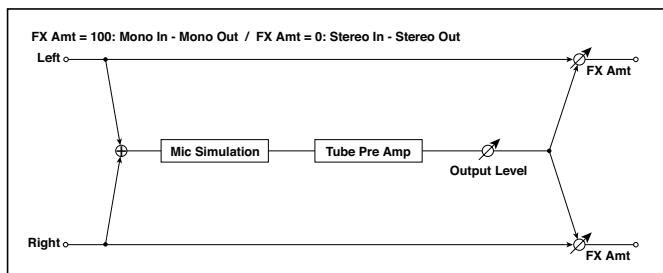

a	Mic Type	Vintage Dynamic, Multi Condenser, Percussion Condenser, Drums Dynamic, Vocal Dynamic, Multi Dynamic, Vocal Condenser, Vocal Tube, Kick Dynamic	Selects the type of mic	
b	Mic Position	Close, On, Off, Far	Sets the mic placement distance	
c	Tube Low Cut [Hz]	Thru, 21...8.00k	Sets the frequency of the low cut filter	
	High Cut [Hz]	53...20.00k, Thru	Sets the frequency of the high cut filter	
d	Tube Gain [dB]	-24.0...+24.0	Sets the input gain to the vacuum tube preamp	
	Saturation [%]	0...100	Sets the input/output response of the preamp	
e	Tube Bias	0...100	Sets the bias level of the preamp	
f	Tube Output Level [dB]	-48.0...+0.0	Sets the output level of the preamp	
g	Wet/Dry	Dry, 1:99...99:1, Wet	Balance between the wet and dry signal	
	Src	Off...Tempo	See DMS (Dynamic Modulation Source)	
	Amt	-100...+100	Amount of modulation source	

b: Mic Position

This expresses the effect that the mic position has on the sound. The Close setting is the closest mic position, and the Far setting is the farthest.

St. Mic + PreAmp (Stereo Mic Modeling + PreAmp)

This is a stereo mic and preamp simulator (Mic Model+PreAmp (Mic Modeling + PreAmp)). For example you might use this to simulate micing of a stereo source such as a rotary speaker.

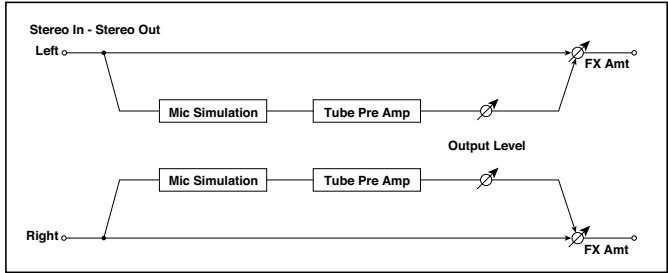

FILT (EQ and Filters)

St.Parametric4EQ (Stereo Parametric 4-Band EQ)

This is a stereo 4-band parametric equalizer. You can select peaking type or shelving type for Band 1 and 4. The gain of Band 2 can be controlled by dynamic modulation.

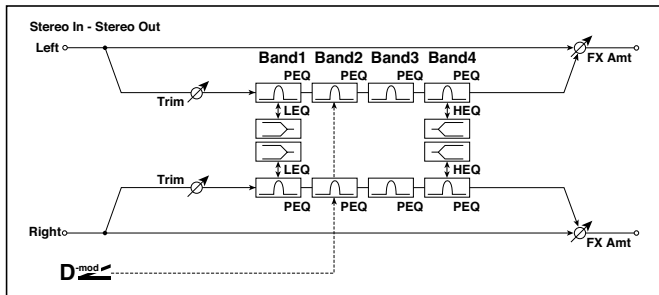

a	Trim	0...100	Sets the input level
b	Band1 Type	Peaking, Shelving-Low	Selects the type of Band 1
c	Band4 Type	Peaking, Shelving-High	Selects the type of Band 4
d	Band2 Dynamic Gain Src	Off...Tempo	Selects the modulation source of the Band 2 gain
	Amt [dB]	-18.0...+18.0	Sets the modulation amount of Band 2 gain
e	Band1 Cutoff [Hz]	20...1.00k	Sets the center frequency of Band 1
	Q	0.5...10.0	Sets the bandwidth of Band 1
	Gain [dB]	-18.0...+18.0	Sets the gain of Band 1
f	Band2 Cutoff [Hz]	50...10.00k	Sets the center frequency of Band 2
	Q	0.5...10.0	Sets the bandwidth of Band 2
	Gain [dB]	-18.0...+18.0	Sets the gain of Band 2
g	Band3 Cutoff [Hz]	300...10.00k	Sets the center frequency of Band 3
	Q	0.5...10.0	Sets the bandwidth of Band 3
	Gain [dB]	-18.0...+18.0	Sets the gain of Band 3

h	Band4 Cutoff [Hz]	500...20.00k	Sets the center frequency of Band 4
	Q	0.5...10.0	Sets the bandwidth of Band 4
	Gain [dB]	-18.0...+18.0	Sets the gain of Band 4
i	Wet/Dry	Dry, 1:99...99:1, Wet	Balance between the wet and dry signal
	Src	Off...Tempo	See DMS (Dynamic Modulation Source)
	Amt	-100...+100	Amount of modulation source

b: Band1 Type

c: Band4 Type

Selects a filter type for Band 1 and 4.

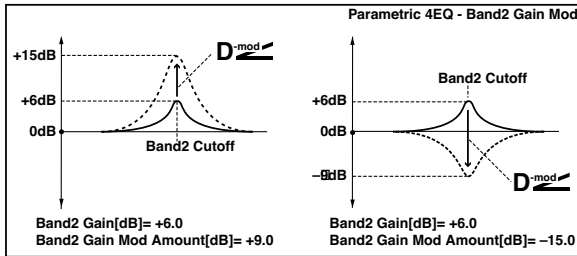
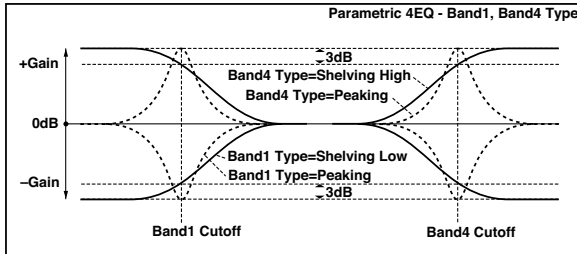

e, f, g, h: Q

These parameters set the bandwidth of each equalizer. The higher the value, the narrower the band becomes.

d: Band2 Dynamic Gain Src

d: Amt [dB]

You can control the gain of Band 2 using the modulation source.

St. Graphic 7EQ (Stereo Graphic 7-Band EQ)

This is a stereo 7-band graphic equalizer. The bar graph of the gain setting for each band gives you a clear, visual idea of frequency responses. You can select a center frequency setting for each band from twelve types, according to the sound.

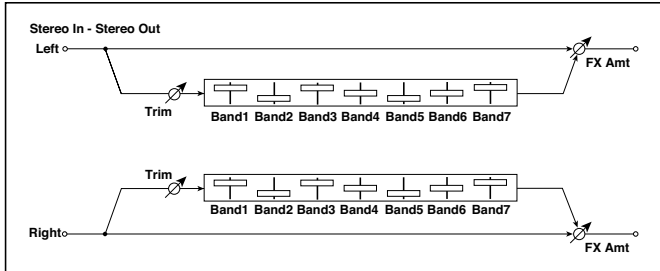

a	Type	1:Wide 1, 2:Wide 2, 3:Wide 3, 4:Half Wide 1, 5:Half Wide 2, 6:Half Wide 3, 7:Low, 8:Wide Low, 9:Mid, 10:Wide Mid, 11:High, 12:Wide High	Selects a combination of center frequencies for each band
b	Trim	0...100	Sets the input level
c	Band1 [dB]	-18.0...+18.0	Sets the gain of Band 1
d	Band2 [dB]	-18.0...+18.0	Sets the gain of Band 2
e	Band3 [dB]	-18.0...+18.0	Sets the gain of Band 3
f	Band4 [dB]	-18.0...+18.0	Sets the gain of Band 4
g	Band5 [dB]	-18.0...+18.0	Sets the gain of Band 5
h	Band6 [dB]	-18.0...+18.0	Sets the gain of Band 6
i	Band7 [dB]	-18.0...+18.0	Sets the gain of Band 7
j	Wet/Dry	Dry, 1:99...99:1, Wet	Balance between the wet and dry signal
	Src	Off...Tempo	See DMS (Dynamic Modulation Source)
	Amt	-100...+100	Amount of modulation source

a: Type

This parameter selects a combination of center frequencies for each band. The center frequency of each band is shown in the right of the screen.

You can configure a 21-Band Graphic EQ ranging from 80 Hz to 18 kHz if you route three Graphic 7-Band EQ effects in series, with a setting of 7:Low, 9:Mid, and 11:High for each EQ.

P4EQ - Exciter (Parametric 4-Band EQ - Exciter)

This effect combines a mono four-band parametric equalizer and an exciter.

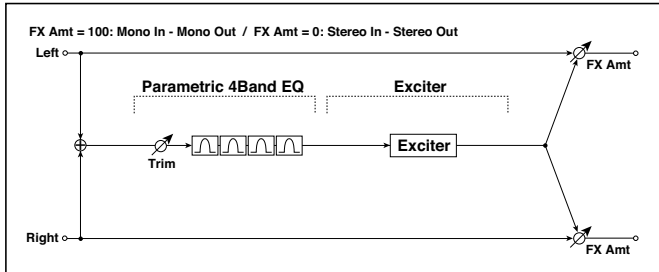

P4EQ			
a	[E]Trim	0...100	Sets the parametric EQ input level
b	[E]B1 Cutoff [Hz]	20...1.00k	Sets the center frequency of Band 1
	Q	0.5...10.0	Sets the bandwidth of Band 1
	Gain [dB]	-18...+18	Sets the gain of Band 1
c	[E]B2 Cutoff [Hz]	50...5.00k	Sets the center frequency of Band 2
	Q	0.5...10.0	Sets the bandwidth of Band 2
	Gain [dB]	-18...+18	Sets the gain of Band 2
d	[E]B3 Cutoff [Hz]	300...10.00k	Sets the center frequency of Band 3
	Q	0.5...10.0	Sets the bandwidth of Band 3
	Gain [dB]	-18...+18	Sets the gain of Band 3
e	[E]B4 Cutoff [Hz]	500...20.00k	Sets the center frequency of Band 4
	Q	0.5...10.0	Sets the bandwidth of Band 4
	Gain [dB]	-18...+18	Sets the gain of Band 4
EXCITER			
f	[X]Exciter Blend	-100...+100	Sets the intensity (depth) of the Exciter effect
g	[X]Emphasis Freq	0...70	Sets the frequency range to be emphasized
h	Wet/Dry	Dry, 1:99...99:1, Wet	Balance between the wet and dry signal
	Src	Off...Tempo	See DMS (Dynamic Modulation Source)
	Amt	-100...+100	Amount of modulation source

P4EQ - Wah (Parametric 4-Band EQ - Wah/Auto Wah)

This effect combines a mono four-band parametric equalizer and a wah. You can change the order of the connection.

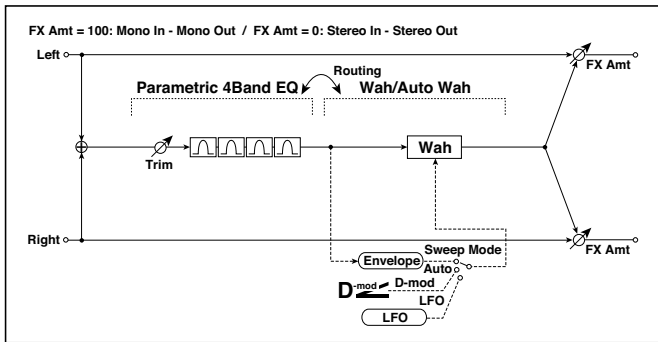



P4EQ			
a	[E]Trim	0...100	Sets the parametric EQ input level
	Routing	P4EQ > Wah, Wah > P4EQ	Changes the order of the parametric equalizer and wah connection
b	[E]B1 Cutoff [Hz]	20...1.00k	Sets the center frequency of Band 1
	Q	0.5...10.0	Sets the bandwidth of Band 1
	Gain [dB]	-18...+18	Sets the gain of Band 1
c	[E]B2 Cutoff [Hz]	50...5.00k	Sets the center frequency of Band 2
	Q	0.5...10.0	Sets the bandwidth of Band 2
	Gain [dB]	-18...+18	Sets the gain of Band 2
d	[E]B3 Cutoff [Hz]	300...10.00k	Sets the center frequency of Band 3
	Q	0.5...10.0	Sets the bandwidth of Band 3
	Gain [dB]	-18...+18	Sets the gain of Band 3
e	[E]B4 Cutoff [Hz]	500...20.00k	Sets the center frequency of Band 4
	Q	0.5...10.0	Sets the bandwidth of Band 4
	Gain [dB]	-18...+18	Sets the gain of Band 4
WAH			
f	[W]Frequency Bottom	0...100	Sets the lower limit of the wah center frequency
	Frequency Top	0...100	Sets the upper limit of the wah center frequency

g	[W]Sweep Mode	Auto, D-mod, LFO	Selects the control from auto-wah, modulation source, and LFO
	Src	Off...Tempo	Selects the modulation source for the wah when Sweep Mode=D-mod
h	[W]LFO Frequency [Hz]	0.02...20.00	Sets the speed of the LFO
	Resonance	0...100	Sets the resonance amount
	LPF	Off, On	Switches the wah low pass filter on and off
i	[W] Wet/Dry	Dry,1 : 99... 99 : 1, Wet	Sets the wah effect balance
	Src	Off...Tempo	Selects the Wet/Dry modulation source for the wah
	Amt	-100...+100	Sets the Wet/Dry modulation amount for the wah
j	Wet/Dry	Dry, 1:99...99:1, Wet	Balance between the wet and dry signal
	Src	Off...Tempo	See DMS (Dynamic Modulation Source)
	Amt	-100...+100	Amount of modulation source

St. Wah/Auto Wah (Stereo Wah/Auto Wah)

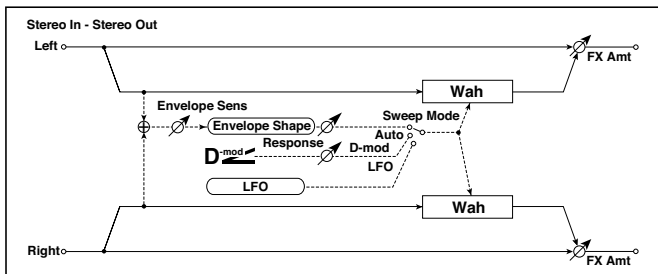
This stereo wah effect allows you to create sounds from vintage wah pedal simulation to auto-wah simulation, and much broader range settings.



a	Frequency Bottom	0...100	Sets the lower limit of the wah center frequency	
	Frequency Top	0...100	Sets the upper limit of the wah center frequency	
b	Sweep Mode	Auto, D-mod, LFO	Selects the control from auto-wah, modulation source, and LFO	
	Src	Off...Tempo	Selects the modulation source for the wah when Sweep Mode=D-mod	
	Respon	0...100	Sets the response speed when Sweep Mode = Auto or D-mod	
c	Envelope Sens	0...100	Sets the sensitivity of auto-wah	
	Envelope Shape	-100...+100	Sets the sweep curve of auto-wah	
d	LFO Frequency [Hz]	0.02...20.00	Sets the speed of the LFO	
	Src	Off...Tempo	Selects a modulation source for LFO speed	
	Amt	-20.00...+20.00	Sets the modulation amount of LFO speed	
e	MIDI Sync	Off, On	When this is on, the LFO speed is set by BPM, Base Note, and Times, instead of Frequency	
	BPM	MIDI, 40.00...300.00	MIDI syncs to the system tempo; 40-300 sets the tempo manually for this individual effect	
	Base Note		Selects the type of notes that specify the LFO speed	
	Times	x1...x32	Sets the number of notes that specify the LFO speed	
f	Resonance	0...100	Sets the resonance amount	
	Low Pass Filter	Off, On	Switches the wah low pass filter on and off	
g	Output Level	0...100	Sets the output level of the effect sound	
	Src	Off...Tempo	Selects the modulation source that will control the effect output level	
	Amt	-100...+100	Sets the modulation amount of the effect output level	
h	Wet/Dry	Dry, 1:99...99:1, Wet	Balance between the wet and dry signal	
	Src	Off...Tempo	See DMS (Dynamic Modulation Source)	
	Amt	-100...+100	Amount of modulation source	

a: Frequency Bottom

a: Frequency Top

The sweep width and direction of the wah filter are determined by the “Frequency Top” and “Frequency Bottom” settings.

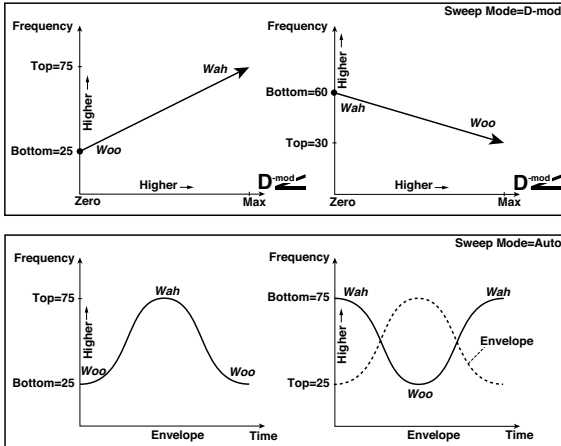

b: Sweep Mode

This parameter changes the wah control mode. Setting “Sweep Mode” to Auto will select an auto-wah that sweeps according to envelope changes in the input signal level. Auto-wah is frequently used for funk guitar parts and clav sounds.

When “Sweep Mode” is set to D-mod, you can control the filter directly via the modulation source in the same way as a wah pedal.

When “Sweep Mode” is set to LFO, the effect uses LFO to sweep in cycle.

c: Envelope Sens

This parameter sets the sensitivity of auto-wah. Increase the value if the input signal is too low to sweep. Reduce the value if the input signal is so high that the filter is stopped temporarily.

c: Envelope Shape

This parameter determines the sweep curve for auto-wah.

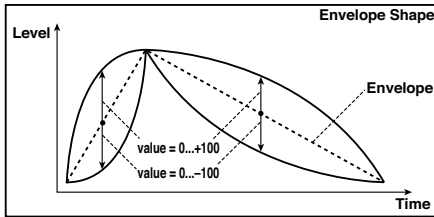

d: LFO Frequency [Hz]

e: MIDI Sync

When "MIDI/Tempo Sync"=Off, the LFO speed uses the LFO Frequency parameter setting. When "MIDI/Tempo Sync"=On, the LFO speed follows the "BPM", "Base Note", and "Times" settings.

e: BPM

e: Base Note

e: Times



One cycle of LFO sweep is obtained by multiplying the length of a note (♩ ...) (selected for "Base Note", in relation to the tempo specified in "BPM", or the MIDI Clock tempo if "BPM" is set to MIDI) by the number specified in the Times parameter.

St. Vintage Wah (Stereo Vintage/Custom Wah)

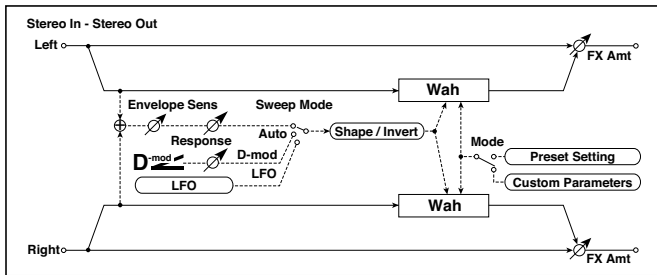
This effect simulates the tonal character of a vintage wah pedal. You can customize the tone and range settings.



a	Mode	Preset, Custom	Selects either preset or custom settings
	Shape	-100...+100	Sets the curve of the sweep
	Invert	Off, On	Inverts the polarity of the sweep
b	Frequency Bottom	0...100	Sets the lower limit of the wah center frequency when Mode = Custom
	Frequency Top	0...100	Sets the upper limit of the wah center frequency when Mode = Custom
c	Resonance Bottom	0...100	Sets the lower limit of resonance amount when Mode=Custom
	Resonance Top	0...100	Sets the upper limit of resonance amount when Mode=Custom
d	Sweep Mode	Auto, D-mod, LFO	Selects the control from auto-wah, modulation source, and LFO
	Src	Off...Tempo	Selects the modulation source for the wah when Sweep Mode=D-mod
	Manual	0...100	Sets the center frequency when Sweep Mode=D-mod and Source=Off
e	Envelope Sens	0...100	Sets the auto-wah sensitivity
	Response	0...100	Sets the speed of response when Sweep Mode=Auto or D-mod
f	LFO Frequency [Hz]	0.02...20.00	Sets the speed of the LFO
	Src	Off...Tempo	Selects a modulation source for LFO speed
	Amt	-20.00...+20.00	Sets the modulation amount of LFO speed

g	MIDI Sync	Off, On	When this is on, the LFO speed is set by BPM, Base Note, and Times, instead of Frequency 
	BPM	MIDI, 40.00... 300.00	MIDI syncs to the system tempo; 40-300 sets the tempo manually for this individual effect
	Base Note		Selects the type of notes that specify the LFO speed
	Times	x1...x32	Sets the number of notes that specify the LFO speed
h	Output Level	0...100	Sets the output level of the effect sound
	Src	Off...Tempo	Selects the modulation source that will control the effect output level
	Amt	-100...+100	Sets the modulation amount of the effect output level
i	Wet/Dry	Dry, 1:99...99:1, Wet	Balance between the wet and dry signal
	Src	Off...Tempo	See DMS (Dynamic Modulation Source)
	Amt	-100...+100	Amount of modulation source

a: Shape

This parameter specifies the sweep curve of the wah. It applies to all control via auto-wah, modulation source, and LFO, and lets you adjust subtle nuances of the wah effect.

a: Mode

b: Frequency Bottom

b: Frequency Top

c: Resonance Bottom

c: Resonance Top

If Mode=Preset, this simulates a vintage wah pedal. In this case, internally fixed values are used for Frequency Bottom/Top and Resonance Bottom/Top, and these settings will be ignored. The settings for Frequency Bottom/Top and Resonance Bottom/Top are valid if Mode=Custom.

VOX Wah

This effect is modeled on two legendary VOX wah pedals: the V847 and the V848 Clyde McCoy model. Thanks to their unique ‘throaty’ tone, these are the only wah pedals that many professionals will consider putting under their feet. Played musically, they can make your melody lines cry like a baby—or howl like a man possessed!

A great tonal trick is to find a ‘sweet spot’ within the range of the Wah pedal and then leave it there. This ‘stuck-Wah’ can be very effective when used tastefully, producing a distinctive sound that will cut through any mix.

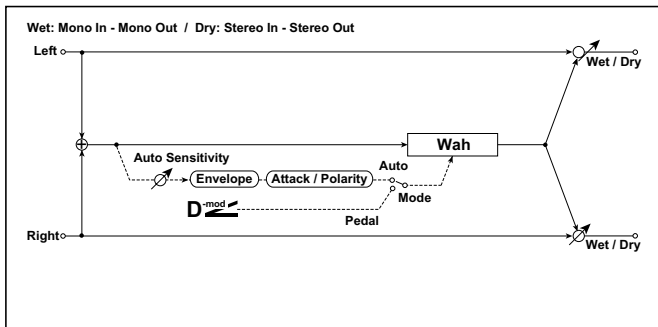

a	Type	V847, V848	Effect model	
b	Open	0...99	Level when open	
	Close	0...99	Level when close	
c	Mode	Auto, Pedal	Selects either auto or pedal mode	
d	Pedal Source	Off...Tempo	Selects the modulation source when in pedal mode	
	Pedal Manual	0...99	Level when in pedal mode	
e	Auto Sensivity	0...100	Sensitivity when in auto mode	
	Auto Polarity	Up, Down	Polarity when in auto mode	
	Auto Attack	0...99	Attack time	
f	Wet/Dry	Dry, 1:99...99:1, Wet	Balance between the wet and dry signal	
	Src	Off...Tempo	See DMS (Dynamic Modulation Source)	
	Amt	-100...+100	Amount of modulation source	

St.Exciter/Enhncr (Stereo Exciter/Enhancer)

This effect is a combination of the Exciter, which adds a punch to the sound and the Enhancer, which adds spread and presence.

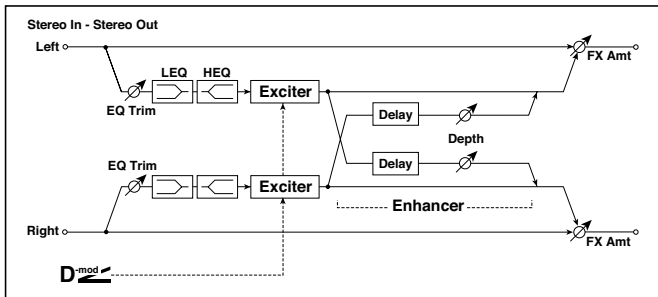

a	Exciter Blend	-100...+100	Sets the intensity (depth) of the Exciter effect
	Src	Off...Tempo	Selects the modulation source of the Exciter intensity
	Amt	-100...+100	Sets the modulation amount of the Exciter intensity
b	Emphasis Freq	0...70	Sets the frequency to be emphasized
	Src	Off...Tempo	Selects the modulation source of the frequency to be emphasized
	Amt	-70...+70	Sets the amount of modulation of the frequency to be emphasized
c	Enhancer Delay L [msec]	0.0...50.0	Sets the delay time for the Enhancer left channel
d	Enhancer Delay R [msec]	0.0...50.0	Sets the delay time for the Enhancer right channel
e	Enhancer Depth	0...100	Sets the determines to what degree the Enhancer effect is applied
	Src	Off...Tempo	Selects the modulation source of the Enhancer width
	Amt	-100...+100	Sets the modulation amount of the Enhancer width
f	EQ Trim	0...100	Sets the 2-band EQ input level
g	Pre LEQ Fc	Low, Mid-Low	Selects the cutoff frequency (low or mid-low) of the low-range equalizer
	Pre HEQ Fc	High, Mid-High	Selects the cutoff frequency (high or mid-high) of the high-range equalizer
h	Pre LEQ Gain [dB]	-15.0...+15.0	Gain of the Lo EQ
	Pre HEQ Gain [dB]	-15.0...+15.0	Gain of the High EQ

i	Wet/Dry	Dry, 1:99...99:1, Wet	Balance between the wet and dry signal
	Src	Off...Tempo	See DMS (Dynamic Modulation Source)
	Amt	-100...+100	Amount of modulation source

a: Exciter Blend

This parameter sets the depth (intensity) of the Exciter effect. Positive values give a frequency pattern (to be emphasized) different from negative values.

b: Emphasis Freq

This parameter sets the frequency to be emphasized. Higher values will emphasize lower frequencies.

c: Enhancer Delay L [msec]

d: Enhancer Delay R [msec]

These parameters set the delay time for the Enhancer left and right channel. Specifying a slightly different delay time for the left and right channel will add a stereo image, depth, and width to the sound.

Stereo Isolator

This is a stereo effect that separates the input signal into low, mid, and high-frequency bands, and controls the volume of each band independently. For example you can separately boost or cut the kick, snare, and hi-hat sounds from a drum signal in realtime.

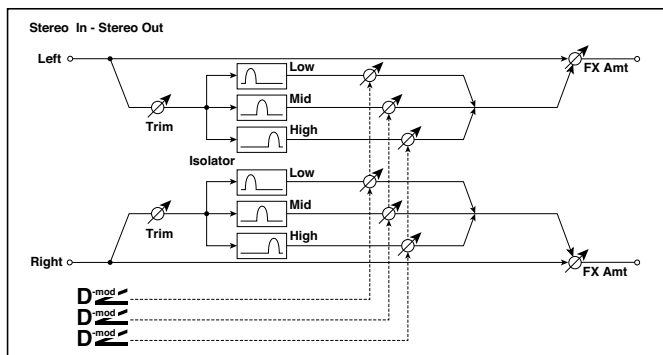

a	Trim	0...100	Sets the input level
b	Low/Mid [Hz]	100...500	Sets the frequency at which the low and mid bands are divided
c	Mid/High [Hz]	2000...6000	Sets the frequency at which the mid and high bands are divided
d	Low Gain [dB]	-Inf, -59...+12	Sets the low-frequency gain
	Src	Off...Tempo	Selects the source that will modulate low-frequency gain
	Amt	-72...+72	Sets the amount by which the low-frequency gain will be modulated
e	Mid Gain [dB]	-Inf, -59...+12	Sets the mid-frequency gain
	Src	Off...Tempo	Selects the modulation source for mid-frequency gain
	Amt	-72...+72	Sets the amount by which the mid-frequency gain will be modulated
f	High Gain [dB]	-Inf, -59...+12	Sets the high-frequency gain
	Src	Off...Tempo	Selects the modulation source for high-frequency gain
	Amt	-72...+72	Sets the amount by which the high-frequency gain will be modulated



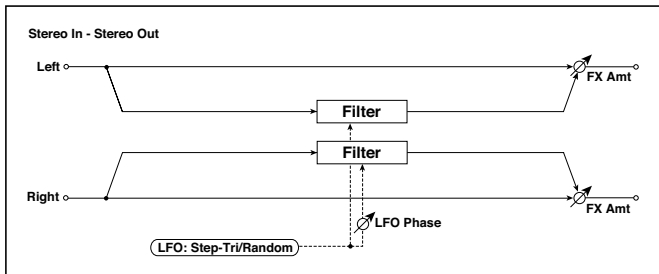

g	Wet/Dry	Dry, 1:99...99:1, Wet	Balance between the wet and dry signal
	Src	Off...Tempo	See DMS (Dynamic Modulation Source)
	Amt	-100...+100	Amount of modulation source

St. Random Filter (Stereo Random Filter)

This stereo band pass filter uses a step-shape waveform and random LFO for modulation. You can create a special effect from filter oscillation.



a	LFO Waveform	Step-Tri, Random	Selects the LFO Waveform
	LFO Phase [degree]	-180...+180	Sets the LFO phase difference between the left and right
b	LFO Frequency [Hz]	0.02...20.00	Sets the speed of the LFO
	Src	Off...Tempo	Selects the modulation source used for both LFO speed and step speed
	Amt	-20.00... +20.00	Sets the modulation amount of LFO speed
c	LFO Step Freq [Hz]	0.05...50.00	Sets the LFO step speed (speed that changes in steps)
	Amt	-50.00... +50.00	Sets the modulation amount of LFO step speed

d	MIDI Sync	Off, On	When this is on, the LFO speed is set by BPM, Base Note, and Times, instead of Frequency	
	BPM	MIDI, 40.00... 300.00	MIDI syncs to the system tempo; 40-300 sets the tempo manually for this individual effect	
	Base Note		Selects the type of notes that specify the LFO speed	
	Times	x1...x32	Sets the number of notes that specify the LFO speed	
e	Step Base Note		Selects the type of notes to specify the LFO step speed	
	Times	x1...x32	Sets the number of notes to specify the LFO step speed	
f	Manual	0...100	Sets the filter center frequency	
	Src	Off...Tempo	Selects the modulation source for the filter center frequency	
	Amt	-100...+100	Sets the modulation amount for the filter center frequency	
g	Depth	0...100	Sets the modulation depth of filter center frequency	
	Src	Off...Tempo	Selects the modulation source of filter modulation	
	Amt	-100...+100	Sets the modulation amount of filter modulation	
h	Resonance	0...100	Sets the resonance amount	
i	Wet/Dry	-Wet, -1:99... Dry...99:1, Wet	Balance between the wet and dry signal	
	Src	Off...Tempo	See DMS (Dynamic Modulation Source)	
	Amt	-100...+100	Amount of modulation source	

a: LFO Phase [degree]

Offsetting the left and right phases alters how modulation is applied to the left and right channels, creating a swelling affect.

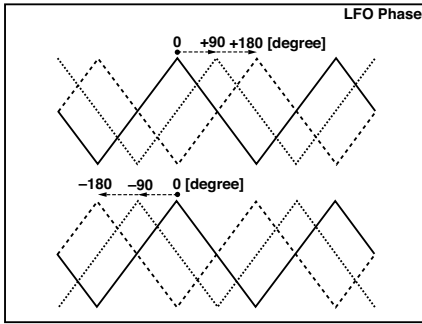
**a: LFO Waveform****b: LFO Frequency [Hz]****c: LFO Step Freq [Hz]**

When "LFO Waveform" is set to Step-Tri, LFO is a step-shape, triangle waveform. The "LFO Frequency" parameter sets the original triangle waveform speed. Changing the "LFO Step Freq" parameter enables you to adjust the width of the steps.

When "LFO Waveform" is set to Random, the "LFO Step Freq" parameter uses a random LFO cycle.

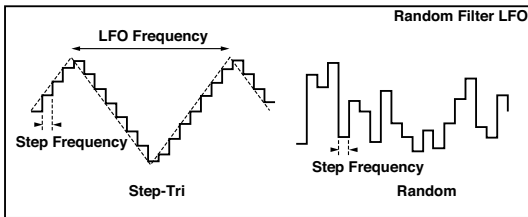
**d: BPM****e: Step Base Note****e: Times**

The width of an LFO step, or a cycle of random LFO, is obtained by multiplying the length of a note (♩, ♪, ♫, ♮) (selected for "Step Base Note", in relation to the tempo specified in "BPM," or the MIDI Clock tempo if "BPM" is set to MIDI) by the number specified in the "Times" parameter.

i: Wet/Dry



The effect sound's phase will be reversed when you set this parameter in the negative range of values.

St. MultiModeFilter (Stereo Multi Mode Filter)

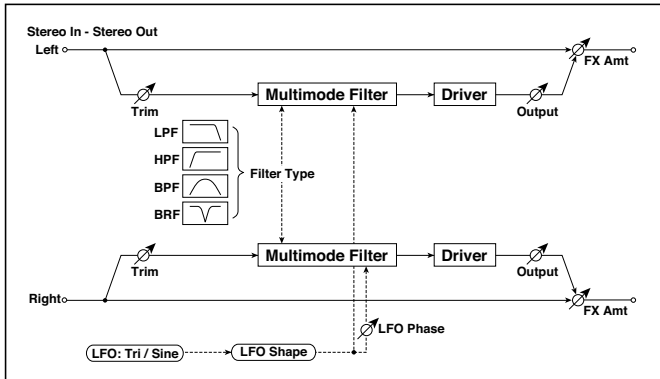
This is a multi-mode filter with four types; low pass, high pass, band pass, and band reject. You can use LFO or dynamic modulation to vary the cutoff frequency or resonance.



a	Type	LPF, HPF, BPF, BRF	Selects the type of filter
	Trim	0...100	Sets the input level
b	Cutoff	0...100	Sets the cutoff frequency (center frequency)
	Src	Off...Tempo	Selects the modulation source of the cutoff
	Amt	-100...+100	Sets the modulation amount of the cutoff
c	Resonance	0...100	Sets the resonance amount
	Src	Off...Tempo	Selects the source that will modulate the amount of resonance
	Amt	-100...+100	Sets the amount by which the resonance will be modulated
d	LFO Waveform	Triangle, Sine	Selects the LFO Waveform
	Phase [degree]	-180...+180	Sets the LFO phase difference between the left and right
	Depth	0...100	Sets the depth to which the LFO will modulate the cutoff frequency



e	LFO Frequency [Hz]	0.02...20.00	Sets the speed of the LFO	
	Src	Off...Tempo	Selects a modulation source for LFO speed	
	Amt	-20.00... +20.00	Sets the modulation amount of LFO speed	
f	MIDI Sync	Off, On	When this is on, the LFO speed is set by BPM, Base Note, and Times, instead of Frequency	
	BPM	MIDI, 40.00... 300.00	MIDI syncs to the system tempo; 40-300 sets the tempo manually for this individual effect	
	Base Note		Selects the type of notes that specify the LFO speed	
	Times	x1...x32	Sets the number of notes that specify the LFO speed	
g	Drive SW	Off, On	Switches distortion on/off within the filter	
	Output Level	0...100	Sets the output level	
h	Drive Gain	0...100	Sets the distortion amount	
	Low Boost	0...100	Sets the amount of low-range boost	
i	Wet/Dry	Dry, 1:99...99:1, Wet	Balance between the wet and dry signal	
	Src	Off...Tempo	See DMS (Dynamic Modulation Source)	
	Amt	-100...+100	Amount of modulation source	

Talking Modulator

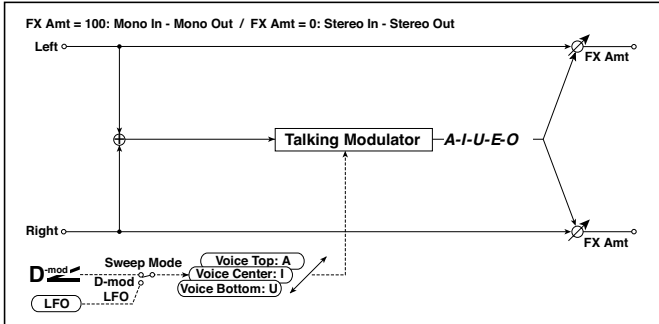
This effect adds an unusual character, like a human voice, to the input signal. Modulating the tone via dynamic modulation, you can create an interesting effect that sounds as if the guitar or synthesizer is talking.



a	Sweep Mode	D-mod, LFO	Switches between modulation source control and LFO control
b	Manual Voice Control	Bottom, 1...49, Center, 51...99, Top	Voice pattern control
	Src	Off...Tempo	Selects the modulation source that controls the voice pattern
c	Voice Top	A, I, U, E, O	Selects a vowel sound at the top end of control
d	Voice Center	A, I, U, E, O	Selects a vowel sound in the center of control
e	Voice Bottom	A, I, U, E, O	Selects a vowel sound at the bottom end of control
f	Formant Shift	-100...+100	Sets the frequency to which the effect is applied
	Resonance	0...100	Sets the Level of resonance of the voice pattern
g	LFO Frequency [Hz]	0.02...20.00	Sets the speed of the LFO
	Src	Off...Tempo	Selects a modulation source for LFO speed
	Amt	-20.00...+20.00	Sets the modulation amount of LFO speed

h	MIDI Sync	Off, On	When this is on, the LFO speed is set by BPM, Base Note, and Times, instead of Frequency 
	BPM	MIDI, 40.00... 300.00	MIDI syncs to the system tempo; 40-300 sets the tempo manually for this individual effect
	Base Note		Selects the type of notes that specify the LFO speed
	Times	x1...x32	Sets the number of notes that specify the LFO speed
i	Wet/Dry	Dry, 1:99...99:1, Wet	Balance between the wet and dry signal
	Src	Off...Tempo	See DMS (Dynamic Modulation Source)
	Amt	-100...+100	Amount of modulation source

- c: Voice Top
- d: Voice Center
- e: Voice Bottom

These parameters assign vowels to the top, center, and bottom position of the controller.

E.g.: When "Voice Top"=A, "Voice Center"=I, and "Voice Bottom"=U:

If "Sweep Mode" is set to D-mod and Ribbon is selected as the modulation source, moving your finger from the right to left of the ribbon controller will change the sound from "a" to "i," then "u."

If Sweep Mode is set to LFO, the sound will change cyclically from "a" to "i," "u," "i," then "a."

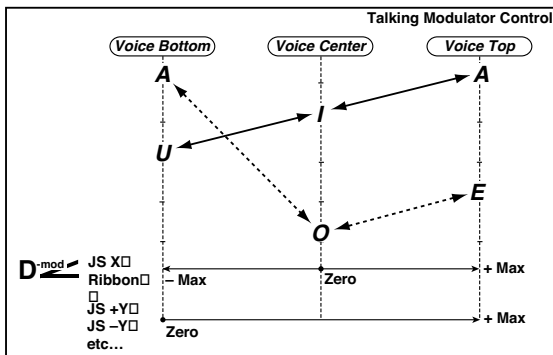

f: Formant Shift

This parameter adjusts the frequency level to which the effect is applied. If you wish to apply the effect to a higher-range sound, set this parameter to a higher value; to apply the effect to a lower-range sound, set this to a lower value.

f: Resonance

This parameter sets the intensity of resonance for the voice pattern. A larger value will add more character to the sound.

2Voice Resonator (2-Voice Resonator)

This effect resonates the input signal at a specified pitch. You can set the pitch, output level, and pan settings for two resonators individually. You can control the resonance intensity via an LFO.

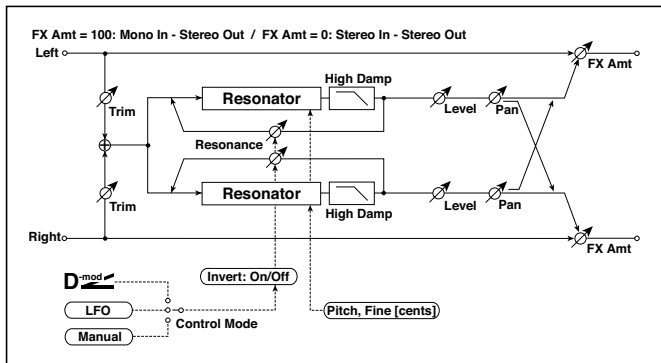

a	Control Mode	Manual, LFO, D-mod	Switches the controls of resonance intensity
	LFO/D-mod Invert	Off, On	Reverses the Voice 1 and 2 control when LFO/D-mod is selected
b	LFO Frequency [Hz]	0.02...20.00	Sets the speed of the LFO
	D-mod Src	Off...Tempo	Selects the modulation source that controls resonance intensity

c	MIDI Sync	Off, On	When this is on, the LFO speed is set by BPM, Base Note, and Times, instead of Frequency 
	BPM	MIDI, 40.00...300.00	MIDI syncs to the system tempo; 40-300 sets the tempo manually for this individual effect
	Base Note		Selects the type of notes that specify the LFO speed
	Times	x1...x32	Sets the number of notes that specify the LFO speed
d	Mod. Depth	-100...+100	Sets the amount of resonance intensity control via LFO/D-mod
	Trim	0...100	Sets the input level at the resonator
e	Voice1: Pitch	C0...B8	Sets the voice1 Pitch for resonance
	Fine [cents]	-50...+50	Fine-adjusts the voice 1 pitch for resonance
	Level	0...100	Sets the Voice1 output level
f	Voice1: Resonance	-100...+100	Sets the intensity of resonance when Control Mode = Manual
	High Damp [%]	0...100	Sets the damping amount of resonant sound in the high range
	Pan	L6...L1, C, R1...R6	Sets the Voice1 stereo image
g	Voice2: Pitch	C0...B8	Sets the voice 2 Pitch for resonance
	Fine [cents]	-50...+50	Fine-adjusts the voice 2 pitch for resonance
	Level	0...100	Sets the Voice2 output level
h	Voice2: Resonance	-100...+100	Sets the intensity of resonance when Control Mode = Manual
	High Damp [%]	0...100	Sets the damping amount of resonant sound in the high range
	Pan	L6...L1, C, R1...R6	Sets the Voice2 stereo image
i	Wet/Dry	Dry, 1:99...99:1, Wet	Balance between the wet and dry signal
	Src	Off...Tempo	See DMS (Dynamic Modulation Source)
	Amt	-100...+100	Amount of modulation source

a: Control Mode

f: Voice 1: Resonance

h: Voice 2: Resonance

This parameter determines the resonance intensity.

When “Control Mode” = Manual, the “Resonance” parameter sets the intensity of resonance. If the “Resonance” parameter has a negative value, harmonics will be changed, and resonance will occur at a pitch one octave lower.

When “Control Mode” = LFO, the intensity of resonance varies according to the LFO. The LFO sways between positive and negative values, causing resonance to occur between specified pitches an octave apart in turn.

When “Control Mode” = D-mod, the resonance is controlled by the dynamic modulation source. If JS X or Ribbon is assigned as the modulation source, the pitch an octave higher and lower can be controlled, similar to when LFO is selected for Control Mode.

a: LFO/D-mod Invert

When “Control Mode” = LFO or D-mod, the controlled phase of either Voice 1 or 2 will be reversed. When the resonance pitch is set for Voice 1 (Resonance has a positive value), Voice 2 will resonate at a pitch an octave below (Resonance has a negative value).

f: Voice 1: Pitch

f: Fine [cents]

h: Voice 2: Pitch

h: Fine [cents]

The Pitch parameter specifies the pitch of resonance by note name. The “Fine” parameter allows for fine adjustment in steps of cents.

g: High Damp [%]

i: High Damp [%]

This sets the amount of damping amount for the high frequencies of the resonant sound. Lower values create a metallic sound with a higher range of harmonics.

VOX Treble Booster

Vintage booster of high frequencies.

a	Drive	0...99	Amount of the boost effect
b	Level	0...99	General level
c	Tone	0...100	Tone of the effect
d	Wet/Dry	Dry, 1:99...99:1, Wet	Balance between the wet and dry signal
	Src	Off...Tempo	See DMS (Dynamic Modulation Source)
	Amt	-100...+100	Amount of modulation source

Vocoder

This effect applies the timbral character of a different signal (the modulator) to the input signal (the carrier).

A common use of this effect is to produce the sound of various instruments by inputting a voice to the Modulator via a microphone. A special effect is also achieved by using rhythm or effect sounds. Strings or distortion guitar sounds with a lot of harmonics are suitable as Carrier signals.

When this effect is selected, the microphone input no longer goes to the Voice Processor, but is routed to this FX processor.

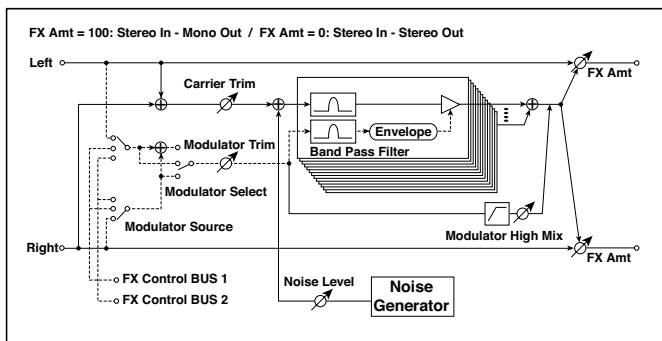

a	Carrier Trim	0...100	Sets the carrier input level
b	Modulator Trim	0...100	Sets the modulator input level
c	Modulator Source	Input, FX Control 1, FX Control 2	Choose either FX Control 1 or 2 to select the microphone input as the modulator. Choose FX Control 1 for the Left Line input, or FX Control 2 for the Right Line input. Choose Input to use the Sound as the modulator. If you want to use the keyboard as the modulator, apply the Vocoder effect to one of the Upper Sounds.
d	Modulator Select	L/R Mix, L Only, R Only	Selects whether to use the left/right mix, only left, or only right of the modulator input
e	Formant Shift	-2...+2	Sets the height of the frequency for the vocoder effect
f	Response	0...100	Sets the speed of the response to the modulator input
g	Noise Level	0...100	Sets the noise mix level to the Carrier
	Src	Off...Tempo	Selects the modulation source for the noise mix level
	Amt	-100...+100	Sets the modulation amount for the noise mix level
h	Modulator High Mix	0...100	Sets the high-range output level of the modulator

i	Low Gain [dB]	-12...+12	Sets the low-range output level of the vocoder
	High Gain [dB]	-12...+12	Sets the high-range output level of the vocoder
j	Wet/Dry	Dry, 1:99...99:1, Wet	Balance between the wet and dry signal
	Src	Off...Tempo	See DMS (Dynamic Modulation Source)
	Amt	-100...+100	Amount of modulation source

e: Formant Shift

By offsetting the Carrier filter, you can adjust the height of the frequency range to which the vocoder effect is applied. The tonal quality will change significantly.

g: Noise Level

This parameter enables you to mix white noise with the Carrier.

h: Modulator High Mix

This parameter sets the high-range output level of the modulator sound. If the modulator is a human voice, it will make the words more clear.

Using the vocoder with the microphone input

When programming the Vocoder, you can start from one of the specially programmed Vocoder Keyboard Sets (in the Synth group) as templates.

To use a voice from a microphone as a modulator:

- 1 Press the MIC button to turn the microphone channel off.
- 2 Connect a microphone to the Mic Input.
- 3 Set Modulator Source to FX Control 1.
- 4 Speak into the microphone while you use the GAIN knob (next to the MIC input) to adjust the level as high as possible without allowing distortion to occur.

With these settings, the sound from the microphone will be used as the modulator. While you play, speak into the mic; it will sound as though the instrument is talking.

If the effect sound is distorted, adjust the Carrier Trim and Modulator Trim.

Please remember to set the Carrier track's Dry parameter to Off, and the Send value to 127.

You can add reverb to the Vocoder, by way of the to MFX1 parameter.

To create a new Song making use of the Vocoder, enter the **Sequencer > Backing Sequence** mode with a Keyboard Set including the Vocoder effect.

FREQ (Frequency)

St. Sub Oscillator (Stereo Sub Oscillator)

This effect adds very low frequencies to the input signal. It is very useful when simulating a roaring drum sound or emphasizing powerful low range. This effect is different from the equalizer in that you can add very low range harmonics. You can also adjust the oscillator frequency to match a particular note number, for use as an octaver.

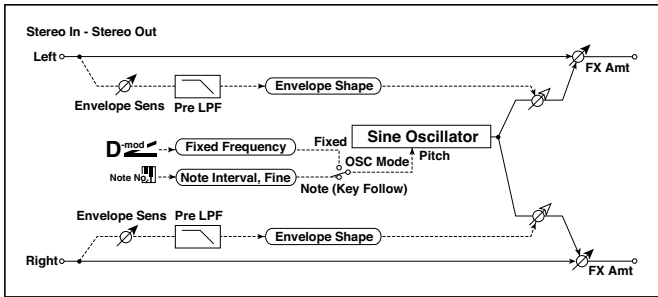

a	OSC Mode	Note (Key Follow), Fixed	Determines whether the oscillator frequency follows the note number or whether it is fixed
b	Note Interval	-48...0	Sets the pitch difference from the note number when OSC Mode=Note (Key Follow)
	Note Fine	-100...+100	Fine adjustment of the oscillator frequency
c	Fixed Frequency [Hz]	10.0...80.0	Sets the oscillator frequency when OSC Mode=Fixed
	Src	Off...Tempo	Selects the modulation source for the oscillator frequency when OSC Mode=Fixed
	Amt	-80...+80	Sets the oscillator frequency modulation amount when OSC Mode=Fixed
d	Envelope Pre LPF	1...100	Sets the upper limit of the frequency range for which very low harmonics are added
e	Envelope Sens	0...100	Sets the sensitivity with which very low harmonics are added
	Envelope Shape	-100...+100	Sets the oscillator's volume envelope curve

f	Wet/Dry	Dry, 1:99...99:1, Wet	Balance between the wet and dry signal	
	Src	Off...Tempo	See DMS (Dynamic Modulation Source)	
	Amt	-100...+100	Amount of modulation source	

a: OSC Mode**b: Note Interval****b: Note Fine**

The “OSC Mode” parameter selects the oscillator operation mode. When Note (Key Follow) is selected, the oscillator’s frequency is determined based on the note number, allowing you to use it as an octaver. The “Note Interval” parameter sets the pitch offset from the original note number by semitone steps. The “Note Fine” parameter allows you to fine-tune in steps of cents.

d: Envelope Pre LPF

This parameter sets the upper limit of the frequency range to which very low harmonics are added. Adjust this parameter if you do not want to add lower harmonics to the higher range.

Grain Shifter

This effect cuts extremely short samples ('grains') from the input signal waveform and plays them repeatedly, giving a mechanical character to the sound.

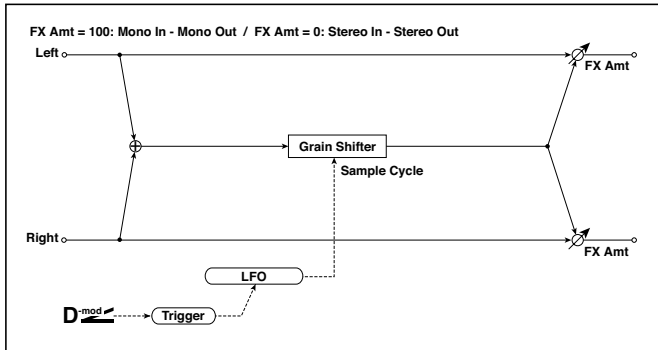

a	Duration	0...100	Sets the duration of the grain	
	Src	Off...Tempo	Selects the source that will modulate the duration of the grain	
	Amt	-100...+100	Sets the amount by which the grain duration will be modulated	
b	LFO Sync Src	Off...Tempo	Selects the modulation source that will reset the LFO	
c	LFO Sample Cycle [Hz]	0.02...20.00	Sets the frequency at which the grain will be switched	
	Src	Off...Tempo	Selects a modulation source for LFO speed	
	Amt	-20.00...+20.00	Sets the modulation amount of LFO speed	
d	MIDI Sync	Off, On	When this is on, the LFO speed is set by BPM, Base Note, and Times, instead of Frequency	
	BPM	MIDI, 40.00...300.00	MIDI syncs to the system tempo; 40-300 sets the tempo manually for this individual effect	
	Base Note		Selects the type of notes that specify the LFO speed	
	Times	x1...x32	Sets the number of notes that specify the LFO speed	
e	Wet/Dry	Dry, 1:99...99:1, Wet	Balance between the wet and dry signal	
	Src	Off...Tempo	See DMS (Dynamic Modulation Source)	
	Amt	-100...+100	Amount of modulation source	

a: Duration

c: LFO Sample Cycle [Hz]

Duration sets the length of the sampled grain, and the LFO Sample Cycle controls how often a new grain is sampled. In between Sample Cycles, the current grain is repeated continuously.

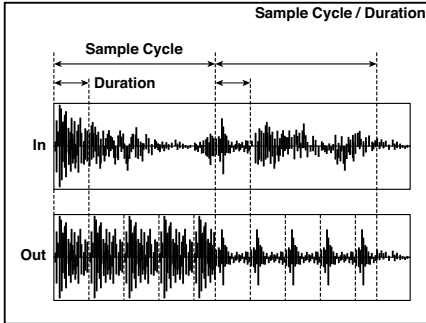

Detune

Using this effect, you can obtain a detune effect that offsets the pitch of the effect sound slightly from the pitch of the input signal. Compared to the chorus effect, a more natural sound thickness will be created.

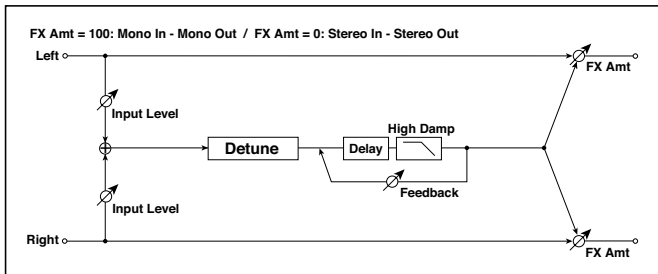

a	Pitch Shift [cents]	-100...+100	Sets the pitch difference from the input signal
	Src	Off...Tempo	Selects a modulation source for pitch shift
	Amt	-100...+100	Sets the modulation amount for pitch shift
b	Delay Time [msec]	0...1000	Sets the delay time
c	Feedback	-100...+100	Sets the feedback amount
	High Damp [%]	0...100	Sets the damping amount in the high range

d	Input Level Dmod [%]	-100...+100	Sets the modulation amount of the input level
	Src	Off...Tempo	Selects the modulation source for the input level
e	Wet/Dry	Dry, 1:99...99:1, Wet	Balance between the wet and dry signal
	Src	Off...Tempo	See DMS (Dynamic Modulation Source)
	Amt	-100...+100	Amount of modulation source

d: Input Level Dmod [%]

d: Src

This parameter sets the dynamic modulation of the input level.

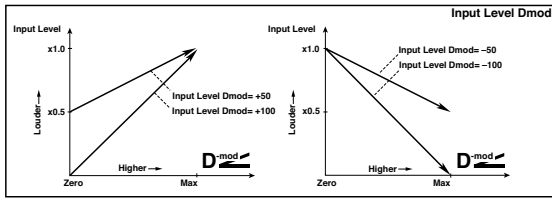

Pitch Shifter

This effect changes the pitch of the input signal. You can select from three types: Fast (quick response), Medium, and Slow (preserves tonal quality). You can also create an effect in which the pitch is gradually raised (or dropped) using the delay with feedback.

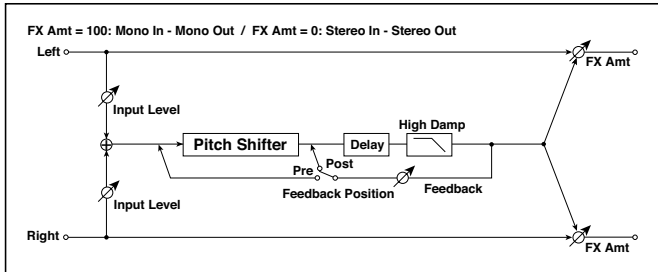

a	Mode	Slow, Medium, Fast	Switches Pitch Shifter mode	
b	Pitch Shift [1/2tone]	-24...+24	Sets the pitch shift amount by steps of a semi-tone	
	Src	Off...Tempo	Selects the modulation source of pitch shift amount	
	Amt	-24...+24	Sets the modulation amount of pitch shift amount	
c	Fine [cents]	-100...+100	Sets the pitch shift amount by steps of a cent	
	Amt	-100...+100	Sets the modulation amount of pitch shift amount	
d	Delay Time [msec]	0...2000	Sets the delay time	
e	Feedback Position	Pre, Post	Switches the feedback connection	
f	Feedback	-100...+100	Sets the feedback amount	
	High Damp [%]	0...100	Sets the damping amount in the high range	
g	Input Level Dmod [%]	-100...+100	Sets the modulation amount of the input level	
	Src	Off...Tempo	Selects the modulation source for the input level	
	Wet/Dry	Dry, 1:99...99:1, Wet	Balance between the wet and dry signal	
h	Src	Off...Tempo	See DMS (Dynamic Modulation Source)	
	Amt	-100...+100	Amount of modulation source	

a: Mode

This parameter switches the pitch shifter operating mode. With **Slow**, tonal quality will not be changed too much. With **Fast**, the effect becomes a Pitch Shifter that has a quick response, but may change the tone. **Medium** is in-between these two. If you do not need to set too much pitch shift amount, set this parameter to **Slow**. If you wish to change the pitch significantly, use **Fast**.

b: Pitch Shift [1/2tone]**b: Src****b: Amt****c: Fine [cents]****c: Amt**

The amount of pitch shift will use the value of the **Pitch Shift** plus the **Fine** value. The amount of modulation will use the **b: Amt** value plus the **c: Amt**.

The same Modulation Source is used for both **Pitch Shift** and **Fine**.

e: Feedback Position**f: Feedback**



When **Feedback Position** is set to **Pre**, the pitch shifter output is again input to the pitch shifter. Therefore, if you specify a higher value for the **Feedback** parameter, the pitch will be raised (or lowered) more and more each time feedback is repeated.

If **Feedback Position** is set to **Post**, the feedback signal will not pass through the pitch shifter again. Even if you specify a higher value for the **Feedback** parameter, the pitch-shifted sound will be repeated at the same pitch.

Pitch Shifter BPM

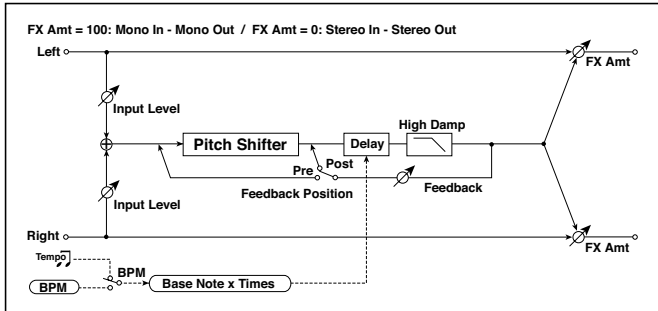
This pitch shifter enables you to set the delay time to match the song tempo.



a	Mode	Slow, Medium, Fast	Switches Pitch Shifter mode	
b	Pitch Shift [1/2tone]	-24...+24	Sets the pitch shift amount in steps of a semitone	
	Src	Off...Tempo	Selects the modulation source of pitch shift amount	
	Amt	-24...+24	Sets the modulation amount of pitch shift amount	
c	Fine [cents]	-100...+100	Sets the pitch shift amount in steps of one cent	
	Amt	-100...+100	Sets the modulation amount of pitch shift amount	
d	BPM	MIDI, 40.00... 300.00	MIDI syncs to the system tempo; 40-300 sets the tempo manually for this individual effect	
	Time Over?	---, OVER!	Displays an error message when the delay time exceeds the upper limit	
e	Delay Base Note		Selects the type of notes to specify the delay time	
	Times	x1...x32	Sets the number of notes to specify the delay time	
f	Feedback Position	Pre, Post	Switches the feedback connection	
g	Feedback	-100...+100	Sets the feedback amount	
	High Damp [%]	0...100	Sets the damping amount in the high range	

h	Input Level Dmod [%]	-100...+100	Sets the modulation amount of the input level
	Src	Off...Tempo	Selects the modulation source for the input level
i	Wet/Dry	Dry, 1:99...99:1, Wet	Balance between the wet and dry signal
	Src	Off...Tempo	See DMS (Dynamic Modulation Source)
	Amt	-100...+100	Amount of modulation source

d: BPM

e: Delay Base Note

e: Times

The delay time is the duration of “Times” number of “Delay Base Note” note values at the “BPM” tempo (or if “BPM” is set to MIDI, the tempo determined by MIDI Clock).



d: Time Over?

You can set the delay time up to 5,290msec. If the delay time exceeds this limit, the error message “OVER!” appears on the display. Set the delay time parameters so that this message will not appear. “Time Over?” is only a display parameter.

Pitch Shift Mod (Pitch Shift Modulation)

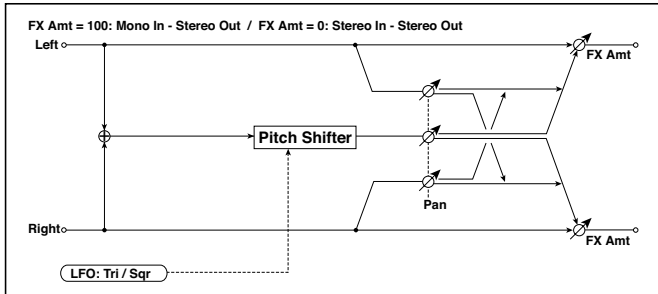
This effect modulates the detuned pitch shift amount using an LFO, adding a clear spread and width to the sound by panning the effect sound and dry sound to the left and right. This is especially effective when the effect sound and dry sound output from stereo speakers are mixed.



a	Pitch Shift [cents]	-100...+100	Sets the pitch difference from the input signal	
b	LFO Waveform	Triangle, Square	Selects the LFO Waveform	
c	LFO Frequency [Hz]	0.02...20.00	Sets the speed of the LFO	
	Src	Off...Tempo	Selects a modulation source for LFO speed	
	Amt	-20.00...+20.00	Sets the modulation amount of LFO speed	
d	MIDI Sync	Off, On	When this is on, the LFO speed is set by BPM, Base Note, and Times, instead of Frequency	
	BPM	MIDI, 40.00...300.00	MIDI syncs to the system tempo; 40-300 sets the tempo manually for this individual effect	
	Base Note		Selects the type of notes that specify the LFO speed	
	Times	x1...x32	Sets the number of notes that specify the LFO speed	
e	Depth	-100...+100	Sets the LFO modulation depth for pitch shift amount	
	Src	Off...Tempo	Selects the modulation source of the depth of modulation	
	Amt	-100...+100	Sets the modulation amount of the depth of modulation	
f	Pan	L, 1:99...99:1, R	Sets the panning effect sound and dry sound separately	

g	Wet/Dry	Dry, 1:99...99:1, Wet	Balance between the wet and dry signal
	Src	Off...Tempo	See DMS (Dynamic Modulation Source)
	Amt	-100...+100	Amount of modulation source

a: Pitch Shift [cents]

e: Depth

These parameters set the amount of pitch shift and amount of modulation by means of the LFO.

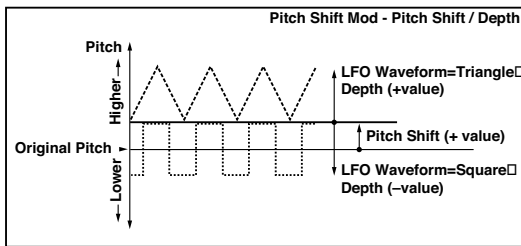

g: Pan

h: Wet/Dry

The Pan parameter pans the effect sound and dry sound to the left and right. With L, the effect sound is panned left, and the dry sound is panned right. With a Wet/Dry = Wet setting, the effect and dry sound will be output in a proportion of 1:1.

St. Pitch Shifter (Stereo Pitch Shifter)

This is a stereo pitch shifter. The pitch shift amount for the left and right channels can be reversed from each other.

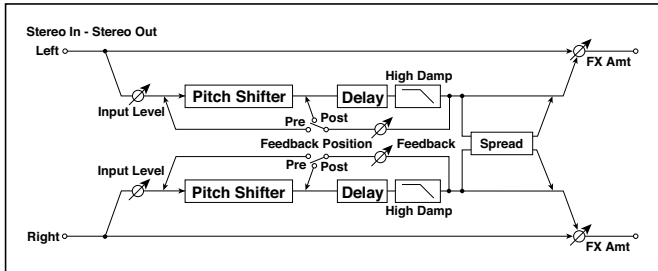

a	Mode	Slow, Medium, Fast	Switches Pitch Shifter mode
	L/R Pitch	Normal, Up/Down	Determines whether or not the L/R pitch shift amount is inverted
b	Pitch Shift [1/2tone]	-24...+24	Sets the pitch shift amount in steps of a semitone
	Src	Off...Tempo	Selects the modulation source of pitch shift amount
	Amt	-24...+24	Sets the modulation amount of pitch shift amount
c	Fine [cents]	-100...+100	Sets the pitch shift amount in steps of one cent
	Amt	-100...+100	Sets the modulation amount of pitch shift amount
d	L Delay [msec]	0...2000	Sets the delay time for the left channel
e	R Delay [msec]	0...2000	Sets the delay time for the right channel
f	Feedback	-100...+100	Sets the feedback amount
	High Damp [%]	0...100	Sets the damping amount in the high range
g	Feedback Position	Pre, Post	Switches the feedback connection
	Spread	-100...+100	Sets the width of the stereo image of the effect sound
h	Input Level Dmod [%]	-100...+100	Sets the modulation amount of the input level
	Src	Off...Tempo	Selects the modulation source for the input level

i	Wet/Dry	Dry, 1:99...99:1, Wet	Balance between the wet and dry signal	
	Src	Off...Tempo	See DMS (Dynamic Modulation Source)	
	Amt	-100...+100	Amount of modulation source	

a: L/R Pitch



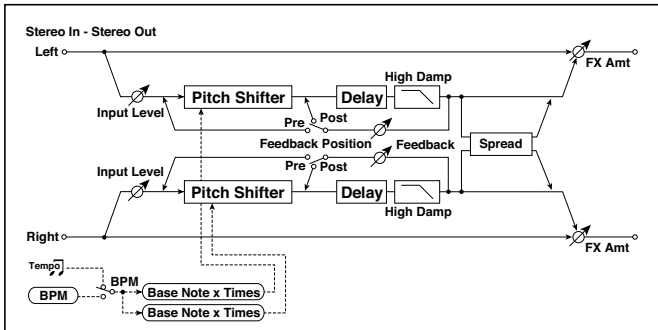

When you select Up/Down for this parameter, the pitch shift amount for the right channel will be reversed. If the pitch shift amount is positive, the pitch of the left channel is raised, and the pitch of the right channel is lowered.

St. PitchShift BPM (Stereo Pitch Shifter BPM)

This stereo pitch shifter enables you to set the delay time to match the song tempo.



a	Mode	Slow, Medium, Fast	Switches Pitch Shifter mode	
	L/R Pitch	Normal, Up/Down	Determines whether or not the L/R pitch shift amount is inverted	
b	Pitch Shift [1/2tone]	-24...+24	Sets the pitch shift amount in steps of a semitone	
	Src	Off...Tempo	Selects the modulation source of pitch shift amount	
	Amt	-24...+24	Sets the modulation amount of pitch shift amount	

c	Fine [cents]	-100...+100	Sets the pitch shift amount in steps of one cent	
	Amt	-100...+100	Sets the modulation amount of pitch shift amount Sets the modulation amount of pitch shift amount	
d	BPM	MIDI, 40.00... 300.00	MIDI syncs to the system tempo; 40-300 sets the tempo manually for this individual effect	
	Time Over? L	---, OVER!	Display the error message if the left channel delay time exceeds the upper limit	
	R	---, OVER!	Display the error message if the right channel delay time exceeds the upper limit	
e	L Delay Base Note		Selects the type of notes to specify the left channel delay time	
	Times	x1...x32	Sets the number of notes to specify the left channel delay time	
f	R Delay Base Note		Selects the type of notes to specify the right channel delay time	
	Times	x1...x32	Sets the number of notes to specify the right channel delay time	
g	Feedback Position	Pre, Post	Switches the feedback connection	
	Spread	-100...+100	Sets the width of the stereo image of the effect sound	
h	Feedback	-100...+100	Sets the feedback amount	
	High Damp [%]	0...100	Sets the damping amount in the high range	
i	Input Level Dmod [%]	-100...+100	Sets the modulation amount of the input level	
	Src	Off...Tempo	Selects the modulation source for the input level	
j	Wet/Dry	Dry, 1:99...99:1, Wet	Balance between the wet and dry signal	
	Src	Off...Tempo	See DMS (Dynamic Modulation Source)	
	Amt	-100...+100	Amount of modulation source	



MISC (Miscellaneous)

Stereo Decimator

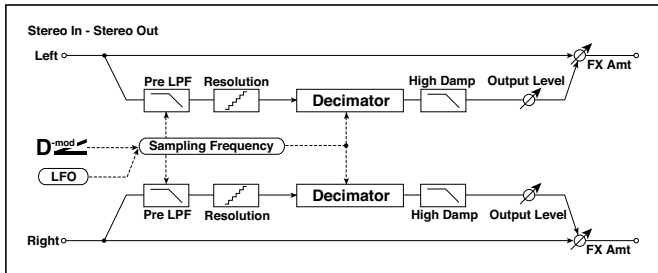
This effect creates a rough sound like a cheap sampler by lowering the sampling frequency and data bit length. You can also simulate noise unique to a sampler (aliasing).



a	Pre LPF	Off, On	Selects whether the harmonic noise caused by a decrease in sampling frequency is generated or not
	High Damp [%]	0...100	Sets the ratio of cut of the high range
b	Sampling Freq [Hz]	1.00k... 48.00k	Sets the sampling frequency
	Src	Off...Tempo	Selects the modulation source of the sampling frequency
	Amt	-48.00k... +48.00k	Sets the modulation amount of the sampling frequency
c	LFO Frequency [Hz]	0.02...20.00	Sets the speed of the LFO
	Src	Off...Tempo	Selects a modulation source for LFO speed
	Amt	-20.00... +20.00	Sets the modulation amount of LFO speed

d	MIDI Sync	Off, On	When this is on, the LFO speed is set by BPM, Base Note, and Times, instead of Frequency	
	BPM	MIDI, 40.00... 300.00	MIDI syncs to the system tempo; 40-300 sets the tempo manually for this individual effect	
	Base Note		Selects the type of notes that specify the LFO speed	
	Times	x1...x32	Sets the number of notes that specify the LFO speed	
e	Depth	0...100	Sets the depth of the sampling frequency LFO modulation	
	Src	Off...Tempo	Selects the LFO modulation source of the sampling frequency	
	Amt	-100...+100	Sets the LFO modulation amount of the sampling frequency	
f	Resolution	4...24	Sets the data bit length	
g	Output Level	0...100	Sets the output level	
	Src	Off...Tempo	Selects the modulation source for the output level	
	Amt	-100...+100	Sets the modulation amount of the output level	
h	Wet/Dry	Dry, 1:99...99:1, Wet	Balance between the wet and dry signal	
	Src	Off...Tempo	See DMS (Dynamic Modulation Source)	
	Amt	-100...+100	Amount of modulation source	

a: Pre LPF

If a sampler with a very low sampling frequency receives very high-pitched sound that could not be heard during playback, it could generate pitch noise that is unrelated to the original sound. Set “Pre LPF” to On to prevent this noise from being generated.

If you set the “Sampling Freq” to about 3 kHz and set “Pre LPF” to Off, you can create a sound like a ring modulator.

f: Resolution

g: Output Level

If you set a smaller value for the “Resolution” parameter, the sound may be distorted. The volume level may also be changed. Use “Output Level” to adjust the level.

St. Analog Record (Stereo Analog Record)

This effect simulates the noise caused by scratches and dust on analog records. It also reproduces some of the modulation caused by a warped turntable.

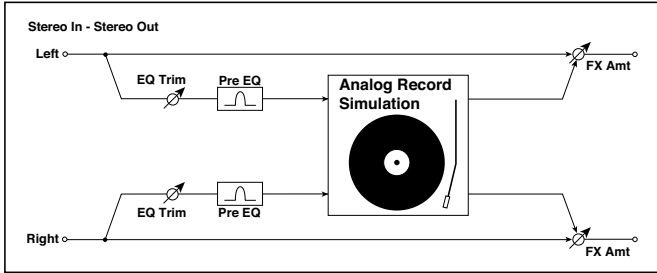

a	Speed [RPM]	33 1/3, 45, 78	Sets the r.p.m. of a record	
b	Flutter	0...100	Sets the modulation depth	
c	Noise Density	0...100	Sets the noise density	
	Noise Tone	0...100	Sets the noise tone	
d	Noise Level	0...100	Sets the noise level	
	Src	Off...Tempo	Selects the modulation source for the noise level	
	Amt	-100...+100	Sets the modulation amount of the noise level	
e	Click Level	0...100	Sets the click noise level	
	Src	Off...Tempo	Selects the modulation source for the click noise level	
	Amt	-100...+100	Sets the modulation amount of the click noise level	
f	EQ Trim	0...100	Sets the EQ input level	
g	Pre EQ Cutoff [Hz]	300...10.00k	Sets the EQ center frequency	
	Q	0.5...10.0	Sets the EQ band width	
	Gain [dB]	-18.0...+18.0	Sets the EQ gain	
h	Wet/Dry	Dry, 1:99...99:1, Wet	Balance between the wet and dry signal	
	Src	Off...Tempo	See DMS (Dynamic Modulation Source)	
	Amt	-100...+100	Amount of modulation source	

b: Flutter

This parameter enables you to set the depth of the modulation caused by a warped turntable.



e: Click Level

This parameter enables you to set the level of the click noise that occurs once every rotation of the turntable. This simulation reproduces record noise, and the noise generated after the music on a vinyl record finishes.

Doppler

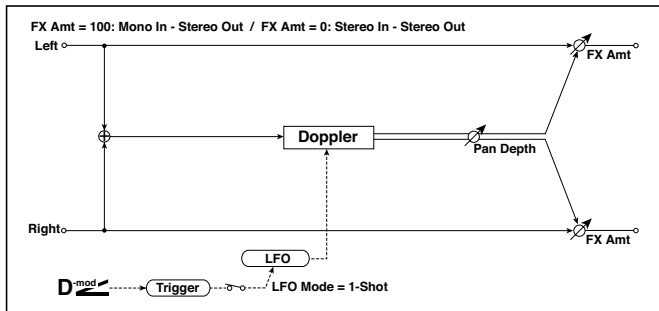
This effect simulates the “Doppler effect” of a moving sound with a changing pitch, similar to the siren of an ambulance. Mixing the effect sound with the dry sound will create a unique chorus effect.



a	LFO Mode	Loop, 1-Shot	Switches LFO operation mode	
	Src	Off...Tempo	Selects the modulation source of LFO reset	
b	LFO Sync	Off, On	Switches between LFO reset on and off when LFO Mode is set to Loop	
c	LFO Frequency [Hz]	0.02...20.00	Sets the speed of the LFO	
	Src	Off...Tempo	Selects a modulation source for LFO speed	
	Amt	-20.00...+20.00	Sets the modulation amount of LFO speed	
d	MIDI Sync	Off, On	When this is on, the LFO speed is set by BPM, Base Note, and Times, instead of Frequency	
	BPM	MIDI, 40.00...300.00	MIDI syncs to the system tempo; 40-300 sets the tempo manually for this individual effect	
	Base Note		Selects the type of notes that specify the LFO speed	
	Times	x1...x32	Sets the number of notes that specify the LFO speed	
e	Pitch Depth	0...100	Sets the pitch variation of the moving sound	
	Src	Off...Tempo	Selects the modulation source of pitch variation	
	Amt	-100...+100	Sets the modulation amount of pitch variation	
f	Pan Depth	-100...+100	Sets the panning of the moving sound	
	Src	Off...Tempo	Selects the modulation source of panning	
	Amt	-100...+100	Sets the modulation amount of panning	
g	Wet/Dry	Dry, 1:99...99:1, Wet	Balance between the wet and dry signal	
	Src	Off...Tempo	See DMS (Dynamic Modulation Source)	
	Amt	-100...+100	Amount of modulation source	

a: LFO Mode**a: Src****b: LFO Sync**

The “LFO Mode” parameter switches LFO operation mode. When Loop is selected, the Doppler effect will be created repeatedly. If “LFO Sync” is set to On, the LFO will be reset when the modulation source specified with the “Src” parameter is turned on.

When “LFO Mode” is set to 1-Shot, the Doppler effect is created only once when the modulation source specified in the “Src” field is turned on. At this time if you do not set the “Src” parameter, the Doppler effect will not be created, and no effect sound will be output.

MD1 The effect is off when a value for the modulation source specified for the “Src” parameter is smaller than 64, and the effect is on when the value is 64 or higher. The Doppler effect is triggered when the value changes from 63 or smaller to 64 or higher.

e: Pitch Depth

With the Doppler effect, the pitch is raised when the sound approaches, and the pitch is lowered when the sound goes away. This parameter sets this pitch variation.

f: Pan Depth

This parameter sets the width of the stereo image of the effect sound. With larger values, the sound seems to come and go from much further away. With positive values, the sound moves from left to right; with negative values, the sound moves from right to left.

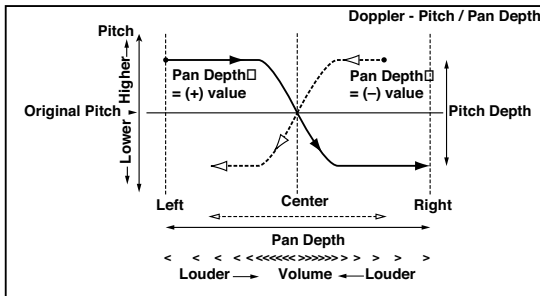

Scratch

This effect is applied by recording the input signal and moving the modulation source. It simulates the sound of scratches you can make using a turntable.

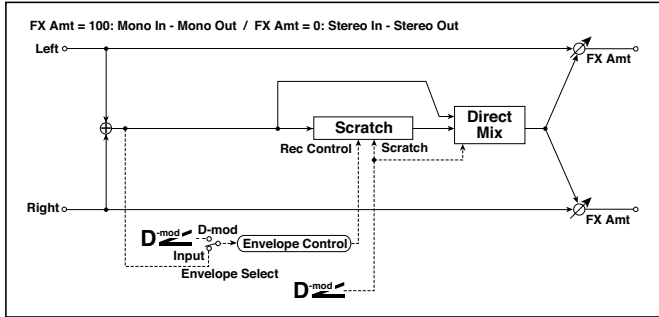

a	Scratch Source	Off...Tempo	Selects the modulation source for simulation control
b	Response	0...100	Sets the speed of the response to the Scratch Src
c	Envelope Select	D-mod, Input	Selects whether the start and end of recording is controlled via the modulation source or the input signal level
	Src	Off...Tempo	Selects the modulation source that controls recording when Envelope Select is set to D-mod
d	Threshold	0...100	Sets the recording start level when Envelope Select is set to Input
e	Response	0...100	Sets the speed of the response to the end of recording
f	Direct Mix	Always On, Always Off, Cross Fade	Selects how a dry sound is mixed
g	Wet/Dry	Dry, 1:99...99:1, Wet	Balance between the wet and dry signal
	Src	Off...Tempo	See DMS (Dynamic Modulation Source)
	Amt	-100...+100	Amount of modulation source

a: Scratch Source**b: Response**

The Scratch Source parameter enables you to select the modulation source that controls simulation. The value of the modulation source corresponds to the playback position. The Response parameter enables you to set the speed of the response to the modulation source.

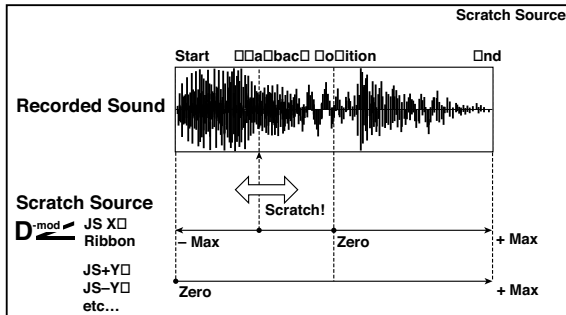
**c: Envelope Select****c: Src****d: Threshold**

When "Envelope Select" is set to D-mod, the input signal will be recorded only when the modulation source value is 64 or higher.

When "Envelope Select" is set to Input, the input signal will be recorded only when its level is over the Threshold value.

The maximum recording time is 2,730msec. If this is exceeded, the recorded data will start being erased from the top.

e: Response

This parameter enables you to set the speed of the response to the end of recording. Set a smaller value when you are recording a phrase or rhythm pattern, and set a higher value if you are recording only one note.

f: Direct Mix

With Always On, a dry sound is usually output. With Always Off, dry sounds are not output. With Cross Fade, a dry sound is usually output, and it is muted only when scratching.

Set Wet/Dry to 100 to use this parameter effectively.

Auto Reverse

This effect records the input signal and automatically plays it in reverse (the effect is similar to a tape reverse sound).

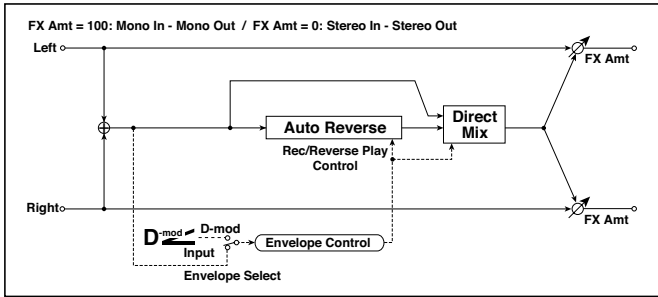

a	Rec Mode	Single, Multi	Sets the recording mode	
b	Reverse Time [msec]	20...2640	Sets the maximum duration of the reverse playback	
c	Envelope Select	D-mod, Input	Selects whether the start and end of recording is controlled via the modulation source or the input signal level	
	Src	Off...Tempo	Selects the modulation source that controls recording when Envelope Select is set to D-mod	
d	Threshold	0...100	Sets the recording start level when Envelope Select is set to Input	
e	Response	0...100	Sets the speed of the response to the end of recording	
f	Direct Mix	Always On, Always Off, Cross Fade	Selects how a dry sound is mixed	
g	Wet/Dry	Dry, 1:99...99:1, Wet	Balance between the wet and dry signal	
	Src	Off...Tempo	See DMS (Dynamic Modulation Source)	
	Amt	-100...+100	Amount of modulation source	

a: Rec Mode

b: Reverse Time [msec]

When “Rec Mode” is set to Single, you can set up to 2,640msec for “Reverse Time.” If recording starts during the reverse playback, the playback will be interrupted.

When “Rec Mode” is set to Multi, you can make another recording during the reverse playback. However, the maximum Reverse Time is limited to 1,320msec.

If you wish to record a phrase or rhythm pattern, set “Rec Mode” to Single. If you record only one note, set “Rec Mode” to Multi.

The “Reverse Time” parameter specifies the maximum duration of the reverse playback. The part in excess of this limit will not be played in reverse. If you wish to add short pieces of the reverse playback of single notes, make the “Reverse Time” shorter.

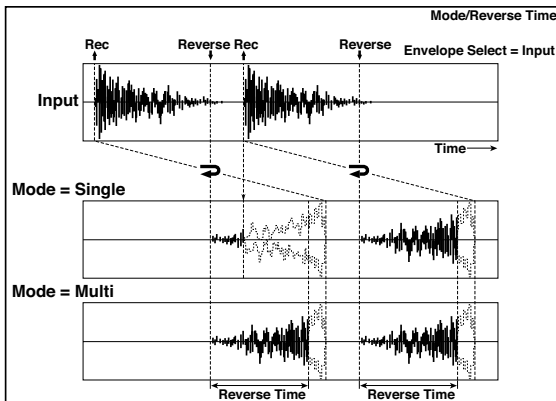

c: Envelope Select

c: Src

d: Threshold

These parameters select the source to control the start and end of recording.

When “Envelope Select” is set to D-mod, the input signal will be recorded only when the value of the modulation source selected by the Src parameter is 64 or higher.

When “Envelope Select” is set to Input, the input signal will be recorded only when its level exceeds the Threshold level.

When recording is completed, reverse playback starts immediately.

P4EQ - Cho/Flng (Parametric 4-Band EQ - Chorus/Flanger)

This effect combines a mono four-band parametric equalizer and a chorus/flanger.

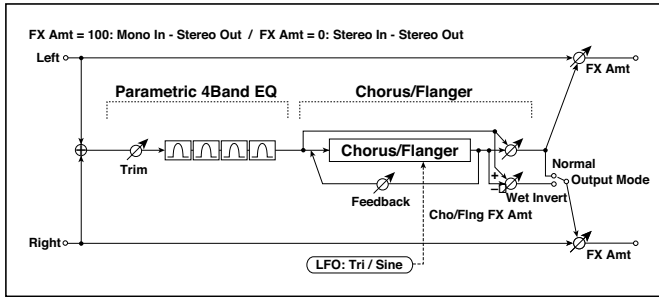

P4EQ			
a	[E]Trim	0...100	Sets the parametric EQ input level
b	[E]B1 Cutoff [Hz]	20...1.00k	Sets the center frequency of Band 1
	Q	0.5...10.0	Sets the bandwidth of Band 1
	Gain [dB]	-18...+18	Sets the gain of Band 1
c	[E]B2 Cutoff [Hz]	50...5.00k	Sets the center frequency of Band 2
	Q	0.5...10.0	Sets the bandwidth of Band 2
	Gain [dB]	-18...+18	Sets the gain of Band 2
d	[E]B3 Cutoff [Hz]	300...10.00k	Sets the center frequency of Band 3
	Q	0.5...10.0	Sets the bandwidth of Band 3
	Gain [dB]	-18...+18	Sets the gain of Band 3
e	[E]B4 Cutoff [Hz]	500...20.00k	Sets the center frequency of Band 4
	Q	0.5...10.0	Sets the bandwidth of Band 4
	Gain [dB]	-18...+18	Sets the gain of Band 4
CHORUS/FLANGER			
f	[F]LFO Frequency [Hz]	0.02...20.00	Sets the speed of the LFO
	LFO Waveform	Triangle, Sine	Selects the LFO Waveform
g	[F]Delay Time [msec]	0.0...1350.0	Sets the delay time
	Depth	0...100	Sets the depth of LFO modulation
	Feedback	-100...+100	Sets the feedback amount

h	[F]Cho/Fing Wet/Dry	-Wet, -1:99... Dry...99:1, Wet	Sets the effect balance of the chorus/flanger
	Src	Off...Tempo	Selects the Wet/Dry modulation source for the chorus/flanger
	Amt	-100...+100	Sets the Wet/Dry modulation amount for the chorus/flanger
i	[F]Output Mode	Normal, Wet Invert	Selects the output mode for the chorus/flanger
j	Wet/Dry	Dry, 1:99...99:1, Wet	Balance between the wet and dry signal
	Src	Off...Tempo	See DMS (Dynamic Modulation Source)
	Amt	-100...+100	Amount of modulation source

i: Output Mode

When Wet Invert is selected, the right channel phase of the chorus/flanger effect sound is inverted. This creates pseudo-stereo effects and adds spread.

However, if a mono-input type effect is connected after this effect, the left and right sounds may cancel each other, eliminating the chorus/flanger effects.

P4EQ - Phaser (Parametric 4-Band EQ - Phaser)

This effect combines a mono four-band parametric equalizer and a phaser.

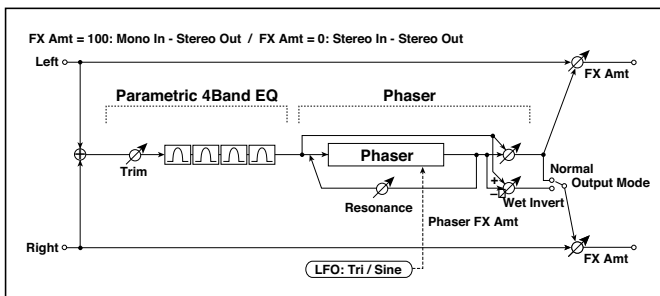

P4EQ			
a	[E]Trim	0...100	Sets the parametric EQ input level
b	[E]B1 Cutoff [Hz]	20...1.00k	Sets the center frequency of Band 1
	Q	0.5...10.0	Sets the bandwidth of Band 1
	Gain [dB]	-18...+18	Sets the gain of Band 1
c	[E]B2 Cutoff [Hz]	50...5.00k	Sets the center frequency of Band 2
	Q	0.5...10.0	Sets the bandwidth of Band 2
	Gain [dB]	-18...+18	Sets the gain of Band 2
d	[E]B3 Cutoff [Hz]	300...10.00k	Sets the center frequency of Band 3
	Q	0.5...10.0	Sets the bandwidth of Band 3
	Gain [dB]	-18...+18	Sets the gain of Band 3
e	[E]B4 Cutoff [Hz]	500...20.00k	Sets the center frequency of Band 4
	Q	0.5...10.0	Sets the bandwidth of Band 4
	Gain [dB]	-18...+18	Sets the gain of Band 4
PHASER			
f	[P]LFO Frequency [Hz]	0.02...20.00	Sets the speed of the LFO
	LFO Waveform	Triangle, Sine	Selects the LFO Waveform
g	[P]Manual	0...100	Sets the frequency to which the effect is applied
	Depth	0...100	Sets the depth of LFO modulation
	Resonance	-100...+100	Sets the resonance amount
h	[P]Phaser Wet/Dry	-Wet, -1:99... Dry...99:1, Wet	Sets the phaser effect balance
	Src	Off...Tempo	Selects the Wet/Dry modulation source for the phaser
	Amt	-100...+100	Sets the Wet/Dry modulation amount for the phaser
i	[P]Output Mode	Normal, Wet Invert	Selects the phaser output mode
j	Wet/Dry	Dry, 1:99...99:1, Wet	Balance between the wet and dry signal
	Src	Off...Tempo	See DMS (Dynamic Modulation Source)
	Amt	-100...+100	Amount of modulation source

P4EQ - Mt. Delay (Parametric 4-Band EQ - Multitap Delay)

This effect combines a mono four-band parametric equalizer and a multitap delay.

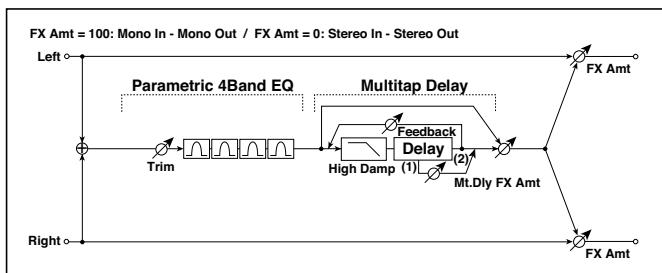

P4EQ			
a	[E]Trim	0...100	Sets the parametric EQ input level
b	[E]B1 Cutoff [Hz]	20...1.00k	Sets the center frequency of Band 1
	Q	0.5...10.0	Sets the bandwidth of Band 1
	Gain [dB]	-18...+18	Sets the gain of Band 1
c	[E]B2 Cutoff [Hz]	50...5.00k	Sets the center frequency of Band 2
	Q	0.5...10.0	Sets the bandwidth of Band 2
	Gain [dB]	-18...+18	Sets the gain of Band 2
d	[E]B3 Cutoff [Hz]	300...10.00k	Sets the center frequency of Band 3
	Q	0.5...10.0	Sets the bandwidth of Band 3
	Gain [dB]	-18...+18	Sets the gain of Band 3
e	[E]B4 Cutoff [Hz]	500...20.00k	Sets the center frequency of Band 4
	Q	0.5...10.0	Sets the bandwidth of Band 4
	Gain [dB]	-18...+18	Sets the gain of Band 4
MULTITAP DELAY			
f	[D]Tap1 Time [msec]	0.0...1360.0	Sets the Tap1 delay time
	Tap1 Level	0...100	Sets the Tap1 output level
g	[D]Tap2 Time [msec]	0.0...1360.0	Sets the Tap2 delay time
	Feedback (Tap2)	-100...+100	Sets the Tap2 feedback amount
h	[D]High Damp [%]	0...100	Sets the damping amount in the high range

i	[D]Mt.Delay Wet/Dry	Dry, 1:99...99:1, Wet	Sets the multitap delay effect balance
	Src	Off...Tempo	Selects the Wet/Dry modulation source for the multitap delay
	Amt	-100...+100	Sets the Wet/Dry modulation amount for the multitap delay
j	Wet/Dry	Dry, 1:99...99:1, Wet	Balance between the wet and dry signal
	Src	Off...Tempo	See DMS (Dynamic Modulation Source)
	Amt	-100...+100	Amount of modulation source

Comp - Wah (Compressor - Wah/Auto Wah)

This effect combines a mono compressor and a wah. You can change the order of the connection.

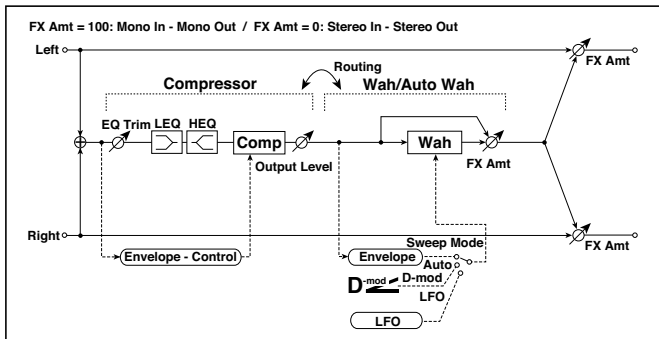

COMPRESSOR				
a	[C] Sensitivity	1...100	Sets the sensitivity	
b	[C]Attack	1...100	Sets the attack level	
	Output Level	0...100	Sets the compressor output level	
c	[C]EQ Trim	0...100	Sets the EQ input level	
d	[C]Pre LEQ Gain [dB]	-15...+15	Sets the gain of Low EQ	
	Pre HEQ Gain [dB]	-15...+15	Sets the gain of High EQ	
WAH				
e	[W]Frequency Bottom	0...100	Sets the lower limit of the wah center frequency	
	Frequency Top	0...100	Sets the upper limit of the wah center frequency	
f	[w]Sweep Mode	Auto, D-mod, LFO	Selects the control from auto-wah, modulation source, and LFO	
	Src	Off...Tempo	Selects the modulation source for the wah when Sweep Mode=D-mod	
g	[W]LFO Frequency [Hz]	0.02...20.00	Sets the speed of the LFO	
	Resonance	0...100	Sets the resonance amount	
	LPF	Off, On	Switches the wah low pass filter on and off	
h	[W]Wet/Dry	Dry, 1:99...99:1, Wet	Sets the wah effect balance	
	Src	Off...Tempo	Selects the Wet/Dry modulation source for the wah	
	Amt	-100...+100	Sets the Wet/Dry modulation amount for the wah	
i	Routing	Comp > Wah, Wah > Comp	Switches the order of the compressor and wah	
j	Wet/Dry	Dry, 1:99...99:1, Wet	Balance between the wet and dry signal	
	Src	Off...Tempo	See DMS (Dynamic Modulation Source)	
	Amt	-100...+100	Amount of modulation source	

Comp - P4EQ (Compressor - Parametric 4-Band EQ)

This effect combines a mono compressor and a four-band parametric equalizer. You can change the order of the effects.

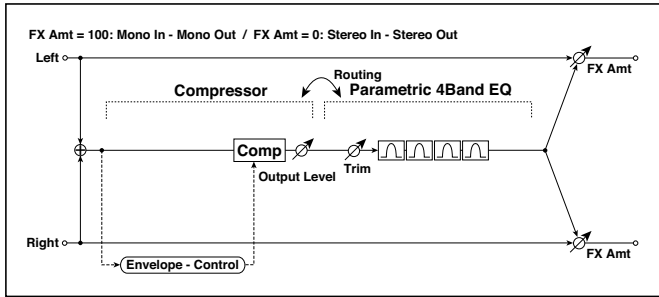

COMPRESSOR			
a	[C]Sensitivity	1...100	Sets the sensitivity
b	[C]Attack	1...100	Sets the attack level
	Output Level	0...100	Sets the compressor output level
P4EQ			
c	[E]Trim	0...100	Sets the parametric EQ input level
d	[E]B1 Cutoff [Hz]	20...1.00k	Sets the center frequency of Band 1
	Q	0.5...10.0	Sets the bandwidth of Band 1
	Gain [dB]	-18...+18	Sets the gain of Band 1
e	[E]B2 Cutoff [Hz]	50...5.00k	Sets the center frequency of Band 2
	Q	0.5...10.0	Sets the bandwidth of Band 2
	Gain [dB]	-18...+18	Sets the gain of Band 2
f	[E]B3 Cutoff [Hz]	300...10.00k	Sets the center frequency of Band 3
	Q	0.5...10.0	Sets the bandwidth of Band 3
	Gain [dB]	-18...+18	Sets the gain of Band 3
g	[E]B4 Cutoff [Hz]	500...20.00k	Sets the center frequency of Band 4
	Q	0.5...10.0	Sets the bandwidth of Band 4
	Gain [dB]	-18...+18	Sets the gain of Band 4
h	Routing	Comp > P4EQ, P4EQ > Comp	Switches the order of the compressor and parametric EQ

i	Wet/Dry	Dry, 1:99...99:1, Wet	Balance between the wet and dry signal	
	Src	Off...Tempo	See DMS (Dynamic Modulation Source)	
	Amt	-100...+100	Amount of modulation source	

Comp - Cho/Fing (Compressor - Chorus/Flanger)

This effect combines a mono compressor and a chorus/flanger. You can change the order of the effects.

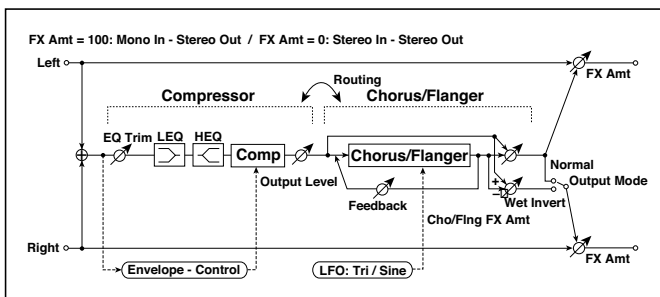

COMPRESSOR

a	[C] Sensitivity	1...100	Sets the sensitivity	
b	[C] Attack	1...100	Sets the attack level	
	Output Level	0...100	Sets the compressor output level	
c	[C] EQ Trim	0...100	Sets the EQ input level	
d	[C] Pre LEQ Gain [dB]	-15...+15	Sets the gain of Low EQ	
	Pre HEQ Gain [dB]	-15...+15	Sets the gain of High EQ	

CHORUS/FLANGER

e	[F] LFO Frequency [Hz]	0.02...20.00	Sets the speed of the LFO	
	LFO Waveform	Triangle, Sine	Selects the LFO Waveform	
f	[F] Delay Time [msec]	0.0...1350.0	Sets the delay time	
	Depth	0...100	Sets the depth of LFO modulation	
	Feedback	-100...+100	Sets the feedback amount	

g	[F]Cho/Flng Wet/Dry	-Wet, -1:99... Dry...99:1, Wet	Sets the effect balance of the chorus/flanger
	Src	Off...Tempo	Selects the Wet/Dry modulation source for the chorus/flanger
	Amt	-100...+100	Sets the Wet/Dry modulation amount for the chorus/flanger
h	[F]Output Mode	Normal, Wet Invert	Selects the output mode for the chorus/flanger
i	Routing	Comp > Flanger, Flanger > Comp	Switches the order of the compressor and chorus/flanger
j	Wet/Dry	Dry, 1:99...99:1, Wet	Balance between the wet and dry signal
	Src	Off...Tempo	See DMS (Dynamic Modulation Source)
	Amt	-100...+100	Amount of modulation source

h: [F]Output Mode

i: Routing

When Wet Invert is selected, the right channel phase of the chorus/flanger effect sound is inverted. This creates pseudo-stereo effects and adds spread.

However, if a mono-input type effect is connected after this effect, the left and right sounds may cancel each other, eliminating the chorus/flanger effects.

When "Routing" is set to Flanger/Comp, "[F]Output Mode" will be set to Normal.

Comp - Phaser (Compressor - Phaser)

This effect combines a mono compressor and a phaser. You can change the order of the effects.

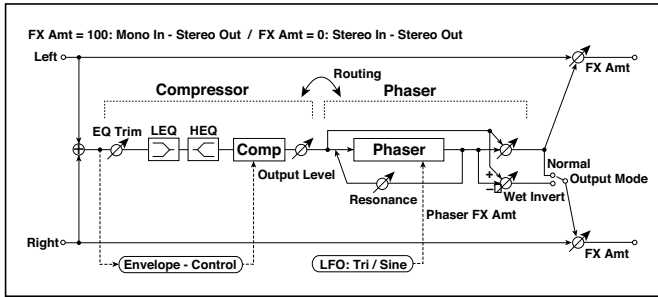

COMPRESSOR

a	[C] Sensitivity	1...100	Sets the sensitivity
b	[C]Attack	1...100	Sets the attack level
	Output Level	0...100	Sets the compressor output level
c	[C]EQ Trim	0...100	Sets the EQ input level
d	[C]Pre LEQ Gain [dB]	-15...+15	Sets the gain of Low EQ
	Pre HEQ Gain [dB]	-15...+15	Sets the gain of High EQ

PHASER

e	[P]LFO Frequency [Hz]	0.02...20.00	Sets the speed of the LFO
	LFO Waveform	Triangle, Sine	Selects the LFO Waveform
f	[P]Manual	0...100	Sets the frequency to which the effect is applied
	Depth	0...100	Sets the depth of LFO modulation
	Resonance	-100...+100	Sets the resonance amount
g	[P]Phaser Wet/Dry	-Wet, -1:99... Dry...99:1, Wet	Sets the phaser effect balance
	Src	Off...Tempo	Selects the Wet/Dry modulation source for the phaser
	Amt	-100...+100	Sets the Wet/Dry modulation amount for the phaser
h	[F]Output Mode	Normal, Wet Invert	Selects the phaser output mode
i	Routing	Comp > Phaser, Phaser > Comp	Switches the order of the compressor and phaser

j	Wet/Dry	Dry, 1:99...99:1, Wet	Balance between the wet and dry signal
	Src	Off...Tempo	See DMS (Dynamic Modulation Source)
	Amt	-100...+100	Amount of modulation source

Comp - Mt. Delay (Compressor - Multitap Delay)

This effect combines a mono compressor and a multitap delay. You can change the order of the effects.

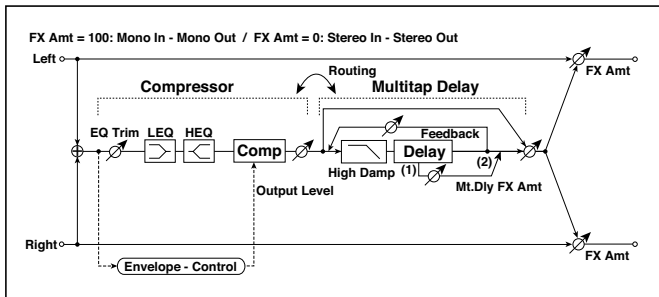

COMPRESSOR			
a	[C]Sensitivity	1...100	Sets the sensitivity
b	[C]Attack	1...100	Sets the attack level
	Output Level	0...100	Sets the compressor output level
c	[C]EQ Trim	0...100	Sets the EQ input level
d	[C]Pre LEQ Gain [dB]	-15...+15	Sets the gain of Low EQ
	Pre HEQ Gain [dB]	-15...+15	Sets the gain of High EQ
MULTITAP DELAY			
e	[D]Tap1 Time [msec]	0.0...1360.0	Sets the Tap1 delay time
	Tap1 Level	0...100	Sets the Tap1 output level
f	[D]Tap2 Time [msec]	0.0...1360.0	Sets the Tap2 delay time
	Feedback (Tap2)	-100...+100	Sets the Tap2 feedback amount
g	[D]High Damp [%]	0...100	Sets the damping amount in the high range

h	[D]Mt.Delay Wet/Dry	Dry, 1 : 99...99 : 1, Wet	Sets the multitap delay effect balance
	Src	Off...Tempo	Selects the Wet/Dry modulation source for the multitap delay
	Amt	-100...+100	Sets the Wet/Dry modulation amount for the multitap delay
i	Routing	Comp > Mt.Delay, Mt.Delay > Comp	Switches the order of the compressor and multitap delay
j	Wet/Dry	Dry, 1:99...99:1, Wet	Balance between the wet and dry signal
	Src	Off...Tempo	See DMS (Dynamic Modulation Source)
	Amt	-100...+100	Amount of modulation source

Limiter - P4EQ (Limiter - Parametric 4-Band EQ)

This effect combines a mono limiter and a four-band parametric equalizer. You can change the order of the effects.

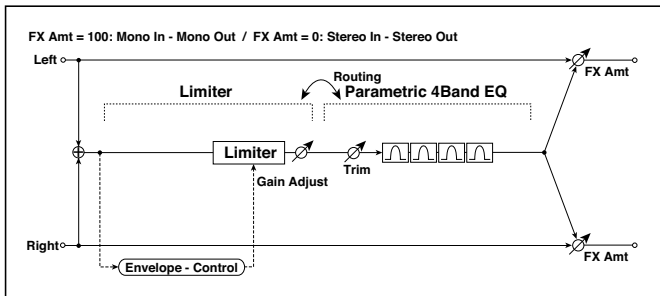

LIMITER

a	[L]Ratio	1.0 : 1... 50.0 : 1, Inf : 1	Sets the signal compression ratio
	Threshold [dB]	-40...0	Sets the level above which the compressor is applied
b	[L]Attack	1...100	Sets the attack time
	Release	1...100	Sets the release time
c	[L]Gain Adjust [dB]	-Inf, -38...+24	Sets the limiter output gain
P4EQ			

d	[E]Trim	0...100	Sets the parametric EQ input level	
e	[E]B1 Cutoff [Hz]	20...1.00k	Sets the center frequency of Band 1	
	Q	0.5...10.0	Sets the bandwidth of Band 1	
	Gain [dB]	-18...+18	Sets the gain of Band 1	
f	[E]B2 Cutoff [Hz]	50...5.00k	Sets the center frequency of Band 2	
	Q	0.5...10.0	Sets the bandwidth of Band 2	
	Gain [dB]	-18...+18	Sets the gain of Band 2	
g	[E]B3 Cutoff [Hz]	300...10.00k	Sets the center frequency of Band 3	
	Q	0.5...10.0	Sets the bandwidth of Band 3	
	Gain [dB]	-18...+18	Sets the gain of Band 3	
h	[E]B4 Cutoff [Hz]	500...20.00k	Sets the center frequency of Band 4	
	Q	0.5...10.0	Sets the bandwidth of Band 4	
	Gain [dB]	-18...+18	Sets the gain of Band 4	
i	Routing	Limiter > P4EQ, P4EQ > Limiter	Switches the order of the limiter and parametric EQ	
j	Wet/Dry	Dry, 1:99...99:1, Wet	Balance between the wet and dry signal	
	Src	Off...Tempo	See DMS (Dynamic Modulation Source)	
	Amt	-100...+100	Amount of modulation source	

a: [L]Ratio

a: Threshold [dB]

c: [L]Gain Adjust [dB]

This parameter sets the signal compression “[L]Ratio”. Compression is applied only when the signal level exceeds the “Threshold” value.

Adjust the output level using the “Gain Adjust” parameter, since compression causes the entire level to be reduced.

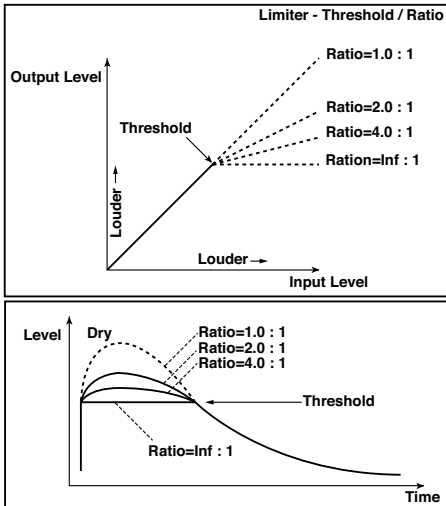

Limiter - Cho/Fing (Limiter - Chorus/Flanger)

This effect combines a mono limiter and a chorus/flanger. You can change the order of the effects.

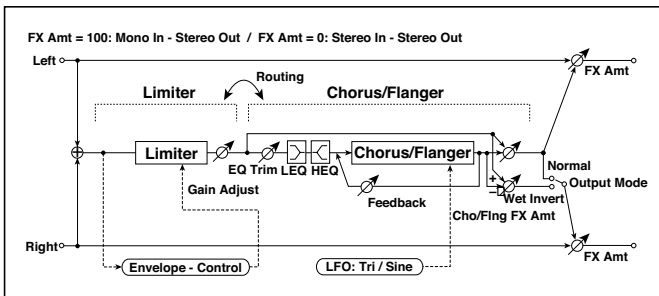

LIMITER				
a	[L]Ratio	1.0 : 1... 50.0 : 1, Inf : 1	Sets the signal compression ratio	
	Threshold [dB]	-40...0	Sets the level above which the compressor is applied	
b	[L]Attack	1...100	Sets the attack time	
	Release	1...100	Sets the release time	
c	[L]Gain Adjust [dB]	-Inf, -38...+24	Sets the limiter output gain	
CHORUS/FLANGER				
d	[F]LFO Frequency [Hz]	0.02...20.00	Sets the speed of the LFO	
	LFO Waveform	Triangle, Sine	Selects the LFO Waveform	
e	[F]Delay Time [msec]	0.0...1350.0	Sets the delay time	
	Depth	0...100	Sets the depth of LFO modulation	
	Feedback	-100...+100	Sets the feedback amount	
f	[F]EQ Trim	0...100	Sets the EQ input level	
g	[F]Pre LEQ Gain [dB]	-15...+15	Sets the gain of Low EQ	
	Pre HEQ Gain [dB]	-15...+15	Sets the gain of High EQ	
h	[F]Cho/Flng Wet/Dry	-Wet, -1:99... Dry...99:1, Wet	Sets the effect balance of the chorus/flanger	
	Src	Off...Tempo	Selects the Wet/Dry modulation source for the chorus/flanger	
	Amt	-100...+100	Sets the Wet/Dry modulation amount for the chorus/flanger	
i	[F]Output Mode	Normal, Wet Invert	Selects the output mode for the chorus/flanger	
	Routing	Limiter > Flanger, Flanger > Limiter	Switches the order of the limiter and chorus/flanger	
j	Wet/Dry	Dry, 1:99...99:1, Wet	Balance between the wet and dry signal	
	Src	Off...Tempo	See DMS (Dynamic Modulation Source)	
	Amt	-100...+100	Amount of modulation source	

Limiters - Phaser

This effect combines a mono limiter and a phaser. You can change the order of the effects.

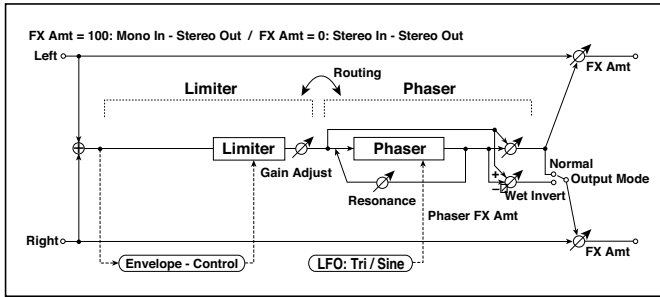

LIMITER			
a	[L]Ratio	1.0 : 1... 50.0 : 1, Inf : 1	Sets the signal compression ratio
	Threshold [dB]	-40...0	Sets the level above which the compressor is applied
b	[L]Attack	1...100	Sets the attack time
	Release	1...100	Sets the release time
c	[L]Gain Adjust [dB]	-Inf, -38...+24	Sets the limiter output gain
PHASER			
d	[P]LFO Frequency [Hz]	0.02...20.00	Sets the speed of the LFO
	LFO Waveform	Triangle, Sine	Selects the LFO Waveform
e	[P]Manual	0...100	Sets the frequency to which the effect is applied
	Depth	0...100	Sets the depth of LFO modulation
	Resonance	-100...+100	Sets the resonance amount
f	[P]Phaser Wet/Dry	-Wet, -1:99... Dry...99:1, Wet	Sets the phaser effect balance
	Src	Off...Tempo	Selects the phaser's Wet/Dry modulation source
	Amt	-100...+100	Sets the phaser's Wet/Dry modulation amount
g	[P]Output Mode	Normal, Wet Invert	Selects the phaser output mode
h	Routing	Limiters > Phaser, Phaser > Limiters	Switches the order of the limiter and phaser

i	Wet/Dry	Dry, 1:99...99:1, Wet	Balance between the wet and dry signal
	Src	Off...Tempo	See DMS (Dynamic Modulation Source)
	Amt	-100...+100	Amount of modulation source

Limiters - Mt.Delay (Limiter - Multitap Delay)

This effect combines a mono limiter and a multitap delay. You can change the order of the effects.

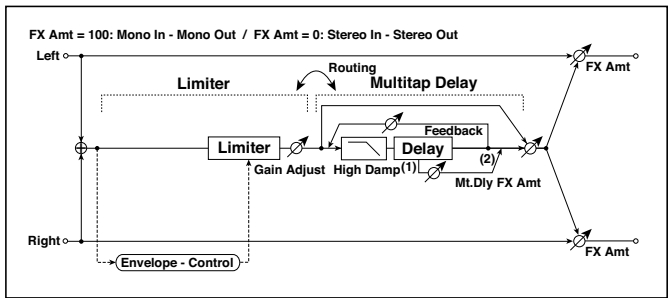

LIMITER			
a	[L]Ratio	1.0 : 1... 50.0 : 1, Inf : 1	Sets the signal compression ratio
	Threshold [dB]	-40...0	Sets the level above which the compressor is applied
b	[L]Attack	1...100	Sets the attack time
	Release	1...100	Sets the release time
c	[L]Gain Adjust [dB]	-Inf, -38...+24	Sets the limiter output gain
MULTITAP DELAY			
d	[D]Tap1 Time [msec]	0.0...1360.0	Sets the Tap1 delay time
	Tap1 Level	0...100	Sets the Tap1 output level
e	[D]Tap2 Time [msec]	0.0...1360.0	Sets the Tap2 delay time
	Feedback	-100...+100	Sets the Tap2 feedback amount
f	[D]High Damp [%]	0...100	Sets the damping amount in the high range
g	[D]Mt.Delay Wet/Dry	Dry, 1:99...99:1, Wet	Sets the multitap delay effect balance
	Src	Off...Tempo	Selects the multitap delay's Wet/Dry modulation source
	Amt	-100...+100	Sets the multitap delay's Wet/Dry modulation amount
h	Routing	Limiter > Mt.Delay, Mt.Delay > Limiter	Switches the order of the limiter and multitap delay
i	Wet/Dry	Dry, 1:99...99:1, Wet	Balance between the wet and dry signal
	Src	Off...Tempo	See DMS (Dynamic Modulation Source)
	Amt	-100...+100	Amount of modulation source

Exciter - Comp (Exciter - Compressor)

This effect combines a mono exciter and a compressor. You can change the order of the effects.

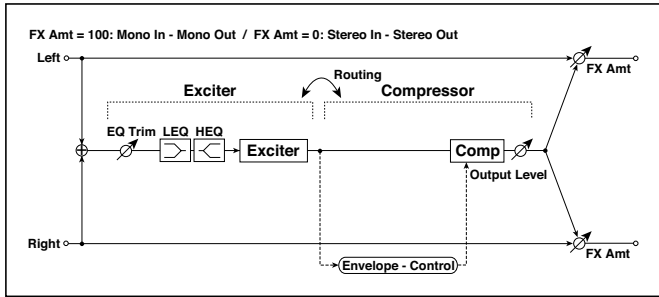

EXCITER			
a	[X]Exciter Blend	-100...+100	Sets the intensity (depth) of the Exciter effect
b	[X]Emphasis Frequency	0...70	Sets the frequency range to be emphasized
c	[X]EQ Trim	0...100	Sets the EQ input level
d	[X]Pre LEQ Gain [dB]	-15...+15	Sets the gain of Low EQ
	Pre HEQ Gain [dB]	-15...+15	Sets the gain of High EQ
COMPRESSOR			
e	[C] Sensitivity	1...100	Sets the sensitivity
f	[C]Attack	1...100	Sets the attack level
	Output Level	0...100	Sets the compressor output level
g	Routing	Exciter > Comp, Comp > Exciter	Switches the order of the exciter and compressor
h	Wet/Dry	Dry, 1:99...99:1, Wet	Balance between the wet and dry signal
	Src	Off...Tempo	See DMS (Dynamic Modulation Source)
	Amt	-100...+100	Amount of modulation source

Exciter - Limiter

This effect combines a mono exciter and a limiter. You can change the order of the effects.

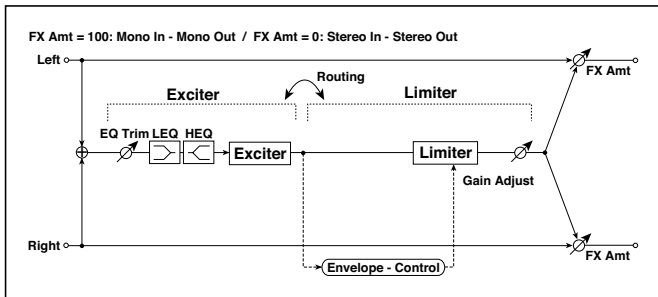

EXCITER			
a	[X]Exciter Blend	-100...+100	Sets the intensity (depth) of the Exciter effect
b	[X]Emphasis Frequency	0...70	Sets the frequency range to be emphasized
c	[X]Trim	0...100	Sets the EQ input level
d	[X]Pre LEQ Gain [dB]	-15...+15	Sets the gain of Low EQ
	Pre HEQ Gain [dB]	-15...+15	Sets the gain of High EQ
LIMITER			
e	[L]Ratio	1.0 : 1... 50.0 : 1, Inf : 1	Sets the signal compression ratio
f	[L]Threshold [dB]	-40...0	Sets the level above which the compressor is applied
g	[L]Attack	1...100	Sets the attack time
	Release	1...100	Sets the release time
h	[L]Gain Adjust [dB]	-Inf, -38...+24	Sets the limiter output gain
i	Routing	Exciter > Limiter, Limiter > Exciter	Switches the order of the exciter and limiter
j	Wet/Dry	Dry, 1:99...99:1, Wet	Balance between the wet and dry signal
	Src	Off...Tempo	See DMS (Dynamic Modulation Source)
	Amt	-100...+100	Amount of modulation source

Exciter - Cho/Flng (Exciter - Chorus/Flanger)

This effect combines a mono limiter and a chorus/flanger.

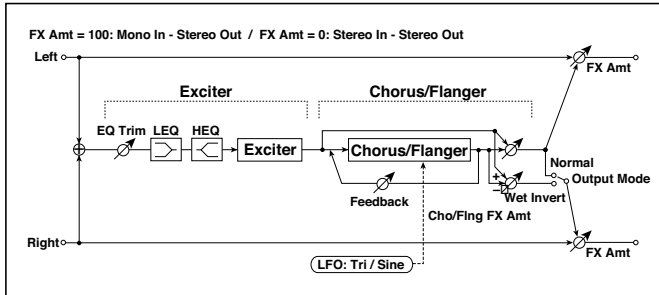

EXCITER			
a	[X]Exciter Blend	-100...+100	Sets the intensity (depth) of the Exciter effect
b	[X]Emphasis Frequency	0...70	Sets the frequency range to be emphasized
c	[X]Trim	0...100	Sets the EQ input level
d	[X]Pre LEQ Gain [dB]	-15...+15	Sets the gain of Low EQ
	Pre HEQ Gain [dB]	-15...+15	Sets the gain of High EQ
CHORUS/FLANGER			
e	[F]LFO Frequency [Hz]	0.02...20.00	Sets the speed of the LFO
	LFO Waveform	Triangle, Sine	Selects the LFO Waveform
f	[F]Delay Time [msec]	0.0...1350.0	Sets the delay time
	Depth	0...100	Sets the depth of LFO modulation
	Feedback	-100...+100	Sets the feedback amount
g	[F]Cho/Flng Wet/Dry	-Wet, -1:99... Dry...99:1, Wet	Sets the effect balance of the chorus/flanger
	Src	Off...Tempo	Selects the Wet/Dry modulation source for the chorus/flanger
	Amt	-100...+100	Sets the Wet/Dry modulation amount for the chorus/flanger
h	[F]Output Mode	Normal, Wet Invert	Selects the output mode for the chorus/flanger

i	Wet/Dry	Dry, 1:99...99:1, Wet	Balance between the wet and dry signal	
	Src	Off...Tempo	See DMS (Dynamic Modulation Source)	
	Amt	-100...+100	Amount of modulation source	

Exciter - Phaser

This effect combines a mono limiter and a phaser.

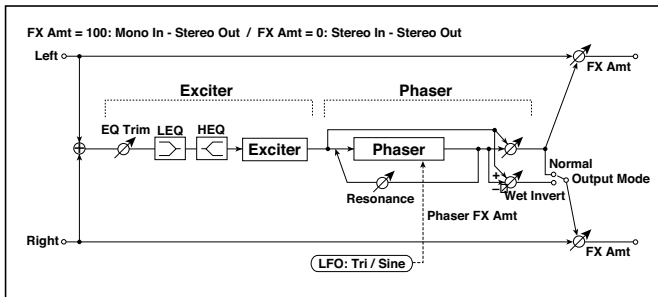

EXCITER

a	[X]Exciter Blend	-100...+100	Sets the intensity (depth) of the Exciter effect	
b	[X]Emphasis Frequency	0...70	Sets the frequency range to be emphasized	
c	[X]Trim	0...100	Sets the EQ input level	
d	[X]Pre LEQ Gain [dB]	-15...+15	Sets the gain of Low EQ	
	Pre HEQ Gain [dB]	-15...+15	Sets the gain of High EQ	

PHASER

e	[P]LFO Frequency [Hz]	0.02...20.00	Sets the speed of the LFO	
	LFO Waveform	Triangle, Sine	Selects the LFO Waveform	
f	[P]Manual	0...100	Sets the frequency to which the effect is applied	
	Depth	0...100	Sets the depth of LFO modulation	
	Resonance	-100...+100	Sets the resonance amount	

g	[P]Phaser Wet/Dry	-Wet, -1:99... Dry...99:1, Wet	Sets the phaser effect balance
	Src	Off...Tempo	Selects the Wet/Dry modulation source for the phaser
	Amt	-100...+100	Sets the Wet/Dry modulation amount for the phaser
h	[P]Output Mode	Normal, Wet Invert	Selects the phaser output mode
i	Wet/Dry	Dry, 1:99...99:1, Wet	Balance between the wet and dry signal
	Src	Off...Tempo	See DMS (Dynamic Modulation Source)
	Amt	-100...+100	Amount of modulation source

Exciter - Mt.Delay (Exciter - Multitap Delay)

This effect combines a mono exciter and a multitap delay.

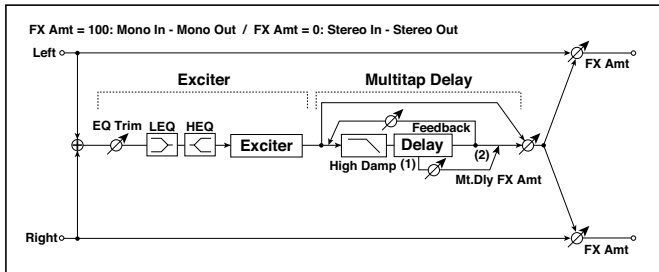

EXCITER			
a	[X]Exciter Blend	-100...+100	Sets the intensity (depth) of the Exciter effect
b	[X]Emphasis Frequency	0...70	Sets the frequency range to be emphasized
c	[X]Trim	0...100	Sets the EQ input level
d	[X]Pre LEQ Gain [dB]	-15...+15	Sets the gain of Low EQ
	Pre HEQ Gain [dB]	-15...+15	Sets the gain of High EQ
MULTITAP DELAY			
e	[D]Tap1 Time [msec]	0.0...1360.0	Sets the Tap1 delay time
	Tap1 Level	0...100	Sets the Tap1 output level

f	[D]Tap2 Time [msec]	0.0...1360.0	Sets the Tap2 delay time	
	Feedback (Tap2)	-100...+100	Sets the Tap2 feedback amount	
g	[D]High Damp [%]	0...100	Sets the damping amount in the high range	
	h	[D]Mt.Delay Wet/Dry	Dry, 1:99...99:1, Wet	Sets the multitap delay effect balance
	Src	Off...Tempo	Selects the Wet/Dry modulation source for the multitap delay	
i	Amt	-100...+100	Sets the Wet/Dry modulation amount for the multitap delay	
	Wet/Dry	Dry, 1:99...99:1, Wet	Balance between the wet and dry signal	
	Src	Off...Tempo	See DMS (Dynamic Modulation Source)	
	Amt	-100...+100	Amount of modulation source	

OD/HG - Cho/Fling (Overdrive/Hi.Gain - Chorus/Flanger)

This effect combines a mono overdrive/high-gain distortion and a chorus/flanger. You can change the order of the effects.

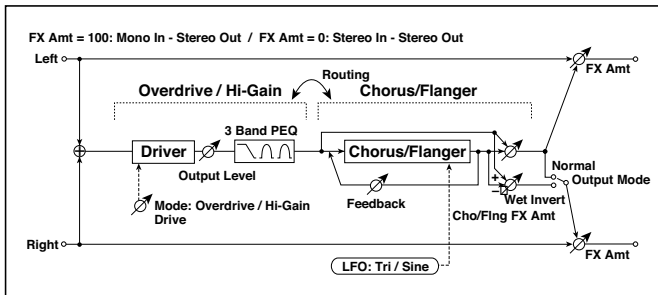

OD/HI-GAIN

a	[O]Drive Mode	Overdrive, Hi-Gain	Switches between overdrive and high-gain distortion	
	Drive	1...100	Sets the degree of distortion	

b	[O]Output Level	0...50	Sets the overdrive output level
	Src	Off...Tempo	Selects the modulation source for the overdrive output level
	Amt	-50...+50	Sets the modulation amount of the overdrive output level
e	[O]Low Cutoff [Hz]	20...1.00k	Sets the center frequency for Low EQ (shelving type)
	Gain [dB]	-18...+18	Sets the gain of Low EQ
f	[O]Mid1 Cutoff [Hz]	300...10.00k	Sets the center frequency for Mid/High EQ 1 (peaking type)
	Q	0.5...10.0	Sets the band width of Mid/High EQ 1
	Gain [dB]	-18...+18	Sets the gain of Mid/High EQ 1
g	[O]Mid2 Cutoff [Hz]	500...20.00k	Sets the center frequency for Mid/High EQ 2 (peaking type)
	Q	0.5...10.0	Sets the band width of Mid/High EQ 2
	Gain [dB]	-18...+18	Sets the gain of Mid/High EQ 2
CHORUS/FLANGER			
h	[F]LFO Frequency [Hz]	0.02...20.00	Sets the speed of the LFO
	LFO Waveform	Triangle, Sine	Selects the LFO Waveform
i	[F]Delay Time [msec]	0.0...1350.0	Sets the delay time
	Depth	0...100	Sets the depth of LFO modulation
	Feedback	-100...+100	Sets the feedback amount
j	[F]Cho/Flng Wet/Dry	-Wet, -1:99... Dry...99:1, Wet	Sets the effect balance of the chorus/flanger
	Src	Off...Tempo	Selects the Wet/Dry modulation source for the chorus/flanger
	Amt	-100...+100	Sets the Wet/Dry modulation amount for the chorus/flanger
k	[F]Output Mode	Normal, Wet Invert	Selects the output mode for the chorus/flanger
	Routing	OD/HG > Flanger, Flanger > OD/HG	Switches the order of the overdrive and chorus / flanger
l	Wet/Dry	Dry, 1:99...99:1, Wet	Balance between the wet and dry signal
	Src	Off...Tempo	See DMS (Dynamic Modulation Source)
	Amt	-100...+100	Amount of modulation source

OD/HG - Phaser (Overdrive/Hi.Gain - Phaser)

This effect combines a mono overdrive/high-gain distortion and a phaser. You can change the order of the effects.

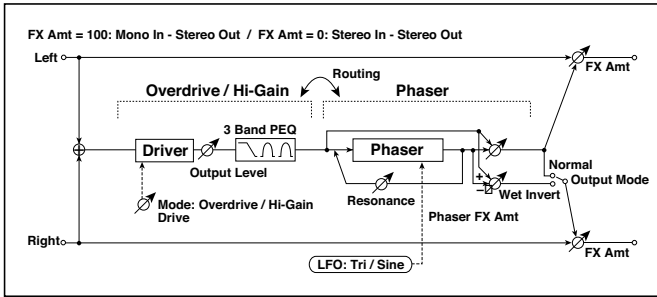

OD/HI-GAIN			
a	[O]Drive Mode	Overdrive, Hi-Gain	Switches between overdrive and high-gain distortion
	Drive	1...100	Sets the degree of distortion
b	[O]Output Level	0...50	Sets the overdrive output level
	Src	Off...Tempo	Selects the modulation source for the overdrive output level
	Amt	-50...+50	Sets the modulation amount of the overdrive output level
e	[O]Low Cutoff [Hz]	20...1.00k	Sets the center frequency for Low EQ (shelving type)
	Gain [dB]	-18...+18	Sets the gain of Low EQ
f	[O]Mid1 Cutoff [Hz]	300...10.00k	Sets the center frequency for Mid/High EQ 1 (peaking type)
	Q	0.5...10.0	Sets the band width of Mid/High EQ 1
	Gain [dB]	-18...+18	Sets the gain of Mid/High EQ 1
g	[O]Mid2 Cutoff [Hz]	500...20.00k	Sets the center frequency for Mid/High EQ 2 (peaking type)
	Q	0.5...10.0	Sets the band width of Mid/High EQ 2
	Gain [dB]	-18...+18	Sets the gain of Mid/High EQ 2
PHASER			
h	[P]LFO Frequency [Hz]	0.02...20.00	Sets the speed of the LFO
	LFO Waveform	Triangle, Sine	Selects the LFO Waveform

i	[P]Manual	0...100	Sets the frequency to which the effect is applied
	Depth	0...100	Sets the depth of LFO modulation
	Resonance	-100...+100	Sets the resonance amount
j	[P]Phaser Wet/Dry	-Wet, -1:99... Dry...99:1, Wet	Sets the phaser effect balance
	Src	Off...Tempo	Selects the Wet/Dry modulation source for the phaser
	Amt	-100...+100	Sets the Wet/Dry modulation amount for the phaser
k	[P]Output Mode	Normal, Wet Invert	Selects the phaser output mode
	Routing	OD/HG > Phaser, Phaser > OD/HG	Switches the order of the overdrive and phaser
l	Wet/Dry	Dry, 1:99...99:1, Wet	Balance between the wet and dry signal
	Src	Off...Tempo	See DMS (Dynamic Modulation Source)
	Amt	-100...+100	Amount of modulation source

OD/HG - Mt.Delay (Overdrive/Hi.Gain - Multitap Delay)

This effect combines a mono overdrive/high-gain distortion and a multitap delay.

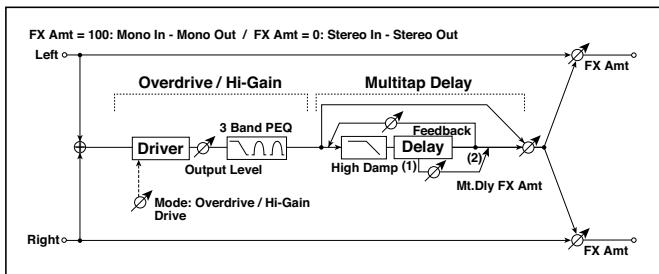

OD/HI-GAIN			
a	[O]Drive Mode	Overdrive, Hi-Gain	Switches between overdrive and high-gain distortion
	Drive	1...100	Sets the degree of distortion

b	[O]Output Level	0...50	Sets the overdrive output level	
	Src	Off...Tempo	Selects the modulation source for the overdrive output level	
	Amt	-50...+50	Sets the modulation amount of the overdrive output level	
e	[O]Low Cutoff [Hz]	20...1.00k	Sets the center frequency for Low EQ (shelving type)	
	Gain [dB]	-18...+18	Sets the gain of Low EQ	
f	[O]Mid1 Cutoff [Hz]	300...10.00k	Sets the center frequency for Mid/High EQ 1 (peaking type)	
	Q	0.5...10.0	Sets the band width of Mid/High EQ 1	
	Gain [dB]	-18...+18	Sets the gain of Mid/High EQ 1	
g	[O]Mid2 Cutoff [Hz]	500...20.00k	Sets the center frequency for Mid/High EQ 2 (peaking type)	
	Q	0.5...10.0	Sets the band width of Mid/High EQ 2	
	Gain [dB]	-18...+18	Sets the gain of Mid/High EQ 2	
MULTITAP DELAY				
h	[D]Tap1 Time [msec]	0.0...1360.0	Sets the Tap1 delay time	
	Tap1 Level	0...100	Sets the Tap1 output level	
i	[D]Tap2 Time [msec]	0.0...1360.0	Sets the Tap2 delay time	
	Feedback	-100...+100	Sets the Tap2 feedback amount	
j	[D]High Damp [%]	0...100	Sets the damping amount in the high range	
k	[D]Mt.Delay Wet/Dry	Dry, 1:99...99:1, Wet	Sets the multitap delay effect balance	
	Src	Off...Tempo	Selects the Wet/Dry modulation source for the multitap delay	
	Amt	-100...+100	Sets the Wet/Dry modulation amount for the multitap delay	
l	Wet/Dry	Dry, 1:99...99:1, Wet	Balance between the wet and dry signal	
	Src	Off...Tempo	See DMS (Dynamic Modulation Source)	
	Amt	-100...+100	Amount of modulation source	

Decimator - Comp (Decimator - Compressor)

This effect combines a mono decimator and a compressor. You can change the order of the effects.

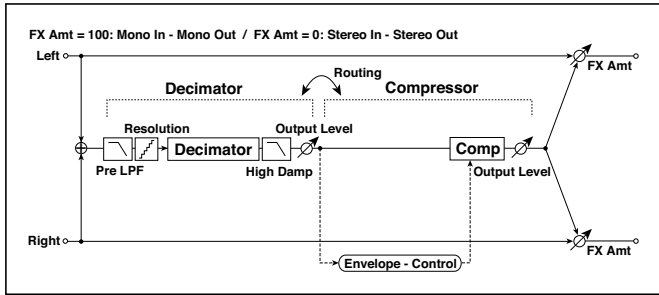

DECIMATOR			
a	[D]Pre LPF	Off, On	Turn the harmonic noise caused by lowered sampling on and off
	High Damp [%]	0...100	Sets the ratio of high-range damping
b	[D]Sampling Freq [Hz]	1.00k...48.00k	Sets the sampling frequency
	Resolution	4...24	Sets the data bit length
c	[D]Output Level	0...100	Sets the decimator output level
COMPRESSOR			
d	[C] Sensitivity	1...100	Sets the sensitivity
e	[C]Attack	1...100	Sets the attack level
	Output Level	0...100	Sets the compressor output level
f	Routing	Decimator > Comp, Comp > Decimator	Switches the order of the decimator and compressor
g	Wet/Dry	Dry, 1:99...99:1, Wet	Balance between the wet and dry signal
	Src	Off...Tempo	See DMS (Dynamic Modulation Source)
	Amt	-100...+100	Amount of modulation source

Cho/Flng - Mt.Dly (Chorus/Flanger - Multitap Delay)

This effect combines a mono chorus/flanger and a multitap delay.

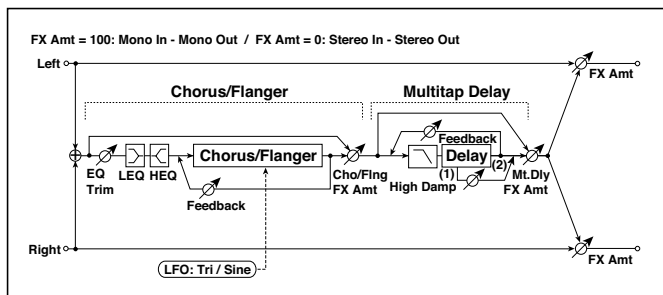

CHORUS/FLANGER

a	[F]LFO Frequency [Hz]	0.02...20.00	Sets the speed of the LFO
	LFO Waveform	Triangle, Sine	Selects the LFO Waveform
b	[F]Delay Time [msec]	0.0...1350.0	Sets the delay time
	Depth	0...100	Sets the depth of LFO modulation
	Feedback	-100...+100	Sets the feedback amount
c	[F]EQ Trim	0...100	Sets the EQ input level
d	[F]PreLEQ Gain [dB]	-15...+15	Sets the gain of Low EQ
	PreHEQ Gain [dB]	-15...+15	Sets the gain of High EQ
e	[F]Cho/Flng Wet/Dry	-Wet...-1 : 99, Dry, 1 : 99...Wet	Sets the effect balance of the chorus/flanger

MULTITAP DELAY

f	[D]Tap1 Time [msec]	0.0...1360.0	Sets the Tap1 delay time
	Tap1 Level	0...100	Sets the Tap1 output level
g	[D]Tap2 Time [msec]	0.0...1360.0	Sets the Tap2 delay time
	Feedback	-100...+100	Sets the Tap2 feedback amount
h	[D]High Damp [%]	0...100	Sets the damping amount in the high range

i	[D]Mt.DelayWet/Dry	Dry, 1:99...99:1, Wet	Sets the multitap delay effect balance
	Src	Off...Tempo	Selects the Wet/Dry modulation source for the multitap delay
	Amt	-100...+100	Sets the Wet/Dry modulation amount for the multitap delay
j	Wet/Dry	Dry, 1:99...99:1, Wet	Balance between the wet and dry signal
	Src	Off...Tempo	See DMS (Dynamic Modulation Source)
	Amt	-100...+100	Amount of modulation source

Multitap Cho/Delay (Multitap Chorus/Delay)

This effect has six chorus blocks with different LFO phases. You can produce a complex stereo image by setting a different delay time and depth for each block. You can control the delay output level via a modulation source.

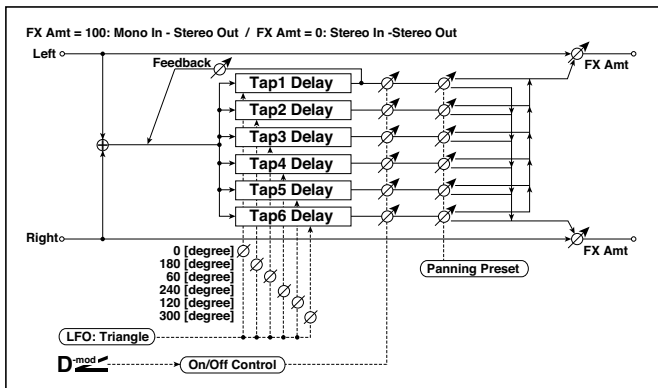

a	LFO Frequency [Hz]	0.02...13.00	Sets the speed of the LFO
b	Tap1 (000) [msec]	0...2000	Sets the Tap1 (LFO phase=0 degrees) delay time
	Depth	0...30	Sets the Tap1 chorus depth
	Status	Always On, Always Off, On>Off (Dm), Off>On (Dm)	Selects on, off, or modulation source for the control of Tap1 output

c	Tap2 (180) [msec]	0...2000	Sets the Tap2 (LFO phase=180 degrees) delay time
	Depth	0...30	Sets the Tap2 chorus depth
	Status	Always On, Always Off, On>Off (Dm), Off>On (Dm)	Selects on, off, or modulation source for the control of Tap2 output
d	Tap3 (060) [msec]	0...2000	Sets the Tap3 (LFO phase=60 degrees) delay time
	Depth	0...30	Sets the Tap3 chorus depth
	Status	Always On, Always Off, On>Off (Dm), Off>On (Dm)	Selects on, off, or modulation source for the control of Tap3 output
e	Tap4 (240) [msec]	0...2000	Sets the Tap4 (LFO phase=240 degrees) delay time
	Depth	0...30	Sets the Tap4 chorus depth
	Status	Always On, Always Off, On>Off (Dm), Off>On (Dm)	Selects on, off, or modulation source for the control of Tap4 output
f	Tap5 (120) [msec]	0...2000	Sets the Tap5 (LFO phase=120 degrees) delay time
	Depth	0...30	Sets the Tap5 chorus depth
	Status	Always On, Always Off, On>Off (Dm), Off>On (Dm)	Selects on, off, or modulation source for the control of Tap5 output
g	Tap6 (300) [msec]	0...2000	Sets the Tap1 (LFO phase=300 degrees) delay time
	Depth	0...30	Sets the Tap6 chorus depth
	Status	Always On, Always Off, On>Off (Dm), Off>On (Dm)	Selects on, off, or modulation source for the control of Tap6 output
h	Panning Preset	1 : L 1 2 3 4 5 6 R, 2 : L 135 246 R, 3 : L 13 5 2 4 6 R, 4 : L 14 5 6 3 2 R	Selects the stereo panning pattern for each tap

i	Tap1 Feedback	-100...+100	Sets the Tap1 feedback amount
	Src	Off...Tempo	Selects the modulation source for the Tap output level, feedback amount, and effect balance
	Amt	-100...+100	Sets the modulation amount of Tap1 feedback amount
j	Wet/Dry	Dry, 1:99...99:1, Wet	Balance between the wet and dry signal
	Src	Off...Tempo	See DMS (Dynamic Modulation Source)
	Amt	-100...+100	Amount of modulation source

b, c, d, e, f, g: Status

These parameters set the output status of each Tap.

Always On: Output is always on. (No modulation)

Always Off: Output is always off. (No modulation)

On/Off (dm): Output level is switched from on to off depending on the modulation source.

Off/On (dm): Output level is switched from off to on depending on the modulation source.

Combining these parameters, you can change from 4-phase chorus to two-tap delay by crossfading them gradually via the modulation source during a performance.

h: Panning Preset

This parameter selects combinations of stereo images of the tap outputs.

PianoBody/Damper (PianoBody/Damper Simulation)

This effect simulates the resonance of the piano sound board caused by the string vibration, and also simulates the resonance of other strings that are not being played when you press the damper pedal. It will create a very realistic sound when applied to acoustic piano sounds.

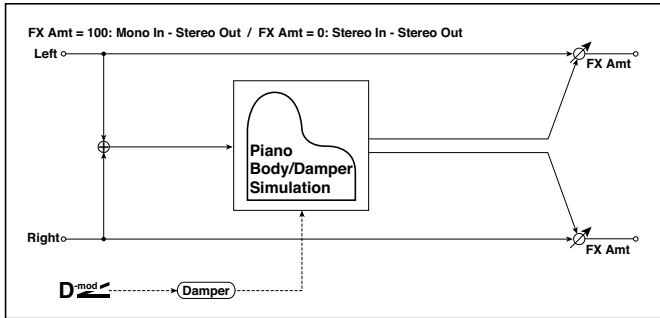

a	Sound Board Depth	0...100	Sets the intensity of resonance of the sound board
b	Damper Depth	0...100	Sets the intensity of the string resonance created when the damper pedal is pressed
	Src	Off...Tempo	Selects the modulation source of damper effect
c	Tone	1...100	Sets tonal quality of effect sound
d	Mid Shape	0...36	Sets the mid range of tonal quality
e	Tune	-50...+50	Fine tuning
f	Wet/Dry	Dry, 1:99...99:1, Wet	Balance between the wet and dry signal
	Src	Off...Tempo	See DMS (Dynamic Modulation Source)
	Amt	-100...+100	Amount of modulation source

a: Sound Board Depth

This parameter sets the intensity of resonance of the piano sound board.

b: Damper Depth**b: Src**

This parameter sets the resonance intensity of the other strings created when the damper pedal is pressed. The “Src” parameter selects the modulation source from which the damper effect is applied. Usually, select Damper #64 Pdl (Damper pedal).

MIDI The effect is off when a value for the modulation source specified for the “Src” parameter is 63 or smaller, and the effect is on when the value is 64 or higher.

c: Tone**d: Mid Shape**

These parameters control the tonal quality of the effect sound.

e: Tune

Since this effect simulates the resonance of the strings, the sound varies depending on the pitch. If you have changed tuning using the “Master Tuning” (Global > General Controls > Basic), adjust this parameter value.

DMS (Dynamic Modulation Sources)

When the Src or DMS abbreviation, or the  symbol is shown, a Dynamic Modulation can be applied to the corresponding parameter. Dynamic Modulation allows for realtime control of the effect. The following table shows the available modulation sources.

DMS	Note
Off	No modulation
Gate1	
Gate1+Dmpr	
Gate2	
Gate2+Dmpr	
Note Nr	Note Number
Velocity	Note Velocity
Expo Velocity	Exponential Note Velocity
AfterTouch	After Touch
JS X	Joystick Left/Right
JS+Y: CC#01	Joystick Forward
JS-Y: CC#02	Joystick Backward
MIDI(CC#04)	
MIDI(CC#12)	FX MIDI Controller 1
MIDI(CC#13)	FX MIDI Controller 2
Ribb.(CC#16)	Ribbon Controller
MIDI(CC#18)	
MIDI(CC#17)	
MIDI(CC#19)	

DMS	Note
MIDI(CC#20)	
MIDI(CC#21)	
MIDI(CC#17+)	
MIDI(CC#19+)	
MIDI(CC#20+)	
MIDI(CC#21+)	
Damper: #64	
Prta.SW: #65	Portamento Switch
Sostenu: #66	Sostenuto Pedal
MIDI(CC#67)	
MIDI(CC#80)	
MIDI(CC#81)	
MIDI(CC#82)	
MIDI(CC#83)	
MIDI(CC#85)	
MIDI(CC#86)	
MIDI(CC#87)	
MIDI(CC#88)	
Tempo	

Some notes on the Gate parameters follow.

Gate1, Gate1+Dmpr (Gate1+Damper)

The effect is at maximum during note-on, and will stop when all keys are released. With **Gate1 + Dmpr**, the effect will remain at maximum even after the keys are released, as long as the damper (sustain) pedal is pressed.

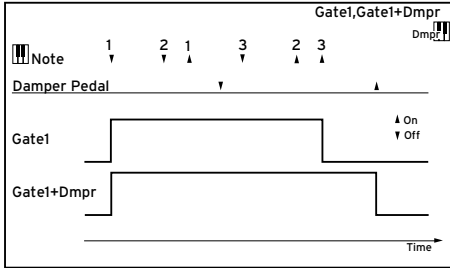

Gate2, Gate2+Dmpr (Gate2+Damper)

This is essentially the same as for Gate 1 or Gate 1 + Dmpr. However when **Gate 2** or **Gate 2 + Dmpr** are used as a dynamic modulation source for the EG, a trigger will occur at each note-on. (In the case of Gate 1 and Gate 1 + Dmpr, the trigger occurs only for the first note-on.)

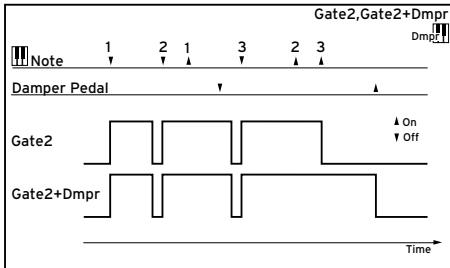

PART X: KAOSS EFFECTS

45 Using the KAOSS effects

The KAOSS page

What are the KAOSS effects?

KAOSS is a KORG technology, allowing for live generation of MIDI events and simultaneous control of multiple parameters via a control surface. In Pa4X, it lets you transform the music flow, or do creative and interactive 'liquid mixing'.

For example, you can smoothly morph between Variations and Drum Kit types, to create an evolving and always renewed arrangement. You can let KAOSS help you improvise on pre-recorded music, by reshaping rhythm, pitch inversion or changing note density. You can make the mix sparser, to leave a solo player be heard better or let you interact with your audience.

There are also DJ-style note-crunching effects, for more radical changes. And you can use the KAOSS as a sophisticated arpeggiator, or an old tape delay machine.

You can choose between several preset KAOSS effects. You will then control the effects' parameters on an XY surface, called the KAOSS pad.

Going to the KAOSS page

You can go to the KAOSS page by touching the KAOSS tab in the main page of the Style Play or Song Play mode.

- In Style Play mode:

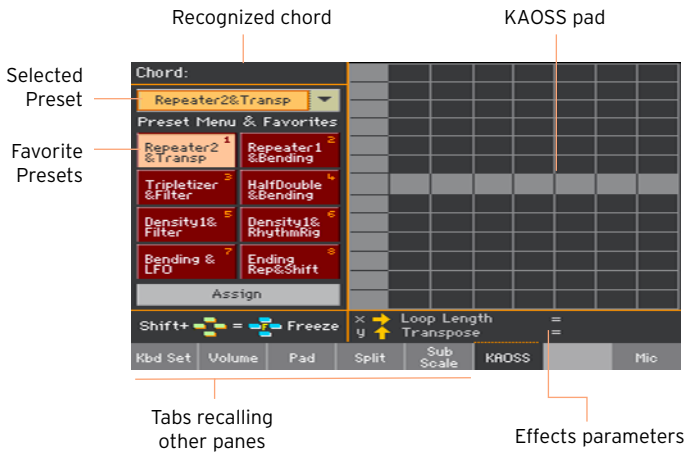

- In Song Play mode:

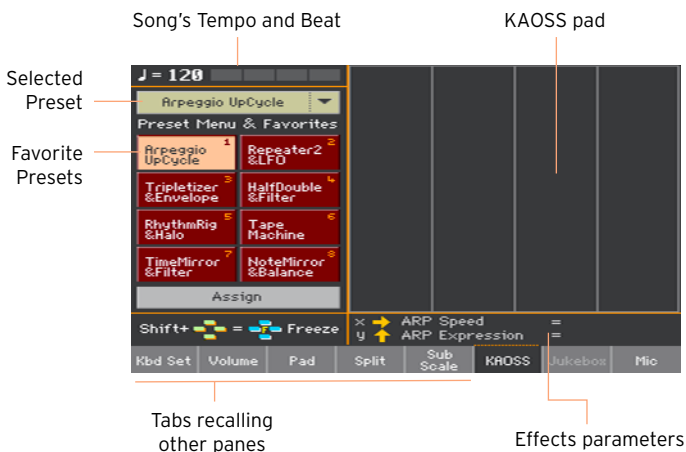

When you leave this page, the KAOSS is automatically stopped.

Choosing the KAOSS Presets

Choosing a KAOSS Preset or Favorite Presets

A series of KAOSS Presets is already supplied with the instrument. You can choose a separate KAOSS Preset for the Style Play and the Song Play mode.

Choose a KAOSS Preset from the library

- Use the pop-up menu in the top left corner of the page to choose one of the presets from the library containing all the presets.

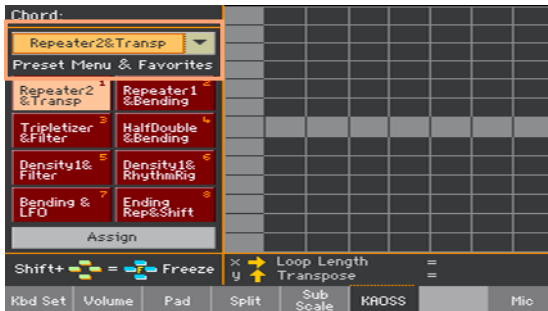

Choose a KAOSS Favorite Presets from the dedicated buttons

- Touch one of the Favorite Presets to choose the corresponding preset.



The selected presets for each mode will remain selected.

Assigning a KAOSS Preset to one of the Favorite Preset buttons

You can assign any of the presets from the library to one of the Favorite Preset buttons. This way, you will have a set of favorite presets always ready.

The Favorites can be different for the Style Play and Song Play mode.

- 1 Choose one of the KAOSS Presets by using the pop-up menu in the top left corner of the page.
- 2 Touch the Assign button under the Favorite Preset buttons.
- 3 When the Select Destination dialog appears, touch one of the buttons to choose a destination.



KAOSS Preset list

The following table contains all the Factory KAOSS Presets. Some of the presets can be chosen both in Style Play and Song Play mode. Some can only be chosen in Style Play mode.

Please note that time-based effects can require a few moments, before starting to work.

Preset for the Style Play and Song Play modes

KAOSS Preset	X-Axis	Y-Axis	Works on
Repeater1&Filter	Loop Length	Cutoff&Resonance	Style, Song Tracks
Repeater1&Bending	Loop Length	Bending&Cutoff	
Repeater2&LFO	Loop Length	LFO Depth	
Repeater2&Transpose	Loop Length	Transpose	
Repeater Filt&Trps	Cutoff&Resonance	Transpose	
Repeater Halo&Bend	FX&Release	Bending&Cutoff	
Repeater Filt&Tape	Cutoff&Resonance	Tape Speed	
Ending Rep&Shift	Loop Length	Note Shift	
Ending Rep&LFO	Loop Length	LFO Depth	
Ending Halo&Bend	FX&Release	Bending&Cutoff	
Tape Machine	BPM	Bending	
Tape & Filter	Tape Speed	Cutoff&Resonance	
Tape & Balance	Tape Speed	D&B Balance	
Bending & LFO	Bending	LFO Depth	
Delay & Balance	Delay Length	D&B Balance	
Delay & LFO	Delay Length	LFO Depth	
Tripletizer&Filter	Tripletizer	Cutoff&Resonance	
Tripletizer&Envelope	Tripletizer	Attack&Decay	
Tripletizer&Balance	Tripletizer	D&B Balance	
RhythmRig&Halo	Rig Set	FX&Release	
RhythmRig&Balance	Rig Set	D&B Balance	
TimeMirror&Envelope	Time Mirror	Attack&Decay	
TimeMirror&Filter	Time Mirror	Cutoff&Resonance	

KAOSS Preset	X-Axis	Y-Axis	Works on
HalfDouble&Bending	D&B Speed	Attack&Decay	Style, Song Tracks
HalfDouble&Halo	D&B Speed	FX&Release	
HalfDouble&Filter	D&B Speed	Cutoff&Resonance	
RhytSpeed&Balance	D&B Speed	D&B Balance	
DrumDecim&Filter	Drum Decimator	Cutoff&Resonance	
DrumDecim&Envelope	Drum Decimator	Attack&Decay	
Decimator&Halo	Decimator	FX&Release	
Decimator&Balance	Decimator	D&B Balance	
Decimator&Transp	Decimator	Transpose	
NoteMirror&Transp	Mirror Note	Transpose	
NoteMirror&Balance	Mirror Note	D&B Balance	
Arpeggio 2/Beat	ARP Shape	ARP Expression	Upper Sounds
Arpeggio 3/Beat	ARP Shape	ARP Expression	
Arpeggio 4/Beat	ARP Shape	ARP Expression	
Arpeggio 6/Beat	ARP Shape	ARP Expression	
Arpeggio UpCycle	ARP Speed	ARP Expression	
Arpeggio DownCycle	ARP Speed	ARP Expression	
Arpeggio UpOneBeat	ARP Speed	ARP Expression	
Arpeggio Random	ARP Speed	ARP Expression	
Arpeggio WeirdShift	ARP Shift	ARP Expression	

Preset for the Style Play only

KAOSS Preset	X-Axis	Y-Axis	Works on
Density1&Filter	Density	Cutoff&Resonance	Style Tracks
Density1&RhythmRig	Density	Rig Set	
Density1&HalfDouble	Density	D&B Speed	
Density2&DrumDecim	Density	Drum Decimator	
Density2&Halo	Density	FX&Release	
Density2&Repeater2	Density	Loop Length	
Density3&Filter	Density	Cutoff&Resonance	
Density3&Balance	Density	D&B Balance	
Density4&Halo	Density	FX&Release	
Ending Den1&Rep	Density	Loop Length	
Repeater Den1&Bend	Density	Bending&Cutoff	
Var & DrumDecim	Variation	Drum Decimator	
Var & HalfDouble	Variation	D&B Speed	
Var & Mute1	Variation	Muting	
Var & Mute2	Variation	Muting	
VarPad1 & DrumDecim	Variation&Pad	Drum Decimator	
VarPad1 & Mute1	Variation&Pad	Muting	
VarPad2 & Decimator	Variation&Pad	Decimator	
Double Var&Balan	Variation	D&B Balance	
Half Var&Halo	Variation	FX&Release	
DrumDecim&Mute1	Drum Decimator	Muting	
Decimator&Mute2	Decimator	Muting	
RhythmRig&Mute1	Rig Set	Muting	
RhythmRig&Mute2	Rig Set	Muting	

Using the KAOSS effects

Using the KAOSS effects is just a matter of letting the instrument play, or playing some notes, and swiping your finger in the KAOSS pad area to change the music flow.

Starting the original music flow

Transformation vs. Arpeggiator

There are two general categories of KAOSS effects:

- Transformation effects, where the music flow generated by the Arranger or Player is processed to create new music.
- Arpeggiator effects, where the latest recognized chord, or the notes you play on the Upper part of the keyboard, are used to generate an arpeggio. The name of these presets begin with Arpeggio.

Choose the original music

- Go to the Style Play or Song Play mode, and either choose a Style or a MIDI Song.
- If you want to play an arpeggio, choose a Keyboard Set including the Sounds you want to arpeggiate.

Choose a KAOSS preset

- Choose a KAOSS Preset or Favorite Preset, as seen above.
- If you want to play an arpeggio, choose a preset whose name begins with Arpeggio.

Start the Accompaniment or the Song

- Depending on whether you are in Style Play or Song Play mode, start the Accompaniment or the Song as usual.
- If you are using an Arpeggiator preset, play a chord or some notes on the Upper part of the keyboard and touch the pad. You do not need to start the Accompaniment or Song.

Using the KAOSS pad

Check the effect's parameters assigned to the X/Y axis

- See the name of the parameters under the pad.



Axis	Meaning
X	Finger movement from left to right, right to left.
Y	Finger movement from top to bottom, bottom to top.

Change the parameters' value

- To change the parameters' value, move your finger in the KAOSS pad.



Depending on the selected preset, the grid in the KAOSS pad will change. Each cell corresponds to a block of values (also called a step). The lighter grey cells are the default value for the corresponding parameter.

When no grid lines appear in the pad, values are continual, without intermediate steps, changing with a finer detail.

- When you release your finger, the default values are reset.

Freeze the current values

Do one of the following:

- Keep the **SHIFT** button pressed, and touch an **area** of the KAOSS pad, then release the **SHIFT** button and finally raise your finger.

You are free to continue moving your finger, or to release it to freeze the current values.

- Press the **SHIFT** button while the finger is touching the KAOSS pad, then raise your finger and finally release the **SHIFT** button.

The values of the latest position of your finger will be frozen. The processed music flow will go on by following those values.

Using the Damper pedal to hold notes

When you are using an Arpeggio preset, pressing down the Damper pedal will not sustain the generated notes, but will hold the notes or chord you played. You are free, therefore, to lift your hand from the keyboard, and let the arpeggiator go on.

PART XI: CONTROLLERS

46 Hand controllers

Programming the joystick

Assigning functions to the joystick

The left/right (X-, X+) movement of the joystick usually controls Pitch Bend. It can however controls a Sound parameter, depending on the Sound programming.

The up/forward movement (Y+) is usually Modulation, and sometimes a different Sound parameter, depending on the Sound programming. The down/backward movement (Y-) can be assigned to various controls, or is left unused.

Assigning Sound parameters to the joystick can be done in Sound Edit.

Assigning the joystick to the Sounds

You can activate/deactivate the Joystick on each Keyboard Sound.

- 1 Go to the Keyboard/Ensemble > Joystick/Pedal page.

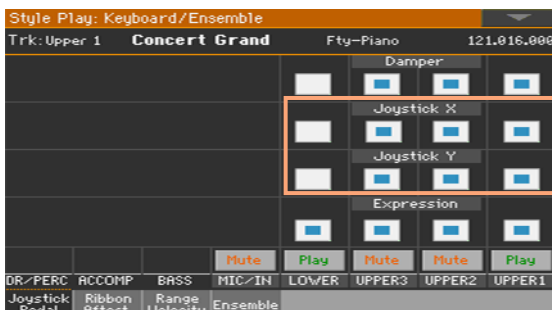

- 2 Use the Joystick X checkbox to turn the left/right Joystick movements on/off on each Sound.
- 3 Use the Joystick Y checkbox to turn the up/down Joystick movements on/off on each Sound.
- 4 Write the changes to a Keyboard Set.

Setting the Pitch Bend range

Pitch Bend range is defined for each Sound set, and can change with different Keyboard Sets, SongBook Entries or Styles.

- 1 Go to the Mixer/Tuning > Tuning page.
- 2 Use the Pitch Bend Sens(itivity) knobs to set the Pitch Bend range for each Sound.

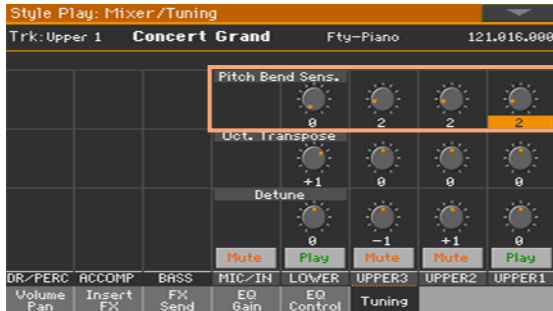

PB Sensitivity	Meaning
0	No pitch bend allowed.
1 ... 12	Maximum up/down pitch bend range (in semitones). 12 = ± 1 octave.

- 3 Write the changes to a Sound set (Keyboard Set, Style Settings).

Programming the keyboard's velocity and aftertouch

Assigning functions to velocity and aftertouch

Velocity usually controls the Sound's loudness, while aftertouch controls modulation. However, they can be assigned to other roles by each individual Sound. Assigning Sound parameters can be done in Sound Edit.

Assigning aftertouch to the Sounds

You can activate/deactivate aftertouch on each Keyboard Sound.

- 1 Go to the Keyboard/Ensemble > Ribbon/Aftertouch page.

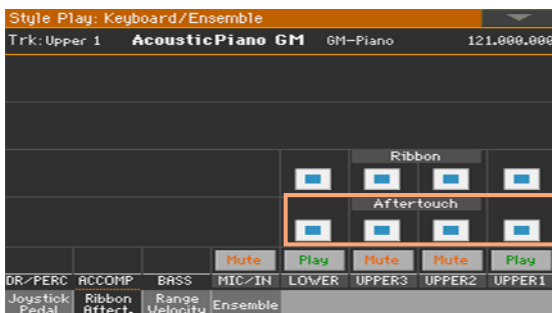

- 2 Use the Aftertouch checkbox to turn the aftertouch on/off on each Keyboard Sound.
- 3 Write the changes to a Keyboard Set.

Adjusting the velocity and aftertouch sensitivity

You can define how the keyboard responds to your striking velocity and aftertouch pressure.

- 1 Go to the Global > Controllers > Hand page.

- 2 Use the Velocity Curve parameter to set the sensitivity of the keyboard to your playing strength.

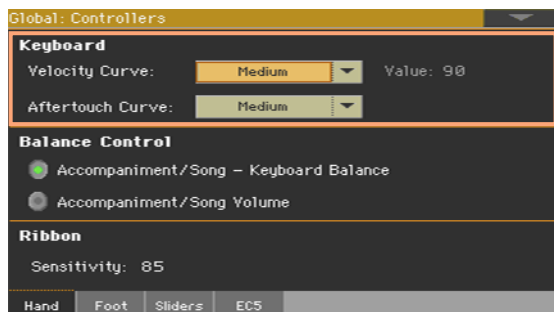

Velocity Curve	Meaning
Fixed	No dynamic control available. Dynamic values are fixed, as in classic organs. When this option is chosen, you can set the fixed velocity value.
Soft1 ... Hard3	Curves, from the lightest one to the hardest one.

- 3 Use the Aftertouch Curve parameter to set the sensitivity of the keyboard to the pressure you apply after playing a key.

A.Touch Curve	Meaning
Soft1 ... Hard3	Curves, from the lightest one to the hardest one.
Off	The aftertouch is turned off.

Programming the ribbon controller

Assigning functions to the ribbon controller

The function controlled by the ribbon depends on the selected Sounds. Assigning Sound parameters to the ribbon controller can be done in Sound Edit.

Assigning the ribbon controller to the Sounds

You can activate/deactivate the ribbon on each Keyboard Sound.

- 1 Go to the Keyboard/Ensemble > Ribbon/Aftertouch page.

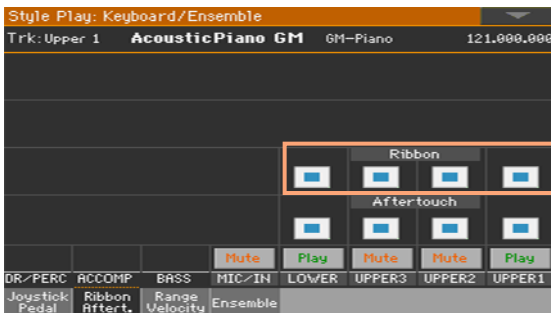

- 2 Use the Ribbon checkbox to turn the ribbon on/off on each Sound.
- 3 Write the changes to a Keyboard Set.

Adjusting the ribbon controller's sensitivity

You can define how sensitive is the ribbon controller to your finger's swipe.

- 1 Go to the Global > Controllers > Hand page.
- 2 Use the Ribbon > Sensitivity parameter to set the ribbon's response.

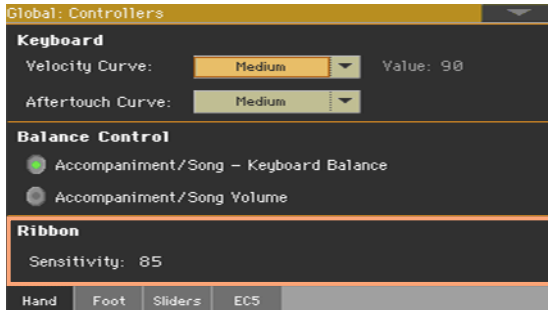

Programming the assignable sliders

How the sliders work depend on the status of the SLIDER MODE indicator. The status of this button is saved with each Keyboard Set, but can be freely changed by repeatedly pressing the button.

Choosing the slider mode

- 1 Use the SLIDER MODE button to select one of the slider modes.

Slider mode	Meaning
Volume	<p>Each of the sliders controls the volume of the corresponding Sound/part/track. Pressing the TRACK SELECT button will change the set, as shown by the labels around the sliders.</p> <p>Keep the SHIFT button pressed, and move one of the sliders to proportionally change the volume of all similar parts/tracks (for example, all the Upper parts or all of a Style's accompaniment tracks).</p> <p>Please note that this cannot work on MIDI Song tracks while in Song Play mode, since their volume is always controlled by the internal MIDI data.</p>
Drawbars	Each slider controls the corresponding drawbar of the selected Digital Drawbars Sound.
Assign. A/B	Two sets of eight freely assignable controls, that can be programmed in the Global > Controllers > Sliders page.

- 2 Write the changes to a Keyboard Set.

Programming the assignable sets

- 1 Go to the Global > Controllers > Sliders page.



- 2 Choose a function for each of the sliders.

There are two sets (Assignable A and Assignable B), that you can recall by selecting the corresponding slider mode.

Functions assignable to the sliders

Slider function	Meaning
Off	No function assigned
Master Volume	Master Volume control
Keyboard Expression	Relative Volume of the Keyboard Sounds. All the other Sounds will not be varied.
Style Drum&Perc.Vol.(Gbl)	The same as the Style Volume sliders in the Global > Mode Preferences > Styles 2 page.
Style Bass Vol.(Gbl)	
Style Accomp.Vol.(Gbl)	
Kbd Upper 1 Volume	Volume of the corresponding Keyboard Sound.
Kbd Upper 2 Volume	
Kbd Upper 3 Volume	
Kbd Lower Volume	
Pad Volume	Pads volume control
Pad 1...4 Volume	Volume of the corresponding Pad.
Style Drum Volume	Volume of the corresponding Style track.
Style Perc Volume	
Style Bass Volume	
Style Acc 1...5 Volume	

Slider function	Meaning	
Song Track 1...16 Volume	Volume of the corresponding MIDI Song track.	
SMF Melody Volume	Volume of the corresponding MIDI Song's special tracks (selected in the Global > Mode Preferences > Song & Seq page).	
SMF Drum&Bass Mode Vol.		
Joystick X+	Replicates the joystick right movement	
Joystick X-	Replicates the joystick left movement	
Joystick Y+	Replicates the joystick forward movement	
Joystick Y-	Replicates the joystick backward movement	
Upper VDF Cutoff	Filter cutoff (for Sounds assigned to the Upper tracks)	
Upper VDF Resonance	Filter resonance (for Sounds assigned to the Upper tracks)	
Mic Lead Voice Level	Continuous controls assigned to the Voice Processor	
Mic Harmony Level		
Mic Double Level		
Mic Filter Level		
Mic uMod Level		
Mic Delay Level		
Mic Reverb Level		
Mic EQ Gain Low		
Mic EQ Gain Mid		
Mic EQ Gain High		
FX CC12 Ctrl		Standard FX controllers, used as DMS modulations. How they work depends on the Effects programming.
FX CC13 Ctrl		

Programming the assignable switches

Assigning a function to the assignable switches

You can program the ASSIGNABLE SWITCHES in a different way for each Keyboard Set. Choosing a different set of Sounds may therefore change the controls assigned to these switches, to match the different types of Sounds.

- 1 Go to the Style Play/Song Play > Pad/Switch > Switch page.

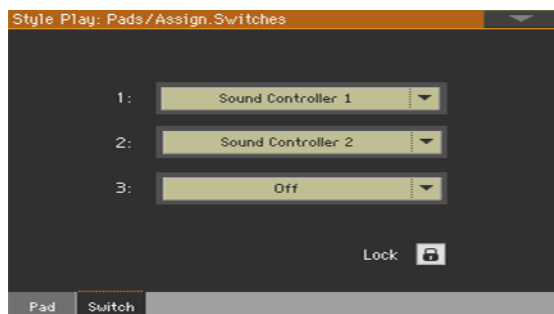

- 2 Use one of the Switch 1...3 menus to choose a command to be assigned to the corresponding switch.
- 3 Write the changes to a Keyboard Set.

Functions assignable to the assignable switches

Switch function	Meaning
Off	No function assigned
Ritardando	Slowing down or making the Tempo faster, according to the curves programmed in the Global > General Controls > Basic page.
Accelerando	
Style Up	Selects the next Style
Style Down	Selects the previous Style
Kbd Set Library Up	Selects the next Keyboard Set from the KEYBOARD SET LIBRARY
Kbd Set Library Down	Selects the previous Keyboard Set from the KEYBOARD SET LIBRARY
Sound Up	Selects the next Sound
Sound Down	Selects the previous Sound

Switch function	Meaning
Synchro Start	Same functions as the control panel buttons with the same name
Synchro Stop	
Style Drum Mute	Mute of the corresponding track
Style Perc Mute	
Style Bass Mute	
Style Acc1...5 Mute	
Style Acc 1-5 Mute	Mute/Unmute all the Acc tracks at once
Song Melody Mute	Mutes the MIDI Song track set as the Melody track (Global > Mode Preference > Song & Seq.)
Vocal Remover	Removes the lead voice from the MP3 Song
Song Drum&Bass Mode	Mute of all MIDI Song tracks, except the Bass and Drum tracks (as set in the Global > Mode Preference > Song & Seq. page). It doesn't work on MP3 Songs.
Solo Selected Track	Turns track solo on/off
Bass&Lower Backing	When the Style is not playing and the keyboard is in Split mode, you can play the Lower Sound with your left hand, while the Bass still plays the chord root.
QuarterTone	Turns Quarter Tone on/off
Retune Style	Makes the instrument wait for a chord. The root of the chord will be the new root of the scale used by some of the Accompaniment tracks.
Global-Scale	When the switch or footswitch is pressed, the Global > Tuning > Scale page is recalled
SubScale Preset 1...15 - SC1...15	Same functions as the Scale Preset buttons in the display
Mic Talk	Switch controls assigned to the Voice Processor
Mic Lead On/Off	
Mic Filter On/Off	
Mic HardTune On/Off	
Mic uMod On/Off	
Mic Delay On/Off	
FX CC12 Switch	Standard FX switches. How they work depends on the Effects programming.
FX CC13 Switch	
Rotary Spkr On/Off	Rotary Speaker effect controls
Rotary Spkr Fast/Slow	
Drawbar Perc On/Off	Turns Drawbar Percussion on/off
Text Page Next	These options let you move to the previous or next page, when reading a text file automatically loaded with a Song or SongBook Entry, or manually loaded from the Lyrics page.
Text Page Prev	

Switch function	Meaning
Set List Next	Moves to the next SongBook Entry in the selected Set List
Set List Prev	Moves to the previous SongBook Entry in the selected Set List
Sound Controller 1	DNC Sound Controllers (CC#80 and CC#81). They control the function assigned in Sound Edit in DNC Sounds.
Sound Controller 2	

Setting the Accelerando/Ritardando times

Accelerando and Ritardando are controls you can assign to an assignable switch or footswitch. While the switch is kept pressed, Tempo will start gradually speeding up or down.

- 1 Go to the Global > General Controls > Basic page.



- 2 Use the Accelerando/Ritardando > Step parameter to set the speed of Tempo change (from 1 to 6).

With higher values, the step change will be greater, and the speed will change faster. With lower values, the step change will be smaller, and the speed will change more slowly.

- 3 Use the Accelerando/Ritardando > Curve parameter to set the curve of Tempo change (from 1 to 3).

Experiment the various options, to see the one that best fits your taste.

47 Foot controllers

Programming the damper pedal

You can connect a footswitch, or a dedicated damper pedal, to the PEDAL > DAMPER connector on the back of the instrument. This pedal always works as a Damper pedal.

Assigning the Damper pedal to the Sounds

You can activate/deactivate the damper pedal on each Keyboard Sound. This is useful, for example, to only sustain some Upper Sounds and not the others.

- 1 Go to the Keyboard/Ensemble > Joystick/Pedal page.
- 2 Use the Damper checkbox to turn the Damper pedal on/off on each Keyboard Sound.

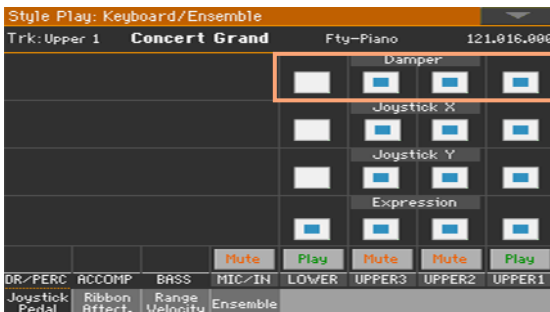

- 3 Write the changes to a Keyboard Set.

Programming the assignable pedal/footswitch

Assigning a function to the pedal/footswitch

You can connect a footswitch or expression pedal to the **PEDAL > ASSIGNABLE** connector on the back of the instrument. Depending on the connected type of pedal, you will choose a suitable function.

Program the pedal/footswitch

- 1 Connect the pedal or footswitch to the **PEDAL > ASSIGNABLE** connector.
- 2 Go to the **Global > Controllers > Foot** page.
- 3 Use the **Function** pop-up menu to choose a control function.



Functions assignable to a footswitch

Footswitch function	Meaning	
Off	No function assigned	
Style Start/Stop	Same functions as the control panel buttons with the same name	
Play/Stop Player 1		
Play/Stop Player 2		
Go to Beginning Player 1		
Go to Beginning Player 2		
Chord Seq. Record		
Chord Seq. Play		
Synchro Start		
Synchro Stop		
Tap Tempo/Reset		
Tempo Lock		
Ritardando		Slowing down or making the Tempo faster, according to the curves programmed in the Global > General Controls > Basic page.
Accelerando		
Tempo Up		Same functions as the control panel buttons with the same name
Tempo Down		
Intro 1...3/Count In	Selects the corresponding Intro	
Ending 1...3	Selects the corresponding Ending	
Fill 1...4	Selects the corresponding Fill	
Break	Selects the Break	
Variation 1...4	Selects the corresponding Variation	
Variation Up	Selects the next Variation	
Variation Down	Selects the previous Variation	
Fade In/Out	Same functions as the control panel button with the same name	
Memory		
Bass Inversion		
Manual Bass		
Split		
Style Up		Selects the next Style
Style Down	Selects the previous Style	
Style to Kbd Set	Same function as the control panel button with the same name	
Kbd Set 1...4	Selects the corresponding Keyboard Set from the KEYBOARD SET section under the display	

Footswitch function	Meaning
Kbd Set Up	Selects the next Keyboard Set from the KEYBOARD SET section under the display
Kbd Set Down	Selects the previous Keyboard Set from the KEYBOARD SET section under the display
Kbd Set Library Up	Selects the next Keyboard Set from the KEYBOARD SET LIBRARY
Kbd Set Library Down	Selects the previous Keyboard Set from the KEYBOARD SET LIBRARY
Sound Up	Selects the next Sound
Sound Down	Selects the previous Sound
Transpose (b)	Same functions as the control panel buttons with the same name
Transpose (#)	
Upper Octave Up	
Upper Octave Down	
Punch In/Out	Turns Punch Recording on/off
Kbd Upper1...3 Mute	Mute of the corresponding Sound.
Kbd Lower Mute	
Style Drum Mute	
Style Perc Mute	
Style Bass Mute	
Style Acc1...5 Mute	
Style Acc1-5 Mute	Mute/Unmute all the Acc tracks at once
Song Melody Mute	Mutes the MIDI Song track set as the Melody track (Global > Mode Preference > Song & Seq.).
Vocal Remover	Removes the lead voice from the MP3 Song
Song Drum&Bass Mode	Mute of all MIDI Song tracks, except the Bass and Drum tracks (as set in the Global > Mode Preference > Song & Seq. page). It doesn't work on MP3 Songs.
Solo Selected Track	Turns track solo on/off
Damper Pedal	Damper function. Corresponds to the right pedal of an acoustic piano. It holds the notes played when the pedal is pressed down.
Soft Pedal	Soft function. Corresponds to the 'una corda' pedal of an acoustic piano. Makes the sound softer.
Sostenuto Pedal	Sostenuto function. Corresponds to the left pedal of a grand piano. It holds the notes already held when pressing the pedal down.
Bass&Lower Backing	When the Style is not playing and the keyboard is in Split mode, you can play the Lower Sound with your left hand, while the Bass still plays the chord root.
Ensemble	Turns Ensemble on/off

Footswitch function	Meaning
QuarterTone	Turns Quarter Tone on/off
Retune Style	Makes the instrument wait for a chord. The root of the chord will be the new root of the scale used by some of the Accompaniment tracks.
Global-Scale	When the switch or footswitch is pressed, the Global > Tuning > Scale page is recalled.
SubScale Preset 1...15 - SC1...15	Same functions as the Scale Preset buttons in the display
Chord Latch	Holds the recognized chord until the pedal is released
Glide	When the pedal is pressed, affected notes on Upper tracks are bent down, according to settings for the Pitch Bend on the same tracks. When the pedal is released, notes return to the normal pitch, at the speed defined in the Global > General Controls > Basic page.
Mic In Mute	Switch controls assigned to the Voice Processor
Mic Talk	
Mic Lead On/Off	
Mic Harmony On/Off	
Mic Double On/Off	
Mic Filter On/Off	
Mic Hard Tune On/Off	
Mic uMod On/Off	
Mic Delay On/Off	
Mic Reverb On/Off	
FX CC12 Switch	Standard FX switches. How they work depends on the Effects programming.
FX CC13 Switch	
Rotary Spkr On/Off	Rotary Speaker effect controls
Rotary Spkr Fast/Slow	
Drawbar Perc On/Off	Turns Drawbar Percussion on/off
Text Page Next	These options let you move to the previous or next page, when reading a text file automatically loaded with a Song or SongBook Entry, or manually loaded from the Lyrics page.
Text Page Prev	
Set List Next	Moves to the next SongBook Entry in the selected Set List.
Set List Prev	Moves to the previous SongBook Entry in the selected Set List.
Pad 1...4	Same functions as the control panel buttons with the same name
Pad Stop	
Sound Controller 1	DNC Sound Controllers (CC#80 and CC#81). They control the function assigned in Sound Edit in DNC Sounds.
Sound Controller 2	

Functions assignable to an expression pedal

Pedal function	Meaning
Master Volume	Master Volume control
Accompaniment Volume	Volume of the Accompaniment Sounds
Keyboard Expression	Relative Volume of the Keyboard Sounds. All the other Sounds will not be varied.
Pad Volume	Volume of the MP3 Songs
Joystick X+	Replicates the joystick right movement
Joystick X-	Replicates the joystick left movement
Joystick Y+	Replicates the joystick forward movement
Joystick Y-	Replicates the joystick backward movement
Upper VDF Cutoff	Filter cutoff (for Sounds assigned to the Upper tracks)
Upper VDF Resonance	Filter resonance (for Sounds assigned to the Upper tracks)
Mic In Volume	Continuous controls assigned to the Voice Processor
Mic Lead Voice Level	
Mic Harmony/Double Level	
Mic Harmony Level	
Mic Double Level	
Mic Filter Level	
Mic uMod Level	
Mic Delay/Reverb Level	
Mic Delay Level	
Mic Reverb Level	
Mic EQ Gain Low	
Mic EQ Gain Mid	
Mic EQ Gain High	
FX CC12 Ctrl	Standard FX controllers, used as DMS modulations. How they work depends on the Effects programming.
FX CC13 Ctrl	

Assigning the Expression pedal to the Sounds

Expression is a relative level control, always subtracted from the Volume value. It can be assigned to any continuous pedal (also called a Volume/Expression pedal).

As an example, imagine you have a Piano sound assigned to Upper 1, and a Strings sound assigned to Upper 2. If you turn the Expression switch on on Upper 2, and off on Upper 1, you can use a continuous pedal to control only the Strings' volume, while the Piano remains unchanged.

- 1 Go to the Keyboard/Ensemble > Joystick/Pedal page.
- 2 Use the Expression checkbox to turn the Expression pedal on/off on each Keyboard Sound.

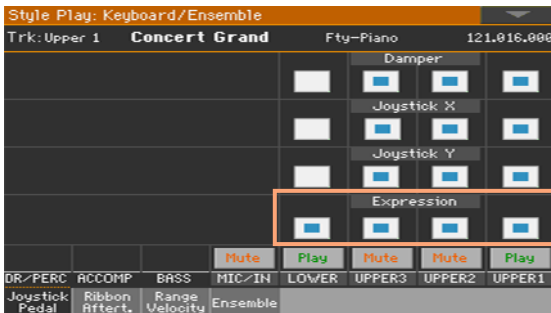

- 3 Write the changes to a Keyboard Set.

Setting the Glide time

Glide is a control you can assign to a footswitch or EC5 switch. When the pedal is pressed, affected notes on Upper parts are bent down, according to settings for the Pitch Bend on the same parts. When the pedal is released, notes return to the normal pitch, at the speed defined by the Time parameter.

Change the Pitch Bend values

- 1 Go to the Mixer/Tuning > Tuning page.

- Use the PB Sensitivity parameter to set the Pitch Bend range (in semitones).

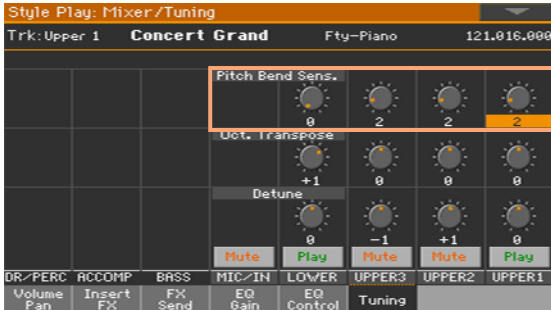

- Write the changes to a Keyboard Set.

Change the Glide time

- Go to the Global > General Controls > Basic page.
- Use the Glide > Time parameter to set the glide time.

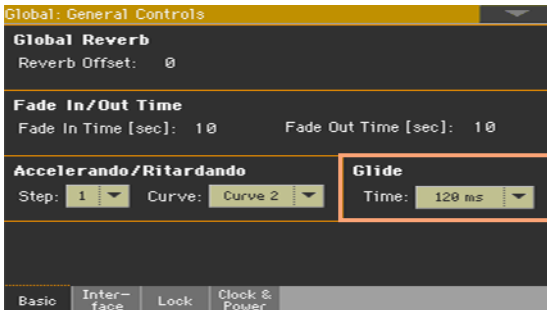

Calibrating the pedal and setting its polarity

If needed, you might have to calibrate the pedals to use their full range of values, without any 'dead spot'. Also, this procedure allows to choose the pedal's polarity.

Calibrate the pedal

- 1 Go to the Global > Controllers > Foot page.

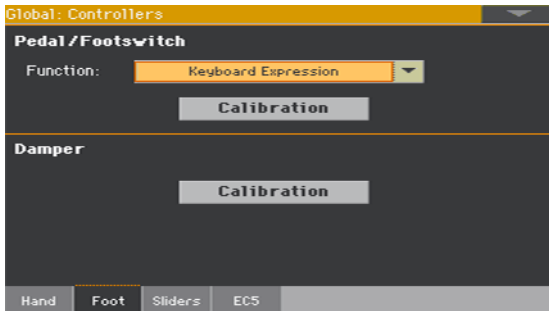

- 2 Touch the Calibration button in the area of the button to calibrate, to make the Damper & Pedal/Footswitch Calibration dialog appear.



- 3 Fully press the pedal down, and while continuing to press touch the Push button to confirm the maximum value.
- 4 When the following dialog appears, release the pedal.



- 5 Touch the Push button in the display to confirm the minimum value. Check if the pedal is working properly. In case it isn't, repeat the procedure.
- 6 Press the EXIT button to return to the previous page.

Programming the EC5 multiswitch

Programming the EC5 switches

You can connect a KORG EC5 multiswitch controller to the EC5 connector on the back of the instrument. This will give you a set of five programmable switches.

- 1 Connect the EC5 multiswitch to the EC5 connector.
- 2 Go to the Global > Controllers > EC5 page.
- 3 Use the A...E pop-up menus to choose a control function to each of the switches.



Functions assignable to an EC5 switch

EC5 function	Meaning
Off	No function assigned
Style Start/Stop	Same functions as the control panel buttons with the same name
Play/Stop Player 1	
Play/Stop Player 2	
Go to Beginning Player 1	
Go to Beginning Player 2	
Chord Seq. Record	
Chord Seq. Play	
Synchro Start	
Synchro Stop	
Tap Tempo/Reset	
Tempo Lock	
Ritardando	Slowing down or making the Tempo faster, according to the curves programmed in the Global > General Controls > Basic page.
Accelerando	
Tempo Up	Same functions as the control panel buttons with the same name
Tempo Down	
Intro 1...3/Count In	Selects the corresponding Intro
Ending 1...3	Selects the corresponding Ending
Fill 1...4	Selects the corresponding Fill
Break	Selects the Break
Variation 1...4	Selects the corresponding Variation
Variation Up	Selects the next Variation
Variation Down	Selects the previous Variation
Fade In/Out	Same functions as the control panel button with the same name
Memory	
Bass Inversion	
Manual Bass	
Split	
Style Up	Selects the next Style
Style Down	Selects the previous Style
Style to Kbd Set	Same function as the control panel button with the same name
Kbd Set 1...4	Selects the corresponding Keyboard Set from the KEYBOARD SET section under the display

EC5 function	Meaning
Kbd Set Up	Selects the next Keyboard Set from the KEYBOARD SET section under the display
Kbd Set Down	Selects the previous Keyboard Set from the KEYBOARD SET section under the display
Kbd Set Library Up	Selects the next Keyboard Set from the KEYBOARD SET LIBRARY
Kbd Set Library Down	Selects the previous Keyboard Set from the KEYBOARD SET LIBRARY
Sound Up	Selects the next Sound
Sound Down	Selects the previous Sound
Transpose (b)	Same functions as the control panel buttons with the same name
Transpose (#)	
Upper Octave Up	
Upper Octave Down	
Punch In/Out	
Kbd Upper1...3 Mute	Mute of the corresponding Sound.
Kbd Lower Mute	
Style Drum Mute	
Style Perc Mute	
Style Bass Mute	
Style Acc1...5 Mute	
Style Acc1-5 Mute	Mute/Unmute all the Acc tracks at once
Song Melody Mute	Mutes the MIDI Song track set as the Melody track (Global > Mode Preference > Song & Seq.).
Vocal Remover	Removes the lead voice from the MP3 Song
Song Drum&Bass Mode	Mute of all MIDI Song tracks, except the Bass and Drum tracks (as set in the Global > Mode Preference > Song & Seq. page). It doesn't work on MP3 Songs.
Solo Selected Track	Turns track solo on/off
Damper Pedal	Damper function. Corresponds to the right pedal of an acoustic piano. It holds the notes played when the pedal is pressed down.
Soft Pedal	Soft function. Corresponds to the 'una corda' pedal of an acoustic piano. Makes the sound softer.
Sostenuto Pedal	Sostenuto function. Corresponds to the left pedal of a grand piano. It holds the notes already held when pressing the pedal down.
Bass&Lower Backing	When the Style is not playing and the keyboard is in Split mode, you can play the Lower Sound with your left hand, while the Bass still plays the chord root.
Ensemble	Turns Ensemble on/off

EC5 function	Meaning
QuarterTone	Turns Quarter Tone on/off
Retune Style	Makes the instrument wait for a chord. The root of the chord will be the new root of the scale used by some of the Accompaniment tracks.
Global-Scale	When the switch or footswitch is pressed, the Global > Tuning > Scale page is recalled.
SubScale Preset 1...15 - SC1...15	Same functions as the Scale Preset buttons in the display
Chord Latch	Holds the recognized chord until the pedal is released
Glide	When the pedal is pressed, affected notes on Upper tracks are bent down, according to settings for the Pitch Bend on the same tracks. When the pedal is released, notes return to the normal pitch, at the speed defined in the Global > General Controls > Basic page.
Mic In Mute	Switch controls assigned to the Voice Processor
Mic Talk	
Mic Lead On/Off	
Mic Harmony On/Off	
Mic Double On/Off	
Mic Filter On/Off	
Mic Hard Tune On/Off	
Mic uMod On/Off	
Mic Delay On/Off	
Mic Reverb On/Off	
FX CC12 Switch	Standard FX switches. How they work depends on the Effects programming.
FX CC13 Switch	
Rotary Spkr On/Off	Rotary Speaker effect controls
Rotary Spkr Fast/Slow	
Drawbar Perc On/Off	Turns Drawbar Percussion on/off
Text Page Next	These options let you move to the previous or next page, when reading a text file automatically loaded with a Song or SongBook Entry, or manually loaded from the Lyrics page.
Text Page Prev	
Set List Next	Moves to the next SongBook Entry in the selected Set List.
Set List Prev	Moves to the previous SongBook Entry in the selected Set List.
Pad 1...4	Same functions as the control panel buttons with the same name
Pad Stop	
Sound Controller 1	DNC Sound Controllers (CC#80 and CC#81). They control the function assigned in Sound Edit in DNC Sounds.
Sound Controller 2	

PART XII:
GLOBAL
SETTINGS AND
PREFERENCES

48 Customizing the user interface

Display and control panel preferences

Choosing the chords and alphanumeric keyboard language

You can choose the language used to show chord names and the characters that can be inserted using the alphanumeric virtual keyboard. Please note that some of the characters can only be used when editing SongBook Entry names.

- 1 Since the instrument must be restarted at the end of this procedure, be sure to first save all unsaved data.
- 2 Go to the Global > General Controls > Interface page.
- 3 Use the Language pop-up menu to select one of the available languages.

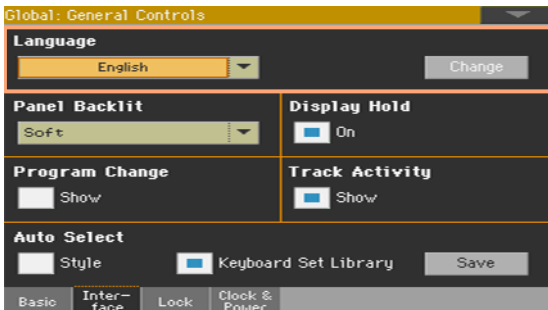

- 4 Touch the Change button to apply the selected language.
- 5 A message will ask you to reboot the instrument. Touch the OK button to close the message window.
- 6 Turn off, then restart the instrument to activate the new language.

Control panel illumination

You can adjust the button indicators' brightness, to adapt the control panel glowing/luminosity to the ambient light.

- 1 Go to the Global > General Controls > Interface page.
- 2 Use the Panel Backlit pop-up menu to select one of the available luminosity degrees.

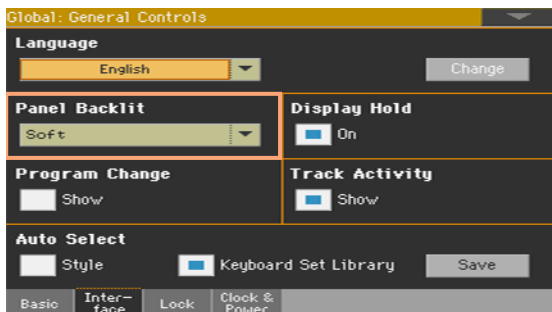

Automatically closing the Select windows

You may prefer to leave a Select window open after you have chosen a Sound, Keyboard Set, Style, Pad or Voice Preset, to continue trying other elements in that window. Or, you may prefer it automatically closes after you have completed your choice. This is determined by the Display Hold parameter.

- 1 Go to the Global > General Controls > Interface page.

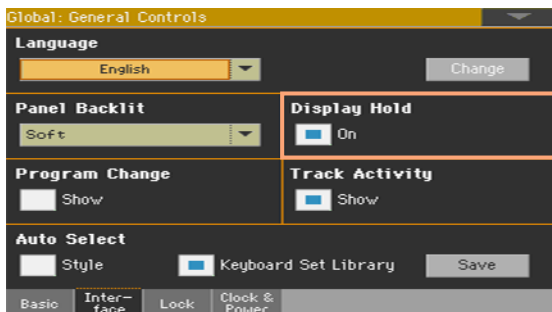

- 2 Select the Display Hold checkbox to let the Select windows remain open until you press the EXIT button. Deselect it to let the Select windows automatically close after you choose an element.

Program Change and activity indicators

Showing/Hiding the Program Change number

You can make Program Change numbers be shown next to Sound names in the Sound Select window.



Please note that Program Change numbers are always shown in the various Track Info areas.

- 1 Go to the Global > General Controls > Interface page.
- 2 Select/deselect the Program Change > Show checkbox.

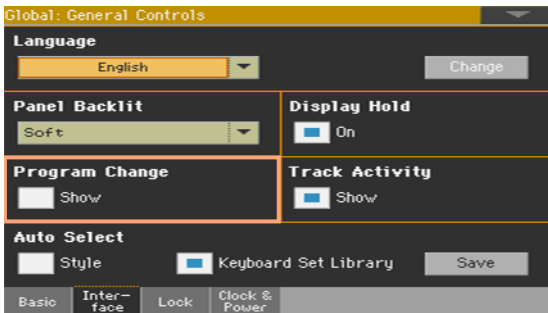

Showing/Hiding the track's activity

You can turn on/off the Track Activity display. When it is turned on, you can monitor events coming from the internal Sounds or the MIDI messages. Incoming events are shown by the color changing on each track's label.



- 1 Go to the Global > General Controls > Interface page.
- 2 Select/deselect the Track Activity > Show checkbox.

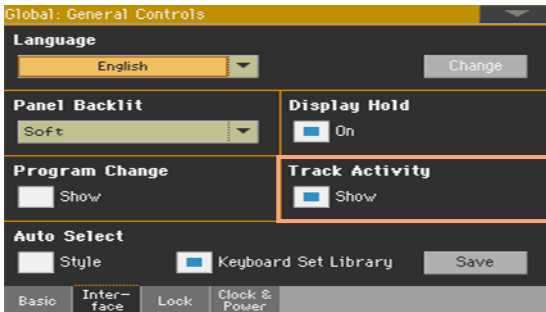

49 Automatic selection and locking

Automatically choosing Styles and Keyboard Sets

Preferred Styles and Keyboard Sets can be assigned to the STYLE and KEYBOARD SET LIBRARY buttons. They are also assigned to the side tabs in the Style Select and Keyboard Set Library Select windows.

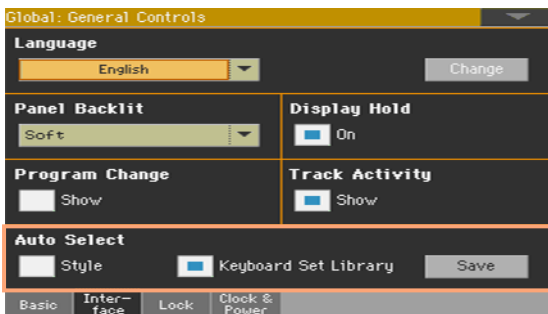

Automatically selecting the Styles

When the Auto Select > Style parameter is activated, pressing one of the STYLE buttons, or touching the name of a bank in the Style Select window, automatically selects the Style you latest selected in that bank. This way, you can assign your preferred Style to each control panel's button, and select it just with a single press.

However, the Style Select window will still appear, so that you can select a different item if desired.

- 1 Choose a Style for each STYLE button you want to program.
- 2 Go to the Global > General Controls > Interface page.
- 3 Select the Style checkbox in the Auto Select section.
- 4 Touch the Save button to save the Style assignment to all banks.

Automatically selecting the Keyboard Sets from the library

When the **Auto Select > Keyboard Set Library** parameter is activated, pressing one of the **KEYBOARD SET LIBRARY** buttons, or touching the name of a bank in the **Keyboard Set Library Select** window, automatically selects the Keyboard Set you latest selected in that bank. This way, you can assign your preferred Keyboard Set to each control panel's button, and select it just with a single press.

However, the **Keyboard Set Library Select** window will still appear, so that you can select a different item if desired.

- 1 Choose a Keyboard Set for each **KEYBOARD SET LIBRARY** button you want to program.
- 2 Go to the **Global > General Controls > Interface** page.
- 3 Select the **Keyboard Set Library** checkbox in the **Auto Select** section.
- 4 Touch the **Save** button to save the Keyboard Set assignment to all buttons.

Locking parameters to prevent changes

In various pages, next to some parameters, you can find a lock (🔒) icon. All these locks are collected in the Global > General Controls > Lock pages for easy access.

Locking the Tuning parameters

- 1 Go to the Global > General Controls > Lock > Tuning page.

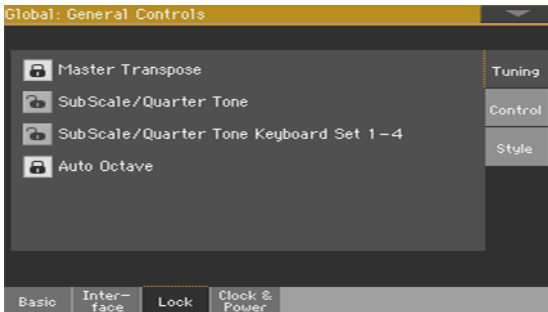

- 2 Select/deselect the desired locks.

Tuning lock	Meaning
Master Transpose	Prevents Master Transpose from changing when choosing a SongBook Entry. It also prevents transposing when loading a Standard MIDI File created by Pa4X or any instrument of the KORGE Pa-Series.
Sub Scale/Quarter Tone	Prevents the Sub-Scale or Quarter Tone value from changing when choosing a Keyboard Set or SongBook Entry.
SubScale/Quarter Tone Keyboard Set 1-4	Prevents the Sub-Scale or Quarter Tone value from changing when choosing a Keyboard Set by pressing the KEYBOARD SET buttons under the display.
Auto Octave	Depending on the status of this lock, the Upper Sounds can be automatically transposed when turning the SPLIT on and off. <ul style="list-style-type: none"> • If locked, turning the SPLIT on or off will not cause Upper Sounds transposition. • If unlocked, when turning the SPLIT button off (Full keyboard mode) the Upper Sound's Octave Transpose will be automatically set to '0'. When turning the SPLIT button on (Split keyboard mode) the Upper Sound's Octave Transpose will be automatically set to '-1'.

SongBook Entries, Keyboard Sets, and the sub-scale

If you want that choosing a SongBook Entry also changes the sub-scale, the SubScale/Quarter Tone has to be unlocked.

However, if you don't want that choosing a Keyboard Set (by pressing one of the KEYBOARD SET buttons under the display) also changes the sub-scale, lock the SubScale/Quarter Tone Keyboard Set 1-4.

Locking the Control parameters

- 1 Go to the Global > General Controls > Lock > Control page.

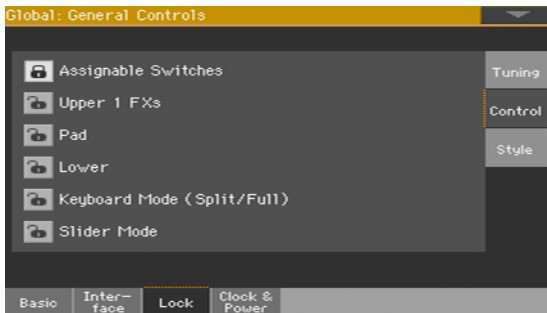

- 2 Select/deselect the desired locks.

Control lock	Meaning
Assignable Switches	When locked, selecting a Keyboard Set will not change the functions assigned to the Assignable Switches.
Upper 1 FXs	<p>When choosing the Upper 1 Sound, the Sound's or the Keyboard Set's effect settings can be selected.</p> <ul style="list-style-type: none"> • If this lock is closed, the Keyboard Set's effect parameters are left unchanged. • If this lock is open, the Sound's effect parameters are selected. <p>To avoid sudden and unmusical effect changes, if the Sound's effects are not compatible with the effects already assigned to the FX B block, the Master FX Send values on the other Keyboard Sounds will be automatically set to zero.</p> <p>For example, assume a chorus effect is assigned to the B2 Master FX processor. If the new Sound assigns a distortion effect to the B2 Master FX processor, the B2 Master FX Send value on the Upper 2, Upper 3, and Lower Sounds will be set to zero, to avoid these Sounds to sound odd. This way, the Upper 1 Sound (usually the most important one for solo playing) will sound with the needed effects, while the other Keyboard Sounds will just sound dry.</p>
Pad	When locked, selecting a Style or SongBook Entry will not change the Pads.
Lower	<p>When this lock is closed, the Lower Sound remains unchanged when a different Keyboard Set or Style is selected.</p> <p>This is useful if, for example, you prefer to only play chords with the left hand, while leaving the Sound in mute.</p> <p>Hint: If you want the same Lower settings to be used during all your shows, save your preferred Lower settings to the MY SETTING Keyboard Set (automatically selected on startup), and close this lock.</p>
Keyboard Mode (Split/Full)	<p>When this lock is closed, the status of the SPLIT button (therefore of the keyboard mode) remains unchanged when a different Keyboard Set is selected.</p> <p>This is useful if, for example, you prefer to always play in Full Keyboard mode, with chords recognized on the full keyboard range.</p> <p>Hint: If you want the same Lower settings to be used during all your shows, save your preferred Lower settings to the MY SETTING Keyboard Set (automatically selected on startup), and close this lock.</p>
Slider Mode	When locked, selecting a Keyboard Set or SongBook Entry will not change the status of the SLIDER MODE indicator.

Locking the Style parameters

- 1 Go to the Global > General Controls > Lock > Style page.

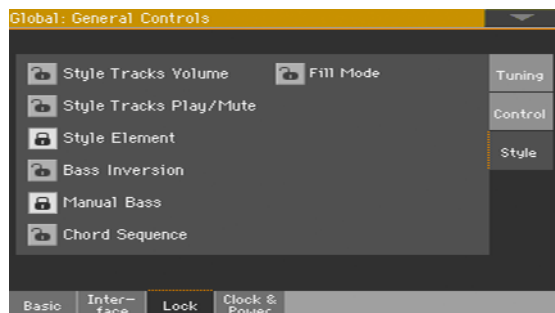

- 2 Select/deselect the desired locks.

Style locks	Meaning
Style Tracks Volume	When this lock is closed, choosing a different Style does not change the volume of the accompaniment tracks. This is useful when you create your own User Styles, and prefer to dynamically adjust the volume by using the internal mixer. It is not recommended with Factory Styles, each one already mixed at its best right at the factory.
Style Tracks Play/Mute	When this lock is closed, choosing a Style does not change the Play/Mute status of the accompaniment tracks. This way, you can, for example, turn the bass track off during a whole show, to allow your bassist to play the part live. Also, you could mute all the Acc tracks, to only play with the Drum and Bass tracks.
Style Element	When this lock is closed, choosing a Style does not change the selected Style Element (Variation, Intro...). This lock does not apply to the Fills and Break. This lock has no effect on the Styles automatically selected when choosing a SongBook Entry. In this case, the Style Element memorized in the SongBook Entry is always selected.
Bass Inversion	When locked, choosing a Keyboard Set will not change the Bass Inversion status.
Manual Bass	When locked, choosing a Keyboard Set will not change the Manual Bass status.
Chord Sequence	When locked, choosing a Style or SongBook Entry will not change the Chord Sequence in memory.
Fill Mode	When locked, the selected Fill Mode will not change when choosing a different Style or SongBook Entry.

50 System preferences

Setting the date and time for file saving

Pa4X includes a battery-backed system calendar and clock. This allows for automatically adding a time-stamp to the files, when they are created or edited.

- 1 Go to the Global > General Controls > Clock & Power page.
- 2 Set the Month/Day/Year and Time values.

Use the Time numeric field to input the time, in the 'hour:minute:second' format.

- 3 After having edited all calendar and time fields, touch the Apply button to apply the changes.

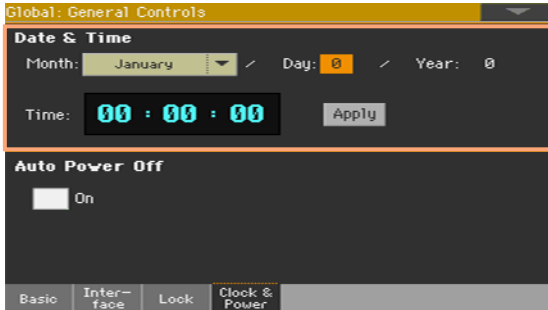

Date and time from older data

Starting with OS v1.1, date and time are assigned to each single musical resource (a single Sound, a single Style...), instead of a whole bank. When saving a musical resource, the current date and time are updated. Older, unsaved resources in the same bank take the same date and time of the saved resource.

Since the date and time of the older, unsaved resources are not the real date and time they were last modified, they will appear dimmed in a file list.

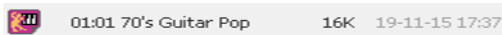

Automatic power off

Pa4X can automatically enter standby after two hours of not being used, to save power and help preserving the environment.

- 1 Go to the Global > General Controls > Clock & Power page.
- 2 Select/deselect the Auto Power Off checkbox.

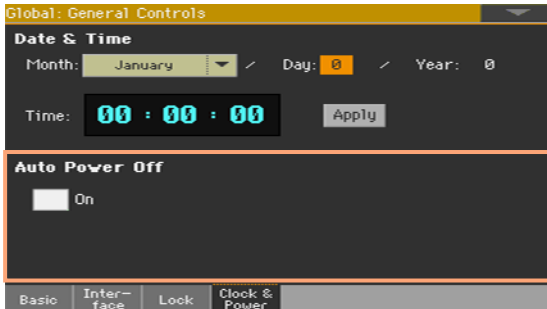

When this parameter is checked, a few minutes before automatic standby a message will warn you that the instrument is going to be put in standby. All unsaved data currently in editing or recording will be lost.

At this message, you can let the instrument enter standby, or you can touch the display, press any button on the display, or play the keyboard to leave it turned on and continue using it.

51 Master Transpose and Tuning

Master Tuning

You can fine tune the instrument (in cents of a semitone), to adapt it to an acoustic instrument that is not possible to tune (for example an acoustic piano without a professional tuner or the right tools, or a period instrument).

- 1 Go to the Global > Tuning > Master page.
- 2 Use the Master Tuning parameter to fine tune the instrument.

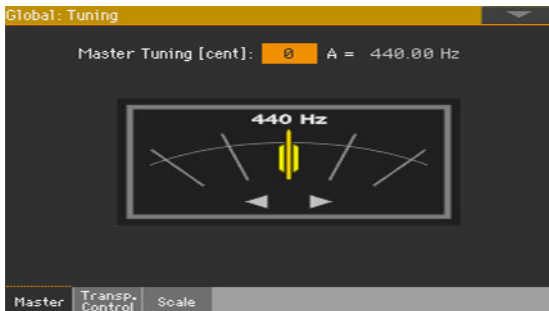

Tuning	Meaning
-100 cents	Lowest pitch (half a semitone down)
0 cents	Standard pitch (A4 = 440Hz)
+100 cents	Highest pitch (half a semitone up)

Master Transpose

Transposing the whole instrument

The instrument's key can be transposed to make singing or playing together with another instrument more comfortable. Master Transpose settings are also sent to any GM-compliant instrument.

The transpose value is usually shown in the page header.



Transpose down from the control panel

- Use the TRANSPOSE > FLAT (b) button to lower the Master Transpose in steps of one semitone.

Transpose up from the control panel

- Use the TRANSPOSE > SHARP (#) button to raise the Master Transpose in steps of one semitone.

Reset transposition

- Press both TRANSPOSE buttons together.

SongBook and Master Transpose

When saving a SongBook Entry, the Master Transpose is also saved. Master Transpose might therefore change when choosing a SongBook Entry. To avoid this to happen, you may lock the Master Transpose in Global > General Controls > Lock > Tuning.

Saving the Master Transpose with a Keyboard Set, Style or Song

If you want to save the Master Transpose value together with the Keyboard Sets, Styles or Songs, you can create a new SongBook Entry based on them. Choose the desired data and settings, then keep the SONGBOOK button pressed for about one second to create a new SongBook Entry.

MP3 Songs and Master Transpose

MP3 Songs can be transposed inside the range of -5...+6 semitones. This range is enough to cover all keys, while avoiding excessive audio degradation. Any further transposing will be reversed to fit the range. So, you might see a +7 transpose value (Just Fifth Up) shown in the display, but the MP3 Song will actually play 5 semitones lower (Just Fourth Down).

MIDI Songs and Master Transpose

Saving Master Transpose with the Song

When saving a MIDI Song from the Sequencer mode, the Master Transpose value is saved with the Song. This value is preserved when playing back the Song in Song Play mode.

Preventing unwanted transposition

When loading a MIDI Song containing Master Transpose data, the instrument's Master Transpose is modified. This may cause problems with other Songs or when playing the Styles. To avoid this to happen, you may lock the Master Transpose in **Global > General Controls > Lock > Tuning**.

If you still want to transpose the Song, use the **Transpose** function found in the **Sequencer > Song Edit > Transpose** page to transpose the MIDI data contained in the MID file.

As a general rule, you should use the **Master Transpose** (TRANSCOPE buttons on the control panel) when you want to transpose the Keyboard Sounds together with the Song. You should use the Song Edit's **Transpose** function when only the Song has to be transposed.

Displaying transposed chord abbreviations in MIDI Songs

When changing the Master Transpose, chord abbreviations contained in MIDI Songs are transposed and correctly shown in the display. Master Transpose must be applied to the Player, but not to the Keyboard.

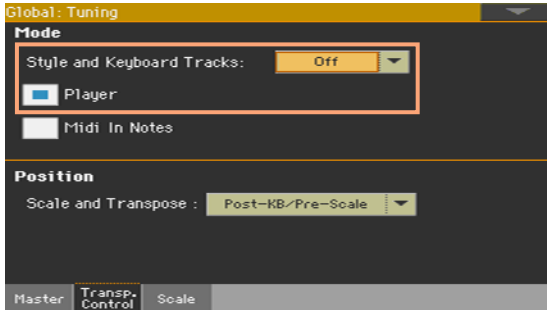

Please note that chords contained in a linked TXT file or shown in a CDG file are not transposed.

When is Master Transpose applied?

You can decide when the Master Transpose will take effect.

- 1 Go to the Global > Tuning > Transpose Control page.
- 2 Use the Mode > Style and Keyboard Tracks pop-up menu to choose when transposition will apply.

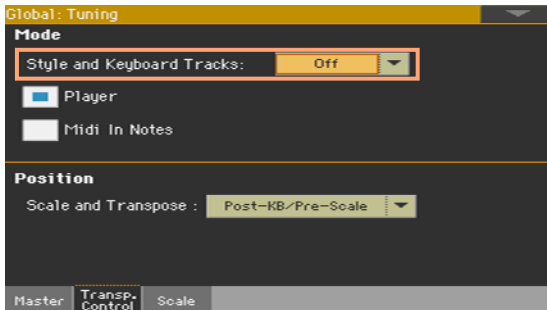

Transpose	Meaning
Off	No Master Transpose is applied to Accompaniment and Keyboard Sounds. Chords shown in the Lyrics page are, however, transposed.
Next Measure	When you press either of the TRANPOSE buttons, the new transpose setting will not take effect until the first beat of the next measure is reached.
Immediate	When you press either of the TRANPOSE buttons, the new transpose setting will separately occur when the next note is played by the Accompaniment or Keyboard Sounds. If, for example, you play a note on the keyboard when the Accompaniment is still playing a chord, only the Keyboard Sounds will be transposed, and the Accompaniment Sounds will only be transposed at the next chord.

Transposing the Songs and the MIDI IN notes

Master Transpose can be separately applied to the Song Player and to the notes entering the MIDI IN or USB DEVICE port.

- 1 Go to the Global > Tuning > Transpose Control page.
- 2 Use the Mode > Player checkbox to activate/deactivate transposition on the internal Players.
- 3 Use the Mode > Midi In notes checkbox to activate/deactivate transposition on the incoming MIDI notes.

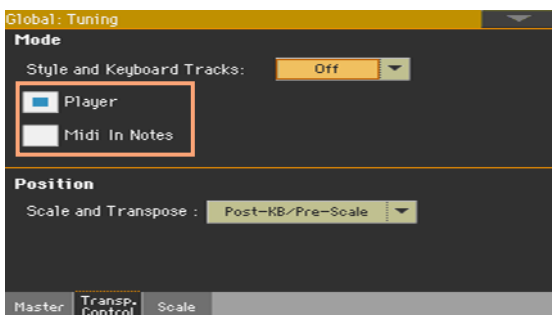

Master Transpose and Scale

You can define the relation between the Scale and the Master Transpose.

- 1 Go to the **Global > Tuning > Transpose Control** page.
- 2 Use the **Position > Scale and Transpose** pop-up menu to choose where transposition will apply in relation to the Scale.

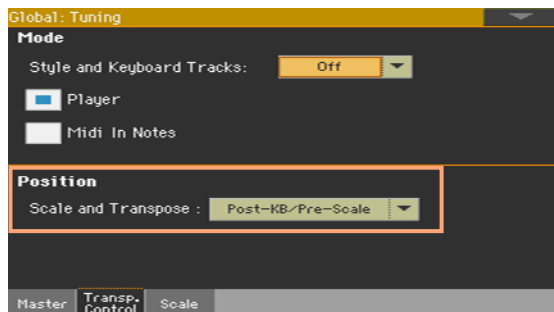

Transpose position	Meaning
Post-KB/Pre-Scale	<p>When this option is selected, notes will be transposed immediately after they leave the keyboard. The Scale will be applied to the transposed notes. For example, if you altered an E, and then set the Master Transpose to +1, the E key will play a real F, and the altered key will still be E (that will play an altered E).</p>
Post-KB & Scale	<p>When this option is selected, all notes are transposed immediately before they enter the internal tone generator, or are sent to the MIDI OUT or USB DEVICE port, and after the Scale. For example, if you altered an E, and set the Master Transpose to +1, the altered key will still be E (that will play an altered F).</p>

Drum Kits and Master Transpose

Drum Kits are never transposed. If you want that an ordinary Sound is not transposed as well, assign it to a track set to **Drum mode** in the **Style Play/Song Play > Track Controls > Mode** page.

52 Scale

Main Scale

Choosing the main scale

The main scale is usually applied to all or most of the Sounds. Some Sounds may use an alternative sub-scale. Some Style Elements may use alternative sub-scales. The main scale is used wherever there is no sub-scale assigned.

Choose the main scale

- 1 Go to the Global > Tuning > Scale page.

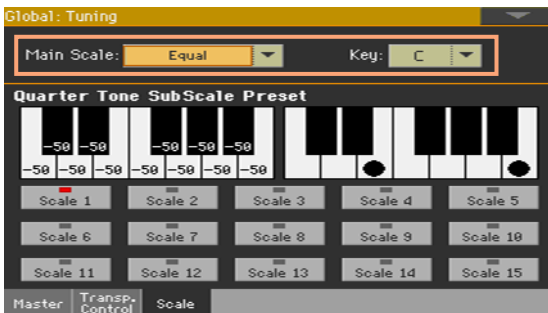

- 2 Use the Main Scale pop-up menu to choose the main scale of the instrument. All Sounds, apart for those for which a different sub-scale has been selected by a Keyboard Set, will use this scale.

If needed, choose a root key

- Use the Key parameter (needed with some scales) to set the scale root (therefore, the Sound's tuning).

Scales list

Scale	Description
Equal	Equal tuning, the standard scale for modern Western music. It is made of 12 identical semitones.
Pure Major	Major chords in the selected key are perfectly tuned.
Pure Minor	Minor chords in the selected key are perfected tuned.
Arabic	An Arabic scale, using quarters of tone. Set the Key parameter as follows: C - for the 'rast C/bayati D' scale D - for the 'rast D/bayati E' scale F - for the 'rast F/bayati G' scale G - for the 'rast G/bayati A' scale A# - for the 'rast Bb/bayati C' scale
Pythagorean	Pythagorean scale, based on the music theories of the great Greek philosopher and mathematician Pythagoras. It is most suitable for melodies.
Werckmeister	Late Baroque and early Classic age scale. Very suitable for 18th Century music.
Kirnberger	Harpsichord scale, very common during the 18th Century.
Slendro	Scale of the Indonesian Gamelan. The octave is divided in five notes (C, D, F, G, A). The remaining notes are tuned as in the Equal tuning.
Pelog	Scale of the Indonesian Gamelan. The octave is divided in seven notes (all white keys, when Key is = C). The black keys are tuned as in the Equal tuning.
Stretch	Simulates the 'stretched' tuning of an acoustic piano. Basically an equal tuning, the lowest notes are slightly lower, while the highest notes are slightly higher than the standard.
User	User scale, only available as a sub-scale. The User scale can be saved to a Keyboard Set, the Style Settings or a MIDI Song. You can't select it as the main scale in the Global.

Sub-Scale

Choosing a sub-scale for the Keyboard and/or Accompaniment Sounds

You can assign a different scale (a sub-scale) to the Keyboard Sounds. This will allow, for example, to play a piano solo with the Stretch tuning, while the backing tracks continue to play in the Equal tuning. A different sub-scale can be associated to each Keyboard Set.

You can also assign a sub-scale to all the Sounds of the Style, separate from the Sounds of a MIDI Song (that will still use the main scale). So, you will be able to play the Styles with a sub-scale, and the Songs with the main scale.

Choosing a sub-scale

- 1 Go to the Sub-Scale pane from the main page of the Style Play and Song Play modes.

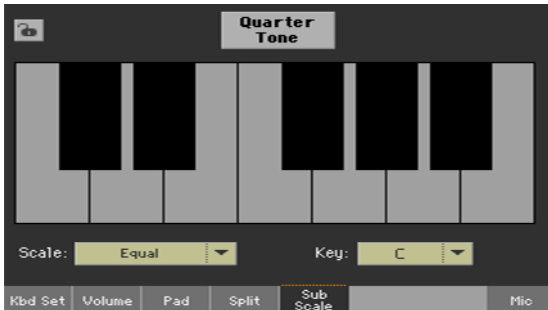

- 2 Use the Scale pop-up menu to choose the sub-scale. See above for a list of the available scales.
 - If needed, use the Key parameter (requested by some scales) to set the preferred key.

Assigning the sub-scale to the Keyboard and/or Accompaniment Sounds

- 1 Go to the Global > Mode Preferences > Style 2 page.
- 2 Use the Scale Mode parameter to choose the Sounds to which to apply the sub-scale. All the other Sounds will use the main scale.

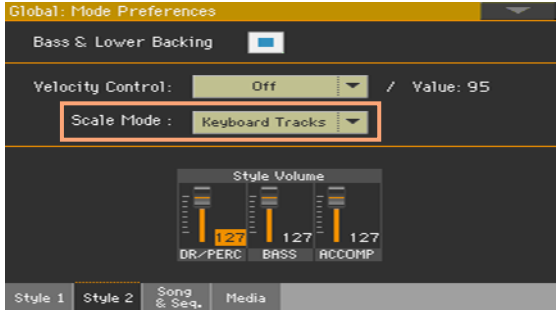

Scale Mode	Meaning
Keyboard Tracks	The sub-scale will affect all the Keyboard Sounds
Upper Tracks	The sub-scale will only affect the Upper 1-3 Keyboard Sounds
All Tracks	The sub-scale will affect the Keyboard Sounds and the Accompaniment Sounds. It will not affect the MIDI Song Sounds.

Editing a sub-scale for each Style Element and Accompaniment Sound

While in Style Record, you can edit a separate sub-scale for each Style Element, and enable the sub-scale on each track of the Style Element. This sub-scale will prevail over any other scale.

- 1 Go to the Style Record > Element Track Controls > Scale page.



- 2 Program the User scale, as explained below. To make programming easier, this sub-scale can only be a User scale.
- 3 Select the checkbox corresponding to the track(s) to which you want to apply the sub-scale.

The root key of this scale can dynamically change while you play, to allow for retuning the Style depending on the song section. How to retune the Style is explained later in this chapter.

Choosing and editing the User sub-scale

In addition to the supplied scales, you can program your own User sub-scale. This allows, for example, to have a different scale for each Keyboard Set.

Choose the User sub-scale

- 1 Go to the Sub-Scale pane from the main page of the Style Play and Song Play modes.

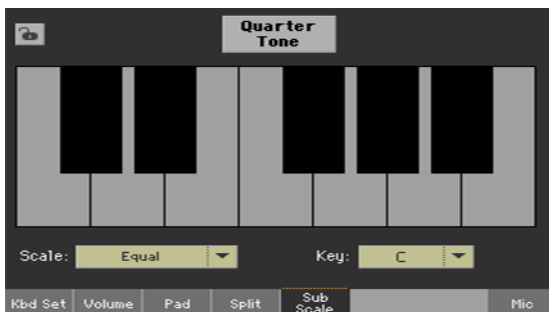

- 2 Use the Scale pop-up menu to choose the User sub-scale.

A Style Element's Scale is always a User scale.

Edit the User sub-scale

When the User sub-scale is selected, the keyboard diagram will become active, letting you program a custom scale.



- Use the numbers appearing in each note of the keyboard diagram to fine tune each note pitch. Detuning is referred to Equal tuning considered as zero detune.

Detuning	Meaning
-99 ... +99	Note detuning in cents or a semitone. Zero is no detuning (Equal tuning), ± 50 is a full quarter tone up or down, ± 99 is nearly one whole semitone up or down.

Memorize the User sub-scale into a Sound set

- Write the changes to a Sound set (Keyboard Set, Style Settings, Style).

Quarter Tone Sub-Scale (Scale Presets)

Editing a Quarter Tone sub-scale (Scale Preset)

Quarter Tone scales (Scale Presets) are custom scales where detuning can be activated or deactivated while playing. Changing note tuning while playing is typical of Middle East/Arabic music. The detuning interval is usually next to a quarter tone.

You can save up to fifteen Quarter Tone scales into the Scale Presets. The Scale Presets are global and do not change with Keyboard Sets, Styles or Songs.

Quarter Tone settings are also sent to other Pa-Series instruments.

Program a Quarter Tone scale

- 1 Go to the Global > Tuning > Scale page.



- 2 Touch one of the Scale buttons to choose a Scale Preset to be edited.
- 3 Program the User Quarter Tone sub-scale.
 - In the left-side scale diagram, fine tune each note of the scale.

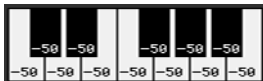

Detuning

-99 ... +99

Meaning

Note detuning in cents or a semitone. Zero is no detuning, ± 50 is a full quarter tone up or down, ± 99 is nearly one whole semitone up or down.

- In the right-side scale diagram, turn on (black dot shown) the scale degree you want to be detuned, and turn off (black dot hidden) the scale degree that will use the standard tuning.



When no preset is selected, a default scale is automatically recalled. This scale assigns a -50 cent value (equivalent to a quarter tone down) to all notes, and turns all scale degrees off.

Memorize the new Quarter Tone sub-scale into a Scale Preset

- 1 Choose the Write Quarter Tone SC Preset command from the page menu to open the Write Quarter Tone Scale Preset dialog.

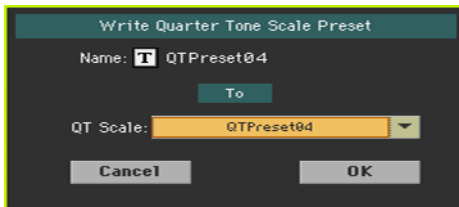

- 2 Touch the Text Edit (**T**) button if you want to assign the Scale Preset a new name.
- 3 Choose one of the Scale Preset locations to save the new scale, then confirm by touching the OK button.

Using the Quarter Tone sub-scales (Scale Presets)

You can instantly recall a Quarter Tone sub-scale, by just choosing one of the Scale Presets.

Activate the Quarter Tone sub-scale

- 1 Go to the Sub-Scale pane from the main page of the Style Play and Song Play modes.

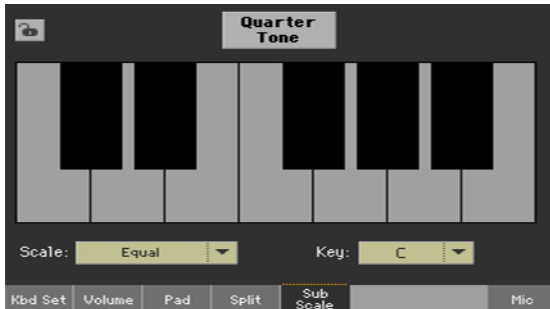

- 2 Touch the Quarter Tone button to make it appear selected. The Scale Preset buttons will appear.

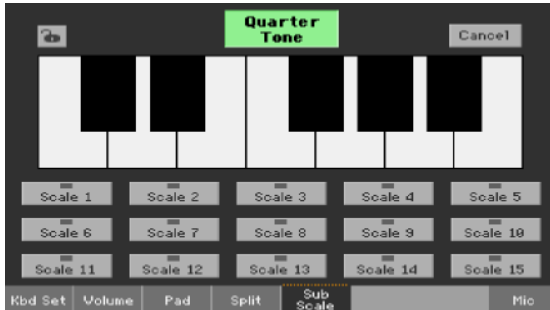

Choose a Scale Preset

- Touch one of the Scale Preset buttons to choose the corresponding Scale Preset.
The saved Quarter Tone sub-scale will be selected.
- Touch the same Scale Preset button to deactivate the selected scale.

Use the Quarter Tone sub-scale

- Touch any note whose pitch you want to lower, making a big dot appear on the note diagram.
- Touch the note again to make the dot disappear, and reset to standard tuning.

Scale alteration made in this page is momentary and is not memorised. It is only meant to allow for quick scale alteration while playing.

Deactivate the Quarter Tone sub-scale

- Touch the Quarter Tone button to make it appear deselected. The Scale Preset buttons will disappear. The main scale will be in use again.

Activating the Quarter Tone function by using a switch or footswitch

To make realtime changes faster, you can assign the Quarter Tone function to an assignable switch, a footswitch or an EC5 switch. This will make those sudden scale changes, typical of the Middle East/Arabic music, quick and easy.

Since these changes are not saved anywhere, the scale is easily 'wiped-out' when selecting a different Keyboard Set, or when pressing the Quarter Tone switch again.

Program the switch or footswitch to be the Quarter Tone switch

- Go to the **Style Play/Song Play > Pad/Switch > Switch** page, and assign the Quarter Tone function to one of the assignable switches.
- Go to the **Global > Controllers > Foot** page, and assign the Quarter Tone function to the footswitch.
- Go to the **Global > Controllers > EC5** page, and assign the Quarter Tone function to one of the EC5 switches.

Please note that programming an assignable switch will tie the Quarter Tone function to a particular Keyboard Set or SongBook Entry, dedicated to a particular Song. On the contrary, programming the footswitch or EC5 switch will offer a global option, that will not change when choosing a different Keyboard Set or SongBook Entry.

Use the Quarter Tone function

1 Lower some note pitches.

Keep the Quarter Tone switch or footswitch pressed. The keyboard will not play at this time. Press the notes whose pitch you want to lower. Release the switch or footswitch.

The black dots will appear in the keyboard diagram of the **Sub-Scale** pane from the main page of the **Style Play** and **Song Play** modes.

2 Play with your new scale. The pitch of the notes you pressed are now lowered.

3 Reset the original scale.

Press and release the Quarter Tone switch or footswitch again, without playing any note. All pitches will be reset, and the original scale will be recalled.

Choosing a Scale Preset by using a switch or footswitch

You can also select a Scale Preset by assigning the relevant function to the footswitch.

- Go to the **Style Play/Song Play > Pad/Switch > Switch** page, and assign the **SubScale Preset** function to one of the assignable switches.
- Go to the **Global > Controllers > Foot** page, and assign the **SubScale Preset** function to the footswitch.
- Go to the **Global > Controllers > EC5** page, and assign the **SubScale Preset** function to one of the EC5 switches.

Retuning the Style while playing

Style Element Scale, Chord Follow, Retune Style

While in the Style Record > Element Track Controls > Scale page, you can program a sub-scale for each Style Element, and enable the sub-scale on each track of the Style Element.

This scale starts from a root key, that can change with each recognized chord, or after a deliberate command. Depending on your style of music, you will choose how to retune the Style.

How you choose the scale's root key will depend on two concurrent parameters: the Chord Follow option inside the Style, and the Retune Style parameter assigned to an assignable switch, footswitch or EC5 switch.

Retune Style	Chord Follow	Scale's Root Key
-	On	From each recognized chord.
	Off	From the chord recognized when the accompaniment is not playing.
Assigned	On	From the chord recognized while the accompaniment is not playing, or after pressing the assignable switch.
	Off	

Enabling the Chord Follow option

- 1 Go to the Style Record > Element Track Controls > Scale page.



- 2 Use the Chord Follow checkbox to turn the option on or off. See the table above to see how it works.

While each Style Element can have its own scale, this option is common to all Style Elements in the Style.

Assigning the Retune Style command to an assignable switch, footswitch or EC5 switch

Assign the Retune Style command to an assignable switch

- 1 Go to the Style Play/Song Play > Pad/Switch > Switch page.
- 2 Use one of the Switch 1...3 menus to choose a command to be assigned to the corresponding switch. Since the first two switches are usually assigned to the Sound Controllers, we suggest you use Switch #3.
- 3 Write the changes to a Keyboard Set. Writing to the special MY SETTING Keyboard Set makes this setting available when turning the instrument on.
- 4 Be sure the lock is closed; this will leave the assignable switch functions unchanged when choosing different Keyboard Sets.

Assign the Retune Style command to a footswitch or EC5 switch

- 1 Go to the Global > Controllers > Foot or EC5 page.
- 2 Use the Function or one of the A...E menus to choose a command to be assigned to the corresponding switch.

Using the Retune Style command

When the Retune Style command is assigned to an assignable switch, footswitch or EC5 switch, use it to change the Style Element Scale's root key.

After choosing a Style, check the main page of the Style Play mode. If at least one of the Style Elements has a sub-scale assigned, and it is enabled on at least one of the tracks, the Key parameter will appear in the Style area.



Retune with an assignable switch

- 1 Just before having to retune the Style, press the assignable switch. The indicator will start flashing.
- 2 Play a chord in the chord recognition area. The root of the chord will be the new root of the scale. The indicator will stop flashing.

Retune with a footswitch or EC5 switch

- 1 Just before having to retune the Style, press the footswitch or EC5 switch.
- 2 Play a chord in the chord recognition area. The root of the chord will be the new root of the scale.

PART XIII: MIDI

53 Connecting MIDI devices

Introduction to MIDI

Ports, channels, messages

What is MIDI?

MIDI stands for Musical Instruments Digital Interface. This interface lets you connect two musical instruments, or a computer and various musical instruments.

From a software point of view, MIDI is a protocol that describes messages for playing notes and controlling them. It is sort of a grammar to let different instruments and computers speak the same language, and let the one tell the other what to do.

From a physical point of view, MIDI messages travel across the classic MIDI interface or the USB port, a modern connector replacing the MIDI ports with a single port and cable.

Pa4X can be connected to a Windows or Mac computer with no need of special software. However, for full and easy use of all its MIDI features, we suggest that you install the **KORG USB MIDI Driver**, a special software that you can download from our web site (www.korg.com).

Channels and messages

Basically, a MIDI or USB cable transmits 16 channels of data. Think to each MIDI channel as a TV channel: the receiver must be set on the same channel of the transmitter. The same happens with MIDI messages: when you send a Note On message on channel 1, it will be received on channel 1 only. This allows for multitimbricity: you can have more than one sound playing on the same MIDI instrument.

There are various messages, but here are the most commonly used:

MIDI Message	CC#	Meaning
Note On		This message instructs an instrument to play a note on a specific channel. Notes have both a name (C4 standing for the center C) and a number (60 being the equivalent for C4). A Note Off message is often used to say the note has been released. Together with the Note On message, a Velocity value is always sent. This value tells the instrument how loud the note must play.
Pitch Bend (PB)		You can generate this message acting on the joystick (X direction). The pitch is translated up or down.
Program Change (PC)		When you select a Sound, a Program Change message is generated on the channel. Use this message, together with Control Change 00 and 32, to remotely select Pa4X data from a sequencer or a master keyboard.
Control Change (CC)		This is a wide array of messages, controlling most of the instrument parameters. Some examples:
Bank Select MSB	00	This message pair is used to select a Sound Bank. Together with the Program Change message, they are used to select a Sound.
Bank Select LSB	32	
Modulation	01	This is the equivalent of pressing up the joystick. A vibrato effect is usually triggered on.
Volume	07	Use this controller to set the channel's volume.
Pan	10	This one sets the channel's position on the stereo front.
Expression	11	Use this controller to set the relative volume of tracks, with the maximum value matching the current setting of the CC07 control.
Damper Pedal	64	Use this controller to simulate the Damper pedal.

Tempo

Tempo is a global MIDI message, that is not tied to a particular channel. Each MIDI Song includes Tempo data.

Lyrics

Lyric Meta Events are intended to display text together with the music. Pa4X can read many of the available Lyrics format on the market.

MIDI standards

Standard MIDI Files

Standard MIDI Files (abbreviated as SMF) are a practical way of exchanging songs between different instruments and computers. Pa4X uses the SMF format as its default MIDI Song format, so reading a song from a computer, or saving a song that a computer software can read, is not a problem at all.

The internal Players are compatible with SMFs format 0 (all data in one track; it is the most common format) and 1 (multitrack). Pa4X can read SMFs in Song Play mode and modify/save them in Sequencer mode. It can save a Song in SMF format 0 from Sequencer mode.

When in Song Play mode, Pa4X can also display SMF lyrics and chord abbreviations in various formats available on the market.

Standard MIDI Files usually have the .mid or .kar filename extension.

The General MIDI standard

Some years ago, the musical instruments world felt a need for some further standardization. Then, the General MIDI Standard (GM) was born. This extension of the basic MIDI sets new rules for compatibility between instruments:

- A minimum of 16 MIDI channels was required.
- A basic set of 128 Sounds, correctly ordered, was mandatory.
- The Drum Kit had a standard order.
- Channel 10 had to be devoted to the Drum Kit.

Pa4X is compatible with the GM1 and GM2 standards.

The XG™ standard

Pa4X is compatible with the Sounds and Drum Kits of the XG standard.

Special MIDI channels

The Control channel

You can set a MIDI IN channel as the Control channel (in the **Global > MIDI > MIDI IN Channels** page), to select Styles, Keyboard Sets and SongBook Entries from an external device (see the Appendix for a list of messages corresponding to Pa4X's internal data). On this special channel you can also send controls to start/stop the Arranger and Players, and select the Style Elements (see later in this part).

A MIDI OUT channel set as the Control channel (set in the **Global > MIDI > MIDI OUT Channels** page) can be used to send messages when selecting SongBook Entries.

The Global channel

Any MIDI channel can be set as a Global channel (in the **Global > MIDI > MIDI IN Channels** page), and can simulate the Pa4X integrated keyboard. When Pa4X is connected to a master keyboard, transmission should take place over the Global channel of Pa4X.

MIDI messages received over a Global channel are affected by the status of the **SPLIT** button, as well as by the split point. Therefore, if the **SPLIT** button's indicator is lit up, notes arriving to Pa4X over this channel will be divided by the split point into the Upper (above the split point) and Lower (below the split point) parts.

Notes received on a Global channel are used for the chord recognition of the automatic accompaniment. If the **SPLIT** indicator is turned on, only the notes below the split point will be used.

The Chord 1 and Chord 2 channels

Two special Chord channels (programmed in the **Global > MIDI > MIDI IN Control** page) can be used to receive notes for chord recognition. These notes will be combined with the notes received on the special Global channel.

Contrary to the Global channel, the Chord channels are not affected by the split point. However, the status of the **SPLIT** button will change the way chords are recognized on the Chord channels:

Split status	Chord Recognition mode
On	Decided by the Chord Recognition parameter of the Global > Mode Preferences > Style page. You can play a single note to play a Major chord.
Off	Always Fingered or Expert, depending on the previous situation. You have to play at least three notes in order for the chord to be detected.

These two channels are especially useful for accordion players, that wish to assign a different Chord channel to the chords and the bass played with the left hand. This way, chords and bass will both contribute to the chord recognition for the automatic accompaniment.

Connecting via the MIDI interface

You can use the MIDI connectors to connect external controllers (master keyboard, MIDI guitar, wind controller, MIDI accordion...) or additional musical instruments (for example, your preferred piano expander).

You can also use the MIDI connector to connect a personal computer through a MIDI interface. However, you can use the USB port for a simpler connection.

- Use the **IN** connector to receive MIDI data from a controller or computer. Connect it to the other device's MIDI OUT port.
- Use the **OUT** connector to send MIDI data to another musical instrument or computer. Connect it to the other device's MIDI IN port.
- Use the **THRU** connector to send an exact copy of the data received on the IN connector. Use it to cascade Pa4X with other MIDI devices.

To know how to match Sounds and MIDI channels, see [Programming the MIDI channels](#) on page 896.

Connecting via the USB DEVICE port

The USB DEVICE port can be used for MIDI communication between Pa4X and a personal computer or tablet. Use a standard A-to-B USB cable to connect your instrument and computer. A dedicated software driver can be found in our [web site](#).

Installing the KORG USB MIDI Driver

KORG USB-MIDI Driver system requirements

Be sure your personal computer meets the requirements, as described in the documents accompanying the driver.

Copyright notice

Copyright to all software included in this product is the property of KORG Inc. The license agreement for this software is provided separately. You must read this license agreement before you install this software. Your installation of this software will be taken to indicate your acceptance of this agreement.

Installing the KORG USB-MIDI Driver on a Windows PC

Please connect Pa4X to the computer via an USB cable only after having installed the KORG USB-MIDI Driver Tools.

- 1 Double-click on KORG USB-MIDI Driver Tools Setup v.n.nn.exe to run the installer ('n.nn' meaning the version number).
- 2 Follow the instructions appearing on screen. At the end, the tools will be installed.
- 3 When installation is completed, connect the USB DEVICE port of your Pa4X to one of the USB ports of your Windows PC by using a standard A-to-B USB cable. The Auto Installer will immediately start.
- 4 When finished, the USB-MIDI driver will be installed, and Pa4X will be able to communicate with your computer via USB.

You can access the tools and manuals from the **Start** menu.

Installing the KORG USB-MIDI Driver on Mac OS X

- 1 Double-click on **KORG USB- MIDI Driver v.n.n.n.dmg** to open a virtual drive in the Finder ('n.n.n' meaning the version number).
- 2 Double-click on **KORG USB-MIDI Driver.pkg** to run the installer.
- 3 Follow the instructions appearing on screen.
- 4 When installation is completed, eject the virtual drive, and connect the **USB DEVICE** port of your Pa4X to one of the USB ports of your Mac by using a standard A-to-B USB cable.

How Pa4X is seen from a MIDI application

After installation, the following ports will be shown in your MIDI application among the other MIDI devices:

Device	Meaning
Pa4X KEYBOARD	This allows for reception of MIDI messages from Pa4X (keyboard and controllers) to the MIDI application running on the computer.
Pa4X SOUND	This allows for transmission of MIDI messages from the MIDI application running on the computer, to the internal tone generator of Pa4X.

Quick settings using MIDI Presets

Using the MIDI Presets

Connecting an instrument to a master keyboard, a personal computer or a tablet, usually requires some programming. To help you configure the MIDI channels, we have provided some MIDI Presets, that will automatically configure the MIDI parameters according to your needs.

Choosing a MIDI Preset

- 1 Go to the Global > MIDI > General Controls page.
- 2 Use the Midi Preset pop-up menu to choose one of the available MIDI Presets.

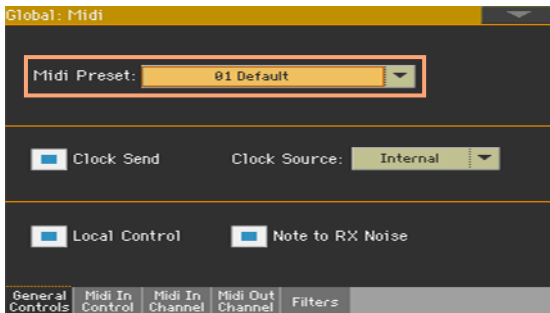

Parameter	Default	Master Kbd	Player 1	Player 2	
MIDI IN Channel	1	Ply 1 Tr 1	Global	Ply 1 Tr 1	Ply 2 Tr 1
	2	Ply 1 Tr 2	Control	Ply 1 Tr 2	Ply 2 Tr 2
	3	Ply 1 Tr 3	-	Ply 1 Tr 3	Ply 2 Tr 3
	4	Ply 1 Tr 4	-	Ply 1 Tr 4	Ply 2 Tr 4
	5	Ply 1 Tr 5	-	Ply 1 Tr 5	Ply 2 Tr 5
	6	Ply 1 Tr 6	-	Ply 1 Tr 6	Ply 2 Tr 6
	7	Ply 1 Tr 7	-	Ply 1 Tr 7	Ply 2 Tr 7
	8	Ply 1 Tr 8	-	Ply 1 Tr 8	Ply 2 Tr 8
	9	Ply 1 Tr 9	-	Ply 1 Tr 9	Ply 2 Tr 9
	10	Ply 1 Tr 10	-	Ply 1 Tr 10	Ply 2 Tr 10
	11	Ply 1 Tr 11	-	Ply 1 Tr 11	Ply 2 Tr 11
	12	Ply 1 Tr 12	-	Ply 1 Tr 12	Ply 2 Tr 12
	13	Ply 1 Tr 13	-	Ply 1 Tr 13	Ply 2 Tr 13
	14	Ply 1 Tr 14	-	Ply 1 Tr 14	Ply 2 Tr 14
	15	Ply 1 Tr 15	-	Ply 1 Tr 15	Ply 2 Tr 15
	16	Ply 1 Tr 16	-	Ply 1 Tr 16	Ply 2 Tr 16
MIDI OUT Channel	1	Upper 1	Upper 1	Ply 1 Tr 1	Ply 2 Tr 1
	2	Upper 2	Upper 2	Ply 1 Tr 2	Ply 2 Tr 2
	3	Upper 3	Upper 3	Ply 1 Tr 3	Ply 2 Tr 3
	4	Lower	Lower	Ply 1 Tr 4	Ply 2 Tr 4
	5	-	-	Ply 1 Tr 5	Ply 2 Tr 5
	6	-	-	Ply 1 Tr 6	Ply 2 Tr 6
	7	-	-	Ply 1 Tr 7	Ply 2 Tr 7
	8	-	-	Ply 1 Tr 8	Ply 2 Tr 8
	9	-	-	Ply 1 Tr 9	Ply 2 Tr 9
	10	-	-	Ply 1 Tr 10	Ply 2 Tr 10
	11	-	-	Ply 1 Tr 11	Ply 2 Tr 11
	12	-	-	Ply 1 Tr 12	Ply 2 Tr 12
	13	-	-	Ply 1 Tr 13	Ply 2 Tr 13
	14	-	-	Ply 1 Tr 14	Ply 2 Tr 14
	15	-	-	Ply 1 Tr 15	Ply 2 Tr 15
	16	-	-	Ply 1 Tr 16	Ply 2 Tr 16
MIDI IN Oct. Trp.	On	On	On	On	
MIDI IN Track Mute	-	On	-	-	

Parameter		Accordion 1	Accordion 2	Accordion 3	Tablet
MIDI IN Channel	1	Global	Upper 1	Upper 1	-
	2	Lower	Lower	Lower	-
	3	Bass	-	Bass	-
	4	-	Upper 2	Upper 2	-
	5	-	Upper 3	Upper 3	-
	6	-	-	-	-
	7	-	-	-	-
	8	-	-	-	-
	9	-	Bass	-	-
	10	Drum	Drum	Drum	-
	11	Percussion	Percussion	Percussion	-
	12	Acc 1	Acc 1	Acc 1	-
	13	Acc 2	Acc 2	Acc 2	-
	14	Acc 3	Acc 3	Acc 3	-
	15	Acc 4	Acc 4	Acc 4	-
	16	Acc 5	Acc 5	Acc 5	Control
MIDI OUT Channel	1	Upper 1	Ply 1 Tr 1	Ply 1 Tr 1	-
	2	Upper 2	Ply 1 Tr 2	Ply 1 Tr 2	-
	3	Upper 3	Ply 1 Tr 3	Ply 1 Tr 3	-
	4	Lower	Ply 1 Tr 4	Ply 1 Tr 4	-
	5	-	Ply 1 Tr 5	Ply 1 Tr 5	-
	6	-	Ply 1 Tr 6	Ply 1 Tr 6	-
	7	-	Ply 1 Tr 7	Ply 1 Tr 7	-
	8	-	Ply 1 Tr 8	Ply 1 Tr 8	-
	9	-	Ply 1 Tr 9	Ply 1 Tr 9	-
	10	-	Ply 1 Tr 10	Ply 1 Tr 10	-
	11	-	Ply 1 Tr 11	Ply 1 Tr 11	-
	12	-	Ply 1 Tr 12	Ply 1 Tr 12	-
	13	-	Ply 1 Tr 13	Ply 1 Tr 13	-
	14	-	Ply 1 Tr 14	Ply 1 Tr 14	-
	15	-	Ply 1 Tr 15	Ply 1 Tr 15	-
	16	-	Ply 1 Tr 16	Ply 1 Tr 16	Control
MIDI IN Oct. Trp.	On	On	On	On	
MIDI IN Track Mute	-	-	-	On	

You will use the supplied MIDI Presets in the following cases:

MIDI Preset	Use
Default	Generic settings, good for most situations
Master Kbd	When connecting to an external master keyboard
Player 1	When using an external sound generator (an expander or a virtual instrument) driven by either Player 1 or Player 2
Player 2	
Accordion 1	Different configurations for connecting a MIDI accordion.
Accordion 2	
Accordion 3	
Tablet	When connecting to a tablet

Editing the MIDI Presets

Editing a MIDI Preset

- 1 Choose a MIDI Preset containing programming similar to what you want to achieve.
- 2 While in the Global > MIDI pages, edit the various parameters.

MIDI Presets can be considered as a starting point that can be freely tweaked. Once you have selected the most appropriate MIDI Preset for the connection to be made, you can modify the parameters as needed.

The parameters that will be saved to a MIDI Preset are the ones shown in the above table.

Writing a MIDI Preset

Open the Write Midi Preset dialog

- 1 Go to the any page of the Global > MIDI section.
- 2 Choose the Write Midi Preset command from the page menu to open the Write Midi Preset dialog.

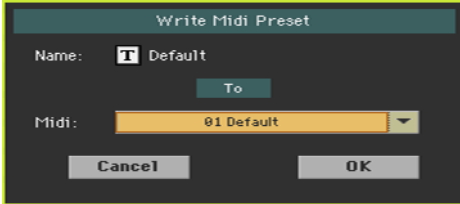

Write over the current MIDI Preset

- If you want to overwrite the current Preset, just touch the OK button.

Write to a different MIDI Preset location

- 1 If you want to choose a different location, use the Midi Preset pop-up menu.
- 2 If you want to change the name of the MIDI Preset, touch the Text Edit (**T**) icon to open the virtual keyboard and edit the name.
- 3 When done editing the name, confirm by touching the OK button under the virtual keyboard.
- 4 When back at the Write Midi Preset dialog, confirm the Write operation by touching the OK button.

Synchronizing Tempo with other instruments

Sending the MIDI Clock

The Arranger or the selected MIDI Song can send a synchronization message to the other devices.

- 1 Go to the Global > MIDI > General Controls page.

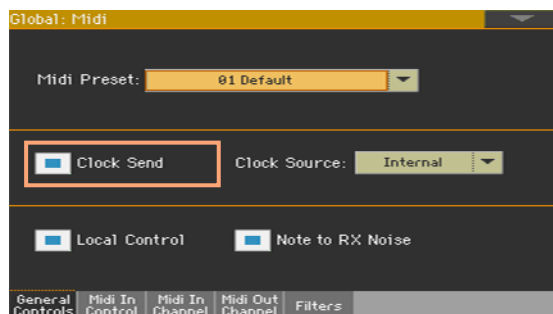

- 2 Select the Clock Send parameter to send the internal MIDI Clock to the MIDI IN and USB ports.

When the MIDI Clock signal is sent, you can slave another instrument to the Pa4X Tempo, Start/Stop and Play/Stop commands.

This parameter is automatically deactivated each time the instrument is turned on.

Receiving the MIDI Clock

In Style Play, Sequencer or Sound mode, you can receive synchronization messages from the internal Arranger or Player, or from an external device.

In Song Play mode, the MIDI Clock is always generated by the internal Players. While in this mode, Pa4X cannot receive MIDI Clock messages from another device.

- 1 Go to the Global > MIDI > General Controls page.

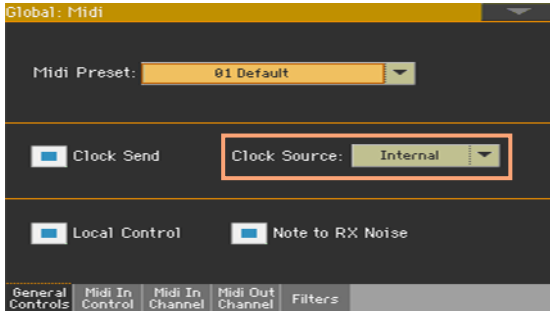

- 2 Use the Clock Source pop-up menu to choose a MIDI Clock source for the Style Play and Sequencer modes.

Clock Source	Meaning
Internal	MIDI Clock is generated by the Pa4X's Arranger or Players internal metronome. When in Song Play mode, the Internal clock is always used.
External MIDI	MIDI Clock is received from the MIDI IN or USB port. In Style Play or Sequencer mode, Pa4X is slaved to an external device. The Start/Stop and Play/Stop commands, as well as the Tempo value, cannot be selected from Pa4X. Use the external device to set the Tempo and Start or Stop the Arranger or Players.
External USB	

This parameter is automatically set to Internal each time the instrument is turned on.

MIDI data routing, processing and transposing

Connecting the keyboard to the internal or external sounds

The 'local' controls (keyboard, physical controllers) can be connected to the internal sounds directly, or echoed back from an external device.

- 1 Go to the Global > MIDI > General Controls page.
- 2 Use the Local Control On parameter to connect or disconnect the keyboard and controllers to the internal sounds.

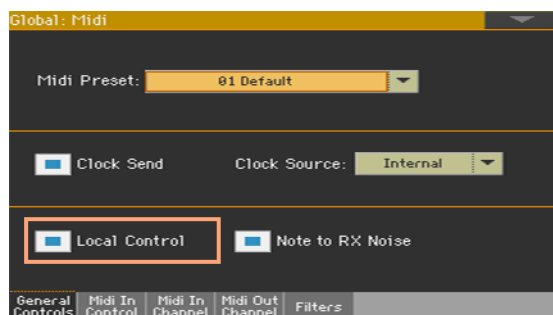

Local Control	Meaning
On	When you play the keyboard, MIDI data are sent to the internal sound generator. If Sounds are assigned to a MIDI OUT channel, data are also sent to the MIDI OUT and USB ports.
Off	The keyboard is connected to the MIDI OUT and USB ports, but cannot play the internal sound generator. This is very useful when working with an external sequencer, to send notes and various MIDI messages from the integrated keyboard and controllers to the external sequencer, and then let the sequencer send them back to the sound generator, without overlapping and MIDI echo effects.

This parameter is automatically activated each time the instrument is turned on.

Converting notes to RX Noises

RX Noises are special ambience or mechanical sounds that allow Sounds to be more realistic. They are usually located above C7, depending on the Sound.

- 1 Go to the Global > MIDI > General Controls page.
- 2 Select the Note to RX Noise checkbox to convert incoming notes to RX Noises.

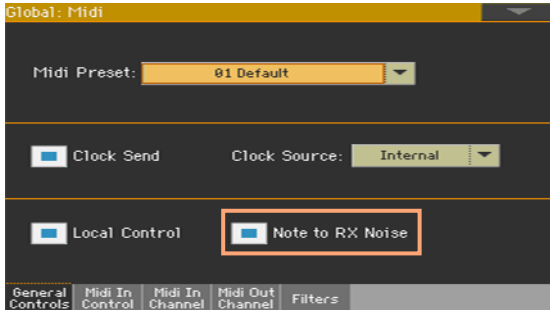

When this parameter is turned on, notes received from the MIDI IN or USB ports, or performed by the internal Players, in the RX Noises range, are recognized and converted to RX Noises.

This parameter is automatically activated each time the instrument is turned on.

Transposing the notes received

Applying master and octave transposition to the notes received

- 1 Go to the Global > Tuning > Transpose Control page.
- 2 Use the Mode > Midi In Notes checkbox to determine if notes received on the MIDI IN and USB ports have to be transposed.

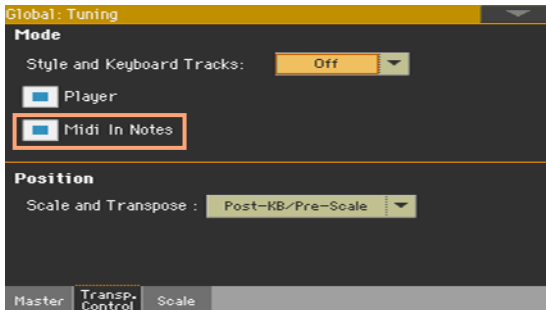

Midi In Transpose	Meaning
On	Notes received on the MIDI IN and USB ports are transposed according to the Master Transpose.
Off	Data received on the MIDI IN and USB ports are not transposed.

Applying octave transposition to the notes received

- 1 Go to the Global > MIDI > MIDI IN Controls page.
- 2 Use the Octave Transpose checkbox to determine if notes received on the MIDI IN and USB ports have to be octave-transposed.

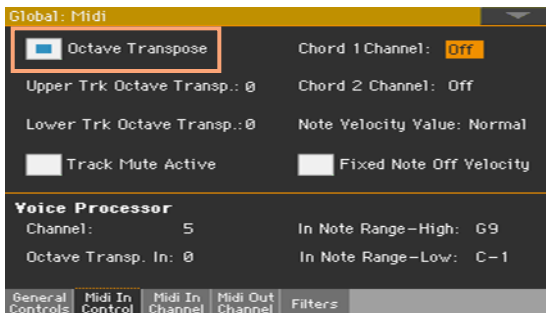

Midi In Octave	Meaning
On	Notes received on the MIDI IN and USB ports are transposed according to the Octave Transpose setting for each Sound.
Off	Data received on the MIDI IN and USB ports are not transposed.

Applying octave transposition to the Upper and Lower parts

- 1 Go to the Global > MIDI > MIDI IN Controls page.
- 2 Use the Upper Trk Octave Transp. and Lower Trk Octave Transp. parameters to transpose the MIDI notes received on the Upper and Lower parts.

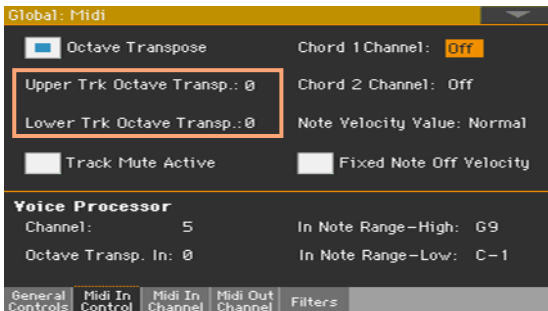

Upper/Lower Octave	Meaning
-2...0...+2	Notes received on the MIDI IN and USB ports are transposed by the number of selected octaves. For example, if you select the +1 value, a C4 received via MIDI will play a C5 on Pa4X.

These parameters may be useful to many MIDI accordion players, whose MIDI interface may be transmitting on an unexpected octave.

Playing muted tracks via MIDI

- 1 Go to the Global > MIDI > MIDI IN Controls page.
- 2 Use the Track Mute Active checkbox to determine if notes received on the USB port will play on muted tracks.

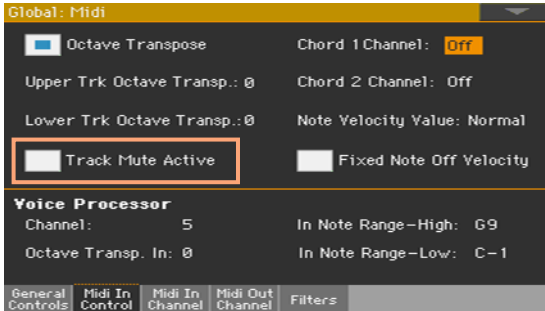

Track Mute Active	Meaning
On	No received MIDI data can play on muted tracks.
Off	Received MIDI data can play on muted tracks.

Choosing a fixed velocity value for the incoming notes

You can set a fixed velocity value for the notes received from MIDI.

- 1 Go to the Global > MIDI > MIDI IN Controls page.

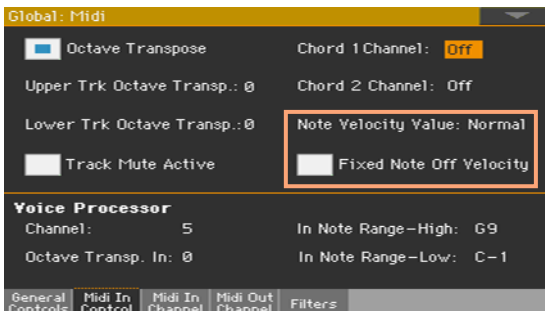

- 2 Use the **Midi In Velocity Value** parameter to set a fixed Note On velocity value for all the notes received via MIDI. This is useful when playing Pa4X with an organ or a MIDI accordion, often sending a fixed velocity value.

Midi In Velocity	Meaning
Normal	Received velocity values are left unchanged.
40 ... 127	All received velocity values are converted to the selected value.

- 3 Use the **Fixed Note Off Velocity** parameter to set a fixed Note Off velocity value for all the notes received via MIDI. This is useful when playing Pa4X with a controller sending a too high Note Off velocity value (usually 64).

Programming the MIDI channels

Programming the MIDI IN channels

- 1 Go to the Global > MIDI > MIDI IN Channels page.

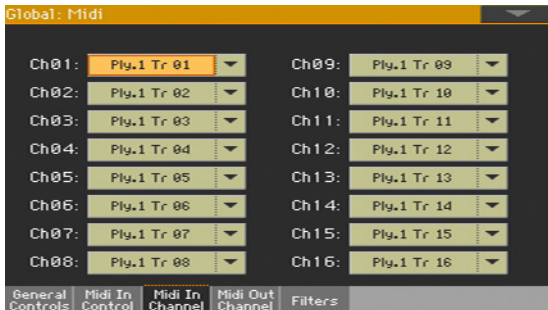

- 2 Use the Channel pop-up menus to assign an instrument's track to each MIDI channel.

Track	Meaning
Off	Nothing assigned
Lower	Keyboard's Lower Sound
Upper 1...3	One of the Keyboard's Upper Sounds
Pad 1...4	One of the Pad Sounds
Drum	Style's Drum Sound
Percussion	Style's Percussion Sound
Bass	Style's Bass Sound
Acc 1...5	One of the Style's Accompaniment Sounds
Ply 1/2 Tr 01...16	One of the Players' tracks (Sounds).
Global	Special channel to simulate Pa4X's integrated controllers (keyboard, pedals, joystick) with an external keyboard or controller. MIDI messages coming on this channel are seen as if they were generated by Pa4X's integrated controllers.
Control	On this special channel, Pa4X receives MIDI messages to remotely select Keyboard Sets, Styles, Style Elements and SongBook Entries. See the tables in the Appendix, and later in this chapter, for more information about the data received.

Programming the MIDI OUT Channels

- 1 Go to the Global > MIDI > MIDI OUT Channels page.



- 2 Use the Channel pop-up menus to assign an instrument's track to each MIDI channel.

Track	Meaning
Off	Nothing assigned
Lower	Keyboard's Lower Sound
Upper 1...3	One of the Keyboard's Upper Sounds
Pad 1...4	One of the Pad Sounds
Drum	Style's Drum Sound
Percussion	Style's Percussion Sound
Bass	Style's Bass Sound
Acc 1...5	One of the Style's Accompaniment Sounds
Ply 1/2 Tr 01...16	One of the Players' tracks (Sounds).
Chord	Use this channel to send notes recognized by the Chord Recognition engine to the MIDI OUT or USB port. This is useful, for example, to control an external Harmonizer playing on the Lower part (even if the part is muted).
Control	On this special channel, Pa4X sends messages corresponding to the selected SongBook Entry.

Filtering out MIDI messages

You can set up to eight filters for the MIDI data received or sent. Filters are applied to all MIDI channels at the same time.

- 1 Go to the Global > MIDI > Filters page.



- 2 Use the Midi In Filters pop-up menus to choose filters on the data received.
- 3 Use the Midi Out Filters pop-up menus to choose filters on the data sent.

Filter	Meaning
Off	No filter
Pitch Bend	Pitch Bend
MonoTouch	Mono (or Channel) After Touch
PolyTouch	Poly After Touch
PrgChange	Program Change
SysExcl	System Exclusive
All CC	All Control Change messages
0 ... 127	Control Change message #0...127. See the Appendix for a list of available Control Change messages.
Notes	Note events

Programming the special Chord channels

- 1 Go to the Global > MIDI > MIDI IN Controls page.
- 2 Use the Chord 1 Midi Channel and Chord 2 Midi Channel parameters to assign the special Chord channels to a MIDI channel.

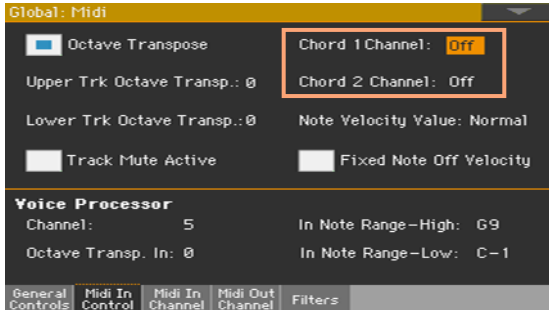

Chord channel	Meaning
Off	Special Chord channel not activated.
1...16	Assigned Chord channel. Two special Chord channels can be used to receive notes for chord recognition. These notes will be combined with the notes that go through the channel set as Global (Global notes are recognized only under the split point, if the SPLIT indicator is lit up).

Connecting Pa4X to a personal computer or tablet

You can program a new song on a personal computer or tablet connected to Pa4X. The computer has to run some sequencing or notation software. When a song is ready, you can transfer it to the internal drive of Pa4X, and read it with the internal Players.

Connection and settings

- 1 Install the KORG USB MIDI Driver, as explained earlier in this part.
- 2 Connect Pa4X and the computer or tablet via the **USB DEVICE** port.
- 3 On the computer, activate the **MIDI Thru** function (please refer to the software's user manual).
- 4 On Pa4X, go to the **Global > MIDI > General Controls** page and choose the **External Sequencer** or **Tablet MIDI Preset**.
- 5 Still in the **Global > MIDI > General Controls** page, deselect the **Local Control On** checkbox to set the instrument to the **Local Off** status.
- 6 Press the **SEQUENCER** button to go to the **Sequencer** mode.
- 7 Play the keyboard.

Notes played on the keyboard will go from the USB port of Pa4X to the USB port of the computer or tablet. Notes generated by the computer are sent from the USB port of the computer to the USB port of Pa4X.

The Sounds

The song that is played back by the sequencer can select Pa4X Sounds through the MIDI messages **Bank Select MSB**, **Bank Select LSB** (bank selection, two messages), and **Program Change** (Sound selection). See the list of Sounds and corresponding MIDI values in the Appendix.

As a hint for those who program songs on computer: even though it is not mandatory, for a wider compatibility you should set bass on channel 2, melody on channel 4, drum kit on channel 10, controls for an harmonizer on channel 5.

Control Change messages

The following is a table including all Control Change messages, and their effect on various functions of the instrument. Note that not all controllers are available in all operative modes.

CC#	CC Name	Pa4X Function
0	Bank Select	Sound selection
1	Modulation 1 (Y+)	Joystick forward
2	Modulation 2 (Y-)	Joystick backward
3	Undefined controller	
4	Foot controller	
5	Portamento time	
6	Data entry	
7	Volume	Track volume
8	Balance	
9	Undefined controller	
10	Pan Pot	Track panning
11	Expression	Expression
12	FX controller 1	CC#12
13	FX controller 2	CC#13
14-15	Undefined controller	
16	Gen.pc.1	
17	Gen.pc.2	
18	Slider	
19	Gen.pc.4	
20-31	Undefined controller	
Control Change #32-63 are the LSB (Least Significant Byte) of Control Change #0-31, i.e. the MSB (Most Significant Byte), and are changed according to their MSB counterparts.		
64	Damper	Damper pedal
65	Portamento	
66	Sostenuto	Sostenuto pedal
67	Soft	Soft pedal
68	Legato	
69	Hold 2	
70	Sustain level	
71	Filter Resonance Hp	Filter resonance

CC#	CC Name	Pa4X Function
72	Release	Release time
73	Attack	Attack time
74	Filter cutoff	Filter cutoff (Brilliance)
75	Decay Time	Decay time
76	Lfo1 Speed	Vibrato speed
77	Lfo1 Dpt	Vibrato depth
78	Lfo1 Dly	Vibrato initial delay
79	FilterEgp	
80	Gen.pc.5	Sound Controller 1
81	Gen.pc.6	Sound Controller 2
82	Gen.pc.7	
83	Gen.pc.8	
84	Portamento control	
85-90	Undefined controller	
91	FX 1 depth	A/B Master FX 1 (reverb) send level
92	FX 2 controller	
93	FX 3 depth	A/B Master FX 2 (modul.) send level
94	FX 4 controller	
95	FX 5 controller	
96	Data Increment	
97	Data Decrement	
98	NRPN LSB	See table below(*)
99	NRPN MSB*	See table below(*)
100	RPN LSB	See MIDI Implementation Chart
101	RPN MSB	See MIDI Implementation Chart
102-119	Undefined controller	
120	AllSOff	
121	Res Ctl	Reset All Controllers
122	LocalCt	
123	NoteOff	
124	OmniOff	
125	Omni On	
126	Mono On	
127	Poly On	

(*) The following NRPN messages are recognized in Song Play and Sequencer mode only. These controls are reset when stopping a Song, or choosing a different Song.

NRPN	CC#99 (MSB)	CC#98 (LSB)	CC#06 (Data Entry)
Vibrato Rate	1	8	0...127
Vibrato Depth	1	9	0...127 ^(a)
Vibrato Decay	1	10	0...127 ^(a)
Filter Cutoff	1	32	0...127 ^(a)
Resonance	1	33	0...127 ^(a)
EG Attack Time	1	99	0...127 ^(a)
EG Decay Time	1	100	0...127 ^(a)
EG Release Time	1	102	0...127 ^(a)
Drum Filter Cutoff	20	dd	0...127 ^(a)
Drum Filter Resonance	21	dd ^(b)	0...127 ^(a)
Drum EG Attack Time	22	dd ^(b)	0...127 ^(a)
Drum EG Decay Time	23	dd ^(b)	0...127 ^(a)
Drum Coarse Tune	24	dd ^(b)	0...127 ^(a)
Drum Fine Tune	25	dd ^(b)	0...127 ^(a)
Drum Volume	26	dd ^(b)	0...127
Drum Panpot	28	dd ^(b)	0...127 ^(a)
Drum Rev Send (FX 1)	29	dd ^(b)	0...127 ^(a)
Drum Mod Send (FX 2)	30	dd ^(b)	0...127 ^(a)
Drum Send #3 (FX 3)	31	dd ^(b)	0...127 ^(a)

(a). 64 = No change to the original parameter's value

(b). dd = Drum Instrument No. 0...127 (C0...C8)

(*) The following NRPN messages are recognized in Style Play and Song Play mode only.

NRPN	CC#99 (MSB)	CC#98 (LSB)	CC#06 (Data Entry)
SongBook Entry	2	64	0...99

Controlling the Arranger and Players via MIDI

You can remotely control the Arranger and Players via MIDI. Please note that the Program Change and Control Change numbers shown in this page follow the 0-127 numbering system.

Selecting the Style Elements

You can remotely select the various Style Elements, by sending Program Change messages on the Control channel.

PC	Style Element	PC	Style Element	PC	Style Element	PC	Style Element
80	Intro 1	81	Intro 2	82	Intro 3/Count In	83	Variation 1
84	Variation 2	85	Variation 3	86	Variation 4	87	Fill 1
88	Fill 2	89	Fill 3	90	Fill 4	91	Break
92	Ending 1	93	Ending 2	94	Ending 3		

Selecting the Style and Player controls

You can remotely send various commands to the Arranger or Players, by sending them Program Change messages on the Control channel.

PC	Control	PC	Control	PC	Control
95	Fade In/Out	96	Style to Kbd Set	97	Auto Fill
98	Memory	99	Bass Inversion	100	Manual Bass
101	Tempo Lock	103	Start/Stop (Arranger)	104	Play/Stop (Player 1)
105	Play/Stop (Player 2)				

Selecting the Keyboard Sets (from a Style or SongBook Entry)

You can remotely select the Keyboard Sets of a Style or SongBook Entry (buttons under the display).

- With Styles, you will send Bank Select MSB (CC#0), Bank Select LSB (CC#32) and Program Change messages on the Control channel. If a Style is already selected, just send the Program Change message.

CC00	CC32	PC	KBD	PC	KBD	PC	KBD	PC	KBD
The same as the Style to which the Keyboard Set belongs	64	KBD SET 1	65	KBD SET 2	66	KBD SET 3	67	KBD SET 4	

- With SongBook Entries, you will first choose an Entry. First send (on the Control channel) an initialization string, made of the NRPN Control Change messages #99 (MSB, with value 2) and #98 (LSB, with value 64) in fast succession. Then send a selection string, made of the two Control Change messages CC#06 (Data Entry MSB) for the thousands and hundreds, and CC#38 (Data Entry LSB) for the tens and units.

After having selected the Entry, you will send a Program Change messages corresponding to the Keyboard Set (again on the Control channel). If a SongBook Entry is already selected, just send the Program Change message.

CC99/98	CC06/38	PC	KBD	PC	KBD	PC	KBD	PC	KBD
The same as the SongBook Entry to which the Keyboard Set belongs	64	KBD SET 1	65	KBD SET 2	66	KBD SET 3	67	KBD SET 4	

PART XIV: FILE MANAGEMENT

54 Managing files in the internal memory

Copying, renaming and deleting

Copying musical data

You can copy any Keyboard Set, Sound, Style, Pad, Voice or Guitar Preset onto a Favorite/User/Direct location. Copying Factory data onto Favorite/User/Direct locations would make them editable.

If you want to overwrite Factory data, remove protection by unchecking the Protect > Factory parameter in the Global > Media Preferences page.

- 1 Open the Keyboard Set Library, Sound, Style, Pad, or Voice Preset Select window.
- 2 Browse through the items in the Select window.

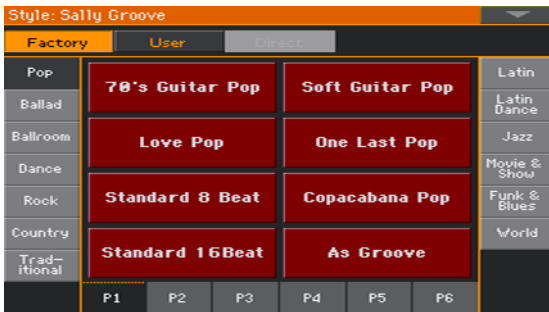

- 3 Touch the name of the item you want to copy.
 - To select more items, keep the SHIFT button pressed and touch all the items to be copied.
 - If you want to copy a whole bank, choose the Select All (Bank) command from the page menu to select all the items in the current bank.
 - You can deselect one of the selected items by touching it while still keeping the SHIFT button pressed. You can deselect all items by touching a single item.

- 4 Choose the **Copy and Paste** command from the page menu to copy the selected items.
- 5 Select the **target location**. In case you are copying more than a single item, all subsequent items will sequentially follow the first one. If there aren't enough locations available, the procedure will be cancelled.

Warning: If you confirm, any item already existing at the target locations will be overwritten!

A good idea is to paste to a blank location, identified by a series of dashes (---).



- 6 When done, press the **EXIT** button to return to the previous page.

Renaming musical data

You can change the name of any Keyboard Set, Sound, Style, Pad, or Voice Preset. If Factory data are protected, remove protection by unchecking the **Protect > Factory** checkbox in the **Global > Media Preferences** page.

Please note that you cannot rename multiple items at once.

- 1 While in the **Keyboard Set Library, Sound, Style, Pad, or Voice Preset Select** window, select the item to be renamed.
- 2 Choose the **Rename** command from the page menu to open the virtual keyboard.
- 3 Edit the name, then confirm by touching **OK**.

Deleting musical data

You can delete any Keyboard Set, Sound, Style, Pad, Voice or Guitar Preset. If Factory data are protected, remove protection by unchecking the **Protect > Factory** parameter in the **Global > Media Preferences** page.

- 1 While in the **Keyboard Set Library, Sound, Style, Pad, or Voice Preset Select** window, select the item to be deleted.
- 2 Choose the **Delete** command from the page menu, then confirm.

Warning: If you confirm, any of the selected item will be deleted!

The Direct Styles, Keyboard Sets, SongBook

Direct data are additional Keyboard Sets, Styles and SongBook Entries and Set Lists, residing in a storage device like the internal drive or a removable USB drive. They can be considered as an extension of the internal memory.

Direct Keyboard Sets and Styles are immediately accessed when pressing the USER/DIRECT button in the STYLE or KEYBOARD SET LIBRARY area, or by selecting the Direct type of data while in the Keyboard Set Library Select or Style Select window.

Direct SongBook Entries and Set Lists are automatically mixed with the internal Entries and Set Lists, making a more extensive database.

You can choose any standard SET folder as the Direct folder.

Selecting the Direct folder

A Direct folder has to be selected before being used.

- 1 Connect the external storage device containing the Direct data.
- 2 Go to the Global > Mode Preferences > Media page.

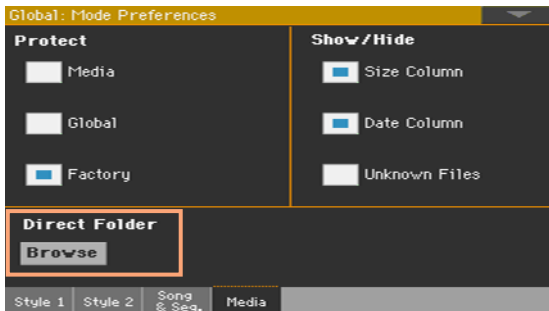

- 3 Touch the Direct Folder > Browse button to open the file selector.

- Browse through the drives and folders, and select the SET folder to be used as the Direct set of banks.

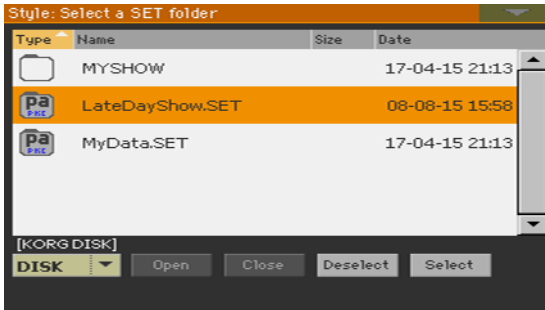

- Touch the Select button to confirm.

Please note that you can only have a single Direct folder of Keyboard Sets, Styles, SongBook.

- If you select a folder from a different Pa-Series instrument, you are asked if you want to convert the data to a format that Pa4X can read. If you confirm, you are prompted to choose a name and position for the new SET folder. (If you touch Cancel, no Direct folder is selected).
- When done, go to a Select window, and see how the Direct type of data can be selected from the tabs on top of the list.



The Direct SongBook Entries and Set Lists will be automatically added to the internal Entries and Set Lists.

Deselecting the Direct folder

To speed up selection of the User banks, and avoid the USER/DIRECT button to cycle one step more to access the Direct data, deselect the Direct banks.

- 1 While in the Global > Mode Preferences > Media page, touch the Direct Folder > Browse button to open the file selector.

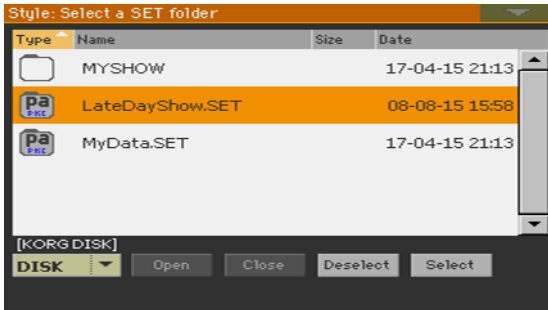

- 2 Touch the Deselect button to remove any assignment.

Creating the Direct Keyboard Set and Style banks

Load Keyboard Sets or Styles into the Direct locations

- While in the Media > Load page, you can load any Keyboard Set or Style into the Direct banks.

Copy & paste onto Direct locations

- While in the Keyboard Set Library Select or Style Select window, choose the Copy and Paste command from the page menu, to copy & paste any Keyboard Set or Style into the Direct banks.

Save a Keyboard Set or Style into a Direct location

- After editing the Keyboard Sounds, choose the Write Kbd Set to Library command from the page menu, and write the Keyboard Set onto the Direct banks.
- While in Style Record, choose the Write Style command from the page menu, and write the new or edited Style onto the Direct banks.

Creating the Direct SongBook

- While in the Media > Save page, save a SongBook into a new SET folder, and move it to a storage device.

Using the Direct Keyboard Sets and Styles

- When choosing a Style or Keyboard Set from the library, press the **USER/DIRECT** button a second time to make the Direct type of banks appear.

As an alternative, touch the Direct type button on top of the list in a Style Select or Keyboard Set Library Select window.

Using the Direct SongBook

Selecting Entries and Set Lists

The Direct SongBook Entries and Set Lists are mixed with the internal SongBook Entries and Set Lists. They appear as a single extended database.

Creating or deleting Entries and Set Lists

When creating or deleting Entries or Set Lists, you are asked to choose whether you want to save it into the internal or external SongBook.

Renaming the Favorite/User/Direct banks

You can rename the User/Favorite and Direct User/ Favorite banks, to create your own sets of Keyboard Sets, Styles or Pads.

- 1 Open the Keyboard Set, Style, or Pad Select window, and select the User or Direct type of data.



- 2 Choose the Rename User Banks command from the page menu to open the Rename User Banks dialog.



- 3 Assign the User/Favorite or Direct User/Favorite tabs any name you like.

Touch the Text Edit (**T**) icon next to the bank to be renamed, and use the virtual keyboard to edit the name. When done, touch OK to confirm.

The assigned name can be spanned over two lines, by separating them with the paragraph character (¶). For example, to write “World Music” on two lines, enter “World¶Music”.

Be careful not to write words exceeding the width of the side tabs of the Keyboard Set Library Select or Style Select window.

- 4 When back at the Rename User Banks dialog, confirm the operation by touching the OK button.

55 Managing files

Overview on file management

You can access the Media pages by pressing the MEDIA button. Media pages are where you manage files and storage devices.

Media page structure

Most Media pages share some basic elements.

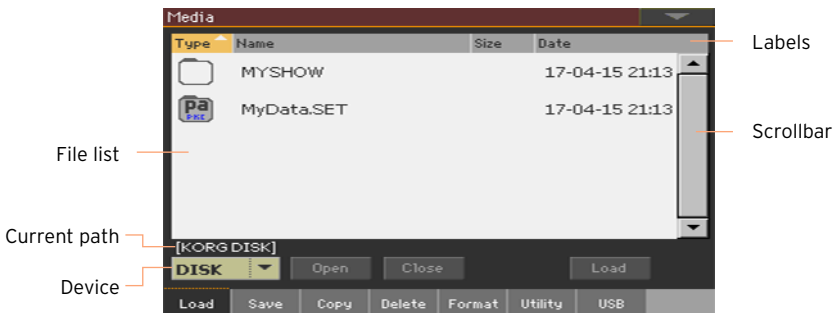

Browsing through the files

You can see the files and folders in the center of the Media pages.

- Scroll the file list by using the scrollbar.
- Open the selected folder by touching the Open button.
- Close the open folder by touching the Close button.

Selecting and deselecting files

- Select a file or folder by touching it.
- Deselect it by touching an empty area in the file list, or by touching the Device pop-up menu, and choosing the current device again.

Changing the list view

You can touch one of the labels on top of the file list to change the order in which files are shown. For example, by touching the Name label, the list is alphabetically re-ordered according to the file names. The selected label appears highlighted, showing the currently selected ordering.

Type	Name	Size	Date
MIDI	My MIDI Song.mid	22K	23-09-03 14:5
JBX	MyJbxList.JBX	58	18-12-10 00:5

If you touch the highlighted label again, the alphabetic order changes from ascending to descending, or vice-versa. The small arrow next to the label name shows the selected order.

Current path

The place in the drive you are currently exploring is always shown under the file list.

```
[KORG DISK]\STARTUP\ALL\STYLE\Bank15.sty
```

Selecting a storage device (drive)

A device can be selected by using the Device pop-up menu, shown in the lower left corner of most Media pages:

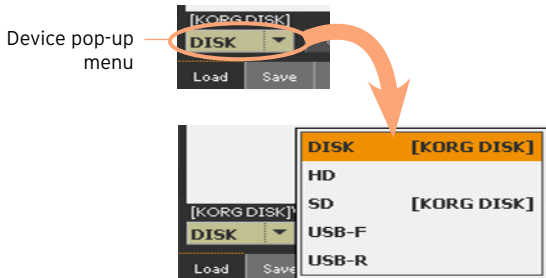

Supported device

Pa4X supports external devices, like hard disks or USB memory sticks, formatted in FAT16 or FAT32 with long file names. NTFS (Windows NT/2000/XP/Vista/7/8/8.1/10), HFS (Mac OS 9) and HFS+ (Mac OS X) formats are not supported.

You can access the following mass storage device types:

Device	Type
DISK	Main internal drive
HD	Secondary internal drive (optional in Pa4X-61)
SD	Optional internal microSD
USB-F	Optional device connected to the front (F) USB HOST port
USB-R	Optional device connected to the rear (R) USB HOST port

Types of files

The following table describes all the file and folder types Pa4X can read or write.

Extension	File/folder type
SET	All the User data. This is a reserved folder containing other reserved folders.
BKP	Backup file, created with the Full Resource Backup function of the Media > Utility page
GBL	Global Setup
VOC	Voice Preset
MXP	MaxxAudio Preset
QTP	Quarter Tone Scale Presets
MPR	MIDI Presets
PRF	Keyboard Set (from the library)
PCG	Sound (KORG Pa-Series)
KMP	Multisample
PCM	Sample
AIF	AIFF audio files
WAV	WAVE audio files
STY	Style
PAD	Pad
SBD	SongBook
SBL	SongBook's Set List
JBX	Jukebox
MID	Standard MIDI File, SMF (MIDI Song)

Extension	File/folder type
MP3	MP3 file (MP3 Song)
TXT	Plain text file

Pa4X can also read (but not write) the following types of data.

Extension	File type
PKG	Operating System and Musical Resource files
KAR	Karaoke file
CDG	CD+Graphics file
PCG	KORG Triton Programs
KSF	Korg Trinity/Triton Sample
SF2	Sound bank format by Creative Labs.

Ordinary data and reserved data

Each device (and the internal memory) can contain files and folders. Data inside Pa4X is slightly more rigidly structured than data in a computer, due to the pre-configured type of data inside the instrument's memory. The diagram below shows the global structure of an Pa4X device.

Factory data can only be seen when the **Protect > Factory** parameter is deselected, and only when loading or saving a single bank, or when erasing something (this can be done in the **Global > Mode Preferences > Media** page, see page 953).

Media structure

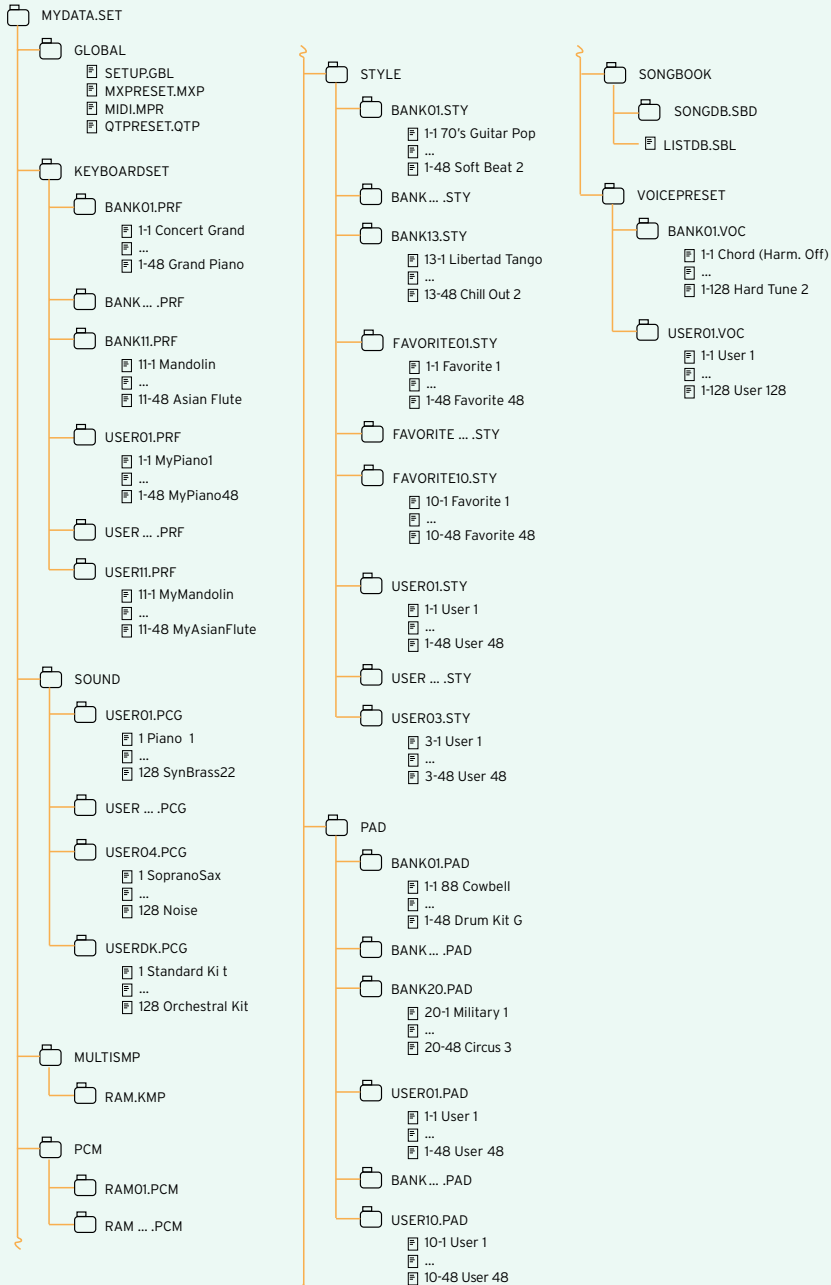

Loading musical resources and settings

Loading files or folders

You can load all the memory content, a separate type of musical resources, a separate bank, or a single resource.

Choose the data to be loaded

- 1 Go to the Media > Load page.

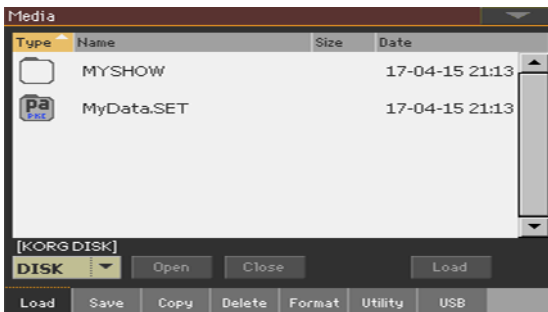

- 2 If loading from an external device, connect the device to one of the USB HOST ports.
- 3 Use the Device pop-up menu to choose the source device.
- 4 Touch an item (file or folder) in the file list to select it.
- 5 Browse through the folders. Touch the Open button to open the selected folder. Touch the Close button to close the current folder.
- 6 When you see the item you are looking for, select it and touch the Load button to load it.

Load the data

- 1 When loading single banks or items, choose a target location in memory.

In this example you are choosing a target where to load a bank of Styles:

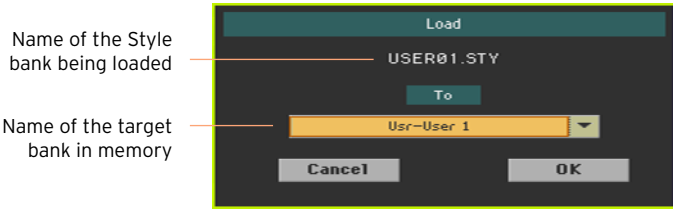

In this example you are choosing a target where to load a single Style:

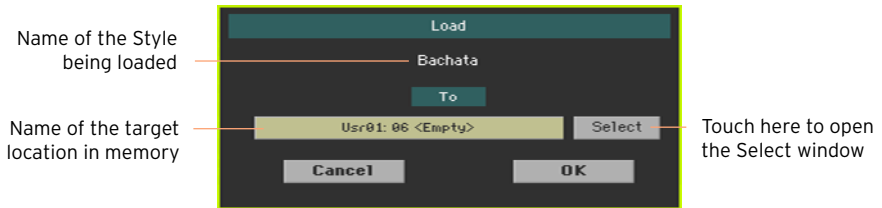

- 2 Touch OK to confirm. After confirming, any item you are overwriting will be deleted.

Loading a SET folder

A SET folder may contain all the data of the internal memory. Loading it may either delete all the data contained in the internal memory, or merge the loaded data with the data already in memory.

Loading a type of data

A folder may contain all the data of a particular type (Styles, Keyboard Sets...). Loading it may either delete all the data of the same type contained in the internal memory, or merge the loaded data with the data already in memory.

Loading a bank

You can load single banks of data. All data contained in the target bank in memory are deleted.

Loading data from other instruments

Loading Global data from Pa-Series instruments

Being unique to each instrument, Global data (Preferences, MIDI Presets, MaxxAudio settings, etc.) can't be loaded from other KORG Pa-Series instruments. They are therefore discarded when loading a SET folder generated by an instrument other than Pa4X.

Loading data from Pa-Series instruments

You can load most data from KORG Pa-Series instruments. The following table shows what you can load from the other instruments.

Please keep in mind that, depending on the actual data, you could not be able to directly load SET folders; in this case, open the folder, and load each bank or individual item separately.

After loading, save the converted data as a new SET folder after loading all the needed data.

Load from	Loaded data
Pa3X	<p>You can load most data as if they were Pa4X data. There are however a few exceptions to be considered:</p> <ul style="list-style-type: none"> • Performances and STSs are converted to Keyboard Sets. • Due to the different order in memory, Factory Styles must be manually reassigned to SongBook Entries by using the KORG SongBook Editor software. • Favorite Style banks over #10 are missing and are not loaded. Since Pa4X banks are larger, load the individual Styles into the additional locations of the other banks. • Performance banks over #11 are missing and are not loaded. Since Pa4X Keyboard Set banks are larger, load the individual Performances into the additional locations of the other banks. • Since the number of Insert and Master FX is different, the effects configuration can be different. • Voice Processor Presets with the MP3 Audio harmony type are reset. • Global settings are not loaded.

Load from	Loaded data
Pa3XLe, Pa900, Pa600, Pa300, HAVIAN 30	<p>You can load most data as if they were Pa4X data. There are however a few exceptions to be considered:</p> <ul style="list-style-type: none"> • Performances and STSs are converted to Keyboard Sets. • Due to the different order in memory, Factory Styles must be manually reassigned to SongBook Entries by using the KORG SongBook Editor software. • Favorite Style banks over #10 are missing and are not loaded. Since Pa4X banks are larger, load the individual Styles into the additional locations of the other banks. • When available, Voice Processor Presets with the MP3 Audio harmony type are reset. • Global settings are not loaded.
Pa2X, Pa800, Pa500, Pa588	<p>You can load most data as if they were Pa4X data. There are however a few exceptions to be considered:</p> <ul style="list-style-type: none"> • Performances and STSs are converted to Keyboard Sets. • Due to the different order in memory, Factory Styles must be manually reassigned to SongBook Entries by using the KORG SongBook Editor software. • Favorite Style banks over #10 are missing and are not loaded. Since Pa4X banks are larger, load the individual Styles into the additional locations of the other banks. • Performance banks over #11 are missing and are not loaded. Since Pa4X Keyboard Set banks are larger, load the individual Performances into the additional locations of the other banks. • Global settings are not loaded.
Pa1X, Pa1X Pro, Pa1X Elite	<p>You can load most data as if they were Pa4X data. There are however a few exceptions to be considered:</p> <ul style="list-style-type: none"> • Performances and STSs are converted to Keyboard Sets. • Due to the different order in memory, Factory Styles must be manually reassigned to SongBook Entries by using the KORG SongBook Editor software. • Performance banks over #11 are missing and are not loaded. Since Pa4X Keyboard Set banks are larger, load the individual Performances into the additional locations of the other banks. • Global settings are not loaded.
Pa80, Pa60, Pa50, Pa50SD, microARRANGER, Liverpool	<p>You can load most data as if they were Pa4X data. There are however a few exceptions to be considered:</p> <ul style="list-style-type: none"> • Performances and STSs are converted to Keyboard Sets. • Programs must be converted to Sounds. First load the SET folder, then separately load the PCG files from the PROGRAM folder. • Global settings are not loaded.

Loading data from i-Series instruments

Pa4X is compatible with the Styles of the older KORG i-Series instruments. You can load them as if they were ordinary Pa4X data.

- 1 Copy the old i-Series data into a USB device, or transfer them to the internal drive of Pa4X.
- 2 Go to the **Media > Load** page.
- 3 Use the **Device** pop-up menu to select the device containing the i-Series data.
- 4 If you are reading an i30 file, select the **SET** folder, then touch the **Open** button.
- 5 Select the **STY** folder.
- 6 At this point, you can load the whole **STY** folder, or open it and choose a single **Style**.
 - To load the whole folder, touch the **Load** button.
 - To load a single **Style**, touch **Open** in the display to open the **STY** folder. Since a conversion will be started at this point, please wait some seconds for the operation to be completed.

Select the **Style** to load, then touch **Load**. You will be prompted to select a target location in memory. Once the target location is selected, touch **Load** to load the **Style**. The 'Are you sure?' message will appear. Touch **OK** to confirm.

Please note that loading a whole **SET** folder from an i30 file may take some time due to format conversion.

- 7 Go to the **Style Play** mode, and select (one of) the loaded **Style**. Adjust the **Tempo** value, then choose the **Write Current Style Settings** command from the **page** menu to write changes.
- 8 Due to the difference in **Sounds**, you will probably want to make some adjustments to the old **Styles**, once they are loaded in Pa4X (changing the **Sound**, **Volume**, **Pan**, **Tempo**, **Drum Mapping**, **Wrap Around**...).
- 9 To make the **Sound** assignment to the **Style** tracks effective, be sure the **Original Style Sounds** parameter is not checked (**Volume** pane, **Style** track view).
- 10 Save the **Style Settings** again, by choosing the **Write Current Style Settings** command from the **page** menu.

Merging data

When loading all User data, or all data of a specified type, most data loaded from a storage device are merged with data already existing in memory. For example, if there is data in all three USER Style banks in memory (USER01, USER02, USER03), and there is only the USER01 Style bank in the storage device, the USER01 bank will be overwritten, while USER02 and USER03 banks will be left unchanged.

As a result, there will be a STYLE folder in memory containing the USER01 bank you just loaded, and the old USER02 and USER03 banks.

Loading data based on User Samples

When loading a SET folder containing Sounds based on User Samples, all existing User Samples in memory are deleted. If there are unsaved User Samples in memory, save them before loading the folder, by selecting the PCM option during a Save All operation (see later in this chapter).

To see if a SET folder contains User Samples, open it and look for a PCM folder.

If you want to load new User Sample without deleting the ones already contained in memory, load single Sounds instead of a whole SET folder.

Merging User Samples from various sources

When you load a SET folder, all the User Samples in memory are deleted. To merge samples from several sources, do the following.

- 1 Load a SET folder containing samples you want to merge with other samples.
- 2 Load single Sounds from other SET folders.
- 3 Go to the Sampling mode, and load or import samples from other sources.
- 4 Save all the content of the memory over the same or a new SET folder.

Saving musical resources and settings

Saving files or folders

You can save all the memory content, a separate type of musical resources, a separate bank, or a single resource.

Pa4X's proprietary data has to be saved into special folders with the '.set' filename extension. These special folders can be saved inside ordinary folders.

Choose the data to be saved

- 1 Go to the Media > Save page.

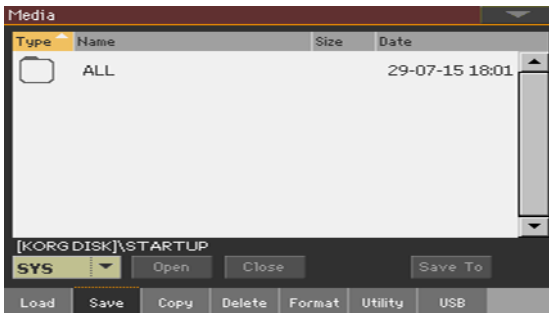

- 2 Touch an item (file or folder) in the file list to select it.
- 3 Browse through the folders. Touch the Open button to open the selected folder. Touch the Close button to close the current folder.
- 4 When you see the item you are looking for, select it and touch the Save To button to save it.

Choose the target device

After touching Save, the target device appears:

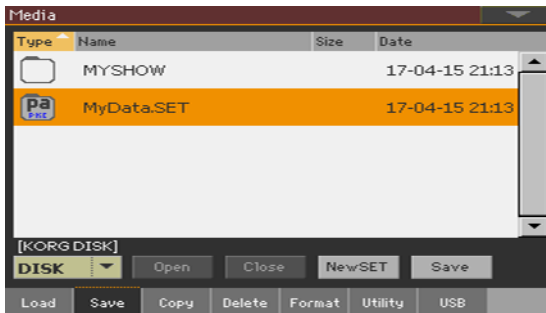

- 1 If saving to an external device, connect the device to the **USB HOST** port.
- 2 Use the Device pop-up menu to choose the target device.

Choose an existing SET folder

You can save data into an existing SET folder. If you are saving data that is not yet in the target folder, data will be merged. Otherwise, it will be overwritten.

Please note that, due to deep file format changes, you can't write into existing SET folders created with older Pa-Series instruments.

- Select an existing SET folder, and touch the Save command to confirm.

Create a new SET folder

You can create a new, empty SET folder to save your data without overwriting anything.

- 1 Touch the **New SET** button to create a new SET folder. The **Create New SET Folder** dialog appears:

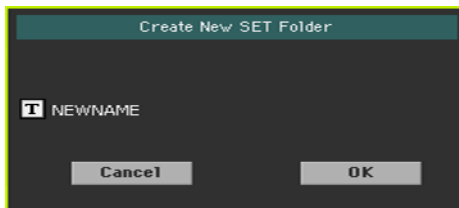

- 2 Touch the Text Edit (**T**) icon to open the virtual keyboard and edit the name. When done editing the name, confirm by touching the **OK** button under the virtual keyboard.

- When back at the Create New SET Folder dialog, touch the OK button to create the new SET folder and exit the dialog.

Save the data

- Save all the memory content, a type or data, single banks or items as described below.

Saving all data

- After having selected an existing SET folder or having created a new one, touch the Save button to confirm. A dialog appears, asking you to select the type of data to save:
 - Save All dialog with the Protect > Factory option activated:

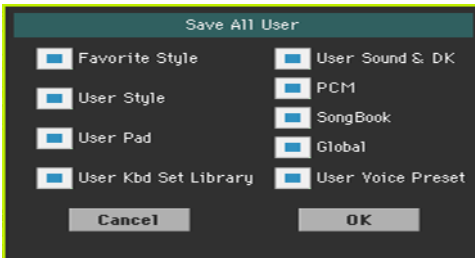

- Save All dialog with the Protect > Factory option deactivated:



- Check all data type you want to save, then touch OK to confirm.

Saving all data of a selected type

- When saving a type of data (Keyboard Sets, Styles...), choose a target location in the storage device.
- Touch OK to confirm. After confirming, any item you are overwriting will be deleted.

Saving single items

- 1 When saving single items, choose a target location in the storage device.
In this example you are choosing a target where to save a single Style:



- 2 Touch OK to confirm. After confirming, any item you are overwriting will be deleted.

Copying files and folders

Copying files or folders

You can copy files and folders. Folders can be generic or SET folders. In addition, you can copy the content of the generic folder you are in. You can copy inside the same device, or from a device to a different one (both devices must be connected to Pa4X during the copy operation).

To preserve data structure integrity, during Copy operations you can't open SET folders and copy only one of the files it contains. You can only open and get inside generic folders.

Choose the data to be copied

- 1 Go to the Media > Copy page.

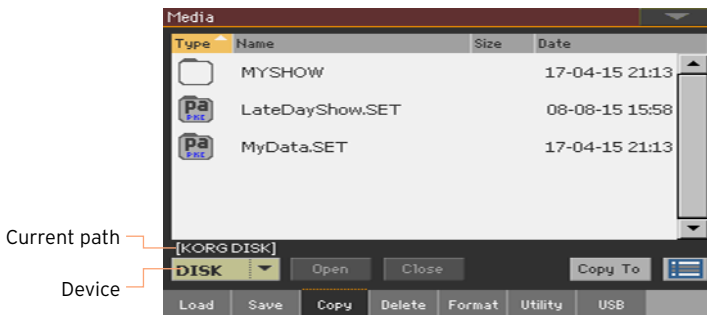

- 2 If copying from an external device, connect the device to one of the USB HOST ports.
- 3 Use the Device pop-up menu to choose the source device.
- 4 Touch an item (file or folder) in the file list to select it.
If nothing is selected, the content of the current folder will be copied.
- 5 Browse through the folders. Touch the **Open** button to open the selected folder. Touch the **Close** button to close the current folder.
- 6 When you see the item you are looking for, select it and touch the **Copy To** button to copy it.

Choose the target device

After touching Copy To, the target device appears:

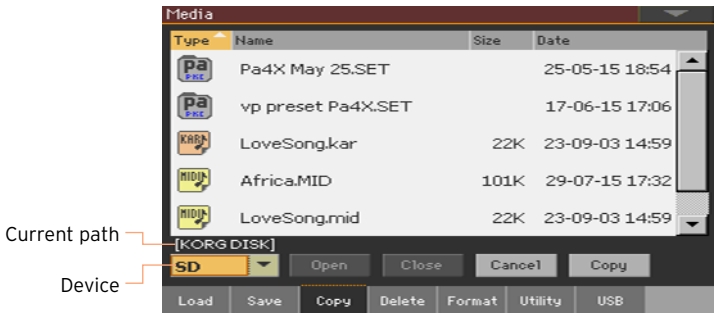

- 1 If copying to an external device, connect the device to one of the USB HOST ports.
- 2 Use the Device pop-up menu to choose the target device.

Choose a target and confirm copying

- Select an existing folder, and touch the Copy command to confirm. If no folder is selected, you will copy into the current folder.

While copying, a dialog shows the copy progress:

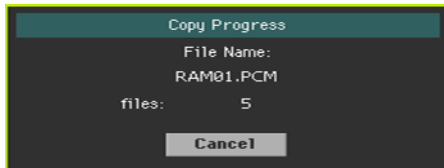

Overwriting existing files or folders

When copying files, a file or folder with the same name of the file or folder being copied might be found in the target device. In this case, Pa4X will ask you if you want to overwrite it.

When a duplicate file or folder is met, the following dialog will appear:

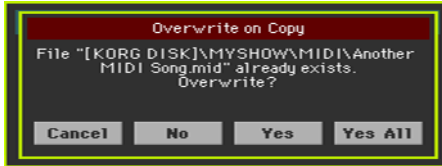

Overwrite	Meaning
Cancel	The procedure is interrupted.
No	The file or folder is not overwritten. The source file or folder is not copied. The procedure will continue with the other files and folders.
Yes	The file or folder is overwritten. The procedure will continue with the other files and folders.
Yes (to) All	The file or folder is overwritten. Any following duplicate file or folders will be overwritten as well, without this dialog box appearing again. The procedure will continue with the other files and folders.

Deleting files and folders

Deleting files or folders

You can delete files and folders from a storage device.

Choose the data to be deleted

- 1 Go to the Media > Delete page.

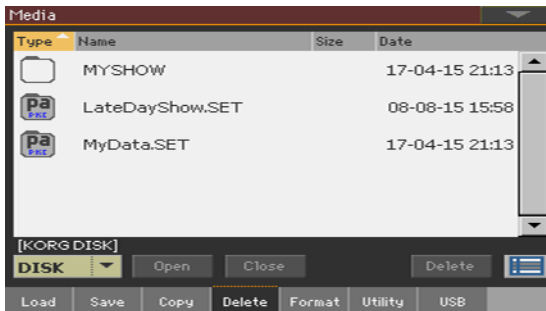



- 2 If deleting from an external device, connect the device to one of the USB HOST ports.
- 3 Use the Device pop-up menu to choose the source device.
- 4 Touch an item (file or folder) in the file list to select it.
- 5 Browse through the folders. Touch the Open button to open the selected folder. Touch the Close button to close the current folder.
- 6 When you see the item you are looking for, select it and touch the Delete button to delete it.

Selecting more items at once

While in the Copy and Delete pages, you can select several files or folders at the same time before executing the operation. Files or folders can be selected consecutively (that is, in a row), or discontinuously (that is, with other files or folders in the middle).

To choose either to select files in a consecutive or discontinuous way, use the **Select Mode** button on the right of the page command buttons, to choose how pressing the **SHIFT** button will work.

Select Mode	Meaning
	Choose this option to select files or folders consecutively (i.e., in a row).
	Choose this option to select files or folders discontinuously (i.e., with other files or folders in the middle).

Select more files or folders consecutively

- 1 Touch the **Select Mode** button to choose the **SHIFT** function.
- 2 Select the first file or folder to be selected.
- 3 Press and keep the **SHIFT** button pressed.
- 4 Select the last file or folder to be selected.
- 5 Release the **SHIFT** button.

Select more files or folders discontinuously

- 1 Touch the **Select Mode** button to choose the **SHIFT** function.
- 2 Select the first file or folder to be selected.
- 3 Press and keep the **SHIFT** button pressed.
- 4 Select a second file or folder to be selected.
- 5 While keeping the **SHIFT** button pressed, continue selecting the other files or folders to be selected.
- 6 Release the **SHIFT** button.

Deselect the files or folders

- To deselect one or more files or folders, without deselecting everything, keep **SHIFT** pressed and touch the file or folder to be deselected.
- To deselect everything, select any other file or folder. All selected files and folders will be deselected.

Exporting playlists

Exporting a list of Songs as a text file

A list of the Songs contained inside a folder or a Jukebox list, or the SongBook and Set Lists, can be exported, to be printed and be used as the playlist of the show.

Exporting a list of songs contained in a folder

- 1 Open the Song Select window.
- 2 Browse through the files and folders, and open the folder whose content you would like to export as a text file.
- 3 Choose the Export Song List command from the page menu to open the Write Song List dialog.



- 4 Use the Device pop-up menu to choose a device where to save the list as a TXT file. The file will be saved in the device's root.

When saved, the text file will be named after the selected folder. For example, a folder named 'Dummy' will generate a 'Dummy.txt' file. If you are saving from the root of the device, a 'Root.txt' file will be generated.

If a file with the same name already exists on the target device, it will be overwritten without waiting for confirmation.

The list will include the progressive number assigned to each Song, the file names, the total number of files in the list.

Exporting a Jukebox list

- 1 While a Jukebox file is assigned to Player 1, choose the **Export Jukebox List** command from the page menu to open the **Write Jukebox List** dialog.

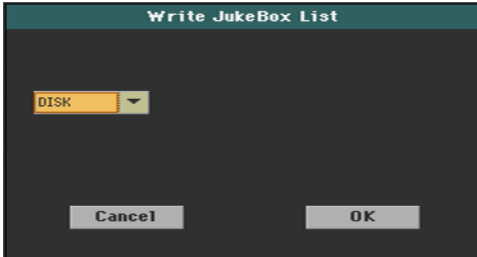

- 2 Use the **Device** pop-up menu to choose a device where to save the list as a **TXT** file. The file will be saved in the device's root.

When saved, the text file will be named after the selected Jukebox file. For example, a Jukebox file named 'Dummy.jbx' will generate a 'Dummy.txt' file. A new, unnamed Jukebox file will generate a 'New_name.txt' file.

If a file with the same name already exists on the target device, it will be overwritten without waiting for confirmation.

The list will include the progressive number assigned to each Song, the file names, the total number of files in the list.

Exporting a SongBook Book list or Custom List

- 1 While you are in the SongBook > Book or SongBook > Set List page, choose the desired list filtering.
- 2 Choose the Export as Text File command from the page menu to open the Export as Text File dialog.

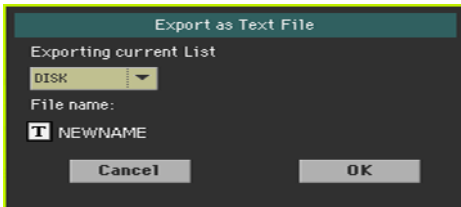
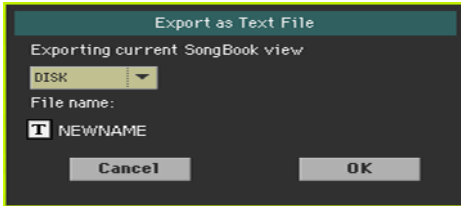

- 3 Use the Device pop-up menu to choose a device where to save the list as a TXT file. The file will be saved in the device's root.
- 4 You may change the name of the list. Touch the Text Edit (**T**) icon to open the virtual keyboard and edit the name. When done editing the name, confirm by touching the OK button under the virtual keyboard.
- 5 When back at the Export as Text File dialog, confirm exporting by touching the OK button.

A TXT file containing the filtered data will be created. If a file with the same name already exists on the target device, it will be overwritten without waiting for confirmation.

Reading the text file on a personal computer

To correctly display and print the list on a personal computer, use a fixed size (i.e., non-proportional) character in your text editor.

56 Managing media

Formatting storage devices

Formatting a storage device

The Format function lets you initialize a device. Pa4X uses a PC-compliant device format (DOS FAT16 and FAT32).

Warning: Formatting a storage device deletes all the data it contains!

Choose the device to be formatted

- 1 Go to the Media > Format page.

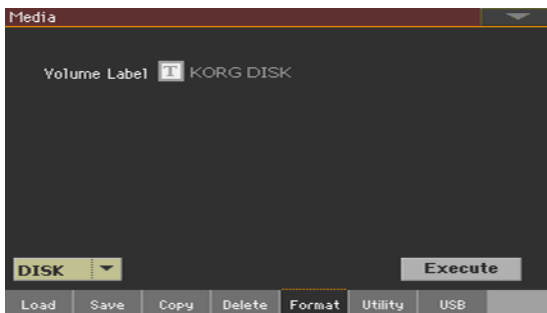

- 2 If formatting an external device, connect the device to one of the USB HOST ports.
- 3 Use the Device pop-up menu to choose the device.

Assign a name to the device

- 1 Use the Volume Label parameter to assign a name to an external device to be formatted.

Since this is a reserved name, you cannot rename the label (name) of the internal volume. When formatting the internal drive, the label cannot be edited.

Also, if you try to rename the internal volume when Pa4X is connected to a PC through the USB port, the original name is automatically restored.

- 2 Touch the **Text Edit** () icon to open the virtual keyboard and edit the name. When done editing the name, confirm by touching the **OK** button under the virtual keyboard.

Please note that renaming a device, containing MIDI Songs or MP3 Songs used in the SongBook, will break the links to the files. We suggest to give the device the same name it had before formatting. In case you changed the name, please use SongBook Editor (freely available on our [web site](#)) to edit the links.

Format the device

- 1 Touch the **Execute** button to start formatting.
- 2 Confirm the following warning message(s).

Backing up and restoring musical resources

A set of file backup and restore utilities can be found in the **Media > Utility** page.

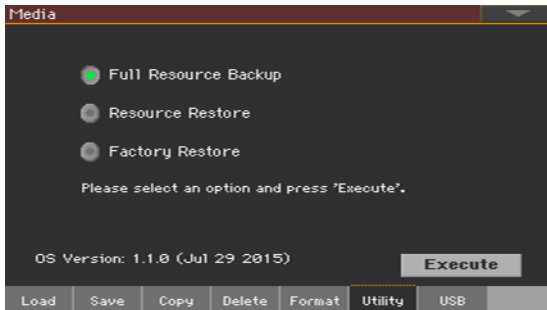

Backing up the musical resources

You can backup the internal data (musical resources and settings) to a storage device. Backup should only be used for archiving purpose, since you will not be able to load individual data from a backup archive. To save data that has to remain accessible with the normal **Media > Load** operations, for example to load User data after updating the musical resources, use the **Media > Save** operations instead.

This function only backs up the internal memory, and not the internal or external drives. It will back up Styles, Keyboard Sets, Sounds, Pads, Voice Presets, the Global. It will not back up the MIDI and MP3 Songs contained in the internal or external drives. Also, it will not back up the Direct banks, already residing in internal or external drives. To back up these data, please make a backup of the internal or external drives by connecting them to a PC (see the **Media > USB** page).

Choose the backup command

- 1 Go to the **Media > Utility** page.
- 2 Select the **Full Resource Backup** option, then touch the **Execute** button to see the file selector.

Choose the target device and folder

After touching **Execute**, the target device appears:

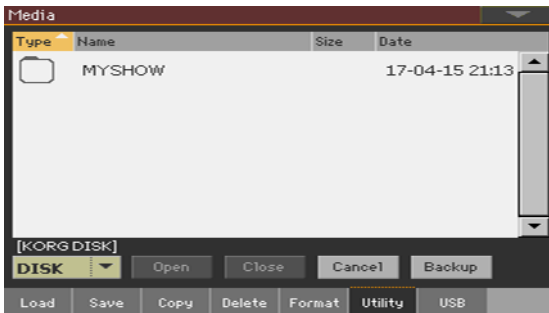

- 1 If you are making a backup to an external device, connect the device to one of the USB HOST ports.
- 2 Use the Device pop-up menu to choose the target device.
- 3 Browse through the folders. Touch the **Open** button to open the selected folder. Touch the **Close** button to close the current folder.
- 4 Select the folder where to backup the data, then touch the **Backup** command to confirm.

If nothing is selected, data will be saved to the current folder.

Assign a name to the backup archive

After touching **Backup**, a dialog will appear, asking you to assign a name to the backup file.

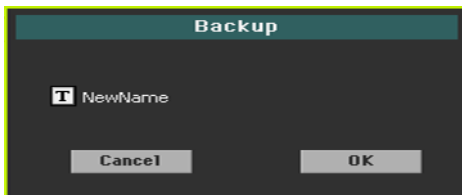

- 1 Touch the Text Edit (**T**) icon to open the virtual keyboard and edit the name. When done editing the name, confirm by touching the **OK** button under the virtual keyboard.
- 2 When at the **Backup** dialog again, touch the **OK** button to start backing up.
- 3 When finished backing, save the storage device in a safe place.

Restoring the musical resources

You can restore data from a backup archive created with the **Full Resource Backup** command.

Choose the restore command

- 1 Go to the **Media > Utility** page.
- 2 Select the **Resource Restore** option, then touch the **Execute** button to see the file selector.

Choose the source device and folder

- 1 If you are restoring from an external device, connect the device to one of the **USB HOST** ports.
- 2 Use the **Device** pop-up menu to choose the target device.
- 3 Browse through the folders. Touch the **Open** button to open the selected folder. Touch the **Close** button to close the current folder.
- 4 When the backup archive appears, select it and touch the **Restore** command.

Choose the data to restore

- 5 After touching **Restore**, a dialog will appear, with a list of types of data to be restored. Only check the types of data you want to restore.



- 6 Touch **OK** to start restoring.

Warning: This command will delete from the internal memory all types of data selected in this dialog box (including your custom data).

- 7 When done, a message will appear, asking you to restart the instrument ('Data Restored. Please switch off'). Turn the instrument off, then turn it on again.

Restoring the original musical resources

After an OS update, or when you want to erase all changes to your Factory and User data, and restore your Pa4X to the same condition it was when new, use the Factory Restore operation.

Warning: This command deletes all data from memory (including your custom data).

- 1 Go to the Media > Utility page.
- 2 Select the Factory Restore option, then touch the Execute button.
- 3 A dialog will appear, with a list of types of data to be restored. Only check the types of data you want to restore.

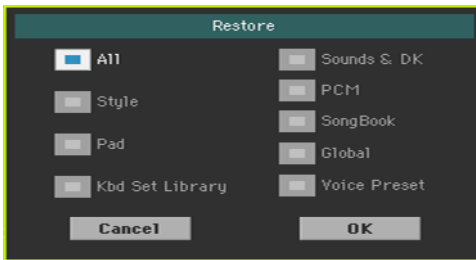

Warning: This command will delete from the internal memory all types of data selected in this dialog box (including your custom data).

- 4 When done, a message will appear, asking you to restart the instrument ('Data Restored. Please switch off'). Turn the instrument off, then turn it on again.

Connecting one of the internal drives to a personal computer

In order to exchange files, you can access one of the internal drives of Pa4X from a personal computer. You don't need any dedicated driver to connect Pa4X and the personal computer.

Connect Pa4X to the personal computer

- Use a standard USB cable to connect one of the **USB DEVICE** ports of Pa4X to an USB port of the personal computer.

Enable USB communication

- 1 Go to the **Media > USB** page, and use the **Device** menu to choose the internal drive to be shared.
- 2 Touch the **Enable** button to start sharing. The icon of the Pa4X's internal drive will appear in your personal computer.

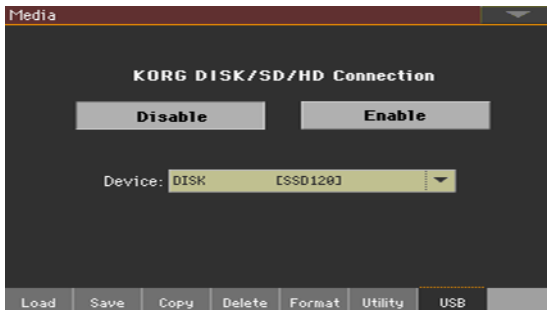



While USB file transfer is enabled, you cannot access other functions on Pa4X. MIDI Over USB is also disabled.

After starting the USB connection, accessing the internal drive from the computer may take some time, depending on the size of the internal drive and the amount of data it contains.

Do not try to change the label (name) of its internal drive when Pa4X is connected to a personal computer. If you try to do it, the original name is automatically restored.

Also, do not modify the structure of the SET folders, or you will no longer be able to use them on Pa4X. Only use the USB connection for data exchange purpose, or to modify ordinary folders.

Disable USB communication

- 1 When finished transferring the files, you can disconnect Pa4X from the personal computer.
 - On a Windows PC, select the dedicated command by clicking on the USB device icon () with the right mouse button.
 - On a Mac, select the USB device icon (), then select the Eject command or drag the drive icon to the eject icon in the Dock ().
- 2 In Pa4X, touch the **Disable** button to disable the **USB DEVICE** port for file transfer, and gain access to all the instrument's functions.

Warning: Do not disconnect USB communication before the personal computer has really finished transferring files. Sometimes, the on-screen indicator tells the procedure has been completed BEFORE it has really finished. Disconnecting USB communication (or disconnecting the USB cable) before data transfer has been completed may cause data loss.

Storage device organization

Creating folders

You can create generic folders, where to store any type of data (other folders, Songs, SET folders...).

- 1 While in any of the Media pages, browse through the folders to find the place where to create a new folder. Touch the **Open** button to open the selected folder. Touch the **Close** button to close the current folder.
- 2 Choose the **Create New Folder** command from the page menu to open the Create New Folder dialog.

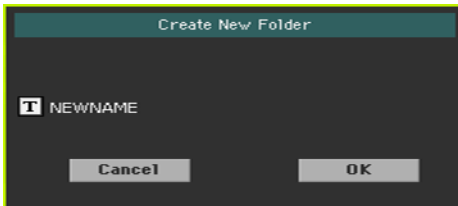

- 3 Touch the Text Edit (**T**) icon to open the **virtual keyboard** and edit the name. When done editing the name, confirm by touching the **OK** button under the virtual keyboard.
- 4 When back at the **Create New Folder** dialog, touch the **OK** button to create the folder at the chosen position.

Renaming files or folders

- 1 While in any of the Media pages, select the item to rename (generic file or folder) and choose the **Rename** command from the page menu.

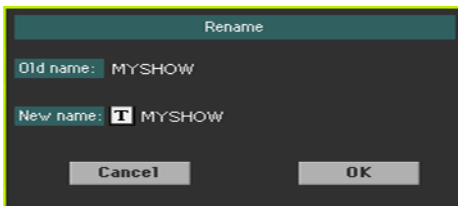

To preserve consistency through the data structure, you cannot rename folders and files inside a SET folder. Also, you cannot change the 3-character extension of files and SET folders, since they are used to identify the type of file or folder.

- 2 Touch the Text Edit (**T**) icon to open the virtual keyboard and edit the name. When done editing the name, confirm by touching the OK button under the virtual keyboard.
- 3 When back at the Rename dialog, touch the OK button to confirm the new name.

Getting information on the selected items

- While in any of the Media pages, select one or more items and choose the Object(s) Info command from the page menu.

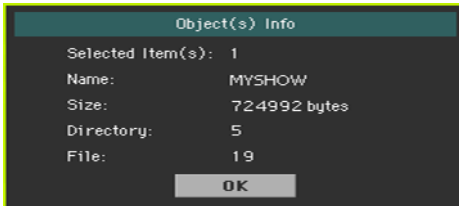

Select this command to see the size of any selected file or folder. Also, the number of files and directories (folders) it contains are shown.

Getting information on the selected device, and changing its name

Open the Device Info dialog

- While in any of the Media pages, choose the Device Info command from the page menu.

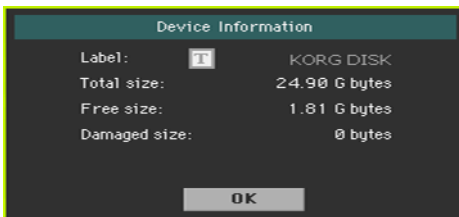

Read the information

While in the Device Information dialog, you can see various information on the selected device. To select a different device, exit from the dialog and use the Device pop-up menu to select a different storage device.

Rename the storage device

- While in the **Device Information** dialog, touch the **Text Edit** () icon to open the **virtual keyboard** and edit the name. When done editing the name, confirm by touching the **OK** button under the virtual keyboard.

Please note that renaming a device, containing MIDI Songs or MP3 Songs used in the SongBook, will break the links to the files. We suggest to give the device the same name it had before formatting. In case you changed the name, please use SongBook Editor (freely available on our web site) to edit the links.

Changing the media display preferences

You can choose what to see when a file selector window opens in the Media Preferences page.

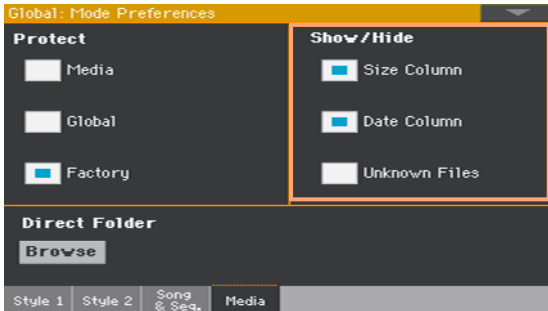

Seeing the file's size and date

To view longer names in their entirety, you can hide the Size and Date columns in the File Selector window.

- 1 Go to the **Global > Mode Preferences > Media** page.
As an alternative, keep the **SHIFT** button pressed and press the **MEDIA** button to open the Media page.
- 2 Use the **Show Columns > Size** checkbox to show or hide the file size.
- 3 Use the **Show Columns > Date** checkbox to show or hide the file creation date stamp.

Hiding unknown files

To make file lists cleaner and easier to browse through, non-proprietary files can be hidden when using Media operations.

- 1 Go to the **Global > Mode Preferences > Media** page.
As an alternative, keep the **SHIFT** button pressed and press the **MEDIA** button to open the Media page.
- 2 Select the **Hide Unknown Files** checkbox to hide non-proprietary files.

Protecting storage devices and files

You can protect media and files in the Media Preferences page.

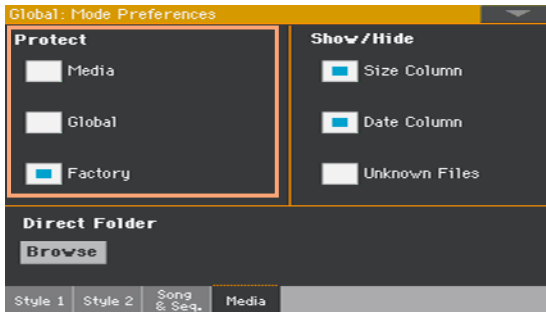

Protecting the media

You can protect the internal drive from writing.

- 1 Go to the Global > Media Preferences page.

As an alternative, keep the **SHIFT** button pressed and press the **MEDIA** button to open the Media page.

- 2 Select the Media Protect checkbox to protect the internal drives.

Protecting the global preferences from changing

When loading data from disk, global parameters may change due to different settings in the loaded data. You can prevent changes to happen.

- 1 Go to the Global > Media Preferences page.

As an alternative, keep the **SHIFT** button pressed and press the **MEDIA** button to open the Media page.

- 2 Select the Global Protect checkbox to protect global preferences to change when loading data from disk.

Please note that, in any case, you could only load global preferences from the same KORG Pa-Series model.

Removing protection from Factory data

Factory Keyboard Sets, Sounds, Styles, Pads and Voice Presets are normally protected, to avoid overwriting the standard musical resources. You can, however, remove this protection and use any Factory location as if they were User locations.

- 1 Go to the Global > Mode Preferences > Media page.

As an alternative, keep the SHIFT button pressed and press the MEDIA button to open the Media page.

- 2 Deselect the Protect > Factory checkbox to remove protection.

This protection will be automatically reset when turning the instrument off.

Hint: Should you accidentally delete, change or overwrite some Factory data, reload the Backup data or use the Factory Restore procedure (in the Media > Utility page).

Note: Pa4X ORIENTAL also included a Factory and Favorite Protect checkbox. When selected, this option protects all the Factory data and the Favorite Styles from editing.

Protecting files and folders

Protect the files or folders

- While in any of the Media pages, select one or more items and choose the Protect command from the page menu.

Choosing this command will protect the selected file(s) or folder(s) from writing or erasing. The lock icon will appear next to the file or folder name.



Unprotect the files or folders

- While in any of the Media pages, select one or more protected items and choose the Unprotect command from the page menu.

Care of storage devices

Pa4X can save most of the data contained in memory to the internal drive, an internally installed microSD card, or to external devices (like hard drives or USB memory sticks) connected to the USB HOST ports. Here are some precautions when handling these devices.

Internal drive write protection

You can protect the internal drive from writing, by using the software protection found in the **Global > Mode Preferences > Media** page (Media Protect checkbox).

Precautions

- Do not remove a device or move the instrument while the device is operating.
- In order to avoid losing data in case of damage, make a backup copy of the data contained in a device. You can backup your data to a personal computer, and from there to a backup unit. You can transfer data from the internal drives of Pa4X to a personal computer by using the USB DEVICE connection.
- Do not leave an USB device connected to the USB ports while carrying the instrument, or it may be damaged.
- Keep the memory devices or the instrument away from sources of magnetic fields, for example televisions, refrigerators, computers, monitors, speakers, cellular phones and transformers. Magnetic fields can alter the contents of the devices.
- Do not keep memory devices in very hot or wet places, do not expose them to direct sunlight and do not store them without use in dusty or dirty places.
- Do not place heavy objects on top of the devices.
- Regular care is recommended with your devices. Defragmenting and repairing the internal drive can be made with any computer utility while Pa4X is connected via USB.

PART XV: APPENDIX

57 Musical Resources

The following pages list all the musical resources supplied as standard with your Pa4X.

Styles

This list shows the Styles as they appear in the Style Select window. The table also includes MIDI data used to remotely select the Styles on the special Control channel. **CC00**: Control Change 0, or Bank Select MSB. **CC32**: Control Change 32, or Bank Select LSB. **PC**: Program Change.

Style	CC00	CC32	PC
Pop			
70's Guitar Pop	0	0	0
Love Pop	0	0	1
Standard 8 Beat	0	0	2
Standard 16 Beat	0	0	3
Soft Guitar Pop	0	0	4
One Last Pop	0	0	5
Copacabana Pop	0	0	6
As Groove	0	0	7
Modern Pop	0	0	8
Groovy Pop	0	0	9
Believer Pop	0	0	10
Sunny Pop	0	0	11
Slow Pop	0	0	12
Hold My Pop	0	0	13
Morning Pop	0	0	14
No Name Pop	0	0	15
Happy Pop	0	0	16
Pop Hit	0	0	17
Piano Pop	0	0	18
Cool Pop	0	0	19
Liverpool 1	0	0	20
Liverpool 2	0	0	21
Pop Beat	0	0	22
Easy Pop Shuffle	0	0	23
Classic Beat	0	0	24
Classic Pop	0	0	25
Shadow Pop	0	0	26

Style	CC00	CC32	PC
Pop Rock	0	0	27
Retro Beat	0	0	28
Pop Shuffle 1	0	0	29
Pop Shuffle 2	0	0	30
Pop Shuffle 3	0	0	31
Vintage Pop 1	0	0	32
Vintage Pop 2	0	0	33
6/8 Slow Pop	0	0	34
12/8 Pop	0	0	35
Gigolò Shuffle	0	0	36
Slow Latin Pop	0	0	37
Drum'n Boogaloo	0	0	38
Vocal Pop	0	0	39
Easy Pop	0	0	40
Guitar Beat	0	0	41
Soft 8 Beat	0	0	42
Soft 16 Beat	0	0	43
Ballad			
Brush Ballad	0	1	0
Modern Ballad	0	1	1
Slow Gtr Ballad	0	1	2
Soft Ballad	0	1	3
Piano Ballad	0	1	4
3/4 Piano Ballad	0	1	5
Orchestral Bld 1	0	1	6
Orchestral Bld 2	0	1	7
Unplugged	0	1	8
Guitar Ballad	0	1	9

Style	CC00	CC32	PC
70's Ballad	0	1	10
Unplugged Heaven	0	1	11
Groovy Ballad 1	0	1	12
Groovy Ballad 2	0	1	13
Analog Ballad 1	0	1	14
Analog Ballad 2	0	1	15
6/8 Ballad 1	0	1	16
6/8 Ballad 2	0	1	17
6/8 Brush Ballad	0	1	18
6/8 Slow	0	1	19
Organ Ballad	0	1	20
Waltz Ballad	0	1	21
Contemporary Bld	0	1	22
Ambient Groove	0	1	23
12/8 Ballad	0	1	24
6/4 Ballad	0	1	25
6/8 Slow Ballad	0	1	26
3/4 Acoustic Bld	0	1	27
Blues Ballad	0	1	28
Jazzy Ballad	0	1	29
Funky Ballad	0	1	30
Reggae Ballad	0	1	31
UnpluggedBallad1	0	1	32
UnpluggedBallad2	0	1	33
UnpluggedBallad3	0	1	34
UnpluggedBallad4	0	1	35
Unplugged Gtr 1	0	1	36
Unplugged Gtr 2	0	1	37
Unplugged Gtr 3	0	1	38
Unplugged Gtr 4	0	1	39
Ambient Ballad	0	1	40
Easy Ballad	0	1	41
Serenade	0	1	42
Unplugged Slow	0	1	43

Style	CC00	CC32	PC
Ballroom			
English Waltz	0	2	0
Quick Step	0	2	1
Pasodoble	0	2	2
Paso Dance	0	2	3
Viennese Waltz	0	2	4
Jive	0	2	5
Argentina Tango	0	2	6
Modern Tango	0	2	7
Slow Waltz 1	0	2	8
Slow Waltz 2	0	2	9
3/4 Flamenco	0	2	10
4/4 Flamenco	0	2	11
Swing Fox	0	2	12
Slow Fox	0	2	13
Fox Shuffle	0	2	14
Foxtrot	0	2	15
Boogie Woogie	0	2	16
Big Band Jump	0	2	17
Big Band Fox	0	2	18
Big Band Swing	0	2	19
Organ Waltz	0	2	20
Organ Foxtrot	0	2	21
Twist	0	2	22
Hully Gully	0	2	23
Dance			
70's Disco Remix	0	3	0
'70 Remix	0	3	1
70's Disco 1	0	3	2
70's Disco 2	0	3	3
80's Dance	0	3	4
90's Dance	0	3	5
UpTown Disco	0	3	6
No Worry Dance	0	3	7

Style	CC00	CC32	PC
Dj Disco Mix	0	3	8
Spanish Remix	0	3	9
ChaCha Remix	0	3	10
Western Remix	0	3	11
Tacata Dance	0	3	12
Kuduro Dance	0	3	13
Gangnam Dance	0	3	14
Party Anthem	0	3	15
Bailando Dance	0	3	16
Get Luck Disco	0	3	17
Brother Dance	0	3	18
Cowboy Dance	0	3	19
Dance Pop	0	3	20
Te Pego Dance	0	3	21
Release My Dance	0	3	22
Waka Dance	0	3	23
Fast Remix	0	3	24
Dance Revival	0	3	25
Summer Dance	0	3	26
Counting Dance	0	3	27
Garage	0	3	28
Electro House	0	3	29
Ethno House	0	3	30
Drum&Bass	0	3	31
Dance Fever	0	3	32
Barry Dance	0	3	33
Sister & Girl	0	3	34
Philly Disco	0	3	35
Love Disco	0	3	36
Dance Motown	0	3	37
Funky Disco 1	0	3	38
Funky Disco 2	0	3	39
Tribal	0	3	40
Euro Trance	0	3	41

Style	CC00	CC32	PC
Rock			
Foo Rock	0	4	0
21 Gun Anthem	0	4	1
First Kid Rock	0	4	2
Killer Rock	0	4	3
HighwayHell Rock	0	4	4
Rock on Fire	0	4	5
Welcome Rock	0	4	6
Rock Star	0	4	7
80's Rock	0	4	8
Rock Punch	0	4	9
Rolling Blues	0	4	10
Alabama Rock	0	4	11
Clean Rock	0	4	12
Stadium Ballad	0	4	13
Rolling Rock	0	4	14
Magic Rock	0	4	15
Prison Rock	0	4	16
Johnny Rock	0	4	17
Rock the Clock	0	4	18
Rockabilly	0	4	19
Basic Rock	0	4	20
Smoke Rock	0	4	21
69's Rock	0	4	22
Walk of Rock	0	4	23
50's R&Roll	0	4	24
60's R&Roll	0	4	25
Rock Oldie	0	4	26
Surf Rock	0	4	27
6/8 Slow Rock	0	4	28
6/8 Rock	0	4	29
60's Slow Rock	0	4	30
Abbey Rock	0	4	31
Rock Cha Cha	0	4	32

Style	CC00	CC32	PC
Slow Latin Rock	0	4	33
Latin Rock	0	4	34
SouthStrait Rock	0	4	35
Classic Rock	0	4	36
Rock Boogie	0	4	37
Rock Blues	0	4	38
Power Rock	0	4	39
Rock Shuffle	0	4	40
8 Beat Rock	0	4	41
Rock Beat	0	4	42
Final Rock	0	4	43
Unplugged Rock	0	4	44
Country			
Acoustic Country	0	5	0
Country Rock	0	5	1
Sally Groove	0	5	2
Easy Country	0	5	3
Country Blues	0	5	4
6/8 Country Bld	0	5	5
Country Fox	0	5	6
Finger Picking	0	5	7
Slow Country	0	5	8
West Coast	0	5	9
Country Hit	0	5	10
Country Strum	0	5	11
Country QuikStep	0	5	12
3/4 Country	0	5	13
Modern Country	0	5	14
Country Pop	0	5	15
Country Beat 1	0	5	16
Country Beat 2	0	5	17
Country Ballad 1	0	5	18
Country Ballad 2	0	5	19
Country 8 Beat	0	5	20

Style	CC00	CC32	PC
Country 16 Beat	0	5	21
Bluegrass	0	5	22
Bar Country	0	5	23
Desert Shuffle	0	5	24
Country Shuffle	0	5	25
South Shuffle	0	5	26
Country Boogie	0	5	27
Easy Strumming	0	5	28
Traditional			
Italian Waltz 1	0	6	0
Italian Waltz 2	0	6	1
Italian Polka 1	0	6	2
Italian Polka 2	0	6	3
Italian Mazurka 1	0	6	4
Italian Mazurka 2	0	6	5
Italian Tango	0	6	6
Italian Fox	0	6	7
Bavarian Polka 1	0	6	8
Bavarian Polka 2	0	6	9
German Polka 1	0	6	10
German Polka 2	0	6	11
German Waltz 1	0	6	12
German Waltz 2	0	6	13
German March	0	6	14
Heimat Walzer	0	6	15
9/8	0	6	16
Vahde	0	6	17
2/4 Oyun	0	6	18
Ciftetelli	0	6	19
Halay	0	6	20
5/8	0	6	21
Oryantal	0	6	22
Turkish Pop	0	6	23
Musette Waltz	0	6	24

Style	CC00	CC32	PC
French Waltz	0	6	25
Irish Slow Waltz	0	6	26
Irish Med. Waltz	0	6	27
Irish Fast Waltz	0	6	28
Irish Fox	0	6	29
Irish QuickStep	0	6	30
Latin			
Samba Enredo	0	7	0
Samba Brazil	0	7	1
Bossa Nova	0	7	2
Classic Salsa	0	7	3
Classic Mambo	0	7	4
Classic ChaCha	0	7	5
Guajira	0	7	6
Guaguancò	0	7	7
Timba	0	7	8
6/8 Afro	0	7	9
Bomba	0	7	10
Classic Bachata	0	7	11
Classic Merengue	0	7	12
Cumbia	0	7	13
Joropo	0	7	14
Habanera	0	7	15
Guitar Bossa	0	7	16
Meditation Bossa	0	7	17
Organ Bossa	0	7	18
Pop Bossa	0	7	19
Cool Bossa	0	7	20
Fast Bossa	0	7	21
Orch. Bossa 1	0	7	22
Orch. Bossa 2	0	7	23
Brazilian Samba	0	7	24
Salsa 1	0	7	25
Salsa 2	0	7	26

Style	CC00	CC32	PC
Mambo	0	7	27
Pop ChaCha	0	7	28
Rhumba 1	0	7	29
Rhumba 2	0	7	30
Bachata	0	7	31
Cool Latin Jazz	0	7	32
Latin Big Band	0	7	33
Latin Pop	0	7	34
Latin Bolero	0	7	35
Latin Vocal	0	7	36
Sabor	0	7	37
Merengue	0	7	38
Natural Bossa	0	7	39
Latin Lounge	0	7	40
Bossa Lounge	0	7	41
Smooth LatinJazz	0	7	42
Unplugged Latin	0	7	43
Latin Dance			
Reggaeton 1	0	8	0
Reggaeton 2	0	8	1
BachaTango	0	8	2
Hot Merengue	0	8	3
Modern Salsa	0	8	4
Bomba Dance	0	8	5
Tortura Dance	0	8	6
Gipsy Dance	0	8	7
Limbo	0	8	8
Bamba	0	8	9
Disco Samba	0	8	10
Mambo Party	0	8	11
Mambo Five	0	8	12
Modern Bachata	0	8	13
Classic Beguine	0	8	14
Modern Beguine	0	8	15

Style	CC00	CC32	PC
Tropicana Dance	0	8	16
Modern Bossa	0	8	17
Disco ChaCha	0	8	18
Calypso	0	8	19
Reggae 1	0	8	20
Reggae 2	0	8	21
Latin Club	0	8	22
Andean	0	8	23
Lambada	0	8	24
Meneaito	0	8	25
Macarena	0	8	26
Bayon	0	8	27
Unplugged Gipsy	0	8	28
Unplugged Reggae	0	8	29
Sambalegre	0	8	30
Samba Dance	0	8	31
Jazz			
Slow BB Shuffle	0	9	0
Duke's Ballad	0	9	1
Dual Tempo Swing	0	9	2
Mood Swing	0	9	3
Swing Band	0	9	4
Modern Big Band	0	9	5
Big Band Shuffle	0	9	6
Latin Jazz Band	0	9	7
Afro-Cuban Jazz	0	9	8
BeBop	0	9	9
Medium JazzWaltz	0	9	10
Fast Jazz Waltz	0	9	11
Bigger Band	0	9	12
Serenade Band	0	9	13
Medium Big Band	0	9	14
Fast Big Band	0	9	15
Swing Ballad 1	0	9	16

Style	CC00	CC32	PC
Swing Ballad 2	0	9	17
Slow Swing Brush	0	9	18
Orchestral Swing	0	9	19
Classic Swing	0	9	20
Acoustic Jazz	0	9	21
Easy Swing	0	9	22
Easy JazzWaltz	0	9	23
Dixieland	0	9	24
Charleston	0	9	25
Stride	0	9	26
Ragtime	0	9	27
Slow Organ Swing	0	9	28
Medium Org.Swing	0	9	29
Organ Blues	0	9	30
Jazz Quartet	0	9	31
Classic JazzWalz	0	9	32
Jazz Club	0	9	33
Jazz Brush	0	9	34
Soft Jazz	0	9	35
Django	0	9	36
Unplugged Swing	0	9	37
Vocal Swing	0	9	38
Vocal Jazz	0	9	39
Jazzy Blues	0	9	40
Swing Quintet	0	9	41
Moon Swing	0	9	42
5/4 Swing	0	9	43
Slow Smooth Jazz	0	9	44
Fast Smooth Jazz	0	9	45
Smooth JazzWaltz	0	9	46
Jazzy Lounge	0	9	47
Movie & Show			
Fifty Shades	0	10	0
Special Agent	0	10	1

Style	CC00	CC32	PC
Spaghetti Western	0	10	2
Burt's Bounce	0	10	3
ScreenEpicMarch1	0	10	4
ScreenEpicMarch2	0	10	5
Weird Movie	0	10	6
Mystery Man	0	10	7
Ritz Swing	0	10	8
Tap Dance	0	10	9
Movie Ballad	0	10	10
Safari Swing	0	10	11
Hollywood 1	0	10	12
Hollywood 2	0	10	13
Western Movie	0	10	14
Cartoon Time	0	10	15
Love Movie	0	10	16
Artie's Theme	0	10	17
Love Ballad	0	10	18
Army Band	0	10	19
Christmas Waltz	0	10	20
Christmas Swing	0	10	21
Theatre Swing	0	10	22
Theatre March	0	10	23
Movie Swing	0	10	24
Horror Movie	0	10	25
Orchestral Movie	0	10	26
Broadway	0	10	27
Show Time	0	10	28
Funk & Blues			
Live @ RMC	0	11	0
Going On Soul	0	11	1
Slap Funk	0	11	2
Chicago Blues	0	11	3
Detroit Backbeat	0	11	4
Street Soul	0	11	5

Style	CC00	CC32	PC
Everybody Bros	0	11	6
Soul Bros	0	11	7
Blues	0	11	8
Soul	0	11	9
Talkin' Funk	0	11	10
Donald Mood	0	11	11
Capital Soul	0	11	12
Soul Power	0	11	13
Level Funk	0	11	14
Acoustic Shuffle	0	11	15
Grace Gospel	0	11	16
Gospel	0	11	17
Gospel Swing	0	11	18
Gospel Shuffle	0	11	19
Modern Gospel 1	0	11	20
Modern Gospel 2	0	11	21
Love 4 All	0	11	22
Dance to Rhythm	0	11	23
Motown Beat 1	0	11	24
Motown Beat 2	0	11	25
Rimshot Mood	0	11	26
Groovy Funk	0	11	27
Easy Funk	0	11	28
Soul Ballad	0	11	29
Cool Funk	0	11	30
Classic Funk	0	11	31
70's Beat Groove	0	11	32
Funk R&B	0	11	33
Elektrik Funk	0	11	34
Funky Sisters	0	11	35
Slide Blues	0	11	36
Cool Vocal	0	11	37
Funk Groovin'	0	11	38
Jazzy Funk	0	11	39

Style	CC00	CC32	PC
Little Shuffle	0	11	40
Slow & Jazzy	0	11	41
Slow Funk	0	11	42
Swing HipHop	0	11	43
Slow Mood	0	11	44
Kool Funk	0	11	45
World			
Libertad Tango	0	12	0
Spanish Dance	0	12	1
Hawaiian	0	12	2
Casatchock	0	12	3
Greek Rumba	0	12	4
Xasapiko	0	12	5
Sirtaki	0	12	6
Zouk	0	12	7
Mexican Waltz	0	12	8
Norteno	0	12	9
Kebradita	0	12	10
Bolero Ranchero	0	12	11
Mariachi Waltz	0	12	12
Mariachi Polka	0	12	13
Mariachi Son	0	12	14
Mariachi Cumbia	0	12	15
Pizzica	0	12	16
Quadriglia	0	12	17
Tammurriata	0	12	18
Sevillana	0	12	19
Milonga	0	12	20
Tarantella	0	12	21
Rumba Napoletana	0	12	22
Raspa	0	12	23
Celtic Dream	0	12	24
Celtic Waltz	0	12	25
Celtic Ballad	0	12	26

Style	CC00	CC32	PC
Scottish Reel	0	12	27
Alpen Schlager	0	12	28
Classic Schlager	0	12	29
Modern Schlager	0	12	30
Vienna Waltz	0	12	31
Orleans	0	12	32
Cajun	0	12	33
Zydeco	0	12	34
Hora	0	12	35
OrchestralBolero	0	12	36
Minuetto	0	12	37
Baroque	0	12	38
Banda	0	12	39
US March	0	12	40
French March	0	12	41
Ska	0	12	42
Hip Hindi Hop	0	12	43
Kyoto Lounge	0	12	44
Chill Out	0	12	45
Favorite/Pop			
Kiss Sky Pop	1	0	0
Corazon Pop	1	0	1
Tiger Pop	1	0	2
Mama Say Pop	1	0	3
Sactuary Pop	1	0	4
Coral Keys	1	0	5
Talk Anymore Pop	1	0	6
24000 Magic Pop	1	0	7
Love Inside Pop	1	0	8
B. Jean Pop	1	0	9
Trailer	1	0	10
Through the Pop	1	0	11
Moving Forward	1	0	12
Easy Beat	1	0	13

Style	CC00	CC32	PC
Stand Up	1	0	14
Pop Promises	1	0	15
Treat & Beat	1	0	16
Feel the Pop	1	0	17
Guitar Pop	1	0	18
Favorite/Ballad			
Paradise Ballad	1	1	0
Sweet Ballad	1	1	1
3/4 Jazz Ballad	1	1	2
Long Life Ballad	1	1	3
Color Ballad	1	1	4
Believe Ballad	1	1	5
True Colors	1	1	6
Analog Feel	1	1	7
Hope Ballad	1	1	8
Favorite/Dance			
Synth Beat	1	2	0
Dance To Trance	1	2	1
EDM Happy Hour	1	2	2
EDM Reggaeton	1	2	3
EDM Remix	1	2	4
NU Disco	1	2	5
Trap Dance 1	1	2	6

Style	CC00	CC32	PC
Trap Dance 2	1	2	7
Reggaeton DJ	1	2	8
House Class	1	2	9
Deep House	1	2	10
Deep Remix	1	2	11
Trance	1	2	12
Saturday Night	1	2	13
Hey Dance	1	2	14
Slowly L. Dance	1	2	15
Shape Dance	1	2	16
Falling Dance	1	2	17
Revelation Dance	1	2	18
Nuvola	1	2	19
Mind Dance	1	2	20
Rainbow Dance	1	2	21
Techno	1	2	22
HipHop	1	2	23
Favorite			
	1	0-9	0-47
User			
	2	0-9	0-47
Direct Favorite			
	3	0-9	0-47
Direct User			
	4	0-9	0-47

Keyboard Set Library

This list shows the Keyboard Sets as they appear in the Keyboard Set Library Select window. The table also includes MIDI data used to remotely select the Keyboard Sets on the special Control channel. **CC00**: Control Change 0, or Bank Select MSB. **CC32**: Control Change 32, or Bank Select LSB. **PC**: Program Change.

Keyboard Set	CC00	CC32	PC
Piano			
German Grand	16	0	0
Classic Grand	16	0	1
Grand Piano Live	16	0	2
Upright Piano	16	0	3
Honky-Tonk	16	0	4
Jazz Piano	16	0	5
Korg M1 Piano	16	0	6
Piano & VPM	16	0	7
Harpsichord	16	0	8
Clav	16	0	9
Rock Piano	16	0	10
Electric Grand	16	0	11
Digital Grand	16	0	12
Piano & E.Piano	16	0	13
Piano & Strings	16	0	14
Midi Grand & Pad	16	0	15
Harpsi & Orch.	16	0	16
Piano & Ensemble	16	0	17
Piano & SynVoice	16	0	18
Piano Atmosphere	16	0	19
Octave Piano	16	0	20
Piano & Scat	16	0	21
Glide Piano	16	0	22
Piano & Bass	16	0	23
Piano Jazz Trio	16	0	24
Piano & Whistle	16	0	25
Vynil Upright	16	0	26
Piano & Vibes	16	0	27

Keyboard Set	CC00	CC32	PC
Vibraphone	16	0	28
Marimba Trill	16	0	29
Xylophone	16	0	30
Music Box	16	0	31
Tropical	16	0	32
Bell & Whistle	16	0	33
Bell & Accordion	16	0	34
Grand & Pad	16	0	35
Vibes & Flute	16	0	36
Concert Hall	16	0	37
E.Piano			
Electric Piano	16	1	0
Phaser E. Piano	16	1	1
Ballad E.Piano	16	1	2
Tremolo E.Piano	16	1	3
Chorus Tine E.P.	16	1	4
Dyno E.Piano	16	1	5
Distorsion E.P.	16	1	6
Classic E.Piano	16	1	7
Amp. Wurly	16	1	8
Vintage Wurly	16	1	9
Clean Wurly 1	16	1	10
Clean Wurly 2	16	1	11
Natural Wurly	16	1	12
Amp&Comp.Wurly	16	1	13
Tremolo Wurly	16	1	14
Wurly & Pad	16	1	15
FM E.Piano	16	1	16
R&B E.Piano	16	1	17

Keyboard Set	CC00	CC32	PC
Comp&Phaser E.P.	16	1	18
Bell Tine E.P.	16	1	19
E.Piano & Pad	16	1	20
E.Piano & Strings	16	1	21
E.Piano&SynVoice	16	1	22
E.P. Atmosphere	16	1	23
Digital E.P. Bld	16	1	24
Stage E.Piano	16	1	25
Hybrid E.Piano 1	16	1	26
Hybrid E.Piano 2	16	1	27
Chorus E.Piano	16	1	28
Stereo E.Piano	16	1	29
Digital E.Piano	16	1	30
Jazz Club E.P.	16	1	31
Organ			
Jimmy Organ	16	2	0
Gospel Organ	16	2	1
Rock Organ	16	2	2
Full Organ V.	16	2	3
DWB Org. Aft	16	2	4
DWB Dark Org.	16	2	5
DWB Jazz Org. Y+	16	2	6
DWB Clas.Perc.Y+	16	2	7
BX3 Hi Perc.	16	2	8
BX3 Jazz Org. V.	16	2	9
BX3 4 Layers V.	16	2	10
Hot BX3 Y+	16	2	11
Full DWB 1 Y+	16	2	12
Full DWB 2 Y+	16	2	13
DWB Perc.Org. 1	16	2	14
DWB Perc.Org. 2	16	2	15
Distortion Organ	16	2	16
Click Organ Y+	16	2	17
Jazz Organ Y+	16	2	18

Keyboard Set	CC00	CC32	PC
Dark Organ V.	16	2	19
Pipe Flute	16	2	20
Full Pipes	16	2	21
Theatre Organ 1	16	2	22
Theatre Organ 2	16	2	23
Harmonica 1	16	2	24
Harmonica 2	16	2	25
Harmonica 3	16	2	26
Blues Harmonica	16	2	27
Toots Harmonica	16	2	28
Melodica	16	2	29
Cassotto	16	2	30
PiccoloAccordion	16	2	31
Musette	16	2	32
Master Fisa	16	2	33
ItalianAccordion	16	2	34
Clarinet Accord.	16	2	35
Alps Accordion	16	2	36
Astor Bandoneon	16	2	37
That's Amore Acc	16	2	38
Acc. & Bass Acc.	16	2	39
Guitar			
Real Nylon Gtr	16	3	0
Natural SteelGtr	16	3	1
Clean Ch.Guitar	16	3	2
Nylon Gtr & Pad	16	3	3
Jazz Guitar 1	16	3	4
Carlos Guitar1	16	3	5
Overdrive Gtr1	16	3	6
Western Gtr&Whis	16	3	7
Pat Guitar Synth	16	3	8
Shadow Guitar	16	3	9
Clean El.Guitar	16	3	10
Overdrive Gtr2	16	3	11

Keyboard Set	CC00	CC32	PC
Carlos Guitar2	16	3	12
Distortion Gtr	16	3	13
My Overdrive Gtr	16	3	14
Nylon Guitar	16	3	15
Gtrs Atmosphere	16	3	16
Real Dobro	16	3	17
Folk Guitar	16	3	18
Jazz Guitar 2	16	3	19
Crunch Gtr DNC	16	3	20
Overdrive Gtr3	16	3	21
AmbienceE.Guitar	16	3	22
Carlos Guitar3	16	3	23
George Gtr&Scat	16	3	24
Guitar & Whistle	16	3	25
Nylon Gtr & Fret	16	3	26
Overdrive Gtr V.	16	3	27
Rock & Roll Gtr	16	3	28
Wah Guitar Y+	16	3	29
12 Str Folk Gtr	16	3	30
Jazz Club Guitar	16	3	31
Unplugged Gtrs	16	3	32
Guitar Club	16	3	33
Flute&Gtr Synth	16	3	34
Strings			
Real new Violin	16	4	0
Real new Viola	16	4	1
Choir & Soprano	16	4	2
Bell & Strings	16	4	3
Real Strings DNC	16	4	4
Theatre Strings	16	4	5
Choir & Scat	16	4	6
Big Choir & Orch	16	4	7
Cinematic+ Sub	16	4	8
Single room Str	16	4	9

Keyboard Set	CC00	CC32	PC
Room Strings	16	4	10
Movie Strings	16	4	11
Real Violin	16	4	12
Jazz Violin	16	4	13
Serenade Violin	16	4	14
Soprano Voice	16	4	15
CinematicStrFast	16	4	16
Epic Sound	16	4	17
Orchestra Tutti	16	4	18
Violin	16	4	19
Scat Voices	16	4	20
A Cappella	16	4	21
Dreaming Choir	16	4	22
Vienna Strings	16	4	23
Slapstick Pizz.	16	4	24
Studio Strings	16	4	25
Natural Strings	16	4	26
eXp Viola	16	4	27
Small Orchestra	16	4	28
Wiener StringPad	16	4	29
Smooth Orchestra	16	4	30
Strings & Bell	16	4	31
ScatVoice & Bass	16	4	32
Strings & Orch.	16	4	33
Soprano Choir	16	4	34
Oboe & Str. Ens.	16	4	35
Vocal & Str. Ens	16	4	36
Brass			
Shake Brass1 Y+	16	5	0
BigBand Brass	16	5	1
Orchestral Brass	16	5	2
SaxEns.& Brass V	16	5	3
Cup & Mute Brass	16	5	4
Horn Section	16	5	5

Keyboard Set	CC00	CC32	PC
Smooth Band	16	5	6
Warm Brass	16	5	7
Sforzato Brass	16	5	8
Horns & Strings	16	5	9
Brass Overtone	16	5	10
Shake Brass2 Y+	16	5	11
Cup Mute Brass	16	5	12
Ballad Brass	16	5	13
BigCountry Horns	16	5	14
Smooth Band RX	16	5	15
SaxEns.& Brass V	16	5	16
MorphAttackBrass	16	5	17
Club Brass Sect.	16	5	18
Club Sax & Muted	16	5	19
Cornet & Sax Ens	16	5	20
Cornet&Brass Ens	16	5	21
Sax & Cornet Ens	16	5	22
Muted Ensemble	16	5	23
Swell Brass DNC	16	5	24
Trumpet			
JazzTrumpet Leg.	16	6	0
Fluge Horn	16	6	1
Miles Muted Trp	16	6	2
Cup Trumpet	16	6	3
Hard Trombone	16	6	4
Cornet Legato	16	6	5
Muted Atmo	16	6	6
Trumpets Atmo	16	6	7
Mute Cornet Leg.	16	6	8
Miles Trp Leg. 1	16	6	9
Miles Trp Leg. 2	16	6	10
Jazz Trumpet 1	16	6	11
Cornet & Growl	16	6	12
Jazz Trombone 1	16	6	13

Keyboard Set	CC00	CC32	PC
Soft Trombone	16	6	14
Dixie Trumpet	16	6	15
Sweet Flugel	16	6	16
Trumpet Delay	16	6	17
eXp Trombone	16	6	18
Club Sax & Trp	16	6	19
Band Trumpet V.	16	6	20
Trump.& Clarinet	16	6	21
Muted Trp. Band	16	6	22
Jazz Trombone 2	16	6	23
Folk Trumpets	16	6	24
Cornet & Strings	16	6	25
Jazz Cornet	16	6	26
Jazz Cornet 1 FX	16	6	27
Jazz Cornet 2 FX	16	6	28
Miles Trp FX	16	6	29
Jazz Trumpet 2	16	6	30
Jazz Trombone 3	16	6	31
Sax			
Jazz Sax 1	16	7	0
Jazz Sax 2	16	7	1
Tenor Sax 1	16	7	2
Tenor Sax 2	16	7	3
Soft Latin Sax 1	16	7	4
Soft Latin Sax 2	16	7	5
Soprano Sax	16	7	6
Kenny Soprano	16	7	7
Jazz Baritone 1	16	7	8
Jazz Baritone 2	16	7	9
Jazz Tenor Sax	16	7	10
Sweet Alto Sax 1	16	7	11
Sweet Alto Sax 2	16	7	12
Sweet Tenor Sax	16	7	13
Alto Sax	16	7	14

Keyboard Set	CC00	CC32	PC
Tenor Sax 4	16	7	15
Breath Tenor Sax	16	7	16
Super Tenor Sax	16	7	17
Soprano Pad	16	7	18
Sax Ensemble	16	7	19
Super Sax Sect.1	16	7	20
Miller Serenade	16	7	21
Sax & Brass V.	16	7	22
Super Sax Sect.2	16	7	23
Super Sax Sect.3	16	7	24
Super Sax Sect.4	16	7	25
Sax Sect. & Trp	16	7	26
Woodwind			
Latin Flute	16	8	0
Concert Flute	16	8	1
eXp Whistle	16	8	2
Jazz Flute 1	16	8	3
Clarinet 1	16	8	4
Clarinet 2	16	8	5
Real Clarinet	16	8	6
Soft Clarinet	16	8	7
Classic Flute	16	8	8
Jazz Flute 2	16	8	9
Flute	16	8	10
Clarinet 3	16	8	11
Cool Oboe 1	16	8	12
Cool Oboe 2	16	8	13
Whistle	16	8	14
Panflute	16	8	15
Shakuhachi	16	8	16
Dynamic Flute	16	8	17
Dixie Clarinet	16	8	18
Whistling Rain	16	8	19
Fruillato Flute	16	8	20

Keyboard Set	CC00	CC32	PC
Bottle Flute	16	8	21
Panflute & Synth	16	8	22
Reeds & Trombone	16	8	23
March Whistle	16	8	24
Flutes&Clarinets	16	8	25
Flute & Muted	16	8	26
Clarinets & RX	16	8	27
Synth			
Fat Synth + Sub	16	9	0
Next Dance	16	9	1
Bros Buzz Y+	16	9	2
Rhythmsfere	16	9	3
Evolving Pad	16	9	4
Next Octave	16	9	5
Symph Synth	16	9	6
Talking Lead	16	9	7
Hybrid Lead	16	9	8
Distortion Synth	16	9	9
Analog Lead	16	9	10
Big Lead	16	9	11
Mini Lead	16	9	12
Big One	16	9	13
Pilot Lead	16	9	14
Portamento Lead	16	9	15
Gliding Lead	16	9	16
Prophy Lead	16	9	17
Waky Lead	16	9	18
Big Lead Sine	16	9	19
Tekno City	16	9	20
Cosmic Sweep	16	9	21
Talking Pad	16	9	22
Fresh Pad	16	9	23
Dream Pad	16	9	24
Double Sweep	16	9	25

Keyboard Set	CC00	CC32	PC
Trinity Pad	16	9	26
Moon Pad	16	9	27
Pa800 Pad	16	9	28
Wave Synth	16	9	29
Wave Sequence	16	9	30
Space Trailer	16	9	31
Far Memories	16	9	32
Step Sequencer	16	9	33
My Sequencer	16	9	34
Pisco Pad	16	9	35
Aereosonic	16	9	36
Rhythmical Synth	16	9	37
S&H Pad	16	9	38
Movie Stack 1	16	9	39
Movie Stack 2	16	9	40
Movie Stack 3	16	9	41
Movie Stack 4	16	9	42
Eastern Depths	16	9	43
Wide Attack	16	9	44
Ethnic			
Mandolin	16	10	0
Mandolins Orch.	16	10	1
Mandolin Tremolo	16	10	2
Napoli Mandolin	16	10	3
Sitar	16	10	4
IndianFret.&Nay	16	10	5
Real Banjo	16	10	6
Berimbau	16	10	7
Pedal Steel Gtr	16	10	8
Hawaiian Guitar	16	10	9
Oriental Feel	16	10	10
User/Piano			
Italian GRAND	17	0	1

Keyboard Set	CC00	CC32	PC
Italian Jazz P.	17	0	2
It.Grand Stack 1	17	0	3
It.Grand Stack 2	17	0	4
Grand & Ensemble	17	0	5
Grand & Orch.	17	0	6
It. Grand Atmo	17	0	7
Octave 2 Pianos	17	0	8
User/Strings & Orch.			
Movie Action	17	1	0
Soft Strings	17	1	1
Strings & Vocal	17	1	2
Movie Orchestra	17	1	3
Vocal Brass	17	1	4
Marcato Strings	17	1	5
Flute & Strings	17	1	6
Soprano &Strings	17	1	7
Steel Gtr & Str.	17	1	8
Vocoder 1	17	1	9
Vocoder 2	17	1	10
Vocoder 3	17	1	11
Vocoder 4	17	1	12
User/Wood & Accord.			
Tenor Jazz Sax 1	17	2	0
Tenor Jazz Sax 2	17	2	1
Robin Whistle	17	2	2
Bandoneon+Short	17	2	3
It. Accordion16'	17	2	4
It. Accordion 8'	17	2	5
It. Acc. 16'+8'	17	2	6
It. Acc. 16'+4'	17	2	7
It.Acc.16'+8'+4'	17	2	8
It. Accordion 4'	17	2	9
It. Acc. 8'+4'	17	2	10

Keyboard Set	CC00	CC32	PC
It.Acc.& Strings	17	2	11
User/Pipe Organ			
Tutti A	17	3	0
Tutti B	17	3	1
Sesquialtera	17	3	2
Plenum A	17	3	3
Plenum B	17	3	4
Plenum C	17	3	5
Plenum D	17	3	6
Plenum E	17	3	7
Pipe Cornet	17	3	8
Viola+Cornet	17	3	9
Principal 8'	17	3	10
Pipe Flute 8'	17	3	11
Gamba 8'	17	3	12
Trumpet Pipes	17	3	13
Pipe Octave	17	3	14
Pipe Super Oct.	17	3	15
Pipe Fifth	17	3	16
Principal+Flute	17	3	17
Nazard A	17	3	18
Nazard B	17	3	19
Flute8'+Flute4'	17	3	20
Flute8'+Flute2'	17	3	21
Gamba+Flute	17	3	22
Celeste	17	3	23
Princ 1 - 2 man.	17	3	24
Princ 2 - 2 man.	17	3	25
Princ 3 - 2 man.	17	3	26
Princ 4 - 2 man.	17	3	27
Flute 1 - 2 man.	17	3	28
Flute 2 - 2 man.	17	3	29
Nazard - 2 man.	17	3	30

Keyboard Set	CC00	CC32	PC
Terziana - 2 man.	17	3	31
Cornet - 2 man.	17	3	32
Larigot - 2 man.	17	3	33
Trumpet - 2 man.	17	3	34
Plenum1 - 2 man.	17	3	35
Plenum2 - 2 man.	17	3	36
Tutti - 2 man.	17	3	37
User/Synth			
Poly6 + JP8	17	4	0
JP8	17	4	1
80's Mellow	17	4	2
80's Super Pad	17	4	3
Analog Synth	17	4	4
Synth Yes	17	4	5
EDM Synth	17	4	6
Dance Basic	17	4	7
Thin PulSeq DNC	17	4	8
Noise Lead DNC	17	4	9
Synth Whooo	17	4	10
Mellow Perc. Pad	17	4	11
Dance Syn Perc	17	4	12
Lfo Sound bpm	17	4	13
Spire Synth	17	4	14
Leadscape	17	4	15
Fing.GlideSquare	17	4	16
Big Side Attack	17	4	17
Groove SynthGtr.	17	4	18
Dubstep Synth	17	4	19
Caos Synth	17	4	20
Robert Bass	17	4	21
Fifth Bass	17	4	22
Widebass	17	4	23
Triangle Solo	17	4	24

Keyboard Set	CC00	CC32	PC
Square Solo	17	4	25
Saw Solo	17	4	26
Square & Pulse	17	4	27
16-8-4 & Sub32	17	4	28
User/Fantasy			
Mixed Echoes	17	5	0
Running bpm	17	5	1
Fisarmony	17	5	2
Pacific Sea	17	5	3
Nighthawk	17	5	4
Wave Echoes	17	5	5

Keyboard Set	CC00	CC32	PC
Hans Sound	17	5	6
Landscape	17	5	7
Waterland	17	5	8
Meditation Stack	17	5	9
Layers Enjoy	17	5	10
Ipnotic bpm	17	5	11
User	17	0-10	0-47
Direct User	18	0-10	0-47

Sounds

The following table lists all Factory Sounds as they appear in the Sound Select window. The table also includes MIDI data used to remotely select the Sounds. CC00: Control Change 0, or Bank Select MSB. CC32: Control Change 32, or Bank Select LSB. PC: Program Change.

Sound	CC00	CC32	PC	Sound	CC00	CC32	PC
Factory/Piano				Factory/E. Piano			
Concert Grand	121	13	0	Upright Piano	121	15	0
Pop Grand	121	12	0	Tine EP Phaser	121	27	4
Warm Grand	121	10	0	Tine EP Dyno	121	28	4
Jazz Piano	121	5	0	Tine EP Amp/Pha	121	29	4
Rock Piano	121	8	0	Wet Tine EP	121	31	4
Live Piano	121	6	1	Dist. Tine EP	121	30	4
Pop Upright	121	14	0	Bell Tine EP	121	32	4
M1 Piano	121	2	2	Classic Tine EP	121	45	4
Classic Piano	121	4	0	Suit Case88 EP1	121	34	4
Bright Piano	121	5	1	Wurly Logic	121	36	4
G.Piano Stack 1	121	8	2	Wurly Amp	121	38	4
G.Piano Stack 2	121	9	2	Wurly Clean 1	121	39	4
Honky-Tonk	121	2	3	Wurly Clean 2	121	41	4
Ragtime Piano	121	3	3	Reed EP Clean	121	37	4
E. Grand Piano	121	12	2	Wurly Amp/Comp	121	40	4
Grand&MovingPad	121	9	0	Natural Wurly	121	44	4
Grand & Strings	121	7	0	Tremolo Wurly	121	16	4
Midi Grand & Pad	121	4	1	VPM Tine 1	121	18	5
Harpichord 1	121	7	6	VPM Tine 2	121	19	5
Harpichord 8+4'	121	8	6	VPM Tine 3	121	17	5
ClassicClav1 DNC	121	7	7	Digi E. Piano	121	14	5
ClassicClav2 DNC	121	8	7	Classic Tines	121	9	5
Piano Layers	121	6	2	DW8000 EP	121	11	5
Grand & FM Stack	121	7	2	Natural EP	121	43	4
Piano & Vibes	121	6	0	E. Piano Halo	121	1	94
Grand Piano Demo	121	11	0	Thin E. Piano	121	9	4
Grand Piano	121	3	0	EP+Damper 1	121	25	4

Sound	CC00	CC32	PC
Tine E. Piano 1	121	18	4
Club E. Piano	121	11	4
Suit E. Piano 1	121	20	4
Suit E. Piano 2	121	21	4
Classic Wurlly 1	121	17	4
Classic Wurlly 2	121	12	4
R&B E. Piano	121	8	4
Factory/Mallet & Bell			
Vibraphone 1	121	2	11
Marimba	121	7	12
Marimba Key Off	121	2	12
Xylophone	121	1	13
Glockenspiel	121	2	9
Celesta	121	1	8
Music Box	121	2	10
Balaphon	121	6	12
Kalimba 1	121	2	108
Kalimba 2	121	1	108
Sistro	121	1	9
Orgel	121	1	10
Warm Steel	121	1	114
Vs Bell Boy	121	2	98
Tubular Bell	121	4	14
Bells	121	3	14
Santur	121	1	15
Mallet Clock	121	5	12
Factory/Accordion			
Harmonica 1 DN1	121	11	22
Harmonica 1 DN2	121	12	22
Harmonica 2 DN1	121	13	22
Harmonica 3 DN1	121	14	22
Melodica	121	15	22
Classic Musette	121	29	21
French Musette	121	18	21

Sound	CC00	CC32	PC
Musette 1	121	3	21
2 Voices Musette	121	16	21
3 Voices Musette	121	17	21
Cassotto 16'	121	12	21
Tango Accordion	121	10	23
Fisa Tango	121	1	23
Fisa Master	121	8	21
Fisa 16,4'	121	7	21
Fisa 16,8'	121	6	21
Accordion	121	24	21
Accordion 16,4'	121	7	23
Accordion 16,8'	121	2	23
Acc.16,8,4' Plus	121	8	23
Acc. Clarinet OT	121	19	21
Acc. Piccolo OT	121	21	21
Accordion Bass	121	5	23
Acc. & Acc. Bass	121	9	23
Acc.16,8' & Bass	121	4	23
Steirisch.Akk.1	121	25	21
Steirisch.Akk.2	121	26	21
Factory/Organ			
DRAWBARS	121	127	16
Jimmy Organ	121	13	18
Perc. Organ 1 V.	121	9	17
Perc. Organ 2 V.	121	11	17
BX3 Rock 1	121	14	18
BX3 Rock 2	121	15	18
BX3 Rock 3	121	16	18
BX3 Rock 4	121	17	18
BX3 Full V.	121	6	16
BX3 Jazz V.	121	20	16
BX3 Jazz Pc. V.	121	9	18
BX3 Gospel	121	37	16
Gospel Organ 1	121	38	16

Sound	CC00	CC32	PC
Jazz Organ	121	8	16
Organ LowPc V.	121	4	17
Organ Low	121	39	16
Organ Low 1 V.	121	15	16
Big Theatre Org.	121	30	16
Theatre Organ 1	121	22	16
Theatre Organ 2	121	23	16
Wunder Organ	121	12	17
VOX Legend	121	11	16
60's Organ	121	40	16
Pianola	121	6	20
Pipe Tutti 1	121	6	19
Pipe Tutti 2	121	8	19
Pipe Tutti 3	121	9	19
Pipe Tutti 4	121	10	19
Church Pipes	121	4	19
Full Pipes	121	5	19
Flauto Pipes	121	3	20
Pipe Mixture	121	3	19
Pipe Flute 1	121	4	20
Pipe Flute 2	121	5	20
Small Pipe	121	2	20
Positive Organ	121	7	19
Organ Pedal 1	121	11	32
Factory/Guitar			
Concert Gtr DNC	121	20	24
Nylon GuitarDNC	121	18	24
7Str.GuitarDNC	121	28	24
NaturalSteel DNC	121	47	25
Acous.Steel1 DNC	121	48	25
Acous.Steel2 DNC	121	49	25
Real Dobro DNC	121	50	25
ViolaCaipira DNC	121	45	25
ClassicSteel DNC	121	36	25

Sound	CC00	CC32	PC
RealFolk Gtr DNC	121	34	25
SteelGtrPro DNC	121	19	25
Strum 12Str. DNC	121	33	25
Strat N DI DNC	121	39	27
Strat N CIn DNC	121	38	27
Strat N DI Mute	121	23	28
Strat N CIn Mute	121	22	28
Strat B DI DNC	121	45	27
Strat B Ovd DNC	121	5	29
Strat B DI Mute	121	28	28
Strat B Ovd Mute	121	6	29
Tele M DI DNC	121	41	27
Tele M CIn DNC	121	40	27
Tele M DI Mute	121	25	28
Tele M CIn Mute	121	24	28
LesP M DI DNC	121	43	27
LesP M CIn DNC	121	42	27
LesP M DI Mute	121	27	28
LesP M CIn Mute	121	26	28
33X B DI DNC	121	44	27
33X B Dst DNC	121	17	30
33X B DI Mute	121	29	28
33X B Dst Mute	121	18	30
Dist. Gtr 1 DNC	121	16	30
Dist. Gtr 2 DNC	121	14	30
Crunch Gtr DNC	121	3	29
Stereo Dist.Gtr	121	8	30
Jazz Gtr 1 DNC	121	8	26
Oct. Jazz Guitar	121	9	26
Soft Jazz Guitar	121	5	26
Clean Jazz 1	121	23	27
Stra.GtrUpDwDNC	121	33	27
E.Gtr Ch/Dly DNC	121	35	27
Real El. Gtr ST1	121	28	27

Sound	CC00	CC32	PC
Single Coil Pro	121	14	27
Pat Guitar Synth	121	10	26
Chorus Guitar	121	3	27
Chorus Gtr Pro	121	18	27
Power Chords 1	121	15	30
Factory/Strings & Vocal			
ClassicViolinDN1	121	14	40
ClassicViolinDN2	121	13	40
Conc. Violin DN1	121	12	40
Real Strings DNC	121	13	49
Cinematic Ens.	121	25	48
Movie Strings 1	121	5	49
Studio Strings	121	19	49
Epic Soundtrack	121	28	48
Choir & Scat	121	28	52
Ballad Strs. DNC	121	17	49
Ballad Strings	121	18	49
Real Spiccato	121	14	49
Real Staccato	121	15	49
Real Marcato	121	16	49
Real Tremolo	121	2	44
Real Pizzicato	121	4	45
OrchestraTutti 1	121	14	48
Strings&Orch.V.	121	24	48
Pizz. Section	121	2	45
Real Quartet 1	121	26	48
Real Quartet 2	121	27	48
Violin DN2	121	10	40
Violin Expr. DN2	121	11	40
Real Viola DN1	121	3	41
Viola Expr.	121	1	41
Real Cello	121	2	42
Real Contrabass	121	2	43
Full Choir	121	25	52

Sound	CC00	CC32	PC
Hmm Choir	121	13	53
DaDiPaTu & Bass	121	26	52
DaDiDuLaPaTu	121	27	52
Unknown Ens.	121	11	53
Unknown Choir	121	10	53
Lyrical Choir	121	9	53
Firemen Choir	121	24	52
Closed Mouth	121	7	54
Sweet Sopr. Halo	121	12	53
Sweet Sopr. Solo	121	7	53
SopranoVox1 DNC	121	4	53
QueenNight Sopr.	121	8	53
Femal&Male Scat	121	14	52
Scat V.& Bass 1	121	17	52
Cycle Scat 1	121	21	52
Ooh Slow Voice	121	3	52
Oh-Ah Voices	121	9	52
Little Boy Voice	121	23	52
Ooh Choir	121	6	52
Strings & Glock.	121	18	48
Orch. & Oboe 1	121	16	48
Orchestra&Flute	121	20	48
Strings & Horns	121	15	48
Classic Harp	121	2	46
Analog Strings 1	121	5	50
Synth Strings 1	121	6	50
Synth Voices	121	6	54
Full Vox Pad	121	9	91
Vocalscape	121	3	54
Fresh Breath	121	7	91
Heaven	121	3	91
Airways	121	3	53
Factory/Trumpet & Trbn.			
Real Flugel DN2	121	37	56

Sound	CC00	CC32	PC
Real Muted DN2	121	10	59
Jazz Trumpet DN1	121	33	56
Jazz Trumpet DN2	121	34	56
Cup Muted DN2	121	9	59
Concert Trumpet	121	19	56
Jazz Cornet DN1	121	32	56
Jazz Cornet DN2	121	36	56
Jazz Trb. DN1	121	20	57
Jazz Trb. DN2	121	21	57
Soft Trb. DN1	121	22	57
Soft Trb. DN2	121	23	57
HardTrombone DN1	121	24	57
HardTrombone DN2	121	25	57
Mute Trumpet	121	5	59
Wah Trumpet	121	2	59
Muted Trp.1 DN1	121	6	59
Muted Trp.2 DN1	121	7	59
Muted Cornet DN1	121	8	59
Sweet FlugelHorn	121	12	56
Real French Horn	121	11	60
French Horn	121	9	60
Euphonium	121	7	58
Tuba Gold	121	2	58
Alp Tuba	121	6	58
Oberkr. Tuba	121	1	58
Factory/Brass			
Swing Horns DNC	121	40	61
Ballade Brass	121	41	61
Horns Swell1 DNC	121	38	61
Horns Swell2 DNC	121	39	61
Big Band Brass 1	121	32	61
Big Band Brass 2	121	4	61
Tight Brass 1	121	27	61

Sound	CC00	CC32	PC
Tight Brass 2	121	29	61
Trpt. & Horns	121	5	60
Trpts & Trombs	121	34	61
Tight Brass 3	121	2	61
Brass of Power	121	30	61
Movie Brass	121	20	61
Brass Expr.	121	15	61
Glenn & Friends	121	3	61
French Section	121	2	60
French Horns	121	10	60
Soft Horns 1	121	8	60
Trombones DNC	121	10	61
Trumpets DNC	121	42	61
TrumpetsHar Mute	121	43	61
TrumpetsCup Mute	121	44	61
Mute Ensemble 1	121	3	59
Mute Ensemble 2	121	4	59
Flute Muted	121	6	73
Synth Brass 1	121	5	62
Electric Brass	121	4	62
Factory/Sax			
Tenor Sax DN1	121	16	66
Tenor Sax DN2	121	17	66
Tenor Growl DN1	121	18	66
Jazz Sax DN1	121	20	65
Jazz Sax DN2	121	21	65
PopAltoSax DN1	121	22	65
Alto Sax DN1	121	23	65
SoftAltoSax DN1	121	24	65
Soprano Sax DN1	121	6	64
Baritone Sax DN1	121	6	67
Cool Sax Ens.	121	11	65
Sax Ens. Legato	121	19	65

Sound	CC00	CC32	PC
SaxEns.Leg.Sfz	121	25	65
Factory/Woodwind			
ConcertFlute DN1	121	15	73
ConcertFlute DN2	121	16	73
Latin Flute DN1	121	17	73
Latin Flute DN2	121	18	73
RealClarinet DN1	121	21	71
JazzClarinet DN1	121	22	71
Oboe 1	121	5	68
Cool Oboe	121	3	68
Bassoon DNC	121	2	70
Bassoon	121	1	70
Double Reed	121	1	68
Piccolo	121	3	72
Ocarina	121	1	79
Shakuhachi	121	2	77
Shakuhachi Vel.	121	3	77
Pan Flute DN1	121	5	75
Blown Bottle	121	1	76
Whistle DN1	121	6	78
Clar & Sax Ens 1	121	17	71
Clar & Sax Ens 2	121	18	71
Reeds & Saxes	121	10	71
Small Orchestra	121	1	72
Factory/Synth Pad			
Warm Pad	121	15	89
Square Pad	121	15	90
Dark Pad	121	6	89
Analog Pad 1	121	8	89
Symphonic Ens.	121	14	89
Warm Buzz	121	17	89
Matrix 12 Pad	121	14	90
The Pad	121	4	89
Evolving Pad	121	4	88

Sound	CC00	CC32	PC
Rhythmsphere	121	11	96
Far Muted Atmos.	121	5	88
Far Memories	121	14	91
Atmoschoir Pad	121	15	91
Space Trailer	121	1	103
Jurassic Pad	121	3	88
Pisco Pad	121	2	99
Tension Scene	121	8	97
Dronas Pad	121	4	93
Moon Cycles	121	5	102
Movie Stack 1	121	4	99
Movie Stack 2	121	5	99
Movie Stack 3	121	6	99
Eastern Depths	121	8	99
S&H Pad DNC	121	10	96
Wave-Sequence	121	4	96
Aerosonic	121	5	96
My Sequencer	121	6	96
Step Sequencer	121	7	96
Big Panner	121	4	63
Choir-Sequence	121	13	91
Pop Synth Pad 1	121	4	91
Air Clouds	121	1	97
Digi Ice Pad	121	2	101
Cinema Pad	121	5	95
Vintage Sweep	121	7	95
Meditate	121	2	95
Super Sweep	121	4	90
Wave Sweep	121	5	90
Next Analog	121	16	89
Cosmic	121	1	93
Bell Pad	121	6	98
Future Pad	121	5	91
Fresh Air 1	121	2	91

Sound	CC00	CC32	PC
Fresh Air 2	121	11	91
80's Pop Synth	121	2	93
Blender	121	1	92
Deep Noise	121	4	127
Factory/Synth Lead			
Next Dance DNC	121	13	87
Lab Synth DNC	121	8	84
Deep Modul. DNC	121	10	84
Bros Buzz Y+	121	14	87
Trance Filter	121	16	87
Parallel Trance	121	9	84
Vintage Monster	121	17	87
Summit Pulse	121	13	81
Fat Synth	121	15	87
FatSynth OctSub	121	19	87
Polysix	121	15	81
Polysix & Sub	121	16	81
Bass Phat Saw	121	12	87
Phat Saw Lead	121	8	81
Fast Glide Saw	121	20	81
Octo Lead	121	6	81
Wave Lead	121	5	80
Simple Square	121	14	80
Noisy Stabb	121	8	90
Big & Raw	121	8	87
Old Portamento	121	3	80
MonoSaw detune	121	17	81
MonoSaw 2 Oct.	121	18	81
MonoSaw 3 Oct.	121	19	81
Justified	121	11	84
Side Distortion	121	13	84
Revolution	121	12	84
Reverse Pulse	121	14	81
Metallic Rez	121	4	84

Sound	CC00	CC32	PC
Dance ReMix	121	10	91
Rave	121	6	97
Synth Pianoid	121	12	81
HipHop Lead	121	6	87
Port White	121	12	80
Sub Harmonic	121	15	80
Factory/Ethnic			
Mandolin DNC	121	40	25
Mandolin	121	43	25
Mandolin Orch.1	121	41	25
Mandolin Orch.2	121	42	25
Real Cavaquinho	121	27	24
Cavaquinho 1	121	23	24
Cavaquinho 2	121	24	24
Bandolim	121	46	25
Berimbau DNC	121	2	106
Berimbau Rel.DNC	121	1	106
Real Ukulele	121	25	24
Zither	121	9	104
Sitar	121	8	104
Sitar Tambou	121	2	104
Indian Frets	121	4	104
Fiddle	121	1	110
Banjo Thumb DNC	121	6	105
Banjo Fin/Th.DNC	121	7	105
Banjo Key Off	121	1	105
Banjo	121	4	105
Kanoun 1	121	5	107
Kanoun 2	121	2	107
Kanoun Trem. 1	121	6	107
Kanoun Trem. 2	121	3	107
Kanoun Mix	121	4	107
Oud 1	121	5	105
Oud 2	121	2	105

Sound	CC00	CC32	PC
Bouzouki	121	5	104
Nay	121	2	72
Kawala	121	1	75
Clarinet G	121	2	71
Klarnet 1	121	11	71
Klarnet 2	121	12	71
Hichiriki	121	2	111
HighlandBagPipes	121	3	109
Uilleann BagPipes	121	2	109
Zurna 1	121	3	111
Zurna 2	121	1	111
Gamelan	121	1	112
Garbage Mall	121	3	112
Jaw Harp	121	3	105
Ac. Baglama 1	121	7	107
Ac. Baglama 2	121	8	107
Ac. Baglama Grp.	121	9	107
Factory/Bass			
Real Ac. Bass 1	121	13	32
Acoustic Bass 1	121	14	32
Acous. Bass Pro1	121	3	32
Ac. Jazz Bass	121	9	32
JB Finger BsDN1	121	29	33
JB Finger BsDN2	121	30	33
JB Pick Bs DN1	121	18	34
JB Pick Bs DN2	121	19	34
JB Fing.Slap Bs	121	32	33
JB Slap Bass	121	8	36
PBs Fing.Pop DN1	121	33	33
PBs Fing.Pop DN2	121	34	33
SR Finger BsDN1	121	27	33
SR Finger BsDN2	121	28	33
SR Pick Bs DN1	121	16	34
SR Pick Bs DN2	121	17	34

Sound	CC00	CC32	PC
SR Fing.Slap Bs	121	31	33
SR Slap Bass	121	9	36
PBsFing.Vint.DN1	121	25	33
PBsFing.Vint.DN2	121	26	33
FS Pick BsDN1	121	14	34
FS Pick BsDN2	121	15	34
Fretless Bs DN1	121	11	35
FretlessVib.DN1	121	10	35
Finger Bass DN1	121	16	33
Dark Bs&Slap DN1	121	7	36
Stein Bass	121	3	34
Woofers Pusher 1	121	9	35
Finger E.Bass 1	121	7	33
Finger E.Bass 2	121	4	33
Chorus Fing.Bass	121	8	33
Vintage P. Bass	121	23	33
Vintage P. Flat	121	18	33
Vintage P. Pick	121	12	34
Picked Jazz Bass	121	13	34
Picked E. Bass 1	121	2	34
Sweet Fretless	121	3	35
Fretless Bass 1	121	1	35
Thumb Bass	121	1	37
Bass & Ride 2	121	2	32
FingerB.& Guitar	121	14	33
Bass&Gtr Double	121	6	34
Super Bass 1	121	2	36
LegatoSynthBass	121	20	38
Synth Bass 1	121	18	38
Basic Saw Bass	121	18	39
Digi Bass 1	121	11	38
Willy FM Bass	121	19	38
Syn Bass Reso.	121	8	38
Jungle Bass	121	13	38

Sound	CC00	CC32	PC
Jungle Reso.	121	5	39
30303 Bass	121	5	38
Disclosure Bass	121	16	39
Fancy Bass	121	17	39
Techno Org.Bass	121	6	17
Org. Synth Pulse	121	13	17
Phunk Synth Bass	121	14	39
Poinker Bass	121	8	39
Drive Bass	121	17	38
Legacy/Piano			
Piano Pad 1	121	2	1
Piano Pad 2	121	3	1
90's Piano	121	3	2
2000's Piano	121	4	2
Chorus Piano	121	5	2
E. Grand Phaser	121	10	2
Saloon Piano	121	4	3
Harpsichord 2	121	6	6
Harpsi 16'	121	5	6
Harpsi Korg	121	4	6
Clav Snap	121	3	7
Sticky Clav	121	4	7
Clav	121	5	7
Clav Wah	121	2	7
Synth Clav	121	6	7
Legacy/E. Piano			
Pro Dyno EP	121	5	4
Pro Stage EP	121	6	4
Studio EP	121	7	4
Suit Case88 EP2	121	33	4
Dyno Tine EP 1	121	10	4
Tine E. Piano 2	121	19	4
Dyno Tine EP 2	121	22	4
Bell E. Piano 1	121	23	4

Sound	CC00	CC32	PC
Bell E. Piano 2	121	24	4
EP+Damper 2	121	26	4
Vintage EP	121	4	4
Stereo Dig. EP	121	6	5
FM Stack EP	121	16	5
Hybrid EP	121	8	5
Phantom Tine	121	10	5
Soft Wurly	121	13	4
Hard Wurly	121	14	4
Velo Wurly	121	15	4
White Pad EP	121	13	5
FM Pad EP	121	15	5
Sweeping EP	121	12	5
Classic Dig. EP	121	7	5
Syn Piano X	121	5	5
Road Piano	121	11	2
E. Piano Noise	121	35	4
Wurly Noise	121	42	4
Legacy/Mallet & Bell			
Vibraphone 2	121	3	11
Monkey Skuls	121	3	12
Digi Bell	121	4	98
Krystal Bell	121	3	98
Legacy/Accordion			
Sweet Harmonica	121	1	22
Akordeon	121	2	21
Cassotto NorTune	121	14	21
Acc. Clarinet NT	121	20	21
Acc. Piccolo NT	121	22	21
Detune Accordion	121	15	21
Sweet Musette	121	11	21
Musette 2	121	4	21
Musette Clar.	121	5	21
Arabic Accordion	121	10	21

Sound	CC00	CC32	PC
Cassotto	121	9	21
Cassotto 16' DNC	121	30	21
Cassotto Or.Tune	121	13	21
Master Accordion	121	23	21
Steirisch.Akk.4	121	28	21
Harmonica	121	2	22
Harmonica AT 1	121	3	22
Harmonica AT 2	121	4	22
Harmonica 1 DNC	121	5	22
Jazz Harm. DNC	121	6	22
Sweet Harm. DNC	121	7	22
Melodica DNC	121	8	22
Harmonica 2 DNC	121	9	22
Harmonica 3 DNC	121	10	22
Accordion16,8,4'	121	3	23
Steirisch.Akk.3	121	27	21
Acc.Voice Change	121	6	23
Legacy/Organ			
Classic Click	121	4	18
Perc. Organ 1	121	10	17
Perc.Short Deca	121	8	18
Rock Organ 2	121	11	18
Jimmy Organ V.	121	10	18
BX3 Rock 1 V.	121	10	16
BX3 Rock 2 V.	121	1	18
BX3 Rock 3 V.	121	5	18
BX3 Rock 4 V.	121	12	18
Dirty B	121	3	18
Killer B	121	2	18
BX3 Short Decay	121	7	17
Super BX Perc.	121	6	18
Gospel Organ 2	121	9	16
Gospel Organ V.	121	13	16
BX3 Gospel V.	121	21	16

Sound	CC00	CC32	PC
Drawbars Organ	121	14	16
Organ Mid V.	121	16	16
Organ Hi V.	121	17	16
Drawbars Fast V.	121	18	16
Drawbars Slow V.	121	19	16
Organ Low+1'V.	121	33	16
Organ HiMix1 V.	121	34	16
Organ HiMix2 V.	121	35	16
Organ 16+51/3 V.	121	36	16
Organ Low 2 V.	121	4	16
Old Wheels	121	3	17
Dark Organ 1	121	7	16
Dark Organ 2	121	5	16
Rotary Organ	121	8	17
M1 Organ	121	5	17
Dirty JazzOrgan	121	7	18
Arabian Organ	121	12	16
Theatre Organ 3	121	24	16
Theatre Organ 4	121	25	16
Tibia	121	26	16
Tibia 16+8+4'	121	27	16
Tibia & Vox	121	28	16
Post Horn Trem.	121	29	16
Tibia & Kinura	121	31	16
Tibia Vox Glock	121	32	16
Legacy/Guitar			
Nylon Bossa	121	4	24
Nylon Vel. Harm.	121	10	24
Spanish Guitar	121	6	24
Nylon Guitar	121	15	24
Brazilian Guitar	121	9	24
Real Steel Gtr	121	31	25
Steel Folk Gtr	121	9	25
Guitar & Strings	121	7	24

Sound	CC00	CC32	PC
Finger Key Off	121	7	25
Club Jazz Gtr 2	121	3	26
Pop Steel Slide	121	23	25
Finger Tips	121	8	25
Country Nu	121	11	27
Reso Guitar	121	12	25
Tel. Middle	121	26	27
Clean Mute Gtr	121	6	28
Clean Funk	121	8	28
Hackbrett	121	6	25
Tel. Bridge	121	27	27
Guitarish	121	8	27
Stra. Gtr Slide	121	17	27
Stra. Chime	121	5	28
L&R E.Guitar 2	121	10	27
Rhythm E.Guitar	121	7	28
Muted Guitar	121	19	28
E.Gtr Harmonics	121	2	31
Solo Dist.Guitar	121	7	30
Dist. Steel Gtr	121	12	30
Joystick Gtr Y-	121	3	30
Ac.Guitar KeyOff	121	5	24
Nylon Gtr Pro1	121	8	24
Nylon Gtr Pro2	121	11	24
Nylon Gtr RX1	121	12	24
Nylon Gtr RX2	121	13	24
Nylon Slide Pro	121	14	24
RealNylon Gtr ST	121	16	24
Real Nylon Gtr	121	17	24
Natural Nylon	121	19	24
Concert Gtr Pro	121	21	24
Steel Guitar 1	121	4	25
Steel Guitar 2	121	20	25
Steel 12 Strings	121	5	25

Sound	CC00	CC32	PC
12 Strings Pro	121	17	25
Steel Slide Pro1	121	13	25
Steel Slide Pro2	121	14	25
Steel Guitar RX1	121	15	25
Steel Guitar RX2	121	16	25
12 Strings RX	121	18	25
Concert 12 Str	121	22	24
Pop Steel Gtr 1	121	21	25
Pop Steel Gtr 2	121	22	25
Pop SteelGtr RX1	121	24	25
Pop SteelGtr RX2	121	25	25
RealSteel Gtr ST	121	28	25
RealFolk GtrST 1	121	29	25
RealFolk GtrST 2	121	30	25
Real Folk Gtr	121	32	25
Steel Gtr RX	121	35	25
Classic12Str Pro	121	37	25
Classic12Str DNC	121	38	25
Classic12Strings	121	39	25
Steel Gtr DNC	121	44	25
Pedal Steel	121	4	26
JazzGtr SlidePro	121	6	26
Jazz Gtr 2 DNC	121	7	26
Club Jazz Gtr 1	121	2	26
Clean Jazz 2	121	22	27
Single Coil	121	6	27
New Stra.Guitar	121	7	27
L&R E.Guitar 1	121	9	27
Vox Wah Chick	121	3	120
Funky Wah RX	121	12	27
Clean Guitar 1	121	20	27
Clean Guitar 2	121	25	27
Clean Gtr Pro 1	121	13	27
Clean Gtr Pro 2	121	15	27

Sound	CC00	CC32	PC
Clean Guitar RX1	121	14	28
Clean Guitar RX2	121	15	28
Clean Guitar RX3	121	16	28
Clean Guitar RX4	121	17	28
Clean Guitar RX5	121	18	28
Clean Guitar RX6	121	20	28
Stra. Vel. Pro	121	16	27
Vintage S. 1	121	19	27
Vintage S. 2	121	4	27
Solid Guitar	121	21	27
'54 E. Guitar	121	24	27
Real El. Guitar1	121	30	27
Real El. Guitar2	121	31	27
Stra. Gtr 1 DNC	121	32	27
Real El. Gtr ST2	121	29	27
R&R Guitar	121	4	28
Processed E.Gtr	121	5	27
Chorus Gtr DNC	121	34	27
Clean Funk RX1	121	10	28
Clean Funk RX2	121	36	27
5th Mute Gtr	121	21	28
E.Gtr Amp DNC	121	37	27
Clean Funk RX3	121	11	28
Funk Stein RX1	121	12	28
Funk Stein RX2	121	13	28
Soft Overdrive	121	2	29
Lead Guitar DNC	121	4	29
Dist. Guitar RX1	121	9	30
Dist. Guitar RX2	121	10	30
Dist. Guitar	121	11	30
Dist. Gtr 3 DNC	121	13	30
Wet Dist. Guitar	121	6	30
Disto Mute	121	9	28
Mute Monster	121	5	30

Sound	CC00	CC32	PC
Power Chords 2	121	4	30
Legacy/Strings & Vocal			
Violin Expr. 2	121	2	40
Violin Expr. 3	121	4	40
Slow Violin	121	3	40
Violin Expr. DNC	121	5	40
Conc.Violin DNC	121	6	40
Real Violin DNC	121	7	40
Violin Expr. 1	121	8	40
Violin DNC	121	9	40
Violin & Viola	121	2	41
Cello	121	1	42
Class.Contrabs	121	1	43
Strings Ens. 1	121	21	48
Strings Ens. 2	121	3	49
Movie Str.1 DNC	121	7	49
Movie Str.2 DNC	121	8	49
ConcertStrings 2	121	23	48
i3 Strings	121	5	48
Real Strings 1	121	9	49
Real Strings 2	121	10	49
Movie Strings 2	121	6	49
Full Strings	121	2	49
Spiccato Strings	121	4	49
ConcertStrings 1	121	11	49
StrappatoStrings	121	12	49
Symphonic Bows	121	10	48
Ensemble & Solo	121	11	48
Tremolo Strings	121	1	44
Pizz. Ensemble	121	1	45
Strings Ens. 3	121	22	48
Stereo Strings	121	3	48
Double Strings	121	3	45
Legato Strings	121	4	48

Sound	CC00	CC32	PC
N Strings	121	6	48
Arco Strings	121	7	48
Octave Strings	121	8	48
Arabic Strings	121	13	48
Strings Quartet	121	9	48
Chamber Strings	121	12	48
OrchestraTutti 2	121	19	48
Strings Choir	121	13	52
Dream Voice	121	5	54
Classic Vox	121	4	54
Doolally	121	2	53
Ooh Voices	121	2	52
Take Voices 1	121	4	52
Wuuh Choir	121	8	52
Vocalesque	121	2	54
Grand Choir	121	11	52
Femal Scat	121	15	52
Male Scat	121	16	52
Cycle Scat 2	121	22	52
Scat V.& Bass 2	121	18	52
Scat Voices	121	19	52
Scat Voices DNC	121	20	52
SopranoVox2 DNC	121	5	53
SopranoChoirDNC	121	6	53
Orch. & Oboe 2	121	17	48
Master Pad	121	2	89
Take Voices 2	121	5	52
Aah Choir	121	7	52
Choir Light	121	12	52
Slow Choir	121	10	52
Cyber Choir	121	2	85
Ether Voices	121	1	85
Odyssey	121	4	50
Sweeper Strings	121	1	49

Sound	CC00	CC32	PC
Analog Strings 2	121	2	50
Synth Strings 2	121	1	51
Analog Velve	121	3	50
Legacy/Trumpet & Trbn.			
Mono Trumpet	121	3	56
Warm Flugel	121	8	56
Pitch Trombone	121	5	57
Soft Trombone	121	4	57
Trombone	121	12	57
BeBop Cornet	121	9	56
Flugel Horn	121	7	56
Dynabone	121	3	58
Ob.Tuba&E.Bass 1	121	4	58
Ob.Tuba&E.Bass 2	121	5	58
Dual Trumpets	121	6	56
Trumpet Pro 1	121	10	56
Trumpet Pro 2	121	11	56
Trumpet Overb.	121	2	56
Flugel Horn Pro	121	13	56
Trumpet	121	14	56
Trumpet Expr.1	121	15	56
Trumpet Expr.2	121	4	56
TrumpetShake Y+	121	18	56
Trumpet Pro 3	121	16	56
Trumpet Pitch	121	5	56
Alp Trumpet	121	17	56
Concert Trp. Pro	121	20	56
Cornet Expr.	121	21	56
Cornet Pro 1	121	22	56
Cornet Pro 2	121	23	56
Cornet Legato	121	31	56
JazzTrumpet1 DNC	121	24	56
JazzTrumpet4 DNC	121	30	56
JazzTrumpet5 DNC	121	35	56

Sound	CC00	CC32	PC
JazzCornet 1 DNC	121	25	56
Trumpet Expr.DNC	121	26	56
JazzTrumpet2 DNC	121	27	56
JazzTrumpet3 DNC	121	28	56
JazzCornet 2 DNC	121	29	56
Hard Trombone	121	3	57
HardTrombone DNC	121	19	57
Trombone Expr. 1	121	6	57
Trombone Expr. 2	121	7	57
Trombone Vel. 1	121	8	57
Trombone Vel. 2	121	9	57
Trombone Vel. 3	121	10	57
Trombone Pro Vel	121	11	57
Trombone DNC	121	13	57
Jazz Trb. 2 DNC	121	14	57
Jazz Trb. 1 DNC	121	15	57
Soft Trb. DNC	121	16	57
Trb. Expr. DNC	121	17	57
Jazz Trb. 3 DNC	121	18	57
Legacy/Brass			
Attack Brass	121	8	61
Big BandShake Y+	121	33	61
Trumpet Ens1 Y+	121	35	61
Trumpet Ens2 Y+	121	36	61
Dyna Brass 1	121	14	61
Dyna Brass 2	121	22	61
Double Brass	121	24	61
Power Brass	121	21	61
Film Brass	121	17	61
Glenn & Boys	121	6	61
Brass Slow	121	18	61
Fanfare	121	19	61
Synth Brass 2	121	5	63
Brass Pad	121	3	63

Sound	CC00	CC32	PC
Netherland Hit	121	8	55
Brass Impact	121	4	55
Classic Horns	121	3	60
Horns & Ensemble	121	4	60
Brass & Sax	121	16	61
Trpts & Brass	121	7	61
Soft Horns 2	121	7	60
Soft Horns 3	121	6	60
Trumpet Ens.	121	9	61
Trombones	121	11	61
Sax & Brass	121	5	61
Tight Brass 4	121	12	61
Fat Brass	121	13	61
Brass Hit	121	25	61
Brass Fall	121	26	61
Sforzato Brass	121	23	61
Tight Brass Pro	121	28	61
Brass Section	121	31	61
MorphAttackBrass	121	37	61
Legacy/Sax			
Folk Sax	121	5	66
Breathy Baritone	121	2	67
Breathy Alto 1	121	1	65
Breathy Tenor	121	3	66
Breathy Alto 2	121	3	65
Alto Sax Growl	121	4	65
Soft Tenor	121	2	66
Tenor Growl	121	4	66
Sweet Soprano 3	121	1	64
Soprano Pro	121	2	64
Sweet Soprano 1	121	3	64
Sweet Soprano 2	121	4	64
Soprano Sax DNC	121	5	64
Sax Ensemble	121	2	65

Sound	CC00	CC32	PC
Sweet Alto Sax 1	121	5	65
Sweet Alto Sax 2	121	6	65
Soft Alto Sax	121	7	65
Alto Sax Pro	121	8	65
Alto Sax Expr.	121	9	65
Alto Sax	121	10	65
Alto Sax 1 DNC	121	12	65
Jazz Sax 1 DNC	121	13	65
Jazz Sax 2 DNC	121	14	65
Real Sax Ens.	121	15	65
Jazz Sax 3 DNC	121	16	65
Alto Sax 2 DNC	121	17	65
SoftLatinSax DNC	121	18	65
Tenor Sax Noise1	121	1	66
Tenor Sax Noise2	121	6	66
Tenor Sax Expr.1	121	7	66
Tenor Sax Expr.2	121	8	66
Jazz Tenor Sax 1	121	9	66
Jazz Tenor Sax 2	121	10	66
Reed of Power	121	11	66
Tenor Sax 1 DNC	121	12	66
Tenor Sax 2 DNC	121	13	66
Tenor Sax 3 DNC	121	14	66
Tenor Sax 4 DNC	121	15	66
Baritone Growl	121	1	67
Baritone Sax Pro	121	3	67
Baritone Sax	121	4	67
Baritone Sax DNC	121	5	67
Sax Breath & Key	121	2	121
Legacy/Woodwind			
Folk Clarinet	121	7	71
Flute	121	9	73
Wooden Flute	121	7	73
Bambu Flute	121	8	73

Sound	CC00	CC32	PC
English Horn	121	1	69
Recorder 1	121	1	74
Recorder 2	121	2	74
Classic Oboe	121	2	68
Oboe 2	121	4	68
Jazz Clarinet	121	1	71
Section Winds 1	121	3	71
Section Winds 2	121	4	71
Clarinet Ens.	121	5	71
Woodwinds	121	6	71
Clarinet Pro 1	121	8	71
Clarinet Pro 2	121	9	71
Clarinet 1 DNC	121	13	71
RealClarinet DNC	121	14	71
JazzClarinet DNC	121	15	71
SoloClarinet DNC	121	16	71
Clarinet 2 DNC	121	19	71
Clarinet 3 DNC	121	20	71
Jazz Flute Expr.	121	1	73
Flute Switch	121	2	73
Flute Dyn. 5th	121	3	73
Flute Frullato	121	4	73
Orchestra Flute	121	5	73
Jazz Flute	121	10	73
Flute DNC	121	11	73
Orch. Flute DNC	121	12	73
Jazz Flute 1 DNC	121	13	73
Jazz Flute 2 DNC	121	14	73
Pan Flute 1 DNC	121	2	75
Pan Flute 2 DNC	121	3	75
Pan Flute Y-	121	4	75
Old Shakuhachi	121	1	77
Whistle 3	121	1	78
Breathy Whistle	121	2	78

Sound	CC00	CC32	PC
Whistle 1	121	3	78
Whistle 2	121	4	78
Whistle DNC	121	5	78
Legacy/Synth Pad			
Sky Watcher	121	2	90
Vintage Pad	121	11	89
You Decide	121	8	95
Korgmatose	121	13	90
Reoccurring Astra	121	6	95
Astral Dream	121	1	95
Reso Down	121	2	97
Crimson 5ths	121	1	86
Freedom Pad	121	7	89
Noble Pad	121	5	97
Mellow Pad	121	4	95
Lonely Spin	121	1	100
Synth Ghostly	121	2	100
Farluce	121	11	90
Bell Choir	121	7	98
Elastick Pad	121	7	97
Caribbean	121	2	96
VCF Modulation	121	3	101
Chiff Touch Pad	121	1	83
Virtual Traveler	121	1	88
Tinklin Pad	121	3	97
OB Pad	121	12	89
Dark Element	121	3	95
Money Pad	121	5	89
Analog Pad 2	121	9	89
Analog Pad 3	121	10	89
Dark Anna	121	13	89
Cross Sweep	121	6	90
Big Sweep Stab	121	12	90
Tsunami Wave	121	6	91

Sound	CC00	CC32	PC
Ravelian Pad	121	8	91
Pop Synth Pad 2	121	12	91
Techno Stab DNC	121	3	93
Double Sweep	121	9	95
Motion Ocean	121	1	96
Wave Cycle	121	3	96
Pods In Pad	121	4	97
Moving Bell	121	5	98
Bengione	121	1	99
Dreaming Coil	121	3	99
Movie Stack 4	121	7	99
Rhythmical Synth	121	9	99
Wide Attack	121	10	99
Organ Stab DNC	121	4	101
Legacy/Synth Lead			
Motion Raver	121	1	101
Synchro City	121	2	84
Wild Arp	121	6	55
Seq Lead	121	7	81
Old & Analog	121	8	80
Flip Blip	121	7	55
Reso Sweep	121	1	90
Synth Sweeper	121	3	90
Sync Kron	121	3	84
Tecno Phonic	121	10	90
Band Passed	121	3	102
Cat Lead	121	9	87
Pan Reso	121	4	102
Square Rez	121	11	80
Rezbo	121	11	81
Auto Pilot 1	121	14	38
Square Bass	121	7	87
Brian Sync	121	5	84
Arp Twins	121	6	84

Sound	CC00	CC32	PC
LoFi Ethnic	121	7	84
Dance Lead	121	4	80
Sine Wave	121	6	80
Analog Lead	121	7	80
Gliding Square	121	9	80
Sine Switch	121	10	80
2VCO Planet Lead	121	13	80
Glide Lead	121	9	81
Fire Wave	121	10	81
Electro Lead	121	2	87
Rich Lead	121	3	87
Power Saw	121	5	81
Thin Analog Lead	121	4	87
Express. Lead	121	5	87
OB Lead	121	10	87
A Leadload	121	11	87
Monster & Dist.	121	18	87
Arp Angeles	121	2	88
Power Synth	121	3	89
Digital PolySix	121	7	90
Mega Synth	121	9	90
Cycle Seq. 1	121	8	96
Cycle Seq. 2	121	9	96
Legacy/Ethnic			
Mandolin Key Off	121	10	25
War Pipes	121	1	109
Sitar Sitar	121	7	104
Hit in India	121	5	55
Tambra	121	6	104
Indian Stars	121	3	104
Bali Gamelan	121	2	112
Ukulele Gtr	121	26	24
Mandolin Trem.	121	11	25
Mandolin Ens. 1	121	26	25

Sound	CC00	CC32	PC
Mandolin Ens. 2	121	27	25
Legacy/Bass			
Ac. Bass Buzz	121	1	32
Slap Bass 1	121	6	36
Slap Bass 2	121	6	37
Slap Bass 3	121	7	37
DynaSlapBass RX	121	3	37
Chorus Slap Bass	121	4	37
DarkWoody A.Bass	121	5	32
More Mid Bass	121	11	33
Woofer Pusher 2	121	6	35
Dark R&B Bass1	121	4	35
Dyna Bass	121	2	37
Ticktacing Bass	121	9	34
Stick Bass	121	5	33
Dark R&B Bass2	121	5	35
Auto Pilot 2	121	13	39
Dr. Octave	121	16	38
Monofilter Bass	121	11	39
Synth Bass 80ish	121	9	39
Reso Bass	121	12	39
Autofilter Bass	121	10	39
Nasty Bass	121	6	39
30303 Square	121	6	38
Bass Square	121	7	38
Phat Bass	121	7	39
Blind As A Bat	121	12	38
Acous. Bass RX	121	7	32
Acoustic Bass 2	121	8	32
Real Ac. Bass 2	121	12	32
Acous. Bass Pro2	121	4	32
Bass & Ride 1	121	6	32
Organ Pedal 2	121	10	32
Finger E.Bass 3	121	2	33

Sound	CC00	CC32	PC
Finger E.Bass 4	121	3	33
Finger E.Bass 5	121	6	33
Bright Finger B.	121	9	33
FingerE.Bass1 RX	121	10	33
Finger Slap	121	12	33
FingerE.Bass2 RX	121	13	33
Finger E.Bass 6	121	15	33
Vintage P.Round	121	17	33
5StringsBass RX	121	19	33
Dark E.Bass 1	121	20	33
Dark E.Bass 2	121	24	33
FingerE.Bass3 RX	121	21	33
Dark E.Bass DNC	121	22	33
Bass & Guitar	121	4	34
Bass Mute	121	5	34
Picked E. Bass 2	121	1	34
Picked E. Bass 3	121	11	34
Picked E. Bass 4	121	7	34
Picked E. Bass 5	121	8	34
Picked E.Bass RX	121	10	34
Fretless Bass 2	121	2	35
Fretless Bass 3	121	7	35
MM Fretless DNC	121	8	35
Super Bass 2	121	1	36
FunkSlapBass RX	121	3	36
SlapFingerBassRX	121	4	36
SlapPickedBassRX	121	5	36
The Other Slap	121	5	37
Digi Bass 2	121	10	38
Digi Bass 3	121	9	38
Hybrid Bass	121	15	38
Euro Bass	121	4	39
Synth Bass 2	121	15	39

Sound	CC00	CC32	PC
GM/XG/Piano			
AcousticPiano GM	121	0	0
Ac. Piano Wide	121	1	0
Ac. Piano Dark	121	2	0
Bright Piano GM	121	0	1
Bright PianoWide	121	1	1
E.Grand Piano GM	121	0	2
E. Grand Wide	121	1	2
Honky-Tonk GM	121	0	3
Honky Wide	121	1	3
E. Piano 1 GM	121	0	4
Detuned EP 1	121	1	4
EP 1 Veloc. Mix	121	2	4
60's E. Piano	121	3	4
E. Piano 2 GM	121	0	5
Detuned EP 2	121	1	5
EP 2 Veloc. Mix	121	2	5
EP Legend	121	3	5
EP Phase	121	4	5
Harpsichord GM	121	0	6
Harpsi OctaveMix	121	1	6
Harpsi Wide	121	2	6
Harpsi Key Off	121	3	6
Clav GM	121	0	7
Pulse Clav	121	1	7
AcousticPiano XG	0	0	0
AcousticPiano KP	0	1	0
Mellow Gr. Piano	0	18	0
Piano Strings	0	40	0
Piano Dream	0	41	0
Bright Piano XG	0	0	1
Bright Piano KP	0	1	1
E.Grand Piano XG	0	0	2
E.Grand Piano KP	0	1	2

Sound	CC00	CC32	PC
E. Grand Detuned	0	32	2
Layered E.Grand1	0	40	2
Layered E.Grand2	0	41	2
Honky-Tonk XG	0	0	3
Honky-Tonk KP	0	1	3
E. Piano 1 XG	0	0	4
E. Piano 1 KP	0	1	4
Mellow EP1	0	18	4
Chorus EP 1	0	32	4
Hard El. Piano	0	40	4
Vel. X-Fade EP 1	0	45	4
60's El. Piano 1	0	64	4
E. Piano 2 XG	0	0	5
E. Piano 2 KP	0	1	5
Chorus EP 2	0	32	5
FM EP Hard	0	33	5
FM Legend EP	0	34	5
FM Phase EP	0	40	5
Dx & Analog	0	41	5
FM Koto EP	0	42	5
Vel. X-Fade EP 2	0	45	5
Harpsichord XG	0	0	6
Harpsichord KP	0	1	6
Harpsichord HP	0	25	6
Harpsi Octave	0	35	6
Clav XG	0	0	7
Clav KP	0	1	7
Clav. Wah Dyn.	0	27	7
Pulse Clav X	0	64	7
Pierce Clav	0	65	7
GM/XG/Chrom. Perc.			
Celesta GM	121	0	8
Glockenspiel GM	121	0	9
Music Box GM	121	0	10

Sound	CC00	CC32	PC
Vibraphone GM	121	0	11
Vibraphone Wide	121	1	11
Marimba GM	121	0	12
Marimba Wide	121	1	12
Xylophone GM	121	0	13
Tubular Bell GM	121	0	14
Church Bell	121	1	14
Carillon	121	2	14
Dulcimer GM	121	0	15
Celesta XG	0	0	8
Glockenspiel XG	0	0	9
Music Box XG	0	0	10
Orgel Bell	0	64	10
Vibraphone XG	0	0	11
Vibraphone KP	0	1	11
Hard Vibraphone	0	45	11
Marimba XG	0	0	12
Marimba KP	0	1	12
Sin Marimba	0	64	12
Balimba	0	97	12
Log Drum	0	98	12
Xylophone XG	0	0	13
Tubular Bell XG	0	0	14
Church Bells	0	96	14
Carillonx	0	97	14
Dulcimer XG	0	0	15
Dulcimer Octave	0	35	15
Cimbalom	0	96	15
Santur 2	0	97	15
GM/XG/Organ			
Drawbar Org GM	121	0	16
Det. Drawbar Org	121	1	16
lt. 60's Organ	121	2	16
Drawbar Org. 2	121	3	16

Sound	CC00	CC32	PC
Perc.Organ GM	121	0	17
Det. Perc. Organ	121	1	17
Perc. Organ 2	121	2	17
Rock Organ GM	121	0	18
Church Organ GM	121	0	19
Church Oct. Mix	121	1	19
Detuned Church	121	2	19
Reed Organ GM	121	0	20
Puff Organ	121	1	20
Accordion GM	121	0	21
Accordion 2	121	1	21
Harmonica GM	121	0	22
Tango Accord.GM	121	0	23
Drawbar Org XG	0	0	16
Detuned Drawbar	0	32	16
60's Draw.Org. 1	0	33	16
60's Organ	0	34	16
70's DB Org. 1	0	35	16
Drawbar Org. 3	0	36	16
Drawbar 5th	0	37	16
Even Bar Org.	0	38	16
Organ 16+2'2/3	0	40	16
Organ Bass	0	64	16
70's DB Org. 2	0	65	16
Cheezy Organ	0	66	16
Drawbar Org Perc	0	67	16
Perc.Organ XG	0	0	17
70's Perc. Organ	0	24	17
ChorusPerc.Organ	0	32	17
Lite Organ	0	33	17
Percussive Organ	0	37	17
Rock Organ XG	0	0	18
Rotary Organ V.	0	64	18

Sound	CC00	CC32	PC
Slow Rotary	0	65	18
Fast Rotary	0	66	18
Church Organ XG	0	0	19
Church Organ 3	0	32	19
Church Organ 2	0	35	19
Notre Dame	0	40	19
Organ Flute	0	64	19
Trem. Org. Flute	0	65	19
Reed Organ XG_n#	0	0	20
Puff Organx	0	40	20
Accordion XG	0	0	21
Accord. It.	0	32	21
Harmonica XG	0	0	22
Soft Harmonica	0	32	22
Tango Accord.XG	0	0	23
TangoAccordion 2	0	64	23
GM/XG/Guitar			
Nylon Guitar GM	121	0	24
Ukulele	121	1	24
Nylon Key Off	121	2	24
Nylon Guitar 2	121	3	24
Steel Guitar GM	121	0	25
12 Strings Gtr	121	1	25
Mandolin	121	2	25
Steel Gtr & Body	121	3	25
Jazz Guitar GM	121	0	26
Pedal Steel Gtr	121	1	26
Clean Guitar GM	121	0	27
Det.Clean El.Gtr	121	1	27
Mid Tone Gtr	121	2	27
Muted Guitar GM	121	0	28
Funky Cut El.Gtr	121	1	28
Mute Vel. El.Gtr	121	2	28

Sound	CC00	CC32	PC
Jazz Man	121	3	28
Overdrive Gtr GM	121	0	29
Guitar Pinch	121	1	29
DistortionGtr GM	121	0	30
Feedback DistGtr	121	1	30
Dist. Rhythm Gtr	121	2	30
Gtr Harmonic GM	121	0	31
Guitar Feedback	121	1	31
Nylon Guitar XG	0	0	24
Nylon Guitar 2rn	0	16	24
Nylon Guitar 3	0	25	24
Nylon & Harm. V.	0	43	24
Ukulele X	0	96	24
Steel Guitar XG	0	0	25
Steel Guitar X	0	16	25
12 Strings Gtr X	0	35	25
Nylon plus Steel	0	40	25
SteelGtrWithBody	0	41	25
Mandolin X	0	96	25
Jazz Guitar XG	0	0	26
Mellow Guitar	0	18	26
Jazz Man Amp	0	32	26
Clean Guitar XG	0	0	27
Chorus El.Gtr	0	32	27
Muted Guitar XG	0	0	28
Funk Cut Guitar	0	40	28
Muted Steel Gtr	0	41	28
Funk Guitar 2	0	43	28
Jazz Boy	0	45	28
Overdrive Gtr XG	0	0	29
Guitar Nip	0	43	29
DistortionGtr XG	0	0	30
Feedback DistGt1	0	40	30
Feedback DistGt2	0	41	30

Sound	CC00	CC32	PC
Gtr Harmonic XG	0	0	31
Gtr Feedback	0	65	31
Gtr Harmonic	0	66	31
GM/XG/Bass			
Acoustic Bass GM	121	0	32
Finger Bass GM	121	0	33
Finger Slap Bass	121	1	33
Picked E.Bass GM	121	0	34
Fretless Bass GM	121	0	35
Slap Bass 1 GM	121	0	36
Slap Bass 2 GM	121	0	37
Synth Bass 1 GM	121	0	38
Synth Bass Warm	121	1	38
Synth Bass Reso	121	2	38
Clavi Bass	121	3	38
Hammer	121	4	38
Synth Bass 2 GM	121	0	39
SynthBass Attack	121	1	39
SynthBass Rubber	121	2	39
Attack Pulse	121	3	39
Acoustic Bass XG	0	0	32
Jazz Rhythm	0	40	32
Ac. Bass V.	0	45	32
Finger Bass XG	0	0	33
Finger Dark	0	18	33
Flange Bass	0	27	33
FngBass&DstGuit.	0	40	33
FingerSlapBass V	0	43	33
Finger Bass rn	0	45	33
Modulated Bass	0	65	33
Picked E.Bass XG	0	0	34
Muted Pick Bass	0	28	34
Fretless Bass XG	0	0	35
Fretless Bass B	0	32	35

Sound	CC00	CC32	PC
Fretless Det.	0	33	35
Fretless Soft	0	34	35
Synth Fretless	0	96	35
Smooth Fretless	0	97	35
Slap Bass 1 XG	0	0	36
Resonant Slap	0	27	36
Punch Thumb Bass	0	32	36
Slap Bass 2 XG	0	0	37
Velo. Sw. Slap	0	43	37
Synth Bass 1 XG	0	0	38
Syn. Bass Dark	0	18	38
Fast Reso. Bass	0	20	38
Acid Bass	0	24	38
Clav. Bass	0	35	38
Techno Bass	0	40	38
Orbiter Bass	0	64	38
Xsquare Bass	0	65	38
Rubber Bass	0	66	38
Hammer Bass	0	96	38
Synth Bass 2 XG	0	0	39
Mellow Syn Bass	0	6	39
Sequenced Bass	0	12	39
Click Synth Bass	0	18	39
Synth Bass Dark	0	19	39
Smooth Syn. Bass	0	32	39
Modular Syn Bass	0	40	39
DX Bass	0	41	39
X Wire Bass	0	64	39
GM/XG/Strings			
Violin GM	121	0	40
Slow Att. Violin	121	1	40
Viola GM	121	0	41
Cello GM	121	0	42
Contrabass GM	121	0	43

Sound	CC00	CC32	PC
Tremolo Str. GM	121	0	44
Pizzicato Str. GM	121	0	45
Harp GM	121	0	46
Yang Chin	121	1	46
Timpani GM	121	0	47
Violin XG	0	0	40
Slow Atk Violin	0	8	40
Viola XG	0	0	41
Cello XG	0	0	42
Contrabass XG	0	0	43
Tremolo Str. XG	0	0	44
Slw Tremolo Str.	0	8	44
Suspense Strings	0	40	44
Pizzicato Str. XG	0	0	45
Harp XG	0	0	46
Yang Chin	0	40	46
Timpani XG	0	0	47
GM/XG/Ensemble			
Strings Ens.1 GM	121	0	48
Strings & Brass	121	1	48
60's Strings	121	2	48
Strings Ens.2 GM	121	0	49
Synth Strings1GM	121	0	50
Synth Strings 3	121	1	50
Synth Strings2GM	121	0	51
Choir Aahs GM	121	0	52
Choir Aahs 2	121	1	52
Voice Oohs GM	121	0	53
Humming	121	1	53
Synth Voice GM	121	0	54
Analog Voice	121	1	54
Orchestra Hit GM	121	0	55
Bass Hit Plus	121	1	55
6th Hit	121	2	55

Sound	CC00	CC32	PC
Euro Hit	121	3	55
Strings Ens.1 XG	0	0	48
Stereo Stringx	0	3	48
Slw Atk Strings	0	8	48
Arco Stringx	0	24	48
60's Strings	0	35	48
Orchestra	0	40	48
Orchestra 2	0	41	48
TremoloOrchestra	0	42	48
Velocity Strings	0	45	48
Strings Ens.2 XG	0	0	49
StereoSlwStrings	0	3	49
SlwLegatoStrings	0	8	49
Warm Strings	0	40	49
Kingdom	0	41	49
70's Strings	0	64	49
Strings 3	0	65	49
Synth Strings1XG	0	0	50
Reso Strings	0	27	50
Synth Strings 4	0	64	50
Synth Strings 5	0	65	50
Synth Strings2XG	0	0	51
Choir Aahs XG	0	0	52
Stereo Choir	0	3	52
Choir Aahs 3	0	16	52
Mellow Choir	0	32	52
Choir Strings	0	40	52
Voice Oohs XG	0	0	53
Synth Voice XG	0	0	54
Synth Voix	0	40	54
Choral	0	41	54
Analog Voix	0	64	54
Orchestra Hit XG	0	0	55
Orchestra Hitx	0	35	55

Sound	CC00	CC32	PC
Impact	0	64	55
GM/XG/Brass			
Trumpet GM	121	0	56
Dark Trumpet	121	1	56
Trombone GM	121	0	57
Trombone 2	121	1	57
Bright Trombone	121	2	57
Tuba GM	121	0	58
Muted Trumpet GM	121	0	59
Muted Trumpet 2	121	1	59
French Horn GM	121	0	60
FrenchHorn Warm	121	1	60
Brass Section GM	121	0	61
Brass Section 2	121	1	61
Synth Brass 1 GM	121	0	62
Synth Brass 3	121	1	62
Analog Brass 1	121	2	62
Jump Brass	121	3	62
Synth Brass 2 GM	121	0	63
Synth Brass 4	121	1	63
Analog Brass 2	121	2	63
Trumpet XG	0	0	56
Trumpet 2	0	16	56
Brite Trumpet	0	17	56
Trombone XG	0	0	57
Warm Trombone	0	18	57
Tuba XG	0	0	58
Tuba 2	0	16	58
Muted Trumpet XG	0	0	59
French Horn XG	0	0	60
French Horn Solo	0	6	60
Warm French Horn	0	32	60
Horn Orchestra	0	37	60
Brass Section XG	0	0	61

Sound	CC00	CC32	PC
Tpt&Tbn Section	0	35	61
Brass Section 3	0	40	61
Hit Brass	0	41	61
Mellow Brass	0	42	61
Synth Brass 1 XG	0	0	62
Quack Brass	0	12	62
Res. Synth Brass	0	20	62
Poly Brass	0	24	62
Synth Brass 4	0	27	62
Jump Brass	0	32	62
AnaVel Brass 1	0	45	62
AnaLog Brass 1	0	64	62
Synth Brass 2 XG	0	0	63
Soft Brass	0	18	63
Synth Brass X	0	40	63
Choir Brass	0	41	63
AnaVel Brass 2	0	45	63
AnaLog Brass 2	0	64	63
GM/XG/Reed			
Soprano Sax GM	121	0	64
Alto Sax GM	121	0	65
Tenor Sax GM	121	0	66
Baritone Sax GM	121	0	67
Oboe GM	121	0	68
English Horn GM	121	0	69
Bassoon GM	121	0	70
Clarinet GM	121	0	71
Soprano Sax XG	0	0	64
Alto Sax XG	0	0	65
Sax Section	0	40	65
HyperAltoSax	0	43	65
Tenor Sax XG	0	0	66
BreathyTenorSax	0	40	66
Soft Tenor Sax	0	41	66

Sound	CC00	CC32	PC
Tenor Sax 2	0	64	66
Baritone Sax XG	0	0	67
Oboe XG	0	0	68
English Horn XG	0	0	69
Bassoon XG	0	0	70
Clarinet XG	0	0	71
GM/XG/Pipe			
Piccolo GM	121	0	72
Flute GM	121	0	73
Recorder GM	121	0	74
Pan Flute GM	121	0	75
Blown Bottle GM	121	0	76
Shakuhachi GM	121	0	77
Whistle GM	121	0	78
Ocarina GM	121	0	79
Piccolo XG	0	0	72
Flute XG	0	0	73
Recorder XG	0	0	74
Pan Flute XG	0	0	75
Blown Bottle XG	0	0	76
Shakuhachi XG	0	0	77
Whistle XG	0	0	78
Ocarina XG	0	0	79
GM/XG/Syn Lead Syn Pad			
Lead Square GM	121	0	80
Lead Square 2	121	1	80
Lead Sine	121	2	80
Lead Saw GM	121	0	81
Lead Saw 2	121	1	81
Lead Saw & Pulse	121	2	81
Lead Double Saw	121	3	81
Lead Seq. Analog	121	4	81
Calliope GM	121	0	82
Chiff GM	121	0	83

Sound	CC00	CC32	PC
Charang GM	121	0	84
Wire Lead	121	1	84
Voice Lead GM	121	0	85
Fifths Lead GM	121	0	86
Bass & Lead GM	121	0	87
Lead Soft Wrl	121	1	87
New Age Pad GM	121	0	88
Warm Pad GM	121	0	89
Sine Pad	121	1	89
Polysynth GM	121	0	90
Choir Pad GM	121	0	91
Itopia Pad	121	1	91
Bowed Glass GM	121	0	92
Metallic Pad GM	121	0	93
Halo Pad GM	121	0	94
Sweep Pad GM	121	0	95
Lead Square XG	0	0	80
Square Lead	0	6	80
LM Square	0	8	80
Hollow	0	18	80
Shroud	0	19	80
Mellow	0	64	80
Solo Sine	0	65	80
Sine Lead	0	66	80
Lead Saw XG	0	0	81
Sawtooth Lead	0	6	81
Thick Sawtooth	0	8	81
Dynamic Sawtooth	0	18	81
Digital Saw	0	19	81
Big Lead	0	20	81
Heavy Synth	0	24	81
Wasp Synth	0	25	81
Pulse Saw	0	40	81
Dr. Lead	0	41	81

Sound	CC00	CC32	PC
Velocity Lead	0	45	81
Sequenced Analog	0	96	81
Calliope XG	0	0	82
Pure Lead	0	65	82
Chiff XG	0	0	83
Rubby	0	64	83
Charang XG	0	0	84
Distorted Lead	0	64	84
Wire Lead	0	65	84
Voice Lead XG	0	0	85
Synth Aahs	0	24	85
Vox Lead	0	64	85
Fifths Lead XG	0	0	86
Big Five	0	35	86
Bass & Lead XG	0	0	87
Big & Low	0	16	87
Fat & Perky	0	64	87
Soft Whirl	0	65	87
New Age Pad XG	0	0	88
Fantasy	0	64	88
Warm Pad XG	0	0	89
Thick Pad	0	16	89
Soft Pad	0	17	89
Sine Pad	0	18	89
Horn Pad	0	64	89
Rotary Strings	0	65	89
Polysynth XG	0	0	90
Poly Pad 800	0	64	90
Click Pad	0	65	90
Analog Pad	0	66	90
Square Pad	0	67	90
Choir Pad XG	0	0	91
Heaven Mod	0	64	91
Itopia	0	66	91

Sound	CC00	CC32	PC
C.C. Pad	0	67	91
Bowed Glass XG	0	0	92
Glacier	0	64	92
Metallic Pad XG	0	0	93
Tine Pad	0	64	93
Pan Pad	0	65	93
Halo Pad XG	0	0	94
Sweep Pad XG	0	0	95
Shwimmer	0	20	95
Converge	0	27	95
Polar Pad	0	64	95
Celestial	0	66	95
GM/XG/Synth SFX			
Ice Rain GM	121	0	96
Soundtrack GM	121	0	97
Crystal GM	121	0	98
Synth Mallet	121	1	98
Atmosphere GM	121	0	99
Brightness GM	121	0	100
Goblins GM	121	0	101
Echo Drops GM	121	0	102
Echo Bell	121	1	102
Echo Pan	121	2	102
Star Theme GM	121	0	103
Ice Rain XG	0	0	96
Clav. Pad	0	45	96
Harmo. Rain	0	64	96
African Wind	0	65	96
Carib	0	66	96
Soundtrack XG	0	0	97
Prologue	0	27	97
Ancestral Clouds	0	64	97
Crystal XG	0	0	98
Synth Drum Comp.	0	12	98

Sound	CC00	CC32	PC
Popcorn	0	14	98
Tiny Bells	0	18	98
Round Glocken.	0	35	98
Glocken. Chimes	0	40	98
Clear Bells	0	41	98
Chorus Bells	0	42	98
Synth Mallet	0	64	98
Soft Crystal	0	65	98
LoudGlockenspiel	0	66	98
Xmas Bell	0	67	98
Vibe Bells	0	68	98
Digital Bells	0	69	98
Air Bells	0	70	98
Bell Harp	0	71	98
Gamelimba	0	72	98
Atmosphere XG	0	0	99
Warm Atmosph.	0	18	99
Hollow Release	0	19	99
Nylon El. Piano	0	40	99
Nylon Harp	0	64	99
Harp Vox	0	65	99
Atmosphere Pad	0	66	99
Planet	0	67	99
Brightness XG	0	0	100
Fantasy Bells	0	64	100
Smokey	0	96	100
Goblins XG	0	0	101
Goblin Synth	0	64	101
Creeper	0	65	101
Ring Pad	0	66	101
Ritual	0	67	101
To Heaven	0	68	101
Night	0	70	101
Glisten	0	71	101

Sound	CC00	CC32	PC
Bell Choir	0	96	101
Echo Drops XG	0	0	102
Echoes	0	8	102
Echo Pan X	0	14	102
Echo Bell X	0	64	102
Big Pan	0	65	102
Synth Piano	0	66	102
Creation	0	67	102
Star Dust	0	68	102
Pan Reso X	0	69	102
Star Theme XG	0	0	103
Starz	0	64	103
GM/XG/Ethnic			
Sitar GM	121	0	104
Sitar 2	121	1	104
Banjo GM	121	0	105
Shamisen GM	121	0	106
Koto GM	121	0	107
Taisho Koto	121	1	107
Kalimba GM	121	0	108
Bag Pipes GM	121	0	109
Fiddle GM	121	0	110
Shanai GM	121	0	111
Sitar XG	0	0	104
Detuned Sitar	0	32	104
Octave Sitar	0	35	104
Tamboura	0	97	104
Banjo XG	0	0	105
Muted Banjo	0	28	105
Rabab	0	96	105
Gopichant	0	97	105
Oud 3	0	98	105
Shamisen XG	0	0	106
Koto XG	0	0	107

Sound	CC00	CC32	PC
Taisho-Kin	0	96	107
Kanoun X	0	97	107
Kalimba XG	0	0	108
Bag Pipes XG	0	0	109
Fiddle XG	0	0	110
Shanai XG	0	0	111
GM/XG/Percussive			
Tinkle Bell GM	121	0	112
Agogo GM	121	0	113
Steel Drums GM	121	0	114
Woodblock GM	121	0	115
Castanets	121	1	115
Taiko Drum GM	121	0	116
Concert BassDrum	121	1	116
Melodic Tom GM	121	0	117
Melodic Tom 2	121	1	117
Synth Drum GM	121	0	118
Rhythm Box Tom	121	1	118
Electric Drum	121	2	118
ReverseCymbalGM	121	0	119
Tinkle Bell XG	0	0	112
Bonang	0	96	112
Altair	0	97	112
Gamelal Gongs	0	98	112
St.GamelanGongs	0	99	112
Rama Cymbal	0	100	112
Asian Bells	0	101	112
Agogo XG	0	0	113
Steel Drums XG	0	0	114
Glass Percussion	0	97	114
Thai Bells	0	98	114
Woodblock XG	0	0	115
Castanex	0	96	115
Taiko Drum XG	0	0	116

Sound	CC00	CC32	PC
Gran Cassa	0	96	116
Melodic Tom XG	0	0	117
Melodic Tom 3	0	64	117
Real Tom	0	65	117
Rock Tom	0	66	117
Synth Drum XG	0	0	118
Analog Tom	0	64	118
Electric Perc.	0	65	118
ReverseCymbalXG	0	0	119
GM/XG/SFX			
Gtr FretNoise GM	121	0	120
Guitar Cut Noise	121	1	120
Ac. Bass String	121	2	120
Breath Noise GM	121	0	121
Flute Key Click	121	1	121
Seashore GM	121	0	122
Rain	121	1	122
Thunder	121	2	122
Wind	121	3	122
Stream	121	4	122
Bubble	121	5	122
Bird Tweet GM	121	0	123
Dog	121	1	123
Horse Gallop	121	2	123
Bird Tweet 2	121	3	123
Telephone GM	121	0	124
Telephone 2	121	1	124
Door Creaking	121	2	124
Door	121	3	124
Scratch	121	4	124
Wind Chime	121	5	124
Helicopter GM	121	0	125
Car Engine	121	1	125
Car Stop	121	2	125

Sound	CC00	CC32	PC
Car Pass	121	3	125
Car Crash	121	4	125
Siren	121	5	125
Train	121	6	125
Jetplane	121	7	125
Starship	121	8	125
Burst Noise	121	9	125
Applause GM	121	0	126
Laughing	121	1	126
Screaming	121	2	126
Punch	121	3	126
Heart Beat	121	4	126
Footsteps	121	5	126
Gun Shot GM	121	0	127
Machine Gun	121	1	127
Laser Gun	121	2	127
Explosion	121	3	127
Gtr FretNoise XG	0	0	120
Breath Noise XG	0	0	121
Seashore XG	0	0	122
Bird Tweet XG	0	0	123
Telephone XG	0	0	124
Helicopter XG	0	0	125
Applause XG	0	0	126
Gun Shot XG	0	0	127
Pa4X V2			
Italian Piano	121	16	0
It. Piano	121	17	0
Italian Jazz P.	121	18	0
It.Grand & Stack	121	13	2
Marimba Syn Seq	121	8	12
Tutti A	121	11	19
Tutti B	121	12	19
Sesquialtera	121	13	19

Sound	CC00	CC32	PC
Plenum A	121	14	19
Plenum B	121	15	19
Plenum C	121	16	19
Plenum D	121	17	19
Plenum E	121	18	19
Pipe Cornet	121	19	19
Viola+Cornet	121	20	19
Principal 8'	121	21	19
Pipe Flute 8'	121	22	19
Gamba 8'	121	23	19
Trumpet Pipes	121	24	19
Pipe Octave	121	25	19
Pipe Super Oct.	121	26	19
Pipe Fifth	121	27	19
Principal+Flute	121	28	19
Nazard A	121	29	19
Nazard B	121	30	19
Flute8'+Flute4'	121	31	19
Flute8'+Flute2'	121	32	19
Gamba+Flute	121	33	19
Celeste	121	34	19
Terziana	121	35	19
Larigot	121	36	19
It. Accordion16'	121	31	21
It. Accordion 8'	121	32	21
It. Accordion 4'	121	33	21
It. Acc. 16'+Bass	121	34	21
Fisarmony	121	35	21
Bandoneon DNC	121	11	23
Bandoneon Sync	121	12	23
Bandoneon Short	121	13	23
CA Steel Gtr DNC	121	51	25
Groove Gtr Wah	121	30	28
Wide Bass	121	21	38

Sound	CC00	CC32	PC
SimplePulse Bass	121	19	39
Fifth Bass	121	20	39
Robert Bass	121	21	39
Movie Action	121	29	48
Strings & Vocal	121	30	48
Soft Strings	121	20	49
Horns Swell3 DNC	121	45	61
JP8	121	6	62
Vocal Brass	121	6	63
Tenor Sax 2 DN1	121	19	66
Tenor Sax 2 DN2	121	20	66
Soft Tenor DN1	121	21	66
Soft Tenor DN2	121	22	66
Whistle Robin	121	7	78
Fing.GlideSquare	121	16	80
Square Solo	121	17	80
Square & Pulse	121	18	80
Thin PulSeq DNC	121	21	81
Spire Synth	121	22	81
Leadspace	121	23	81
EDM Synth	121	24	81
Dance Basic	121	25	81
Triangle Solo	121	26	81
Saw Solo	121	27	81
16-8-4 & Sub32	121	28	81
Landscape	121	1	82
Dubstep Synth	121	14	84
Caos Synth	121	15	84
Noised Lead DNC	121	20	87
Pacific Sea	121	6	88
Nighthawk	121	7	88
Mellow Perc. Pad	121	8	88
Waterland	121	9	88
Meditation Stack	121	10	88

Sound	CC00	CC32	PC
Big Side Attack	121	18	89
80's Mellow	121	19	89
80's Super Pad	121	20	89
Synth Whooo	121	16	90
Analog Synth	121	17	90
Synth Yes	121	18	90
Poly6 + JP8	121	19	90
Mixed Echoes	121	16	91
Running	121	12	96
Hans Sound	121	13	96

Sound	CC00	CC32	PC
Layers Enjoy	121	11	99
Ipnotic Stack	121	12	99
Lfo Sound bpm	121	5	101
Wave Echoes	121	6	102
Metallic Syn Seq	121	2	114
Dance Syn Perc	121	3	114
Wood&Metal Seq	121	4	114
Shape Sound	121	5	114

DNC Sounds and controls

The following table lists the DNC Sounds and their DNC controls. DNC, DN1 and DN2 Sounds use different sets of controls.

Sound Name	CC		PC		Legato		SC1		SC2		Y+	Y-	After Touch
	00	32			In	Out	Note On	Note Off	Note On	Note Off			
Factory/Piano													
ClassicClav1 DNC	121	7	7				Pickup position 1 (toggle)		Pickup position 2 (toggle)				
ClassicClav2 DNC	121	8	7										
Factory/Accordion													
Harmonica 1 DN1	121	11	22	Legato Atk			Riff Up	Riff Down	Riff Down	Fall Down		Soft Atk	Bend
Harmonica 1 DN2	121	12	22	Legato Atk	> ±9st: Riff Up/Down		Riff Up	Riff Down	Riff Down	Fall Down		Soft Atk	Bend
Harmonica 2 DN1	121	13	22	Legato Atk			Riff Up	Riff Down	Riff Down	Fall Down		Soft Atk	Bend
Harmonica 3 DN1	121	14	22	Legato Atk			Riff Up	Riff Down	Riff Down	Fall Down		Soft Atk	Bend
Factory/Guitar													
Concert Gtr DNC	121	20	24	Legato Atk			Slide Up		Harm			Body NZ	Vibrato
Nylon Guitar DNC	121	18	24	Legato Atk			Slide Up		Harm			Body NZ	Vibrato
7Str.Guitar DNC	121	28	24	Legato Atk			Slide Up		Harm			Mute	Vibrato
NaturalSteel DNC	121	47	25				Slide Up		Harm			Mute	Vibrato
Acous.Steel1 DNC	121	48	25				Slide Up		Harm			Mute	Vibrato
Acous.Steel2 DNC	121	49	25				Slide Up		Harm			Mute	Vibrato
Real Dobro DNC	121	50	25				Slide Up		Harm			Mute	Vibrato
ViolaCaipira DNC	121	45	25	Legato Atk			Slide Up		Harm			Body NZ	Vibrato
ClassicSteel DNC	121	36	25	Legato Atk			Slide Up		Harm			Body NZ	Vibrato
RealFolk Gtr DNC	121	34	25	Legato Atk			Slide Up		Harm			Body NZ	Vibrato
SteelGtrPro DNC	121	19	25	Legato Atk			Slide Up		Harm			Body NZ	Vibrato
Strum 12Str.DNC	121	33	25	Legato Atk			Slide Up		Harm			Body NZ	Vibrato
Strat N DI DNC	121	39	27				Slide Up		Harm				Vibrato
Strat N Cln DNC	121	38	27				Slide Up		Mute				Vibrato
Strat B DI DNC	121	45	27				Slide Up		Harm				Vibrato
Strat B Ovd DNC	121	5	29				Slide Up		Harm			Feedback	Vibrato
Tele M DI DNC	121	41	27				Slide Up		Harm				Vibrato
Tele M Cln DNC	121	40	27				Slide Up		Harm				Vibrato
LesP M DI DNC	121	43	27				Slide Up		Harm				Vibrato
LesP M Cln DNC	121	42	27				Slide Up		Harm				Vibrato
33X B DI DNC	121	44	27				Slide Up		Harm				Vibrato
33X B Dst DNC	121	17	30				Slide Up		Harm			Feedback	Vibrato

Sound Name	CC		PC	Legato		SC1		SC2		Y+	Y-	After Touch
	00	32		In	Out	Note On	Note Off	Note On	Note Off			
Dist. Gtr 1 DNC	121	16	30			Slide Up		Harm			Feedback	Vibrato
Dist. Gtr 2 DNC	121	14	30	Legato Atk		Slide Up		Harm			Feedback	Vibrato
Crunch Gtr DNC	121	3	29	Legato Atk		Slide Up		Harm			Feedback	Vibrato
Jazz Gtr 1 DNC	121	8	26	Legato Atk		Slide Up		Harm			Octave (toggle)	Vibrato
Stra.GtrUpDwDNC	121	33	27			Slide Up		Harm				
E.Gtr Ch/Dly DNC	121	35	27	Legato Atk		Slide Up		Harm				
Factory/Strings & Vocal												
ClassicViolinDN1	121	14	40			Détaché		Pizzicato		Tremolo	Balzato	More Vib.
ClassicViolinDN2	121	13	40		> ±9st: Riff Up/Down	Riff Up	Fall Down	Gliss Down	Gliss Up	Tremolo	Mordente	More Vib.
Conc. Violin DN1	121	12	40			Open String		Pizzicato			Mordente	More Vib.
Real Strings DNC	121	13	49			Spiccato		Pizzicato		Tremolo	Marcato	
Ballad Strs. DNC	121	17	49			Spiccato		Pizzicato		Tremolo	Marcato	
Violin DN2	121	10	40		> ±9st: Riff Up/Down	Gliss Up	Fall Down	Gliss Down	Gliss Up		Mordente	More Vib.
Violin Expr. DN2	121	11	40		> ±9st: Riff Up/Down	Gliss Up	Fall Down	Gliss Down	Gliss Up		Mordente	More Vib.
Real Viola DN1	121	3	41			Détaché		Pizzicato		Tremolo	Balzato	More Vib.
SopranoVox1 DNC	121	4	53	< ±6st: Smooth	> ±6st: Gliss Up/Down	> G4: 4th Up		< F5: 5th Down				
Factory/Trumpet & Trbn												
Real Flugel DN2	121	37	56	Legato Atk	> ±3st: Riff Up/Down	Riff Up	Fall Down	Riff Down	Doit		Staccato	More Vib.
Real Muted DN2	121	10	59	Legato Atk	> ±3st: Riff Up/Down	Riff Up	Fall Down	Riff Down	Doit		Staccato	More Vib.
Jazz Trumpet DN1	121	33	56	Legato Atk		Gliss Up	Fall Down	Riff Down	Doit		Alt Timbre	More Vib.
Jazz Trumpet DN2	121	34	56	Legato Atk	> ±9st: Riff Up/Down	Gliss Up	Fall Down	Riff Down	Doit		Alt Timbre	More Vib.
Cup Muted DN2	121	9	59	Legato Atk	> ±3st: Riff Up/Down	Long Fall Down	Fall Down	Long Doit	Doit		Wha	More Vib.
Jazz Cornet DN1	121	32	56	Legato Atk		Gliss Up	Fall Down	Riff Down	Doit		Alt Timbre	More Vib.
Jazz Cornet DN2	121	36	56	Legato Atk	> ±9st: Riff Up/Down	Gliss Up	Fall Down	Riff Down	Doit		Alt Timbre	More Vib.
Jazz Trb. DN1	121	20	57	Legato Atk		Gliss Up	Fall Down	Riff Down	Doit		Alt Timbre	More Vib.
Jazz Trb. DN2	121	21	57	Legato Atk	> ±9st: Gliss Up/Down	Gliss Up	Fall Down	Riff Down	Doit		Alt Timbre	More Vib.
Soft Trb. DN1	121	22	57	Legato Atk		Gliss Up	Fall Down	Riff Down	Doit		Alt Timbre	More Vib.
Soft Trb. DN2	121	23	57	Legato Atk	> ±9st: Gliss Up/Down	Gliss Up	Fall Down	Riff Down	Doit		Alt Timbre	More Vib.

Sound Name	CC		PC	Legato		SC1		SC2		Y+	Y-	After Touch
	OO	32		In	Out	Note On	Note Off	Note On	Note Off			
HardTrombone DN1	121	24	57	Legato Atk		Gliss Up	Fall Down	Riff Down	Doit		Alt Timbre	More Vib.
HardTrombone DN2	121	25	57	Legato Atk	> ±9st: Gliss Up/Down	Gliss Up	Fall Down	Riff Down	Doit		Alt Timbre	More Vib.
Muted Trp.1 DN1	121	6	59	Legato Atk		Gliss Up	Fall Down	Riff Down	Doit		Alt Timbre	More Vib.
Muted Trp.2 DN1	121	7	59	Legato Atk		Gliss Up	Fall Down	Riff Down	Doit		Alt Timbre	More Vib.
Muted Cornet DN1	121	8	59	Legato Atk		Gliss Up	Fall Down	Riff Down	Doit		Alt Timbre	More Vib.
Factory/Brass												
Swing Horns DNC	121	40	61			Fall Down		Doit		Shake	Swell	
Horns Sweet1 DNC	121	38	61			Fall Down		Doit		Shake	SFX	
Horns Sweet2 DNC	121	39	61			Fall Down		Doit		Shake	SFX	
Trombones DNC	121	10	61			Fall Down		Doit		Shake	Swell	
Trumpets DNC	121	42	61			Fall Down		Doit		Shake	Swell	
Factory/Sax												
Tenor Sax DN1	121	16	66			Riff Up	Fall Down	Riff Down	Gliss Down		Growl	More Vib.
Tenor Sax DN2	121	17	66		> ±9st: Riff Up/Down	Riff Up	Fall Down	Riff Down	Gliss Down		Growl	More Vib.
Tenor Growl DN1	121	18	66			Riff Up	Fall Down	Riff Down	Gliss Down		Growl	More Vib.
Jazz Sax DN1	121	20	65			Riff Up	Fall Down	Riff Down	Gliss Down		Growl	More Vib.
Jazz Sax DN2	121	21	65		> ±9st: Riff Up/Down	Riff Up	Fall Down	Riff Down	Gliss Down		Growl	More Vib.
PopAltoSax DN1	121	22	65			Riff Up	Fall Down	Riff Down	Gliss Down		Growl	More Vib.
Alto Sax DN1	121	23	65			Riff Up	Fall Down	Riff Down	Gliss Down		Growl	More Vib.
SoftAltoSax DN1	121	24	65			Riff Up	Fall Down	Riff Down	Gliss Down		Growl	More Vib.
Soprano Sax DN1	121	6	64			Riff Up	Fall Down	Riff Down	Gliss Down		Alt Timbre	More Vib.
Baritone Sax DN1	121	6	67			Riff Up	Fall Down	Riff Down	Gliss Down		Growl	More Vib.
Factory/Woodwind												
ConcertFlute DN1	121	15	73			Riff Up	Fall Down	Gliss Up	Gliss Down		Frull	More Vib.
ConcertFlute DN2	121	16	73		> ±9st: Riff Up/Down	Riff Up	Fall Down	Gliss Up	Gliss Down		Frull	More Vib.
Latin Flute DN1	121	17	73			Riff Up	Fall Down	Gliss Up	Gliss Down		Frull	More Vib.
Latin Flute DN2	121	18	73		> ±9st: Riff Up/Down	Riff Up	Fall Down	Gliss Up	Gliss Down		Frull	More Vib.
RealClarinet DN1	121	21	71			Riff Up	Fall Down	Riff Down	Gliss Down		Alt Timbre	More Vib.
JazzClarinet DN1	121	22	71			Riff Up	Fall Down	Riff Down	Gliss Down		Alt Timbre	More Vib.
Bassoon DNC	121	02	70			Staccato		Alt Timbre				More Vib.
Pan Flute DN1	121	05	75			Riff Up	Fall Down	Gliss Up	Gliss Down		Alt Attack	More Vib.
Whistle DN1	121	06	78			Riff Up	Fall Down	Riff Down	Gliss Down		Alt Timbre	More Vib.

Sound Name	CC		PC	Legato		SC1		SC2		Y+	Y-	After Touch
	00	32		In	Out	Note On	Note Off	Note On	Note Off			
Factory/Synth Pad												
S&H Pad DNC	121	10	96			White Noise		RND filter		Reson.	Detune	HP Filter
Factory/Synth Lead												
Next Dance DNC	121	13	87			White Noise		Alt Timbre			LP Filter	Reson.
Lab Synth DNC	121	8	84			HP Filter		Detune			LP Filter	Reson.
Deep Modul. DNC	121	10	84			HP Filter		Alt Attack		LFO Speed Increase	LFO Speed Decrease	
Factory/Ethnic												
Mandolin DNC	121	40	25	Legato Atk		No Rel.						
Berimbau DNC	121	02	106			Caxixi		Crash		Belly		
Berimbau Rel.DNC	121	01	106			Caxixi		Bend		Belly		
Banjo Thumb DNC	121	06	105			Mordente		Harm			Mute	
Banjo Fin/Th.DNC	121	07	105			Thumb		Harm			Mute	
Factory/Bass												
JB Finger BsDN1	121	29	33			Mute		Harm			Ghost	Vibrato
JB Finger BsDN2	121	30	33			Pick		Slap			Mute	Vibrato
JB Pick Bs DN1	121	18	34			Mute		Harm			Ghost	Vibrato
JB Pick Bs DN2	121	19	34			Finger		Slap			Mute	Vibrato
PBs Fing.Pop DN1	121	33	33			Mute		Harm			Ghost	Vibrato
PBs Fing.Pop DN2	121	34	33			Pick		Slap			Mute	Vibrato
SR Finger BsDN1	121	27	33			Mute		Harm			Ghost	Vibrato
SR Finger BsDN2	121	28	33			Pick		Slap			Mute	Vibrato
SR Pick Bs DN1	121	16	34			Mute		Harm			Ghost	Vibrato
SR Pick Bs DN2	121	17	34			Finger		Slap			Mute	Vibrato
PBsFing.Vint.DN1	121	25	33			Mute		Harm			Ghost	Vibrato
PBsFing.Vint.DN2	121	26	33			Pick		Slap			Mute	Vibrato
FS Pick Bs DN1	121	14	34			Mute		Harm			Ghost	Vibrato
FS Pick Bs DN2	121	15	34			Finger		Slap			Mute	Vibrato
Fretless Bs DN1	121	11	35			Mute		Harm			Ghost	Vibrato
FretlessVib.DN1	121	10	35			Mute		Harm			Ghost	Vibrato
Finger Bass DN1	121	16	33			Mute		Harm			Ghost	Vibrato
Dark Bs&Slp DN1	121	7	36			Mute		Harm			Ghost	Vibrato

The following table explains the meaning of the DNC controls.

DNC Control	Meaning
Legato (In)	Playing legato inside the Legato range (as defined in the Sound > Basic > Sound page, and shown in the previous table)
Legato (Out)	Playing legato out of the Legato range
SC1 Note On	Sound Controllers 1 & 2 (SC1, SC2) are MIDI controllers that can be assigned to a physical control (assignable switch, footswitch, EC5 switch). They can be activated either by a Note On or a Note Off message.
SC1 Note Off	
SC2 Note On	For example, imagine you are playing an Accordion DN1-type Sounds, and SC1 is assigned to an assignable switch. The SC1 controller is programmed as a 'booking'-type control in Sound Edit (Sound > Basic > Sound page), therefore it will affect the next Note On or Note Off event. If you press the switch before playing a note (Note On), a Riff Up will be triggered when playing a note. If you press the switch while the note is playing, a Fall Down will be triggered when releasing the note (Note Off).
SC2 Note Off	
Y+	Downward movement of the Joystick
Y-	Downward movement of the Joystick
After Touch	Deeper press on the key

Depending on the chosen Sounds and the assigned DNC functions, the SC1, SC2 and Y- controllers can either 'book' a function, that will be triggered while playing, or enable (or disable) it by pressing the button to 'toggle' it. When an SC1 or SC2 controller is assigned to an assignable switch, the indicator will show the DNC controllers status.

Indicator status	Meaning
Off	No DNC function assigned.
Red steady	Booking DNC function available.
Red blinking	Booking DNC function waiting to be executed. Then, it will return steady.
Green steady	Toggle DNC function available.
Green blinking	Toggle activated. Press it again to disable it.

Drum Kits

The following table lists all Factory Drum Kits as they appear in the Sound Select window. The table also includes MIDI data used to remotely select the Sounds. CC00: Control Change 0, or Bank Select MSB. CC32: Control Change 32, or Bank Select LSB. PC: Program Change.

Drum Kit	CC00	CC32	PC	Drum Kit	CC00	CC32	PC
Factory/Drum & SFX				Synth Kit 2	120	0	58
Pop Kit 1 Amb	120	0	52	Synth Kit 3	120	0	61
Funk Kit 1 Amb	120	0	53	Standard Kit 1	120	0	5
VintageKit 1 Amb	120	0	54	Standard Kit 2	120	0	1
Rock Kit 1 Amb	120	0	55	Standard Kit 3	120	0	2
Jazz Kit 1 Amb	120	0	62	Standard Kit 4	120	0	6
Standard Kit Amb	120	0	93	Ambient Kit	120	0	3
Room Kit Amb	120	0	80	Electro Kit 1	120	0	75
Power Kit 1 Amb	120	0	20	Electro Kit 2	120	0	76
Power Kit 2 Amb	120	0	21	Electro Kit 3	120	0	122
Rock Kit 2 Amb	120	0	22	Brush Kit 1	120	0	42
VintageKit 2 Amb	120	0	94	Brush Kit 2	120	0	43
Gate Kit Amb	120	0	23	Brush Kit 3	120	0	44
Cool Kit Amb	120	0	39	HipHop Kit 1	120	0	9
Jazz Kit 2 Amb	120	0	36	HipHop Kit 2	120	0	72
Jazz Kit 3 Amb	120	0	37	Jazz Kit 1	120	0	33
Brush Kit 1 Amb	120	0	45	Jazz Kit 2	120	0	34
Brush Kit 2 Amb	120	0	46	Jazz Kit 3	120	0	35
Lounge Kit Amb	120	0	38	House Kit 1	120	0	30
Real Kit 1 Amb	120	0	81	House Kit 2	120	0	31
Real Kit 2 Amb	120	0	82	Power Kit 1	120	0	18
Pop Kit 2 Amb	120	0	88	Power Kit 2	120	0	19
Studio Kit	120	0	95	Dance Kit	120	0	74
Drum & FX Kit 1	120	0	78	Analog Kit	120	0	123
Drum & FX Kit 2	120	0	79	Jungle Kit	120	0	10
Slice FX Kit	120	0	98	Pop Std. Kit 1	120	0	89
Groove Kit	120	0	77	Pop Std. Kit 2	120	0	90
Synth Kit 1	120	0	59	Pop Std. Kit 3	120	0	4

Drum Kit	CC00	CC32	PC
Standard PercKit	120	0	69
Braz. Perc. Kit	120	0	115
Arabian Kit 1	120	0	51
Arabian Kit 2	120	0	117
Turkish Kit	120	0	118
Oriental PercKit	120	0	119
Percussion Kit	120	0	64
Latin Perc.Kit 1	120	0	65
Latin Perc.Kit 2	120	0	68
Trinity Perc.Kit	120	0	66
i30 Perc. Kit	120	0	67
Timpani	121	1	47
Incipit Noises	121	3	119
SFX Kit 1	120	0	60
SFX Kit 2	120	0	57
Slices A FX	121	4	118
Slices B FX	121	5	118
Reverse Tom	121	2	117
Reverse Cymbal	121	2	119
Stadium	121	6	126
Legacy/Drum & SFX			
Standard Kit 5	120	0	7
Bdrum&Sdrum Kit	120	0	50
Room Kit 1	120	0	120
Room Kit 2	120	0	12
Power Kit 3	120	0	121
Power Kit 4	120	0	17
HipHop Kit 3	120	0	13
Elektro Kit 1	120	0	96
Elektro Kit 2	120	0	97
Techno Kit 1	120	0	11
Techno Kit 2	120	0	73
Techno Kit 3	120	0	15
Techno Kit 4	120	0	14

Drum Kit	CC00	CC32	PC
House Kit 3	120	0	26
House Kit 4	120	0	27
House Kit 5	120	0	28
Brush Kit 4	120	0	125
Brush Kit 5	120	0	41
Orchestra Kit	120	0	49
Log Drum	121	4	12
Reverse Snare	121	3	118
Dragon Gong	121	1	119
Castanets Plus	121	2	115
Woodblock	121	3	115
Footstep Walk	121	7	126
GM/XG/Drum			
Standard Kit GM	120	0	0
Room Kit GM	120	0	8
Power Kit GM	120	0	16
Electro Kit GM	120	0	24
Analog Kit GM	120	0	25
Jazz Kit GM	120	0	32
Brush Kit GM	120	0	40
Orchestra Kit GM	120	0	48
SFX Kit GM	120	0	56
Standard Kit1 XG	127	0	0
Standard Kit2 XG	127	0	1
Room Kit XG	127	0	8
Rock Kit XG	127	0	16
Electro Kit XG	127	0	24
Analog Kit XG	127	0	25
Jazz Kit 1 XG	127	0	32
Jazz Kit 2 XG	127	0	33
Brush Kit XG	127	0	40
Classic Kit XG	127	0	48
Pa4X V2			
Trance Kit	120	0	63

Drum Kit	CC00	CC32	PC
Dance Kit Remix	120	0	29
Pop Kit 2 Amb	120	0	70
Pop Kit 3 Amb	120	0	71
Jazz Kit 2 Amb	120	0	83
Brush Kit 1 Amb	120	0	84

Multisamples

The following table contains all the Factory Multisamples.

#	Multisample	#	Multisample	#	Multisample
0	Grand Piano 1 OT L	31	Grand Piano 4 R	62	Piano Hammer noise L
1	Grand Piano 1 OT R	32	Grand Piano 5 L	63	Piano Hammer noise R
2	Grand Piano 2 OT L	33	Grand Piano 5 R	64	Piano FX Pedal On L
3	Grand Piano 2 OT R	34	Grand Piano 6 L	65	Piano FX Pedal On R
4	Grand Piano 3 OT L	35	Grand Piano 6 R	66	Piano FX Pedal Off L
5	Grand Piano 3 OT R	36	Grand Piano Res 1 L	67	Piano FX Pedal Off R
6	Grand Piano 4 OT L	37	Grand Piano Res 1 R	68	Piano FX Key Off L
7	Grand Piano 4 OT R	38	Grand Piano Res 2 L	69	Piano FX Key Off R
8	Grand Piano 5 OT L	39	Grand Piano Res 2 R	70	Baby Grand L
9	Grand Piano 5 OT R	40	Grand Piano Res 3 L	71	Baby Grand R
10	Grand Piano 6 OT L	41	Grand Piano Res 3 R	72	Upright Piano mf L
11	Grand Piano 6 OT R	42	Grand Piano Res 4 L	73	Upright Piano mf R
12	Grand Piano Res 1 OT L	43	Grand Piano Res 4 R	74	Upright Piano f L
13	Grand Piano Res 1 OT R	44	Grand Piano Res 5 L	75	Upright Piano f R
14	Grand Piano Res 2 OT L	45	Grand Piano Res 5 R	76	E.GrandPiano 1
15	Grand Piano Res 2 OT R	46	Grand Piano Res 6 L	77	E.GrandPiano 2
16	Grand Piano Res 3 OT L	47	Grand Piano Res 6 R	78	Piano M1
17	Grand Piano Res 3 OT R	48	Acoustic Piano p OT L	79	E.Piano PO 1
18	Grand Piano Res 4 OT L	49	Acoustic Piano p OT R	80	E.Piano PO 2
19	Grand Piano Res 4 OT R	50	Acoustic Piano f OT L	81	E.Piano PO 3
20	Grand Piano Res 5 OT L	51	Acoustic Piano f OT R	82	E.Piano PO 4
21	Grand Piano Res 5 OT R	52	Acoustic Piano p L	83	E.Piano PO 5
22	Grand Piano Res 6 OT L	53	Acoustic Piano p R	84	E.Piano PO 6
23	Grand Piano Res 6 OT R	54	Acoustic Piano f L	85	E.Piano PO 7
24	Grand Piano 1 L	55	Acoustic Piano f R	86	E.Piano PO Kof p
25	Grand Piano 1 R	56	Acoustic Piano Res OT L	87	E.Piano PO Kof f
26	Grand Piano 2 L	57	Acoustic Piano Res OT R	88	E.Piano Rx Kon L
27	Grand Piano 2 R	58	Acoustic Piano Res L	89	E.Piano Rx Kon R
28	Grand Piano 3 L	59	Acoustic Piano Res R	90	E.Piano Rx Kof L
29	Grand Piano 3 R	60	Grand Piano Leakage L	91	E.Piano Rx Kof R
30	Grand Piano 4 L	61	Grand Piano Leakage R	92	E.Piano Suit Bright p

#	Multisample
93	E.Piano Suit Bright mf
94	E.Piano Suit Bright f
95	E.Piano Dyno p
96	E.Piano Dyno mf
97	E.Piano Dyno f
98	E.Piano Dyno Soft
99	E.Piano Dyno SoftLP
100	E.Piano Stage Hard
101	E.Piano Stage HardLP
102	E.Piano Vintage 1
103	E.Piano Vintage 2
104	E.Piano Vintage 3
105	E.Piano Vintage 4
106	E.Piano Vintage 5
107	E.Piano Vintage 6
108	E.Piano Vintage Koff
109	E.Piano Wurlly Soft
110	E.Piano Wurlly Hard
111	E.Piano FM AB 1
112	E.Piano FM AB 2
113	E.Piano FM AB 3
114	E.Piano FM EF 1
115	E.Piano FM EF 2
116	E.Piano FM EF 3
117	E.Piano FM EF 4
118	E.Piano FM 1
119	E.Piano FM 1LP
120	E.Piano FM 2
121	E.Piano Pad 1
122	E.Piano Pad 1LP
123	E.Piano Pad 2
124	Clav. BC 1
125	Clav. BC 2
126	Clav. BC 3

#	Multisample
127	Clav. BC 4
128	Clav. 1
129	Clav. 2
130	Clav. 3
131	Clav. 4
132	Clav. GM
133	Harpsichord1
134	Harpsichord1 Key Off
135	Harpsichord1 Release
136	Harpsichord1 Bump On
137	Harpsichord1 Bump Off
138	Harpsichord2
139	Harpsichord2 Key Off
140	Gospel Organ Slow L
141	Gospel Organ Slow R
142	Gospel Organ Fast L
143	Gospel Organ Fast R
144	16' 8' LF L
145	16' 8' LF R
146	16' 8' LS L
147	16' 8' LS R
148	16' 8' 51/3 LF L
149	16' 8' 51/3 LF R
150	16' 8' 51/3 LS L
151	16' 8' 51/3 LS R
152	4' 22/3' 2' LF L
153	4' 22/3' 2' LF R
154	4' 22/3' 2' LS L
155	4' 22/3' 2' LS R
156	11/3' 13/5' 1' LF L
157	11/3' 13/5' 1' LF R
158	11/3' 13/5' 1' LS L
159	11/3' 13/5' 1' LS R
160	16' 8' 51/3' Perc LF L

#	Multisample
161	16' 8' 51/3' Perc LF R
162	16' 8' 51/3' Perc LS L
163	16' 8' 51/3' Perc LS R
164	Theater Organ 1
165	Theater Organ 2
166	50s E.Organ Bright
167	50s E.Organ Dark
168	E.Organ CX 3
169	E.Organ Perc. 01W
170	E.Organ Fast Click
171	E.Organ Perc. 1
172	E.Organ Perc. 2
173	E.Organ Perc. 3
174	E.Organ Perc. 4
175	Organ 1 M1
176	Organ 2 M1
177	Organ 1
178	Organ 2
179	Organ 2LP
180	Organ 3 Jazz
181	BX3 & Perc. 3rd
182	E.Organ Vox
183	E.Organ Soft
184	E.Organ Full
185	E.Organ Dist
186	Rotary Organ 1
187	Rotary Organ 1LP
188	Rotary Organ 2
189	Super BX3
190	Super BX3LP
191	Rotor Noise LF L
192	Rotor Noise LF R
193	Rotor Noise LS L
194	Rotor Noise LS R

#	Multisample
195	H Organ Leakage
196	H Organ 2nd Harmonic
197	H Organ Click Kon
198	H Organ Click Koff
199	ON-Click (Organ)
200	OFF-Click (Organ)
201	Pipe Flute L
202	Pipe Flute R
203	Pipe Positive
204	Pipe Mixture
205	Pipe Full 1 L
206	Pipe Full 1 R
207	Pipe Full 2
208	E.Organ Church
209	EI Organ Toy
210	Music Box
211	Music BoxLP
212	Kalimba
213	Kalimba GM
214	Marimba
215	MarimbaLP
216	Xylophone
217	Balaphone
218	Vibraphone1
219	Vibraphone1LP
220	Vibraphone2
221	Celesta
222	Celesta GM
223	CelestaLP
224	Glockenspiel
225	GlockenspielLP
226	Tubular Bell
227	Log Drum
228	Steel Drum Hard

#	Multisample
229	Steel Drum GM
230	Steel Drum HardLP
231	Gamelan
232	FM Bell
233	Flute mf
234	Flute f
235	Flute Chiff
236	Flute Singed
237	Flute Flutter
238	Flute Fall Down
239	Flute Riff Up
240	Flute Gliss Down Sus
241	Flute
242	Flute Falls
243	Flute Gliss Up
244	Flute Gliss Down
245	Flute Frull
246	Flute Voice
247	Flute Jazz
248	Flute Vibrato
249	Flute Attack p
250	Flute Attack f
251	Breath Noise RX
252	Piccolo
253	Pan Flute
254	Pan Flute Attack
255	Tin Whistle
256	Tin Whistle Voice
257	Tin Whistle Attack
258	Whistle Gliss
259	Whistle Straight
260	Whistle Sfz Vibr
261	Whistle Sfz No Vibr
262	Whistle Slow Atk Vibr

#	Multisample
263	Whistle Breath
264	Shakuhachi
265	Shakuhachi Atk
266	Shakuhachi Mid
267	Shakuhachi High
268	Bottle
269	Bottlizer
270	Shanai GM
271	Recorder
272	Ocarina
273	Clarinet 1 Vibrato p
274	Clarinet 1 Vibrato f
275	Clarinet 1 GlissUp
276	Clarinet 1 GlissUp Sus
277	Clarinet 1 Fall
278	Clarinet 2
279	Clarinet 3
280	Double Reed M1
281	Oboe 1 Vibrato
282	Oboe 2 Straight
283	Oboe key noises
284	Oboe Get a Breath
285	English Horn
286	Bassoon 1
287	Bassoon 1 Vibrato
288	Bassoon 1 Staccato
289	Bassoon 2
290	Baritone Sax p
291	Baritone Sax f
292	Baritone Sax Growl
293	Baritone Sax GM
294	Tenor Sax Vib 1
295	Tenor Sax Vib 2
296	Tenor Sax Vib 3

#	Multisample
297	Tenor Sax Vib 4
298	Tenor Sax Glissando
299	Tenor Sax Falls
300	Tenor Sax Straight
301	Tenor Sax Riff Up
302	Tenor Sax Fall Down
303	Tenor Sax Vibrato
304	Tenor Sax Expressive
305	Tenor Sax p
306	Tenor Sax mf
307	Tenor Sax f
308	Tenor Sax M1
309	Tenor Sax GM
310	Alto Sax Vib 1
311	Alto Sax Vib 2
312	Alto Sax Vib 2 Drive
313	Alto Sax p
314	Alto Sax f
315	Alto Sax GM
316	Alto Sax Growl
317	Soprano Sax Vibrato
318	Soprano Sax Straight
319	Soprano Sax GM
320	Sax Family Vibrato
321	Sax key on
322	Sax key off
323	Sax breath
324	Tsax sfp< L
325	Tsax sfp< R
326	Musette 1
327	Musette 2
328	Musette 2LP
329	Musette 3 L
330	Musette 3 R

#	Multisample
331	Accordion 16'
332	Accordion 16' OT
333	Accordion 8'
334	Accordion 8' OT
335	Accordion 4'
336	Accordion 4' OT
337	Accordion preset 1
338	Accordion preset 2
339	Accordion Bassoon
340	Accordion Clarinet
341	Accordion Bandoneon
342	Accordion Volkst.
343	Accordion Bass
344	Accordion Noise KeyOn
345	Accordion Noise KeyOff
346	Accordion Change Voice
347	Harmonica 1
348	Harmonica 1 Fall
349	Harmonica 2
350	Harmonica 3 Wah
351	Melodica
352	Melodica Key On
353	Melodica Key Off
354	Highland Bag Pipes
355	Highland Drones
356	Uilleann Pipes
357	Bag Pipes
358	Bag Pipes GM
359	French Horn 1 p
360	French Horn 1 mf
361	French Horn 1 f
362	French Horn 1 ff
363	French Horn 2 Close
364	French Horn 2 Open

#	Multisample
365	French Horn T1
366	Tenor Horn
367	2Horns Str p L
368	2Horns Str p R
369	2Horns Str mf L
370	2Horns Str mf R
371	2Horns Str f L
372	2Horns Str f R
373	2Horns Str ff L
374	2Horns Str ff R
375	2Horns Stacc p L
376	2Horns Stacc p R
377	2Horns Stacc mf L
378	2Horns Stacc mf R
379	2Horns Stacc f L
380	2Horns Stacc f R
381	2Horns Stacc ff L
382	2Horns Stacc ff R
383	French Horn Ensemble
384	French Horns GM
385	Flugelhorn Vib light p
386	Flugelhorn Vib light mf
387	Flugelhorn Vib light f
388	Flugelhorn Vib light ff
389	Flugelhorn Staccato p
390	Flugelhorn Staccato f
391	Flugel Octave Up p
392	Flugel Octave Up f
393	Flugel Octave Dw p
394	Flugel Octave Dw f
395	Flugel Falls p
396	Flugel Falls f
397	Flugel Horn Vibrato
398	Flugel Horn M1

#	Multisample
399	Flugel Atk Noise
400	Euphonium Vibrato p
401	Euphonium Vibrato f
402	Euphonium Staccato p
403	Euphonium Staccato f
404	Tuba p
405	Tuba f
406	Tuba GM
407	Tuba Bariton Attack
408	Trombone 1 p
409	Trombone 1 mf
410	Trombone 1 f
411	Trombone 1 Gliss Up
412	Trombone 1 Fall
413	Trombone 1 Smear
414	Trombone 1 Smear Atk
415	Trombone 2 Vibrato
416	Trombone 3 mf
417	Trombone 3 f
418	Trombone 4 Soft
419	Trombone 4 Bright
420	Trombone 5 Straight fff
421	Trombone Slur Up
422	Trombone Fall
423	Trombone GM
424	Trombone Muted
425	2 Trombones mf L
426	2 Trombones mf R
427	2 Trombones f L
428	2 Trombones f R
429	2 Trombones Str p L
430	2 Trombones Str p R
431	2 Trombones Str f L
432	2 Trombones Str f R

#	Multisample
433	2 Trombones Sfp< L
434	2 Trombones Sfp< R
435	2 Trombones Shake L
436	2 Trombones Shake R
437	2 Trombones Fall L
438	2 Trombones Fall R
439	2 Trombones Glissup L
440	2 Trombones Glissup R
441	Classic Trumpet p
442	Classic Trumpet f
443	Pop Trumpet p
444	Pop Trumpet f
445	Trumpet Expr.
446	Trumpet Slow p
447	Trumpet Slow f
448	Trumpet GM
449	Trumpet Tonguing p
450	Trumpet Tonguing f
451	Trumpet Medium
452	Trumpet Overblown
453	Trumpet Muted
454	Trumpet Muted GM
455	Trumpet Wah
456	Trumpet WDH Vib
457	Trumpet WDH Shakes
458	Trumpet WDH Shakes Atk
459	Trumpet WDH Shakes Rel
460	Trumpet Doit
461	Trumpet Fall
462	TRP CupMute Vib p
463	TRP CupMute Vib mf
464	TRP CupMute Vib f
465	TRP CupMute Wha Vib
466	TRP CupMute Wha Fast

#	Multisample
467	TRP CupMute Wha Growl
468	TRP CupMute Dw 4th
469	TRP CupMute Up 4th
470	TRP CupMute Fall p
471	TRP CupMute Doit
472	TRP MuteHarm Vib p
473	TRP MuteHarm Vib mf
474	TRP MuteHarm Vib f
475	TRP MuteHarm Stac p
476	TRP MuteHarm Stac f
477	TRP MuteHarm Dw
478	TRP MuteHarm Up
479	TRP MuteHarm Doit
480	TRP MuteHarm Falls
481	TRP MuteHarm Bump Atk
482	TRP Basic Noise
483	2 Trumpets p L
484	2 Trumpets p R
485	2 Trumpets f L
486	2 Trumpets f R
487	2 Trumpets Str mf L
488	2 Trumpets Str mf R
489	2 Trumpets Str ff L
490	2 Trumpets Str ff R
491	2 Trumpets Sfp< L
492	2 Trumpets Sfp< R
493	2 Trumpets Shake L
494	2 Trumpets Shake R
495	2 Trumpets Fall L
496	2 Trumpets Fall R
497	2 Trumpets Glissup L
498	2 Trumpets Glissup R
499	2Tp 2Tb Hit (SFX) L
500	2Tp 2Tb Hit (SFX) R

#	Multisample
501	Brass Ensemble Stereo L
502	Brass Ensemble Stereo R
503	Brass Ensemble 1
504	Brass Ensemble 2
505	Brass Ensemble 2LP
506	Brass Ensemble GM
507	Soprano Movie
508	Soprano Night
509	Soprano Voice
510	Soprano Voice AD
511	Soprano Voice 5thDw
512	Soprano Voice 4thUp
513	Voice Female Wuh
514	Voice Female Woh
515	Voice Female Wah
516	Voice Female Dah
517	Voice Male Wuh
518	Voice Male Woh
519	Voice Male Wah
520	Voice Male Dah
521	Voice Scat Buh
522	Voice Scat Duh
523	Voice Scat Bah
524	Voice Scat Dah
525	Voice Choir
526	Voice Hoo
527	Voice Pop Ooh
528	Voice Pop Ah
529	Voice Doo
530	Voice DooLP
531	Choir Ahh Male/Fem p L
532	Choir Ahh Male/Fem p R
533	Choir Ahh Male/Fem f L
534	Choir Ahh Male/Fem f R

#	Multisample
535	Choir Ohh Male/Fem L
536	Choir Ohh Male/Fem R
537	Choir Uhh Male/Fem L
538	Choir Uhh Male/Fem R
539	Choir Da Male/Fem L
540	Choir Da Male/Fem R
541	Choir Di Male/Fem L
542	Choir Di Male/Fem R
543	Choir Du Male/Fem L
544	Choir Du Male/Fem R
545	Choir La Male/Fem L
546	Choir La Male/Fem R
547	Choir Pa Male/Fem L
548	Choir Pa Male/Fem R
549	Choir Tu Male/Fem L
550	Choir Tu Male/Fem R
551	Choir Humming M/F L
552	Choir Humming M/F R
553	Choir Whisper Female L
554	Choir Whisper Female R
555	Choir Whisper Male L
556	Choir Whisper Male R
557	Violin 1 Espressive p
558	Violin 1 Espressive mf
559	Violin 1 Espressive f
560	Violin 1 Detache Vib p
561	Violin 1 Detache Vib f
562	Violin 1 Balzato 1
563	Violin 1 Balzato 2
564	Violin 1 Sforzato
565	Violin 1 Tremolo
566	Violin 1 Pizzicato 1
567	Violin 1 Pizzicato 2
568	Violin 1 Play Up

#	Multisample
569	Violin 1 Play End
570	Violin 1 Bow Noise
571	Violin 2 Classic
572	Violin 2 Gliss Up
573	Violin 2 Gliss Dw
574	Violin 2 Strings Free
575	Violin 2 Trill Up
576	Violin 3 Solo Vibrato
577	Violin 3 Straight
578	Violin GM
579	Fiddle GM
580	Viola 1 Espressive p
581	Viola 1 Espressive f
582	Viola 1 Detache p Up
583	Viola 1 Detache p Dw
584	Viola 1 Balzato p
585	Viola 1 Balzato mf
586	Viola 1 Sforzato
587	Viola 1 Staccato
588	Viola 1 Tremolo
589	Viola 1 Pizzicato
590	Viola 2 Vibrato p
591	Viola 2 Vibrato f
592	Viola GM
593	Cello Vibrato L
594	Cello Vibrato R
595	Cello GM
596	Violin & Cello
597	Cello & Contrabass
598	Contrabass Vibrato L
599	Contrabass Vibrato R
600	Strings Quartet L
601	Strings Quartet R
602	Strings Quartet Vibrato1

#	Multisample
603	Strings Quartet Vibrato2
604	Pizzicato
605	Strings Ens Legato1 L
606	Strings Ens Legato1 R
607	Strings Ens Legato2 L
608	Strings Ens Legato2 R
609	Strings Ens Legato3 L
610	Strings Ens Legato3 R
611	Strings Ens Marcato L
612	Strings Ens Marcato R
613	Strings Ens Spiccato L
614	Strings Ens Spiccato R
615	Strings Ens Staccato1 L
616	Strings Ens Staccato1 R
617	Strings Ens Staccato2 L
618	Strings Ens Staccato2 R
619	Strings Ens Tremolo L
620	Strings Ens Tremolo R
621	Strings Ens Pizzicato L
622	Strings Ens Pizzicato R
623	Strings Ensemble St L
624	Strings Ensemble St R
625	Strings Ensemble GM L
626	Strings Ensemble GM R
627	Strings Ensemble Mono
628	Strings Ensemble Tremolo
629	Pizzicato Ensemble
630	Harp Stereo L
631	Harp Stereo R
632	Harp Atk L
633	Harp Atk R
634	Harp Mono
635	Ac.Gtr T 1 L
636	Ac.Gtr T 1 R

#	Multisample
637	Ac.Gtr T 2 L
638	Ac.Gtr T 2 R
639	Ac.Gtr T 3 L
640	Ac.Gtr T 3 R
641	Ac.Gtr T 4 L
642	Ac.Gtr T 4 R
643	Ac.Gtr T 5 L
644	Ac.Gtr T 5 R
645	Ac.Gtr T 6 L
646	Ac.Gtr T 6 R
647	Ac.Gtr T Ghost L
648	Ac.Gtr T Ghost R
649	Ac.Gtr T Mute 1 L
650	Ac.Gtr T Mute 1 R
651	Ac.Gtr T Mute 2 L
652	Ac.Gtr T Mute 2 R
653	Ac.Gtr T Mute 3 L
654	Ac.Gtr T Mute 3 R
655	Ac.Gtr T Harmonics 1 L
656	Ac.Gtr T Harmonics 1 R
657	Ac.Gtr T Harmonics 2 L
658	Ac.Gtr T Harmonics 2 R
659	Ac.Gtr T HTone Up 1 L
660	Ac.Gtr T HTone Up 1 R
661	Ac.Gtr T HTone Up 2 L
662	Ac.Gtr T HTone Up 2 R
663	Ac.Gtr M 1 L
664	Ac.Gtr M 1 R
665	Ac.Gtr M 2 L
666	Ac.Gtr M 2 R
667	Ac.Gtr M 3 L
668	Ac.Gtr M 3 R
669	Ac.Gtr M Mute 1 L
670	Ac.Gtr M Mute 1 R

#	Multisample
671	Ac.Gtr M Mute 2 L
672	Ac.Gtr M Mute 2 R
673	Ac.Gtr M Harmonics L
674	Ac.Gtr M Harmonics R
675	Ac.Gtr M HTone Up 1 L
676	Ac.Gtr M HTone Up 1 R
677	Ac.Gtr M HTone Up 2 L
678	Ac.Gtr M HTone Up 2 R
679	Ac.Gtr RX noises L
680	Ac.Gtr RX noises R
681	Ac.Gtr finger off L
682	Ac.Gtr finger off R
683	Steel Gtr 1 Pick p
684	Steel Gtr 1 Pick mf
685	Steel Gtr 1 Pick f
686	Steel Gtr 1 Mute
687	Steel Gtr 1 Slide
688	Steel Gtr 2 p
689	Steel Gtr 2 mf
690	Steel Gtr 2 f
691	Steel Gtr 2 Slap
692	Steel Gtr 2 Slide
693	Steel Gtr 12 Strings
694	Steel Gtr Harmonics 1
695	Steel Gtr Harmonics 2
696	Steel Gtr Noise
697	Guitar Fret Noise Off
698	Guitar Noise Off
699	Guitar Body
700	Guitar Noise Attack Off
701	Nylon Gtr1 p L
702	Nylon Gtr1 p R
703	Nylon Gtr1 mf1 L
704	Nylon Gtr1 mf1 R

#	Multisample
705	Nylon Gtr1 mf2 L
706	Nylon Gtr1 mf2 R
707	Nylon Gtr1 mf3 L
708	Nylon Gtr1 mf3 R
709	Nylon Gtr1 f L
710	Nylon Gtr1 f R
711	Nylon Gtr1 Slide p L
712	Nylon Gtr1 Slide p R
713	Nylon Gtr1 Slide f L
714	Nylon Gtr1 Slide f R
715	Nylon Gtr1 Harmonics L
716	Nylon Gtr1 Harmonics R
717	Nylon Gtr2 p
718	Nylon Gtr2 mf
719	Nylon Gtr2 f
720	Nylon Gtr2 Atk
721	Nylon Gtr2 GM
722	Nylon Gtr 7 Strings p
723	Nylon Gtr 7 Strings f
724	Nylon Gtr 7 Strings Mute
725	FS N Dw Clean 1
726	FS N Dw Clean 2
727	FS N Dw Clean 3
728	FS N Dw Clean 4
729	FS N Ghost Clean
730	FS N Mute Clean 1
731	FS N Mute Clean 2
732	FS N Mute Clean 3
733	FS N Mute Clean 4
734	FS N Mute Clean 5
735	FS N Dw DI 1
736	FS N Dw DI 2
737	FS N Dw DI 3
738	FS N Dw DI 4

#	Multisample
739	FS N Dw DI 5
740	FS N Dw DI 6
741	FS N Ghost DI
742	FS N Mute DI 1
743	FS N Mute DI 2
744	FS N Mute DI 3
745	FS N Mute DI 4
746	FS N Mute DI 5
747	FS B Dw Overdrive 1
748	FS B Dw Overdrive 2
749	FS B Dw Overdrive 3
750	FS B Mute Overdrive 1
751	FS B Mute Overdrive 2
752	FS B Mute Overdrive 3
753	FS B RX Noise Ovd 1
754	FS B RX Noise Ovd 2
755	FS B RX Noise Ovd 3
756	FS B Dw DI 1
757	FS B Dw DI 2
758	FS B Dw DI 3
759	FS B Dw DI 4
760	FS B Dw DI 5
761	FS B Dw DI 6
762	FS B Mute DI 1
763	FS B Mute DI 2
764	FS B Mute DI 3
765	FS B Mute DI 4
766	FS B Mute DI 5
767	FS RX Noise DI 1
768	FS RX Noise DI 2
769	FS RX Noise DI 3
770	FS Amp Noise Floor
771	Tele M Dw Clean 1
772	Tele M Dw Clean 2

#	Multisample
773	Tele M Dw Clean 3
774	Tele M Dw Clean 4
775	Tele M Mute Clean 1
776	Tele M Mute Clean 2
777	Tele M Mute Clean 3
778	Tele M Mute Clean 4
779	Tele M Mute Clean 5
780	Tele M RX Noise Clean 1
781	Tele M RX Noise Clean 2
782	Tele M RX Noise Clean 3
783	Tele M Dw DI 1
784	Tele M Dw DI 2
785	Tele M Dw DI 3
786	Tele M Dw DI 4
787	Tele M Dw DI 5
788	Tele M Dw DI 6
789	Tele M Mute DI 1
790	Tele M Mute DI 2
791	Tele M Mute DI 3
792	Tele M Mute DI 4
793	Tele M Mute DI 5
794	Tele M RX Noise DI 1
795	Tele M RX Noise DI 2
796	Tele M RX Noise DI 3
797	GLP M Dw Clean 1
798	GLP M Dw Clean 2
799	GLP M Dw Clean 3
800	GLP M Dw Clean 4
801	GLP M Mute Clean 1
802	GLP M Mute Clean 2
803	GLP M Mute Clean 3
804	GLP M Mute Clean 4
805	GLP M Mute Clean 5
806	GLP M RX Noise Clean 1

#	Multisample
807	GLP M RX Noise Clean 2
808	GLP M RX Noise Clean 3
809	GLP M Dw DI 1
810	GLP M Dw DI 2
811	GLP M Dw DI 3
812	GLP M Dw DI 4
813	GLP M Dw DI 5
814	GLP M Dw DI 6
815	GLP M Mute DI 1
816	GLP M Mute DI 2
817	GLP M Mute DI 3
818	GLP M Mute DI 4
819	GLP M Mute DI 5
820	GLP RX Noise DI 1
821	GLP RX Noise DI 2
822	GLP RX Noise DI 3
823	G335 B Dw Dist 1
824	G335 B Dw Dist 2
825	G335 B Dw Dist 3
826	G335 B Ghost Dist
827	G335 B Mute Dw Dist 1
828	G335 B Mute Dw Dist 2
829	G335 B Mute Dw Dist 3
830	G335 B Mute Dw Dist 4
831	G335 B Mute Dw Dist 5
832	G335 B RX Dist 1
833	G335 B RX Dist 2
834	G335 B RX Dist 3
835	G335 B Dw DI 1
836	G335 B Dw DI 2
837	G335 B Dw DI 3
838	G335 B Dw DI 4
839	G335 B Dw DI 5
840	G335 B Dw DI 6

#	Multisample
841	G335 B Ghost DI
842	G335 B Mute DI 1
843	G335 B Mute DI 2
844	G335 B Mute DI 3
845	G335 B Mute DI 4
846	G335 B Mute DI 5
847	G335 B RX Noise DI 1
848	G335 B RX Noise DI 2
849	G335 B RX Noise DI 3
850	Dist Guitar MP 1
851	Dist Guitar MP 2
852	Dist Guitar MP 3
853	Dist Guitar MP 4
854	Dist Guitar MP 5
855	Dist Guitar MP Slides
856	Dist Guitar MP KeyOff
857	Stra P2 MTS1
858	Stra P2 MTS2
859	Stra P2 MTS3
860	Stra P2 MTS4
861	Stra P2 MTS5
862	Stra P2 MTS6
863	Stra P2 MTL1
864	Stra P2 MTL2
865	Stra P2 MTL3
866	Stra P2 MTL4
867	Stra P2 Dw1
868	Stra P2 Dw2
869	Stra P2 Dw3
870	Stra P2 Dw4
871	Stra P2 Dw5
872	Stra P2 Up1
873	Stra P2 Up2
874	Stra P2 Up3

#	Multisample
875	Stra P2 Up4
876	Stra P2 Up5
877	Stra P2 SlideHT p
878	Stra P2 SlideHT f
879	Stra P2 Harm 12
880	Stra P2 Harm 7
881	Stra P2 Harm 5
882	Stra P2 Ghost Up
883	Stra P2 Ghost Dw
884	Stra P2 Fret Nuances
885	Stra P2 Key Off
886	Stra RX1 (Old Compatib)
887	Stra RX2
888	El.Guitar Stra 54 p
889	El.Guitar Stra 54 mf
890	El.Guitar Stra 54 f
891	El.Guitar Stra 54 Slide
892	El.Guitar Tel Mid p
893	El.Guitar Tel Mid mf
894	El.Guitar Tel Mid f
895	El.Guitar Tel Bridge p
896	El.Guitar Tel Bridge mf
897	El.Guitar Tel Bridge f
898	El.Guitar Tel Mt 5th pp
899	El.Guitar Tel Mt 5th p
900	El.Guitar Tel Mt 5th mf
901	El.Guitar Tel Mt 5th f
902	El.Guitar Tel Mt 5th ff
903	El.Guitar Tel Mt 5th Kof
904	El.Guitar Clean Str p
905	El.Guitar Clean Str f
906	El.Guitar Clean Mute
907	El.Guitar Clean Dead
908	El.Guitar Clean Slap

#	Multisample
909	El.Guitar Clean Slide
910	El.Guitar Clean GM
911	El.Guitar Fret Noise GM
912	El.Guitar Cut Noise GM
913	El.Guitar Le Neck
914	El.Guitar Le Bridge
915	El.Guitar Le Mute p
916	El.Guitar Le Mute mf
917	El.Guitar Le Ghost1
918	El.Guitar Le Ghost2
919	El.Guitar Harmonics
920	El.Guitar Gliss Down
921	El.Guitar Gliss Up
922	El.Guitar Noise
923	El.Guitar Short Noise
924	El.Guitar Fret Noise
925	El.Guitar Les P.
926	Jazz Guitar1
927	Jazz Guitar2
928	Jazz Gib mellow p
929	Jazz Gib mellow mf
930	Jazz Gib mellow f
931	Jazz Octave Guitar
932	Pedal Steel Guitar
933	Resonator Guitar
934	Vox Wah Guitar
935	Overdrive GM
936	Dist.Guitar1
937	Dist.Guitar1 GM
938	Dist.Guitar1 Harm.
939	Dist.Guitar1 Harm. GM
940	Dist.Guitar2 Harmo P1
941	Dist.Guitar2 Harmo P2
942	Dist.Guitar2 Mutel

#	Multisample
943	Dist.Guitar2 Mute2
944	El.Guitar DistMuted 1
945	El.Guitar DistMuted 2
946	El.Guitar PowerChord1
947	El.Guitar PowerChord2
948	El.Guitar PowerChord3
949	Ac.Bass Natural
950	Ac.Bass Natural Key Off
951	Ac.Bass Natural Ghost
952	Acoustic Bass1
953	Acoustic Bass2 mf
954	Acoustic Bass2 f
955	Acoustic Bass3 mp
956	Acoustic Bass3 mp VAR
957	Acoustic Bass3 mf
958	Acoustic Bass3 mf VAR
959	Acoustic Bass3 f
960	Acoustic Bass3 f VAR
961	Acoustic Bass GM
962	Acoustic Bass RX Noises
963	Bass SR Finger 1
964	Bass SR Finger 2
965	Bass SR Finger 3
966	Bass SR Ghost 1
967	Bass SR Ghost 2
968	Bass SR Ghost 3
969	Bass SR Ghost 4
970	Bass SR Finger Mute 1
971	Bass SR Finger Mute 2
972	Bass SR Finger Mute 3
973	Bass SR Pick1
974	Bass SR Pick2
975	Bass SR Pick3
976	Bass SR Pick4

#	Multisample
977	Bass SR Pick Mute 1
978	Bass SR Pick Mute 2
979	Bass SR Pick Mute 3
980	Bass SR Harmonics
981	Bass SR Note Off
982	Bass SR Thumb&Slap 1
983	Bass SR Thumb&Slap 2
984	Bass SR Slide UD
985	Bass SR Slide Down
986	Bass SR Hammer On
987	JB Finger 1
988	JB Finger 2
989	JB Finger 3
990	JB Finger 4
991	JB Finger 5
992	JB Ghost
993	JB Finger Mute 1
994	JB Finger Mute 2
995	JB Finger Mute 3
996	JB Pick 1
997	JB Pick 2
998	JB Pick 3
999	JB Pick 4
1000	JB Pick Mute 1
1001	JB Pick Mute 2
1002	JB Pick Mute 3
1003	JB Thumb 1
1004	JB Thumb 2
1005	JB Slap 1
1006	JB Slap 2
1007	JB Slap Ghost
1008	JB Harmonics
1009	PB FS Finger 1
1010	PB FS Finger 2

#	Multisample
1011	PB FS Finger 3
1012	PB FS Finger 4
1013	PB FS Ghost
1014	PB FS Fing Mute 1
1015	PB FS Fing Mute 2
1016	PB FS Fing Mute 3
1017	PB FS Pick 1
1018	PB FS Pick 2
1019	PB FS Pick 3
1020	PB FS Pick 4
1021	PB FS Pick Mute 1
1022	PB FS Pick Mute 2
1023	PB FS Pick Mute 3
1024	PB FS Pick Mute 4
1025	PB FS Harmonics
1026	PB Finger 1
1027	PB Finger 2
1028	PB Finger 3
1029	PB Finger 4
1030	PB Finger 5
1031	FJB Fretless Finger 1
1032	FJB Fretless Finger 2
1033	FJB Fretless Finger 3
1034	FJB Fretless Finger 4
1035	FJB Fretless Vibrato
1036	FJB Fretless Harm 1
1037	FJB Fretless Harm 2
1038	FJB Fretless Hammer On
1039	FJB Fretless KeyOff
1040	Bass Prec FS Finger
1041	Bass Prec Finger
1042	Bass Prec FingerDeads
1043	Bass Prec Pick Open p
1044	Bass Prec Pick Open f

#	Multisample
1045	Bass Prec Pick Dead
1046	Bass Sray Finger
1047	Bass Sray Harmonics
1048	Bass Sray Deads
1049	Bass Sray HandNoise
1050	Bass Almb Fingered p
1051	Bass Almb Fingered f
1052	Bass Fjazz Fingered
1053	Bass Fjazz pickmute p
1054	Bass Fjazz pickmute f
1055	Bass Fjazz Ghost
1056	E.Bass1 Finger
1057	E.Bass2 P.B.1
1058	E.Bass2 P.B.2
1059	E.Bass2 LH Stop
1060	E.Bass2 RH Stop
1061	E.Bass2 Harmo.
1062	E.Bass3 p
1063	E.Bass3 mf
1064	E.Bass3 f Slap
1065	E.Bass4 Pick
1066	E.Bass4 Harmo.
1067	E.Bass4 Slap
1068	E.Bass4 SlapHar
1069	E.Bass4 LH Mute
1070	E.Bass4 RH Mute
1071	E.Bass5 Finger
1072	E.Bass6 Finger
1073	E.Bass6 FingerLP
1074	E.Bass7 Finger
1075	E.Bass8 Pick
1076	E.Bass9 Pick Muted1
1077	E.Bass9 Pick Muted2
1078	E.Bass9 Pick

#	Multisample
1079	E.Bass9 PickLP
1080	E.Bass10 Thumb
1081	E.Bass11 SlapThumb
1082	E.Bass11 SlapThumbLP
1083	E.Bass Gliss
1084	E.Bass Noise1
1085	E.Bass Noise2
1086	E.Bass Harmonics
1087	E.Bass HarmonicsLP
1088	E.Bass Fretless 1
1089	E.Bass Fretless 2
1090	Finger Bass GM
1091	Picked Bass GM
1092	Slap Bass 1 GM
1093	Slap Bass 2 GM
1094	Fretless Bass GM
1095	Sitar 1
1096	Sitar 2
1097	Sitar GM
1098	Sitar & Tambura
1099	Zither
1100	Santur
1101	SanturLP
1102	Tambura
1103	TamburaLP
1104	Bouzouki
1105	BouzoukiLP
1106	Mandolin Dw mf L
1107	Mandolin Dw mf R
1108	Mandolin Dw f L
1109	Mandolin Dw f R
1110	Mandolin Up L
1111	Mandolin Up R
1112	Mandolin mono

#	Multisample
1113	Mandolin monoLP
1114	Mandolin Tremolo
1115	Mandolin Ensemble
1116	Viola Caipira p
1117	Viola Caipira mf
1118	Viola Caipira f
1119	Viola Caipira Mute
1120	Viola Caipira Harmonics
1121	Viola Caipira Noises
1122	Bandolim
1123	Berimbau Op Q 1
1124	Berimbau Op Q 2
1125	Berimbau Op Q 3
1126	Berimbau Op Q 4
1127	Berimbau Op A 1
1128	Berimbau Op A 2
1129	Berimbau Op A 3
1130	Berimbau Op A Rel 1
1131	Berimbau Op A Rel 2
1132	Berimbau Op A Rel 3
1133	Berimbau Cax atk p
1134	Berimbau Cax atk f
1135	Berimbau Cax rel p
1136	Berimbau Cax rel f
1137	Berimbau Crash Leg p
1138	Berimbau Crash Leg f
1139	Berimbau Crash p
1140	Berimbau Crash f
1141	Banjo1 Finger Op 1
1142	Banjo1 Finger Op 2
1143	Banjo1 Finger Op 3
1144	Banjo1 Finger Op 4
1145	Banjo1 Finger Op 5
1146	Banjo1 Finger Op 6

#	Multisample
1147	Banjo1 Thumb Op 1
1148	Banjo1 Thumb Op 2
1149	Banjo1 Thumb Op 3
1150	Banjo1 Thumb Op 4
1151	Banjo1 Thumb Op 5
1152	Banjo1 Thumb Op 6
1153	Banjo1 Ghost
1154	Banjo1 Mute 1
1155	Banjo1 Mute 2
1156	Banjo1 Mute 3
1157	Banjo1 Harmonics
1158	Banjo1 Mordente
1159	Banjo2
1160	Banjo GM
1161	BanjoLP
1162	Banjo RX Noise
1163	Dobro Thumb 1 L
1164	Dobro Thumb 1 R
1165	Dobro Thumb 2 L
1166	Dobro Thumb 2 R
1167	Dobro Thumb 3 L
1168	Dobro Thumb 3 R
1169	Dobro Thumb 4 L
1170	Dobro Thumb 4 R
1171	Dobro Thumb 5 L
1172	Dobro Thumb 5 R
1173	Dobro Thumb 6 L
1174	Dobro Thumb 6 R
1175	Dobro Ghost L
1176	Dobro Ghost R
1177	Dobro Muted 1 L
1178	Dobro Muted 1 R
1179	Dobro Muted 2 L
1180	Dobro Muted 2 R

#	Multisample
1181	Dobro Muted 3 L
1182	Dobro Muted 3 R
1183	Dobro Rake Blues L
1184	Dobro Rake Blues R
1185	Dobro Vibrato L
1186	Dobro Vibrato R
1187	Dobro Slide Vibrato L
1188	Dobro Slide Vibrato R
1189	Dobro Harmonics L
1190	Dobro Harmonics R
1191	Dobro Pick Noise L
1192	Dobro Pick Noise R
1193	Cavaquinho p
1194	Cavaquinho mf
1195	Cavaquinho f
1196	Ukulele
1197	Shamisen
1198	Shamisen GM
1199	Koto
1200	Koto GM
1201	M.E. Oud
1202	M.E. Oud Tek
1203	M.E. Kanoun1
1204	M.E. Kanoun2
1205	M.E. Kanoun Tremolo
1206	M.E. Baglama1
1207	M.E. Baglama2
1208	M.E. Zurna
1209	M.E. Klarnet Tek
1210	M.E. Klarnet
1211	M.E. Nay
1212	Mouth Harp1
1213	Mouth Harp2
1214	Mouth Harp3

#	Multisample
1215	Mouth Harp4
1216	Mouth Harp5
1217	Syn Flute Pad
1218	Synth Sub Bass-L
1219	Synth Sub Bass-R
1220	Syn Bass Reso
1221	Syn Bass FM1
1222	Syn Bass FM1LP
1223	Syn Bass FM2
1224	Syn Bass FM2LP
1225	Syn Bass TB
1226	R&B Saw Bass
1227	R&B Square Bass
1228	MS20 Bass Wave
1229	MS20 Synth
1230	SEM Square
1231	Chrom Res
1232	Compulsynth
1233	Monst Classic
1234	Monst Distort
1235	Next Dance
1236	Fat Synth LG
1237	Detuned Super
1238	Detuned PWM
1239	Polysix Unison L
1240	Polysix Unison R
1241	Synth Brass
1242	Pop Synth
1243	An.Strings1
1244	An.Strings2
1245	Vintage Synth Pad L
1246	Vintage Synth Pad R
1247	Vintage Analog
1248	Food Blender

#	Multisample
1249	White Pad
1250	N1 Air Vox
1251	SynthBell
1252	Ether Bell
1253	Ether BellLP
1254	Lore
1255	Lore NT
1256	Space Lore
1257	Wave Sweep1
1258	Wave Sweep2
1259	Wave Sweep3
1260	Syn Ghostly
1261	Ghost
1262	Syn Air Pad
1263	Dream Str
1264	Syn AirVortex
1265	Syn Palawan
1266	Syn Clicker
1267	Cricket Spectrum
1268	Noise1
1269	Noise2
1270	Noise Pad
1271	Swish Terra
1272	Gamelan XEQ
1273	Saw1
1274	Saw2
1275	Saw3
1276	Pulse 02%
1277	Pulse 05%
1278	Pulse 08%
1279	Pulse 16%
1280	Pulse 33%
1281	Pulse 40%
1282	Square

#	Multisample
1283	Square MG
1284	Square JP
1285	Triangle MG
1286	Ramp
1287	Ramp MG
1288	Sine
1289	DWGS Syn Sine1
1290	DWGS Syn Sine2
1291	DWGS Organ1
1292	DWGS Organ2
1293	DWGS Bell1
1294	DWGS Bell2
1295	DWGS Bell3
1296	DWGS Bell4
1297	DWGS Clav.
1298	DWGS Digi1
1299	DWGS Digi2
1300	DWGS Wire1
1301	DWGS Wire2
1302	DWGS Sync1
1303	DWGS Sync2
1304	DWGS Sync3
1305	Orchestra Hit 1
1306	Orchestra Hit 2
1307	Orchestra Hit GM L
1308	Orchestra Hit GM R
1309	Band Hit
1310	Impact Hit
1311	Brass Fall
1312	Vibe Chord
1313	Zap1
1314	Zap2
1315	Stadium
1316	Applause

#	Multisample
1317	Birds1
1318	Birds2
1319	Crickets
1320	Church Bell
1321	Thunder
1322	Stream
1323	Bubble
1324	Dog
1325	Gallop
1326	Laughing
1327	Telephone Ring
1328	Scream
1329	Punch
1330	Heart Beat
1331	Footstep 1
1332	Footstep2
1333	Door Creak
1334	Door Slam
1335	Car Engine
1336	Car EngineLP
1337	Car Stop
1338	Car Pass
1339	Car Crash
1340	Train
1341	Helicopter
1342	Gun Shot
1343	Machine Gun
1344	Laser Gun
1345	Explosion
1346	Wind
1347	Chinese Gong
1348	Crash
1349	Crash Reverse
1350	Crash Reverse GM

#	Multisample
1351	Orchestra Crash
1352	Ride Jazz
1353	Ride Edge1
1354	Ride Edge2
1355	HiHat Closed
1356	88 HiHat Open
1357	88 Cowbell
1358	88 Tom
1359	88 Conga
1360	88 Crash
1361	Tom
1362	Tom Brush
1363	Tom Process
1364	Electric Tom
1365	Melodic Tom GM
1366	Flexatone
1367	Tambourine
1368	Agogo Bell
1369	Meditation Tree
1370	Marc Tree
1371	Marc TreeLP
1372	Rain Stick
1373	Cowbell
1374	Castanet
1375	Temple Blocks
1376	Orchestra BD
1377	Timpani
1378	Taiko
1379	Djembe Open
1380	Djembe Mute
1381	Conga
1382	Quinto & Bongo
1383	Okonkolo
1384	Timbales

#	Multisample
1385	Cowbell & Clave
1386	Cabasa
1387	Shaker
1388	Cabasa & Shaker
1389	Dumbek - Djambe - Udu
1390	Caxixi
1391	Tabla & Baya
1392	WoodBlock & Castanet
1393	Mix Latin Percussion
1394	Kangaroo
1395	DJ Eddie Set
1396	Bob Slice A L
1397	Bob Slice A R
1398	Bob Slice B L
1399	Bob Slice B R
1400	Claps Natural Set1 L
1401	Claps Natural Set1 R
1402	Claps Natural Set2 L
1403	Claps Natural Set2 R
1404	Claps Natural Set3 L
1405	Claps Natural Set3 R
1406	Snare Ghost
1407	Stereo Snares1&2 L
1408	Stereo Snares1&2 R
1409	Stereo Snare1 L
1410	Stereo Snare1 R
1411	Stereo Snare2 L
1412	Stereo Snare2 R
1413	BD Thunder Bright L
1414	BD Thunder Bright R
1415	FX SD Large Hall1 L
1416	FX SD Large Hall1 R
1417	FX SD Large Hall2 L
1418	FX SD Large Hall2 R

#	Multisample
1419	FX Rim Large Hall1 L
1420	FX Rim Large Hall1 R
1421	FX Rim Large Hall2 L
1422	FX Rim Large Hall2 R
1423	Click
1424	Metronome W bell
1425	Metronome W
1426	Empty
1427	IT G.Piano V1-L
1428	IT G.Piano V1-R
1429	IT G.Piano V2-L
1430	IT G.Piano V2-R
1431	IT G.Piano V3-L
1432	IT G.Piano V3-R
1433	IT G.Piano V4-L
1434	IT G.Piano V4-R
1435	IT G.Piano V5-L
1436	IT G.Piano V5-R
1437	IT G.Piano V6-L
1438	IT G.Piano V6-R
1439	IT G.Piano Res V1-L
1440	IT G.Piano Res V1-R
1441	IT G.Piano Res V2-L
1442	IT G.Piano Res V2-R
1443	IT G.Piano Res V3-L
1444	IT G.Piano Res V3 -R
1445	IT G.Piano Res V4-L
1446	IT G.Piano Res V4-R
1447	IT G.Piano Res V5-L
1448	IT G.Piano Res V5-R
1449	IT G.Piano Res V6-L

#	Multisample
1450	IT G.Piano Res V6-R
1451	Posaune 32 OT-L
1452	Posaune 32 OT-R
1453	Principal OT-L
1454	Principal OT-R
1455	Cornet OT-L
1456	Cornet OT-R
1457	Coppel Flute OT-L
1458	Coppel Flute OT-R
1459	Harmonic Trumpet OT-L
1460	Harmonic Trumpet OT-R
1461	Viola da Gamba OT-L
1462	Viola da Gamba OT-R
1463	Mixture A OT-L
1464	Mixture A OT-R
1465	Mixture B OT-L
1466	Mixture B OT-R
1467	Pieno OT-L
1468	Pieno OT-R
1469	Recorder Vibrato
1470	Whistle Robin
1471	Tenor Sax J Soft
1472	Tenor Sax J mp
1473	Tenor Sax J mf
1474	Tenor Sax J f
1475	Tenor Sax J Growl
1476	Tenor Sax J R-Up
1477	Tenor Sax J R-Dw
1478	Tenor Sax J Falls
1479	IT Accordion Bass V1 OT
1480	IT Accordion Bass V2 OT

#	Multisample
1481	IT Accordion Bass V3 OT
1482	IT Accordion Bass Key On
1483	IT Accordion 16 V1 OT
1484	IT Accordion 16 V2 OT
1485	IT Accordion 16 V3 OT
1486	IT Accordion 16 V4 OT
1487	IT Accordion 8 V1 OT
1488	IT Accordion 8 V2 OT
1489	IT Accordion 8 V3 OT
1490	IT Accordion 8 V4 OT
1491	IT Accordion 4 V1 OT
1492	IT Accordion 4 V2 OT
1493	IT Accordion 4 V3 OT
1494	IT Accordion 4 V4 OT
1495	IT Accordion Noise Floor
1496	Bandoneon
1497	Bandoneon Stop
1498	Bandoneon Short
1499	Bandoneon Valve
1500	Bandoneon RX
1501	Ac. Guitar T410
1502	Ac. Guitar T410 Muted
1503	Ac. Guitar T410 Harm
1504	Ac. Guitar T410 RX
1505	J8 Analog Brass L
1506	J8 Analog Brass R
1507	Dumpstep Wha
1508	Dumpstep Lp
1509	Dumpstep One Shot

* IT Accordion courtesy by PSound.

Drum Samples

The following table contains all the Factory Drum Samples. DF: Drum Family.

#	Drum Sample	DF
0	BD Spn Sof 1 Room	BD
1	BD Spn Sof 2 Room	BD
2	BD Spn Sof 3 Room	BD
3	BD Spn Sof 4 Room	BD
4	BD Spn Sof 5 Room	BD
5	BD Spn Sof 6 Room	BD
6	BD Spn Sof 7 Room	BD
7	BD Spn Sof 8 Room	BD
8	BD Spn Son 1 Room	BD
9	BD Spn Son 2 Room	BD
10	BD Spn Son 3 Room	BD
11	BD Spn Son 4 Room	BD
12	BD Spn Son 5 Room	BD
13	BD Spn Son 6 Room	BD
14	BD Spn Son 7 Room	BD
15	BD Spn Son 8 Room	BD
16	BD DW Pop 1	BD
17	BD DW Pop 2	BD
18	BD DW Pop 3	BD
19	BD DW Pop 4	BD
20	BD DW Pop 5	BD
21	BD DW Pop 6	BD
22	BD DW Pop 7	BD
23	BD DW Pop 8	BD
24	BD Grt A 1	BD
25	BD Grt A 2	BD
26	BD Grt A 3	BD
27	BD Grt A 4	BD
28	BD Grt A 5	BD
29	BD Grt A 6	BD
30	BD Grt A 7	BD

#	Drum Sample	DF
31	BD Grt B 8	BD
32	BD Grt B 1	BD
33	BD Grt B 2	BD
34	BD Grt B 3	BD
35	BD Grt B 4	BD
36	BD Grt B 5	BD
37	BD Grt B 6	BD
38	BD Grt B 7	BD
39	BD Grt B 8	BD
40	BD Rock 1	BD
41	BD Rock 2	BD
42	BD Rock 3	BD
43	BD Rock 4	BD
44	BD Rock 5	BD
45	BD Rock 6	BD
46	BD Rock 7	BD
47	BD Rock 8	BD
48	BD 1 Studio 1	BD
49	BD 1 Studio 2	BD
50	BD 1 Studio 3	BD
51	BD 1 Studio 4	BD
52	BD 1 Studio 5	BD
53	BD 1 Studio 7	BD
54	BD 1 Studio 8	BD
55	BD 2 Studio 1	BD
56	BD 2 Studio 2	BD
57	BD 2 Studio 3	BD
58	BD 2 Studio 4	BD
59	BD 2 Studio 5	BD
60	BD 2 Studio 6	BD
61	BD 2 Studio 7	BD

#	Drum Sample	DF
62	BD 2 Studio 8	BD
63	BD Chamber 1	BD
64	BD Chamber 2	BD
65	BD Chamber 3	BD
66	BD Chamber 4	BD
67	BD Chamber 5	BD
68	BD Chamber 6	BD
69	BD Live 1	BD
70	BD Live 2	BD
71	BD Live 3	BD
72	BD Live 4	BD
73	BD Live 5	BD
74	BD Live 6	BD
75	BD Funk 1	BD
76	BD Funk 2	BD
77	BD Funk 3	BD
78	BD Funk 4	BD
79	BD Funk 5	BD
80	BD Funk 6	BD
81	BD Plate 1	BD
82	BD Plate 2	BD
83	BD Plate 3	BD
84	BD Plate 4	BD
85	BD 22 Inch Std1	BD
86	BD 22 Inch Std2	BD
87	BD 22 Inch Std3	BD
88	BD 22 Inch Std4	BD
89	BD 22 Inch Std5	BD
90	BD 22 Inch Std6	BD
91	BD 24x14 p	BD
92	BD 24x14 mf	BD

#	Drum Sample	DF
93	BD 24x14 f	BD
94	BD 24x14 f GM	BD
95	BD 24 inch Open p	BD
96	BD 24 inch Open mf	BD
97	BD 24 inch Open f	BD
98	BD 26 inch Open p	BD
99	BD 26 inch Open mf	BD
100	BD 26 inch Open f	BD
101	BD 26 inch Open ff	BD
102	BD 26 inch Open ff GM	BD
103	BD 26 inch Std p	BD
104	BD 26 inch Std mf	BD
105	BD 26 inch Std f	BD
106	BD 26 inch Std ff	BD
107	BD Natural1 p	BD
108	BD Natural1 mf	BD
109	BD Natural1 f	BD
110	BD Natural2 p	BD
111	BD Natural2 mf	BD
112	BD Natural2 f	BD
113	BD Natural2 ff	BD
114	BD Pop1	BD
115	BD Pop2	BD
116	BD Pop3 p	BD
117	BD Pop3 f	BD
118	BD Pop4 p	BD
119	BD Pop4 f	BD
120	BD Pop5	BD
121	BD Acoustic1 p	BD
122	BD Acoustic1 mf	BD
123	BD Acoustic1 f	BD
124	BD Acoustic2 mf	BD
125	BD Acoustic2 mf GM	BD
126	BD Acoustic2 f	BD

#	Drum Sample	DF
127	BD Acoustic2 f GM	BD
128	BD open p	BD
129	BD open mf	BD
130	BD open f	BD
131	BD Peak	BD
132	BD Dry1	BD
133	BD Dry2	BD
134	BD Dry3	BD
135	BD Normal	BD
136	BD SoftRoom	BD
137	BD Pillow	BD
138	BD Woofer	BD
139	BD MondoKill	BD
140	BD Terminator	BD
141	BD Tubby	BD
142	BD Gated	BD
143	BD Tight	BD
144	BD Squash	BD
145	BD Soul1	BD
146	BD Soul2	BD
147	BD Soul3 dist	BD
148	BD Soul4 noise	BD
149	BD Soul5 Long	BD
150	BD Soul6	BD
151	BD Jazz OP1	BD
152	BD Jazz OP2	BD
153	BD Jazz OP3	BD
154	BD Jazz OP4	BD
155	BD Jazz OP5	BD
156	BD Jazz OP6	BD
157	BD Jazz OP7	BD
158	BD Jazz OP8	BD
159	BD Jazz OPW1	BD
160	BD Jazz OPW2	BD

#	Drum Sample	DF
161	BD Jazz OPW3	BD
162	BD Jazz OPW4	BD
163	BD Jazz OPW5	BD
164	BD Jazz OPW6	BD
165	BD Jazz OPW7	BD
166	BD Jazz OPW8	BD
167	BD Jazz Hi 1	BD
168	BD Jazz Hi 2	BD
169	BD Jazz Hi 3	BD
170	BD Jazz Hi 4	BD
171	BD Jazz Hi 5	BD
172	BD Jazz Hi 6	BD
173	BD Jazz Hi 7	BD
174	BD Jazz Hi 8	BD
175	BD Jazz Low 1	BD
176	BD Jazz Low 2	BD
177	BD Jazz Low 3	BD
178	BD Jazz Low 4	BD
179	BD Jazz Low 5	BD
180	BD Jazz Low 6	BD
181	BD Jazz Low 7	BD
182	BD Jazz Low 8	BD
183	BD Jazz open p	BD
184	BD Jazz open f	BD
185	BD Jazz wire open p	BD
186	BD Jazz wire open f	BD
187	BD Jazz	BD
188	BD Jazz GM	BD
189	BD async 1	BD
190	BD async 2	BD
191	BD async 3	BD
192	BD async 4	BD
193	BD Satur 1	BD
194	BD Satur 2	BD

#	Drum Sample	DF
195	BD Satur 3	BD
196	BD Elektro	BD
197	BD HipHop1	BD
198	BD HipHop2	BD
199	BD IDM 1	BD
200	BD IDM 2	BD
201	BD Tribal 1	BD
202	BD Tribal 2	BD
203	BD Thunder bright	BD
204	BD Thunder dark	BD
205	BD Analog	BD
206	BD MS20 A 1	BD
207	BD MS20 A 2	BD
208	BD MS20 A 3	BD
209	BD MS20 A 4	BD
210	BD MS20 A 5	BD
211	BD MS20 A 6	BD
212	BD MS20 B 1	BD
213	BD MS20 B 2	BD
214	BD MS20 B 3	BD
215	BD MS20 C 1	BD
216	BD MS20 C 2	BD
217	BD MS20 C 3	BD
218	BD MS20 D	BD
219	BD MS20 Gliss Down	BD
220	BD ET Down	BD
221	BD ET DubStep 1	BD
222	BD ET DubStep 2	BD
223	BD ET DubStep 3	BD
224	BD ET HipHop 1	BD
225	BD ET HipHop 2	BD
226	BD ET HipHop 3	BD
227	BD ET House A 1	BD
228	BD ET House A 2	BD

#	Drum Sample	DF
229	BD ET House A 3	BD
230	BD ET House B 1	BD
231	BD ET House B 2	BD
232	BD ET House B 3	BD
233	BD ET Gliss Up 1	BD
234	BD ET Gliss Up 2	BD
235	BD ET Gliss Up 3	BD
236	BD ET Minimal A 1	BD
237	BD ET Minimal A 2	BD
238	BD ET Minimal A 3	BD
239	BD ET Minimal B 1	BD
240	BD ET Minimal B 2	BD
241	BD ET Minimal B 3	BD
242	BD Dance1	BD
243	BD Dance2	BD
244	BD Dance3	BD
245	BD House1	BD
246	BD House2	BD
247	BD House3	BD
248	BD House4	BD
249	BD House5	BD
250	BD Liquid	BD
251	BD Techno1	BD
252	BD Techno2	BD
253	BD Hip1	BD
254	BD Hip2	BD
255	BD Hip3	BD
256	BD Hip4	BD
257	BD Kick1	BD
258	BD Kick2	BD
259	BD Electro	BD
260	BD Ambient	BD
261	BD Ambient Crackle	BD
262	BD Ambient Rocker	BD

#	Drum Sample	DF
263	BD Pop	BD
264	BD Deep	BD
265	BD Deep GM	BD
266	BD Klanger	BD
267	BD Electribe01	BD
268	BD Electribe02	BD
269	BD Electribe03	BD
270	BD Electribe04	BD
271	BD Electribe05	BD
272	BD Electribe06	BD
273	BD Electribe07	BD
274	BD Electribe08	BD
275	BD Electribe09	BD
276	BD Electribe10	BD
277	BD Electribe11	BD
278	BD Electribe12	BD
279	BD Electribe13	BD
280	BD Electribe14	BD
281	BD Electribe15	BD
282	BD Electribe16	BD
283	BD Electribe17	BD
284	BD Syn1	BD
285	BD Syn2	BD
286	BD Syn3	BD
287	BD Syn4	BD
288	BD Buzz	BD
289	BD Orchestra Open p	BD
290	BD Orchestra Open f	BD
291	BD Orchestra muted	BD
292	BD Orchestra	BD
293	BD Orchestra GM	BD
294	Timpani	BD
295	SD DW Pop 1	SD
296	SD DW Pop 2	SD

#	Drum Sample	DF
297	SD DW Pop 3	SD
298	SD DW Pop 4	SD
299	SD DW Pop 5	SD
300	SD DW Pop 6	SD
301	SD DW Pop 7	SD
302	SD DW Pop 8	SD
303	SD Brady 1	SD
304	SD Brady 2	SD
305	SD Brady 3	SD
306	SD Brady 4	SD
307	SD Brady 5	SD
308	SD Brady 6	SD
309	SD Brady 7	SD
310	SD Brady 8	SD
311	SD Ldw A 1	SD
312	SD Ldw A 2	SD
313	SD Ldw A 3	SD
314	SD Ldw A 4	SD
315	SD Ldw A 5	SD
316	SD Ldw A 6	SD
317	SD Ldw A 7	SD
318	SD Ldw A 8	SD
319	SD Ldw B 1	SD
320	SD Ldw B 2	SD
321	SD Ldw B 3	SD
322	SD Ldw B 4	SD
323	SD Ldw B 5	SD
324	SD Ldw B 6	SD
325	SD Ldw B 7	SD
326	SD Ldw B 8	SD
327	SD Alc A 1	SD
328	SD Alc A 2	SD
329	SD Alc A 3	SD
330	SD Alc A 4	SD

#	Drum Sample	DF
331	SD Alc A 5	SD
332	SD Alc A 6	SD
333	SD Alc A 7	SD
334	SD Alc A 8	SD
335	SD Alc B 1	SD
336	SD Alc B 2	SD
337	SD Alc B 3	SD
338	SD Alc B 4	SD
339	SD Alc B 5	SD
340	SD Alc B 6	SD
341	SD Alc B 7	SD
342	SD Alc B 8	SD
343	SD Rock A 1	SD
344	SD Rock A 2	SD
345	SD Rock A 3	SD
346	SD Rock A 4	SD
347	SD Rock A 5	SD
348	SD Rock A 6	SD
349	SD Rock A 7	SD
350	SD Rock A 8	SD
351	SD Rock B 1	SD
352	SD Rock B 2	SD
353	SD Rock B 3	SD
354	SD Rock B 4	SD
355	SD Rock B 5	SD
356	SD Rock B 6	SD
357	SD Rock B 7	SD
358	SD Rock B 8	SD
359	SD D1 1	SD
360	SD D1 2	SD
361	SD D1 3	SD
362	SD D1 4	SD
363	SD D1 5	SD
364	SD D1 6	SD

#	Drum Sample	DF
365	SD D2 1	SD
366	SD D2 2	SD
367	SD D2 3	SD
368	SD D2 4	SD
369	SD D2 5	SD
370	SD D2 6	SD
371	SD P1 1	SD
372	SD P1 2	SD
373	SD P1 3	SD
374	SD P1 4	SD
375	SD P1 5	SD
376	SD P1 6	SD
377	SD P2 1	SD
378	SD P2 2	SD
379	SD P2 3	SD
380	SD P2 4	SD
381	SD P2 5	SD
382	SD P2 6	SD
383	SD S1 1	SD
384	SD S1 2	SD
385	SD S1 3	SD
386	SD S1 4	SD
387	SD S1 5	SD
388	SD S1 6	SD
389	SD S2 1	SD
390	SD S2 2	SD
391	SD S2 3	SD
392	SD S2 4	SD
393	SD S2 5	SD
394	SD S2 6	SD
395	SD Y1 1	SD
396	SD Y1 2	SD
397	SD Y1 3	SD
398	SD Y1 4	SD

#	Drum Sample	DF
399	SD Y1 5	SD
400	SD Y1 6	SD
401	SD Y2 1	SD
402	SD Y2 2	SD
403	SD Y2 3	SD
404	SD Y2 4	SD
405	SD Y2 5	SD
406	SD Y2 6	SD
407	SD Plate 1	SD
408	SD Plate 2	SD
409	SD Plate Ghost	SD
410	SD Plate Rim	SD
411	SD 1 Studio 1	SD
412	SD 1 Studio 2	SD
413	SD 1 Studio 3	SD
414	SD 1 Studio 4	SD
415	SD 1 Studio 5	SD
416	SD 1 Studio 6	SD
417	SD 1 Studio 7	SD
418	SD 1 Studio 8	SD
419	SD 2 Studio 1	SD
420	SD 2 Studio 2	SD
421	SD 2 Studio 3	SD
422	SD 2 Studio 4	SD
423	SD 2 Studio 5	SD
424	SD 2 Studio 6	SD
425	SD 2 Studio 7	SD
426	SD 2 Studio 8	SD
427	SD Crv p	SD
428	SD Crv mf	SD
429	SD Crv f	SD
430	SD Crv+Rim p	SD
431	SD Crv+Rim mf	SD
432	SD Crv+Rim f	SD

#	Drum Sample	DF
433	SD CrvOpen pp	SD
434	SD CrvOpen p	SD
435	SD CrvOpen mf	SD
436	SD CrvOpen f	SD
437	SD CrvOpRim pp	SD
438	SD CrvOpRim p	SD
439	SD CrvOpRim mf	SD
440	SD CrvOpRim f	SD
441	SD Crv Roll p	SD
442	SD Crv Roll mf	SD
443	SD Crv Roll f	SD
444	SD Crv Stage p	SD
445	SD Crv Stage mf	SD
446	SD Crv Stage f	SD
447	SD Crv+Rim Stage p	SD
448	SD Crv+Rim Stage mf	SD
449	SD Crv+Rim Stage f	SD
450	SD Crv Open Stage pp	SD
451	SD Crv Open Stage p	SD
452	SD Crv Open Stage mf	SD
453	SD Crv Open Stage f	SD
454	SD Crv OpRim Stage pp	SD
455	SD Crv OpRim Stage p	SD
456	SD Crv OpRim Stage mf	SD
457	SD Crv OpRim Stage f	SD
458	SD Crv Gate1 p	SD
459	SD Crv Gate1 mf	SD
460	SD Crv Gate1 f	SD
461	SD Crv+Rim Gate1 p	SD
462	SD Crv+Rim Gate1 mf	SD
463	SD Crv+Rim Gate1 f	SD
464	SD Crv OpRim Gate1 pp	SD
465	SD Crv OpRim Gate1 p	SD
466	SD Crv OpRim Gate1 mf	SD

#	Drum Sample	DF
467	SD Crv OpRim Gate1 f	SD
468	SD Crv Roll Gate1 p	SD
469	SD Crv Roll Gate1 mf	SD
470	SD Crv Roll Gate1 f	SD
471	SD Crv Gate2 p	SD
472	SD Crv Gate2 mf	SD
473	SD Crv Gate2 f	SD
474	SD Crv+Rim Gate2 p	SD
475	SD Crv+Rim Gate2 mf	SD
476	SD Crv+Rim Gate2 f	SD
477	SD Crv Roll Gate2 p	SD
478	SD Crv Roll Gate2 mf	SD
479	SD Crv Roll Gate2 f	SD
480	SD Crv+Rim Plate p	SD
481	SD Crv+Rim Plate mf	SD
482	SD Crv+Rim Plate f	SD
483	SD Crv Open Plate pp	SD
484	SD Crv Open Plate p	SD
485	SD Crv Open Plate mf	SD
486	SD Crv Open Plate f	SD
487	SD Crv OpRim Plate pp	SD
488	SD Crv OpRim Plate p	SD
489	SD Crv OpRim Plate mf	SD
490	SD Crv OpRim Plate f	SD
491	SD Crv Open Room pp	SD
492	SD Crv Open Room p	SD
493	SD Crv Open Room mf	SD
494	SD Crv Open Room f	SD
495	SD Crv OpRim Room pp	SD
496	SD Crv OpRim Room p	SD
497	SD Crv OpRim Room mf	SD
498	SD Crv OpRim Room f	SD
499	SD LdwBB1A C11	SD
500	SD LdwBB1A C12	SD

#	Drum Sample	DF
501	SD LdwBB1A C13	SD
502	SD LdwBB1A C14	SD
503	SD LdwBB1A OpRim1	SD
504	SD LdwBB1A OpRim2	SD
505	SD LdwBB1A OpRim3	SD
506	SD LdwBB1A OpRim4	SD
507	SD LdwBB1A Roll1	SD
508	SD LdwBB1A Roll2	SD
509	SD LdwBB1A Roll3	SD
510	SD LdwBB1B Op1	SD
511	SD LdwBB1B Op2	SD
512	SD LdwBB1B Op3	SD
513	SD LdwBB1B Op4	SD
514	SD LdwBB1B OpRim1	SD
515	SD LdwBB1B OpRim2	SD
516	SD LdwBB1B OpRim3	SD
517	SD LdwBB1B OpRim4	SD
518	SD LdwBB2 OpRim1	SD
519	SD LdwBB2 OpRim2	SD
520	SD LdwBB2 Std1	SD
521	SD LdwBB2 Std2	SD
522	SD LdwBB2 Std3	SD
523	SD LdwBB2 Roll1	SD
524	SD LdwBB2 Roll2	SD
525	SD LdwBB2 Roll3	SD
526	SD LdwBB2 Roll4	SD
527	SD LdwSup Std p	SD
528	SD LdwSup Std mf	SD
529	SD LdwSup Std f	SD
530	SD LdwSup Std+Rim p	SD
531	SD LdwSup Std+Rim mf	SD
532	SD LdwSup Std+Rim f	SD
533	SD LdwSup Std Gate p	SD
534	SD LdwSup Std Gate mf	SD

#	Drum Sample	DF
535	SD LdwSup Std Gate f	SD
536	SD LdwSup S+R Gate p	SD
537	SD LdwSup S+R Gate mf	SD
538	SD LdwSup S+R Gate f	SD
539	SD LdwSup Std Room p	SD
540	SD LdwSup Std Room mf	SD
541	SD LdwSup Std Room f	SD
542	SD LdwSup S+R Room p	SD
543	SD LdwSup S+R Room mf	SD
544	SD LdwSup S+R Room f	SD
545	SD LdwVintage Std p	SD
546	SD LdwVintage Std mf	SD
547	SD LdwVintage Std f	SD
548	SD LdwVintage Std ff	SD
549	SD LdwVintage S+Rim p	SD
550	SD LdwVintage S+Rim mf	SD
551	SD LdwVintage S+Rim f	SD
552	SD Ldw Roll p	SD
553	SD Ldw Roll mf	SD
554	SD Ldw Roll f	SD
555	SD LdwVint Room p	SD
556	SD LdwVint Room mf	SD
557	SD LdwVint Room f	SD
558	SD LdwVint Room ff	SD
559	SD LdwVint room S+R p	SD
560	SD LdwVint room S+R mf	SD
561	SD LdwVint room S+R f	SD
562	SD Ldw Roll room p	SD
563	SD Ldw Roll room mf	SD
564	SD Ldw Roll room f	SD
565	SD Spr Std p	SD
566	SD Spr Std mf	SD
567	SD Spr Std f	SD
568	SD Spr StdRim p	SD

#	Drum Sample	DF
569	SD Spr StdRim mf	SD
570	SD Spr StdRim f	SD
571	SD Spr Open p	SD
572	SD Spr Open mf	SD
573	SD Spr Open f	SD
574	SD Spr Open ff	SD
575	SD Spr OpRim p	SD
576	SD Spr OpRim mf	SD
577	SD Spr OpRim f	SD
578	SD Spr OpRim ff	SD
579	SD Spr Roll p	SD
580	SD Spr Roll mf	SD
581	SD P.E. Std p	SD
582	SD P.E. Std mf	SD
583	SD P.E. Std f	SD
584	SD P.E. Std+Rim p	SD
585	SD P.E. Std+Rim mf	SD
586	SD P.E. Std+Rim f	SD
587	SD P.E. Open p	SD
588	SD P.E. Open mf	SD
589	SD P.E. Open f	SD
590	SD P.E. OpRim mf	SD
591	SD P.E. OpRim f	SD
592	SD P.E. Roll mf	SD
593	SD P.E. Roll f	SD
594	SD Natural p	SD
595	SD Natural mf	SD
596	SD Natural f	SD
597	SD Natural Rim p	SD
598	SD Natural Rim mf	SD
599	SD Natural Rim f	SD
600	SD Dry center1	SD
601	SD Dry center2	SD
602	SD Dry center3	SD

#	Drum Sample	DF
603	SD Dry Rim1	SD
604	SD Dry Rim2	SD
605	SD Dry Rim3	SD
606	SD Dry Roll	SD
607	SD Pop1 p	SD
608	SD Pop1 p GM	SD
609	SD Pop1 mf	SD
610	SD Pop1 mf GM	SD
611	SD Pop1 f	SD
612	SD Pop1 f GM	SD
613	SD Pop1 +Rim mf	SD
614	SD Pop1 +Rim mf GM	SD
615	SD Pop1 +Rim f	SD
616	SD Pop1 +Rim f GM	SD
617	SD Pop2 p	SD
618	SD Pop2 mf	SD
619	SD Pop2 f	SD
620	SD Pop2 ff	SD
621	SD Flam	SD
622	SD Black	SD
623	SD S Gate1	SD
624	SD S Gate1 GM	SD
625	SD S Gate2	SD
626	SD S Gate3	SD
627	SD Wood1 p	SD
628	SD Wood1 mf	SD
629	SD Wood1 f	SD
630	SD Wood2 pp	SD
631	SD Wood2 p	SD
632	SD Wood2 mf	SD
633	SD Wood2 f	SD
634	SD Piccolo1 pp	SD
635	SD Piccolo1 p	SD
636	SD Piccolo1 mf	SD

#	Drum Sample	DF
637	SD Piccolo1 f	SD
638	SD Piccolo2 pp	SD
639	SD Piccolo2 p	SD
640	SD Piccolo2 mf	SD
641	SD Piccolo2 f	SD
642	SD Solid1 p	SD
643	SD Solid1 mf	SD
644	SD Solid1 f	SD
645	SD Solid2 p	SD
646	SD Solid2 mf	SD
647	SD Solid2 f	SD
648	SD Maple1 pp	SD
649	SD Maple1 p	SD
650	SD Maple1 mp	SD
651	SD Maple1 mf	SD
652	SD Maple1 f	SD
653	SD Maple1 ff	SD
654	SD Maple2 pp	SD
655	SD Maple2 p	SD
656	SD Maple2 mp	SD
657	SD Maple2 mf	SD
658	SD Maple2 f	SD
659	SD Maple2 ff	SD
660	SD Brass1 p	SD
661	SD Brass1 mf	SD
662	SD Brass1 f	SD
663	SD Brass2 p	SD
664	SD Brass2 mf	SD
665	SD Brass2 f	SD
666	SD Roll	SD
667	SD Ghost Roll	SD
668	SD Ghost p	SD
669	SD Ghost f	SD
670	SD Snr Ghost1 a	SD

#	Drum Sample	DF
671	SD Snr Ghost1 b	SD
672	SD Snr Ghost2 a	SD
673	SD Snr Ghost2 b	SD
674	SD Snr Ghost2 c	SD
675	SD Snr Signature p	SD
676	SD Snr Signature mf	SD
677	SD Snr Signature f	SD
678	SD Snr Signature Rim mf	SD
679	SD Snr Signature Rim f	SD
680	SD Snr Signature Rim1	SD
681	SD Snr Signature Rim2	SD
682	SD Dry1	SD
683	SD Dry2	SD
684	SD Dry3	SD
685	SD Full Room	SD
686	SD Off Center	SD
687	SD Jazz Ring	SD
688	SD J center p	SD
689	SD J center f	SD
690	SD J edge1	SD
691	SD J edge2	SD
692	SD J edge3	SD
693	SD J edge4	SD
694	SD J std p	SD
695	SD J std mf	SD
696	SD J std f	SD
697	SD J std+rim p	SD
698	SD J std+rim mf	SD
699	SD J std+rim f	SD
700	SD Amb.Piccolo	SD
701	SD Paper	SD
702	SD Big Rock	SD
703	SD Yowie	SD
704	SD Trinity1	SD

#	Drum Sample	DF
705	SD Trinity2	SD
706	SD Stereo Gate	SD
707	SD Stereo Gate GM	SD
708	SD Processed	SD
709	SD Processed GM	SD
710	SD Processed + AMB	SD
711	SD Cracker Room	SD
712	SD El. Funk1	SD
713	SD El. Funk2	SD
714	SD El. Funk3	SD
715	SD Dance01	SD
716	SD Dance02	SD
717	SD Dance03	SD
718	SD Dance04	SD
719	SD Dance05	SD
720	SD Dance06	SD
721	SD Dance07	SD
722	SD Dance08	SD
723	SD Dance09	SD
724	SD Dance10	SD
725	SD Dance11	SD
726	SD Dance12	SD
727	SD Dance13	SD
728	SD Dance14	SD
729	SD Dance15	SD
730	SD Dance16	SD
731	SD Dance17	SD
732	SD Dance18	SD
733	SD Dance19	SD
734	SD Dance20	SD
735	SD Dance21	SD
736	SD Dance22	SD
737	SD Dance23	SD
738	SD Dance23 GM	SD

#	Drum Sample	DF
739	SD Dance24	SD
740	SD House1	SD
741	SD House2	SD
742	SD House3	SD
743	SD House4	SD
744	SD BeatBox	SD
745	SD Small	SD
746	SD Rap	SD
747	SD Noise	SD
748	SD Reverse	SD
749	SD Hip1	SD
750	SD Hip2	SD
751	SD Hip3	SD
752	SD Hip4	SD
753	SD Hip5	SD
754	SD Hip6	SD
755	SD Ringy	SD
756	SD Tiny	SD
757	SD Vintage1	SD
758	SD Vintage2	SD
759	SD Vintage3	SD
760	SD Vintage4	SD
761	SD Vintage5	SD
762	SD Vintage6	SD
763	SD AmbiHop	SD
764	SD Brassier	SD
765	SD Chili	SD
766	SD Whopper	SD
767	SD Syn.1	SD
768	SD Syn.2	SD
769	SD Syn.3	SD
770	SD Syn.4	SD
771	SD Electro	SD
772	SD ET DubStep1_0	SD

#	Drum Sample	DF
773	SD ET DubStep1_1	SD
774	SD ET DubStep1_2	SD
775	SD Orchestra	SD
776	SD Orch. Roll	SD
777	SD Brush C1	SD
778	SD Brush C2	SD
779	SD Brush C3	SD
780	SD Brush C4	SD
781	SD Brush C5	SD
782	SD Brush C6	SD
783	SD Brush Mute1	SD
784	SD Brush Mute2	SD
785	SD Brush Mute3	SD
786	SD Brush Mute4	SD
787	SD Brush Mute5	SD
788	SD Brush Mute6	SD
789	SD Brush S1 1	SD
790	SD Brush S1 2	SD
791	SD Brush S1 3	SD
792	SD Brush S1 4	SD
793	SD Brush S1 5	SD
794	SD Brush S1 6	SD
795	SD Brush S2 1	SD
796	SD Brush S2 2	SD
797	SD Brush S2 3	SD
798	SD Brush S2 4	SD
799	SD Brush S2 5	SD
800	SD Brush S2 6	SD
801	SD Swirl A1	SD
802	SD Swirl A2	SD
803	SD Swirl A3	SD
804	SD Swirl A4	SD
805	SD Swirl B1	SD
806	SD Swirl B2	SD

#	Drum Sample	DF
807	SD Swirl B3	SD
808	SD Swirl B4	SD
809	SD Swirl C1	SD
810	SD Swirl C2	SD
811	SD Swirl C3	SD
812	SD Swirl C4	SD
813	SD Swirl L1	SD
814	SD Swirl L2	SD
815	SD Swirl L3	SD
816	SD Swirl M1	SD
817	SD Swirl M2	SD
818	SD Swirl M3	SD
819	SD Swirl S1	SD
820	SD Swirl S2	SD
821	SD Swirl S3	SD
822	SDTap&Swirl L1	SD
823	SDTap&Swirl L2	SD
824	SDTap&Swirl L3	SD
825	SDTap&Swirl L4	SD
826	SDTap&Swirl L5	SD
827	SDTap&Swirl L6	SD
828	SDTap&Swirl S1	SD
829	SDTap&Swirl S2	SD
830	SDTap&Swirl S3	SD
831	SDTap&Swirl S4	SD
832	SDTap&Swirl S5	SD
833	SDTap&Swirl S6	SD
834	SD Brush Swirl End	SD
835	SD Brush Swirl End Up	SD
836	SD Swirl GM	SD
837	SD JBrush Loop1	SD
838	SD JBrush loop2	SD
839	SD JBrush mid	SD
840	SD JBrush open p	SD

#	Drum Sample	DF
841	SD JBrush open mf	SD
842	SD JBrush open f	SD
843	SD JBrush short	SD
844	SD JBrush shot p	SD
845	SD BrushHit1	SD
846	SD BrushHit2	SD
847	SD JazzBrush1	SD
848	SD JazzBrush2	SD
849	SD Brush1 (swirl1)	SD
850	SD Brush1 (swirl2)	SD
851	SD Brush1 (swirl3)	SD
852	SD Brush1 (swirl4)	SD
853	SD Brush1	SD
854	SD Brush2 (ghost1)	SD
855	SD Brush2 (ghost2)	SD
856	SD Brush2 (ghost3)	SD
857	SD Brush2	SD
858	SD Brush2 (fill) 4 shots	SD
859	SD Brush2 (fill) 3 shots	SD
860	SD Brush2 (fill) 2 shots	SD
861	SD Brush3 Hit	SD
862	SD Brush3 Tap1	SD
863	SD Brush3 Tap2	SD
864	SD Brush3 Swirl	SD
865	SD FX Large Hall1	SD
866	SD FX Large Hall2	SD
867	Rim Pop 1	SD
868	Rim Pop 2	SD
869	Rim Pop 3	SD
870	Rim Pop 4	SD
871	Rim Pop 5	SD
872	Rim Pop 6	SD
873	Rim Pop 7	SD
874	Rim Pop 8	SD

#	Drum Sample	DF
875	Rim1 m Room	SD
876	Rim2 m Room	SD
877	Rim3 m Room	SD
878	Rim4 m Room	SD
879	Rim1 st Room	SD
880	Rim2 st Room	SD
881	Rim3 st Room	SD
882	Rim4 st Room	SD
883	Rim1 m rev 80's	SD
884	Rim2 m rev 80's	SD
885	Rim3 m rev 80's	SD
886	Rim4 m rev 80's	SD
887	Rim1 st rev 80's	SD
888	Rim2 st rev 80's	SD
889	Rim3 st rev 80's	SD
890	Rim4 st rev 80's	SD
891	Rim1 m Gate 1	SD
892	Rim2 m Gate 1	SD
893	Rim3 m Gate 1	SD
894	Rim4 m Gate 1	SD
895	Rim1 st Gate 1	SD
896	Rim2 st Gate 1	SD
897	Rim3 st Gate 1	SD
898	Rim4 st Gate 1	SD
899	Rim1 m Gate 2	SD
900	Rim2 m Gate 2	SD
901	Rim3 m Gate 2	SD
902	Rim4 m Gate 2	SD
903	Rim1 st Gate 2	SD
904	Rim2 st Gate 2	SD
905	Rim3 st Gate 2	SD
906	Rim4 st Gate 2	SD
907	Rim1 m Hall	SD
908	Rim2 m Hall	SD

#	Drum Sample	DF
909	Rim3 m Hall	SD
910	Rim4 m Hall	SD
911	Rim1 st Hall	SD
912	Rim2 st Hall	SD
913	Rim3 st Hall	SD
914	Rim4 st Hall	SD
915	Rim1 Amb	SD
916	Rim2 Amb	SD
917	Rim3 Amb	SD
918	Rim4 Amb	SD
919	Rim Signature Hi	SD
920	Rim Signature Mid	SD
921	Rim Signature Low	SD
922	Rim Shot p	SD
923	Rim Shot f	SD
924	Rim House1	SD
925	Rim House2	SD
926	Rim Synth	SD
927	Rim Synth Click	SD
928	Rim Synth Tamb	SD
929	Rim Analog	SD
930	Rim FX Large Hall1	SD
931	Rim FX Large Hall2	SD
932	Sidestick mf	SD
933	Sidestick f	SD
934	Sidestick Dance	SD
935	SideStick Dry	SD
936	SideStick Amb	SD
937	DrumStick Hit	SD
938	DrumStick Hit GM	SD
939	DrumStick Hit Amb	SD
940	Tom Pop Hi 1	Tm
941	Tom Pop Hi 2	Tm
942	Tom Pop Hi 3	Tm

#	Drum Sample	DF
943	Tom Pop Hi 4	Tm
944	Tom Pop Hi 5	Tm
945	Tom Pop Hi 6	Tm
946	Tom Pop Hi 7	Tm
947	Tom Pop Hi 8	Tm
948	Tom Pop Hi Mid 1	Tm
949	Tom Pop Hi Mid 2	Tm
950	Tom Pop Hi Mid 3	Tm
951	Tom Pop Hi Mid 4	Tm
952	Tom Pop Hi Mid 5	Tm
953	Tom Pop Hi Mid 6	Tm
954	Tom Pop Hi Mid 7	Tm
955	Tom Pop Hi Mid 8	Tm
956	Tom Pop Low Mid 1	Tm
957	Tom Pop Low Mid 2	Tm
958	Tom Pop Low Mid 3	Tm
959	Tom Pop Low Mid 4	Tm
960	Tom Pop Low Mid 5	Tm
961	Tom Pop Low Mid 6	Tm
962	Tom Pop Low Mid 7	Tm
963	Tom Pop Low Mid 8	Tm
964	Tom Pop Low 1	Tm
965	Tom Pop Low 2	Tm
966	Tom Pop Low 3	Tm
967	Tom Pop Low 4	Tm
968	Tom Pop Low 5	Tm
969	Tom Pop Low 6	Tm
970	Tom Pop Low 7	Tm
971	Tom Pop Low 8	Tm
972	Tom Pop Floor Hi 1	Tm
973	Tom Pop Floor Hi 2	Tm
974	Tom Pop Floor Hi 3	Tm
975	Tom Pop Floor Hi 4	Tm
976	Tom Pop Floor Hi 5	Tm

#	Drum Sample	DF
977	Tom Pop Floor Hi 6	Tm
978	Tom Pop Floor Hi 7	Tm
979	Tom Pop Floor Hi 8	Tm
980	Tom Pop Floor Low 1	Tm
981	Tom Pop Floor Low 2	Tm
982	Tom Pop Floor Low 3	Tm
983	Tom Pop Floor Low 4	Tm
984	Tom Pop Floor Low 5	Tm
985	Tom Pop Floor Low 6	Tm
986	Tom Pop Floor Low 7	Tm
987	Tom Pop Floor Low 8	Tm
988	Tom Rock Hi 1	Tm
989	Tom Rock Hi 2	Tm
990	Tom Rock Hi 3	Tm
991	Tom Rock Hi 4	Tm
992	Tom Rock Hi 5	Tm
993	Tom Rock Hi 6	Tm
994	Tom Rock Hi 7	Tm
995	Tom Rock Hi 8	Tm
996	Tom Rock Hi Mid 1	Tm
997	Tom Rock Hi Mid 2	Tm
998	Tom Rock Hi Mid 3	Tm
999	Tom Rock Hi Mid 4	Tm
1000	Tom Rock Hi Mid 5	Tm
1001	Tom Rock Hi Mid 6	Tm
1002	Tom Rock Hi Mid 7	Tm
1003	Tom Rock Hi Mid 8	Tm
1004	Tom Rock Low Mid 1	Tm
1005	Tom Rock Low Mid 2	Tm
1006	Tom Rock Low Mid 3	Tm
1007	Tom Rock Low Mid 4	Tm
1008	Tom Rock Low Mid 5	Tm
1009	Tom Rock Low Mid 6	Tm
1010	Tom Rock Low Mid 7	Tm

#	Drum Sample	DF
1011	Tom Rock Low Mid 8	Tm
1012	Tom Rock Low 1	Tm
1013	Tom Rock Low 2	Tm
1014	Tom Rock Low 3	Tm
1015	Tom Rock Low 4	Tm
1016	Tom Rock Low 5	Tm
1017	Tom Rock Low 6	Tm
1018	Tom Rock Low 7	Tm
1019	Tom Rock Low 8	Tm
1020	Tom Rock Floor Hi 1	Tm
1021	Tom Rock Floor Hi 2	Tm
1022	Tom Rock Floor Hi 3	Tm
1023	Tom Rock Floor Hi 4	Tm
1024	Tom Rock Floor Hi 5	Tm
1025	Tom Rock Floor Hi 6	Tm
1026	Tom Rock Floor Hi 7	Tm
1027	Tom Rock Floor Hi 8	Tm
1028	Tom Rock Floor Low 1	Tm
1029	Tom Rock Floor Low 2	Tm
1030	Tom Rock Floor Low 3	Tm
1031	Tom Rock Floor Low 4	Tm
1032	Tom Rock Floor Low 5	Tm
1033	Tom Rock Floor Low 6	Tm
1034	Tom Rock Floor Low 7	Tm
1035	Tom Rock Floor Low 8	Tm
1036	Tom D Hi p	Tm
1037	Tom D Hi mf	Tm
1038	Tom D Hi f	Tm
1039	Tom D Mid p	Tm
1040	Tom D Mid mf	Tm
1041	Tom D Mid f	Tm
1042	Tom D Low p	Tm
1043	Tom D Low mf	Tm
1044	Tom D Low f	Tm

#	Drum Sample	DF
1045	Tom D Floor p	Tm
1046	Tom D Floor mf	Tm
1047	Tom D Floor f	Tm
1048	Tom P Hi	Tm
1049	Tom P Mid	Tm
1050	Tom P Low	Tm
1051	Tom P Floor	Tm
1052	Tom R Vintage Hi	Tm
1053	Tom R Vintage Mid	Tm
1054	Tom R Vintage Floor	Tm
1055	Tom Vintage Room Hi	Tm
1056	Tom Vintage Room Mid	Tm
1057	Tom Vintage Room Low	Tm
1058	Tom1 Open Hi p	Tm
1059	Tom1 Open Hi p flam	Tm
1060	Tom1 Open Hi f	Tm
1061	Tom1 Open Hi f flam	Tm
1062	Tom1 Open Mid p	Tm
1063	Tom1 Open Mid p flam	Tm
1064	Tom1 Open Mid f	Tm
1065	Tom1 Open Mid f flam	Tm
1066	Tom1 Open Low p	Tm
1067	Tom1 Open Low p flam	Tm
1068	Tom1 Open Low f	Tm
1069	Tom1 Open Low f flam	Tm
1070	Tom1 Open Floor p	Tm
1071	Tom1 Open Floor p flam	Tm
1072	Tom1 Open Floor f	Tm
1073	Tom1 Open Floor f flam	Tm
1074	Tom2 Hi p	Tm
1075	Tom2 Hi f	Tm
1076	Tom2 Mid p	Tm
1077	Tom2 Mid f	Tm
1078	Tom2 Low p	Tm

#	Drum Sample	DF
1079	Tom2 Low f	Tm
1080	Tom2 Floor p	Tm
1081	Tom2 Floor f	Tm
1082	Tom3 Hi	Tm
1083	Tom3 Floor	Tm
1084	Tom4 Hi	Tm
1085	Tom4 Low	Tm
1086	Tom4 Floor	Tm
1087	Tom5 Hi	Tm
1088	Tom5 Low	Tm
1089	Tom6 Vintage Hi p	Tm
1090	Tom6 Vintage Hi mf	Tm
1091	Tom6 Vintage Hi f	Tm
1092	Tom6 Vintage Mid p	Tm
1093	Tom6 Vintage Mid mf	Tm
1094	Tom6 Vintage Mid f	Tm
1095	Tom6 Vintage Low p	Tm
1096	Tom6 Vintage Low mf	Tm
1097	Tom6 Vintage Low f	Tm
1098	Tom Jazz HW Hi 1	Tm
1099	Tom Jazz HW Hi 2	Tm
1100	Tom Jazz HW Hi 3	Tm
1101	Tom Jazz HW Hi 4	Tm
1102	Tom Jazz HW Hi 5	Tm
1103	Tom Jazz HW Low 1	Tm
1104	Tom Jazz HW Low 2	Tm
1105	Tom Jazz HW Low 3	Tm
1106	Tom Jazz HW Low 4	Tm
1107	Tom Jazz HW Low 5	Tm
1108	Tom Jazz HW Low 6	Tm
1109	Tom Jazz HW Low 7	Tm
1110	Tom Jazz HW Low 8	Tm
1111	Tom Jazz HW Floor 1	Tm
1112	Tom Jazz HW Floor 2	Tm

#	Drum Sample	DF
1113	Tom Jazz HW Floor 3	Tm
1114	Tom Jazz HW Floor 4	Tm
1115	Tom Jazz HW Floor 5	Tm
1116	Tom Jazz HW Floor 6	Tm
1117	Tom Jazz HW Floor 7	Tm
1118	Tom Jazz HW Floor 8	Tm
1119	Tom Jazz Hi center	Tm
1120	Tom Jazz Hi center GM	Tm
1121	Tom Jazz Hi edge	Tm
1122	Tom Jazz Hi rim	Tm
1123	Tom Jazz Low center	Tm
1124	Tom Jazz Low center GM	Tm
1125	Tom Jazz Low edge	Tm
1126	Tom Jazz Low rim	Tm
1127	Tom Jazz Hi	Tm
1128	Tom Jazz Floor	Tm
1129	Tom Brush Mt Hi 1	Tm
1130	Tom Brush Mt Hi 2	Tm
1131	Tom Brush Mt Hi 3	Tm
1132	Tom Brush Mt Hi 4	Tm
1133	Tom Brush Mt Hi 5	Tm
1134	Tom Brush Mt Hi 6	Tm
1135	Tom Brush Op Hi 1	Tm
1136	Tom Brush Op Hi 2	Tm
1137	Tom Brush Op Hi 3	Tm
1138	Tom Brush Op Hi 4	Tm
1139	Tom Brush Op Hi 5	Tm
1140	Tom Brush Op Hi 6	Tm
1141	Tom Brush Mt Low 1	Tm
1142	Tom Brush Mt Low 2	Tm
1143	Tom Brush Mt Low 3	Tm
1144	Tom Brush Mt Low 4	Tm
1145	Tom Brush Mt Low 5	Tm
1146	Tom Brush Mt Low 6	Tm

#	Drum Sample	DF
1147	Tom Brush Op Low 1	Tm
1148	Tom Brush Op Low 2	Tm
1149	Tom Brush Op Low 3	Tm
1150	Tom Brush Op Low 4	Tm
1151	Tom Brush Op Low 5	Tm
1152	Tom Brush Op Low 6	Tm
1153	Tom Brush1 (sd open)	Tm
1154	Tom Brush1 (sd close)	Tm
1155	Tom Brush2 (sd open)	Tm
1156	Tom Brush2 (sd close)	Tm
1157	Tom Brush3 Hi mf	Tm
1158	Tom Brush3 Hi f	Tm
1159	Tom Brush3 Hi f GM	Tm
1160	Tom Brush3 Mid mf	Tm
1161	Tom Brush3 Mid f	Tm
1162	Tom Brush3 Mid f GM	Tm
1163	Tom Brush3 Low mf	Tm
1164	Tom Brush3 Low f	Tm
1165	Tom Brush3 Low f GM	Tm
1166	Tom Brush4	Tm
1167	Tom Brush5 Amb Hi	Tm
1168	Tom Brush5 Amb Low	Tm
1169	Tom Processed	Tm
1170	E.Tom FM	Tm
1171	E.Tom Real	Tm
1172	HH Pop Z Cl 1	HH
1173	HH Pop Z Cl 2	HH
1174	HH Pop Z Cl 3	HH
1175	HH Pop Z Cl 4	HH
1176	HH Pop Z Cl 5	HH
1177	HH Pop Z Cl 6	HH
1178	HH Pop Z Cl 7	HH
1179	HH Pop Z Cl 8	HH
1180	HH Pop Z Op 1	HH

#	Drum Sample	DF
1181	HH Pop Z Op 2	HH
1182	HH Pop Z Op 3	HH
1183	HH Pop Z Op 4	HH
1184	HH Pop Z Op 5	HH
1185	HH Pop Z Op 6	HH
1186	HH Pop Z Op 7	HH
1187	HH Pop Z Op 8	HH
1188	HH Pop Z Ped 1	HH
1189	HH Pop Z Ped 2	HH
1190	HH Pop Z Ped 3	HH
1191	HH Pop Z Ped 4	HH
1192	HH Pop Z Ped 5	HH
1193	HH Pop Z Ped 6	HH
1194	HH Pop Z Ped 7	HH
1195	HH Pop Z Ped 8	HH
1196	HH Rock Cl 1	HH
1197	HH Rock Cl 2	HH
1198	HH Rock Cl 3	HH
1199	HH Rock Cl 4	HH
1200	HH Rock Cl 5	HH
1201	HH Rock Cl 6	HH
1202	HH Rock Cl 7	HH
1203	HH Rock Op 1	HH
1204	HH Rock Op 2	HH
1205	HH Rock Op 3	HH
1206	HH Rock Op 4	HH
1207	HH Rock Op 5	HH
1208	HH Rock Op 6	HH
1209	HH Rock Op 7	HH
1210	HH Rock HOp 1	HH
1211	HH Rock HOp 2	HH
1212	HH Rock HOp 3	HH
1213	HH Rock HOp 4	HH
1214	HH Rock HOp 5	HH

#	Drum Sample	DF
1215	HH Rock HOp 6	HH
1216	HH Rock HOp 7	HH
1217	HH Rock QOp 1	HH
1218	HH Rock QOp 2	HH
1219	HH Rock QOp 3	HH
1220	HH Rock QOp 4	HH
1221	HH Rock QOp 5	HH
1222	HH Rock QOp 6	HH
1223	HH Rock QOp 7	HH
1224	HH Rock Ped 1	HH
1225	HH Rock Ped 2	HH
1226	HH Rock Ped 3	HH
1227	HH Rock Ped 4	HH
1228	HH Rock Ped 5	HH
1229	HH Rock Ped 6	HH
1230	HH Rock Ped 7	HH
1231	HH Natural Cl p	HH
1232	HH Natural Cl mf	HH
1233	HH Natural Op1 p	HH
1234	HH Natural Op1 mf	HH
1235	HH Natural Op2 p	HH
1236	HH Natural Op2 mf	HH
1237	HH Natural Op3	HH
1238	HH Natural Op4	HH
1239	HH Natural pedal Cl	HH
1240	HH Natural pedal Op	HH
1241	HH Natural tip Cl p	HH
1242	HH Natural tip Cl mf	HH
1243	HH Natural tip Op1 p	HH
1244	HH Natural tip Op1 mf	HH
1245	HH Natural tip Op2 p	HH
1246	HH Natural tip Op2 mf	HH
1247	HH Natural tip Op3	HH
1248	HH Natural cup Op1	HH

#	Drum Sample	DF
1249	HH Natural cup Op2	HH
1250	HH Soul Cl p	HH
1251	HH Soul Cl mf	HH
1252	HH Soul Cl f	HH
1253	HH Soul Op p	HH
1254	HH Soul Op mf	HH
1255	HH Soul Op f	HH
1256	HH Vintage Cl p	HH
1257	HH Vintage Cl mf	HH
1258	HH Vintage Cl f	HH
1259	HH Vintage Op	HH
1260	HH Jazz Cl a	HH
1261	HH Jazz Cl b	HH
1262	HH Jazz Cl c	HH
1263	HH Jazz Op1 a	HH
1264	HH Jazz Op1 b	HH
1265	HH Jazz Op1 c	HH
1266	HH Jazz Op2 a	HH
1267	HH Jazz Op2 b	HH
1268	HH Jazz Op3	HH
1269	HH Jazz Op4	HH
1270	HH Jazz tip Cl a	HH
1271	HH Jazz tip Cl b	HH
1272	HH Jazz tip Cl c	HH
1273	HH Jazz tip Op1 a	HH
1274	HH Jazz tip Op1 b	HH
1275	HH Jazz tip Op1 c	HH
1276	HH Jazz tip Op2 a	HH
1277	HH Jazz tip Op2 b	HH
1278	HH Jazz tip Op3	HH
1279	HH Jazz ped Cl	HH
1280	HH Jazz ped Op	HH
1281	HH1 Closed pp	HH
1282	HH1 Closed p	HH

#	Drum Sample	DF
1283	HH1 Closed mf	HH
1284	HH1 Closed f	HH
1285	HH1 Open mp	HH
1286	HH1 Open mf	HH
1287	HH1 Foot mp	HH
1288	HH1 Foot mf	HH
1289	HH2 Closed pp	HH
1290	HH2 Closed p	HH
1291	HH2 Closed mp	HH
1292	HH2 Closed mf	HH
1293	HH2 Closed f	HH
1294	HH2 Closed ff	HH
1295	HH2 Open p	HH
1296	HH2 Open f	HH
1297	HH2 Foot p	HH
1298	HH2 Foot f	HH
1299	HH3 Closed1	HH
1300	HH3 Closed2	HH
1301	HH3 Open1	HH
1302	HH3 Open2	HH
1303	HH3 Sizzle	HH
1304	HH3 Foot	HH
1305	HH4 Closed1	HH
1306	HH4 Closed2	HH
1307	HH4 Open	HH
1308	HH4 Foot	HH
1309	HH4 Foot Open	HH
1310	HH Old TiteClose	HH
1311	HH Old Close1	HH
1312	HH Old Close2	HH
1313	HH Old Open1	HH
1314	HH Old Open2	HH
1315	HH Brush Nat Cl 1	HH
1316	HH Brush Nat Cl 2	HH

#	Drum Sample	DF
1317	HH Brush Nat Cl 3	HH
1318	HH Brush Nat Cl 4	HH
1319	HH Brush Nat Cl 5	HH
1320	HH Brush Nat Cl 6	HH
1321	HH Brush Nat Op a 1	HH
1322	HH Brush Nat Op a 2	HH
1323	HH Brush Nat Op a 3	HH
1324	HH Brush Nat Op a 4	HH
1325	HH Brush Nat Op a 5	HH
1326	HH Brush Nat Op a 6	HH
1327	HH Brush Nat Op b 1	HH
1328	HH Brush Nat Op b 2	HH
1329	HH Brush Nat Op b 3	HH
1330	HH Brush Nat Op b 4	HH
1331	HH Brush Nat Op b 5	HH
1332	HH Brush Nat Op b 6	HH
1333	HH Brush Nat Op c 1	HH
1334	HH Brush Nat Op c 2	HH
1335	HH Brush Nat Op c 3	HH
1336	HH Brush Nat Op c 4	HH
1337	HH Brush Nat Op c 5	HH
1338	HH Brush Nat Op c 6	HH
1339	HH Brush Nat Op d 1	HH
1340	HH Brush Nat Op d 2	HH
1341	HH Brush Nat Op d 3	HH
1342	HH Brush Nat Op d 4	HH
1343	HH Brush Nat Op d 5	HH
1344	HH Brush Nat Op d 6	HH
1345	HH Ped Nat Cl 1	HH
1346	HH Ped Nat Cl 2	HH
1347	HH Ped Nat Cl 3	HH
1348	HH Ped Nat Cl 4	HH
1349	HH Ped Nat Cl 5	HH
1350	HH Ped Nat Op 1	HH

#	Drum Sample	DF
1351	HH Ped Nat Op 2	HH
1352	HH Ped Nat Op 3	HH
1353	HH Ped Nat Op 4	HH
1354	HH Ped Nat Op 5	HH
1355	HH Brush Cl 1	HH
1356	HH Brush Cl 2	HH
1357	HH Brush Cl 3	HH
1358	HH Brush Op 1	HH
1359	HH Brush Op 2	HH
1360	HH Brush Op 3	HH
1361	HH Brush Op 4	HH
1362	HH1 MS20 Cl 1	HH
1363	HH1 MS20 Cl 2	HH
1364	HH1 MS20 Cl 3	HH
1365	HH1 MS20 Cl 4	HH
1366	HH1 MS20 Cl 5	HH
1367	HH1 MS20 Cl 6	HH
1368	HH1 MS20 Op 1	HH
1369	HH1 MS20 Op 2	HH
1370	HH1 MS20 Op 3	HH
1371	HH1 MS20 Op 4	HH
1372	HH1 MS20 Op 5	HH
1373	HH2 MS20 Cl 1	HH
1374	HH2 MS20 Cl 2	HH
1375	HH2 MS20 Cl 3	HH
1376	HH2 MS20 Cl 4	HH
1377	HH2 MS20 Cl 5	HH
1378	HH2 MS20 Cl 6	HH
1379	HH2 MS20 Op 4	HH
1380	HH2 MS20 Op 5	HH
1381	HH House Open1	HH
1382	HH House Open2	HH
1383	HH Hip	HH
1384	HH Alpo Close	HH

#	Drum Sample	DF
1385	HH Dance1	HH
1386	HH Dance2	HH
1387	HH Syn. Closed	HH
1388	HH Syn. Open	HH
1389	Ride T20 1 S 1	Cy
1390	Ride T20 2 S 1	Cy
1391	Ride T20 3 S 1	Cy
1392	Ride T20 4 S 1	Cy
1393	Ride T20 1 S 2	Cy
1394	Ride T20 2 S 2	Cy
1395	Ride T20 3 S 2	Cy
1396	Ride T20 4 S 2	Cy
1397	Ride T20 1 S 3	Cy
1398	Ride T20 2 S 3	Cy
1399	Ride T20 3 S 3	Cy
1400	Ride T20 4 S 3	Cy
1401	Ride T20 1 S 4	Cy
1402	Ride T20 2 S 4	Cy
1403	Ride T20 3 S 4	Cy
1404	Ride T20 4 S 4	Cy
1405	Ride T20 1 S 5	Cy
1406	Ride T20 2 S 5	Cy
1407	Ride T20 3 S 5	Cy
1408	Ride T20 4 S 5	Cy
1409	Ride T20 Cup 1	Cy
1410	Ride T20 Cup 2	Cy
1411	Ride T20 Cup 3	Cy
1412	Ride T20 Cup 4	Cy
1413	Ride Pop1 1	Cy
1414	Ride Pop1 2	Cy
1415	Ride Pop1 3	Cy
1416	Ride Pop1 4	Cy
1417	Ride Pop1 5	Cy
1418	Ride Pop1 6	Cy

#	Drum Sample	DF
1419	Ride Pop1 7	Cy
1420	Ride Pop1 8	Cy
1421	Ride Pop2 1	Cy
1422	Ride Pop2 2	Cy
1423	Ride Pop2 3	Cy
1424	Ride Pop2 4	Cy
1425	Ride Pop2 5	Cy
1426	Ride Pop2 6	Cy
1427	Ride Pop2 7	Cy
1428	Ride Pop2 8	Cy
1429	Ride Pop Bell 1	Cy
1430	Ride Pop Bell 2	Cy
1431	Ride Pop Bell 3	Cy
1432	Ride Pop Bell 4	Cy
1433	Ride Pop Bell 5	Cy
1434	Ride Pop Bell 6	Cy
1435	Ride Pop Bell 7	Cy
1436	Ride Pop Bell 8	Cy
1437	Ride Rock1 1	Cy
1438	Ride Rock1 2	Cy
1439	Ride Rock1 3	Cy
1440	Ride Rock2 1	Cy
1441	Ride Rock2 2	Cy
1442	Ride Rock2 3	Cy
1443	Ride Rock Bell 1	Cy
1444	Ride Rock Bell 2	Cy
1445	Ride Rock Bell 3	Cy
1446	Ride Z20 edge1	Cy
1447	Ride Z20 edge2	Cy
1448	Ride Z20 edge3	Cy
1449	Ride Z20 edge4	Cy
1450	Ride Z20 edge5	Cy
1451	Ride Z20 edge6	Cy
1452	Ride Z20 cup1	Cy

#	Drum Sample	DF
1453	Ride Z20 cup2	Cy
1454	Ride Z20 cup3	Cy
1455	Ride 20' mp1	Cy
1456	Ride 20' mp2	Cy
1457	Ride 20' mf1	Cy
1458	Ride 20' mf2	Cy
1459	Ride Edge1	Cy
1460	Ride Edge2	Cy
1461	Ride Cup	Cy
1462	Ride Jazz	Cy
1463	Ride Z22 Rivet 1 S1	Cy
1464	Ride Z22 Rivet 2 S1	Cy
1465	Ride Z22 Rivet 3 S1	Cy
1466	Ride Z22 Rivet 4 S1	Cy
1467	Ride Z22 Rivet 1 S2	Cy
1468	Ride Z22 Rivet 2 S2	Cy
1469	Ride Z22 Rivet 3 S2	Cy
1470	Ride Z22 Rivet 4 S2	Cy
1471	Ride Z22 Rivet 1 S3	Cy
1472	Ride Z22 Rivet 2 S3	Cy
1473	Ride Z22 Rivet 3 S3	Cy
1474	Ride Z22 Rivet 4 S3	Cy
1475	Ride Z22 Rivet Cup 1	Cy
1476	Ride Z22 Rivet Cup 2	Cy
1477	Ride Z22 Rivet Cup 3	Cy
1478	Ride Z22 Rivet Cup 4	Cy
1479	Ride Rivet	Cy
1480	Ride Rivet Amb	Cy
1481	Ride Brush1	Cy
1482	Ride Brush2	Cy
1483	Ride Brush3	Cy
1484	Ride Brush Nat 1 1	Cy
1485	Ride Brush Nat 1 2	Cy
1486	Ride Brush Nat 1 3	Cy

#	Drum Sample	DF
1487	Ride Brush Nat 2 1	Cy
1488	Ride Brush Nat 2 2	Cy
1489	Ride Brush Nat 2 3	Cy
1490	Ride Brush Nat Cup 1	Cy
1491	Ride Brush Nat Cup 2	Cy
1492	Ride Brush Nat Cup 3	Cy
1493	Ride Z Brush Edge 1	Cy
1494	Ride Z Brush Edge 2	Cy
1495	Ride Z Brush Cup	Cy
1496	Crash Pop 1 1	Cy
1497	Crash Pop 1 2	Cy
1498	Crash Pop 1 3	Cy
1499	Crash Pop 1 4	Cy
1500	Crash Pop 1 5	Cy
1501	Crash Pop 1 6	Cy
1502	Crash Pop 1 7	Cy
1503	Crash Pop 1 8	Cy
1504	Crash Pop 2 1	Cy
1505	Crash Pop 2 2	Cy
1506	Crash Pop 2 3	Cy
1507	Crash Pop 2 4	Cy
1508	Crash Pop 2 5	Cy
1509	Crash Pop 2 6	Cy
1510	Crash Pop 2 7	Cy
1511	Crash Pop 2 8	Cy
1512	Crash Rock 1 1	Cy
1513	Crash Rock 1 2	Cy
1514	Crash Rock 1 3	Cy
1515	Crash Rock 2 1	Cy
1516	Crash Rock 2 2	Cy
1517	Crash Rock 2 3	Cy
1518	Crash 15' edge 1	Cy
1519	Crash 15' edge 2	Cy
1520	Crash 17' edge 1	Cy

#	Drum Sample	DF
1521	Crash 17' edge 2	Cy
1522	Crash 19' open 1	Cy
1523	Crash 19' open 2	Cy
1524	Crash T20 1	Cy
1525	Crash T20 2	Cy
1526	Crash T20 3	Cy
1527	Crash T20 4	Cy
1528	Crash Z 20	Cy
1529	Crash 1	Cy
1530	Crash 2	Cy
1531	Crash Z22 Rivet 1 A1	Cy
1532	Crash Z22 Rivet 2 A1	Cy
1533	Crash Z22 Rivet 3 A1	Cy
1534	Crash Z22 Rivet 4 A1	Cy
1535	Crash Brush 11	Cy
1536	Crash Brush 12	Cy
1537	Crash Brush 13	Cy
1538	Crash Brush 21	Cy
1539	Crash Brush 2 2	Cy
1540	Crash Reverse	Cy
1541	Reverse Cymbal	Cy
1542	Crash Dance 99	Cy
1543	Crash DDD-1	Cy
1544	Splash Pop 1	Cy
1545	Splash Pop 2	Cy
1546	Splash Pop 3	Cy
1547	Splash Pop 4	Cy
1548	Splash Pop 5	Cy
1549	Splash Pop 6	Cy
1550	Splash Pop 7	Cy
1551	Splash Pop 8	Cy
1552	Splash Rock 1	Cy
1553	Splash Rock 2	Cy
1554	Splash Rock 3	Cy

#	Drum Sample	DF
1555	Splash Rock 4	Cy
1556	Splash U11 1	Cy
1557	Splash U11 2	Cy
1558	Splash U11 3	Cy
1559	Splash U11 4	Cy
1560	Splash 8' edge1	Cy
1561	Splash 8' edge2	Cy
1562	Splash	Cy
1563	Chinese Pop 1	Cy
1564	Chinese Pop 2	Cy
1565	Chinese Pop 3	Cy
1566	Chinese Pop 4	Cy
1567	Chinese Pop 5	Cy
1568	Chinese Pop 6	Cy
1569	Chinese Pop 7	Cy
1570	Chinese Pop 8	Cy
1571	China Rock Cymb 1	Cy
1572	China Rock Cymb 2	Cy
1573	China Rock Cymb 3	Cy
1574	China	Cy
1575	Orchestra Cymbal	Cy
1576	Finger Snaps	LP
1577	Finger Snap	LP
1578	Hand Claps 1	LP
1579	Hand Claps 2	LP
1580	Hand Claps 3	LP
1581	Hand Claps 4	LP
1582	Hand Claps 5	LP
1583	Claps Natural 1a	LP
1584	Claps Natural 1b	LP
1585	Claps Natural 1c	LP
1586	Claps Natural 1d	LP
1587	Claps Natural 2a	LP
1588	Claps Natural 2b	LP

#	Drum Sample	DF
1589	Claps Natural 2c	LP
1590	Claps Natural 2d	LP
1591	Claps Natural 2e	LP
1592	Claps Natural 3a	LP
1593	Claps Natural 3b	LP
1594	Claps Natural 3c	LP
1595	Claps Natural 3d	LP
1596	Claps Natural 3e	LP
1597	Claps Natural 3f	LP
1598	Claps Natural 3g	LP
1599	Claps Natural 3h	LP
1600	Claps1	LP
1601	Claps2	LP
1602	Claps3	LP
1603	Claps4	LP
1604	Claps Ensemble 1	LP
1605	Claps Ensemble 2	LP
1606	Claps Ensemble 3	LP
1607	Claps Ensemble 4	LP
1608	Claps Analog	LP
1609	Dance Claps1	LP
1610	Dance Claps2	LP
1611	Dance Claps3	LP
1612	Dance Claps4	LP
1613	Dance Claps5	LP
1614	Dance Claps6	LP
1615	Dance Conga Lo-Open	LP
1616	Dance Conga Hi-Open	LP
1617	Dance Tambourine	HP
1618	Electric Bongo	LP
1619	Syn. Bongo Hi	LP
1620	Syn. Bongo Low	LP
1621	Syn. Castanet	LP
1622	Syn. Shaker	HP

#	Drum Sample	DF
1623	Syn. Noise	SFX
1624	Syn. FX1	SFX
1625	Syn. FX2	SFX
1626	Syn. FX3	SFX
1627	Syn. FX4	SFX
1628	Syn. FX5	SFX
1629	Syn. Perc. Ahh	SFX
1630	Boom	SFX
1631	Zap1	SFX
1632	Zap2	SFX
1633	Vinyl Hit	SFX
1634	DJ Vinyl Sliced 01	SFX
1635	DJ Vinyl Sliced 02	SFX
1636	DJ Vinyl Sliced 03	SFX
1637	DJ Vinyl Sliced 04	SFX
1638	DJ Vinyl Sliced 05	SFX
1639	DJ Vinyl Sliced 06	SFX
1640	DJ Vinyl Sliced 07	SFX
1641	DJ Vinyl Sliced 08	SFX
1642	DJ Vinyl Sliced 09	SFX
1643	DJ Vinyl Sliced 10	SFX
1644	DJ Vinyl Sliced 11	SFX
1645	DJ Vinyl Sliced 12	SFX
1646	DJ Vinyl Sliced 13	SFX
1647	DJ Vinyl Sliced 14	SFX
1648	DJ Vinyl Sliced 15	SFX
1649	DJ Vinyl Sliced 16	SFX
1650	DJ Vinyl Sliced 17	SFX
1651	DJ Vinyl Sliced 18	SFX
1652	DJ Vinyl Sliced 19	SFX
1653	DJ Vinyl Sliced 20	SFX
1654	DJ Vinyl Sliced 21	SFX
1655	DJ Vinyl Sliced 22	SFX
1656	DJ Vinyl Sliced 23	SFX

#	Drum Sample	DF
1657	DJ Vinyl Sliced 24	SFX
1658	DJ Scratch1	SFX
1659	DJ Scratch2	SFX
1660	DJ Scratch3	SFX
1661	DJ Scratch4	SFX
1662	DJ Scratch5	SFX
1663	DJ Scratch6	SFX
1664	DJ Hit Rub	SFX
1665	DJ Vocal Rub1	SFX
1666	DJ Vocal Rub2	SFX
1667	DJ BD Rub	SFX
1668	DJ SD Rub	SFX
1669	Guiro Long Nat p	LP
1670	Guiro Long Nat f	LP
1671	Guiro Long	LP
1672	Guiro Short Nat p	LP
1673	Guiro Short Nat f	LP
1674	Guiro Short	LP
1675	Vibraslap	HP
1676	Vibraslap Amb	HP
1677	Long Whistle	HP
1678	Short Whistle	HP
1679	Samba Whistle	HP
1680	Samba Whistle Lp	HP
1681	Cuica Open 1	LP
1682	Cuica Open 2	LP
1683	Cuica Open 3	LP
1684	Cuica Mute 1	LP
1685	Cuica Mute 2	LP
1686	Cuica Hi	LP
1687	Cuica Lo	LP
1688	Surdo Open	LP
1689	Surdo Mute	LP
1690	Surdo Open GM	LP

#	Drum Sample	DF
1691	Surdo Mute GM	LP
1692	Tumba Open1 mf	LP
1693	Tumba Open1 f	LP
1694	Tumba Open2 mf	LP
1695	Tumba Open2 f	LP
1696	Tumba Open Flam	LP
1697	Tumba Glissando	LP
1698	Tumba Basstone	LP
1699	Tumba O.Slap Flam mf	LP
1700	Tumba O.Slap Flam f	LP
1701	Tumba Muffled	LP
1702	Low Conga 1	LP
1703	Low Conga 2	LP
1704	Low Conga 3	LP
1705	Low Conga 4	LP
1706	Low Conga 5	LP
1707	Congal Lo Basstone	LP
1708	Congal Lo Open mf	LP
1709	Congal Lo Open Slap	LP
1710	Congal Lo Glissando	LP
1711	Congal Lo Muffled	LP
1712	Congal Lo Closed	LP
1713	Congal Lo Closed Slap	LP
1714	Congal Lo Heel	LP
1715	Congal Lo Toe	LP
1716	Open Hi Conga 1	LP
1717	Open Hi Conga 2	LP
1718	Open Hi Conga 3	LP
1719	Open Hi Conga 4	LP
1720	Mute Hi Conga 1	LP
1721	Mute Hi Conga 2	LP
1722	Mute Hi Conga 3	LP
1723	Congal Hi Basstone mf	LP
1724	Congal Hi Basstone f	LP

#	Drum Sample	DF
1725	Conga1 Hi Open mf	LP
1726	Conga1 Hi Open Slap	LP
1727	Conga1 Hi Muffled	LP
1728	Conga1 Hi Closed	LP
1729	Conga1 Hi Closed Slap	LP
1730	Conga1 Hi Heel	LP
1731	Conga1 Hi Toe	LP
1732	Conga2 Lo Open	LP
1733	Conga2 Lo Mt Slap	LP
1734	Conga2 Lo Slap	LP
1735	Conga2 Hi Open	LP
1736	Conga2 Hi Mute	LP
1737	Conga2 Hi Mt Slap	LP
1738	Conga2 Hi Slap1	LP
1739	Conga2 Hi Slap2	LP
1740	Conga2 Heel	LP
1741	Conga2 Toe	LP
1742	Quinto1 Open	LP
1743	Quinto1 Closed	LP
1744	Quinto1 Closed Slap	LP
1745	Quinto1 Toe	LP
1746	Quinto2 Basstone	LP
1747	Quinto2 Open mp	LP
1748	Quinto2 Open Flam	LP
1749	Quinto2 Open Slap	LP
1750	Quinto2 Muffled	LP
1751	Quinto2 C.Slap Flam p	LP
1752	Quinto2 C.Slap Flam f	LP
1753	Quinto2 Heel	LP
1754	Low Bongo 1	LP
1755	Low Bongo 2	LP
1756	Low Bongo 3	LP
1757	Hi Bongo 1	LP
1758	Hi Bongo 2	LP

#	Drum Sample	DF
1759	Hi Bongo 3	LP
1760	Bongo1 Lo Muffled mp	LP
1761	Bongo1 Lo Muffled f	LP
1762	Bongo1 Lo Closed	LP
1763	Bongo1 Lo Flam	LP
1764	Bongo1 Lo MuffledFlam	LP
1765	Bongo1 Lo Stick	LP
1766	Bongo1 Lo StickEdge mf	LP
1767	Bongo1 Lo StickEdge f	LP
1768	Bongo1 Lo StickBounce	LP
1769	Bongo1 Lo Fingernail	LP
1770	Bongo1 Lo Cuptone	LP
1771	Bongo1 Lo Slap	LP
1772	Bongo1 Hi Open mf	LP
1773	Bongo1 Hi Open f	LP
1774	Bongo1 Hi Pops	LP
1775	Bongo1 Hi Hightone	LP
1776	Bongo1 Hi OpenFlam	LP
1777	Bongo1 Hi Fingernail	LP
1778	Bongo1 Hi Stick	LP
1779	Bongo1 Hi StickEdge mf	LP
1780	Bongo1 Hi StickEdge f	LP
1781	Bongo1 Hi StickBounce	LP
1782	Bongo1 Hi Cuptone	LP
1783	Bongo1 Hi Slap	LP
1784	Bongo2 Lo Open a	LP
1785	Bongo2 Lo Open b	LP
1786	Bongo2 Lo Mute	LP
1787	Bongo2 Hi Open a	LP
1788	Bongo2 Hi Open b	LP
1789	Bongo2 Hi Muffled	LP
1790	Bongo2 Hi Slap	LP
1791	Bongo2 Lo Heel	LP
1792	Bongo2 Lo Muffled	LP

#	Drum Sample	DF
1793	Bongo3 Lo Open	LP
1794	Bongo3 Lo Slap	LP
1795	Bongo3 Lo Stick	LP
1796	Bongo3 Hi Open	LP
1797	Bongo3 Hi Slap	LP
1798	Bongo3 Hi Stick1	LP
1799	Bongo3 Hi Stick2	LP
1800	Okonkolo Boca Open mp	LP
1801	Okonkolo Boca Open mf	LP
1802	Okonkolo Boca Open f	LP
1803	Okonkolo Boca Open ff	LP
1804	Okonkolo Cha Open p	LP
1805	Okonkolo Cha Open mf	LP
1806	Okonkolo Cha Open f	LP
1807	Okonkolo Cha Open ff	LP
1808	Okonkolo Cha Slap p	LP
1809	Okonkolo Cha Slap mf	LP
1810	Okonkolo Cha Slap f	LP
1811	Baya Open	LP
1812	Baya Ghe	LP
1813	Baya GheUp a	LP
1814	Baya GheUp b	LP
1815	Baya KaPalm	LP
1816	Baya KaToe a	LP
1817	Baya KaToe b	LP
1818	Baya Nail a	LP
1819	Baya Nail b	LP
1820	Baya Nail c	LP
1821	Baya Ge	LP
1822	Baya Up	LP
1823	Baya UpDown a	LP
1824	Baya UpDown b	LP
1825	Baya Mute1	LP
1826	Baya Mute2	LP

#	Drum Sample	DF
1827	Baya Mute3	LP
1828	Tabla1 Na	LP
1829	Tabla1 Open	LP
1830	Tabla1 Tin	LP
1831	Tabla1 Mute1	LP
1832	Tabla1 Mute2	LP
1833	Tabla1 Mute3	LP
1834	Tabla2 Tin a	LP
1835	Tabla2 Tin b	LP
1836	Tabla2 Na a	LP
1837	Tabla2 Na b	LP
1838	Tabla2 Na c	LP
1839	Tabla2 Tun a	LP
1840	Tabla2 Tun b	LP
1841	Tabla2 Tele a	LP
1842	Tabla2 Tele b	LP
1843	Tabla2 Tele c	LP
1844	Tabla2 Ti a	LP
1845	Tabla2 Ti b	LP
1846	Tabla2 Ti c	LP
1847	Tabla2 Tera	LP
1848	Tsuzumi	LP
1849	Taiko Open	LP
1850	Taiko Rim	LP
1851	Low Timbale 1	LP
1852	Low Timbale 2	LP
1853	Low Timbale 3	LP
1854	Low Timbale 4	LP
1855	Low Timbale 5	LP
1856	Timbales1 Lo Op mp	LP
1857	Timbales1 Lo Op mf	LP
1858	Timbales1 Lo Op mf GM	LP
1859	Timbales1 Lo Edge mf	LP
1860	Timbales1 Lo Edge f	LP

#	Drum Sample	DF
1861	Timbales1 Lo RimShot	LP
1862	Timbales1 Lo Abanico	LP
1863	Timbales1 Lo Roll	LP
1864	Timbales1 Lo Mute mf	LP
1865	Timbales1 Lo Mute f	LP
1866	Timbales1 Lo Paila mf	HP
1867	Timbales1 Lo Paila f	HP
1868	High Timbale 1	LP
1869	High Timbale 2	LP
1870	High Timbale 3	LP
1871	High Timbale 4	LP
1872	High Timbale 5	LP
1873	Timbales1 Hi Open	LP
1874	Timbales1 Hi Edge	LP
1875	Timbales1 Hi Edge GM	LP
1876	Timbales1 Hi Rim p	LP
1877	Timbales1 Hi Rim mf	LP
1878	Timbales1 Hi Rim f	LP
1879	Timbales1 Hi Abanico1	LP
1880	Timbales1 Hi Abanico2	LP
1881	Timbales1 Hi Mute	LP
1882	Timbales1 Hi Paila mf	HP
1883	Timbales1 Hi Paila f	HP
1884	Timbales2 Lo Open	LP
1885	Timbales2 Lo Mute	LP
1886	Timbales2 Lo Rim	LP
1887	Timbales2 Hi Edge	LP
1888	Timbales2 Hi Rim1	LP
1889	Timbales2 Hi Rim2	LP
1890	Timbales2 Paila	HP
1891	Cowbell Amb	HP
1892	Cowbell1	HP
1893	Cowbell2	HP
1894	Cowbell3	HP

#	Drum Sample	DF
1895	Cowbell4 Open	HP
1896	Cowbell4 Mute	HP
1897	Cowbell5 Open a	HP
1898	Cowbell5 Open b	HP
1899	Cowbell5 Mute	HP
1900	Cowbell6	HP
1901	Cowbell7-Open	HP
1902	Cowbell7-Mute	HP
1903	Cowbell Rock 1	HP
1904	Cowbell Rock 2	HP
1905	Cowbell Rock 3	HP
1906	Cowbell Rock 4	HP
1907	Hi Agogo	HP
1908	Low Agogo	HP
1909	Agogo Bell	HP
1910	Chacha Bell	HP
1911	Mambo Bell	HP
1912	Recoreco short1	HP
1913	Recoreco short2	HP
1914	Recoreco short3	HP
1915	Recoreco long	HP
1916	Open Triangle p	HP
1917	Open Triangle f	HP
1918	Triangle1 Open	HP
1919	Triangle2 Open Lp	HP
1920	Triangle2 Closed c	HP
1921	Mute Triangle p	HP
1922	Mute Triangle f	HP
1923	Triangle1 Mute	HP
1924	Sleigh Bell	HP
1925	Rap Sleigh Bell	HP
1926	Jingle Bell Amb	HP
1927	Jingle Bell	HP
1928	Bells Open	HP

#	Drum Sample	DF
1929	Finger Cymbal	HP
1930	Marc Tree	HP
1931	Marc Tree GM	HP
1932	Marc TreeLP	HP
1933	Marc Tree Amb	HP
1934	Rainstick	SFX
1935	Flexatone	HP
1936	Chinese Gong	Cy
1937	Claves p	LP
1938	Claves f	LP
1939	Claves1 Lo a	LP
1940	Claves1 Lo b	LP
1941	Claves1 Hi a	LP
1942	Claves1 Hi b	LP
1943	Claves2	LP
1944	Low Wood Block p	LP
1945	Low Wood Block f	LP
1946	Hi Wood Block p	LP
1947	Hi Wood Block f	LP
1948	Wood Block 1 a	LP
1949	Wood Block 1 b	LP
1950	Wood Block 2 a	LP
1951	Wood Block 2 b	LP
1952	Wood Block 3 a	LP
1953	Wood Block 3 b	LP
1954	Wood Block 4 a	LP
1955	Wood Block 4 b	LP
1956	Wood Block 5 a	LP
1957	Wood Block 5 b	LP
1958	Wood Block 6 a	LP
1959	Wood Block 6 b	LP
1960	Wood Block 7	LP
1961	Wood Block 8	LP
1962	Castanet Amb	LP

#	Drum Sample	DF
1963	Castanet 1 a	LP
1964	Castanet 1 b	LP
1965	Castanet 1 c	LP
1966	Castanet 2	LP
1967	Castanet Single	LP
1968	Castanet Single GM	LP
1969	Castanet Double	LP
1970	Cabasa Amb 1	HP
1971	Cabasa Amb 2	HP
1972	Cabasa Amb 3	HP
1973	Cabasa 1 L a Down	HP
1974	Cabasa 1 L a Up	HP
1975	Cabasa 1 L b Down	HP
1976	Cabasa 1 L b Up	HP
1977	Cabasa 1 S a Down	HP
1978	Cabasa 1 S a Up	HP
1979	Cabasa 1 S b Down	HP
1980	Cabasa 1 S b up	HP
1981	Cabasa 2 L Stack b	HP
1982	Cabasa 2 L Stack a	HP
1983	Cabasa 2 L Roll	HP
1984	Cabasa 2 S Stack a	HP
1985	Cabasa 2 S Stack b	HP
1986	Cabasa 2 S Roll	HP
1987	Cabasa 3 WS	HP
1988	Cabasa 3 Up	HP
1989	Cabasa 3 Down	HP
1990	Cabasa 3 Tap	HP
1991	Caxixi1 a	HP
1992	Caxixi1 b	HP
1993	Caxixi1 c	HP
1994	Caxixi2 a	HP
1995	Caxixi2 b	HP
1996	Caxixi2 c	HP

#	Drum Sample	DF
1997	Caxixi3 Hard	HP
1998	Caxixi3 Soft	HP
1999	Shaker Amb	HP
2000	Shaker1 PuE_Sh a	HP
2001	Shaker1 PuE_Sh b	HP
2002	Shaker1 Pull a	HP
2003	Shaker1 Pull b	HP
2004	Shaker1 Accent a	HP
2005	Shaker1 Accent b	HP
2006	Shaker1 Slow a	HP
2007	Shaker1 Slow b	HP
2008	Shaker1 Slow c	HP
2009	Shaker1 Roll a	HP
2010	Shaker1 Roll b	HP
2011	Shaker1 Roll c	HP
2012	Shaker2	HP
2013	Shaker3	HP
2014	Maracas Amb 1	HP
2015	Maracas Amb 2	HP
2016	Maracas Amb 3	HP
2017	Maracas Amb 4	HP
2018	Maracas Push	HP
2019	Maracas Pull	HP
2020	Dumbek a	LP
2021	Dumbek b	LP
2022	Dumbek c	LP
2023	Dumbek d	LP
2024	Dumbek e	LP
2025	Dumbek f	LP
2026	Dumbek g	LP
2027	Dumbek h	LP
2028	Dumbek i	LP
2029	Dumbek j	LP
2030	Dumbek k	LP

#	Drum Sample	DF
2031	Djembe L Basstone a	LP
2032	Djembe L Basstone b	LP
2033	Djembe L Basstone c	LP
2034	Djembe L Open	LP
2035	Djembe L Open Slap	LP
2036	Djembe L Closed Slap	LP
2037	Djembe S Basstone a	LP
2038	Djembe S Basstone b	LP
2039	Djembe S Basstone c	LP
2040	Djembe Open	LP
2041	Djembe Mute	LP
2042	Djembe Slap	LP
2043	Djembe S Open	LP
2044	Djembe S Open Slap a	LP
2045	Djembe S Open Slap b	LP
2046	Djembe S Closed Slap a	LP
2047	Djembe S Closed Slap b	LP
2048	Djembe S Closed Slap c	LP
2049	Djembe Bass	LP
2050	Udu Open a	LP
2051	Udu Open b	LP
2052	Udu Open c	LP
2053	Udu Open d	LP
2054	Udu Slide a	HP
2055	Udu Slide b	HP
2056	Udu Half Open a	LP
2057	Udu Half Open b	LP
2058	Udu Half Open c	LP
2059	Udu Bell a	LP
2060	Udu Bell b	LP
2061	WD Brazillia1	SD
2062	WD Brazillia2	SD
2063	WD Ethno SD1	SD
2064	WD Ethno SD2	SD

#	Drum Sample	DF
2065	WD Ethno SD3	SD
2066	WD Ethno SD4	SD
2067	WD Ethno SD5	SD
2068	WD Ethno SD6	SD
2069	WD Kangaroo1	SFX
2070	WD Kangaroo2	SFX
2071	WD Kangaroo3	SFX
2072	WD Kangaroo4	SFX
2073	WD Kangaroo5	SFX
2074	WD Kangaroo6	SFX
2075	WD Kangaroo7	SFX
2076	WD Kangaroo8	SFX
2077	Tambourine Push	HP
2078	Tambourine Pull	HP
2079	Tambourine Acc1 A	HP
2080	Tambourine Acc1 B	HP
2081	Tambourine Acc2	HP
2082	Tambourine Mute1	LP
2083	Tambourine Mute2	LP
2084	Tambourine Open	LP
2085	Tambourine Nat 1	HP
2086	Tambourine Nat 2	HP
2087	Tambourine Nat 3	HP
2088	Tambourine Nat 4	HP
2089	Tambourine Nat 5	HP
2090	Tambourine Rock 1	HP
2091	Tambourine Rock 2	HP
2092	Tambourine Rock 3	HP
2093	Tambourine Rock 4	HP
2094	M.E.1 Douf Rim Ak	LP
2095	M.E.1 Douf Tek Ak1	LP
2096	M.E.1 Douf Tek Ak2	LP
2097	M.E.1 Pand Open	LP
2098	M.E.1 Pand Pattern1	LP

#	Drum Sample	DF
2099	M.E.1 Pand Pattern2	LP
2100	M.E.1 Pand Pattern3	LP
2101	M.E.1 Pand Pattern4	LP
2102	M.E.1 Rek Dom Ak	HP
2103	M.E.1 Rek Jingle	HP
2104	M.E.1 Rik1	LP
2105	M.E.1 Rik2	LP
2106	M.E.1 Rik3	LP
2107	M.E.1 Sagat Half Open	HP
2108	M.E.1 Sagat Close	HP
2109	M.E.1 Surdo L Open	LP
2110	M.E.1 Surdo L Mute	LP
2111	M.E.1 Tabla Medium	LP
2112	M.E.1 Tabla Dom	LP
2113	M.E.1 Tabla Flam	LP
2114	M.E.1 Tabla Rim	LP
2115	M.E.1 Tabla Tak	LP
2116	M.E.1 Timbales	HP
2117	M.E.1 Udu f Open	LP
2118	M.E.1 Alkis	LP
2119	M.E.1 Bandir Open	LP
2120	M.E.1 Bandir Closed	LP
2121	M.E.1 Bongo Roll	LP
2122	M.E.1 Darbuka1 Tek1	LP
2123	M.E.1 Darbuka1 Tek2	LP
2124	M.E.1 Darbuka1 Open	LP
2125	M.E.1 Darbuka1 Closed	LP
2126	M.E.1 Darbuka2	LP
2127	M.E.1 Darbuka3	LP
2128	M.E.1 Darbuka4	LP
2129	M.E.1 Darbuka5 D1	LP
2130	M.E.1 Darbuka5 D2	LP
2131	M.E.1 Darbuka5 D3	LP
2132	M.E.1 Darbuka6 Mute	LP

#	Drum Sample	DF
2133	M.E.1 Darbuka6 Open	LP
2134	M.E.1 Darbuka6 Rim	LP
2135	M.E.1 Darbuka6 Dom Ak	LP
2136	M.E.1 Davul	HP
2137	M.E.1 Hollo1	LP
2138	M.E.1 Hollo2	LP
2139	M.E.1 Kup1	LP
2140	M.E.1 Kup2	LP
2141	M.E.1 Ramadan Davul1	LP
2142	M.E.1 Ramadan Davul2	LP
2143	M.E.1 Ramadan Davul3	LP
2144	M.E.1 Tef1	HP
2145	M.E.1 Tef2	HP
2146	M.E.1 Tef3	HP
2147	M.E.2 BD Kick	BD
2148	M.E.2 SD	SD
2149	M.E.2 Asagum	LP
2150	M.E.2 Asmatek	LP
2151	M.E.2 Bendirgum	LP
2152	M.E.2 Bendirtek1	LP
2153	M.E.2 Bendirtek2	LP
2154	M.E.2 Dm1	LP
2155	M.E.2 Findik	LP
2156	M.E.2 Gum	LP
2157	M.E.2 Hollotokat	LP
2158	M.E.2 Islik1	SFX
2159	M.E.2 Islik2	SFX
2160	M.E.2 Kapalit	LP
2161	M.E.2 Kasik1	LP
2162	M.E.2 Kasik2	LP
2163	M.E.2 Kasik3	LP
2164	M.E.2 Kasik4	LP
2165	M.E.2 Kemik	LP
2166	M.E.2 Kenar1	LP

#	Drum Sample	DF
2167	M.E.2 Kenartek	LP
2168	M.E.2 Ramazanum	LP
2169	M.E.2 Ramazantek	LP
2170	M.E.2 Renk	LP
2171	M.E.2 Renkbir	LP
2172	M.E.2 Renkiki	LP
2173	M.E.2 Tefacik	LP
2174	M.E.2 Tefgum	LP
2175	M.E.2 Teftek1	LP
2176	M.E.2 Teftokat	LP
2177	M.E.2 Teftrill	LP
2178	M.E.2 Tefzil	LP
2179	M.E.2 Tek1	LP
2180	M.E.2 Tek2	LP
2181	M.E.2 Tekbir	LP
2182	M.E.2 Tokat	LP
2183	M.E.2 Toprgum	LP
2184	M.E.2 Toprtek1	LP
2185	M.E.2 Toprtek2	LP
2186	M.E.2 Toprtokat	LP
2187	M.E.2 TRILL1	LP
2188	M.E.2 Zil1	HP
2189	M.E.2 Zil2	HP
2190	M.E.2 Zil3	HP
2191	M.E.2 Zilgit	SFX
2192	Orchestra Hit	SFX
2193	Band Hit	SFX
2194	Impact Hit	SFX
2195	Metal Hit	SFX
2196	Yeah!	SFX
2197	Yeah! Solo	SFX
2198	Uhh	SFX
2199	Hit It	SFX
2200	Uhhhh Solo	SFX

#	Drum Sample	DF
2201	Comp Voice Noise	SFX
2202	Stadium Amb	SFX
2203	Stadium	SFX
2204	Applause Amb	SFX
2205	Applause	SFX
2206	Scream	SFX
2207	Laughing	SFX
2208	Footsteps1	SFX
2209	Footsteps2	SFX
2210	Bird1	SFX
2211	Bird2	SFX
2212	Dog	SFX
2213	Gallop	SFX
2214	Crickets	SFX
2215	Cat	SFX
2216	Growl	SFX
2217	Heart Beat	SFX
2218	Heart Beat GM	SFX
2219	Punch	SFX
2220	Tribe	SFX
2221	Door Creak	SFX
2222	Door Slam	SFX
2223	Car Engine	SFX
2224	Car Stop	SFX
2225	Car Pass	SFX
2226	Car Crash	SFX
2227	Train	SFX
2228	Helicopter	SFX
2229	Gun Shot1	SFX
2230	Gun Shot2	SFX
2231	Machine Gun	SFX
2232	Laser Gun	SFX
2233	Explosion	SFX
2234	Thunder	SFX

#	Drum Sample	DF
2235	Wind	SFX
2236	Stream	SFX
2237	Bubble	SFX
2238	Bubble GM	SFX
2239	Church Bell	SFX
2240	Telephone Ring	SFX
2241	Xylophone Spectr	SFX
2242	Cricket Spectrum	SFX
2243	Air Vortex	SFX
2244	Noise White	SFX
2245	Noise FM Mod	SFX
2246	Tubular	HP
2247	Gamelan	HP
2248	Tambura	HP
2249	Gtr Cut Noise1	SFX
2250	Gtr Cut Noise2	SFX
2251	Power Chord	SFX
2252	Fret Noise	SFX
2253	Dist. Slide1	SFX
2254	Dist. Slide2	SFX
2255	E.Gtr Pick1	SFX
2256	E.Gtr Pick2	SFX
2257	Gtr Scratch1	SFX
2258	Gtr Scratch2	SFX
2259	Ac.Bs-String Slap	SFX
2260	Amp Noise	SFX
2261	Space Lore	SFX
2262	Swish Terra	SFX
2263	Hand Drill	SFX
2264	Mouth Harp	SFX
2265	Slice Groove A 001	BD
2266	Slice Groove A 002	SD
2267	Slice Groove A 003	SD
2268	Slice Groove A 004	SD

#	Drum Sample	DF
2269	Slice Groove A 005	SFX
2270	Slice Groove A 006	SD
2271	Slice Groove A 007	BD
2272	Slice Groove A 008	BD
2273	Slice Groove A 009	BD
2274	Slice Groove A 010	SFX
2275	Slice Groove A 011	SD
2276	Slice Groove A 012	SD
2277	Slice Groove A 013	SFX
2278	Slice Groove A 014	SFX
2279	Slice Groove A 015	SD
2280	Slice Groove A 016	SFX
2281	Slice Groove A 017	SFX
2282	Slice Groove A 018	SFX
2283	Slice Groove A 019	SFX
2284	Slice Groove A 020	BD
2285	Slice Groove A 021	HH
2286	Slice Groove A 022	SFX
2287	Slice Groove A 023	SD
2288	Slice Groove A 024	SFX
2289	Slice Groove A 025	BD
2290	Slice Groove A 026	SD
2291	Slice Groove A 027	BD
2292	Slice Groove A 028	BD
2293	Slice Groove A 029	SD
2294	Slice Groove A 030	SD
2295	Slice Groove A 031	SD
2296	Slice Groove A 032	SD
2297	Slice Groove A 033	SD
2298	Slice Groove A 034	SD
2299	Slice Groove A 035	SD
2300	Slice Groove A 036	BD
2301	Slice Groove A 037	BD
2302	Slice Groove A 038	SD

#	Drum Sample	DF
2303	Slice Groove A 039	SD
2304	Slice Groove A 040	SFX
2305	Slice Groove A 041	SFX
2306	Slice Groove A 042	SD
2307	Slice Groove A 043	SFX
2308	Slice Groove A 044	SFX
2309	Slice Groove A 045	SFX
2310	Slice Groove A 046	SFX
2311	Slice Groove A 047	SFX
2312	Slice Groove A 048	SFX
2313	Slice Groove A 049	SFX
2314	Slice Groove A 050	SFX
2315	Slice Groove A 051	SD
2316	Slice Groove A 052	SFX
2317	Slice Groove A 053	SFX
2318	Slice Groove A 054	SD
2319	Slice Groove A 055	HH
2320	Slice Groove A 056	SD
2321	Slice Groove A 057	SFX
2322	Slice Groove A 058	BD
2323	Slice Groove A 059	SD
2324	Slice Groove A 060	SD
2325	Slice Groove A 061	SD
2326	Slice Groove A 062	Tm
2327	Slice Groove A 063	Tm
2328	Slice Groove A 064	BD
2329	Slice Groove A 065	SFX
2330	Slice Groove A 066	SFX
2331	Slice Groove A 067	SFX
2332	Slice Groove A 068	SD
2333	Slice Groove A 069	SFX
2334	Slice Groove A 070	SFX
2335	Slice Groove A 071	SFX
2336	Slice Groove A 072	SFX

#	Drum Sample	DF
2337	Slice Groove A 073	BD
2338	Slice Groove A 074	SD
2339	Slice Groove A 075	BD
2340	Slice Groove A 076	SFX
2341	Slice Groove A 077	SD
2342	Slice Groove A 078	BD
2343	Slice Groove A 079	SFX
2344	Slice Groove A 080	SFX
2345	Slice Groove A 081	SFX
2346	Slice Groove A 082	BD
2347	Slice Groove A 083	BD
2348	Slice Groove A 084	SFX
2349	Slice Groove A 085	BD
2350	Slice Groove A 086	SD
2351	Slice Groove A 087	SFX
2352	Slice Groove A 088	BD
2353	Slice Groove A 089	BD
2354	Slice Groove A 090	HH
2355	Slice Groove A 091	BD
2356	Slice Groove A 092	SD
2357	Slice Groove A 093	SFX
2358	Slice Groove A 094	SFX
2359	Slice Groove A 095	SFX
2360	Slice Groove A 096	SFX
2361	Slice Groove A 097	BD
2362	Slice Groove A 098	BD
2363	Slice Groove A 099	SD
2364	Slice Groove A 100	SFX
2365	Slice Groove A 101	SFX
2366	Slice Groove A 102	SFX
2367	Slice Groove A 103	SFX
2368	Slice Groove A 104	SFX
2369	Slice Groove A 105	SFX
2370	Slice Groove A 106	BD

#	Drum Sample	DF
2371	Slice Groove A 107	SFX
2372	Slice Groove A 108	SFX
2373	Slice Groove A 109	SFX
2374	Slice Groove A 110	SFX
2375	Slice Groove A 111	HH
2376	Slice Groove A 112	SFX
2377	Slice Groove A 113	BD
2378	Slice Groove A 114	SD
2379	Slice Groove A 115	SFX
2380	Slice Groove A 116	SFX
2381	Slice Groove A 117	SFX
2382	Slice Groove A 118	SFX
2383	Slice Groove A 119	HH
2384	Slice Groove A 120	BD
2385	Slice Groove A 121	SFX
2386	Slice Groove A 122	SFX
2387	Slice Groove A 123	SFX
2388	Slice Groove A 124	SD
2389	Slice Groove A 125	SD
2390	Slice Groove A 126	SD
2391	Slice Groove A 127	BD
2392	Slice Groove A 128	SD
2393	Slice Groove B 001	SD
2394	Slice Groove B 002	BD
2395	Slice Groove B 003	BD
2396	Slice Groove B 004	BD
2397	Slice Groove B 005	SFX
2398	Slice Groove B 006	SFX
2399	Slice Groove B 007	SFX
2400	Slice Groove B 008	BD
2401	Slice Groove B 009	SD
2402	Slice Groove B 010	HH
2403	Slice Groove B 011	BD
2404	Slice Groove B 012	BD

#	Drum Sample	DF
2405	Slice Groove B 013	SD
2406	Slice Groove B 014	SD
2407	Slice Groove B 015	SFX
2408	Slice Groove B 016	BD
2409	Slice Groove B 017	SD
2410	Slice Groove B 018	SFX
2411	Slice Groove B 019	SFX
2412	Slice Groove B 020	SFX
2413	Slice Groove B 021	SFX
2414	Slice Groove B 022	BD
2415	Slice Groove B 023	HH
2416	Slice Groove B 024	SFX
2417	Slice Groove B 025	SFX
2418	Slice Groove B 026	SFX
2419	Slice Groove B 027	BD
2420	Slice Groove B 028	SD
2421	Slice Groove B 029	SFX
2422	Slice Groove B 030	SFX
2423	Slice Groove B 031	SFX
2424	Slice Groove B 032	BD
2425	Slice Groove B 033	BD
2426	Slice Groove B 034	HH
2427	Slice Groove B 035	HH
2428	Slice Groove B 036	HH
2429	Slice Groove B 037	SFX
2430	Slice Groove B 038	BD
2431	Slice Groove B 039	BD
2432	Slice Groove B 040	BD
2433	Slice Groove B 041	SFX
2434	Slice Groove B 042	SD
2435	Slice Groove B 043	SD
2436	Slice Groove B 044	HH
2437	Slice Groove B 045	BD
2438	Slice Groove B 046	SD

#	Drum Sample	DF
2439	Slice Groove B 047	SFX
2440	Slice Groove B 048	SFX
2441	Slice Groove B 049	SFX
2442	Slice Groove B 050	BD
2443	Slice Groove B 051	SFX
2444	Slice Groove B 052	BD
2445	Slice Groove B 053	SFX
2446	Slice Groove B 054	SFX
2447	Slice Groove B 055	SFX
2448	Slice Groove B 056	SFX
2449	Slice Groove B 057	SFX
2450	Slice Groove B 058	SFX
2451	Slice Groove B 059	HH
2452	Slice Groove B 060	SD
2453	Slice Groove B 061	SFX
2454	Slice Groove B 062	SFX
2455	Slice Groove B 063	SFX
2456	Slice Groove B 064	BD
2457	Slice Groove B 065	BD
2458	Slice Groove B 066	SFX
2459	Slice Groove B 067	SFX
2460	Slice Groove B 068	SFX
2461	Slice Groove B 069	SFX
2462	Slice Groove B 070	SD
2463	Slice Groove B 071	SFX
2464	Slice Groove B 072	SD
2465	Slice Groove B 073	SFX
2466	Slice Groove B 074	HH
2467	Slice Groove B 075	BD
2468	Slice Groove B 076	SFX
2469	Slice Groove B 077	SFX
2470	Slice Groove B 078	SD
2471	Slice Groove B 079	SFX
2472	Slice Groove B 080	BD

#	Drum Sample	DF
2473	Slice Groove B 081	SD
2474	Slice Groove B 082	SD
2475	Slice Groove B 083	SD
2476	Slice Groove B 084	SFX
2477	Slice Groove B 085	SD
2478	Slice Groove B 086	HH
2479	Slice Groove B 087	SD
2480	Slice Groove B 088	SD
2481	Slice Groove B 089	SD
2482	Slice Groove B 090	SD
2483	Slice Groove B 091	SD
2484	Slice Groove B 092	SD
2485	Slice Groove B 093	BD
2486	Slice Groove B 094	SFX
2487	Slice Groove B 095	SFX
2488	Slice Groove B 096	SFX
2489	Slice Groove B 097	SFX
2490	Slice Groove B 098	SFX
2491	Slice Groove B 099	BD
2492	Slice Groove B 100	SFX
2493	Slice Groove B 101	SD
2494	Slice Groove B 102	SFX
2495	Slice Groove B 103	BD
2496	Slice Groove B 104	BD
2497	Slice Groove B 105	HH
2498	Slice Groove B 106	BD
2499	Slice Groove B 107	SFX
2500	Slice Groove B 108	SFX
2501	Slice Groove B 109	HH
2502	Slice Groove B 110	SFX
2503	Slice Groove B 111	HH
2504	Slice Groove B 112	BD
2505	Slice Groove B 113	BD
2506	Slice Groove B 114	SFX

#	Drum Sample	DF
2507	Slice Groove B 115	SD
2508	Slice Groove B 116	SD
2509	Slice Groove B 117	HH
2510	Slice Groove B 118	SFX
2511	Slice Groove B 119	SD
2512	Slice Groove B 120	BD
2513	Slice Groove B 121	BD
2514	Slice Groove B 122	SFX
2515	Slice Groove B 123	BD
2516	Slice Groove B 124	SFX
2517	Slice Groove B 125	SFX
2518	Slice Groove B 126	SD
2519	Slice Groove B 127	SFX
2520	Slice Groove B 128	SFX
2521	Grv BD1	BD
2522	Grv BD2	BD
2523	Grv BD3	BD
2524	Grv BD4	BD
2525	Grv BD5	BD
2526	Grv BD6	BD
2527	Grv BD7	BD
2528	Grv BD8	BD
2529	Grv BD9	BD
2530	Grv BD10	BD
2531	Grv BD11	BD
2532	Grv BD12	BD
2533	Grv BD13	BD
2534	Grv BD14	BD
2535	Grv BD15	BD
2536	Grv BD16	BD
2537	Grv BD17	BD
2538	Grv BD18	BD
2539	Grv BD19	BD
2540	Grv BD20	BD

#	Drum Sample	DF
2541	Grv BD21	BD
2542	Grv BD22	BD
2543	Grv BD23	BD
2544	Grv SD1	SD
2545	Grv SD2	SD
2546	Grv SD3	SD
2547	Grv SD4	SD
2548	Grv SD5	SD
2549	Grv SD6	SD
2550	Grv SD7	SD
2551	Grv SD8	SD
2552	Grv SD9	SD
2553	Grv SD10	SD
2554	Grv SD11	SD
2555	Grv SD12	SD
2556	Grv SD13	SD
2557	Grv SD14	SD
2558	Grv SD15	SD
2559	Grv SD16	SD
2560	Grv SD17	SD
2561	Grv Rim1	SD
2562	Grv Rim2	SD
2563	Grv Rim3	SD
2564	Grv Rim4	SD
2565	Grv Rim5	SD
2566	Grv Rim6	SD
2567	Grv HH Closed1	HH
2568	Grv HH Closed2	HH
2569	Grv HH Closed3	HH
2570	Grv HH Closed4	HH
2571	Grv HH Closed5	HH
2572	Grv HH Closed6	HH
2573	Grv HH Closed7	HH
2574	Grv HH Closed8	HH

#	Drum Sample	DF
2575	Grv HH Closed9	HH
2576	Grv HH Closed10	HH
2577	Grv HH Closed11	HH
2578	Grv HH Closed12	HH
2579	Grv HH Closed13	HH
2580	Grv HH Closed14	HH
2581	Grv HH Closed15	HH
2582	Grv HH Closed16	HH
2583	Grv HH Closed17	HH
2584	Grv HH Open1	HH
2585	Grv HH Open2	HH
2586	Grv HH Open3	HH
2587	Grv HH Open4	HH
2588	Grv Hi Tom1	Tm
2589	Grv Hi Tom2	Tm
2590	Grv Low Tom1	Tm
2591	Grv Low Tom2	Tm
2592	Grv Ride	Cy
2593	Grv Crash1	Cy
2594	Grv Crash2	Cy
2595	Grv Claps1	LP
2596	Grv Claps2	LP
2597	Grv Claps3	LP
2598	Grv Claps4	LP
2599	Grv Claps5	LP
2600	Grv Claps6	LP
2601	Grv Claps7	LP
2602	Grv Claps8	LP
2603	Grv Claps9	LP
2604	Grv Claps10	LP
2605	Grv Fx1	SFX
2606	Grv Fx2	SFX
2607	Grv Fx3	SFX
2608	Grv Fx4	SFX

#	Drum Sample	DF
2609	Grv Fx5	SFX
2610	Grv Fx6	SFX
2611	Grv Fx7	SFX
2612	Grv Fx8	SFX
2613	Grv Fx9	SFX
2614	Grv Fx10	SFX
2615	Grv Fx11	SFX
2616	Grv Fx12	SFX
2617	Grv Fx13	SFX
2618	Grv Fx14	SFX
2619	Grv Fx15	SFX
2620	Grv Fx16	SFX
2621	Grv Fx17	SFX
2622	Grv Fx18	SFX
2623	Grv Fx19	SFX
2624	Grv Fx20	SFX
2625	Grv Fx21	SFX
2626	Grv Fx22	SFX
2627	Grv Fx23	SFX
2628	Grv Fx24	SFX
2629	Grv Fx25	SFX
2630	Grv Fx26	SFX
2631	Grv Fx27	SFX
2632	Grv Fx28	SFX
2633	Grv Fx29	SFX
2634	Grv Fx30	SFX
2635	Grv Fx31	SFX
2636	Grv Fx32	SFX
2637	Grv Fx33	SFX
2638	Grv Fx34	SFX
2639	Grv Fx35	SFX
2640	Grv Slice1	SFX
2641	Grv Slice2	SFX
2642	Grv Slice3	SFX

#	Drum Sample	DF
2643	Grv Slice4	SFX
2644	Grv Slice5	SFX
2645	Grv Slice6	SFX
2646	Grv Slice7	SFX
2647	Grv Slice8	SFX
2648	Grv Slice9	SFX
2649	Grv Slice10	SFX
2650	Grv Slice11	SFX
2651	Grv Slice12	SFX
2652	Grv Slice13	SFX
2653	Grv Slice14	SFX
2654	Grv Slice15	SFX
2655	Grv Slice16	SFX
2656	Grv Slice17	SFX
2657	Grv Slice18	SFX
2658	Grv Slice19	SFX
2659	Grv Slice20	SFX
2660	Grv Slice21	SFX
2661	Grv Slice22	SFX
2662	Grv Slice23	SFX
2663	55 BD	BD
2664	55 Claps	LP
2665	55 CongaHi	LP
2666	55 CongaLow	LP
2667	55 Cowbell Hi	HP
2668	55 Cowbell Low	HP
2669	55 Crash	Cy
2670	55 HH Close	HH
2671	55 HH Open	HH
2672	55 Ride	Cy
2673	55 Rim	SD
2674	55 SD	SD
2675	55 Timbales Hi	LP
2676	55 Tom Hi	Tm

#	Drum Sample	DF
2677	55 Tom Mid	Tm
2678	55 Tom Low	Tm
2679	66 BD	BD
2680	66 SD	SD
2681	66 HH Close	HH
2682	66 HH Open	HH
2683	66 Tom	Tm
2684	66 Congas	LP
2685	66 Cymbal	Cy
2686	66 Cowbell	HP
2687	78 BD	BD
2688	78 SD1	SD
2689	78 SD2	SD
2690	78 HH Cl1	HH
2691	78 HH Cl2	HH
2692	78 HH Open	HH
2693	78 Tom	Tm
2694	78 Cymbal	Cy
2695	78 Bongos	LP
2696	78 Congas	LP
2697	78 Claves	LP
2698	88 BD1	BD
2699	88 BD2	BD
2700	88 BD Long	BD
2701	88 SD1	SD
2702	88 SD2	SD
2703	88 SD2 GM	SD
2704	88 SD3	SD
2705	88 SD3 GM	SD
2706	88 RIM Shot1	SD
2707	88 Rim Shot2	SD
2708	88 Rim Shot2 GM	SD
2709	88 HH Close1	HH
2710	88 HH Close1 acc	HH

#	Drum Sample	DF
2711	88 HH Close1 acc GM	HH
2712	88 HH Close2	HH
2713	88 HH Close2 GM	HH
2714	88 HH Open1	HH
2715	88 HH Open1 GM	HH
2716	88 HH Open2	HH
2717	88 Tom1	Tm
2718	88 Tom2	Tm
2719	88 Cymbal	Cy
2720	88 Cymbal Acc1	Cy
2721	88 Cymbal Acc2	Cy
2722	88 Crash	Cy
2723	88 Crash GM	Cy
2724	88 Bongos	LP
2725	88 Congas1	LP
2726	88 Congas2	LP
2727	88 Claps1	LP
2728	88 Claps2	LP
2729	88 Claves	LP
2730	88 Cowbell	HP
2731	88 Maracas	HP
2732	99 BD1	BD
2733	99 BD2	BD
2734	99 BD3	BD
2735	99 SD1	SD
2736	99 SD2	SD
2737	99 SD3	SD
2738	99 RIM Shot	SD
2739	99 HH Close1	HH
2740	99 HH Close2	HH
2741	99 HH Close3	HH
2742	99 HH Open1	HH
2743	99 HH Open2	HH
2744	99 HH Open3	HH

#	Drum Sample	DF
2745	99 Tom Hi	Tm
2746	99 Tom Mid	Tm
2747	99 Tom Low	Tm
2748	99 Claps	LP
2749	99 Guiro1	LP
2750	99 Guiro2	LP
2751	99 Ride	Cy
2752	99 Ride Dance	Cy
2753	99 Crash1	Cy
2754	99 Crash2	Cy
2755	99 Crash3	Cy
2756	99 Cabasa	HP
2757	99 Bongo Hi	LP
2758	99 Bongo Low	LP
2759	99 Agogo Hi	HP
2760	99 Agogo Low	HP
2761	99 Conga Hi	LP
2762	99 Conga Mid	LP
2763	99 Conga Low	LP
2764	99 WoodBlock	LP
2765	99 Timbale Hi	LP
2766	99 Timbale Mid	LP
2767	99 Metal	HP
2768	Click	SFX
2769	Click GM	SFX
2770	Seq Click	SFX
2771	Metronome W Bell	SFX
2772	Metronome W	SFX
2773	BR_Agg2Bc1grv1	HP
2774	BR_Agg2Bc1grv2	HP
2775	BR_Agg2Bc1grv3	HP
2776	BR_Agg2Bc1grv4	HP
2777	BR_Agg2Bc1grv5	HP
2778	BR_Agg2Bc2agu1	HP

#	Drum Sample	DF
2779	BR_Agg2Bc2agu2	HP
2780	BR_Agg2Bc2agu3	HP
2781	BR_Agg2Bc2agu4	HP
2782	BR_Agg2Bc2agu5	HP
2783	BR_Agg4Bc1grv1lp	HP
2784	BR_Agg4Bc1grv2lp	HP
2785	BR_Agg4Bc1grv3lp	HP
2786	BR_Agg4Bc1grv4lp	HP
2787	BR_Agg4Bc1grv5lp	HP
2788	BR_Agg4Bc4agu1lp	HP
2789	BR_Agg4Bc4agu2lp	HP
2790	BR_Agg4Bc4agu3lp	HP
2791	BR_Agg4Bc4agu4lp	HP
2792	BR_Agg4Bc4agu5lp	HP
2793	BR_Agg4Bc21lp	HP
2794	BR_Agg4Bc22lp	HP
2795	BR_Agg4Bc23lp	HP
2796	BR_Agg4Bc24lp	HP
2797	BR_Agg4Bc25lp	HP
2798	BR_Agg4Bc31lp	HP
2799	BR_Agg4Bc32lp	HP
2800	BR_Agg4Bc33lp	HP
2801	BR_Agg4Bc34lp	HP
2802	BR_Agg4Bc35lp	HP
2803	BR_AggMad1grv1	HP
2804	BR_AggMad1grv2	HP
2805	BR_AggMad1grv3	HP
2806	BR_AggMad1grv4	HP
2807	BR_AggMad1grv5	HP
2808	BR_AggMad2agu1	HP
2809	BR_AggMad2agu2	HP
2810	BR_AggMad2agu3	HP
2811	BR_AggMad2agu4	HP
2812	BR_AggMad2agu5	HP

#	Drum Sample	DF
2813	BR_AlfaiaBqt1	LP
2814	BR_AlfaiaBqt2	LP
2815	BR_AlfaiaBqt3	LP
2816	BR_AlfaiaBqt4	LP
2817	BR_AlfaiaCl1	LP
2818	BR_AlfaiaCl2	LP
2819	BR_AlfaiaCl3	LP
2820	BR_AlfaiaCl4	LP
2821	BR_AlfaiaOp1	LP
2822	BR_AlfaiaOp2	LP
2823	BR_AlfaiaOp3	LP
2824	BR_AlfaiaOp4	LP
2825	BR_ApitoA	HP
2826	BR_ApitoB	HP
2827	BR_ApitoC	HP
2828	BR_CaxixiAAnsw_f	HP
2829	BR_CaxixiAAnsw_p	HP
2830	BR_CaxixiAQues_f	HP
2831	BR_CaxixiAQues_p	HP
2832	BR_CaxixiBAnsw_f	HP
2833	BR_CaxixiBAnsw_p	HP
2834	BR_CaxixiBQues_f	HP
2835	BR_CaxixiBQues_p	HP
2836	BR_ChocalhoAnsw	HP
2837	BR_ChocalhoQues	HP
2838	BR_CuicaAgu1	LP
2839	BR_CuicaAgu2	LP
2840	BR_CuicaAgu3	LP
2841	BR_CuicaGrvA1	LP
2842	BR_CuicaGrvA2	LP
2843	BR_CuicaGrvA3	LP
2844	BR_CuicaGrvB1	LP
2845	BR_CuicaGrvB2	LP
2846	BR_CuicaGrvB3	LP

#	Drum Sample	DF
2847	BR_CuicaGrvC1	LP
2848	BR_CuicaGrvC2	LP
2849	BR_CuicaGrvC3	LP
2850	BR_CuicaMedA1	LP
2851	BR_CuicaMedA2	LP
2852	BR_CuicaMedA3	LP
2853	BR_CuicaMedB1	LP
2854	BR_CuicaMedB2	LP
2855	BR_CuicaMedB3	LP
2856	BR_FrigidBorda1	HP
2857	BR_FrigidBorda2	HP
2858	BR_FrigidBorda3	HP
2859	BR_FrigidBorda4	HP
2860	BR_FrigidCentro1	HP
2861	BR_FrigidCentro2	HP
2862	BR_FrigidCentro3	HP
2863	BR_FrigidCentro4	HP
2864	BR_GanzaAnsw_f	HP
2865	BR_GanzaAnsw_p	HP
2866	BR_GanzaQues_f	HP
2867	BR_GanzaQues_p	HP
2868	BR_Gongue1	HP
2869	BR_Gongue2	HP
2870	BR_Gongue3	HP
2871	BR_Gongue4	HP
2872	BR_Gongue5	HP
2873	BR_MatchbFng1	LP
2874	BR_MatchbFng2	LP
2875	BR_MatchbFng3	LP
2876	BR_MatchbFng4	LP
2877	BR_PndCocoCls1	LP
2878	BR_PndCocoCls2	LP
2879	BR_PndCocoCls3	LP
2880	BR_PndCocoCls4	LP

#	Drum Sample	DF
2881	BR_PndCocoCls5	LP
2882	BR_PndCocoDeepMt1	LP
2883	BR_PndCocoDeepMt2	LP
2884	BR_PndCocoDeepMt3	LP
2885	BR_PndCocoDeepMt4	LP
2886	BR_PndCocoDeepMt5	LP
2887	BR_PndCocoOpn1	LP
2888	BR_PndCocoOpn2	LP
2889	BR_PndCocoOpn3	LP
2890	BR_PndCocoOpn4	LP
2891	BR_PndCocoPlt1	LP
2892	BR_PndCocoPlt2	LP
2893	BR_PndCocoPlt3	LP
2894	BR_PndCocoPlt4	LP
2895	BR_PndCocoPlt5	LP
2896	BR_PndCocoRuloLong	LP
2897	BR_PndCocoRuloShort	LP
2898	BR_PndCocoSlap1	LP
2899	BR_PndCocoSlap2	LP
2900	BR_PndCocoSlap3	LP
2901	BR_PndCouroCls1	LP
2902	BR_PndCouroCls2	LP
2903	BR_PndCouroCls3	LP
2904	BR_PndCouroCls4	LP
2905	BR_PndCouroCls5	LP
2906	BR_PndCouroDeepMt1	LP
2907	BR_PndCouroDeepMt2	LP
2908	BR_PndCouroDeepMt3	LP
2909	BR_PndCouroDeepMt4	LP
2910	BR_PndCouroOpn1	LP
2911	BR_PndCouroOpn2	LP
2912	BR_PndCouroOpn3	LP
2913	BR_PndCouroOpn4	LP
2914	BR_PndCouroPlt1	LP

#	Drum Sample	DF
2915	BR_PndCouroPlt2	LP
2916	BR_PndCouroPlt3	LP
2917	BR_PndCouroPlt4	LP
2918	BR_PndCouroPlt5	LP
2919	BR_PndCouroPltOnly1	LP
2920	BR_PndCouroPltOnly2	LP
2921	BR_PndCouroRuloLong	LP
2922	BR_PndCouroRuloMedium	LP
2923	BR_PndCouroRuloShort	LP
2924	BR_PndCouroSlap1	LP
2925	BR_PndCouroSlap2	LP
2926	BR_PndCouroSlap3	LP
2927	BR_PndCouroSlap4	LP
2928	BR_PndNylonCls1	LP
2929	BR_PndNylonCls2	LP
2930	BR_PndNylonCls3	LP
2931	BR_PndNylonCls4	LP
2932	BR_PndNylonCls5	LP
2933	BR_PndNylonOpn1	LP
2934	BR_PndNylonOpn2	LP
2935	BR_PndNylonOpn3	LP
2936	BR_PndNylonOpn4	LP
2937	BR_PndNylonOpn5	LP
2938	BR_PndNylonPlt1	LP
2939	BR_PndNylonPlt2	LP
2940	BR_PndNylonPlt3	LP
2941	BR_PndNylonPlt4	LP
2942	BR_PndNylonPlt5	LP
2943	BR_PndNylonRuloLong	LP
2944	BR_PndNylonRuloMedium	LP
2945	BR_PndNylonRuloShort	LP
2946	BR_PndNylonSlap1	LP
2947	BR_PndNylonSlap2	LP
2948	BR_PndNylonSlap3	LP

#	Drum Sample	DF
2949	BR_PndNylonSlap4	LP
2950	BR_PndNylonSlap5	LP
2951	BR_PndTradCls1	LP
2952	BR_PndTradCls2	LP
2953	BR_PndTradCls3	LP
2954	BR_PndTradCls4	LP
2955	BR_PndTradCls5	LP
2956	BR_PndTradOpn1	LP
2957	BR_PndTradOpn2	LP
2958	BR_PndTradOpn3	LP
2959	BR_PndTradOpn4	LP
2960	BR_PndTradOpn5	LP
2961	BR_PndTradPlat1	LP
2962	BR_PndTradPlat2	LP
2963	BR_PndTradPlat3	LP
2964	BR_PndTradPlat4	LP
2965	BR_PndTradPlat5	LP
2966	BR_PndTradRuloLong	LP
2967	BR_PndTradRuloShort	LP
2968	BR_PndTradSlap1	LP
2969	BR_PndTradSlap2	LP
2970	BR_PndTradSlap3	LP
2971	BR_PndTradSlap4	LP
2972	BR_PratoHit1	HP
2973	BR_PratoHit2	HP
2974	BR_PratoHit3	HP
2975	BR_PratoSlide1	HP
2976	BR_PratoSlide2	HP
2977	BR_PratoSlide3	HP
2978	BR_RecoHitA1	HP
2979	BR_RecoHitA2	HP
2980	BR_RecoHitA3	HP
2981	BR_RecoHitA4	HP
2982	BR_RecoHitA5	HP

#	Drum Sample	DF
2983	BR_RecoHitB1	HP
2984	BR_RecoHitB2	HP
2985	BR_RecoHitB3	HP
2986	BR_RecoHitB4	HP
2987	BR_RecoHitB5	HP
2988	BR_RecoSlideA1	HP
2989	BR_RecoSlideA2	HP
2990	BR_RecoSlideA3	HP
2991	BR_RecoSlideA4	HP
2992	BR_RecoSlideA5	HP
2993	BR_RecoSlideB1	HP
2994	BR_RecoSlideB2	HP
2995	BR_RecoSlideB3	HP
2996	BR_RecoSlideB4	HP
2997	BR_RecoSlideB5	HP
2998	BR_RecoSlideLn1	HP
2999	BR_RecoSlideLn2	HP
3000	BR_RecoSlideMd1	HP
3001	BR_RecoSlideMd2	HP
3002	BR_RecoSlideMd3	HP
3003	BR_RecoSlideMd4	HP
3004	BR_RecoSlideMd5	HP
3005	BR_RpnqMtMad1	LP
3006	BR_RpnqMtMad2	LP
3007	BR_RpnqMtMad3	LP
3008	BR_RpnqMtMad4	LP
3009	BR_RpnqMtNyl1	LP
3010	BR_RpnqMtNyl2	LP
3011	BR_RpnqMtNyl3	LP
3012	BR_RpnqMtNyl4	LP
3013	BR_RpnqMtVim1	LP
3014	BR_RpnqMtVim2	LP
3015	BR_RpnqMtVim3	LP
3016	BR_RpnqMtVim4	LP

#	Drum Sample	DF
3017	BR_RpnqRimMad1	LP
3018	BR_RpnqRimMad2	LP
3019	BR_RpnqRimMad3	LP
3020	BR_RpnqRimMad4	LP
3021	BR_RpnqRimNyl1	LP
3022	BR_RpnqRimNyl2	LP
3023	BR_RpnqRimNyl3	LP
3024	BR_RpnqRimNyl4	LP
3025	BR_RpnqRimVim1	LP
3026	BR_RpnqRimVim2	LP
3027	BR_RpnqRimVim3	LP
3028	BR_RpnqRimVim4	LP
3029	BR_RpqAnelHndMt1	LP
3030	BR_RpqAnelHndMt2	LP
3031	BR_RpqAnelHndMt3	LP
3032	BR_RpqAnelHndMt4	LP
3033	BR_RpqAnelOpn1	LP
3034	BR_RpqAnelOpn2	LP
3035	BR_RpqAnelOpn3	LP
3036	BR_RpqAnelOpn4	LP
3037	BR_RpqAnelRpq1	LP
3038	BR_RpqAnelRpq2	LP
3039	BR_RpqAnelRpq3	LP
3040	BR_RpqAnelRpq4	LP
3041	BR_SmbSnr1Opn1	SD
3042	BR_SmbSnr1Opn2	SD
3043	BR_SmbSnr1Opn3	SD
3044	BR_SmbSnr1Opn4	SD
3045	BR_SmbSnr1Rim1	SD
3046	BR_SmbSnr1Rim2	SD
3047	BR_SmbSnr1Rim3	SD
3048	BR_SmbSnr1Rim4	SD
3049	BR_SmbSnr1RII1	SD
3050	BR_SmbSnr1RII2	SD

#	Drum Sample	DF
3051	BR_SmbSnr1RII3	SD
3052	BR_SmbSnr1RII4	SD
3053	BR_SmbSnr2Opn1	SD
3054	BR_SmbSnr2Opn2	SD
3055	BR_SmbSnr2Opn3	SD
3056	BR_SmbSnr2Opn4	SD
3057	BR_SmbSnr2Rim1	SD
3058	BR_SmbSnr2Rim2	SD
3059	BR_SmbSnr2Rim3	SD
3060	BR_SmbSnr2Rim4	SD
3061	BR_SmbSnr2RII1	SD
3062	BR_SmbSnr2RII2	SD
3063	BR_SmbSnr2RII3	SD
3064	BR_SmbSnr2RII4	SD
3065	BR_SmbSnr3Opn1	SD
3066	BR_SmbSnr3Opn2	SD
3067	BR_SmbSnr3Opn3	SD
3068	BR_SmbSnr3Opn4	SD
3069	BR_SmbSnr3Rim1	SD
3070	BR_SmbSnr3Rim2	SD
3071	BR_SmbSnr3Rim3	SD
3072	BR_SmbSnr3Rim4	SD
3073	BR_SmbSnr3RII1	SD
3074	BR_SmbSnr3RII2	SD
3075	BR_SmbSnr3RII3	SD
3076	BR_SmbSnr3RII4	SD
3077	BR_SrdPriHandMt1	LP
3078	BR_SrdPriHandMt2	LP
3079	BR_SrdPriHandMt3	LP
3080	BR_SrdPriHandMt4	LP
3081	BR_SrdPriMt1	LP
3082	BR_SrdPriMt2	LP
3083	BR_SrdPriMt3	LP
3084	BR_SrdPriMt4	LP

#	Drum Sample	DF
3085	BR_SrdPriMtBqtCl1	LP
3086	BR_SrdPriMtBqtCl2	LP
3087	BR_SrdPriMtBqtCl3	LP
3088	BR_SrdPriMtBqtCl4	LP
3089	BR_SrdPriOp1	LP
3090	BR_SrdPriOp2	LP
3091	BR_SrdPriOp3	LP
3092	BR_SrdPriOp4	LP
3093	BR_SrdQuaCl1	LP
3094	BR_SrdQuaCl2	LP
3095	BR_SrdQuaCl3	LP
3096	BR_SrdQuaCl4	LP
3097	BR_SrdQuaHandMt1	LP
3098	BR_SrdQuaHandMt2	LP
3099	BR_SrdQuaHandMt3	LP
3100	BR_SrdQuaHandMt4	LP
3101	BR_SrdQuaOp1	LP
3102	BR_SrdQuaOp2	LP
3103	BR_SrdQuaOp3	LP
3104	BR_SrdQuaOp4	LP
3105	BR_SrdSegHandMt1	LP
3106	BR_SrdSegHandMt2	LP
3107	BR_SrdSegHandMt3	LP
3108	BR_SrdSegHandMt4	LP
3109	BR_SrdSegMtBqtCl1	LP
3110	BR_SrdSegMtBqtCl2	LP
3111	BR_SrdSegMtBqtCl3	LP
3112	BR_SrdSegMtBqtCl4	LP
3113	BR_SrdSegOp1	LP
3114	BR_SrdSegOp2	LP
3115	BR_SrdSegOp3	LP
3116	BR_SrdSegOp4	LP
3117	BR_SrdTerHandMt1	LP
3118	BR_SrdTerHandMt2	LP

#	Drum Sample	DF
3119	BR_SrdTerHandMt3	LP
3120	BR_SrdTerHandMt4	LP
3121	BR_SrdTerMtBqtCl1	LP
3122	BR_SrdTerMtBqtCl2	LP
3123	BR_SrdTerMtBqtCl3	LP
3124	BR_SrdTerMtBqtCl4	LP
3125	BR_SrdTerOp1	LP
3126	BR_SrdTerOp2	LP
3127	BR_SrdTerOp3	LP
3128	BR_SrdTerOp4	LP
3129	BR_Tamborica1	LP
3130	BR_Tamborica2	LP
3131	BR_Tamborica3	LP
3132	BR_Tamborica4	LP
3133	BR_TamzaoFngMt1	LP
3134	BR_TamzaoFngMt2	LP
3135	BR_TamzaoFngMt3	LP
3136	BR_TamzaoFngMt4	LP
3137	BR_TamzaoFngMt5	LP
3138	BR_TamzaoHndMt1	LP
3139	BR_TamzaoHndMt2	LP
3140	BR_TamzaoHndMt3	LP
3141	BR_TamzaoHndMt4	LP
3142	BR_TamzaoHndMt5	LP
3143	BR_TamzaoLatat1	LP
3144	BR_TamzaoLatat2	LP
3145	BR_TamzaoLatat3	LP
3146	BR_TamzaoLatat4	LP
3147	BR_TamzaoLatat5	LP
3148	BR_TamzaoOpenA1	LP
3149	BR_TamzaoOpenA2	LP
3150	BR_TamzaoOpenA3	LP
3151	BR_TamzaoOpenA4	LP
3152	BR_TamzaoOpenA5	LP

#	Drum Sample	DF
3153	BR_TamzinHndMt1	LP
3154	BR_TamzinHndMt2	LP
3155	BR_TamzinHndMt3	LP
3156	BR_TamzinHndMt4	LP
3157	BR_TamzinHndSlp1	LP
3158	BR_TamzinHndSlp2	LP
3159	BR_TamzinHndSlp3	LP
3160	BR_TamzinHndSlp4	LP
3161	BR_TamzinOpen1	LP
3162	BR_TamzinOpen2	LP
3163	BR_TamzinOpen3	LP
3164	BR_TamzinOpen4	LP
3165	BR_TamzinShell1	LP
3166	BR_TamzinShell2	LP
3167	BR_TamzinShell3	LP
3168	BR_TamzinShell4	LP
3169	BR_TimbaHiMaoFec1	LP
3170	BR_TimbaHiMaoFec2	LP
3171	BR_TimbaHiMaoFec3	LP
3172	BR_TimbaHiMaoFec4	LP
3173	BR_TimbaHiVas1	LP
3174	BR_TimbaHiVas2	LP
3175	BR_TimbaHiVas3	LP
3176	BR_TimbaHiVas4	LP
3177	BR_TimbaLoFng1	LP
3178	BR_TimbaLoFng2	LP
3179	BR_TimbaLoFng3	LP
3180	BR_TimbaLoFng4	LP

#	Drum Sample	DF
3181	BR_TimbaLoOpn1	LP
3182	BR_TimbaLoOpn2	LP
3183	BR_TimbaLoOpn3	LP
3184	BR_TimbaLoOpn4	LP
3185	BR_TimbauLoBs	LP
3186	BR_TimbauToBs1	LP
3187	BR_TimbauToBs2	LP
3188	BR_TimbauToBs3	LP
3189	BR_TimbauToOpFlm1	LP
3190	BR_TimbauToOpFlm2	LP
3191	BR_TimbauToOpFlm3	LP
3192	BR_TmbUpstr1	LP
3193	BR_TmbUpstr2	LP
3194	BR_TmbUpstr3	LP
3195	BR_TmbUpstr4	LP
3196	BR_TmbUpstr5	LP
3197	BR_TrianguloCl1	HP
3198	BR_TrianguloCl2	HP
3199	BR_TrianguloCl3	HP
3200	BR_TrianguloOp1lp	HP
3201	BR_TrianguloOp2lp	HP
3202	BR_TrianguloOp3lp	HP
3203	BR_WdTmbDmpFng1	LP
3204	BR_WdTmbDmpFng2	LP
3205	BR_WdTmbDmpFng3	LP
3206	BR_WdTmbDmpFng4	LP
3207	BR_WdTmbDmpFng5	LP
3208	BR_WdTmbOpnA1	LP

#	Drum Sample	DF
3209	BR_WdTmbOpnA2	LP
3210	BR_WdTmbOpnA3	LP
3211	BR_WdTmbOpnA4	LP
3212	BR_WdTmbOpnB1	LP
3213	BR_WdTmbOpnB2	LP
3214	BR_WdTmbOpnB3	LP
3215	BR_WdTmbOpnB4	LP
3216	BR_WdTmbRm1	LP
3217	BR_WdTmbRm2	LP
3218	BR_WdTmbRm3	LP
3219	BR_WdTmbRm4	LP
3220	BR_ZabuBotBacCl1	LP
3221	BR_ZabuBotBacCl2	LP
3222	BR_ZabuBotBacCl3	LP
3223	BR_ZabuBotBacCl4	LP
3224	BR_ZabuBotCl1	LP
3225	BR_ZabuBotCl2	LP
3226	BR_ZabuBotCl3	LP
3227	BR_ZabuBotCl4	LP
3228	BR_ZabuBotGrvOp1	LP
3229	BR_ZabuBotGrvOp2	LP
3230	BR_ZabuBotGrvOp3	LP
3231	BR_ZabuBotGrvOp4	LP
3232	BR_ZabuTopBacCl1	LP
3233	BR_ZabuTopBacCl2	LP
3234	BR_ZabuTopBacCl3	LP
3235	BR_ZabuTopBacCl4	LP
3236	BR_ZabuTopCl1	LP

#	Drum Sample	DF
3237	BR_ZabuTopCl2	LP
3238	BR_ZabuTopCl3	LP
3239	BR_ZabuTopCl4	LP
3240	BR_ZabuTopGrvOp1	LP
3241	BR_ZabuTopGrvOp2	LP
3242	BR_ZabuTopGrvOp3	LP

#	Drum Sample	DF
3243	BR_ZabuTopGrvOp4	LP
3244	BR_ZabuTopOp1	LP
3245	BR_ZabuTopOp2	LP
3246	BR_ZabuTopOp3	LP
3247	BR_ZabuTopOp4	LP
3248	Empty	

Legend:

BD = Bass Drum

SD = Snare Drum

Tm = Tom

HH = Hi Hat

Cy = Cymbal

LP = Low Percussion

HP = Hi Percussion

SFX = Special FX

Pads

The following table contains all the Factory Pads.

#	Pad
	HIT - Drum
1	88 Cowbell
2	88 Crash
3	China
4	Crash 1
5	Crash 2
6	Rev. Cymbal
7	Ride 1
8	Ride 2
9	Ride Bell
10	Splash
11	Sticks
12	Rim-Shot
13	Hi Tom Flam
14	Mid Tom Flam
15	Low Tom Flam
16	Tom Flam End
17	Drum Single A
18	Drum Single B
19	Drum Single C
20	Drum Single D
21	Drum Sing.HouseA
22	Drum Sing.HouseB
23	Drum Sing.HouseC
24	Drum Sing.HouseD
25	Drum Kit A
26	Drum Kit B
27	Drum Kit C
28	Drum Kit D
29	Drum Kit E
30	Drum Kit F

#	Pad
	HIT - Percussion
1	Agogo 1
2	Agogo 2
3	Castanet 1
4	Castanet 2
5	Conga Hi
6	Conga Low
7	Conga Mute
8	Conga Slap
9	Cowbell
10	Cuica 1
11	Cuica 2
12	Jingle Bell
13	Long Guiro
14	Short Guiro
15	Open Bells
16	Rain Stick
17	Tamb. Acc. 1
18	Tamb. Acc. 2
19	Tamb. Open
20	Tamb. Push
21	Timbale Hi
22	Timbale Low
23	Timbale Rim 1
24	Timbale Rim 2
25	Triangle 1
26	Triangle 2
27	Vibra Slap
28	Whistle 1
29	Whistle 2
30	Windchimes 1

#	Pad
31	Windchimes 2
32	Windchimes 3
	HIT - World 1
1	Baja 1
2	Baja 2
3	China Gong
4	Darbuka 1
5	Darbuka 2
6	Darbuka 3
7	Darbuka 4
8	Darbuka 5
9	Darbuka 6
10	Darbuka 7
11	Darbuka 8
12	Davul
13	Douf Rim Ak
14	Dragon Gong
15	Hollo 1
16	Hollo 2
	Hit - World 2
1	Kup 1
2	Kup 2
3	Kup 3
4	Kup 4
5	Ramazan 1
6	Ramazan 2
7	Ramazan 3
8	Rek Dom Ak
9	Rik 1
10	Rik 2
11	Rik 3

#	Pad
12	Sagat 1
13	Sagat 2
14	Tef 1
15	Tef 2
16	Tef 3
17	Tef 4
18	Tef 5
19	Tef 6
HIT - Orchestral	
1	Brass Fall
2	Orch.Cymbal 1
3	Orch.Cymbal 2
4	Orch. Hit
5	Orch. Snare
6	Orch. Sn. Roll
7	Timpani 1
8	Timpani 2
9	Timpani 3
10	Timpani 4
11	Orchestra Tutti
HIT - Synth&Pad	
1	Cosmic
2	VCF Modulation
3	Planet Lead
4	Brightness
5	Crystal
6	New Age Pad
7	Fifths Lead
8	Calliope
9	Caribbean
10	Rezbo
11	Digital Polisix
12	Motion Raver
13	Moving Bell

#	Pad
14	Elastick Pad
15	Rave
16	Dance Remix
17	Vintage Sweep
18	You Decide
HIT - Voice	
1	Aah !
2	Hit it !
3	Laughing
4	Scream
5	Uuh !
6	Yeah ! 1
7	Yeah ! 2
HIT - Blocks	
1	Blk Funk 1 A
2	Blk Funk 1 B
3	Blk Funk 1 C
4	Blk Funk 1 D
5	Blk Funk 2 A
6	Blk Funk 2 B
7	Blk Funk 2 C
8	Blk Funk 2 D
9	Blk Organ A
10	Blk Organ B
11	Blk Organ C
12	Blk Organ D
13	Blk Choir A
14	Blk Choir B
15	Blk Choir C
16	Blk Choir D
HIT - Misc&SFX 1	
1	Applause
2	Bird 1
3	Bird 2

#	Pad
4	Cat
5	Church Bell
6	Crickets
7	Dist. Slide 1
8	Dist. Slide 2
9	Dog
10	Door Creak
11	Door Slam
12	Foosteps 1
13	Foosteps 2
14	Heart Beat
15	Horse Gallop
16	Lion
17	Scratch 1
18	Scratch 2
19	Scratch 3
20	Scratch 4
21	Scratch 5
22	Scratch 6
23	Stadium
HIT - Misc&SFX 2	
1	Bubble
2	Car Crash
3	Car Engine
4	Car Pass
5	Car Stop
6	Explosion
7	Gun Shot
8	Helicopter
9	Jet Plane
10	Laser Gun
11	Machine Gun
12	Phone Ring
13	Punch

#	Pad
14	River
15	Seashore
16	Siren
17	Starship
18	Thunder
19	Train
20	Wind
SEQ - Drum	
1	Drum DrumBasSolo
2	Drum Snare Solo
3	Drum 8 Bt Easy
4	Drum 8 Bt Medium
5	Drum Rock 1
6	Drum Rock 2
7	Drum Brush 1 3/4
8	Drum Brush 2 3/4
9	Drum Disco 1
10	Drum Disco 2
11	Drum Disco 3
12	Drum Disco 4
13	Drum Funk 1
14	Drum Funk 2
15	Drum Brush Shuff
16	Drum Latin
17	Drum Progressiv1
18	Drum Progressiv2
19	Drum Fill 1
20	Drum Fill 2
21	Drum Break
22	Drum End
SEQ - Percussion	
1	Perc FingerSnap
2	Perc Triang.+HH
3	Perc Latin 1

#	Pad
4	Perc Latin 2
5	Perc Latin 3
6	Perc Mix
7	Perc Soft
8	Perc Conga
9	Perc Conga+Ride
10	Perc Conga+Mix
11	Perc Conga+Bongo
12	Perc Conga+Tamb.
13	Perc Shaker
14	Perc Shak+Tamb 1
15	Perc Shak+Tamb 2
16	Perc Shak+Cong 1
17	Perc Shak+Cong 2
18	Perc Tambourine1
19	Perc Tambourine2
20	Perc Tamb+Congal
21	Perc Tamb+Conga2
22	Perc Guiro+Bongo
23	Perc Cowbel+Tamb
24	Perc 3/4
25	Perc 6/8
SEQ - Groove	
1	Grv Drum 1
2	Grv Drum 2
3	Grv Brush
4	Grv Jazzy
5	Grv Latin
6	Grv HipHop 1
7	Grv HipHop 2
8	Grv HipHop 3
9	Grv HipHop 4
10	Grv HipHop 5
11	Grv HipHop 6

#	Pad
12	Grv Funk 1
13	Grv Funk 2
14	Grv Funk 3
15	Grv House 1
16	Grv House 2
17	Grv Analog
18	Grv Garage 1
19	Grv Garage 2
20	Grv Dance 1
21	Grv Dance 2
22	Grv Techno 1
23	Grv Techno 2
SEQ - Bass	
1	Bass Pick Easy
2	Bass Pick Med.
3	Bass Pick Busy
4	Bass Finger Easy
5	Bass Finger Med.
6	Bass Finger Walk
7	Bass Latin
8	Bass Slap
9	Bass Digital
10	Bass Synth
11	Bass DigiFilter1
12	Bass DigiFilter2
13	Bass DigiFilter3
SEQ - Piano	
1	Piano Accomp 1
2	Piano Accomp 2
3	Piano Accomp 3
4	Piano Accomp 4
5	Piano Accomp 5
6	Piano Accomp 6
7	Piano Accomp 7

#	Pad
8	Piano Accomp 8
9	Piano Accomp 9
10	Piano Arpeg. 1
11	Piano Arpeg. 2
12	Piano Arp 1 3/4
13	Piano Arp 2 3/4
14	Piano Arp Down
15	Piano Arp Up
16	Piano Rhythm 1/8
17	Piano Rhythm1/8T
18	Piano Latin Rock
19	Piano Salsa 1
20	Piano Salsa 2
21	Pno GlissDwnWhit
22	Pno GlissUpWhite
23	Pno GlissDwnBlak
24	Pno GlissUpBlack
25	Honky End
SEQ - Guitar	
1	Gtr Steel Strum1
2	Gtr Steel Strum2
3	Gtr Steel Strum3
4	Gtr Steel Strum4
5	Gtr Steel Strum5
6	Gtr Steel Strum6
7	GtSteelStrum 3/4
8	Gtr Steel Arp 1
9	Gtr Steel Arp 2
10	Gtr Steel Arp 3
11	GtrSteel Arp 6/8
12	Gtr Steel Mute 1
13	Gtr Steel Mute 2
14	Guitar Country
15	Gtr Nylon Strum1

#	Pad
16	Gtr Nylon Strum2
17	Gtr Nylon Strum3
18	Gtr Nylon Strum4
19	Gtr Nylon Strum5
20	Gtr Nylon Strum6
21	Gtr Nylon Arp 1
22	Gtr Nylon Arp 2
23	Gtr Nylon Arp 3
24	GtrNylon Arp 3/4
SEQ - Orchestral	
1	Timpani Roll 1
2	Timpani Roll 2
3	Orch. Tutti 1
4	Orch. Tutti 2
5	Orch. Tutti 3
6	Orch. Tutti 4
7	Orch. Harp 1
8	Orch. Harp 2
9	Orch. Harp 3
10	Orch. Harp 4
11	Orch. Harp 5
12	French Horns 1
13	French Horns 2
14	Strings 1
15	Strings 2
16	Strings 3
17	Strings 4
18	Strings 5
19	Strings 6
20	Strings 7
SEQ - Solo	
1	Solo Marimba
2	Solo Kalimba 1
3	Solo Kalimba 2

#	Pad
4	Solo Steel Drums
5	Solo Vibes
6	Solo Gtr Dist.
7	Solo Slide Steel
8	Solo Banjo
9	Solo Violin
10	Solo Harpsi 3/4
11	Solo Harpsi 4/4
12	Solo Gtr Funk
13	Solo Piano 1
14	Solo Piano 2
15	Solo Piano 3
16	Solo Piano 4
17	Solo Synth 1
18	Solo Synth 2
19	Solo Synth 3
20	Solo Synth 4
21	Solo Synth 5
22	Solo Synth 6
23	Solo Guitar 1
24	Solo Guitar 2
25	Solo Guitar 3
SEQ - Synth&Pad	
1	Synth Seq 1
2	Synth Seq 2
3	Synth Seq 3
4	Synth Seq 4
5	Synth Seq 5
6	Synth Seq 6
7	Synth Seq 7
8	Synth Seq 8
9	Synth Seq 9
10	Synth Seq 10
11	Synth Seq 11

#	Pad
12	Synth Portam. 1
13	Synth Portam. 2
14	Synth Portam. 3
15	Synth Portam. 4
16	Synth Filter 1
17	Synth Filter 2
18	Synth Pad Panned
19	Synth Master Pad
20	Synth Dark Pad
SEQ - Misc&SFX	
1	Military 1

#	Pad
2	Military 2
3	Military 3
4	Military 4
5	Horror 1
6	Horror 2
7	Horror 3
8	Horror 4
9	Lullaby 1
10	Lullaby 2
11	Nature - River
12	Nature - Storm

#	Pad
13	Metronome 3/4
14	PreCount 3/4
15	Metronome 4/4
16	PreCount 4/4
17	PreCount 4/4 Dbl
18	Toccata
19	5th Intro
20	Primavera
21	Circus 1
22	Circus 2

58 Recognized chords

The following pages show the main recognized chords, when the selected Chord Recognition mode is Fingered 3-Notes.

Major

3-note

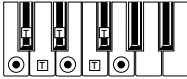

2-note

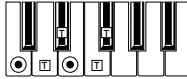

Major 6th

4-note

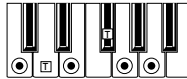

2-note



Major 7th

4-note

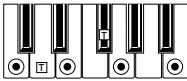

3-note

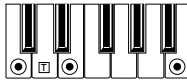

2-note



Sus 4

3-note

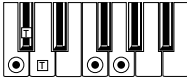

2-note

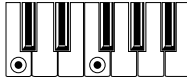

Sus 2

3-note



Dominant 7th

4-note

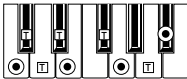

3-note



2-note



Dominant 7th Sus 4

4-note



3-note



Flat 5th

3-note

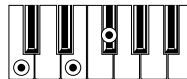

Dominant 7th ^b5

4-note



Major 7th ^b5

4-note

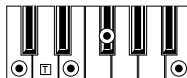

Major 7th Sus 4

4-note



● = constituent notes of the chord

▭ = can be used as tension

Minor

3-note

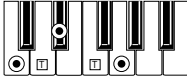

2-note



Minor 6th

4-note

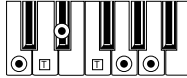

Minor 7th

4-note

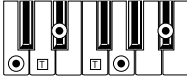

3-note



Minor-Major 7th

4-note

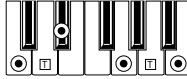

3-note



Diminished

3-note

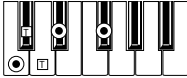

Diminished 7th

4-note

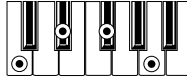

Diminished Major 7th

4-note

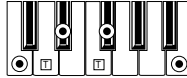

Minor 7th ^b5

4-note

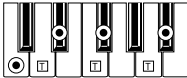

Augmented

3-note

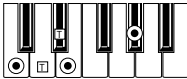

Augmented 7th

4-note

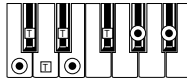

Augmented Major 7th

4-note

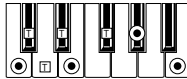

No 3rd

2-note



No 3rd, no 5th

1-note



● = constituent notes of the chord

□ = can be used as tension

59 Connecting an external display

You can connect Pa4X to a TV or video monitor, to read lyrics and chords with your fellow musicians or audience.

Connect the external video monitor

- Use the VIDEO OUT connector to connect Pa4X to a TV set or video monitor. Depending on the type of video monitor, you can use a cable of the RCA-to-RCA type (if the monitor is equipped with a Video Composite input), or the RCA-to-SCART type (if the monitor is equipped with a SCART connector). You can buy the needed cables at a store that sells television equipment.

Go to the Video Out page

- 1 If it is off, turn the instrument on.
- 2 Go to the Global > Audio & Video > Video Out page.

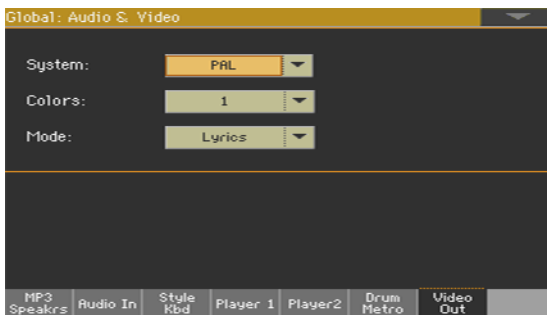

Select the video standard

- Use the System menu to select the video standard.

System	Meaning
PAL	Used in most European, South American, Asian and African countries. This setting can be also used with SECAM TV sets (used in France, Russia, and some African countries); in this latter case, however, the picture is shown in black & white.
NTSC	Used in North America, Central America and part of South America. It is also used in Japan, Korea, Taiwan, Philippines and Myanmar.

Turn the external monitor on

- Turn the video monitor on, and tune it on the correct AV input.

Set the colors

- In the same page, use the Colors menu to choose the preferred set of colors for the lyrics and the background.

Colors	Meaning
1...5	Color set. Try them to find the one you feel most comfortable with.

Choose what to display

- In the same page, use the External Video menu to choose what to show in the video monitor.

Mode	Meaning
Lyrics	Only Lyrics and Chords (if any) are shown in the external display. (This is the default option at startup.)
Display Mirror	The internal display is duplicated ('mirrored') to the external display.

61 | Installing the options

Assembling the amplification system (PaAS)

If you purchased the (optional) PaAS Amplification System, here is how to install it, and add a three-way amplification system, a pair of integrated speakers and a bass-reflex box.

Installing the PaAS will not deactivate the main audio outputs. Connecting the headphones will deactivate the PaAS (but not the main audio outputs).

Assembling the amplification bar

Precautions

- Installation of the Amplification System is done at the user's own risk. KORG will assume no responsibility for any damage or injury resulting from its improper installation or use.
- Be very careful not to make the speaker box fall when installing it, or it can be damaged.

Installation

- 1 Remove the protective cap (b) from the connector (c) on the back of the instrument (a), by gently pulling it and making it turn down.

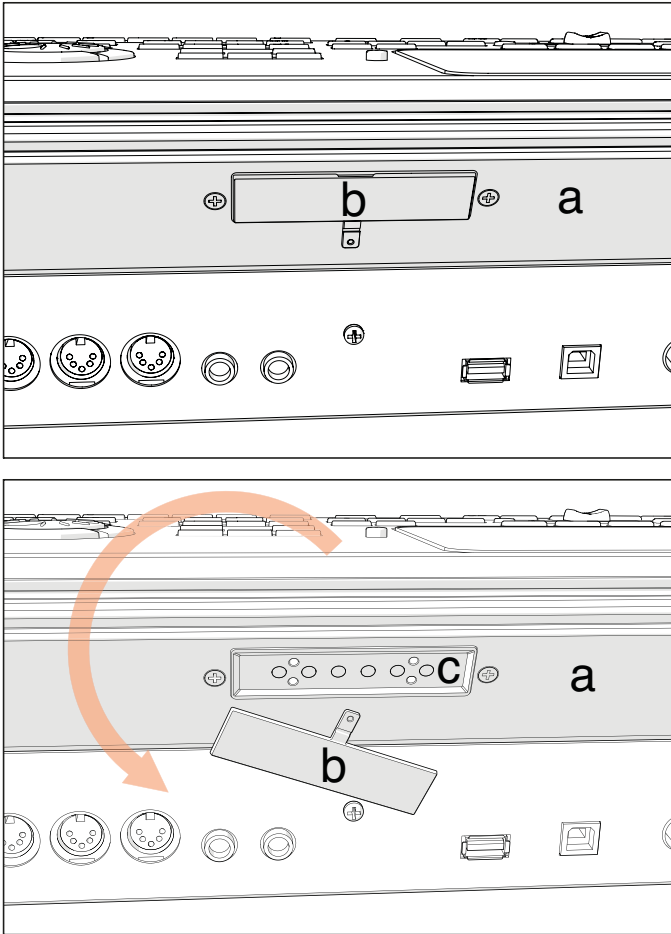

- Now locate the front (d1) and the rear (d2) side of the speaker box, to be sure you will place it in the right way.

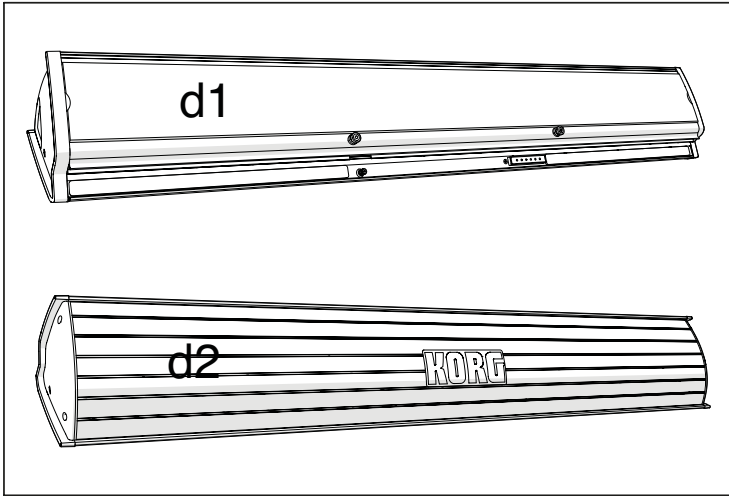

- Lift the speaker box (d) by making the back side (d2) look toward you and the front side (d1) toward the Pa4X. Align its extruding guide (e) to the matching slot (f) on the back of the instrument (a). Slightly tilt the speaker box (d) forward, to prevent the fixing pin (j, see below) to damage the back of the instrument. To align them correctly, use one of the two plastic stoppers/delimiters (h) as a reference point, making one of the flanks or the speaker box's guide (e) touch it.

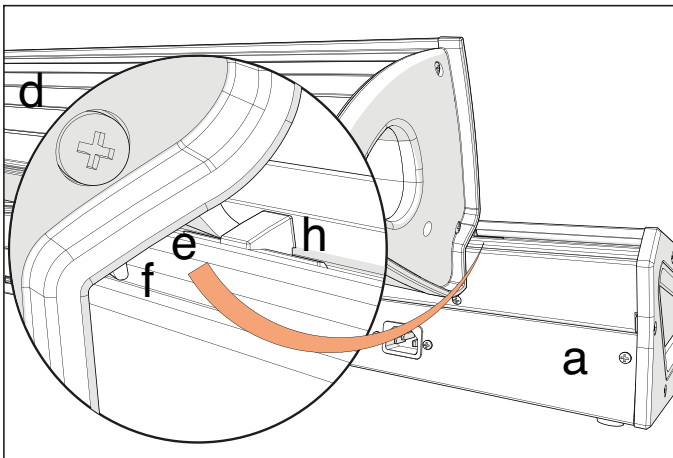

- 4 Insert the speaker box's extruding guide (e) entirely into the slot (f) on the back of the instrument, being sure the speaker box is perfectly horizontal.

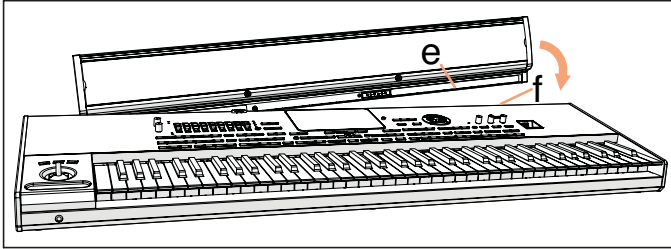

Be sure the nylon supports (i) for the music stand are perfectly resting on the control panel of the instrument (a).

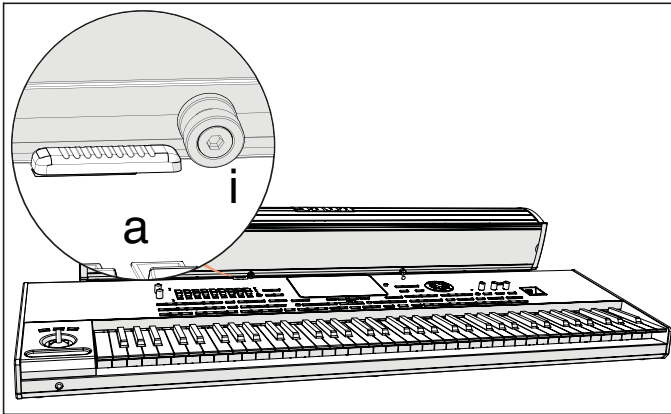

- When the speaker box (d) is perfectly aligned to the stoppers/delimiters, and the fixing pin (j) is over the corresponding hole (k) on the back of the instrument (a), tilt down the speaker box (d), to make the fixing pin (j) enter the hole (k).

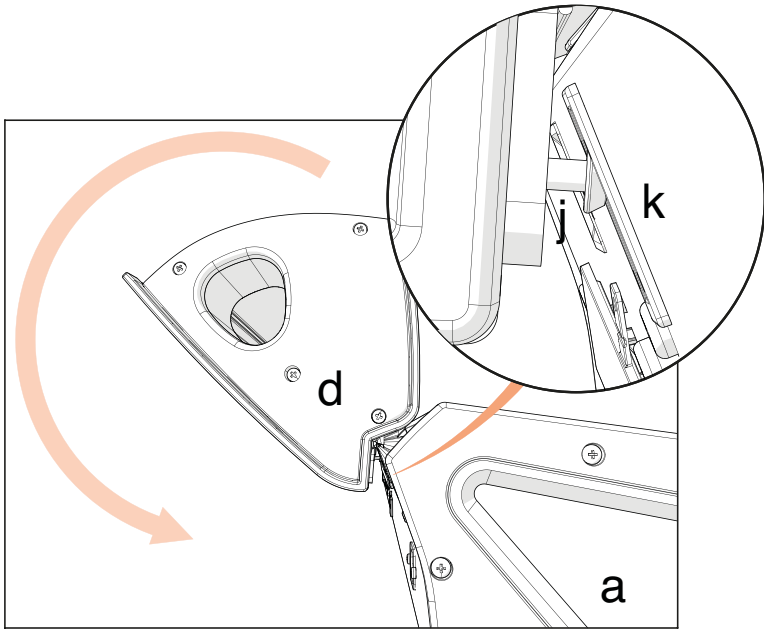

- Use the SPEAKER LOCK slider (l) next to the display to lock (or later unlock) the speaker box (d). When the box is locked, you must see the closed lock icon (🔒). This will firmly join the speaker box (d) to the instrument (a).

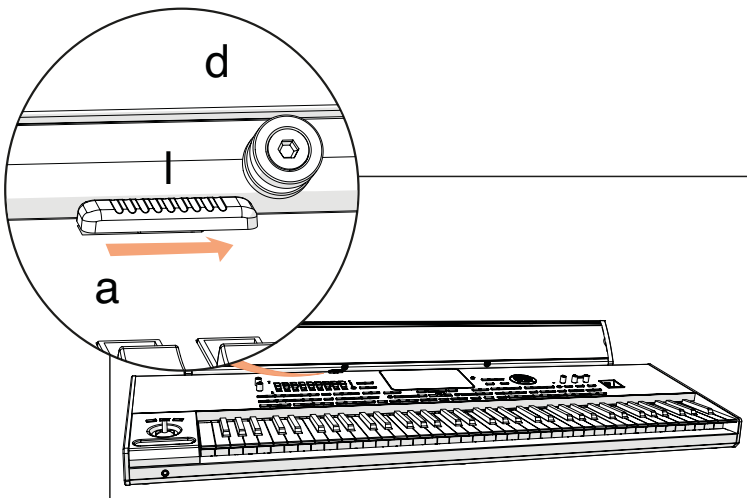

- 7 At this point, the speaker box is correctly installed. To remove it, reverse the above instructions.

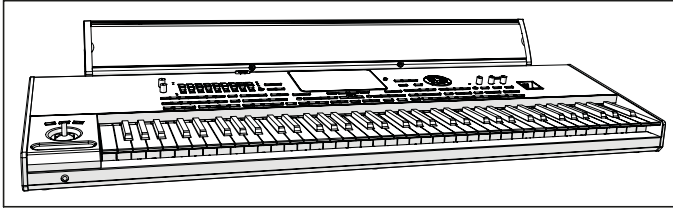

Please note that, since Pa4X has to recognize the new circuit, the integrated speakers will start operating only a few seconds after the speaker box has been installed.

Turning the integrated loudspeakers on and off

The integrated speakers are automatically deactivated when inserting a jack into the PHONES connector. They can also be deactivated from the display.

Turn the speakers off (or back on)

- 1 Go to the Global > Audio & Video > MP3/Speakers page.

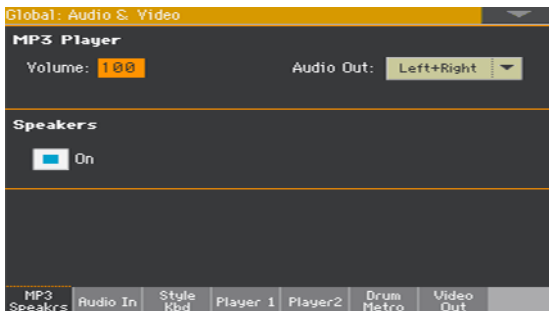

- 2 Use the Speakers On/Off checkbox to turn the (optional) integrated speakers on or off. The speakers can be installed by adding the (optional) PaAS Amplification System.
- 3 Press the EXIT button to return to the previous page.

Controlling the output volume of the integrated loudspeakers

- Adjust the output level with the MASTER VOLUME knob.

Assembling the music stand

Follow these instructions to assemble the supplied music stand.

Assembling the music stand without the amplification bar installed

- 1 Insert the music stand into the dedicated guide on the back of Pa4X, as shown in the illustration.

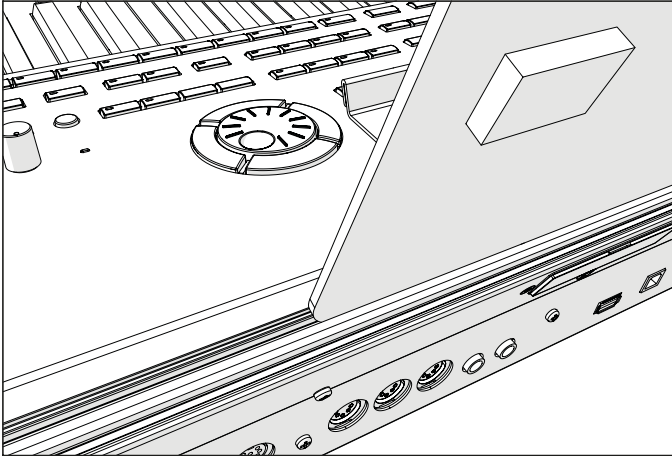

- 2 Freely adjust the music stand, by sliding it to the left or the right of the standard central position.

Assembling the music stand with the amplification bar installed

- When the (optional) PaAS amplification system is installed, make the music stand rest over the nylon supports in front of the PaAS, as shown in the illustration.

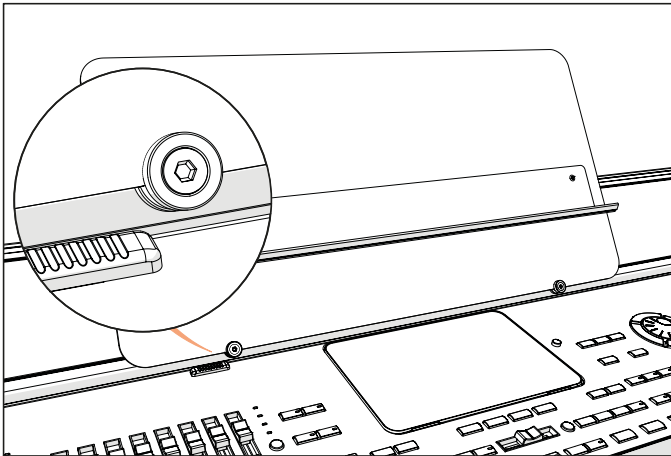
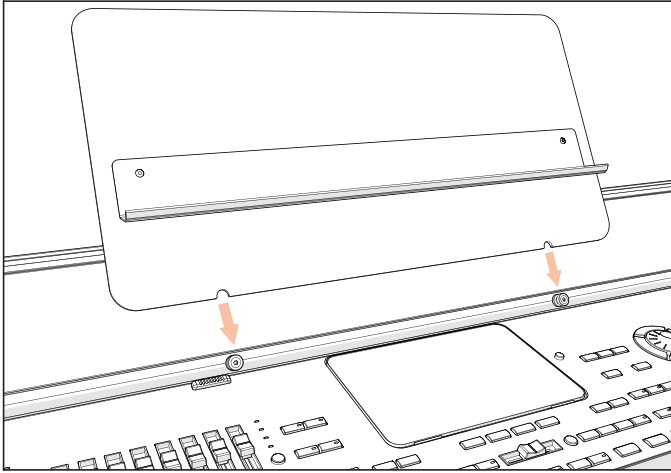

Assembling the stand (ST-SV1 BK)

You can use the KORG ST-SV1 BK stand as a steady support for your Pa4X.

Precautions before assembly

Before you begin to assemble the stand, please keep the following in mind:

- To assemble the stand, two people are strongly suggested. Failing to do so may damage the instrument and cause injury.
- When placing the instrument on the stand, be careful not to pinch your hands.
- Be sure to follow the steps in order, and make sure that the parts are assembled in the correct orientation and position.
- Do not apply weight to the edge of the instrument before tightening the screws, otherwise it may fall down.

Assembly instructions

- 1 Open the packing carton and take out the contents. Remove the stand (B) from the package by grabbing it by the four brackets (a). Lay it on the ground, with the legs on top (see illustration).

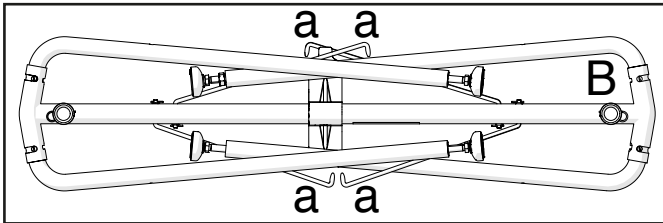

- 2 Remove the protective sheet, and keep it in a safe place for future use.

- 3 Slightly lift the stand, and push the spring bolt (b) located under the tubing.

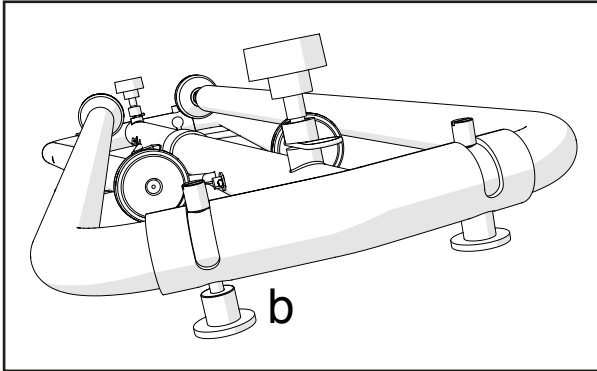

- 4 Once the spring bolt has been extended, raise the leg (c), until you hear a 'click'. At this point, the spring bolt (c) is automatically retracted, and the leg is fixed in place. Please repeat the same procedure for all four legs.

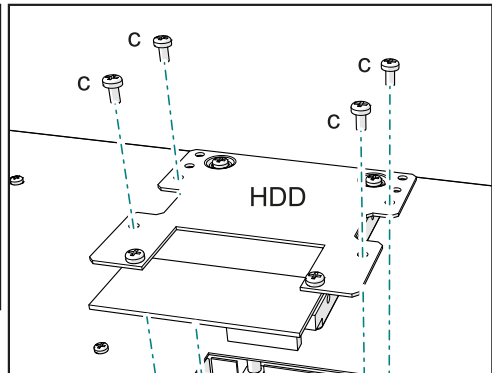
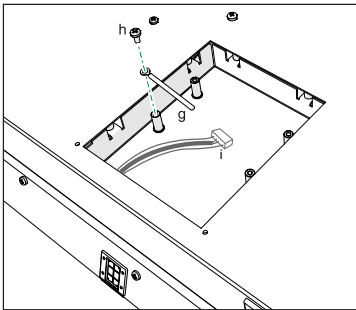

- 5 Lift the bracket (a), and insert it into the corresponding hole (d) in the leg (c). Repeat the same procedure for all four legs.

Warning: Be careful not to pinch your fingers between the leg and the bracket!

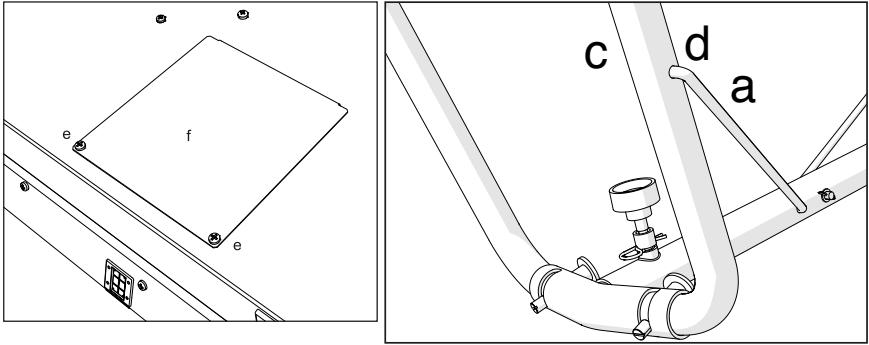

- 6 Turn the stand (B) upside down, so that the feet are laying on the floor. Place the concave side of the bracket (e) toward you.

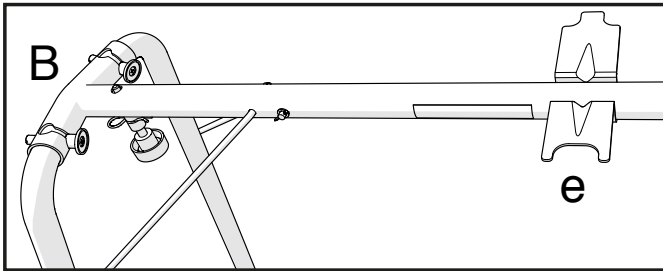

- 7 Adjust the height of the feet (f), by turning them by hand and leveling the stand on each side, even if it is not completely even. We suggest you prevent the nut (g) from turning with the help of the supplied 11/16" wrench (h). After adjusting each of the feet, make sure that the nut (g) touches the leg's border.

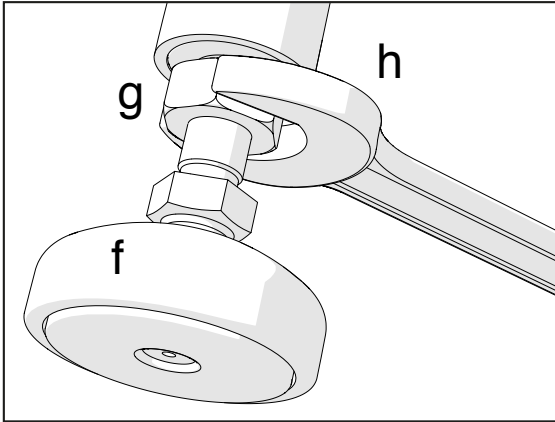

- 8 **Using two people**, lift the instrument (A), and attach it to the ST-SV1 BK stand (B), being sure the concave side of the bracket (e) is pointing toward the front side of the instrument (A).

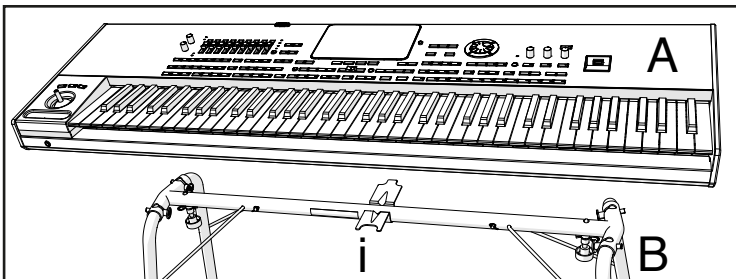

- 9 If the instrument and the stand are correctly aligned, the screws (j) should fit into the threaded nuts of the holes (k). If this does not happen, align the instrument and stand again. Once the screws are inside the threaded nuts, tighten them to attach the instrument to the stand.

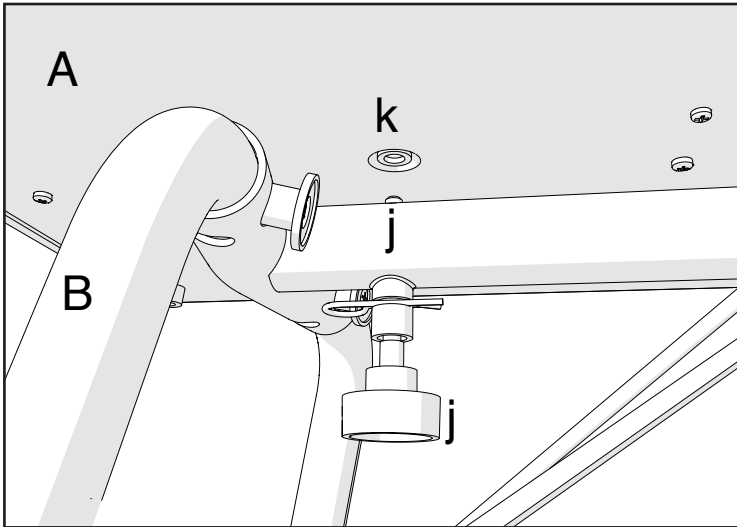

- 10 Be sure all screw are tightened, and all brackets correctly inserted.
- 11 Place the instrument in the location where it will be played.

Precautions after assembly

Use caution when transporting the instrument

Remove the instrument from its stand, and transport them separately. Please use the included loop fastener tapes to secure the stand legs during transport and avoid any damage. After transportation, refer to these instructions and re-assemble the instrument and stand.

Loosening of the screws

After assembly, the various screws and bolts of the stand may loosen as time goes by, causing the stand to wobble. If this occurs, re-tighten the screws.

Disassembly

If you need to pack up the instrument, reverse the assembly order by which the instrument was attached to the stand and the stand was assembled. For improved protection, we suggest you also replace the protective sheet (see step 1).

Replacing the clock backup battery

You can replace the clock backup battery with a standard lithium battery (model CR2032). **Do not use replacements different than the one suggested by KORG, or you risk to damage the instrument!**

Precautions

- Installation of the battery is done at the user's own risk. KORG will assume no responsibility for any data loss, damage or injury resulting from its improper installation or use.
- Be sure to disconnect the instrument from the AC plug, before opening it.
- To prevent your body's static electricity from damaging the board's components, touch an unpainted metallic component before proceeding with the installation.

Installation

For installation, you will need a cross-point screwdriver (not supplied).

- 1 Disconnect the instrument from the AC power.
- 2 From the back of the instrument, use the cross-point screwdriver to remove the fixing screw (a), then remove the cover and keep it apart.

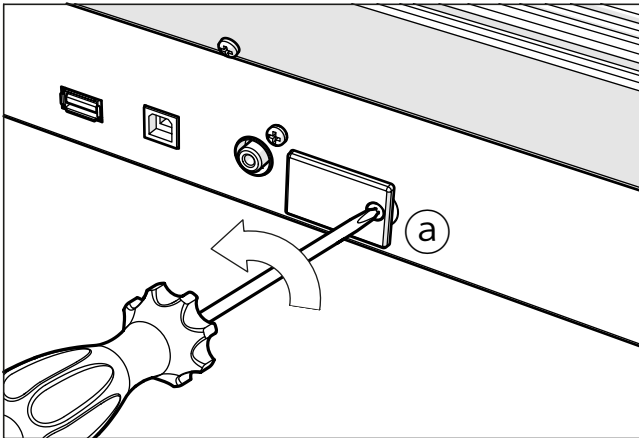

- 3 With the help of your fingernail, lift the exhausted battery (c) from its lower side, and remove it from the battery slot, being very careful not to let it fall inside the instrument.

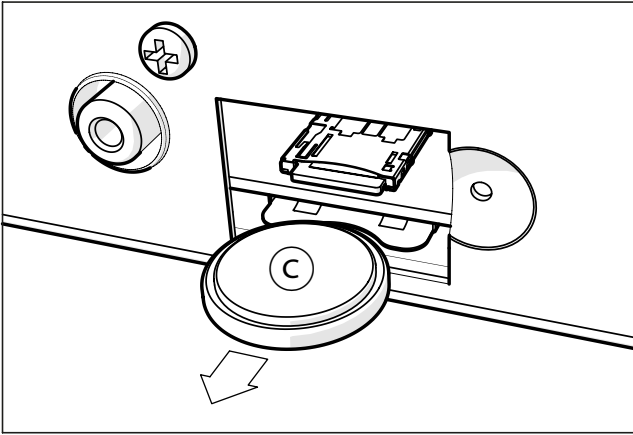

- 4 Insert the new battery (d) into the empty battery slot, being sure the positive (+) side is facing down. Be very careful not to let it fall inside the instrument.

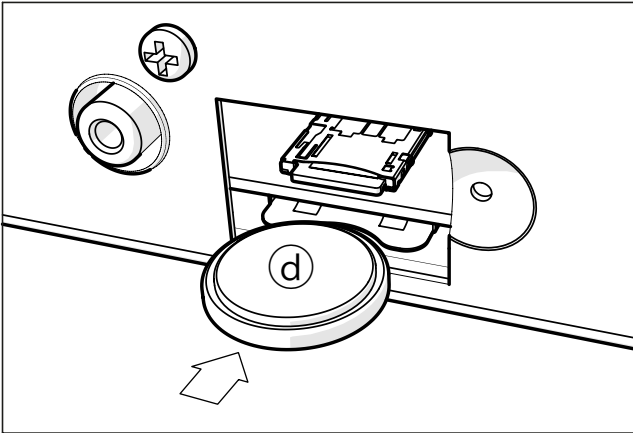

- 5 Replace the cover (b) to the original position. Attach the cover to the back of the instrument by fastening the fixing screw (a).

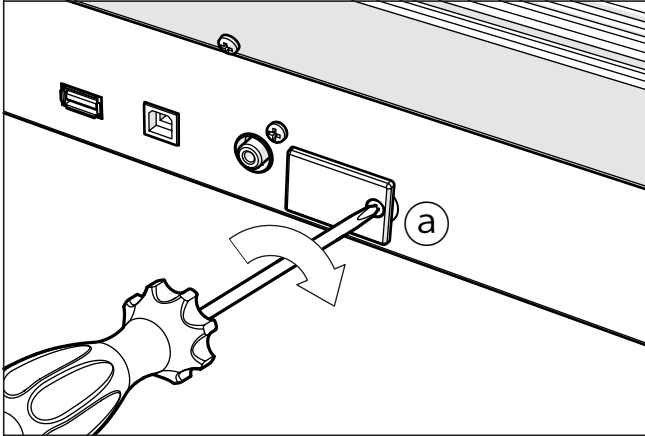
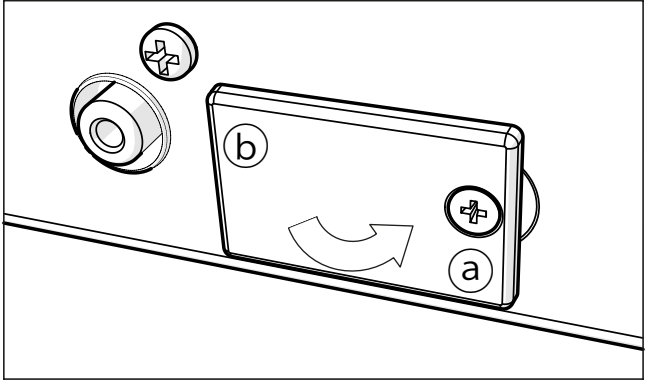

Installing a microSD card

To expand the available onboard storage memory, you can install an (optional) microSD card. The card can be installed by the user. **Do not use parts different than the one suggested by KORG, or you risk to damage the instrument!**

Please consider a card containing localized musical resources could have already been installed by your KORG Distributor. If you are not sure, contact them before removing the installed card.

Precautions

- Installation of the microSD card is done at the user's own risk. KORG will assume no responsibility for any data loss, damage or injury resulting from its improper installation or use.
- Be sure to disconnect the instrument from the AC plug, before opening it. **Warning:** Removing or inserting the microSD card while the instrument is connected to the AC plug may damage the instrument and the card!
- To prevent your body's static electricity from damaging the board's components, touch an unpainted metallic component before proceeding with the installation.

Installation

For installation, you will need a cross-point screwdriver (not supplied).

- 1 Disconnect the instrument from the AC plug.

- From the back of the instrument, use the cross-point screwdriver to remove the fixing screw (a), then remove the cover and keep it apart.

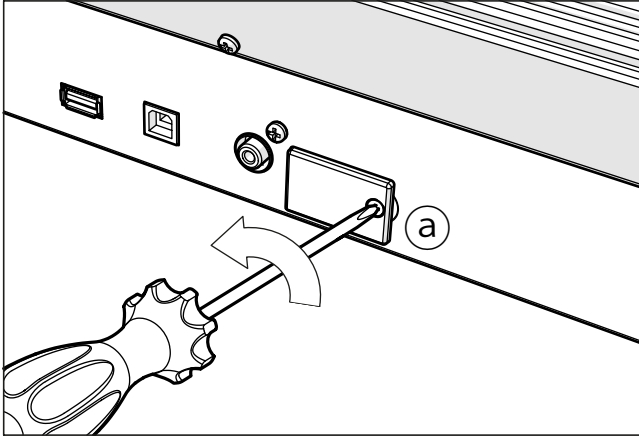

- Push on the microSD card (c) already installed in the slot (if any) to unlock it, and remove it, being very careful not to let it fall inside the instrument.

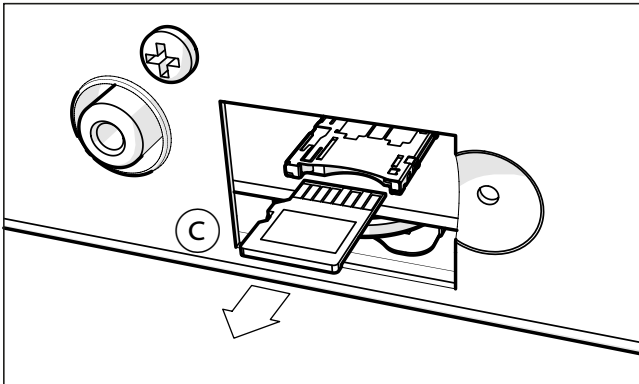

- Insert the microSD card (d) into the empty card slot, being sure the connector side is facing up and toward the instrument. Gently push the card, until

you hear a click sound meaning it is properly inserted. **Warning:** Be sure to insert the card correctly, or it may slip inside the instrument!

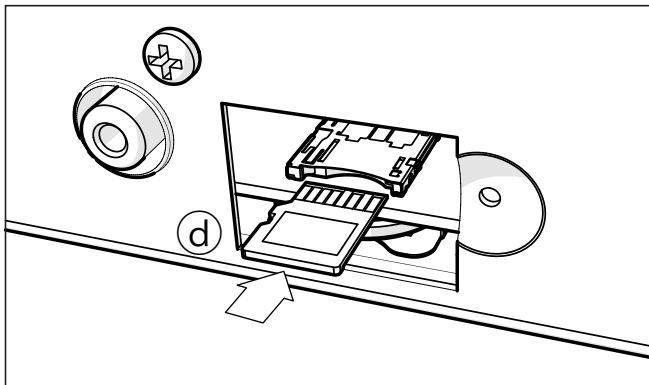

- 5 Replace the cover (b) to the original position. Attach the cover to the back of the instrument by fastening the fixing screw (a).

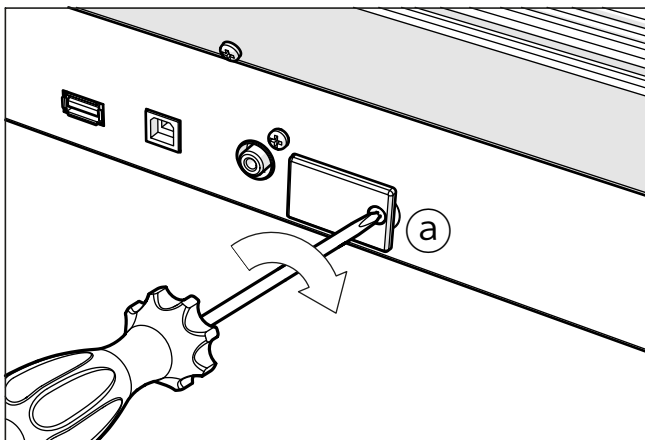
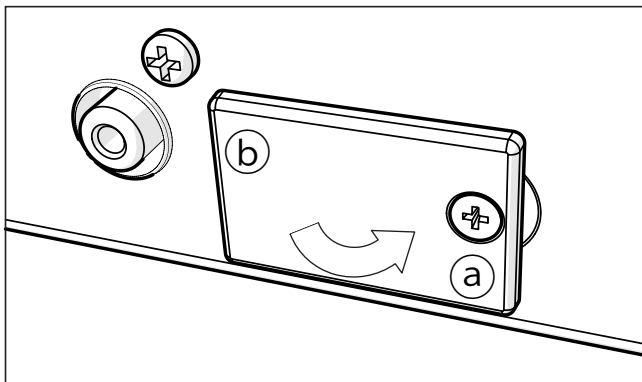

Accessing the microSD card

Once the microSD card is installed, restart your Pa4X. You can access the card from any Media page or from the Song Select window, by using the Device selector and choosing the SD storage device.

Installing an additional internal drive

The HDIK-3 kit allows you to install a standard internal 2.5" SATA hard disk drive in your Pa4X-61 (an additional drive comes as standard with Pa4X-76). The hard disk drive is not supplied with the kit, so you will have to purchase it separately. **Do not use parts different than the one suggested by KORG, or you risk to damage the instrument!**

Precautions

- Installation of the kit is done at the user's own risk. Korg will assume no responsibility for any damage or injury resulting from its improper installation or use.
- Be sure to disconnect the instrument from the AC plug, before opening it.
- To prevent your body's static electricity from damaging the board's components, touch an unpainted metallic component before proceeding with the installation.
- Never force the connectors, that can only be inserted in a way.

List of parts

Before beginning with the installation, be sure to have all the parts listed in the following table. You also need a cross-point screwdriver (not supplied).

a	HDD interface	x 1
b	HDD support	x 1
c	M3x6 TC screws	x 6
d	M3x4 TC screws	x 2

Backup

Before installing or replacing the hard disk drive, please backup or save your User data to an USB storage device, by using the Media > Utility > Full Resource Backup or Media > Save > All operations.

Installation

- 1 Extract the hard disk kit from its package, being careful not to touch any component on the interface board's surface with your fingers. Turn the instrument upside down, being careful not to damage the display, joystick and knobs.
- 2 Attach the connector of the interface board (a) to the matching connector on the hard disk drive. Align the two connectors, and delicately push them together.

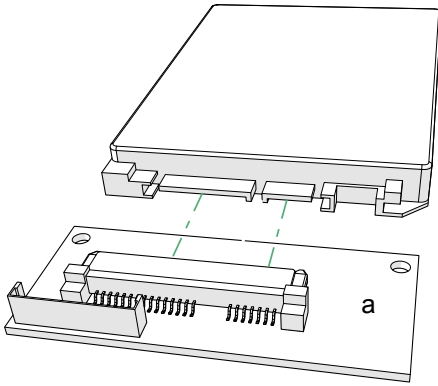

- 3 Use two screws (c) to secure the hard disk drive (not supplied with the kit) to the interface board (a) and to the metal support (b), as shown in the illustration. Use the two screws (d) to secure the hard disk drive to the support (b).

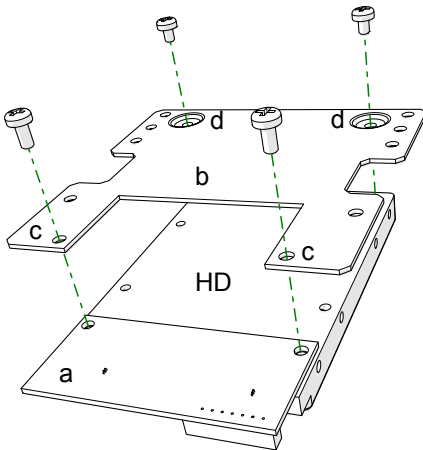

- 4 From the bottom of the instrument, remove the two fixing screws (e) and keep them apart. Open the cover (f) by lifting it as if it was hinged on the opposite side, and keep it apart.

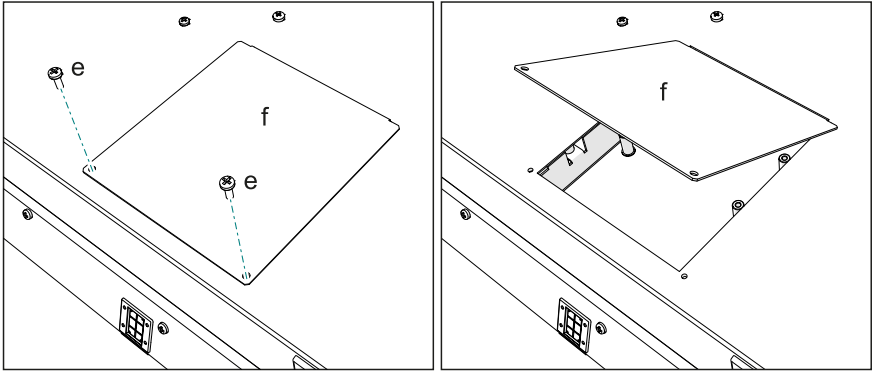

- 5 Disconnect the data cable (i) from the fixing clip (g), and remove the clip (g) by unscrewing the fixing screw (h).

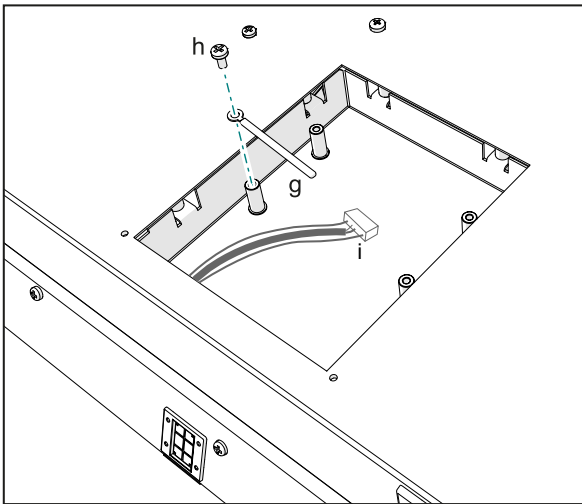

- 6 Connect the data cable (i) to the dedicated connector on the interface board (a).
- 7 Place the previously assembled hard disk kit over the four dedicated spacers inside the instrument (the drive can only be installed in a way), being careful not to pinch and damage the cable. Fix the assembly with the last four screws (c) found in the installation kit.

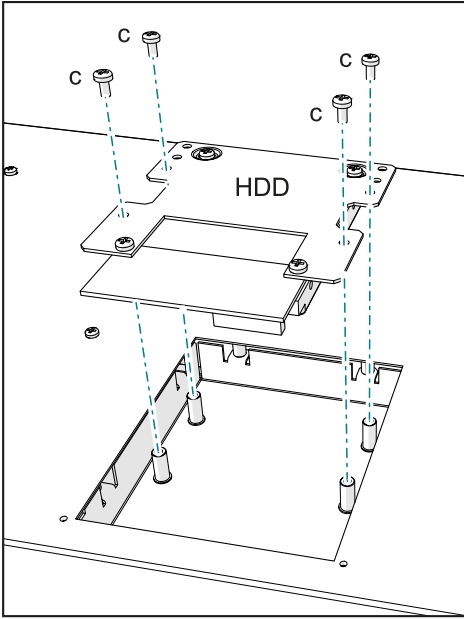

- 8 By following the opening instructions in reversal, close the instrument by replacing the cover (f).

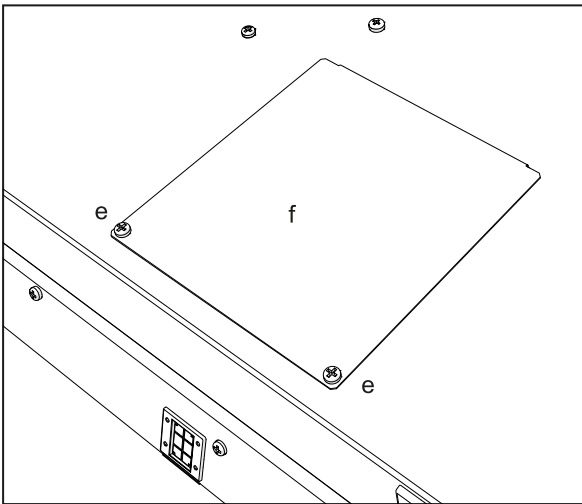

- 9 When the installation is finished, turn the instrument over, connect the power cord, and switch the instrument on again. If the hard disk drive is not already formatted, go to the [Media > Format](#) page, and format it (HD device) before accessing it for data storage.

62 Shortcuts

Shift functions

You can keep the SHIFT button pressed, and press another button on the control panel to directly jump to an edit page or dialog box.

Long keypress

You can keep a button pressed for about one second to directly jump to an edit page or dialog box.

Special functions

Other available shortcuts are the following ones.

Style Play mode	
Tempo +/- (together)	Original Tempo
Transpose #/b (together)	Set the Master Transpose to 0
Upper Octave +/- (together)	Set the Upper Octave to the original setting

63 Troubleshooting

In case of problems, please check the following list to find a solution.

Problem	Solution
General problems	
Power does not turn on	Make sure that (1) the power cable is plugged into the outlet, (2) the cable is plugged into the connector on the back of the instrument, (3) and is not damaged, (4) there are no problems with the mains.
	Is the POWER indicator turned on?
	If the power still does not turn on, contact your dealer or the nearest KORG Service Center.
Power does not turn off	Press the POWER button again and keep it pressed for a few seconds. At the end, the button's indicator will turn off, and the instrument will be set to standby.
No sound	Is the VOLUME knob set to a position other than '0'?
	Is a jack inserted into the HEADPHONES connector? Unplug it.
	Check the connections to your amp or mixer.
	Make sure that all the components of the amplifying system are turned on.
	Is the Local parameter set to off? Turn it on.
	Is the Attack parameter value of the selected Sound too high? Set it to a lower value, to let the sound start faster. Is the Volume parameter too low? Set it to a higher value.
Lowest note are not played	When the SPLIT indicator is turned on, the keyboard is divided into a Lower part (lower notes, below the split point) and an Upper part (higher notes, above the split point). Is the Lower part muted? Unmute it.
Wrong sounds	Do the User banks contain modified data? Load the appropriate data for the Song or the Style you wish to play.
	Has one of the User Drum Kits been replaced? Load the appropriate Drum Kits.
	Have the Styles or Keyboard Sets been replaced? Load the appropriate data.
Sound does not stop	Keep the SHIFT button pressed, and press the START/STOP button to send a Panic message, and turn all notes off.
	Make sure that the Damper pedal calibration is correctly set.

Problem	Solution
The selected Style or Song cannot start	Make sure that the Clock parameter is set to Internal. If you are using the MIDI Clock of another device (like a sequencer), you must set the MIDI Clock parameter to MIDI or USB, and make sure that the external device transmits MIDI Clock data.
Does not respond to MIDI messages	Make sure that the MIDI or USB cable is connected correctly.
	Make sure that the external device is transmitting through MIDI channels enabled to receive in Pa4X.
	Make sure that the MIDI IN Filters do not prevent the reception of messages.
Percussive instruments are not played correctly	Make sure that the Drum track is set to Drum Mode and the external device has not transposition applied.
Some 'clicks' can be heard when playing a percussive instrument	This is part of the sound, and not a problem.
A background noise can be heard after selecting a Keyboard Set or Style	The selected Keyboard Set or Style recalled the effect 'St. Analog Record', simulating the noise of a old vinyl recording.
Media related problems	
Cannot format a device	Is the USB cable correctly connected?
	Is the USB device correctly powered?
	Is the device inserted correctly?
	Is the write protect tab of the disk or card in the protect position? Unprotect it.
Cannot save data to a device	Is the device formatted?
	Is the device inserted correctly?
	Is the write protect tab of the disk or card in the protect position? Unprotect it.
Cannot load data from a device	Is the device inserted correctly?
	Does the device contain data compatible with Pa4X?
The message 'Over Current Condition Detected on USB port: please remove the USB media' appears in the display	The USB device is probably defective, due to a short circuit, and cannot be used. While this will not damage Pa4X, it is advisable to remove the device.

64 Specs

KORG Pa4X	Features
Keyboard	Pa4X-76: 76 keys (E1 - G7)
	Pa4X-61: 61 keys (C2 - C7)
	Semi-weighted keys with velocity and aftertouch
System	Upgradable operating system
	Multitasking, Load while play
Sound Generator	EDS-X (Enhanced Definition Synthesis - eXpanded)
	Filters with resonance, 3-band EQ on each Sound/channel
Polyphony	128 voices, 128 oscillators
Effects	Accompaniment/Song: 4 insert effects; 3 master effects (148 types)
	Keyboard Sounds: 1 insert effect; 2 master effects (148 types)
	Final mastering effects by Waves Audio®:
	Waves Audio MAXX Suite, including MaxxEQ™, MaxxBass™, MaxxTreble™, MaxxStereo™, MaxxVolume™
	Voice Processor Technology by TC•Helicon®:
Four-part Harmonizer, Double, →Mod, Reverb, Delay, Filter, HardTune, Pitch Correction; plus Compressor, EQ, Gate (Adaptive Mic Setting on the Mic input)	
Sounds / Drum Kits	Factory: More than 1,900 Factory Sounds including two multilayer Stereo Grand Pianos with damper and body resonance, GM/XG sound sets and more than 110 Drum Kits
	User: 512 Sounds, 256 Drum Kits
	Digital Drawbars: 9 footages, percussion, key on/off, leakage, rotary speaker effect
	DNC (Defined Nuance Control) Technology
	Natural Ambience Drums Sounds
	Full Sounds/Drum Kits editing
Sampling	User PCM Sample memory: 400 MB compressed (equivalent to 800 MB linear data)
	Loads KORG, WAV, AIFF and SoundFont™ formats
	Saves KORG, WAV and AIFF formats
	Full Edit, Time Slice, Sampling

KORG Pa4X	Features
Styles	<p>Factory: More than 550 Factory Styles, freely reconfigurable sets</p> <p>User: 1,248 locations, including User, Favorite and Direct banks</p> <p>Eight Accompaniment tracks, 4 Keyboard Sets, 4 Pads per Style; Style Settings (Sounds and Arranger parameters) on each Style</p> <p>Guitar Mode 2, Parallel and Fixed NTT (Note Transposition Table)</p> <p>Style/Pad Record with Step Record, Track and Event Edit</p> <p>Style Creator Bot (MIDI Song to Style Converter)</p> <p>Style controls: 3 Intros, 4 Variations, 4 Fills, Break, 3 Endings, Synchro Start, Synchro Stop, Tap Tempo/Reset, Bass Inversion, Auto Fill, Manual Bass, Memory, Accompaniment Mute, Drum Mapping, Snare & Kick Designation, Style to Keyboard Set Mode</p>
Chord Sequencer	<p>Chord Sequence recorder in Style Play mode</p> <p>Chord Sequences can be saved to Style and SongBook Entries</p> <p>Edit functions: Delete, Copy from Style/SongBook, Import/Export from/to SMF</p>
Keyboard Set Library	<p>Memorize Keyboard Sound settings</p> <p>Factory: More than 460 Factory Keyboard Sets, freely reconfigurable</p> <p>User: 1,056 locations, including User and Direct banks</p> <p>'My Setting' special Keyboard Set</p>
KAOSS FX	<p>Automatic MIDI FX generator</p> <p>More than 65 Factory Presets</p>
Song Play	<p>Patented XDS Crossfade Dual Sequencer Player with X-Fader control</p> <p>Supported formats: MID, KAR, MP3+Lyrics, MP3+G</p> <p>Two Players with separate Select, Start/Stop, Home, Rewind and Fast Forward controls</p> <p>Lyrics, Score, and Chord data can be displayed on screen, or on an external video monitor</p> <p>Markers with Add, Delete, Edit and Loop functions</p> <p>Jukebox function</p>
MP3 Player / Recorder	<p>Double MP3 Player and MP3 Recorder</p> <p>Transpose (+6/-5 semitones)</p> <p>Tempo change (+30%)</p> <p>Vocal Remover</p> <p>Records MP3 files, including Styles, MIDI Songs, MP3 Songs, Keyboard Sounds, Pads, Microphone, Effects, KAOSS Effects</p>

KORG Pa4X	Features
Sequencer	Quick Record (Backing Sequence), Multitrack and Step Record functions
	Full-featured sequencer, 16 tracks, Up to 200,000 events, SMF (MIDI) native format
SongBook	Fully programmable music database, based on Styles, MIDI Songs (MIDI and KAR files), MP3 Songs, with automatic selection of Style Play and Song Play modes
	User definable Set Lists, with Entries selectable from the control panel
	Filtering and sorting options
Compatibility	'i-Series' models: Styles
	Pa-Series models: Styles, Performances/Keyboard Sets, Programs/Sounds, Songs, SongBook Entries, Pads
Pads	Four Assignable Pads + Stop buttons
	Pad Record function
General Controls	Master Volume; Fade In/Out; Keyboard-Acc/Song Balance; Ensemble; Octave Transpose; Master Transpose; Quarter Tone and Arabic Scale memorized inside Keyboard Sets; Joystick; Ribbon; Mic Volume; Harmony/Double; Delay/Reverb; Mic Preset; Mic On/Off; Harmony On/Off; Double On/Off; 8 Assignable Sliders; Slider Mode; MP3 Volume; 3 Assignable Switches; Tempo +/-; Tempo Lock; Metronome On/Off; Dial; Up/+; Down/-; Search; Shift; Chord Scan (Lower, Upper); Split; Keyboard Tracks Sound Select and On/Off; Record
Control Inputs	Damper pedal (supports half-pedaling with the optional DS-1H pedal)
	Assignable pedal/switch
	EC5 multiswitch pedal
Mic/Line Inputs	Mic: Combo XLR balanced with Gain control and Phantom Power
	Line 1: Left/Right (1/4" jack) line inputs, balanced
	Line 2: Stereo (1/8" mini-jack) line input, unbalanced
Outputs	Audio Outputs: Left/Right, Out 1, Out 2 (1/4" jack) balanced
	Headphone output (1/4" jack)
	Video out (RCA connector)
MIDI	IN, OUT, THRU standard MIDI connectors
	USB to MIDI using the USB ports
	Eight user definable MIDI Setups
USB	Type A (HOST, for memory and controllers) x 2 (front/rear)
	Type B (DEVICE, for personal computers and tablets) x 1 (rear)
	2.0 Hi-Speed connections

KORG Pa4X	Features
Storage	<p>Hard Disk Drive</p> <p>Pa4X-76: standard</p> <p>Pa4X-61: optional, user installable; HDIK-3 hard disk installation kit required</p> <p>microSD card (card not included); rear panel slot with plastic cover</p> <p>USB external drives (drive not included); 1 front panel port, 1 rear panel port</p>
Display	7" Wide capacitive color TouchView™ TFT display
Clock	Internal System Clock
Power Consumption	<p>100-240 Volts, 50/60 Hz</p> <p>< 0.5 Watt in standby / 16 Watt normal / 35 Watt with PaAS installed</p>
Dimensions (W x D x H)	<p>Pa4X-76: 1,192 x 364.4 x 125.56 mm / 46.93" x 14.35" x 4.94"</p> <p>Pa4X-61: 980 x 364.4 x 125.56 mm / 38.58" x 14.35" x 4.94"</p> <p>(without music stand, display fully lowered)</p>
Weight	<p>Pa4X-76: 16.3 kg / 35.93 lbs</p> <p>Pa4X-61: 13.9 kg / 30.64 lbs</p>
Accessories	AC Power Cable, Music Stand, Quick Guide manual
Options	<p>PaAS Amplification System</p> <p>ST-SV1 BK Keyboard Stand</p> <p>HDIK-3 Hard Disk Installation Kit (for Pa4X-61 only)</p> <p>EC-5 Multiswitch Pedal</p> <p>EXP-2 Foot Controller</p> <p>XVP-10 Expression/Volume Pedal</p> <p>DS-1H Damper Pedal (supports half-pedaling)</p> <p>PS-1 Pedal Switch</p> <p>PS-3 Pedal Switch</p>

Specifications and appearance are subject to change without notice for improvement.

Function	Transmitted	Recognized	Remarks
Basic Channel	Default	1-16	Memorized
	Changed	1-16	
Mode	Default	3	
	Messages Altered	X *****	X
Note	0-127	0-127	
Note Number:	*****	0-127	
Velocity	Note On	0 9n, V=1-127	0 9n, V=1-127
	Note Off	0 8n, V=0-127	0 8n, V=0-127
Aftertouch	Poly (Key)	0	Player data only
Pitch Bend	Mono (Channel)	0	*1
		0, 32	Bank Select (MSB, LSB)
	1, 2	0	*1 Modulations
	6	0	*1 Data Entry MSB
	12, 13	0	*1 FX MIDI Controller 1/2
	38	0	*1 Data Entry LSB
	7, 11, 16	0	*1 Volume, Expression, Ribbon
	10, 91, 93, 96	0	*1 Panpot, A/B Master FX Send 1/2/3
Control	64, 66, 67	0	*1 Damper, Sostenuto, Soft
Change	65, 5	0	*1 Portamento On/Off, Portamento Time
	71, 72, 73	0	*1 Harmonic Content, EG time (Release, Attack)
	74, 75	0	*1 Brightness, Decay Time

76, 77, 78	O	O	O	Vibrato Rate, Depth, Delay	*1
80, 81	O	O	O	Sound Controller (1, 2)	*1
98, 99	O	O	O	NRPN (LSB, MSB)	*1, 2
100, 101	O	O	O	RPN (LSB, MSB)	*1, 3
120, 121	X	O	O	All sounds off, Reset all controllers	*1
Program Change	O 0-127 *****	O 0-127 0-127			*1
System Exclusive					
System Common	X	X	X	Song Position	*4
	X	X	X	Song Select	
	X	X	X	Tune	
System Real Time	O	O	O	Clock	*5
	O	O	O	Commands	*5
Aux Messages	X	X	X	Local On/Off	
	X	X	O (123-124)	All Notes Off	
	O	O	O	Active Sense	
	X	X	X	Reset	
Notes	*1: Sent and received when MIDI Filters In and Out are set to Off in Global mode. *2: Drawbars settings, Sound parameters, Selection of SongBook Entries, Drum Kit Family settings. *3: LSB, MSB = 00,00: Pitch Bend range, =01,00: Fine Tune, =02,00: Coarse Tune. *4: Includes Inquiry, Master Volume and Transpose messages, FX settings, Quarter Tone settings. GM Mode On. *5: Transmitted only when the Clock Send parameter (Global mode) is set to on.				
Mode 1: OMNI ON, POLY	Mode 2: OMNI ON, MONO				O: Yes
Mode 3: OMNI OFF, POLY	Mode 4: OMNI OFF, MONO				X: No

IMPORTANT NOTICE TO CONSUMERS

This product has been manufactured according to strict specifications and voltage requirements that are applicable in the country in which it is intended that this product should be used. If you have purchased this product via the internet, through mail order, and/or via a telephone sale, you must verify that this product is intended to be used in the country in which you reside.

WARNING: Use of this product in any country other than that for which it is intended could be dangerous and could invalidate the manufacturer's or distributor's warranty.

Please also retain your receipt as proof of purchase otherwise your product may be disqualified from the manufacturer's or distributor's warranty.

NOTICE REGARDING DISPOSAL (EU ONLY)

If this symbol is shown on the product, manual, battery, or package, you must dispose of it in the correct manner to avoid harm to human health or damage to the environment. Contact your local administrative body for details on the correct disposal method. If the battery contains heavy metals in excess of the regulated amount, a chemical symbol is displayed below the symbol on the battery or battery package.



In case of electromagnetic radiations a temporary deterioration of the quality of audio performances may occur. A deterioration that might arise can be a sound signal emitted. This will stop when the electromagnetic disturbance ceases.

THE FCC REGULATION WARNING (FOR USA)

This equipment has been tested and found to comply with the limits for a Class B digital device, pursuant to Part 15 of the FCC Rules. These limits are designed to provide reasonable protection against harmful interference in a residential installation. This equipment generates, uses, and can radiate radio frequency energy and, if not installed and used in accordance with the instructions, may cause harmful interference to radio communications. However, there is no guarantee that interference will not occur in a particular installation. If this equipment does cause harmful interference to radio or television reception, which can be determined by turning the equipment off and on, the user is encouraged to try to correct the interference by one or more of the following measures:

- Reorient or relocate the receiving antenna.
- Increase the separation between the equipment and receiver.
- Connect the equipment into an outlet on a circuit different from that to which the receiver is connected.
- Consult the dealer or an experienced radio/TV technician for help.

If items such as cables are included with this equipment, you must use those included items.

Unauthorized changes or modification to this system can void the user's authority to operate this equipment.

DECLARATION OF CONFORMITY (FOR USA)

Responsible Party: KORG USA INC.

Address: 316 SOUTH SERVICE ROAD, MELVILLE

Telephone: 1-631-390-6500

Equipment Type: Professional Arranger

Model: Pa4X

This device complies with Part 15 of FCC Rules. Operation is subject to the following two conditions: (1) This device may not cause harmful interference, and (2) this device must accept any interference received, including interference that may cause undesired operation.

PERCHLORATE (CALIFORNIA, USA ONLY)

Perchlorate Material - special handling may apply. See www.dtsc.ca.gov/hazardous-waste/perchlorate.

KORG

Address

KORG ITALY SpA
Via Cagiata, 85
60027 Osimo (AN)
Italy

Web

www.korg.com