

KORG

PA8000

professional
arranger

E 12

ENGLISH
OS Ver. 2.0
MAN00010002

User's Manual

Important safety instructions

- Read these instructions.
- Keep these instructions.
- Heed all warnings.
- Follow all instructions.
- Do not use this apparatus near water.
- Mains powered apparatus shall not be exposed to dripping or splashing and that no objects filled with liquids, such as vases, shall be placed on the apparatus.
- Clean only with dry cloth.
- Do not block any ventilation openings, install in accordance with the manufacturer's instructions.
- Do not install near any heat sources such as radiators, heat registers, stoves, or other apparatus (including amplifiers) that produce heat.
- Do not defeat the safety purpose of the polarized or grounding-type plug. A polarized plug has two blades with one wider than the other. A grounding type plug has two blades and a third grounding prong. The wide blade or the third prong are provided for your safety. If the provided plug does not fit into your outlet, consult an electrician for replacement of the obsolete outlet. (for U.S.A. and Canada)
- Protect the power cord from being walked on or pinched particularly at plugs, convenience receptacles, and the point where they exit from the apparatus.
- Only use attachments/accessories specified by the manufacturer.
- Unplug this apparatus during lightning storms or when unused for long periods of time.
- Turning off the power switch does not completely isolate this product from the power line so remove the plug from the socket if not using it for extended periods of time, or before cleaning. Please ensure that the mains plug or appliance couple remains readily accessible.
- Refer all servicing to qualified service personnel. Servicing is required when the apparatus has been damaged in any way, such as power-supply cord or plug is damaged, liquid has been spilled or objects have fallen into the apparatus, the apparatus has been exposed to rain or moisture, does not operate normally, or has been dropped.
- Do not install this equipment on the far position from wall outlet and/or convenience receptacle.
- Do not install this equipment in a confined space such as a box for the conveyance or similar unit.
- When a cart is used, use caution when moving the cart/apparatus combination to avoid injury from tip-over.



WARNING:
TO REDUCE THE RISK OF FIRE OR ELECTRIC SHOCK DO NOT EXPOSE THIS PRODUCT TO RAIN OR MOISTURE.

	CAUTION RISK OF ELECTRIC SHOCK DO NOT OPEN	
AVERTISSEMENT: RISQUE DE CHOC ÉLECTRIQUE—NE PAS OUVRIR.		
注意 感電の恐れあり、キャビネットをあけるな		

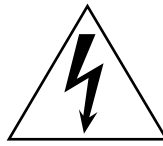

The lightning flash with arrowhead symbol within an equilateral triangle, is intended to alert the user to the presence of uninsulated "dangerous voltage" within the product's enclosure that may be of sufficient magnitude to constitute a risk of electric shock to persons.



The exclamation point within an equilateral triangle is intended to alert the user to the presence of important operating and maintenance (servicing) instructions in the literature accompanying the product.

THE FCC REGULATION WARNING (for U.S.A.)

This equipment has been tested and found to comply with the limits for a Class B digital device, pursuant to Part 15 of the FCC Rules. These limits are designed to provide reasonable protection against harmful interference in a residential installation. This equipment generates, uses, and can radiate radio frequency energy and, if not installed and used in accordance with the instructions, may cause harmful interference to radio communications. However, there is no guarantee that interference will not occur in a particular installation. If this equipment does cause harmful interference to radio or television reception, which can be determined by turning the equipment off and on, the user is encouraged to try to correct the interference by one or more of the following measures:

- Reorient or relocate the receiving antenna.
- Increase the separation between the equipment and receiver.
- Connect the equipment into an outlet on a circuit different from that to which the receiver is connected.
- Consult the dealer or an experienced radio/TV technician for help.

Unauthorized changes or modification to this system can void the user's authority to operate this equipment.

CE mark for European Harmonized Standards

CE mark which is attached to our company's products of AC mains operated apparatus until December 31, 1996 means it conforms to EMC Directive (89/336/EEC) and CE mark Directive (93/68/EEC).

And, CE mark which is attached after January 1, 1997 means it conforms to EMC Directive (89/336/EEC), CE mark Directive (93/68/EEC) and Low Voltage Directive (73/23/EEC).

Also, CE mark which is attached to our company's products of Battery operated apparatus means it conforms to EMC Directive (89/336/EEC) and CE mark Directive (93/68/EEC).

IMPORTANT NOTICE TO CONSUMERS

This product has been manufactured according to strict specifications and voltage requirements that are applicable in the country in which it is intended that this product should be used. If you have purchased this product via the internet, through mail order, and/or via a telephone sale, you must verify that this product is intended to be used in the country in which you reside.

WARNING: Use of this product in any country other than that for which it is intended could be dangerous and could invalidate the manufacturer's or distributor's warranty.

Please also retain your receipt as proof of purchase otherwise your product may be disqualified from the manufacturer's or distributor's warranty.

Notice regarding disposal (for EU only)



If this "crossed-out wheeled bin" symbol is shown on the product or in the operating manual, you must dispose of the product in an appropriate way. Do not dispose of this product along with your household trash. By disposing of this product correctly, you can avoid environmental harm or health risk. The correct method of disposal will depend on your locality, so please contact the appropriate local authorities for details.

Data Handling

Data in memory may sometimes be lost due to incorrect user action. Be sure to save important data to the (optional) internal hard disk or to an external USB device. Korg will not be responsible for damages caused by data loss.

Example screens

Some pages of the manuals show LCD screens along with an explanation of functions and operations. All sound names, parameter names, and values are merely examples and may not always match the actual display you are working on.

Cleaning the display

Use a soft cotton cloth to clean the screen. Some materials, such as paper towels, could cause scratches and damage it. Computer wipes are also suggested, provided they are specifically designed for LCD screens.

Do not spray any liquids on the LCD screen directly. Always apply the solution to your cloth first, then clean the screen.

Trademarks

Akai is a registered trademark of Akai Professional Corporation. Macintosh is a registered trademark of Apple Computer, Inc. MS-DOS and Windows are registered trademarks of Microsoft Corporation. TC-Helicon is a registered trademark of TC Electronic, Inc. All other trademarks or registered trademarks are the property of their respective holders.

Disclaimer

The information contained in this manual have been carefully revised and checked through. Due to our constant efforts to improve our products, the specifications might differ to those in the manual. Korg is not responsible for any eventual differences found between the specifications and the contents of the instruction manual – the specifications being subject to change without prior notice.

Liability

Korg products are manufactured under strict specifications and voltages required by each country. These products are warranted by the Korg distributor only in each country. Any Korg product not sold with a warranty card or carrying a serial number disqualifies the product sold from the manufacturer's/distributor's warranty and liability. This requirement is for your own protection and safety.

Service and User's Assistance

For service, please contact your nearest Authorized Korg Service Center. For more information on Korg products, and to find software and accessories for your keyboard, please contact your local Authorized Korg distributor. For up-to-date information, please point your web browser to www.korgpa.com.

Copyright © 2008 KORG Italy Spa. Printed in Italy.

Keep your keyboard up-to-date

Your instrument can be constantly updated as new versions of the operating system are released by Korg. You can download the operating system from www.korgpa.com. Please, read the instructions supplied with the operating system.

The BALANCE slider

When turning the instrument on, please be assured the BALANCE slider is set to the center. This sets both Sequencer 1 and Sequencer 2 to their maximum level. This will avoid you start a Song without hearing anything.

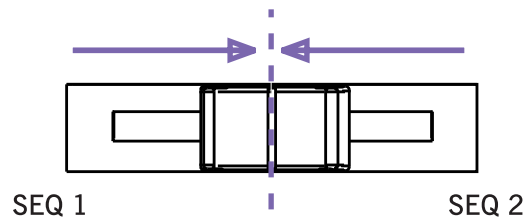

Table of Contents

Introduction

Easy Mode	6
The Style Play page in detail	7
The Song Play page in detail	8
The Lyrics page in detail	9
Front panel	10
Rear panel	18
Welcome!	20
Live Performing	20
Easy Mode	20
Useful links	21
What's in the box	21
About this manual	21
Making a backup of the original data	22
Loading the Operating System	22
Loading the Musical Resources	22
Start up	23
Connecting the AC power cord	23
Turning the instrument on and off	23
Controlling the Volume	23
The Sequencer's BALANCE slider	23
Headphones	23
Audio Outputs	24
Audio Inputs	24
MIDI connections	24
Damper Pedal	24
Demo	24
The music stand	24
Glossary of Terms	25
Sound	25
Style	25
Pad	25
Keyboard tracks	25
Performance	26
Sequencer	26
The LOGO decoder	26
Interface basics	27
The Color TouchView™ graphical user interface	27
Operative modes	29
Selected, highlighted items	29
Non-available, grayed-out parameters	29
Shortcuts	29

Quick Guide

Turning the instrument on and listening to the demos	32
Turning the instrument on, and viewing the main screen	32
Playing the demos	32
Playing Sounds	33
Selecting a Sound and playing it on the keyboard	33
Playing two or three Sounds at the same time	35
Playing different Sounds with your left and right hand	37
Changing the split point	38
Raising or lowering the Upper octave	39

Selecting and saving Performances	40
Selecting a Performance	40
Saving your settings to a Performance	41
Selecting and playing Styles	44
Selecting and playing a Style	45
Tempo	46
Intro, Fill, Variation, Ending	47
Single Touch Settings (STS)	48
The Pads	48
Adjusting balance between the Style and the keyboard	49
Adjusting volume of each single track	49
Turning Style tracks on/off	50
Adding harmony notes to your right-hand melody with the ENSEMBLE function	51
Song Play	53
Selecting a Song to play	53
Playing back a Song	55
Changing tracks volume	56
Turning Song tracks on/off	58
Soloing a track	58
Mixing two Songs	59
The SongBook	60
Selecting the desired entry from the Main List	60
Displaying Artist or Genre	61
Sorting entries	62
Searching entries	63
Adding entries	65
Creating a Custom List	67
Selecting and using a Custom List	69
Selecting a SongBook STS	69
Singing with a connected microphone	70
Connecting a microphone	70
Applying harmony to your voice	72
Soloing your voice (TalkBack)	73
Locking Voice Processor settings	73
Recording a new Song	74
Entering Backing Sequence (Quick Record) mode	74
Preparing to record	75
Recording	76
Second-take recording (Overdubbing)	77
Saving a Song to disk	77

Reference

Selecting elements	80
Sound Select window	80
Performance Select window	80
Style Select window	81
Pad Select window	81
STS Select	82
Song Select window	82
Style Play operating mode	85
Start-up settings	85
How Styles, Performances and STSs are linked together	85
Master Volume and Balance	85
Factory, User and Favorite Styles	85
Main page (Normal view)	86

Style Tracks view page	88
Volume panel	89
Lyrics panel	90
STS Name panel	90
Mic panel	91
Sub-Scale panel	92
Pad panel	92
Split panel	92
Edit menu	93
Edit page structure	93
Mixer/Tuning: Volume/Pan	93
Mixer/Tuning: FX Send	94
Mixer/Tuning: EQ Gain	95
Mixer/Tuning: EQ Control	95
Mixer/Tuning: Tuning	96
Mixer/Tuning: Sub Scale	96
Effects: FX Select	98
Effects: FX A...D	99
Track Controls: Mode	99
Track Controls: Drum Volume	100
Track Controls: Easy Edit	101
Keyboard/Ensemble: Keyboard Control	102
Keyboard/Ensemble: Key/Velocity Range	102
Keyboard/Ensemble: Ensemble	103
Style Controls: Drum/Fill	104
Style Controls: Keyboard Range On/Off / Wrap Around	104
Pad/Switch: Pad	105
Pad/Switch: Assignable Switch	105
Preferences: Style Preferences	106
Preferences: Style Play Setup	107
Page menu	108
Write Performance dialog box	109
Write Single Touch Setting dialog box	109
Write Style Performance dialog box	110
Write Global-Style Play Setup dialog box	110
The Favorite banks	110
Style Record mode	111
The Style structure	111
Style Import/Export	112
Entering the Style Record mode	112
Exit by saving or deleting changes	113
Listening to the Style while in Edit mode	113
List of recorded events	113
Main page - Record 1	114
Main page - Record 2/Cue	117
Main page - Guitar Mode	118
Style Record procedure	120
Edit menu	123
Edit page structure	123
Event Edit: Event Edit	124
Event Edit: Filter	126
Style Edit: Quantize	126
Style Edit: Transpose	127
Style Edit: Velocity	127
Style Edit: Cut	128
Style Edit: Delete	129
Style Edit: Delete All	129
Style Edit: Copy from Style	130
Style Edit: Copy from Pad	131
Style Element Track Controls: Sound/Expression	131
Style Element Track Controls: Keyboard Range	132
Style Element Track Controls: Noise/Guitar	133
Style Element Chord Table: Chord Table	133

Style Track Controls: Type/Trigger/Tension	133
Import: Import Groove	134
Import: Import SMF	135
Export SMF	137
Page menu	138
Write Style dialog box	138
Copy Key/Chord dialog box	139
Copy Sounds dialog box	139
Copy Expression dialog box	139
Copy Key Range dialog box	140
Copy Chord Table dialog box	140
Overdub Step Recording window	140
Pad Record mode	142
The Pad structure	142
Entering the Pad Record mode	142
Exit by saving or deleting changes	143
Listening to the Pad while in Record/Edit mode	143
Main page - Record 1	143
Main page - Guitar Mode	146
Pad Record procedure	147
Edit menu	148
Edit page structure	148
Event Edit: Event Edit	148
Event Edit: Filter	149
Pad Edit: Quantize	149
Pad Edit: Transpose	149
Pad Edit: Velocity	150
Pad Edit: Cut	150
Pad Edit: Delete	151
Pad Edit: Delete All	151
Pad Edit: Copy from Style	152
Pad Edit: Copy from Pad	152
Pad Track Controls: Sound/Expression	153
Pad Chord Table	154
Import: Import Groove	154
Import: Import SMF	154
Export: SMF	155
Page menu	155
Write Pad dialog box	156
Song Play operating mode	157
Transport controls	157
MIDI Clock	157
Tempo Lock and Link Mode	157
Master Volume, Balance, Sequencer Balance	157
Track parameters	157
Standard MIDI Files and Sounds	157
NRPN Sound parameters	158
Keyboard, Pad and Sequencer tracks	158
Main page	159
Song Tracks 1-8 and 9-16 pages	161
Volume panel	162
Jukebox panel	163
Lyrics / Score panel	164
STS Name panel	167
Mic panel	167
Sub-Scale panel	167
Pad panel	167
Split panel	167
Edit menu	168
Edit page structure	168
Switching between sequencers during editing	168
Mixer/Tuning: Volume/Pan	169
Mixer/Tuning: FX Send	170

Mixer/Tuning: EQ Gain	171
Mixer/Tuning: EQ Control	171
Mixer/Tuning: Tuning	172
Effects: FX Select	172
Effects: FX A...D	173
Track Controls: Mode	173
Track Controls: Drum Volume	173
Track Controls: Easy Edit	173
Keyboard/Ensemble: Keyboard Control	173
Keyboard/Ensemble: Key/Velocity Range	173
Keyboard/Ensemble: Ensemble	174
Pad/Switch: Pad	174
Pad/Switch: Assignable Switch	174
Jukebox Editor	174
Groove Quantize	175
Preferences: Track Settings	176
Preferences: General Control	176
Page menu	178
Write Global-Song Play Setup dialog box	179
SongBook	180
Book	180
Book Edit 1	182
Book Edit 2	184
Custom List	185
List Edit	185
Lyrics/STS	186
Info	187
Page menu	187
Sequencer operating mode	189
Transport controls	189
The Songs and the Standard MIDI File format	189
Songs and Voice Processor Presets	189
Sequencer Play - Main page	189
Entering Record mode	191
Record mode: Multitrack Sequencer page	192
Record mode: Step Record page	194
Record mode: Backing Sequence (Quick Record) page	196
Record mode: Step Backing Sequence page	198
Edit menu	201
Edit page structure	201
Mixer/Tuning: Volume/Pan	201
Mixer/Tuning: FX Send	202
Mixer/Tuning: EQ Gain	203
Mixer/Tuning: EQ Control	203
Mixer/Tuning: Tuning	204
Mixer/Tuning: Sub Scale	204
Effects: FX Select	204
Effects: FX A...D	205
Track Controls: Mode	205
Track Controls: Drum Volume	205
Track Controls: Easy Edit	205
Event Edit: Event Edit	205
Event Edit: Filter	207
Song Edit: Quantize	207
Song Edit: Transpose	208
Song Edit: Velocity	208
Song Edit: Cut/Insert Measures	209
Song Edit: Delete	209
Song Edit: Copy	209
Song Edit: Move	210
Song Edit: RX Convert	210
Preferences: Sequencer Setup	211
Page menu	211
Write Global-Sequencer Setup dialog box	212
Song Select window	212
Save Song window	213
Global edit mode	215
What is it, and how the Global is structured	215
Main page	215
Edit menu	215
Edit page structure	215
General Controls: Basic	216
General Controls: Transpose Control	217
General Controls: Scale	217
General Controls: Lock	218
General Controls: Interface	220
Controllers: Pedal/Switch	222
Controllers: Assignable Sliders	222
Controllers: EC5	223
MIDI: MIDI Setup / General Controls	223
MIDI: MIDI In Control	224
MIDI: MIDI In Channels	225
MIDI: MIDI Out Channels	225
MIDI: Filters	226
Audio Setup: Sty/Kbd	226
Audio Setup: Seq1	227
Audio Setup: Seq2	227
Audio Setup: Drums	227
Audio Setup: Audio In	228
Audio Setup: Metro / MP3 / Speakers	228
Audio Setup: Master EQ	229
Voice Processor Setup and Preset sections	229
Video Interface: Video Out	230
Touch Panel Calibration	230
Page menu	231
Write Global - Global Setup dialog box	231
Write Global - Midi Setup dialog box	231
Write Global - Talk Configuration dialog box	232
Write Global - Voice Processor Setup dialog box	232
Write Global - Voice Processor Preset dialog box	232
Write Quarter Tone SC Preset dialog box	232
Voice Processor	233
Accessing the Voice Processor edit pages	233
Voice Processor Setup: Setup	233
Voice Processor Setup: Dynamics / EQ	234
Voice Processor Setup: Talk	234
Voice Processor Preset: Preset	235
Voice Processor Preset: Harmony	236
Voice Processor Preset: Harmony Voices	237
Voice Processor Preset: Effects	239
Harmony and Tuning with the Voice Processor	240
Media edit mode	243
Storage devices and internal memory	243
Supported device	243
Selecting and deselecting files	243
Searching files	244
File types	245
Media structure	245
Main page	246
Page structure	246
Navigation tools	246
Load	247
Save	250
Copy	254
Erase	255
Format	256

Utility	256
Preferences	257
USB	258
Page menu	259
Care of mass storage devices	261
Merging PCM samples from various sources	261
Bonus software	262

MIDI	263
What is MIDI?	263
What is MIDI Over USB?	263
Standard MIDI Files	264
The General MIDI standard	264
The Global channel	264
The Chord 1 and Chord 2 channels	264
The Control channel	264
MIDI Setup	264
Connecting Pa800 to a Master keyboard	265
Connecting the Pa800 to a MIDI accordion	265
Connecting the Pa800 to an external sequencer	266
Playing another instrument with the Pa800	267

Appendix

Factory data	270
Styles	270
Style Elements	274
Style and Player controls	274
Single Touch Settings (STS)	274
Sounds (Bank order)	275
Sounds (Program Change order)	284
DNC Sounds	293
Drum Kits	295
Multisamples	296
Drum Samples	301
Performances	307
Pads	309
Effects	312
MIDI Setup	314

Assignable parameters	315
List of Footswitch and EC5 functions	315
List of Assignable Pedal and Assignable Slider (A/B) functions	316
List of Assignable Slider (Mic) functions	317
List of Assignable Switch functions	317
Scales	318
MIDI Data	319
MIDI Controllers	319
Program Change messages used as remote commands	320
Control Change and Program Change message used as remote commands	320
MIDI Implementation Chart	321
Recognized chords	322
Installing the MP3 Board (EXBP-Dual MP3)	324
Precautions	324
Installation	324
Playing MP3 files	325
Recording MP3 files	325
Installing the Video Interface (VIF4)	327
NTSC, PAL, SECAM	327
Precautions	327
Installation	327
Connections and setup	328
Installing the Korg USB MIDI Driver	329
Connecting the Pa800 to a personal computer	329
KORG USB-MIDI Driver system requirements	329
Please note before use	329
Windows: Installing the KORG USB-MIDI Driver	329
Mac OS X: Installing KORG USB-MIDI Driver	330
Shortcuts	331
Troubleshooting	332
Technical specifications	334
Index	336

Introduction

Easy Mode

If you have never used an arranger before, we suggest you to switch to the Easy Mode. Easy Mode allows you to play Styles and Songs with a simple user interface, free from the many advanced parameters that you will want to learn at a later date.

Turning the Easy Mode on

Touch the little rectangle on the top right corner of the display, to open the **page menu**:

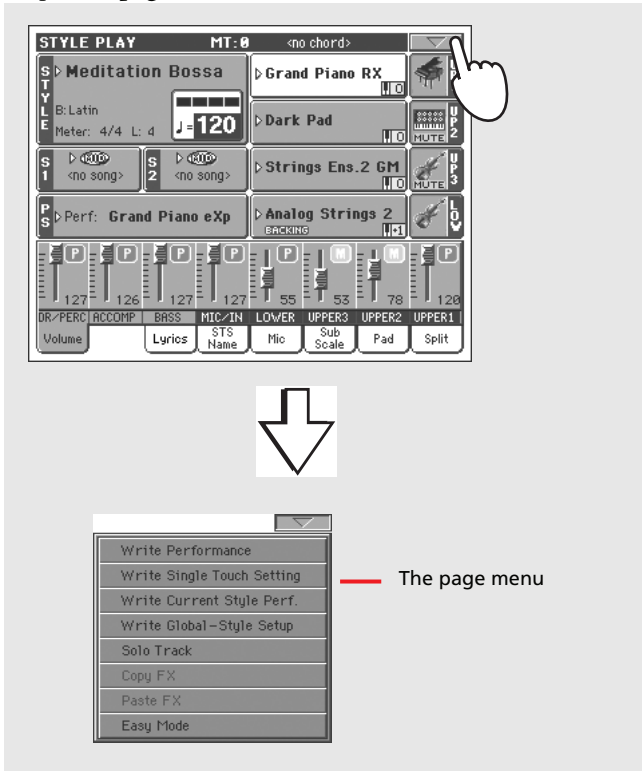

Touch the “Easy Mode” menu item, to make the checkmark appear:

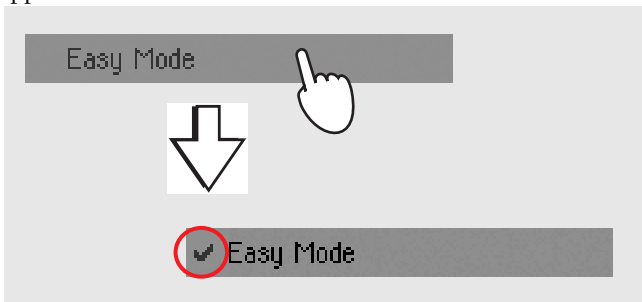

At this point, the Easy Mode has been activated, and the elements in the display appear less cluttered:

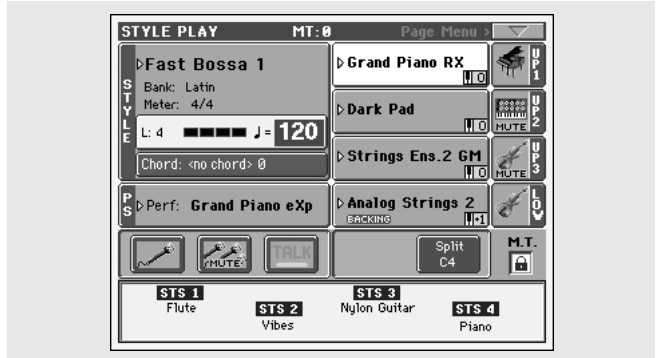

Turning the Easy Mode off

The instrument will stay in this mode even after having been turned off. Repeat the above operation when you want to deactivate the Easy Mode.

Switching between Styles and Songs

Depending on what you want to play, you must switch to Style Play mode or Song Play mode.

- Press the STYLE PLAY button to switch to the Style Play mode and play Styles. This is the mode you are in when you first turn the instrument on.
- Press the SONG PLAY button to switch to the Song Play mode and play Songs.

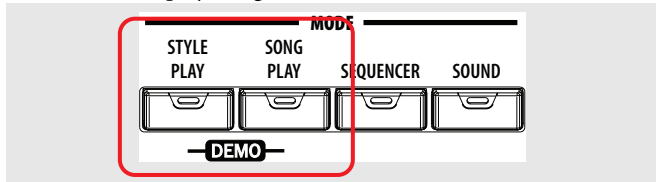

The Style Play page in detail

STYLE PLAY MT: 0 Page Menu >

Fast Bossa 1
Bank: Latin
Meter: 4/4
L: 4 [Progress bar] J=120
Chord: <no chord> 0

UPPER HAND SOUNDS:
 ▷ Grand Piano RX (UP1)
 ▷ Dark Pad (UP2)
 ▷ Strings Ens.2 GM (UP3)

LOWER HAND SOUND:
 ▷ Analog Strings 2 (LOW)

PERFORMANCE (P) & STS:
 ▷ Perf: Grand Piano exp
 STS 1 Flute
 STS 2 Vibes
 STS 3 Nylon Guitar
 STS 4 Piano

CONTROL PANEL:
 MUTE, TALK, Split C4, M.T. (lock icon)

Annotations:
 - Style name and info. Touch the Style's name to open the Style Select window and choose a different Style. → page 81
 - Sounds assigned to the right hand (UP1 to UP3) and to the left hand (LOW). Touch the Sound's name to open the Sound Select window and choose a different Sound. → page 80
 - Tempo. Use the DIAL to change it.
 - Length of the accompaniment pattern, and current beat.
 - Performance or STS. Touch it to open the Performance Select window and choose a different Performance. Sounds on the keyboard will change. → page 80
 - Touch it to turn the microphone on/off. → page 70
 - Touch it to turn the voice harmony on/off. → page 72
 - Touch it to talk to your audience. → page 73
 - Single Touch Settings (STS). Touch one of them to choose it, or use the dedicated buttons on the control panel. Sounds on the keyboard will change. → page 82
 - Sound icon and status. If the MUTE icon appears, the Sound is in mute and cannot be heard. If the icon does not appear, the Sound is in play and can be heard. → page 35
 - Close this lock to avoid transposition when choosing a different Performance or Style. → page 218
 - Touch here to change the Split Point. → page 38

Notes:

- There are three Sounds for the right hand (Upper 1, Upper 2, Upper 3), and only one Sound for the left hand (Lower). Their names are abbreviated as UP1, UP2 UP3, LOW, and are shown in the right side of the display.
- Right hand (Upper) and left hand (Lower) Sounds are separated by the Split Point.

- Performances and STSs are collections of Sounds. Just choose one of them to change all the Sounds of the keyboard (and, when the STYLE CHANGE LED is lit on the control panel, of the Style).
- Choose a Style to change the musical style of the accompaniment patterns. Touching the Style name in the display is the same as to press one of the buttons of the STYLE section on the control panel.

The Song Play page in detail

Song assigned to Sequencer 1. Touch it to open the Song Select window and choose a different Song. → page 82

Tempo. Use the DIAL to change it.

Song assigned to Sequencer 2. Touch it to open the Song Select window and choose a different Song. → page 82

Performance or STS. Touch it to open the Performance Select window and choose a different Performance. Sounds on the keyboard will change. → page 80

Touch it to turn the microphone on/off. → page 70

Touch it to turn the voice harmony on/off. → page 72

Touch it to talk to your audience. → page 73

Single Touch Settings (STS). Touch one of them to choose it, or use the dedicated buttons on the control panel. Sounds on the keyboard will change. → page 82

Sounds assigned to the right hand (UP1 to UP3) and to the left hand (LOW). Touch the Sound's name to open the Sound Select window and choose a different Sound. → page 80

Sound icon and status. If the **MUTE** icon appears, the Sound is in mute and cannot be heard. If the icon does not appear, the Sound is in play and can be heard. → page 35

Close this lock to avoid transposition when choosing a different Performance or Style. → page 218

Touch here to change the Split Point. → page 38

Touch here to see the Song's Lyrics. → page 9

Notes:

- As in Style mode, there are three Sounds for the right hand (Upper 1, Upper 2, Upper 3), and only one Sound for the left hand (Lower). Their names are abbreviated as UP1, UP2, UP3, LOW, and are shown in the right side of the display.
- Right hand (Upper) and left hand (Lower) Sounds are separated by the Split Point.
- Performances and STSs are collections of Sounds. Just choose one of them to change all the Sounds of the keyboard.

- Available STSs depend on the Style you last selected.
- Since there are two onboard Sequencers, you can play two Songs at the same time. Mix them using the SEQUENCER BALANCE slider on the control panel.
- Touching a Song name in the display is the same as to press one of the SELECT buttons on the control panel. Each Sequencer has its own SELECT and transport buttons.

The Lyrics page in detail

The screenshot shows the Lyrics page interface. At the top, there's a header bar with 'B min7 0', 'MT:0', and 'M: 16'. Below this, the lyrics are displayed in large, bold, black text: 'HAVE SOME FUN', 'THROW AWAY THE WORK', 'WELL MY FRIENDS THE', 'TIME HAS COME', and 'TO RAISE THE ROOF AND'. At the bottom, there are four instrument selection buttons: '1 Flute', '2 Vibes', '3 Nylon Guitar', and '4 Piano'. The song name 'Canyon' is centered at the very bottom. On the right side, there's a vertical menu with tabs: 'Seq.1', 'Seq.2', 'Style', 'Mark Seq.1', 'Mark Seq.2', 'Score 1', 'Score 2', and 'Options'. Red lines and boxes highlight these elements, with callouts explaining their functions.

Master Transpose. → page 159

Chord (if included in the Song).

Current beat and measure number.

Lyrics are shown in this area.

Use these tabs to see Lyrics of the Song assigned to Sequencer 1, Sequencer 2 or the Style. → page 164

Use these tabs to see Markers set for the Song assigned to Sequencer 1 or Sequencer 2. → page 165

Use these tabs to see the Score of the Song assigned to Sequencer 1 or Sequencer 2. → page 165

Use this tab to set the display options. → page 167

STS. Either touch them to select, or use the SINGLE TOUCH SETTING buttons under the display. → page 14

Name of the Song in play.

Notes:

- Exit from this page by pressing the EXIT button.
- When you switch to a different Sequencer using the SEQUENCER BALANCE slider, the Lyrics shown in the display may change (see “Lyrics/Score Balance Link” on page 177).

Front panel

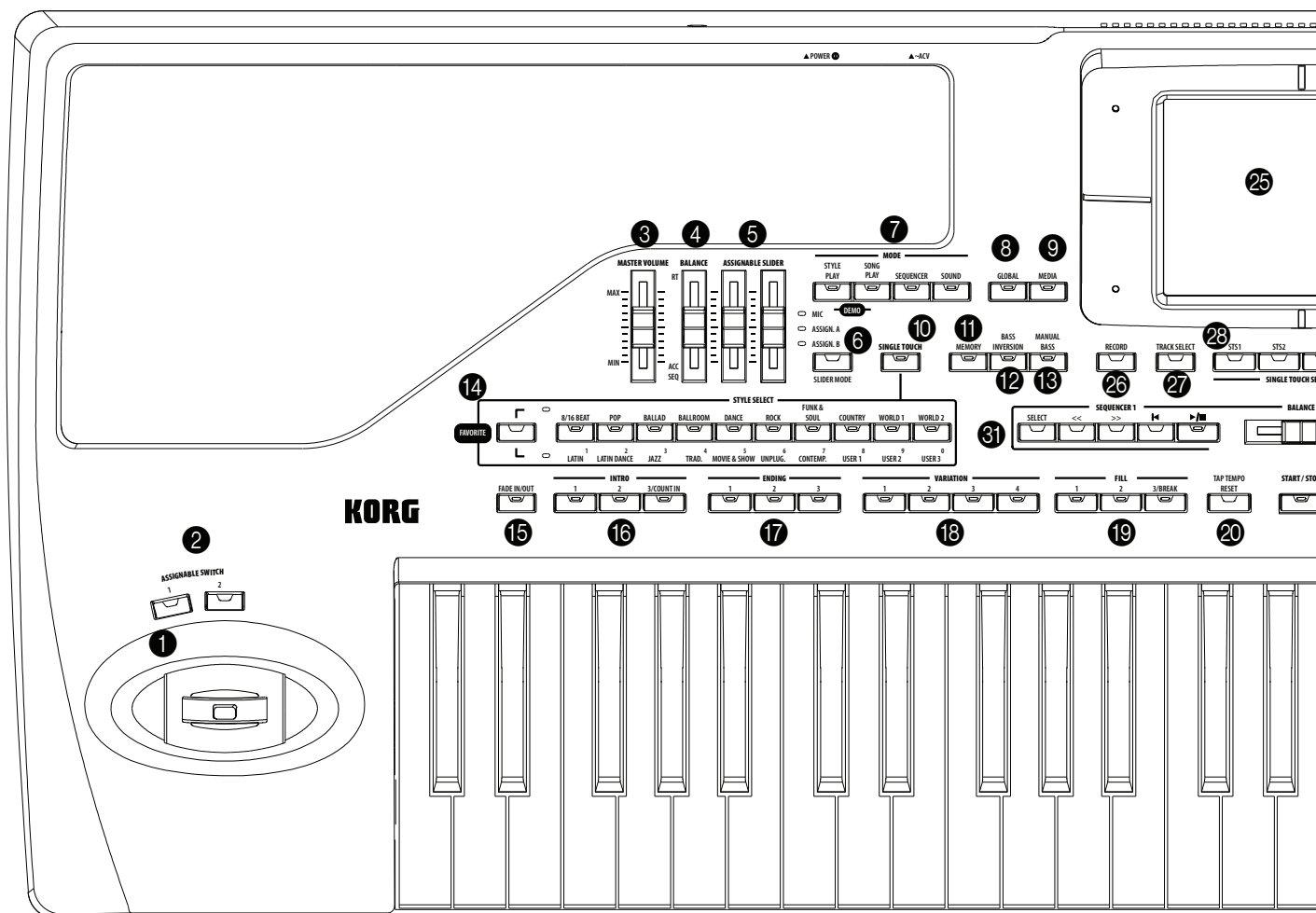

1 JOYSTICK

This joystick triggers different functions, depending on the direction it is moved towards.

X (+/-) Move the joystick towards the left (-) to lower the pitch, or towards the right (+) to raise it. This is also called Pitch Bend.

Y+ Move the joystick forward to trigger Modulation.

Y- Move the joystick backward, to trigger the function assigned in Sound mode.

2 ASSIGNABLE SWITCH

These are freely assignable switches (see “Pad/Switch: Assignable Switch” on page 105 for information on how to assign functions to them).

3 MASTER VOLUME

This slider controls the overall volume of the instrument, both of the internal speakers, the LEFT/MONO and RIGHT outputs, and the HEADPHONES output. It does not control the volume of the 1 and 2 sub-outputs.

This slider also controls the volume of the microphone connected to the AUDIO INPUT 1, when it is sent to the Voice Pro-

cessor. It does not control the signal entering the AUDIO INPUTs (1 and 2) when they are directly sent to the outputs, without entering the Voice Processor (see “Audio Setup: Audio In” on page 228).

Warning: At the maximum level, with rich-sounding Songs, Styles or Sounds, the internal speakers of Pa800 might distort during signal peaks. Should this happen, lower the Master Volume a little.

4 BALANCE

By default, this slider balances the volume of the Keyboard tracks, against the Style (Accompaniment), Pad and Song tracks. As an alternative, the slider can be used to control the Style/Song Volume without affecting the Keyboard tracks (see “Balance Slider” on page 221 for information on setting the slider’s behavior).

This is a relative control, whose effective maximum level is determined by the MASTER VOLUME slider position.

When moved, a magnified version of the virtual slider appears in the display, for more accurate positioning.

Note: This slider only works in Style Play and Song Play mode; it does not work in Sequencer mode.

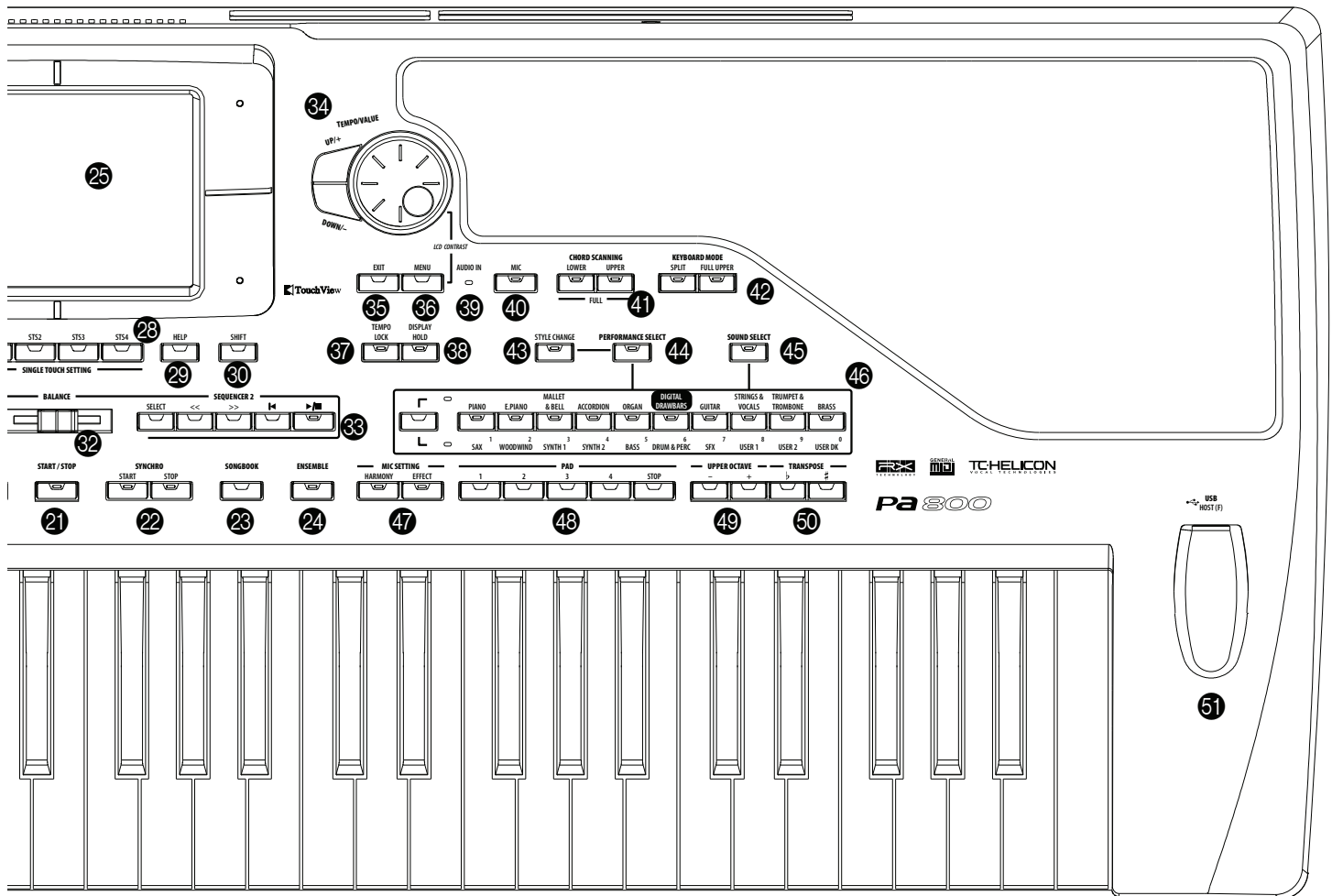

5 ASSIGNABLE SLIDER ▶GBL Gbl

These are freely assignable sliders (see “Controllers: Assignable Sliders” on page 222 for information on how to assign functions to them). Three operating modes are available, and can be selected by pressing the SLIDER MODE button (see below).

SHIFT You can use these sliders to change the volume of several tracks at once. While in Style Play or Sequencer mode, select one of the Upper tracks, or one of the separate Style or Song tracks in the display; then keep the SHIFT button pressed, and move one of these sliders to proportionally change the volume of all similar tracks.

Note: This only works in Style Play and Sequencer modes; it does not work in Song Play mode.

Here are three ways of working of this special function:

- *In Style Play mode:* First select one of the Upper tracks. Then keep SHIFT pressed and move one of the sliders, to proportionally change the volume of all Upper tracks at the same time.
- *In Style Play mode:* First press TRACK SELECT and select one of the separate Style tracks. Then keep SHIFT pressed and move one of the sliders, to proportionally change the volume of all Style tracks at the same time.

- *In Sequencer mode:* Keep SHIFT pressed and move one of the sliders, to proportionally change the volume of all Song tracks at the same time.

6 SLIDER MODE ▶PERF ▶STS ▶STS^{SB}

Use this button to select one of the three available operating modes for the sliders. The sliders can be freely programmed in Global mode (see “Controllers: Assignable Sliders” on page 222).

MIC While this mode is active, the sliders control two parameters related to the microphone. By default, the left slider controls the volume, while the right one controls the FX level.

ASSIGN. A First set of freely assignable controls.

ASSIGN. B Second set of freely assignable controls.

7 MODE section

Each of these buttons recalls one of the instrument’s operating modes. When selected, each mode excludes the others.

STYLE PLAY Style Play mode, where you can play Styles (automatic accompaniments) and play up to four Keyboard tracks and four Pad tracks.

In the main page, Keyboard tracks are shown in the right half of the display. You can reach the main page by pressing EXIT from any of the Style Play edit pages. If you are in a different operating mode, press STYLE PLAY to recall the Style Play mode. If Keyboard tracks are not shown in the display, press the TRACK SELECT button to see them.

This operating mode is automatically selected when turning the instrument on.

SONG PLAY Song Play mode, where you can play back Songs in Standard MIDI File (SMF or KAR) and MP3 format (*MP3 files can only be played if the optional EXBP-Dual MP3 board installed*). Since the Pa800 is equipped with two sequencers, you can even play two Songs at the same time, and mix them with the SEQUENCER BALANCE slider.

In addition to the Song tracks, you can play up to four Keyboard tracks along with the Song(s). In the main page, Keyboard tracks are shown in the right half of the display. You can reach the main page by pressing EXIT from any of the Song Play edit pages. If you are in a different operating mode, press SONG PLAY to recall the Song Play mode. Use the TRACK SELECT button to cycle between Keyboard and Song tracks.

SEQUENCER Sequencer mode, where you can play, record or edit a Song. The Backing Sequence mode lets you record a new Song based on the Keyboard and Style tracks, and save it as a new Standard MIDI File.

SOUND Sound mode, to play single Sounds on the keyboard, or edit them. By pressing RECORD you can enter the Sampling mode, Pa800 full-featured sampler.

DEMO Press the STYLE PLAY and SONG PLAY buttons together to select the Demo mode. This mode lets you listen to some Demo Songs, to let you understand the sonic power of the Pa800. To exit from this mode, press any of the MODE buttons.

8 GLOBAL

This button recalls the Global edit environment, where you can adjust various global settings. This edit environment overlaps any operating mode, that still remains active in the background. Press EXIT to go back to the underlying operating mode.

9 MEDIA

This button recalls the Media edit environment, where you can execute various operations on files and storage devices (Load, Save, Format, etc...). This edit environment overlaps any operating mode, that still remains active in the background. Press EXIT to go back to the underlying operating mode.

10 SINGLE TOUCH

This button turns the Single Touch and Variation/STS Link functions on or off.

On When a different Style (or the same again) is selected, a Single Touch Setting (STS1) is automatically selected. The Keyboard sounds and

effects will change, along with the Style sounds and effects. Pad sounds will change too.

Flashing Variation/STS Link function activated. This function makes each Variation recall the corresponding STS when selected. For example, select Variation 2, and STS 2 will be automatically recalled; select Variation 3, and STS 3 will be automatically recalled.

Off When you select a different Style (or the same again), the Style sounds and effects will change, as well as Pad sounds. The Keyboard sounds and effects will not change.

11 MEMORY ▶SB

This button turns the Lower and Chord Memory functions on or off. Go to the “Preferences: Style Preferences” edit page (Style Play mode, see page 106) to decide if this button should be a Chord Memory only, or a Lower/Chord Memory button. When it works as a Lower/Chord Memory:

Note: This function can be automatically activated by playing the keyboard harder. See “Velocity Control” on page 106.

On The sound on the left of the split point, and the chord for the automatic accompaniment, are kept in memory even when you raise your hand from the keyboard.

Off The sound and chords are released as soon as you raise your hand from the keyboard.

SHIFT You can jump to the Style Play > Style Preferences page by keeping SHIFT pressed, and pressing the MEMORY button.

12 BASS INVERSION ▶PERF ▶STS ▶STS^{SB}

This button turns the Bass Inversion function on or off.

Note: This function can be automatically activated by playing the keyboard harder. See “Velocity Control” on page 106.

On The lowest note of a chord played in inverted form will always be detected as the root note of the chord. Thus, you can specify to the arranger composite chords such as “Am7/G” or “F/C”.

Off The lowest note is scanned together with the other chord notes, and is not always considered as the root note.

13 MANUAL BASS ▶PERF ▶STS ▶STS^{SB}

This button turns the Manual Bass function on or off.

Note: When you press the MANUAL BASS button, the Bass track volume is automatically set to its maximum value. The volume is automatically set back to the original value when the MANUAL BASS button is deactivated.

On The automatic accompaniment stops playing (apart for the Drum and Percussion tracks), and you can manually play the Bass track on the Lower part of the keyboard. You can start the automatic accompaniment again by pressing one of the CHORD SCANNING buttons.

Off The bass track is automatically played by the Style.

14 STYLE SELECT section

▶PERF

Use these buttons to open the Style Select window and select a Style. See “Style Select window” on page 81.

The leftmost button lets you select the upper or lower row of Style banks, or the Favorite Style banks. Press it repeatedly to select one of the rows. (After both LEDs have turned on, press the button again to turn them off).

Upper LED On Upper-row Styles selected. These are ten factory-programmed banks.

Lower LED On Lower-row Styles selected. These are seven factory-programmed banks, plus three user-programmed banks.

Both LEDs On **FAVORITE** Styles selected. These are custom-made banks.

A word about Style banks and names. Styles in banks from “8BEAT/16 BEAT” to “WORLD 2”, and from “LATIN” to “CON-TEMP” are standard Styles, the user can’t normally overwrite with a Load operation (unless you remove the protection; see “Factory Style and Pad Protect” on page 257).

Styles in banks from “USER1” to “USER3” are location where you can load new Styles from an external device, or save newly created or edited Styles.

Like the User Styles, Styles in the “FAVORITE” banks are locations where you can load new Styles from an external device, or save newly created or edited Styles. In addition, you can edit the names of these banks as it appears in the display, so that you can have a custom set of Styles. See “The Favorite banks” on page 110.

Each button (Style bank) contains four pages, each with up to eight Styles. Repeatedly press a bank button to cycle between the available pages.

SHIFT If you keep the SHIFT button pressed, and press one of the buttons of this section, the “Write Style Performance” window appears in the display, and you can save the current Style Performance (see “Write Style Performance dialog box” on page 110).

15 FADE IN/OUT

When the Style or Song is not playing, press this button to start it with a volume fade-in (the volume goes from zero to the maximum).

When the Style or Song is playing back, press this button to stop it with a volume fade-out (the volume gradually decreases).

You don’t need to press START/STOP or PLAY/STOP to start or stop the Style or Song.

Note: This does not work in Sequencer mode.

SHIFT You can jump to the Global > Basic page by keeping SHIFT pressed, and pressing the FADE IN/OUT button.

16 INTRO 1-3/COUNT IN buttons▶PERF ▶PERF^{Sty} ▶SB

These buttons turn the corresponding Intro on. After pressing one of these buttons, start the Style, and it will begin with the selected intro. The INTRO LED automatically goes off at the end of the intro.

Press them twice (LED blinking) to let them play in loop, and select any other Style element (Fill, Intro, Variation...) to exit the loop.

Note: Intro 1 plays a short sequence with different chords, while Intro 2 plays on the latest recognized chord. Intro 3 is usually a one-bar Count In.

17 ENDING 1-3 buttons▶PERF ▶PERF^{Sty} ▶SB

While the Style is running, these three buttons trigger an Ending, and stop the Style. Press one of them, and the Style will stop running with an Ending. If pressed while the Style is stopped, they act as three additional Intros.

Press them twice (LED blinking) to let them play in loop, and select any other Style element (Fill, Intro, Variation...) to exit the loop.

Note: Ending 1 plays a short sequence with different chords, while Ending 2 plays on the latest recognized chord. Ending 3 starts immediately, and is just two measures long.

18 VARIATION 1-4 buttons▶PERF ▶PERF^{Sty} ▶SB

Each of these buttons selects one of the four variations of the current Style. Each variation can vary in patterns and sounds.

SHIFT You can jump to the Style Play > Drum/Fill page by keeping SHIFT pressed, and pressing one of the VARIATION buttons.

19 FILL 1-3/BREAK buttons▶PERF ▶PERF^{Sty} ▶SB

These buttons trigger a fill-in. Press them twice (LED blinking) to let them play in loop, and select any other Style element (Fill, Intro, Variation...) to exit the loop.

Note: Fill 3 is usually a Break.

Note: This function can be automatically activated by playing the keyboard harder. See “Velocity Control” on page 106.

SHIFT You can jump to the Style Play > Drum/Fill page by keeping SHIFT pressed, and pressing one of the FILL buttons.

20 TAP TEMPO/RESET

This is a double-function button, acting in a different way depending on the Style status (stop/play).

Tap Tempo: When the Style is not playing, you can “beat” the tempo on this button. At the end, the accompaniment starts playing, using the “tapped in” tempo.

Reset: When you press this button while the Style is playing back, the Style pattern goes back to the beginning of measure 1.

21 START/STOP

Starts or stops the Style running.

Note: This function can be automatically activated by playing the keyboard harder. See “Velocity Control” on page 106.

SHIFT You can reset all ‘frozen’ notes and controllers on the Pa800 and any instrument connected to its MIDI OUT or the USB Device port, by using the “Panic” key combination. Just press SHIFT + START/STOP to stop all notes and reset all controllers.

22 SYNCHRO START / STOP buttons ▶SB

These buttons turn the Synchro Start and Synchro Stop functions on or off. This lets you decide if you must press START/STOP to start and/or stop a Style, or just play the keyboard.

Start On, Stop Off

In this situation, just play a chord in the chord recognition area (usually under the split point, see “CHORD SCANNING section” on page 15) to automatically start the Style. If you like, turn one of the INTROs on before starting the Style.

Start On, Stop On

When both LEDs are lit, raising your hands from the keyboard momentarily stops the Style running. If you play a chord again, the Style starts again.

Start Off, Stop Off

All Synchro functions are turned off.

23 SONGBOOK

Press this button to recall the SongBook mode. While in this mode, you can browse through the music database.

SHIFT You can jump to the SongBook > Custom List page by keeping SHIFT pressed, and pressing the SONGBOOK button.

24 ENSEMBLE ▶PERF ▶STS ▶STSB

This button turns the Ensemble function on or off. When on, the right-hand melody is harmonized with the left-hand chords.

Note: The Ensemble function works only when the keyboard is in SPLIT mode, and the LOWER Chord Scanning mode is selected.

SHIFT You can jump to the Style Play > Ensemble page by keeping SHIFT pressed, and pressing the ENSEMBLE button.

25 COLOR TOUCHVIEW™ GRAPHICAL DISPLAY

Use this display to interact with the instrument. To set the display contrast, keep the MENU button pressed, and turn the DIAL counter-clockwise to decrease brightness, or clockwise to increase it.

26 RECORD

This button sets the instrument to the Record or Sampling mode (which one depends on the current operating mode).

27 TRACK SELECT

Depending on the operating mode, this button switches between the various track views.

STYLE PLAY MODE

Toggles between Keyboard and Style tracks.

SONG PLAY MODE

Toggles between Keyboard tracks, Song tracks 1-8, and Song tracks 9-16.

SEQUENCER MODE

Toggles between Song tracks 1-8 and Song tracks 9-16.

28 SINGLE TOUCH SETTING buttons

These buttons allow to select up to four Single Touch Settings. Each of the Styles and SongBook entries includes a maximum of

four Single Touch Settings (STS), to automatically configure Keyboard tracks and effects, and the Voice Processor, at the touch of a finger. When the SINGLE TOUCH LED is lit, an STS is automatically selected when selecting a Style.

SHIFT If you keep the SHIFT button pressed, and press one of the buttons of this section, the “Write STS” window appears in the display, with the current STS already selected, and you can save the current keyboard track settings in a STS (see “Write Single Touch Setting dialog box” on page 109).

29 HELP

Press this button to open the context-sensitive Help.

30 SHIFT

With this button held down, pressing certain other buttons gives access to a second function.

31 SEQUENCER 1 TRANSPORT CONTROLS

Pa800 is equipped with two sequencers (Sequencer 1 and Sequencer 2), each with its own set of transport controls. The Sequencer 1 group is also used for the Sequencer mode.

<< and >> Rewind and Fast Forward commands. If you use them while the Song is in play, they make it scroll back or forward.

When pressed once, these buttons move the Song to the previous or following measure. When kept pressed, they make the Song scrolling continuously, until you release them.

In Sequencer mode, if you set a Locate Measure other than 1, the Song goes back up to that measure (see “Locate measure” on page 190).

SHIFT In Jukebox mode (Sequencer 1), keep the SHIFT button pressed, and press these buttons to scroll to the previous or next Song in the Jukebox list (see “Jukebox Editor” on page 174).

◀ (HOME) Sends the Song Position back to measure 1 (i.e., the beginning of the Song).

In Sequencer mode, if you set a Locate Measure other than 1, the Song Position goes back to that measure (see “Locate measure” on page 190).

▶/■ (PLAY/STOP)

Starts or stops the Song from the current Song Position.

SHIFT In Song Play mode, pressed while keeping SHIFT pressed, starts both sequencers at the same time.

32 SEQUENCER BALANCE slider

In Song Play mode, this slider balances the volume of the two on-board sequencers. When fully on the left, only Sequencer 1 can be heard. When fully on the right, only Sequencer 2 can be heard. When in the middle, both sequencers play at full volume.

It also selects the Lyrics, Chords, Markers, Score and Harmony Track from one of the two sequencers.

This slider only works in Song Play mode; it does not work in Style Play or Sequencer mode.

33 SEQUENCER 2 TRANSPORT CONTROLS

Transport controls for Sequencer 2. See instructions for Sequencer 1 above.

34 TEMPO/VALUE section ▶PERF ▶PERF^{Sty} ▶SB

The DIAL and the DOWN/- and UP/+ buttons can be used to control the Tempo, assign a different value to the selected parameter in the display, or scroll a list of files in the Song Select and Media pages.

DIAL Turn the dial clockwise to increase the value or tempo. Turn it counter-clockwise to decrease the value or tempo.

SHIFT When used while pressing the SHIFT button, this control always acts as a Tempo control.

MENU When used while pressing the MENU button, this control always acts as a Display Contrast control.

DOWN/- and UP/+ DOWN/- decreases the value or tempo; UP/+ increases the value or tempo.

Press both buttons together to reset the Tempo to the value memorized in the selected Style.

35 EXIT

Use this button to perform various actions, leaving from the current status:

- exit the edit menu page, without selecting any item
- make the page menu disappear, without selecting any item
- return to the main page of the current operating mode
- exit the Global or Media edit environment, and return to the current page of the current operating mode
- exit from a Style, Performance or Sound Select window
- exit from the Score page

36 MENU

This button opens the edit menu page for the current operating mode or edit mode. After opening an edit menu, you can jump to one of the edit sections by touching the corresponding button in the display.

Otherwise, press EXIT to return to the main page of the current operating mode, or the current page of the underlying operating mode.

See the relevant chapter devoted to each operating mode or edit environment, to see their “maps” in detail.

37 TEMPO LOCK

This button turns the Tempo Lock and Link Mode functions on or off.

On When you select a different Style or Performance, or select a different Song, the tempo does not change. You can still manually change it, by using the DIAL.

The Link Mode is also turned on for the Song Play mode. Tempo is the same for both Sequencers.

Off When you select a different Style or Performance, or select a different Song, the memorized tempo is automatically selected.

The Link Mode is also turned off for the Song Play mode, so each Sequencer plays with its own Tempo.

SHIFT You can jump to the Global > Lock page by keeping SHIFT pressed, and pressing the TEMPO LOCK button.

38 DISPLAY HOLD

This button turns the Display Hold function on or off.

On When you open a temporary windows (like the Sound Select window), it remains in the display until you press EXIT or an operating mode button.

Off Any temporary window closes after a certain time.

39 AUDIO IN LED

This LED shows the level of the audio signal entering the INPUT connectors. Three different colors (green, orange, red) show the level. Try to keep the level so that this LED remains on green most of the time, with orange appearing at signal peaks. Never go to red.

Off No signal entering.

Green Low- to mid-level signal entering. If the LED turns off too often, the input gain is too low. Use the GAIN controls and/or the source device’s volume to raise the input level.

Orange Slight overload in the signal path. This is fine if it turns on only on signal peaks.

Red Clipping is occurring in the signal path. Use the GAIN controls and/or the source device’s volume to lower the input level.

See page 19 for more information on the INPUTs and volume control.

40 MIC

Press this button to turn the microphone input on or off. The LED shows the status of the microphone section.

On The microphone input is turned on.

Off The microphone input is turned off.

SHIFT If you keep the SHIFT button pressed, and press this button, the Voice Processor Setup > Setup page will appear (see “Voice Processor Setup: Setup” on page 233).

41 CHORD SCANNING section ▶PERF ▶STS ▶STS^{SB}

In Style Play and Sequencer-Backing Sequence mode, use these buttons to define the way chords are recognized by the arranger.

LOWER Chords are detected below the split point. The number of notes you should play to form a chord is defined by the Chord Scanning Mode parameter (see “Chord Recognition Mode” on page 106).

UPPER Chords are detected above the split point. You must always play three or more notes to let the arranger recognize a chord.

FULL (both LEDs On)

Chords are detected on the full keyboard range. You must always play three or more notes to let the arranger recognize a chord. (You can use this mode even when the Split Keyboard Mode is selected).

OFF

No chords detected. After pressing START/STOP, only the Drum and Percussion accompaniment tracks can play.

42 KEYBOARD MODE section ▶PERF ▶STS ▶STS^{SB}

These buttons define how the four Keyboard tracks are positioned on the keyboard.

SPLIT

The Lower track plays below the split point, while the Upper 1, Upper 2 and Upper 3 tracks play above it. By default, selecting this keyboard mode automatically selects the Lower chord scanning mode (see “Chord Recognition Mode” on page 106).

FULL UPPER

The Upper 1, Upper 2 and/or Upper 3 tracks play on the whole keyboard range. The Lower track does not play. By default, selecting this keyboard mode automatically selects the Full chord scanning mode (see “Chord Recognition Mode” on page 106).

43 STYLE CHANGE

This button turns the Style Change function on or off.

On

When you select a Performance, the Style might change, according to which Style number is memorized onto the Performance.

Off

When you select a Performance, the Style and Style track settings remain unchanged. Only Keyboard track settings are changed.

44 PERFORMANCE SELECT

Press this button to use the PERFORMANCE/SOUND SELECT section to select a Performance.

45 SOUND SELECT

Press this button to use the PERFORMANCE/SOUND SELECT section to select a Sound, and assign it to the selected track.

46 PERFORMANCE/SOUND SELECT section▶PERF ▶STS ▶PERF^{Sty} ▶STS^{SB} ▶SB

Use these buttons to open the Sound Select or Performance Select window, and select a Sound or a Performance. See “Sound Select window” on page 80, or “Performance Select window” on page 80. For a list of available Sounds, see “Sounds (Program Change order)” on page 284.

The leftmost button selects the upper or lower row of Sound or Performance banks. Press it repeatedly to select one of the rows.

Upper LED On Upper row of Sounds or Performances selected.

Lower LED On Lower row of Sounds or Performances selected.

On the front panel, **Sound banks** are identified by the instrument names, while **Performance banks** are identified by numbers (1 ~ 20).

A note about Sound banks and names. Sounds in banks from “PIANO” to “SFX” are standard Sounds, the user can’t directly modify.

Sounds in banks “USER1” and “USER2” are locations where you can load new Sounds from an external device, or save new or edited Sounds.

The “USER DK” bank is where you can load new Drum Kits, or save new or edited Drum Kits.

Each Sound bank contains various pages, each with up to eight Sounds. Repeatedly press a bank button to cycle between the available pages.

(SHIFT) If you keep the SHIFT button pressed, and press one of the buttons of this section (even if you are in Sound Select mode), the “Write Performance” window appears in the display, and you can save the current track settings into a Performance (see “Write Performance dialog box” on page 109).

47 MIC SETTING buttons

Use these buttons to turn voice harmony and effects on or off.

HARMONY Turns the Voice Harmony effect on or off.

(SHIFT) If you keep the SHIFT button pressed, and press this button, the Voice Processor Preset > Preset page will appear (see “Voice Processor Preset: Preset” on page 235).

EFFECT Turns the Voice Effects effect on or off.

(SHIFT) If you keep the SHIFT button pressed, and press this button, the Voice Processor Preset > Effects page will appear (see “Voice Processor Preset: Effects” on page 239).

48 PAD (1-4, STOP) ▶PERF ▶STS ▶STS^{SB}

Each Pad corresponds to a dedicated Pad track. Use these buttons to trigger up to four sounds or sequences at the same time.

- Press a single PAD button to trigger a single sound or sequence.
- Press more PAD buttons to trigger several sounds or sequences.

The sequences will play up to the end. Then, they will stop or continue repeating, depending on their “One Shot/Loop” status (see “Pad Type” on page 153).

You can stop all sequences, or just some of them, by pressing the STOP button of the PAD section:

- Press STOP to stop all sequences at once.
- Keep STOP pressed and press one (or more) of the PAD buttons to stop the corresponding sequence(s).

Note: Pads are automatically stopped when selecting one of the Endings.

Note: Pads share polyphony voices with the other tracks, so avoid using too many of them together with a dense Style or Song arrangement.

About Pad synchronization. In Style Play mode, Pads are sync’d to the Style’s tempo. In Song Play mode, they are sync’d to the latest Sequencer you set to play. For example, assume you pressed SEQ2-PLAY; when pressing one of the PAD buttons, it will play in sync with Sequencer 2.

Note: There is no synchronization with MP3 files. Pads can only be synchronized to Standard MIDI Files. Therefore, when an MP3 file is assigned to the last select Sequencer, Pads will synchronize to the last Standard MIDI File that has been played back.

About Pads' and the Sequencers' Play command. When you press one of the PLAY buttons to start the corresponding Sequencer, all Pads will stop playing.

SHIFT You can jump to the Style Play > Pad/Assignable Switch page by keeping SHIFT pressed, and pressing one of the PAD buttons.

49 UPPER OCTAVE ▶PERF ▶STS ▶STS^{SB}

These buttons transpose the selected track in steps of a whole octave (12 semitones; max ± 2 octaves). The octave transposition value is always shown (in octaves) next to the Sound's name.



Press both buttons together, to reset the Octave Transpose to zero.

Note: The Octave Transpose has no effect on tracks set to Drum mode (and, even if set in a different status, on the Drum and Percussion tracks).

- Lowers the selected track an octave.
- + Raises the selected track an octave.

SHIFT You can jump to the Style Play > Tuning page by keeping SHIFT pressed, and pressing one of the UPPER OCTAVE buttons.

50 TRANSPOSE ▶PERF ▶PERF^{Sty} ▶SB

These buttons transpose the whole instrument in semitone steps (Master Transpose). The transposition value is usually shown on the page header in the display.

STYLE PLAY **MT:0** <no chord> 0

Press both buttons together, to reset the Master Transpose to zero.

Note: The Master Transpose has no effect on tracks set to Drum mode (and, even if set in a different status, on the Drum and Percussion tracks). See “Track Controls: Mode” on page 99, and “Track Controls: Mode” on page 173.

Note: You can also transpose MP3 files. Keep in mind, however, that transposition is limited to the range $-6...+5$ semitones. This range is enough to cover all keys, but allows to avoid excessive audio degradation. Any further transposing will have no effect. So, you may see a +7 transpose value shown in the display, but the MP3 will still be limited to +5 semitones.

b Lowers the Master Transpose in steps of a semitone.

Raises the Master Transpose in steps of a semitone.

SHIFT You can jump to the Global > Transpose Control page by keeping SHIFT pressed, and pressing one of the TRANSPOSE buttons.

51 HOST(F)

This is a USB Type A (Master/Host) connector, USB 2.0 compliant (High Speed). It duplicates the USB connector located in the rear panel. Use it to connect to the Pa800 an USB Flash Memory stick, an external CD-ROM drive, an USB hard disk. To access the connected device, go to the Media edit mode (see “Media edit mode” on page 243).

Rear panel

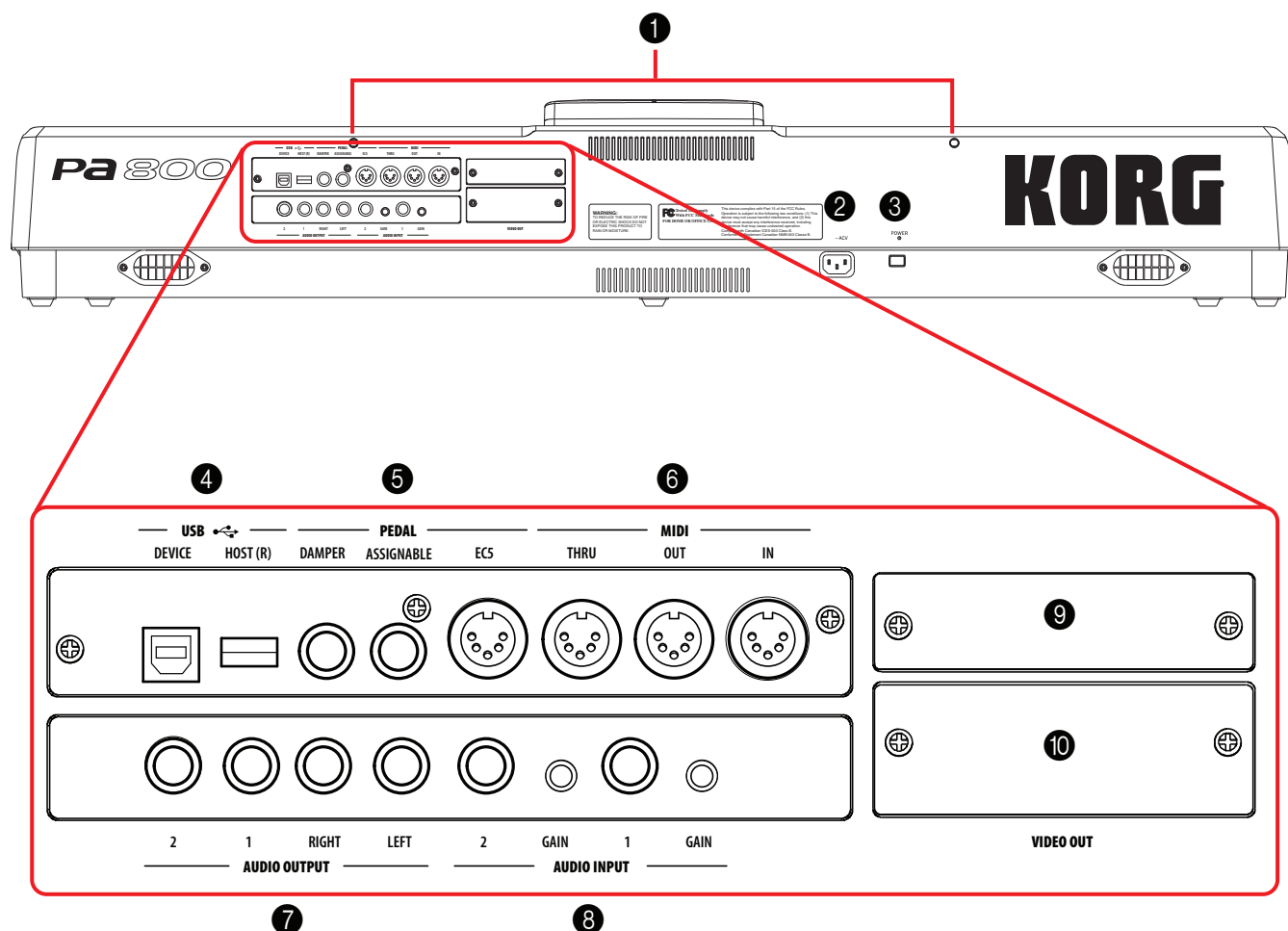
**1 Music stand holes**

A music stand comes standard with your Pa800. Insert its legs into these two dedicated holes.

2 ACV cable connector

Plug the supplied AC cable into this connector.

3 POWER switch

Use this switch to turn the instrument on or off.

4 USB connectors

DEVICE This is a USB Type B (Slave/Device) connector, USB 1.1 compliant (Full Speed). Use it to connect the Pa800 to a personal computer, and transfer data to/from its internal devices (SSD, hard disk if fitted...). See “HD and SSD-U Connection” on page 258 for more information.

MIDI Over USB is supported, so you can use this connector instead of the MIDI ports (see “What is MIDI Over USB?” on page 263).

HOST(R)

This is a USB Type A (Master/Host) connector, USB 2.0 compliant (High Speed). It duplicates the USB connector located in the front panel. Use it to connect to the Pa800 a USB Flash Memory stick, an external CD-ROM drive, a USB hard disk. To access the connected device, go to the Media edit mode (see “Media edit mode” on page 243).

5 PEDAL connectors

These connectors allow for connection of external pedals.

DAMPER

Use this to connect a Damper pedal, like the Korg PS1 or DS1H. To change its polarity and calibrate it, see “Damper” on page 222.

ASSIGNABLE

Use this port to connect a continuous- or foot-switch-type pedal, like the Korg EXP2 or XVP10. To program and calibrate it, see “Pedal/Foot-switch” on page 222.

EC5

This connects to a Korg EC5 multiswitch, to control many functions in realtime. To program the EC5, see “EC5-A...E” on page 223.

2 1 RIGHT LEFT 2 GAIN 1 GAIN

AUDIO OUTPUT

AUDIO INPUT

VIDEO OUT

6 MIDI INTERFACE

The MIDI interface allows your Pa800 to be connected to external controllers (master keyboard, MIDI guitar, wind controller, MIDI accordion...), to a series of expanders, or to a computer running a sequencer. For more information on how to use the MIDI interface, see the “MIDI” chapter.

IN	This connector receives MIDI data from a computer or a controller. Connect it to an external controller’s or computer’s MIDI OUT.
OUT	This connector sends MIDI data generated by Pa800’s keyboard, controllers, and/or the internal sequencer. Connect it to an expander’s or computer’s MIDI IN.
THRU	This connector sends an exact copy of the data received on the IN connector. Use it to cascade the Pa800 with other MIDI instruments.

7 AUDIO OUTPUT

Use these unbalanced connectors to send the audio signal (sound) to a mixer, a PA system, a set of powered monitors, or your hi-fi system.

To set the output for each track, or the routing for the audio inputs, see the “Audio Output” section, starting from page 226.

LEFT, RIGHT	These are the main stereo outputs. Use them to send the final stereo mix to an external device. Connect either of them to output the signal in mono. Set the output level with the MASTER VOLUME slider.
1, 2	These are the sub outputs. Use them to create a stereo sub-mix of just some tracks, or to output

just a single instrument to be mixed alone, or to be processed or amplified externally.

Note: The MASTER VOLUME slider has no effect on these outputs. Signal is sent dry, with no effects applied.

8 AUDIO INPUT

Use these connectors to input another keyboard/synthesizer, a CD or MP3 player, or one or two dynamic microphones. To connect a condenser microphone, you need an external phantom power supply (refer to your microphone user’s manual).

1, 2	Use these balanced/unbalanced connectors to connect your external source(s). The signal goes directly to the final mix. As an alternative, it can be sent to the Voice Processor (see “Audio Setup: Audio In” on page 228 for more information).
------	--

GAIN	Use these controls to adjust the input sensitivity of the input connectors (from 0 to -40 dB). You can check the input level by watching at the AUDIO IN LED on the control panel (see “AUDIO IN LED” on page 15).
------	--

9 MP3 Board (optional)

Slot for the optional EXBP-Dual MP3 board. See “Installing the MP3 Board (EXBP-Dual MP3)” on page 324 for more information.

10 VIDEO OUT (optional)

If an optional VIF4 video interface is fitted, you can connect the Pa800 to a TV or video monitor. See “Installing the Video Interface (VIF4)” on page 327 for more information.

Welcome!

Welcome to the world of Korg Pa800 Professional Arranger! Pa800 is the most powerful arranger available today, both for professional and home entertainment use.

Here are some of the features of your new instrument:

- RX Technology, the cutting edge engine that drives every aspect of the Pa800 – from the synthesis to the display and how it all works together.
- Powerful EDS (Enhanced Definition Synthesis) Korg sound generation system, as seen in our best professional synthesizers.
- 120 voices of polyphony.
- OPOS (Objective Portable Operating System) multitasking operating system, to let you load data while playing your instrument.
- Operating System updates, to load new features and enhancements from disk. Don't let your instrument get old!
- Optional hardware expansions, to add a video out board, a hardware MP3 encoder/decoder, and an internal hard disk. Get more and more for the money!
- Solid State Disk (SSD), for any system update – a smart way to replace the usual ROM memory.
- Favorite (Custom) Style banks, to create your own collections of Styles.
- General MIDI Level 2 Sound-compatible.
- More than 1,030 Sounds, including 63 Drum Kits.
- Four multieffect processors for the internal MIDI tracks, with 125 effects, including a Vocoder, and a selection of fine guitar effects created using Korg's REMS™ (Resonant structure and Electronic circuit Modeling System) technology, to deliver truly great sounding effects.
- Final semi-parametric Master EQ, to customize your own sound.
- 320 Performance locations, and more than 1,600 preloaded Single Touch Settings (STS), for fast setting of keyboard sounds and effects.
- 409 preloaded Styles.
- Style Record and Edit, including Guitar Mode.
- Pad Record and Edit.
- XDS Double Sequencer with Crossfader.
- Full-featured 16-track sequencer.

- Fully editable music database, for fast song retrieving, supplied by the SongBook.
- Onboard sampling to create and edit new sounds and audio grooves.
- Sophisticated Voice Processor, with effects and a 3-voice harmonizer, featuring voice technologies by TC-Helicon™.
- High-quality microphone preamplifiers, with 0 ~ -40dB of gain. The same inputs double as line inputs.
- High-quality input (ADC) and output (DAC) audio converters.
- Color TouchView™ Graphical User Interface.
- Two fully-programmable sliders and switches.
- 2 × 22 Watt digital bi-amplification with auto-loudness and fixed digital equalizer. Two-way Bass Reflex system, for realistic sound reproduction.
- 2 × USB 2.0 High Speed Host ports, for connecting external devices like hard disks, CD-ROM drives, USB memory sticks, etc.
- A single USB 1.1 Full Speed Device port, to connect a personal computer to your Pa800. This port can be used for file transfer, and for MIDI connection (without the need of a dedicated MIDI interface for the PC).

Live Performing

Pa800 has been carefully designed to be used live. The “realtime” word has its full meaning in this instrument. **Performances** allow the instant selection of all the tracks on the keyboard and a suitable Style; **STs** allow an instant selection of the keyboard tracks; **Styles** are the realtime backing companions for your realtime playing; **Songs** can be mixed in realtime; the **SongBook** is the quick way to select a song from a sophisticated music database.

Easy Mode

If you are the kind of musician that prefers to play, more than deal with technical matters, you can use the Pa800 in Easy Mode, and forget all its most powerful features, and let them out of your way.

Useful links

Your preferred Korg dealer not only carries this keyboard, but also a whole bunch of hardware and software accessories. You should ask him for more Sounds, Styles, and other useful music materials.

Each Korg distributor can give you useful information. Just give them a call for additional services. In the English-speaking world, here are the relevant addresses:

USA	KORG USA, 316 South Service Road, Melville, New York, 11747, USA Tel:1-516-333-9100, Fax:1-516-333-9108
Canada	Jam Industries, 620 McCaffrey, St-Laurent, QC, Canada, H4T 1N1 Tel. (514) 738-3000, Fax (514) 737-5069
UK	KORG UK Ltd, 9 Newmarket Court, Kingston, Milton Keynes, Buckinghamshire, MK10, 0AU Tel.: 01908 857100 UK Technical Support Tel: 01908 857122, Fax: 01908 857199 E-mail: info@korg.co.uk

Many Korg distributors also have their own web page on the internet, where you can find infos and software. Useful web pages in English are the following:

Korg USA	www.korg.com
Korg UK	www.korg.co.uk
Korg Canada	www.korgcanada.com

A place to find operating system updates and various system files (for example, a full backup of the factory data), additional musical resources, user's manuals and various information, is at the following link:

Korg Italy	www.korgpa.com
------------	--

Other useful information can be found worldwide by accessing to other Korg web sites, like the following:

Korg Inc. (Japan)	www.korg.co.jp
Gaffarel Musique (France)	www.laboitenoiremusicien.com
Korg & More (Germany and Austria)	www.korg.de
Eko Music Group (Italy)	www.ekomusicgroup.com
Letusa (Spain)	www.korg.es

What's in the box

After you buy your Pa800, please check all the following items are included in the package. If some of them are missing, immediately contact your Korg dealer.

- Pa800
- Music stand
- Power cable
- Owner's Manual
- Accessory CD (containing the USB driver, additional manuals, the Bonus Software, and a backup of the original Operating System and Musical Resources)

About this manual

This manual is divided in four sections:

- An **Introduction**, containing an overview of the instrument and of basic operations.
- A **Quick Guide**, containing a series of practical guides.
- A **Reference Guide**, with each page and parameter described in detail.
- An **Appendix**, with a list of data and useful information for the advanced user. *Additional information can be found inside the Accessory CD.*

Within the manual, you will find the following abbreviations:

- ▶**PERF** The parameter can be saved to a Performance by selecting the Write Performance command from the page menu.
- ▶**PERF^{Sty}** The parameter can be saved to the current Style Performance by selecting the Write Style Performance command from the page menu.
- ▶**STS** The parameter can be saved to one of the Single Touch Settings of the current Style, or to a Single Touch Setting of a SongBook entry. To save it to a Style, select the Write STS command from the page menu of the Style Play mode. To save it to a SongBook entry (either of Style or Song type), check the Write STS option in the Book Edit 1 page of the SongBook mode.
- ▶**GBL** The parameter can be saved to the Global, by selecting one of the available Write Global commands from the page menu. Several Global areas are available, and a smaller symbol after the GBL abbreviation will appear for each relevant parameter. More information is given in each Reference chapter.
- ▶**SB** The parameter can be saved to a SongBook entry.

Making a backup of the original data

A backup copy of all original data is supplied with the Accessory CD, and can be found on our website (www.korgpa.com). You can freely download it, in case you want to restore the Pa800 to its original status.

In case you customize your Musical Resources (Sounds, Performances and Styles), we suggest you make frequent backup copies of them, to avoid accidental loss.

To backup the Operating System, please see “Backup OS” on page 256.

To backup the Factory Musical Resources (Styles, Programs...), see “Full Backup Resources” on page 257.

Loading the Operating System

Your Pa800 can be constantly updated as new versions of the operating system are released by Korg. You can download the operating system from www.korgpa.com. Please, read the instructions supplied with the operating system on the site.

You can see which version of the operating systems is installed in your Pa800 by going to the “Utility” page of the Media mode (see “OS Version Number” on page 257).

Warning: Do not install an OS other than the official OS supplied by Korg for the Pa800. Trying to install an OS created for different models may cause data loss and permanent damage to the instrument. Korg is not responsible for any damage caused by improper installation of the OS.

Loading the Musical Resources

Should you need the original Musical Resources, a copy of them is already supplied with the Accessory CD, or can be downloaded from www.korgpa.com. You may also have created a backup copy of your custom data (see “Full Backup Resources” on page 257).

To restore data, see “Full Restore Resources” on page 257.

Warning: Do not install Musical Resources other than the official ones supplied by Korg for the Pa800. Trying to install Musical Resources created for different models may cause data loss.

Loading Musical Resources created with previous Pa-Series (Pa80, Pa1X) and i-Series instruments is allowed with some limitations. See the “Media edit mode” chapter for more information.

Start up

Connecting the AC power cord

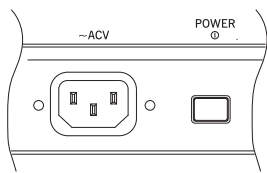

Connect the supplied power cord to the dedicated socket on the rear of the instrument. Then, plug it into a wall socket. You don't need to worry about the local voltage, since the Pa800 uses a universal power adapter.

Turning the instrument on and off

- Press the POWER switch on the rear panel to turn the instrument on. The display will light up, showing the boot procedure.

Note: When turning the instrument on, RAM PCM Samples used by some User Sounds may be automatically loaded, depending on the status of the "PCM Autoload" parameter (see page 258). This may take some time for loading.

- Press again the POWER switch on the rear panel to turn the instrument off.

Warning: When turning the instrument off, all data contained in RAM (Song recorded or edited in Sequencer mode, Samples in edit and not yet saved) will be lost. MIDI Grooves generated by the Time Slice function will be lost, too.

On the contrary, data contained in the SSD memory (Factory data, User Sounds, Performances, Styles and Multisamples) will be preserved. Saved Samples will be preserved, too.

Controlling the Volume

Master Volume

Use the MASTER VOLUME slider to control the overall volume of the instrument. This slider controls the volume of the sound going to the internal speakers, the main (LEFT & RIGHT) OUTPUTs, and the HEADPHONES connector.

The 1 & 2 OUTPUT connectors are not affected by this slider. So, use the mixer's or speaker's level controls to adjust the volume.

Note: Begin with a moderate level, then raise the MASTER VOLUME up. Don't keep the volume at an uncomfortable level for too long.

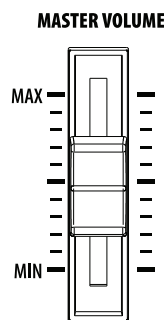

Keyboard, Style and Song Volume

By default, this slider balances the volume of the Keyboard (RT, Realtime) tracks, against the Style (ACC, Accompaniment), Pad and Song (SEQ) tracks.

- When in Style Play mode, this slider balances between the Keyboard tracks, and the Style and Pad tracks.
- When in Song Play mode, this slider balance between the Keyboard tracks, and both Sequencer and Pad tracks.

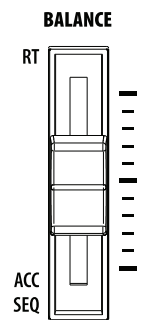

As an alternative, the slider can be used to control the Style/Song Volume without affecting the Keyboard tracks (see "Balance Slider" on page 221 for information on setting the slider's behavior).

This is a relative control, whose effective maximum level is determined by the MASTER VOLUME slider position.

When moved, a magnified version of the virtual slider appears in the display, for more accurate positioning.

Note: This slider only works in Style Play and Song Play mode; it does not work in Sequencer mode.

The Sequencer's BALANCE slider

The Sequencer's BALANCE slider sets the relative volume of the two onboard sequencers (Sequencer 1 and Sequencer 2).



- Move it fully left to set Sequencer 1 to the maximum level and Sequencer 2 to zero.
- Move it fully right to set Sequencer 1 to zero and Sequencer 2 to the maximum level.
- Move it to the center to set both Sequencer at the same level.

Note: When turning the instrument on, move this slider to the center, to avoid starting a Song at the minimum level.

Note: When moving this slider fully to the right or the left, the shown Lyrics, Chords, Markers and Score, as well as the Harmony Track, may change.

Headphones

Connect a pair of headphones to the HEADPHONES output, under the left part of the keyboard (just under the joystick). You can use headphones with an impedance of 16-200Ω (50Ω suggested). Use a headphone splitter to connect more than one pair of headphones.

Audio Outputs

Audio outputs allows you to connect the Pa800 to an external amplification system.

Stereo. Connect two mono cables to the main (LEFT, RIGHT) OUTPUTs. Connect the other end of the cables to a stereo channel of your mixer, two mono channels, two powered monitors, or the CD, LINE IN or TAPE/AUX input of your audio system. Don't use the PHONO inputs of your audio system!

Mono. Connect a mono cable to either the LEFT or RIGHT OUTPUT alone. Connect the other end of the cable to a mono channel of your mixer, a powered monitor, or a single channel of your CD, LINE IN or TAPE/AUX input of a hi-fi system (you will hear that channel only, unless you can set the amplifier to Mono mode).

Separate outputs. You can connect your Pa800 to four channels of a mixer. This is very useful when recording, or if you want to send a sequencer's or backing track to a separate channel. For example, by using the separate outputs, you may send the Drum or Bass track to an external compressor or reverb unit, or mix the separate tracks on an external mixer.

Connect four mono cables to each of the main (LEFT, RIGHT) and 1, 2 OUTPUTs. To feed the sub-outputs (1, 2) you must program the track(s) you wish to send them (see the "Audio Output" section in the Global, starting from page 226).

Note: When a track is sent to the OUTPUT 1 or 2, it is removed from the main mix going to the internal speakers and the LEFT & RIGHT OUTPUTs.

Note: OUTPUTs 1 & 2 carry a dry sound with no effects applied.

Adjust the volume of the LEFT & RIGHT OUTPUTs with the MASTER VOLUME slider. Adjust the volume of the 1 & 2 OUTPUTs with the mixer's or external speaker's level controls.

Audio Inputs

Connect your microphones, guitars, or any other musical instrument, to the AUDIO INPUTs on the back of the instrument. A microphone connected to the AUDIO INPUT 1 can also be sent to the Voice Processor for sophisticated processing.

Use a suitable "XLR to 1/4" jack" adapter to connect a microphone with a XLR connector to the Pa800's 1/4" jack inputs. Use an external phantom power supply (like a mixer) to connect condenser microphones.

Use the GAIN knobs next to the audio inputs to set the input sensitivity. While you play the external source, look at the AUDIO IN LED indicator on the front panel, to see when the audio level is correctly set:

Off	No signal entering.
Green	Low- to mid-level signal entering. If the LED turns off too often, the input gain is too low. Use the GAIN controls and/or the source device's volume to raise the input level.
Orange	Slight overload in the signal path. This is fine if it turns on only on signal peaks.

Red Clipping is occurring in the signal path. Use the GAIN controls and/or the source device's volume to lower the input level.

See the "Singing with a connected microphone" chapter on page 70, and the "Audio Setup: Audio In" section on page 228, for more information on connecting and setting the inputs and the audio source.

MIDI connections

You can play the internal sounds of your Pa800 with an external controller, i.e. a master keyboard, a MIDI guitar, a wind controller, a MIDI accordion, or a digital piano.

You can also control other MIDI devices with the Pa800, or connect it to a computer for use with an external sequencer.

As an alternative to the MIDI connectors, you can use the USB Device port for direct connection to a personal computer.

See the "MIDI" chapter on page 263 for more information on MIDI connections.

Damper Pedal

Connect a Damper (Sustain) pedal to the DAMPER connector on the back panel. Use a Korg PS1 or DS1H footswitch pedal, or a compatible one. To switch the Damper polarity, see "Damper" on page 222

Demo

Listen to the built-in Demo Songs to appreciate the power of the Pa800. There are several Demo Songs to choose from.

1. Press the STYLE PLAY and SONG PLAY buttons together. Their LEDs start blinking.
At this point, if you don't press any other button, all the Demo Songs will be played back.
2. Select one of the available options, to listen to a specified Demo Song.
3. Stop the Demo by touching the STOP button on the display, or by exiting the Demo mode by pressing any MODE button.

The music stand

A music stand comes standard with your Pa800. Insert its legs into the two dedicated holes on the rear panel.

Glossary of Terms

Before you begin, take a few moments to familiarize yourself with the names and terms we will be using to talk about the various elements of the Pa800.

In this section, you will find a brief description of various key elements of the Pa800. A professional arranger (Pa) keyboard uses different terminology than a traditional synthesizer or workstation. By familiarizing yourself with the names and functions in this section, you will get a better understanding of how all the different parts of the Pa800 work together to create a realistic musical performance. This will also help you to get the most out of the rest of the User's Manual.

Sound

A Sound is the most basic unit of an Arranger Keyboard performance. A Sound is basically a playable instrument timbre (piano, bass, sax, guitar...) that can be edited, saved, recalled and assigned to any track. An individual Sound can be played on the keyboard in the Sound mode. In the Style Play mode or Sequencer mode, Sounds may be freely assigned to Sequencer tracks, Style tracks, or Keyboard tracks.

Style

The Style is the heart of a professional arranger keyboard. At its basic level, a Style will consist of up to eight parts, or "Tracks".

Drums

The Drum track will provide a repeating rhythmic phrase, played by the standard instruments of a Drum Kit.

Percussion

An additional rhythmic phrase played by various percussion instruments (conga, shaker, cowbell, etc.) is provided by the Percussion track.

The Drum and Percussion tracks will play the same phrase repeatedly, regardless of the notes and chords being played on the keyboard, although it is possible to assign a different Drum Kit to either part, or to edit the Kit itself.

Bass & Accompaniment

The Bass track and the (up to) five additional Style tracks will each play musical phrases that are musically related to and in sync with the Drum and Percussion tracks. However, the notes being played by these tracks *will* change to follow the chord progression that you play on the keyboard.

Again, any Sound you choose may be assigned to any track in a Style.

Variation

For each Style, there are four Variations. In general, each Variation is a slightly different version of the others. As you progress from Variation one to Variation four, the arrangements will become more complex, and more parts (Tracks) may be added. This allows your performance to have a more dynamic arrangement, without losing the original "feel" of the Style.

Fill-in

During a performance, a drummer may often perform a "fill" - such as when transitioning from a verse to a chorus - adding extra dynamics and keeping the beat from getting too repetitive. The Pa800 offers three Fill-ins specifically programmed for each Style. A Fill-in may be drums alone, drums with instrumentation, or even a silent "break".

Intro & Ending

Each Style also allows you to embellish your performance with a set of musical introductions and endings. A long and short version of the Intro and Ending are usually provided, with the former more harmonically elaborated, and the latter with a fixed chord. A "count-in" style Intro is also provided.

Pad

Pads are like single-track Styles, that can be triggered by using the dedicated PAD buttons. They can be used to play in realtime single sounds, as well as short, cycling sequences that play in time with the Style.

Keyboard tracks

In addition to the Style and Pad tracks, up to four additional parts can be played on the keyboard in real-time. Each of these Keyboard tracks can be limited to a particular range of keys or velocities, but in general three can be assigned to play above the split point (Upper), and one below (Lower). This allows the Upper Sounds to be layered together. The split point can be set to any note on the keyboard. In addition to performing along with a Style, these same Keyboard tracks will allow you to play along with the Sequencer.

STS (Single Touch Settings)

Single Touch Settings allow you to instantly change the sounds assigned to each of the Keyboard tracks with a single button press, allowing for wide variation in sounds during a performance. Four STS (Single Touch Settings) can be saved with each Style or SongBook entry.

Ensemble

By turning the Ensemble feature on, a single note played on one of the Keyboard tracks will be embellished by additional notes to create a complete chord voicing. The Ensemble knows which notes to add by looking at the chord that the Style is playing. In addition, the Ensemble parameters allow you to select the type of voicing that will be added – from a simple one-note harmony to a full “Brass” section – even a marimba-style trill!

Performance

The Performance is the most encompassing setting on the Pa800 – a single setting that can remember a Style (with all the appropriate sounds), the Keyboard tracks (with all the appropriate sounds) and all their Single Touch Settings, Tempo, transposition, etc... A Performance can be stored in one of the Performance Banks, or it can be saved in a “database” format using the SongBook function.

Sequencer

The Sequencer acts as a recorder, so you can capture and playback your performances. The Pa800 sequencer can function in different modes. In the Backing Sequence mode, each Style element and each Real-Time (Keyboard and Pads) element can be recorded on a separate track in a single pass. This can be a big help in getting a song recorded quickly. The sequencer can also behave as a traditional 16-track linear sequencer, where each track is recorded individually one at a time.

The LOGO decoder

On the front panel of your Pa800 you have probably noticed three logos, and may have even wondered what they stand for. Well, here is a quick explanation of each one.



RX Technology is the cutting edge engine that drives every aspect of the Pa800 – from the synthesis to the display and how it all works together.



A variety of professional vocal effects are provided by the Pa800 – including reverb, delay, compression, and even three-part vocal harmonies! All of the vocal effects (apart for reverb) are provided by TC Helicon, the leader in vocal processing technology.



General MIDI (GM) is a standard that ensures the compatibility of sounds and messages between GM compatible instruments available from different manufacturers. For example, sequenced songs created on any GM equipped product and saved in the GM format will playback correctly on the Pa800.

Interface basics

The Color TouchView™ graphical user interface

Pa800 features an easy-to-use graphical user interface, based on Korg's patented Color TouchView™ interface. Here are the basic elements of the user's interface.

Pages

Parameters are grouped into separate pages, to be selected by touching the corresponding tabs on the lower part of the display.



Menus and sections

Pages are grouped in sections, to be selected by touching the corresponding buttons in the Edit menu that opens up when you press the MENU button.

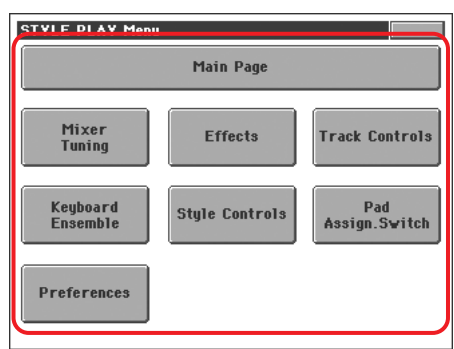

Selectable items

A triangle next to the name of a Sound, Style, STS, Pad or Song, means that you can select it and replace it with a different element. Touch the item's name and make the corresponding Select window appear.



Overlapping windows

When you touch a Sound, Style, STS, Pad or Song name, a selecting window overlaps the current page. After you select an

item in the window, or press the EXIT button, the window closes, and the underlying page is shown again.



Dialog boxes

Similar to selecting windows, dialog boxes overlap the underlying page. Touch one of the buttons in the display to give Pa800 an answer, and the dialog box will close.

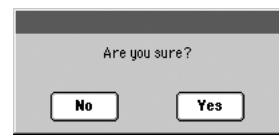

Page menus

Touch the icon on the upper right corner of each page, and a menu with suitable commands for the current page will appear. Touch one of the available commands to select it. (Or, touch anywhere else on the screen to make it disappear, with no command selected).

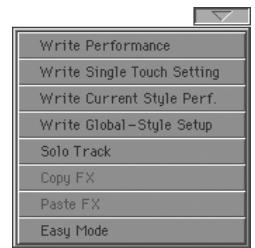

Pop-up menus

When an arrow appears next to a parameter name, touch it to open a pop-up menu. Select any of the available options (or anywhere else on the screen to make the menu disappear).



Checkboxes

This kind of parameters are on/off switches. Touch them to change their status.

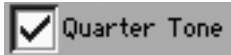

Numeric fields

When a numeric value can be edited, tap it a second time to open the Numeric Keypad.

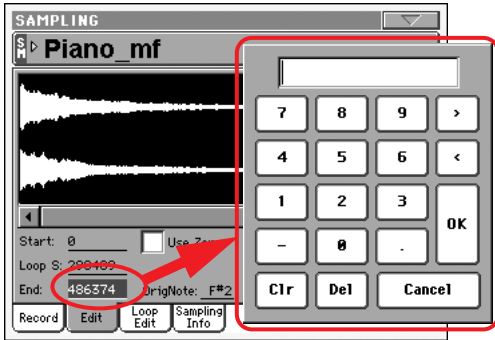

As an alternative, touch a numeric field and keep it held. Then move your fingers up (or right) to increase the value, or move it down (or left) to decrease it.

This also includes the Tempo numeric field in the main page of the Style Play, Song Play, and Sequencer modes.

Alphabetic fields

When a text option is underlined, tap it a second time to open a list of options.

Editable names

When the **T** (Text Edit) button appears next to a name, touch it to open the Text Edit window and edit the name.

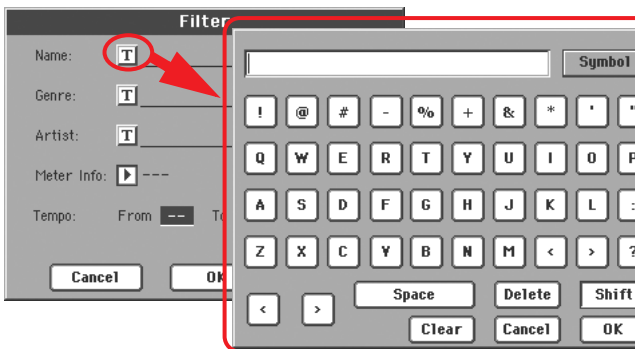

Lists and scrollbars

Files on storage media, as well as other kinds of data, are shown as lists. Use the scrollbar to scroll the list content.

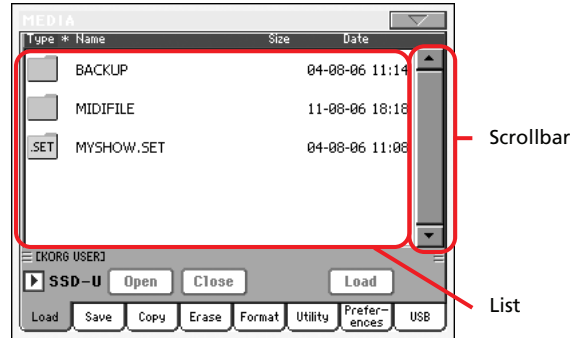

Keep the SHIFT button pressed while touching one of the arrows, to scroll to the next or previous alpha-numeric section.

Sliders

To change a slider's position, select it, then use the TEMPO/VALUE controls to change its position. As an alternative, touch a slider with your fingers and keep it held. Then move it up or down to change its position.

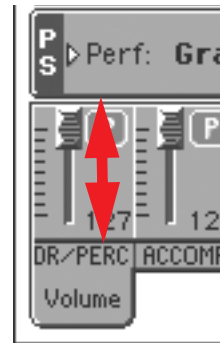

Knobs

To change a knob's position, select it, then use the TEMPO/VALUE controls to change its position. As an alternative, touch a knob with your finger and keep it held. Then move your fingers up (or right) to rotate it clockwise, or move it down (or left) to rotate the knob counter-clockwise.

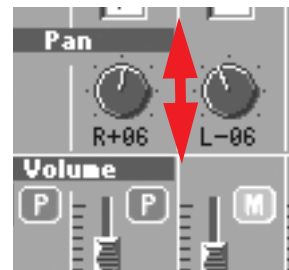

Drawbars

To change a drawbar's position, select it, then use the TEMPO/VALUE controls to change its position. As an alternative, touch a drawbar with your fingers and keep in held. Then move it up or down to change its position.

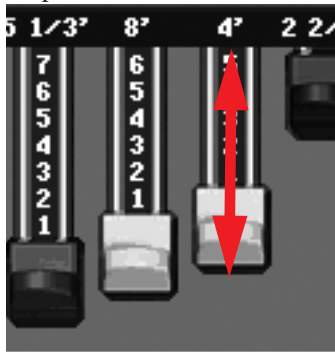

Icons

Various icons help identifying the type of a file, a Song, a folder.

Operative modes

Pa800 pages are divided into various operating modes. Each mode is accessed by pressing the corresponding button in the MODE section on the control panel.

Each operating mode is marked with a different *color code*, that helps you understand at first sight where you are.

Three special modes (Global, Media, and SongBook) overlap the current operating mode, that remains active in the background. The SongBook mode can recall the Style Play or Song Play modes.

Selected, highlighted items

Any operation carried on on parameters, data or list entries, is executed on highlighted items. First select the parameter or item, then execute the operation.

J = 71

Non-available, grayed-out parameters

When a parameter or command is not currently available, it is shown in grey on the display. This means it cannot be selected, but may become available when a different option is selected, or you switch to a different page.

Pitch

Shortcuts

Some commands or pages can be recalled by keeping the SHIFT button pressed, and touching other buttons or elements in the display. See the "Shortcuts" chapter on page 331 for a list of available shortcuts.

Quick Guide

Turning the instrument on and listening to the demos

First of all, turn the instrument on and familiarize yourself with the main screen. You can also listen to the demos.

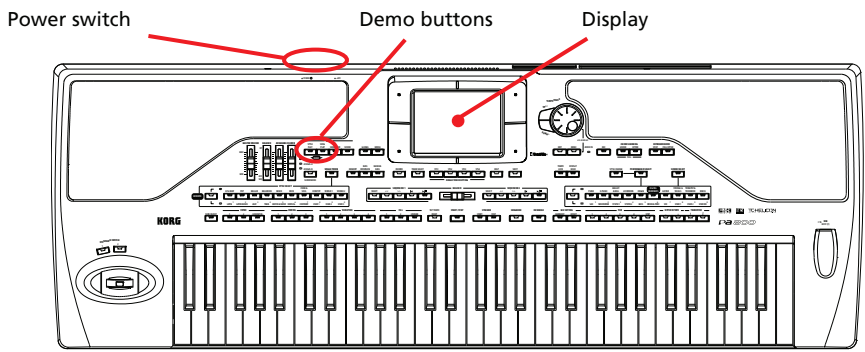

Turning the instrument on, and viewing the main screen

Turn the Pa800 on by pressing the POWER button, located on the back panel.

After you turn the POWER on, a welcome screen is shown for a few seconds, and then the main display appears.

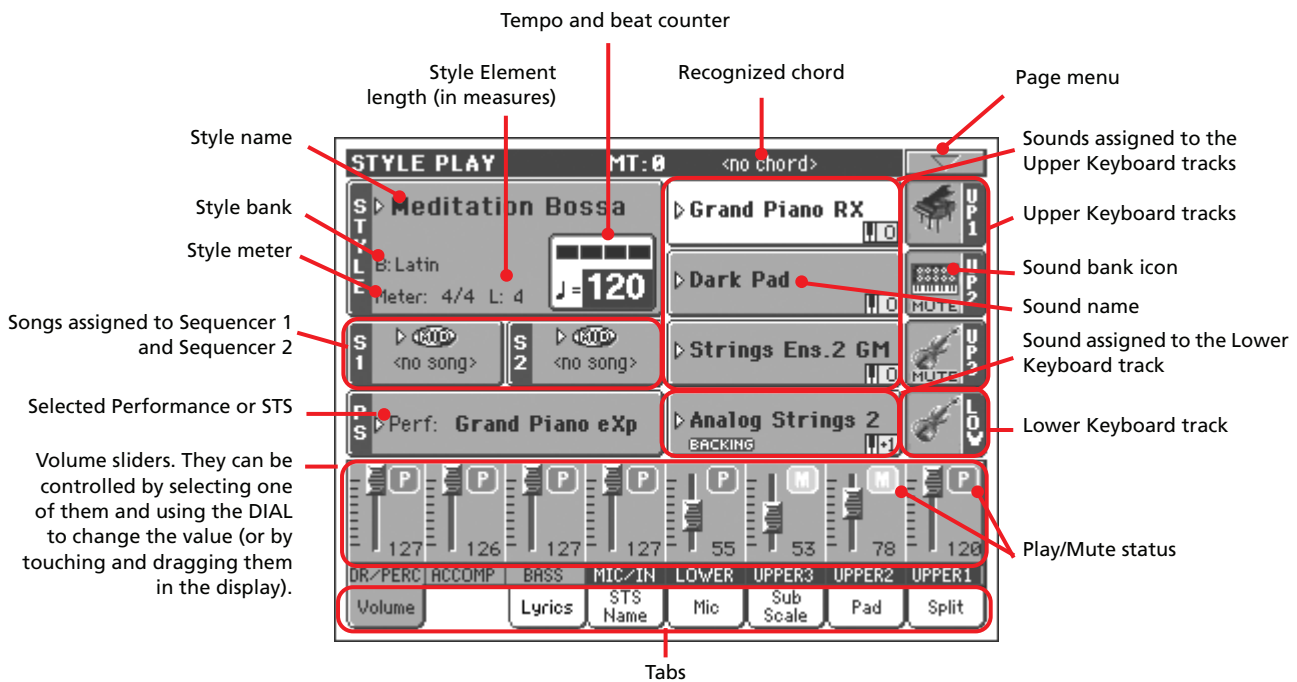

Playing the demos

A variety of demo songs have been included to demonstrate the sonic power of the Pa800.

- 1 To open the Demo page, press the STYLE PLAY and SONG PLAY buttons at the same time.**
- 2 Follow the instructions in the display. That's it!**

Playing Sounds

You can play up to three sounds at the same time on the keyboard. You can also split the keyboard into two parts, to play up to three sounds with your right hand (Upper), and one with your left hand (Lower).

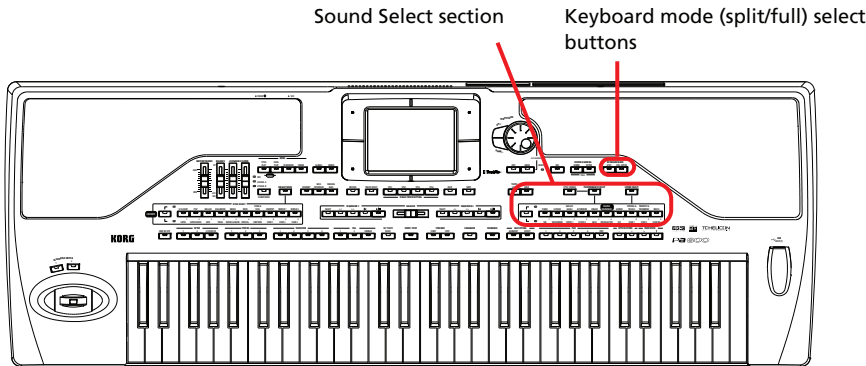

Selecting a Sound and playing it on the keyboard

1 Be sure the Upper 1 track is selected and set to play.

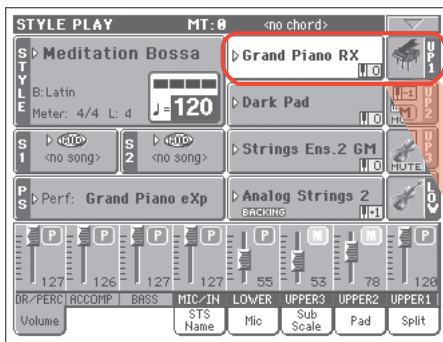

A selected track is shown with a white background. In this example, the Upper 1 track is selected. If it is not selected, touch it once to select it.

The absence of the **MUTE** icon over the bank icon shows that the Upper 1 track is set to play. If it is muted, touch the bank icon to set it to play.

i Note: Be sure tracks Upper 2 and Upper 3 are muted, and are not playing. If you hear more than one sound, see also page 35 for how to mute tracks.

2 If you want to play the Sound on the whole keyboard, be sure the keyboard is in Full Upper mode. If it is split in two parts, press the **FULL UPPER** button in the **KEYBOARD MODE** section on the control panel.

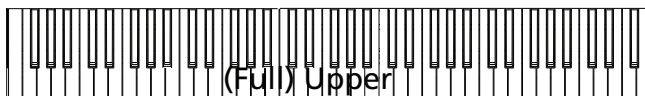
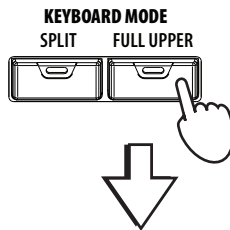

3 Touch the Upper 1 track's area in the display, to open the Sound Select window.

The triangle means you can touch this name to open a Select window

Sound's name

Set of banks. [1/10] corresponds to the top row of Factory Sounds on the control panel, [11/17] to the lower row. [User] are the User Sounds.

The currently selected Sound also appears on the page header.

Target track for the selected Sound

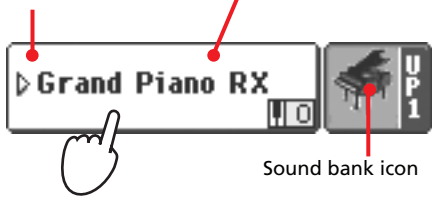

Sound bank icon

The selected Sound is highlighted. Touch a Sound's name to select it.

Touch one of the side tabs to select a different Sound bank.

Touch one of the lower tabs to select a different Sound page.

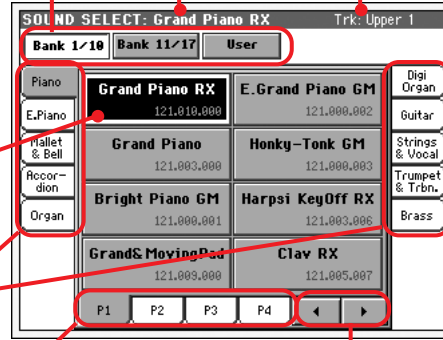

A Previous and Next Page pair of button may appear in this area, when more than five pages are available.

i Note: You can also open the Sound Select window by pressing one of the buttons in the PERFORMANCE/SOUND SELECT section – provided the LED on the SOUND SELECT button is on. This will let you jump directly to the desired Sound bank.

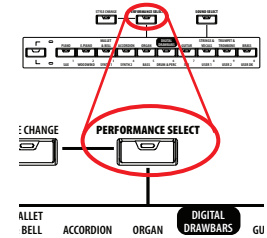

4 Select a Sound from the Sound Select window.

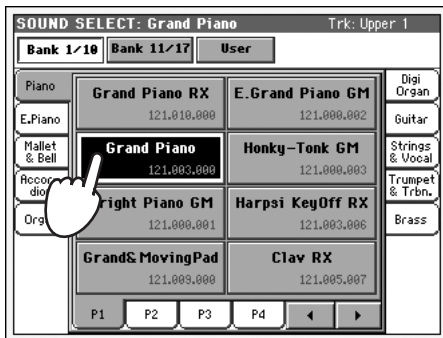

The Sound Select window closes, and the main screen appears again, with the selected Sound assigned to the Upper 1 track.

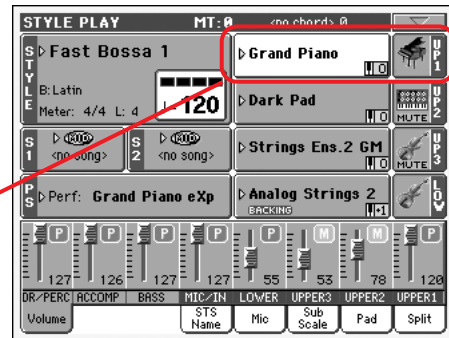

5 Play the Sound on the keyboard.

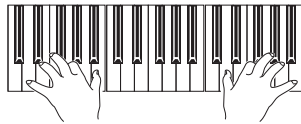

i Note: You can leave the Sound Select window open in the display, even after selecting a Sound. Just press the DISPLAY HOLD button to turn its LED on. In this case, press the EXIT button to exit from a window.



Playing two or three Sounds at the same time

You can layer all three Upper tracks and play them on the keyboard.



Please note how the **MUTE** icon appears in the Upper 2 and Upper 3 status boxes. These tracks will not be heard.

- 1 Touch the **MUTE** icon in the Upper 2 status box, to set the Upper 2 track to play.

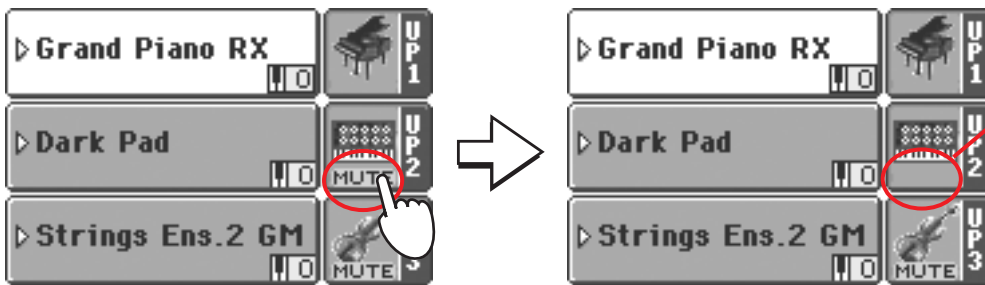

After touching in this area, the **MUTE** icon disappears. The Upper 2 track will be set to play and will be heard.

- 2 Play the keyboard.

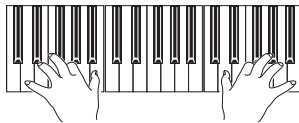

Note how the 'Dark Pad' sound (assigned to the Upper 2 track) has been layered with the 'Grand Piano' (assigned to the Upper 1 track).

- 3 Touch the **MUTE** icon in the Upper 3 status box, to set the Upper 3 track to play.

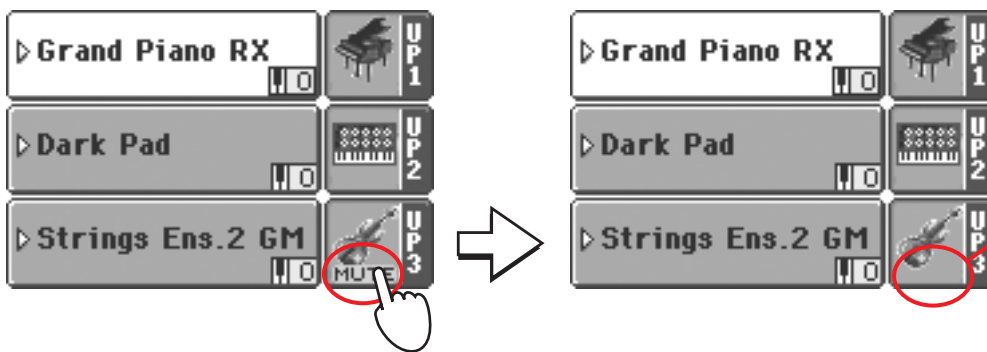

As above, after touching in this area, the **MUTE** icon disappears. The Upper 3 track will be set to play and will be heard.

- 4 Play the keyboard.

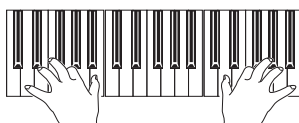

Note how the 'StringEns2' sound (assigned to the Upper 3 track) has been added to the 'Dark Pad' (assigned to the Upper 2 track) and the 'Grand Piano' (assigned to the Upper 1 track).

5 Touch the bank icon in the Upper 3 status box, to mute the Upper 3 track again.

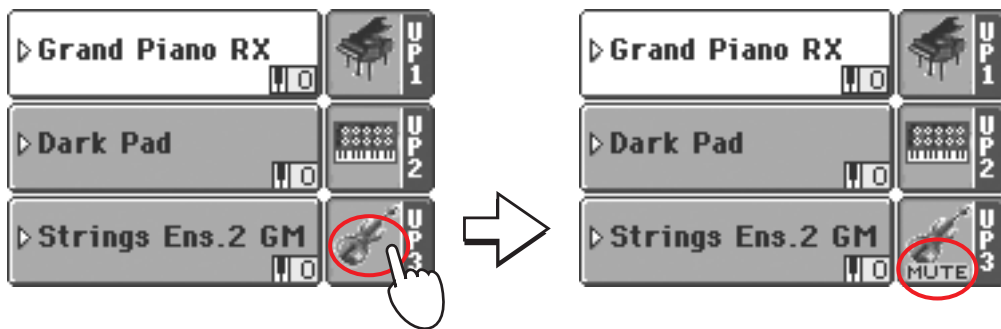

6 Play the keyboard.

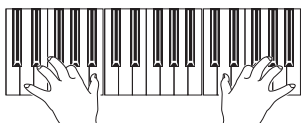

Note how the 'StringEns2' sound (assigned to the Upper 3 track) has been muted again. Only tracks Upper 1 and Upper 2 can be heard at this time.

7 Touch the bank icon in the Upper 2 status box, to mute the Upper 2 track again.

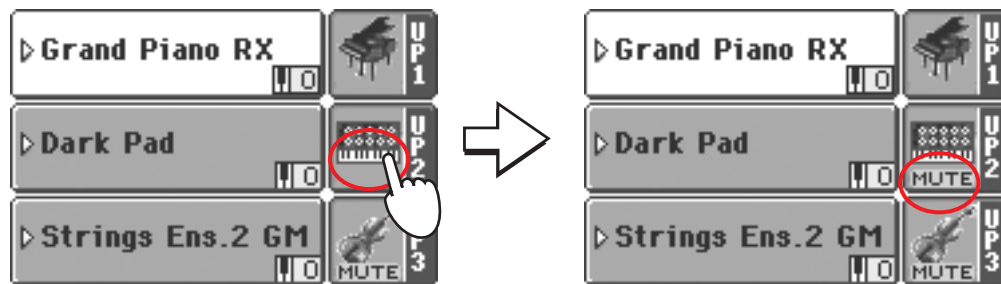

8 Play the keyboard.

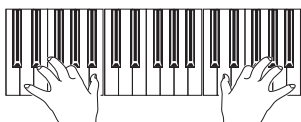

Note how the 'Dark Pad' sound (assigned to the Upper 2 track) has been muted again. Only track Upper 1 can be heard at this time.

Playing different Sounds with your left and right hand

You can play a single Sound with your left hand, in addition to playing up to three Sounds with your right hand.

- 1 Press the **SPLIT** button in the **KEYBOARD MODE** section on the control panel, to split the keyboard into **Lower** (left hand) and **Upper** (right hand) parts.

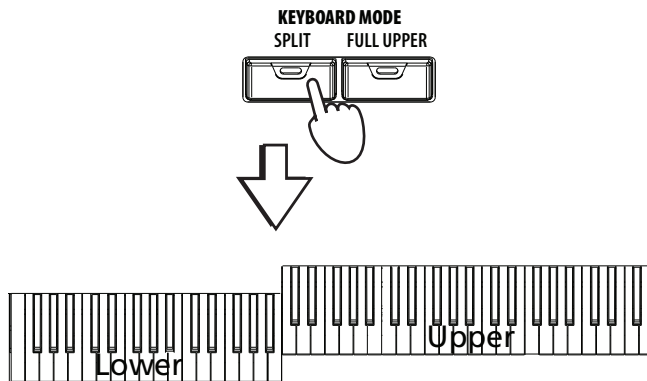

- 2 Be sure the **Lower** track is set to play.



If the **Lower** track is muted, touch its **MUTE** icon to make it disappear from this area.

- 3 Play the keyboard.

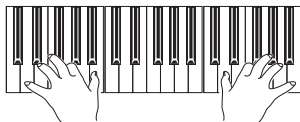

Note how the keyboard is split into two parts, each playing different sounds.

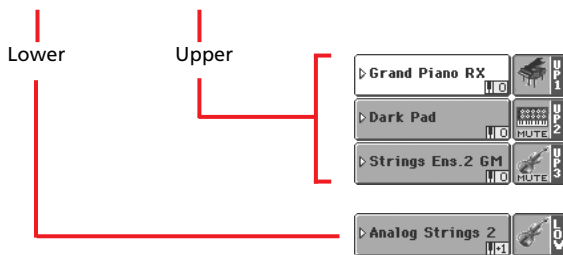

i Hint: You can select a different Sound for the **Lower** part, by following the same procedure used for the **Upper 1** track. See page 33.

- 4 Return to the full keyboard playing mode by pressing the **FULL UPPER** button in the **KEYBOARD MODE** section on the control panel.

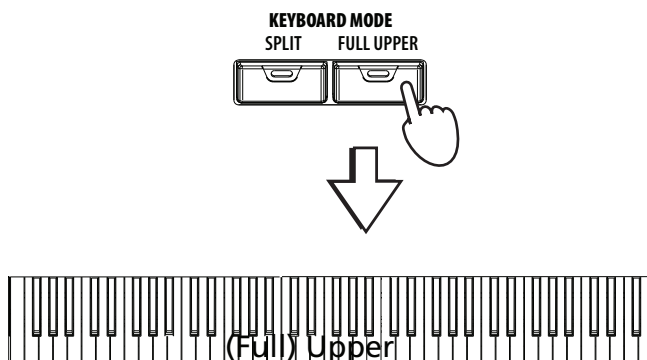

5 Play the keyboard.



Note how the keyboard once again plays the Upper tracks for the entire length of the keyboard.

Upper

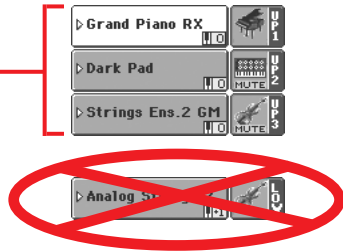

Changing the split point

If you are not comfortable with the selected split point, you may set the split point to any key.

1 Touch the Split tab to see the Split Point panel.

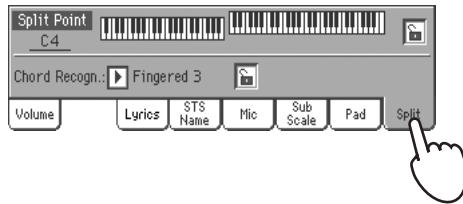

2 Touch the keyboard in the display, then play a note on the keyboard. Or, touch the Split Point parameter to select it, and use the DIAL to select the new split point.

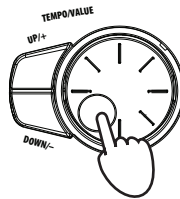
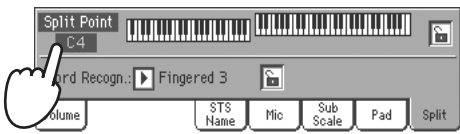

3 Touch the Volume tab to go back to the Volume panel.

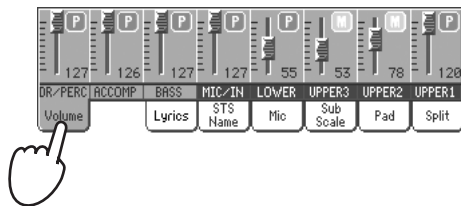

Raising or lowering the Upper octave

If all Upper tracks sound too high or too low, you can quickly change which octave they are playing in.

- 1 Use the **UPPER OCTAVE** buttons on the control panel, to transpose all Upper tracks at the same time.

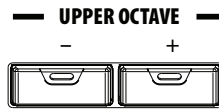

Each press of this button will lower the pitch by one octave.

Each press of this button will raise the pitch by one octave.

i *Note: The Octave Transpose value for each of the keyboard track is shown under the Sound's name.*

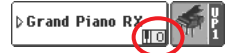

- 2 Press both **UPPER OCTAVE** buttons together to reset the octave.

Selecting and saving Performances

The Performance is the musical heart of the Pa800. Unlike selecting single Sounds, selecting a Performance will recall several Sounds at the same time, the needed effects and transpositions, a suitable Voice Processor preset, plus many more parameters useful for playing in a musical situation.

You can save all control panel settings in a Performance memory location (including your Digital Drawbar Organ settings). While many Performances are already supplied with the instrument, you can customize each of them to your own taste, and then save them in their customized form.

Similar to Performances, you can also save your settings to a **Single Touch Setting (STS)**, which will store all the settings for the Keyboard tracks. Four STSs are supplied with each Style and SongBook entry, and can be selected with the four dedicated buttons under the display.

As far as Style tracks are concerned, you can save settings in a third object called the **Style Performance**.

Please note that **settings saved in Performance 1 are automatically selected when the instrument is turned on.** This means you can save your preferred startup settings to Performance 1.

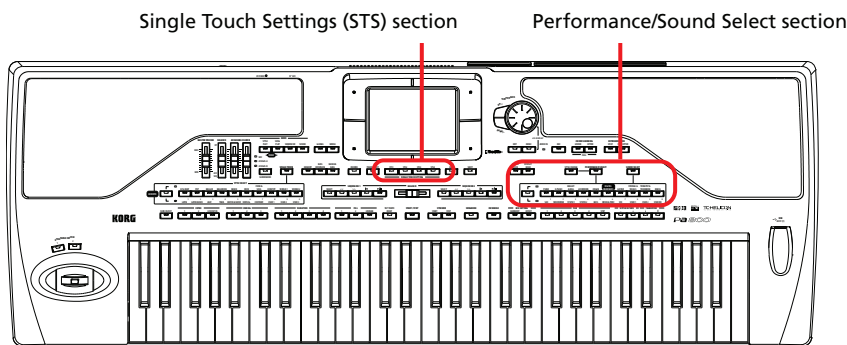

Selecting a Performance

- 1 **Touch the Performance area in the display, to open the Performance Select window.**



The selected Performance is highlighted. Touch a Performance name to select it.

Touch one of the side tabs to select a different Performance bank.

Set of banks. [1/10] corresponds to the top row of Performances on the control panel, [11/20] to the lower row.

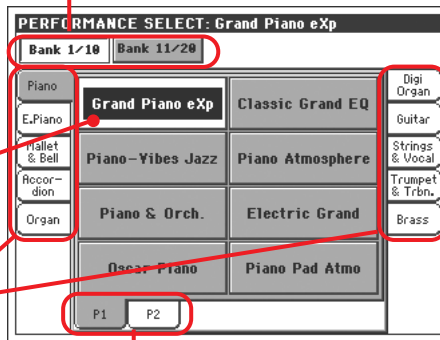

Touch one of the lower tabs to select a different Performance page.

Note: You can open the Performance Select window also by pressing one of the buttons in the PERFORMANCE/SOUND SELECT section – provided the LED on the PERFORMANCE SELECT button is on. This will let you jump directly to the desired Performance bank.

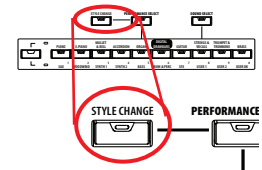

2 Select one of the Performances in the Performance Select window.

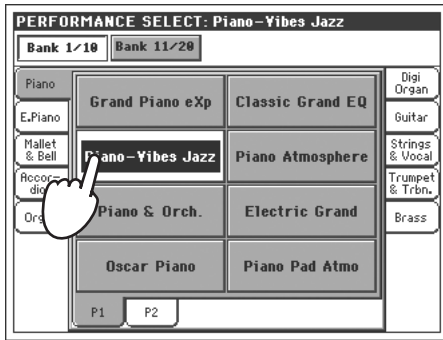

The Performance Select window closes, and the main screen appears again (provided the DISPLAY HOLD LED is turned off). Sounds, effects, and other settings, change according to the setting memorized in the selected Performance.

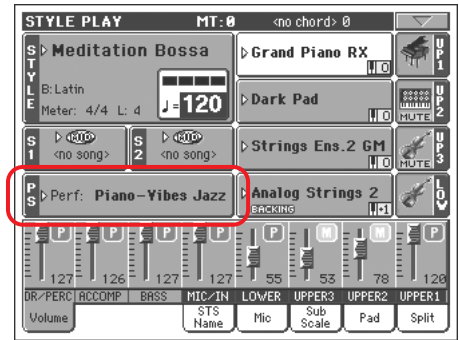

3 Play the keyboard.

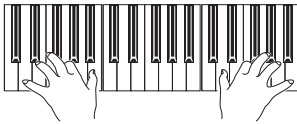

Settings memorized in the selected Performance have been selected. Sounds, effects and other settings have been recalled.

i Note: If the LED of the STYLE CHANGE button is turned on, selecting a Performance may automatically select a different Style and its settings (Sounds, effects, Drawbar settings for the Style tracks...)

Saving your settings to a Performance

All the control panel settings, plus the Keyboard track settings, selected effects and Voice Processor Preset, can be saved to a single Performance, to be quickly recalled at a later time.

1 Touch the page menu icon to open the page menu.

Page menu icon

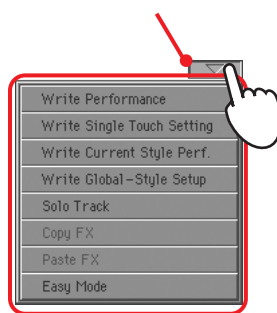

Page menu

i Note: To open the Write Performance dialog box, you can press the SHIFT + one of the PERFORMANCE buttons.

42 | Selecting and saving Performances

Saving your settings to a Performance

2 Select the 'Write Performance' command to open the Write Performance dialog box.

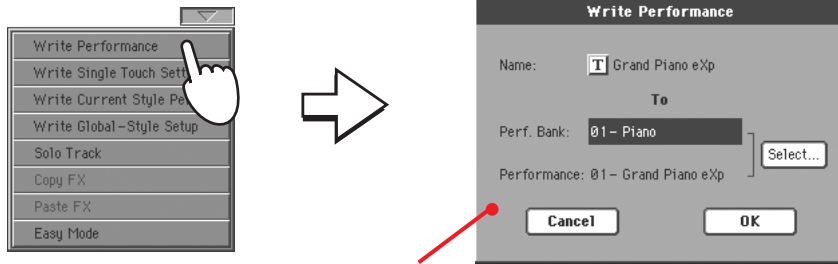

After choosing the Write Performance menu item, the Write Performance dialog box appears.

3 If you like, you may assign a new name to the Performance.

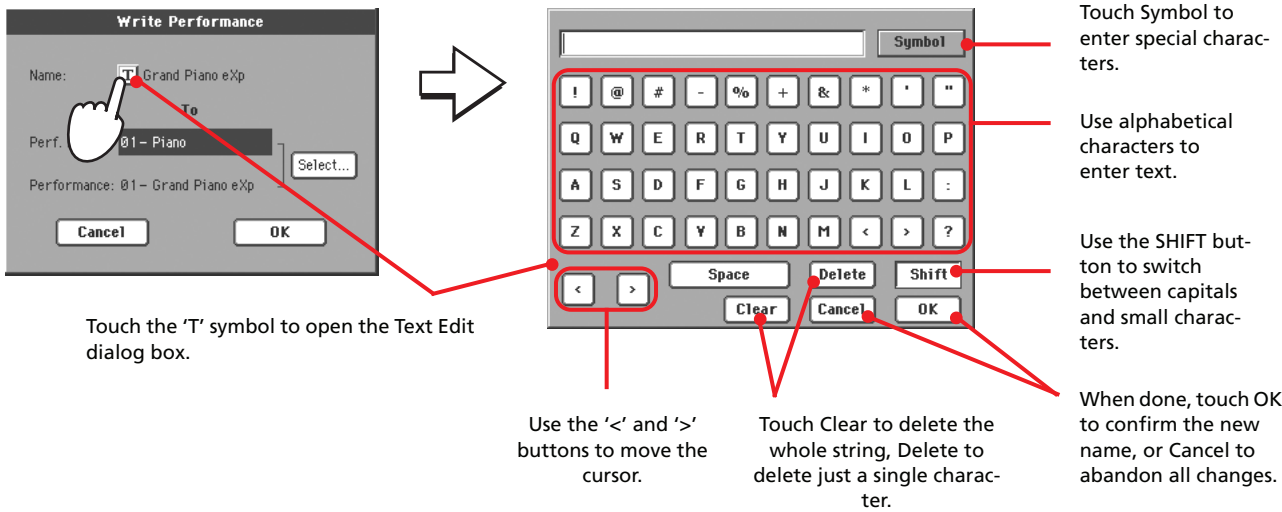

Touch the 'T' symbol to open the Text Edit dialog box.

Use the '<' and '>' buttons to move the cursor.

Touch Clear to delete the whole string, Delete to delete just a single character.

Touch Symbol to enter special characters.

Use alphabetical characters to enter text.

Use the SHIFT button to switch between capitals and small characters.

When done, touch OK to confirm the new name, or Cancel to abandon all changes.

4 Select a Bank and Performance location in memory, where you would like to save the Performance.

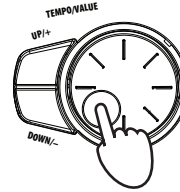
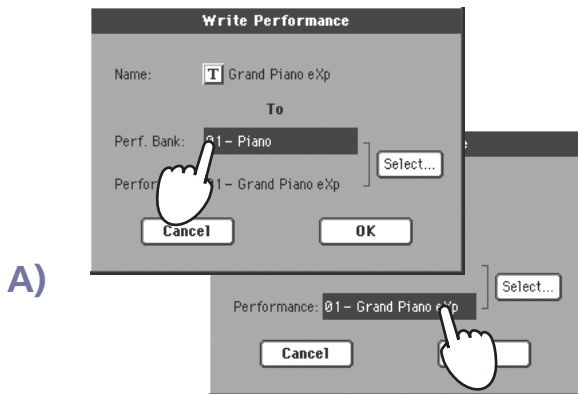

To select the target Bank and Performance location, select the Bank and Performance parameters, and use the TEMPO/VALUE section.

or...

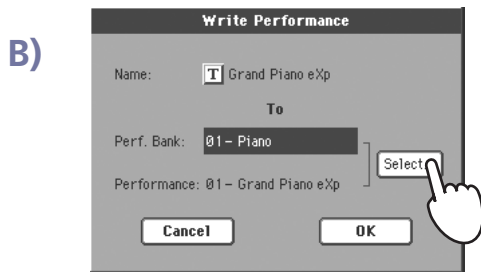

Set of banks. [1/10] corresponds to the top row of Performances on the control panel, [11/20] to the lower row.

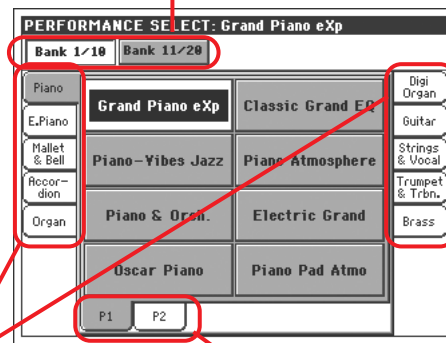

The selected Performance location is highlighted. Touch a Performance's name to select it.

Note: A Performance can be saved to an 'Empty' location. An 'Empty' locations currently contains no data.

Touch one of the side tabs to select a different Performance bank.

Touch one of the lower tabs to select a different Performance page.

5 When you have changed the name to the Performance, and selected the target location, touch OK to save the Performance to memory (or cancel to stop the operation).

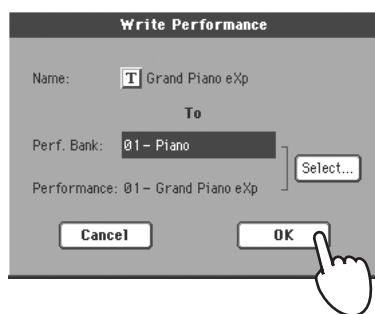

Warning: Saving a Performance to an already used location overwrites any existing data at that location. The old data are lost. Make a backup of all your important data.

Selecting and playing Styles

Pa800 is an *arranger*, i.e. a musical instrument providing automatic accompaniments, or *arrangements*. Each arrangement style is called, as a consequence, “Style”.

A Style is made of several Style Elements (Intro, Variation, Fill, Ending), corresponding to the various sections of a song. By selecting Style Elements, you can make your playing more varied and musical.

When selecting a Style, a Style Performance, with settings for the Style tracks, is also selected. If the SINGLE TOUCH LED is turned on, the first of the four Single Touch Settings (STS) associated with the Style is selected, too, and Keyboard tracks, pads, effects and some other useful parameters are automatically configured.

Use the Style controls to start or stop the Style.

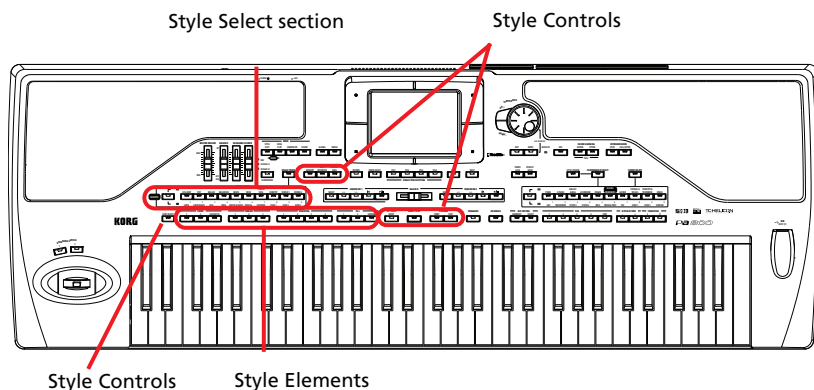

Selecting and playing a Style

1 Touch the Style area in the display. The Style Select window appears.



The selected Style is highlighted. Touch a Style's name to select it.

Touch one of the side tabs to select a different Style bank.

Set of banks. [1/10] corresponds to the top row of Styles in the control panel, [11/20] to the lower row, [Favorite] to the Favorite Styles.

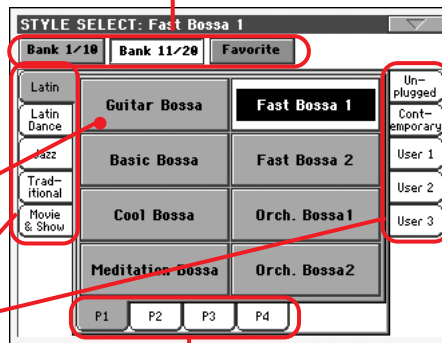

Touch one of the lower tabs to select a different Style page.

i Note: You can open the Style Select window also by pressing one of the buttons in the STYLE SELECT section. This will let you jump directly to the desired Style bank.



2 Select a Style from the Style Select window.

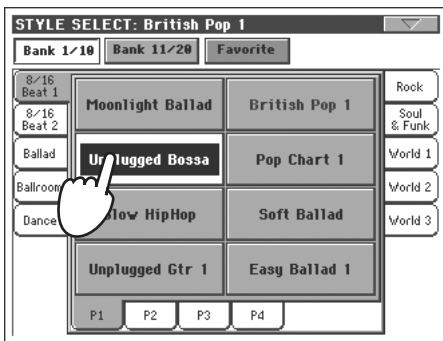

The Style Select window closes, and the main screen appears again, with the selected Style ready to go.



i Note: You can leave the Style Select window open in the display, even after selecting a Style. Just press the DISPLAY HOLD button to turn its LED on. In this case, press the EXIT button to exit from a window.



3 Be sure one of the Chord Scanning modes is selected.

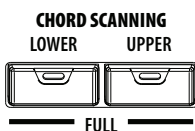

For chord scanning to work, either of both LEDs must be turned on. Lower: chords are recognized on the left of the split point; Upper: chords are recognized on the right of the split point; Full: chords are recognized on the whole keyboard. Off: only the Drum track can be heard.

4 Press the SYNCHRO-START button to turn its LED on.

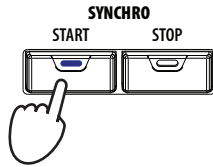

5 Play the keyboard.



When the Syncho-Start function is turned on, the Style starts playing as soon as you play a note or chord in the chord recognition area. Play chords with your left hand, and the melody with your right hand. The arranger will follow your playing.

6 Press START/STOP to stop the Style.

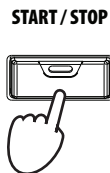

i Note: You could simply press START/STOP to start the Style, but the Syncho-Start function allows you to make the Style start in sync with your playing on the keyboard. Therefore, it may be considered a “more musical” way of starting a Style.

Tempo

While a Tempo setting is saved with each Style or Performance, you can change it to be whatever you like. You can use either of the following two methods.

- While the Tempo parameter is selected, use the TEMPO/VALUE controls to change its value.



i Hint: As an alternative to using the TEMPO/VALUE controls, hold the Tempo value in the display, then move your finger up/down or left/right.

- When the Tempo parameter is not selected, or you are in any other page, keep the SHIFT button pressed, and use the DIAL to change the Tempo. The selected tempo will be shown in a small window.

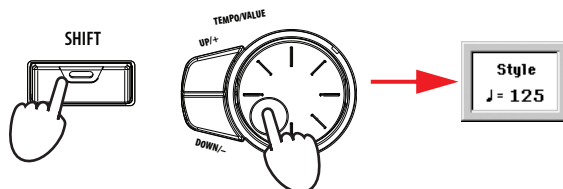

- Press the UP and DOWN buttons at the same time to recall the saved Tempo.

Intro, Fill, Variation, Ending

When playing Styles, you can select various “Style Elements” to make your playing richer. A Style is made of up to four basic patterns (Variations), three Intros (or two Intros and a Count-In), three Fills (or two Fills and a Break), and three Endings.

- 1 **Make sure the SYNCHRO-START LED is turned on (otherwise, press the button to turn it on).**

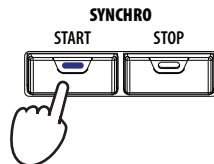

- 2 **Press one of the INTRO buttons to set the corresponding Intro to play.**

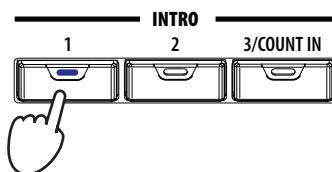

- 3 **Play the keyboard.**

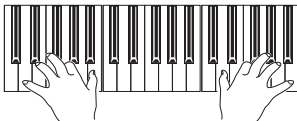

The Style starts with the selected Intro. When the Intro is completed, the basic pattern (selected Variation) starts to play.

- 4 **While playing, press one of the FILL buttons to select a Fill.**

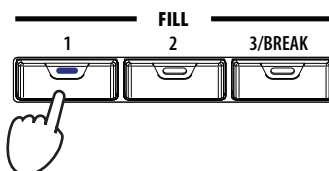

i Note: You do not need to select a Fill before selecting a different Variation, but selecting a Fill makes the transition “smoother” and more musical.

- 5 **Before the Fill ends, press one of the VARIATION buttons, to select a different variation of the basic pattern.**

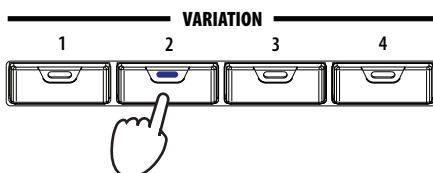

When the Fill ends, the selected Variation will start playing.

i Note: You do not need to select a Variation during a Fill, since a Variation may already be automatically recalled at the end of the Fill. See “Fill Mode (1...3)” on page 104.

- 6 **When you like to stop playing, press one of the ENDING buttons to stop the Style with an Ending.**

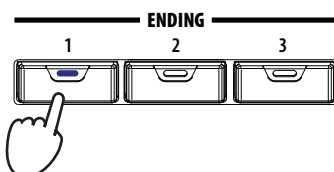

When the Ending is finished, the Style automatically stops.

Single Touch Settings (STS)

Each Style or SongBook entry may come with up to four Keyboard track settings, called STS (short for “Single Touch Settings”). STS #1 is automatically selected when choosing a Style, provided the SINGLE TOUCH LED is turned on. STS#1 is also recalled when a SongBook entry is selected.

STSs are still available when switching to Song Play mode from Style play mode, to let you select a different configuration of Keyboard tracks and a different Voice Processor Preset, while listening to the Songs.

1 Press one of the four STS buttons under the display.

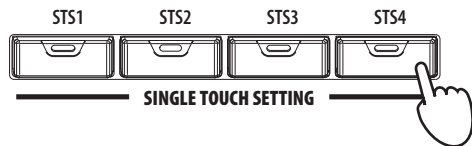

2 Play the keyboard.

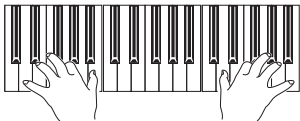

Settings memorized in the selected STS have been selected. Sounds, effects and other settings have been recalled.

3 Try all the other STSs, and see how settings change with each of them.

i Note: STSs are very similar to Performances, but they are fine-tuned to the Style they are associated to.

i Hint: You may see the name of the four available STSs for the current Style, by touching the STS Name tab.

The Pads

When the STYLE CHANGE LED is turned on, each Performance and STS can assign different sounds or patterns to the four PADS. These sounds or patterns can be played along with the Keyboard and Style tracks.

1 Press one of the four PADS.

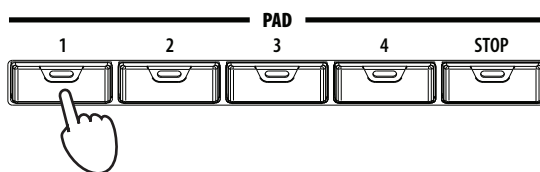

2 If the selected PAD triggers an endless sound or pattern (i.e. an applause, or a guitar arpeggio), pressing STOP will stop that sound.

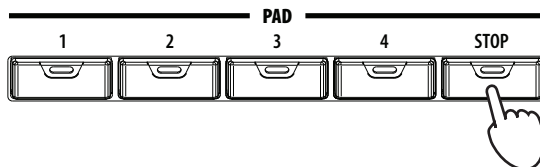

3 Select a different Performance, and see how the sounds or patterns assigned to the PADS change.

i Hint: You can see which sounds or patterns are associated to the four Pads for the current Performance or STS, by touching the Pad tab.

i Hint: You can open the Pad Select window to assign a different sound or pattern to the Pads, by pressing SHIFT + one of the PADS.

You can even press more Pads at once, and play two or more sounds or patterns at the same time. Pressing STOP stops them all at the same time. Keeping STOP pressed and pressing one of the PAD buttons only stops that sound or pattern.

Adjusting balance between the Style and the keyboard

Balancing between the Keyboard and Style tracks may be useful, to gently fade them and adjust their respective volume.

- While the Style is playing, use the **BALANCE** slider (next to the **MASTER VOLUME** slider) to balance between the Keyboard and Style volume.

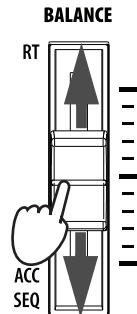

Adjusting volume of each single track

You can adjust the volume of each of the Style and Keyboard tracks, for example to soften the bass a little, or to make the keyboard solo louder.

1 Touch a track, and use the TEMPO/VALUE controls to change its volume.

The average volume of grouped Style tracks (Drum/Perc, Accomp and Bass) will not change when choosing a different Style.

i Note: Grouped Style tracks are:
Dr/Perc = Drum and Percussion; Accomp. = Accompaniment 1 ~ 5; Bass = Bass

In Normal view, all Style tracks are seen as three 'grouped' tracks.

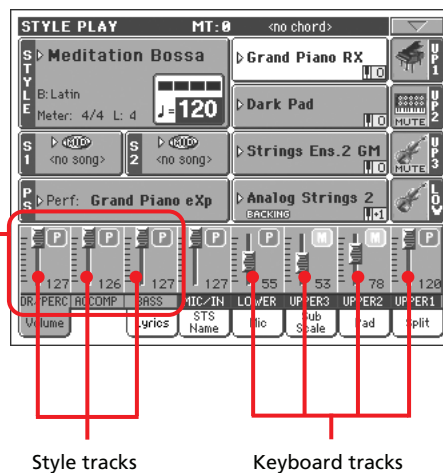

i Hint: As an alternative to using the TEMPO/VALUE controls, hold the track's slider in the display, then move your finger up/down.

- To separately adjust each Style track, press the TRACK SELECT button to change track's view.

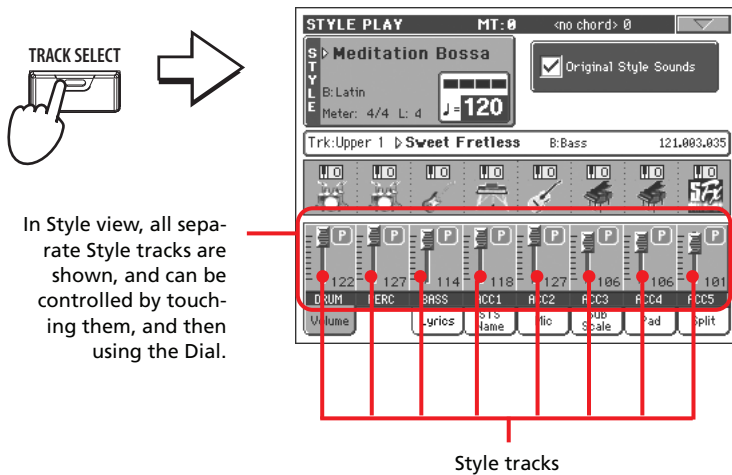

- To return to Normal view, press the TRACK SELECT button again.

Turning Style tracks on/off

You may easily turn on or off any Style track while you are playing. For example, try muting all accompaniment tracks, while drum and bass continue to play.

- While the Style is playing, touch anywhere in the ACCOMP track's channel strip to select the track (volume value highlighted), then touch it again to set the track to Mute.

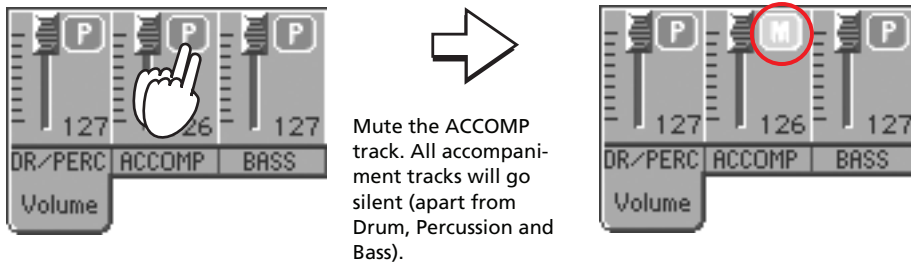

- To set tracks back to the Play status, touch the Mute icon on the ACCOMP track.

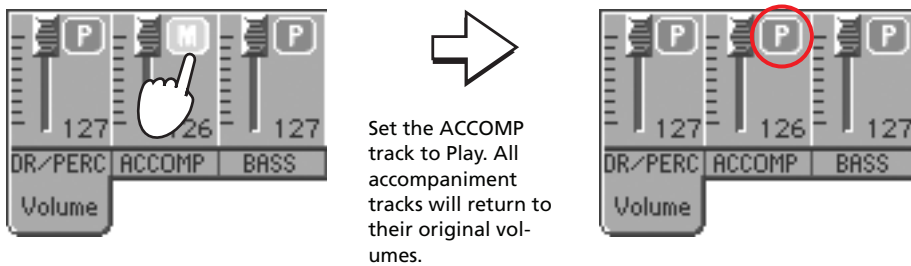

- To mute/unmute each single Style track, press TRACK SELECT to switch to the Style Tracks view.
- Press the TRACK SELECT button again to go back to the Normal view.

i Note: While in the Normal view of the Style Play mode, you can see Style tracks grouped in just three "complex" tracks. To see each Style track as individual tracks, just press the TRACK SELECT button.

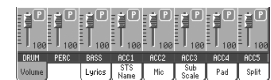
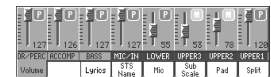

i Hint: When moving the slider of a muted track, the track is automatically set to play again.

Adding harmony notes to your right-hand melody with the ENSEMBLE function

Chords played with your left hand may be applied to the right-hand melody.

- 1 Press the **SPLIT** button in the **KEYBOARD MODE** section to split the keyboard.

The Ensemble function only works in Split mode.

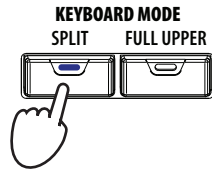

- 2 Press the **ENSEMBLE** button to turn its LED on.

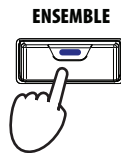

- 3 Play chords with the left hand and single notes in the right hand.



Notice how the right hand is automatically harmonized, according to the chords composed with your left hand.

- 4 To select a different harmonization style, keep the **SHIFT** button pressed, and press the **ENSEMBLE** button to open the Ensemble page.

This is a fast 'shortcut' to recall this page. The longer would have been entering the Edit mode by pressing the MENU button, then going to the Ensemble page.

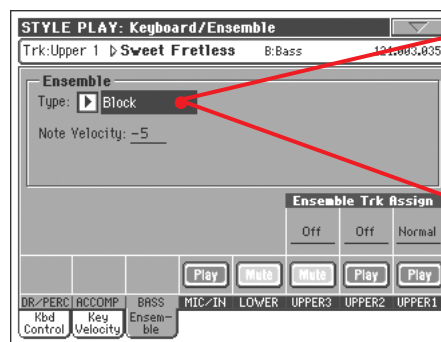
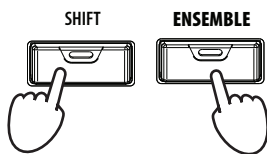

While the Ensemble parameter is selected, use the TEMPO/VALUE controls to select one of the available harmonization types.

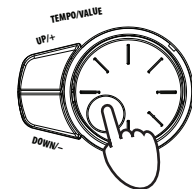

52 | Selecting and playing Styles

Adding harmony notes to your right-hand melody with the ENSEMBLE function

- 5 When the right harmonization type has been selected, press the EXIT button to go back to the main page.

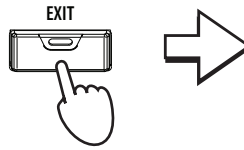
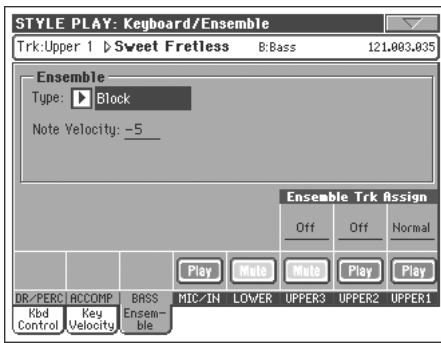

While in an edit page, press EXIT to go back to the main page of the current operating mode.

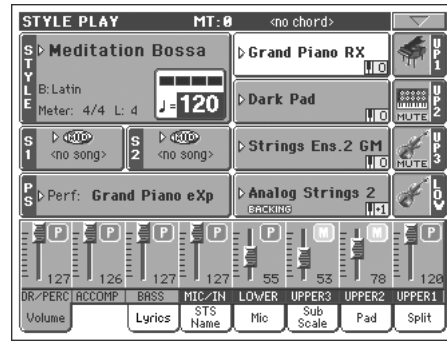

- 6 Press the ENSEMBLE button again to turn its LED off. The automatic harmonization will be turned off.

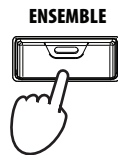

Song Play

Pa800 is equipped with two onboard sequencers that can be run at the same time to mix between different Songs. Pa800 can read Songs in Standard MIDI File (SMF), Karaoke™ (KAR) and MP3 format.

It may be of great interest to singers and guitar players to know that if a midifile or MP3 file contains lyrics and chords, they can be seen in the display. Also, any midifile's track can be seen as a traditional score. Lyrics, chords and score can also be seen on an external video monitor, provided you have the (optional) VIF4 Video Interface installed.

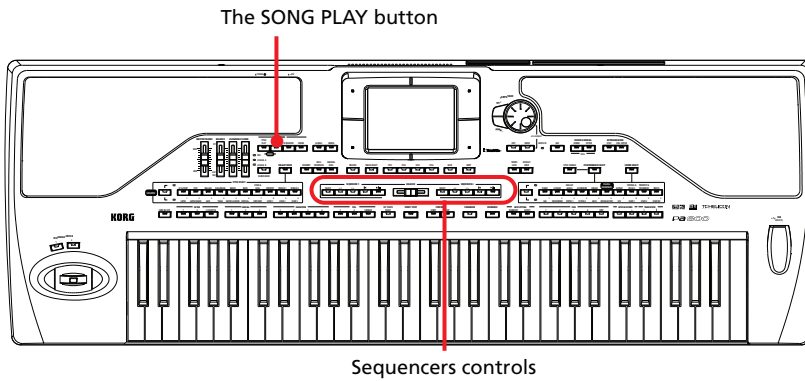

Selecting a Song to play

1 Press the SONG PLAY button to switch to the Song Play mode.

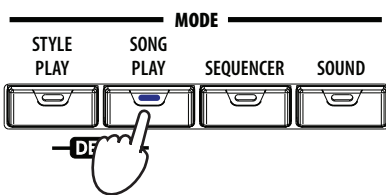

After pressing the SONG PLAY button, the main page of the Song Play mode appears.

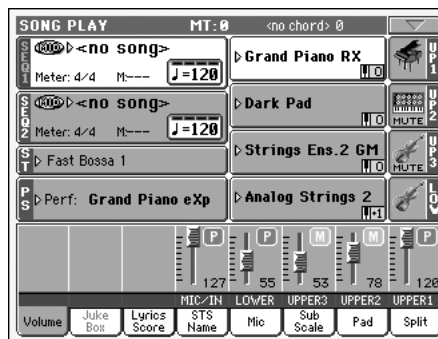

i Hint: In Style Play mode, you can pre-select the Songs to be assigned to both sequencers. This way, you will be ready to start them, as soon as you switch to Song Play mode.

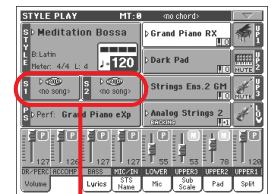

The Songs area of the Style Play main page.

2 Touch the Sequencer 1 area to open the Song Select window.

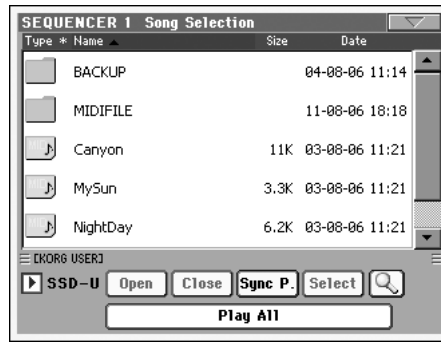
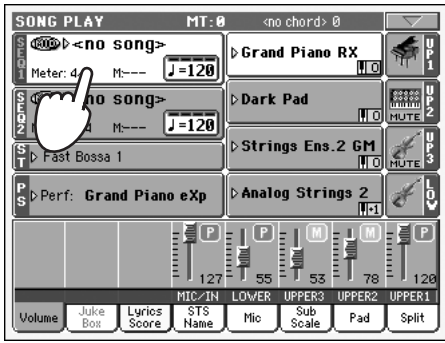

i Hint: As an alternative, you can open the Song Select window by pressing the SELECT button in the SEQUENCER 1 section on the control panel.

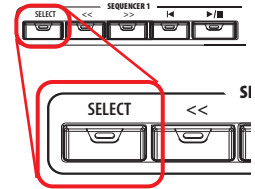

3 Scroll through the list and select the Song to play.

The selected Song is highlighted. Touch a Song's name to select it.

Use the scroll bar to see all Songs in the list. Keep SHIFT pressed and touch the Up/Down arrow to scroll to the next/previous alphabetic section. As an alternative, you can use the DIAL.

Touch the Select button to select the highlighted Song, and assign it to Sequencer 1.

Use the Device pop-up menu to select one of the available mass-storage devices (SSD-U, hard drive...).

Use the Open and Close buttons to browse through the folders.

Use the Sync P. (Synchronized Path) button to see the selected Song again.

4 When the Song is selected, touch the Select button to confirm your selection, and close the Song Select window.

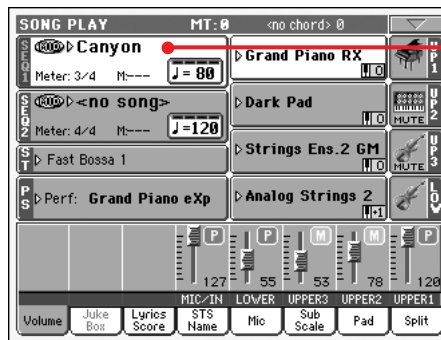
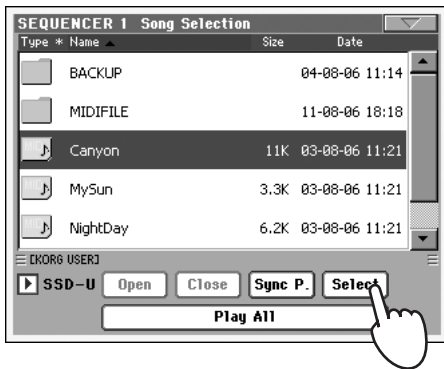

After touching the Select button in the display, the main page of the Song Play mode appears again.

Playing back a Song

Once a Song has been selected, it may be played back by the sequencer.

- 1 Be sure the **SEQUENCER BALANCE** slider is completely moved to the left (toward Sequencer 1).

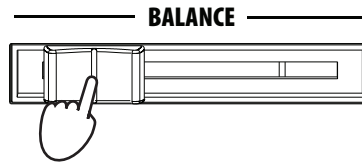

- 2 Press the **▶/■ (PLAY/STOP)** button in the **SEQUENCER 1** section to start playback.

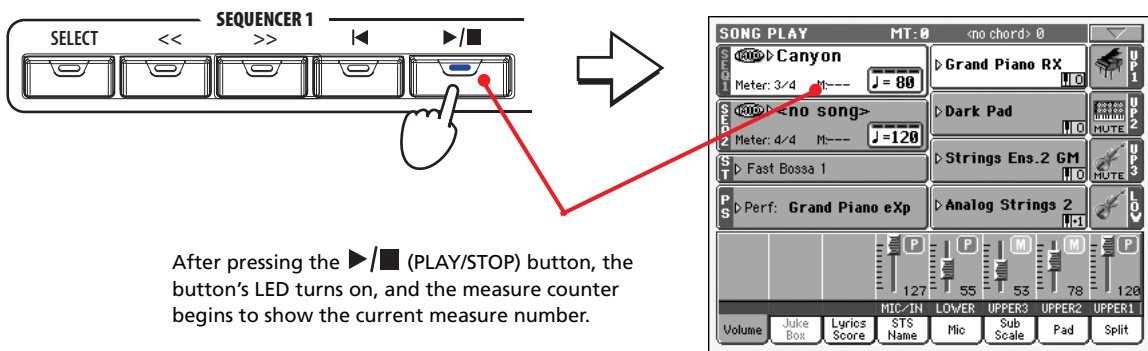

After pressing the **▶/■ (PLAY/STOP)** button, the button's LED turns on, and the measure counter begins to show the current measure number.

- 3 Use the **SEQUENCER 1** control section to control the Song's playback.

Press the **HOME** button to move the Song to measure 1. Press the **PLAY/STOP** button to stop the Song at the current position. Press it again to resume playback.

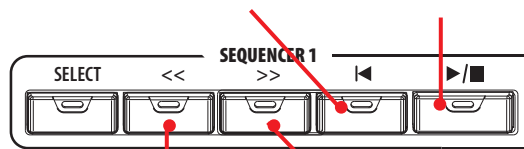

Press the **REWIND** button once to go to the beginning of the current measure. Keep it pressed to go back several measures.

Press the **FAST FORWARD** button once to go to the beginning of the next measure. Keep it pressed to go forward several measures.

- 4 When you want to stop the song and go back to the first measure, press the **◀ (HOME)** button.

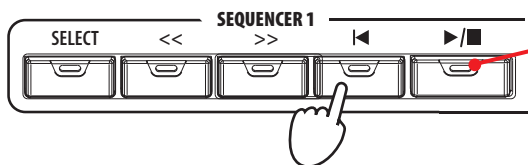

When the Song is stopped, the LED on the **PLAY/STOP** button goes dark.

i Note: In any case, the sequencer will automatically stop when the end of the Song is reached.

Changing tracks volume

During playback, you may wish to change each track's volume, to create a mix "on the fly".

- 1 In Normal view, you can adjust each Keyboard track's volume. Touch a track and use the TEMPO/VALUE controls to change its volume

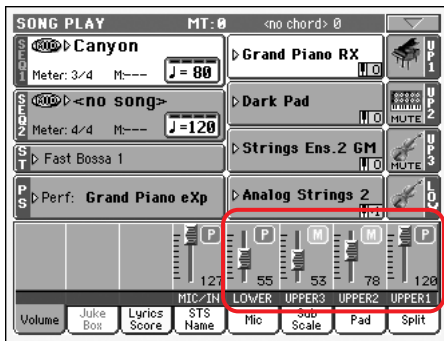

Keyboard tracks

i Hint: As an alternative to using the TEMPO/VALUE controls, hold the track slider in the display, then move your finger up/down.

- 2 Press the TRACK SELECT button once to see tracks 1-8 (Track 1-8 view).

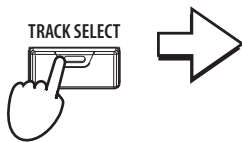

In Track 1-8 view, the first 8 tracks of the selected Song are shown.

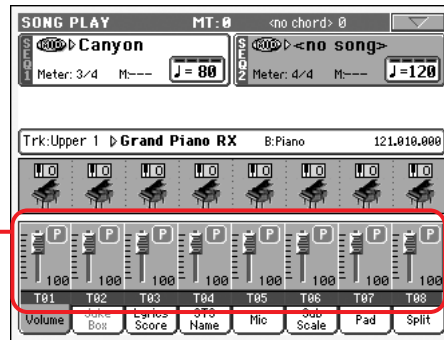

i Note: Changes to Song tracks will not be saved, and will be reset each time you press the **◀** (Home) button. They may also be reset while pressing the **<<** (Rewind) button. To save changes, you must edit the Song in Sequencer mode.

- 3 Press TRACK SELECT once again to see tracks 9-16 (Track 9-16 view).

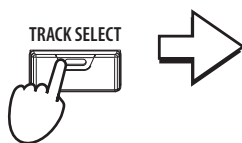

In Track 9-16 view, the second group of 8 tracks of the selected Song are shown.

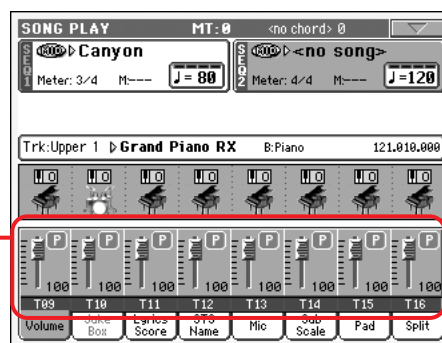

- 4 Press **TRACK SELECT** again, to return to the Normal view (Keyboard tracks).

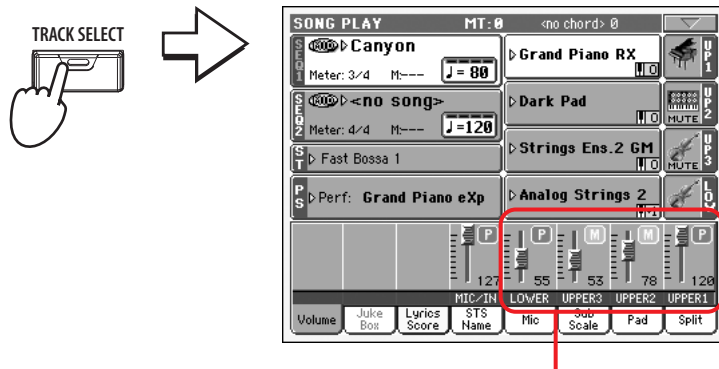

Keyboard tracks

- 5 Press the **▶/■ (PLAY/STOP)** button to start the Song.

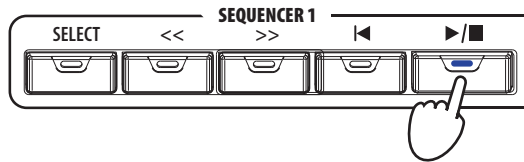

- 6 While listening to the Song, switch from Normal view to Track 1-8 and Track 9-16 view, to see which tracks are playing.

To see if a track is playing, look at its name, and see if it changes color.

- Touch each track's channel strip, to see each track's detail in the Track Info line.

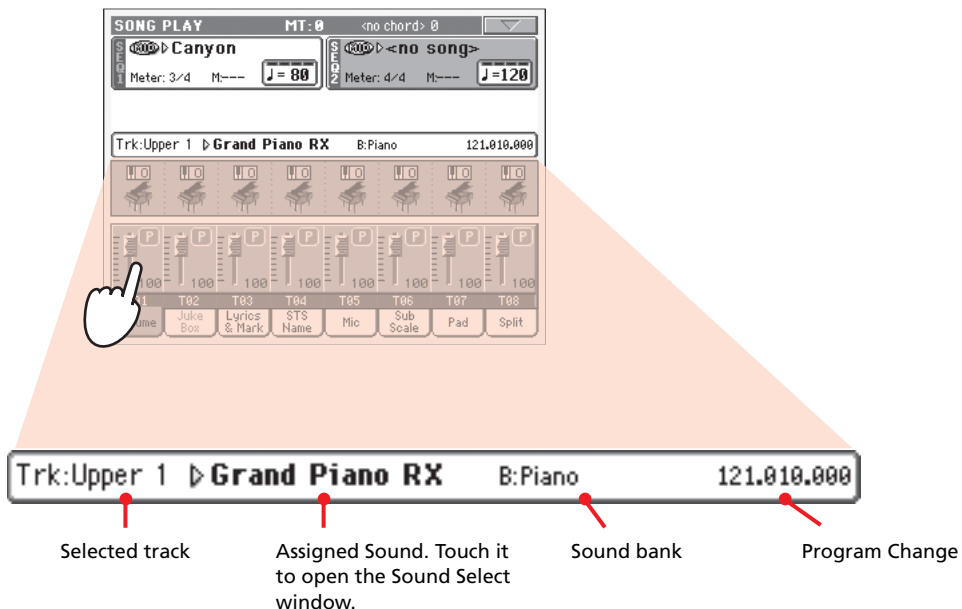

- **Alternatively, you can see which type of Sound is assigned to each track in the Sound area of the Track 1-8 and Track 9-16 views.**

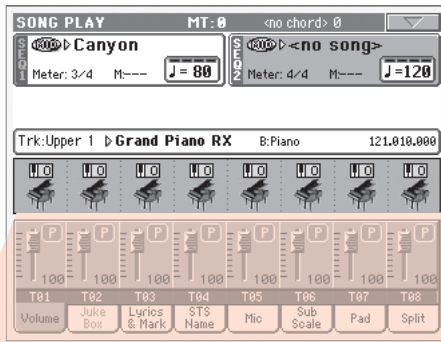

Turning Song tracks on/off

During playback, you may wish to mute one or more tracks, for example to sing along with the Song, or play an instrumental part live on the keyboard.

Muting/unmuting Song tracks works exactly as with Style tracks. See “Turning Style tracks on/off” on page 50 for more information.

i Note: These changes will not be saved to the Song. To save changes, edit the Song in Sequencer mode.

Soloing a track

Contrary to the above, you may want to make a single track play alone. This is called the Solo function.

- 1 **While the Song is playing, keep the SHIFT button pressed and touch the track you want to listen to in Solo mode.**
- 2 **To set all tracks back to the Play status, keep the SHIFT button pressed again, and touch the track currently in Solo mode.**

You can use the Solo function also in Style Play and Sequencer mode. The Solo command can also be selected from the page menu.

Mixing two Songs

You can select two Songs at the same time, and mix between them using the BALANCE slider.

- 1 Touch the **Sequencer 1** area to open the **Song Select** window and select the Song to be played by Sequencer 1. Touch **Select** to confirm.

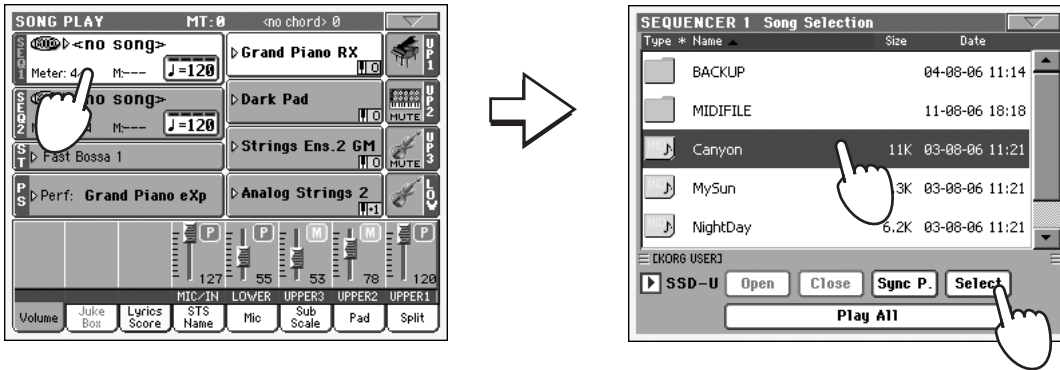

- 2 Once a song is assigned to Sequencer 1, touch the **Sequencer 2** area once to select it, and a second time to open the **Song Select** window. Select a Song to be assigned to Sequencer 2, and touch **Select** to confirm.

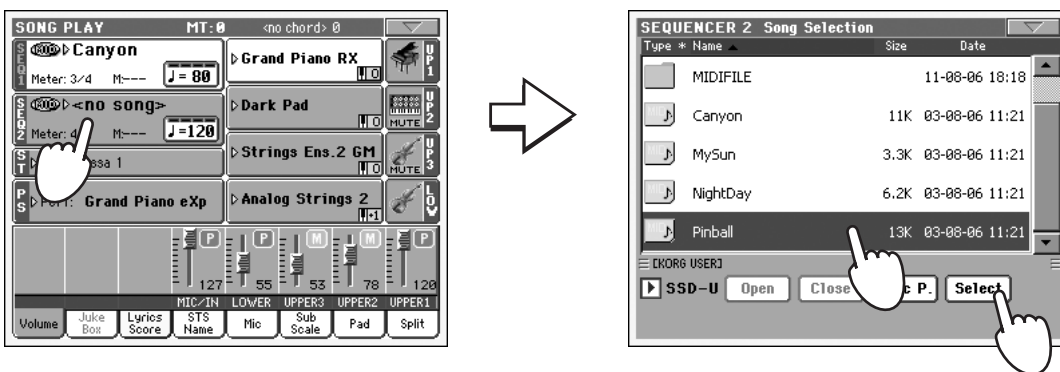

- 3 Keep the **SHIFT** button pressed, and press any of the two **▶/■** (PLAY/STOP) buttons, to start both Sequencers at the same time.

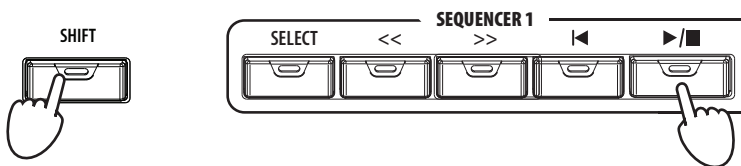

- 4 During playback, move the **SEQUENCER BALANCE** slider, to mix between the two Songs.

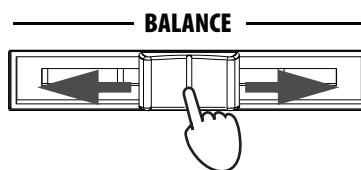

- 5 During playback, you may control each Sequencer separately, by using the dedicated Sequencer controls.
- 6 Press the relevant **▶/■** (PLAY/STOP) button to stop the corresponding Sequencer.

i Hint: You don't need to start both sequencers at the same time. You can start the first Song – then start the second one when the first one is near to the end. This way, you can use the BALANCE slider to gently crossfade between the end of one Song and the beginning of the following one.

The SongBook

One of the most powerful features of the Pa800 is the onboard music database, that allows you to organize your Styles and Songs (in SMF, KAR and – optionally – MP3 format) for easy retrieving. Each entry of this database may include the artist, title, genre, number, key, tempo, and meter of a specified song. When selecting one of the entries, the associated Style, Standard MIDI File or MP3 file – as well as the Style Play or Song Play mode – is automatically recalled.

In addition to helping you organizing your shows, the SongBook allows you to associate up to four STSs to each Standard MIDI File or MP3 file. This way, it is easy to recall a complete setup for Keyboard tracks, effects, and the Voice Processor, for realtime playing over a Standard MIDI File or MP3 file.

Also, you can link a text file to a Standard MIDI File, MP3 file or to a Style, to read the Lyrics in the display or in an external monitor, even if there are no Lyrics events in the midifile or MP3 file, or if you prefer to play the song live with the help of the Styles.

You can add your own entries to the SongBook, as well as edit the existing ones. Korg has already supplied some hundred entries as standard. Furthermore, the SongBook allows you to create various custom lists, that may suit your different shows.

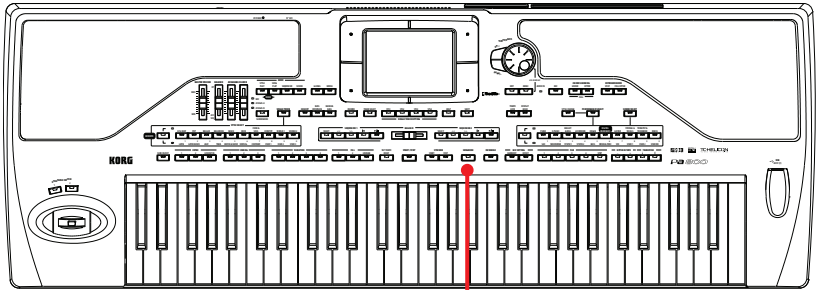

The SONGBOOK button

Selecting the desired entry from the Main List

A large database is already included with the instrument, and you can later customize it. You may browse through this database in a variety of ways.

- 1 While you are in Style Play or Song Play mode, press the SONGBOOK button to open the SongBook window.

Style, Standard MIDI File(s) or MP3 file(s) currently assigned to the arranger or sequencer(s)

SONGBOOK

SongBook Main List

Touch this checkbox to turn the view filter on.

Type	Name	Genre	Key	Tempo	Mete
2	much aPterworld	Ballad	----	84	4/4
5	A day in paradise	Pop	----	100	4/4
5	A gigolo	Pop	----	130	4/4
5	A groovy love	Ballad	----	73	4/4
5	A hard day/night	Pop	----	138	4/4
5	A whiter shade	Ballad	----	74	4/4

Filtered Filter... Add to list Select

Book Book Edit 1 Book Edit 2 Custom List List Edit Lyrics STS Info

Use the scroll bar to see all Songs in the list. Keep SHIFT pressed and touch the Up/Down arrow to scroll to the next/previous alphabetic section. As an alternative, you can use the DIAL.

Touch this button to edit the view filter.

Adds the selected entry to the Custom List (if activated – see page 67).

Touch this button to select the current entry to play.

2 Browse through the entries.

Icons in the Type column will help you identify the type of the entry. The Genre column is shown by default, but you can switch to the Artist column (see “Displaying Artist or Genre” below).

3 When the entry is visible in the display, select it and touch the Select button in the display.

After selecting an entry, the corresponding Style, SMF, KAR or MP3 file (optional) will be recalled, together with the relevant operating mode (Style Play or Song Play). Up to four STSs will also be recalled. Any TXT file associated with the entry can be seen in the Lyrics/STS page.

The selected Style, SMF, or KAR file, or MP3 is shown in the higher part of the screen.

Displaying Artist or Genre

For space matter, either the Genre or Artist column can be seen in the display. You cannot see both at the same time.

1 Touch the page menu icon to open the page menu.



i Note: The Artist and Key fields of all supplied entries have been intentionally left empty.

2 Choose Show Artist (now Genre) to switch from Genre to Artist in the List view. The Artist column will be shown.



3 Open the page menu again, and choose the Show Genre (now Artist) item. The Genre column will be shown again.

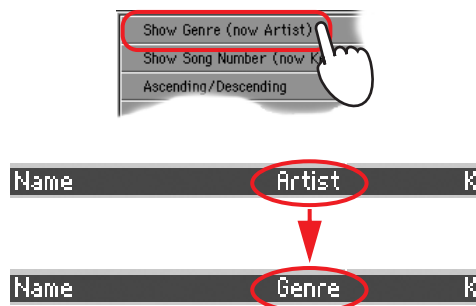

Sorting entries

You can change the order entries are shown in the display.

1 Touch the page menu icon to open the page menu.

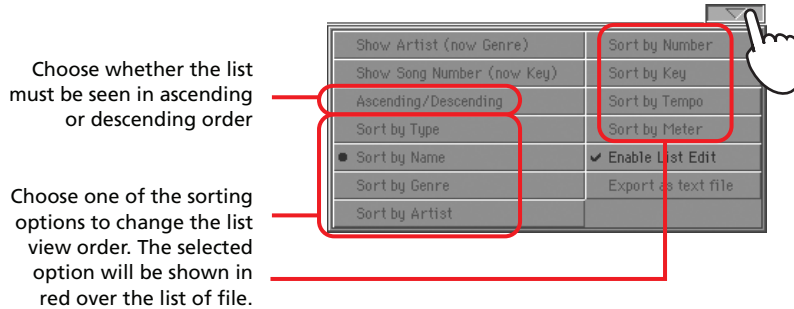

2 Select one of the available sorting options.

The order of entries in the display changes, reflecting the selected sorting option.

- As an alternative, you can change the sorting order by touching one of the labels in a list of names.

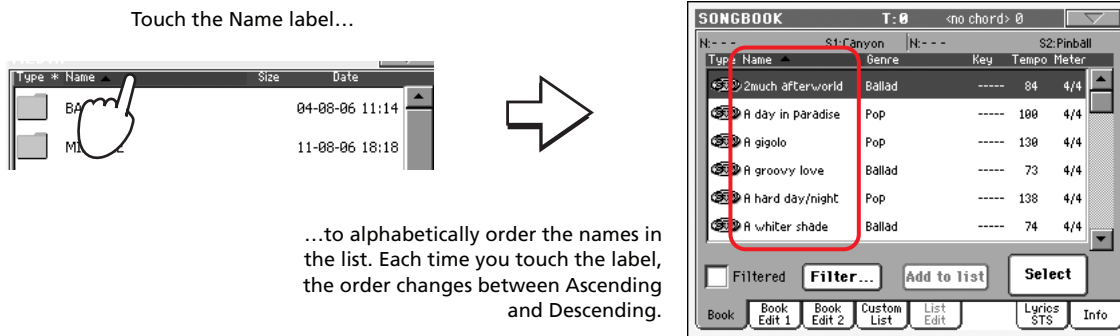

You can do the same by touching the Type, Name, Genre, Artist, Key, Number, Tempo or Meter label.

- Each time you touch the same label again, the order changes between ascending and descending.

Searching entries

The SongBook database may be really huge. You can, however, look for (say) specific artists or song titles, using the filtering functions.

1 Touch the Filter button in the display, to open the Filter dialog box.

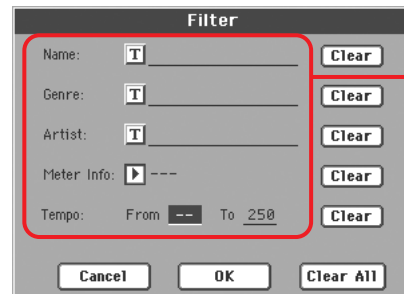
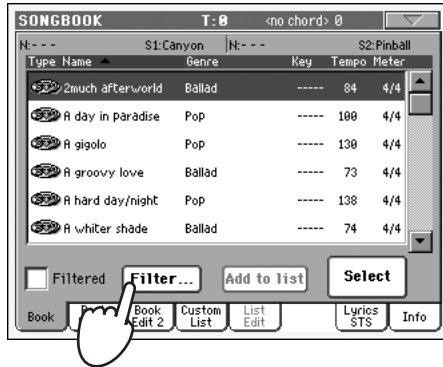

Available search criteria. "Genre" and "Artist" are both considered, even though only one of them may be shown in the List

2 Touch the **T** (Text Edit) button next to the search criteria (even more than one) you want to enter.

For example, you may want to find all songs containing the word "love" in the title (in any position in the string). If so, select the 'Name' criterion, and enter the word 'love'. Capitals are not relevant for the search.

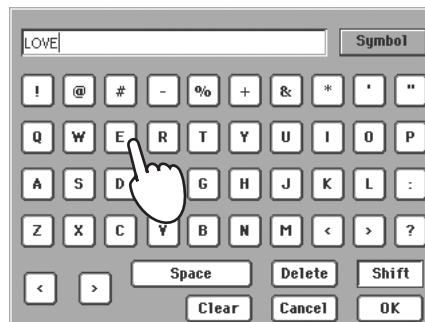
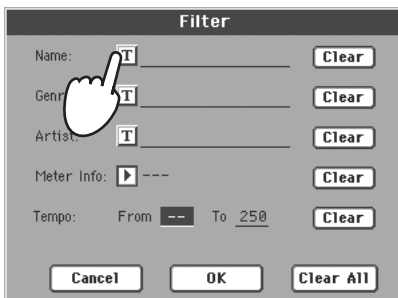

3 Touch OK in the display, and close the Text Edit dialog box. The entered text is now the search criteria.

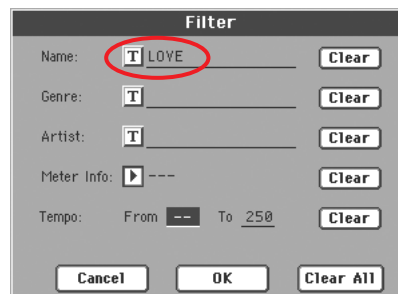
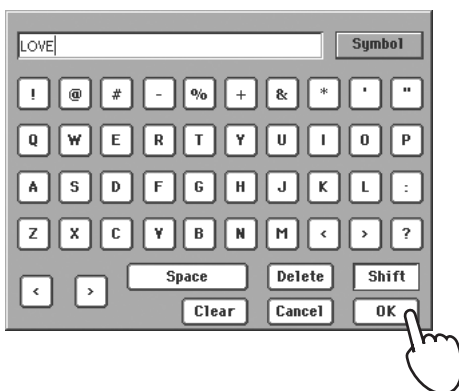

4 Touch OK to close the Filter dialog box and return to the SongBook page.

Once the Filter dialog box has been closed by touching OK, the Filtered check box is automatically checked, and the filter is activated. Only entries matching the entered criterion are seen in the Main List.

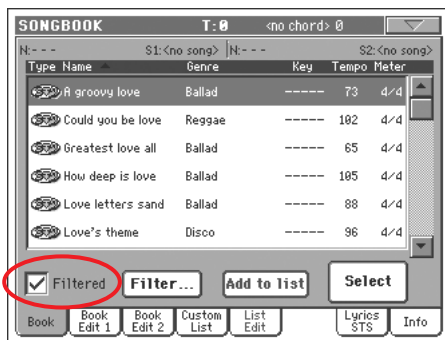

5 To see the whole SongBook database again, touch the Filtered check box again, to make the check mark disappear.

Adding entries

You can add your own entries to the SongBook database.

- 1 Go to the Style Play or Song Play mode, depending on the type of entry you want to add to the SongBook database.**
- 2 Select the Style, Standard MIDI File or MP3 file (optional) to be added to the SongBook.**
Assign the selected Song to Sequencer 1. (Only Songs assigned to Sequencer 1 will be saved in the SongBook entry. Songs assigned to Sequencer 2 will not be saved).
- 3 Edit Keyboard and Style tracks as you prefer, by selecting different Sounds and Effects, or editing any other parameter.**
Please note that changes to a Standard MIDI File's tracks will not be saved as SongBook data. Data included in the Standard MIDI File will always be considered.
- 4 Select a different Voice Processor Preset, if you like.**
- 5 When your entry is ready, press the SONGBOOK button, then the Book Edit 1 tab to see the Book Edit 1 page.**

The screenshot shows the 'SONGBOOK' interface with the following fields and controls:

- Name:** 2much afterworld
- Resource:** Love 8 Beat
- Genre:** T Ballad
- Tempo:** 84
- Artist:** T
- Meter Info:** 4/4
- Key Info:** --
- M.Transp.:** 0
- Write Current Resource:** <no song>
- Write STS:** Nylon Gtr & Fret
- To:** STS1
- Buttons:** New Song, Del Song, Write
- Bottom Bar:** Book, Book Edit 1, Book Edit 2, Custom List, List Edit, Lyrics STS, Info

Annotations:

- Entry's name:** Points to the Name field.
- Entry's parameters:** Points to the Genre, Tempo, Artist, Meter Info, Key Info, and M.Transp. fields.
- Currently selected resource. If a different Style, SMF, KAR or MP3 file has been selected, it may differ from the saved:** Points to the Resource field.
- One of the four STS available for each entry, where you can save the current settings for Keyboard tracks and the Voice Processor.** Points to the Write STS radio button.
- Touch New Song to create a new entry.** Points to the New Song button.
- Choose All Current Style STS to save the four STSs (recalled by the latest selected Style) with the new entry.** Points to the All Current Style STS radio button.

Text on the left:

When checked, current settings for Style tracks, or the path for the SMF, KAR or MP3 file, are saved with the entry. If unchecked, original Style track settings are saved with the entry.

This parameter is mandatory when creating a new entry by touching the New Song button.

When checked, current Keyboard track and Voice Processor settings are saved to one of the four STSs available for each entry. You can also exit the SongBook, edit Keyboard tracks, then return to the SongBook and save the new settings to a different STS. Touch the Text Edit icon to edit the STS name.

6 When done with this page, touch the tab to go to the Book Edit 2 page.

Name of the Style, SMF, KAR or MP3 file, memorized with the entry (provided "Write Current Resource" is selected when saving it).

Entry's name

Entry's parameters

Entry's progressive number

Track from which to take notes to be sent to the Voice Harmony.

Touch New Song to create a new entry.

Text file linked to the entry. This text will be seen as Lyrics in the display or in the external monitor. See "Lyrics as text files associated to a SongBook entry" on page 186.

7 Touch the New Song button in the display to add a new item to the SongBook list.

8 Touch the **T (Text Edit) button next to the field(s) you want to edit. Set all other parameters.**

You can write the genre, artist name, and name of the associated STS. Select a Tempo matching the song's tempo, and select the Meter and Key of the song. You can also specify a Master Transpose value, to be automatically selected when selecting the entry.

9 After having filled up all the desired fields (be as comprehensive as you can), touch the Write button in the display to open the Write dialog box.

10 Touch the **T** (Text Edit) button to assign a name to the new entry, then touch OK to save the entry to the SongBook database.

Entry's name. A good idea is to assign the entry the same name of the associated Standard MIDI File or MP3 file, or a name suitable for the use of the associated Style.

Select Rename/Overwrite to overwrite an existing entry. **Warning: the older entry will be deleted!**

Select New Song to add a new entry to the SongBook database. This option is automatically selected when a new entry has been created (by touching the New Song button while in the Edit 1 page).



Creating a Custom List

You can create several Custom Lists in the SongBook, to make a set of entries suitable for your various shows. Before starting a new Custom List, be sure you have added all needed entries to the SongBook main database (see "Adding entries" above).

1 While in SongBook mode, open the page menu and check the 'Enable List Edit' item.



After you check the 'Enable List Edit' item, the List Edit page becomes available.

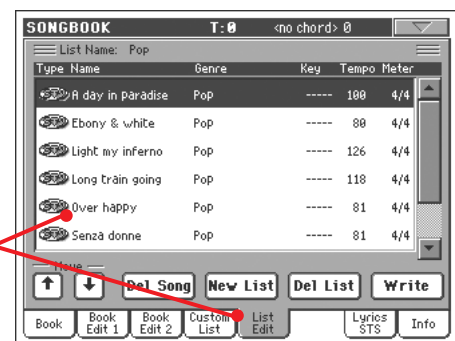

2 Select a Custom List to be edited.

To edit an existing list, touch the Custom List tab to open the Custom List page, and select one of the available Custom Lists. To create a new list, touch the List Edit tab to open the List Edit page, and touch the New List button to create a new, blank list.

3 Touch the Book tab to open the Book page and see the full database. Use the various sorting, searching and filtering options (seen above) to find

the entries you are looking for. Touch the **Add to List** button when the desired entry has been selected.

Use the scroll bar to see all Songs in the list. Keep SHIFT pressed and touch the Up/Down arrow to scroll to the next/previous alphabetic section. As an alternative, you can use the DIAL.

Touch this checkbox to turn the view filter on (if any).

Touch this button to edit the view filter.

Adds the highlighted entry to the Custom List.

Type	Name	Genre	Key	Tempo	Meter
2	much afterworld	Ballad	----	84	4/4
5	A day in Paradise	Pop	----	100	4/4
5	A gigolo	Pop	----	130	4/4
5	A groovy love	Ballad	----	73	4/4
5	A hard day/night	Pop	----	138	4/4
5	A whiter shade	Ballad	----	74	4/4

4 When finished adding entries to the Custom List, touch the **List Edit** tab to go to the List Edit page, and use the various commands to edit the list.

Use the vertical arrows to move the selected entry up or down in the list.

Touch Del Song to delete the selected entry.

Touch New List to create a new Custom List. Touch Del List to delete the current Custom List. **Warning:** Del List will delete the current Custom List.

Touch Write to save the current Custom List.

Select an entry on the list to edit

Type	Name	Genre	Key	Tempo	Meter
5	A day in Paradise	Pop	----	100	4/4
5	Ebony & white	Pop	----	80	4/4
5	Light my inferno	Pop	----	126	4/4
5	Long train going	Pop	----	118	4/4
5	Over happy	Pop	----	81	4/4
5	Senza donne	Pop	----	81	4/4

5 When the Custom List is ready, touch the **Write** button in the display to save it to memory. Assign a new name to the Custom List.

Touch the 'T' symbol to open the Text Edit dialog box.

Use the '<' and '>' buttons to move the cursor.

Touch Clear to delete the whole string, Delete to delete just a single character.

Touch Symbol to enter special characters.

Use alphabetic characters to enter text.

Use the SHIFT button to switch between capitals and small characters.

When done, touch OK to confirm the new name, or Cancel to abandon all changes.

Selecting and using a Custom List

After creating one or more Custom Lists, you can select one and use it for your show.

- 1 Touch the Custom List tab to select the Custom List page.
- 2 Use the List pop-up menu to select one of the available Custom Lists.

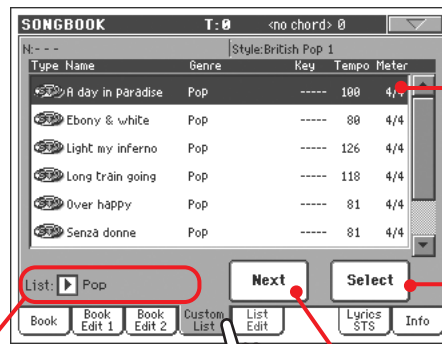

Entry in play. To select a different one, highlight it and touch the Select button in the display.

Touch Select to set the highlighted entry to play (if different than the one automatically selected).

Use the List pop-up menu to select one of the available Custom Lists.

Touch Next to select the next entry in the list. (This command can also be assigned to an Assignable Switch).

- 3 Select one of the entries in the list (it turns blue), then touch the Select button in the display (the selected entry turns green) to start playing back from there.

Selecting a SongBook STS

Up to four STSs can be associated to any SongBook entry. It doesn't matter if it is based on a Style, a Standard MIDI File or an MP3 file.

- 1 Touch the Lyrics/STS tab to open the Lyrics/STS page and see the four STSs associated to the current SongBook entry.

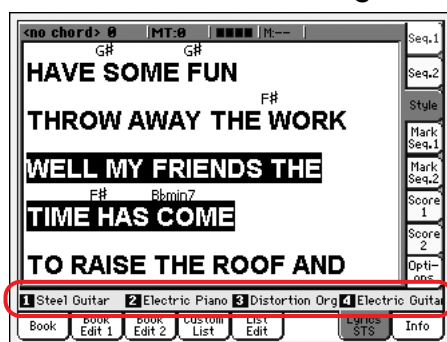

STSs associated with the current entry.

- 2 Select the desired STS by touching its name in the display. As an alternative, press the SINGLE TOUCH BUTTON corresponding to the desired STS.

The STS is selected. Keyboard tracks and Voice Processor settings may change.

Singing with a connected microphone

Pa800 is fitted with a powerful digital voice processor, based on technologies developed by TC Helicon, including effects and three-part harmonization.

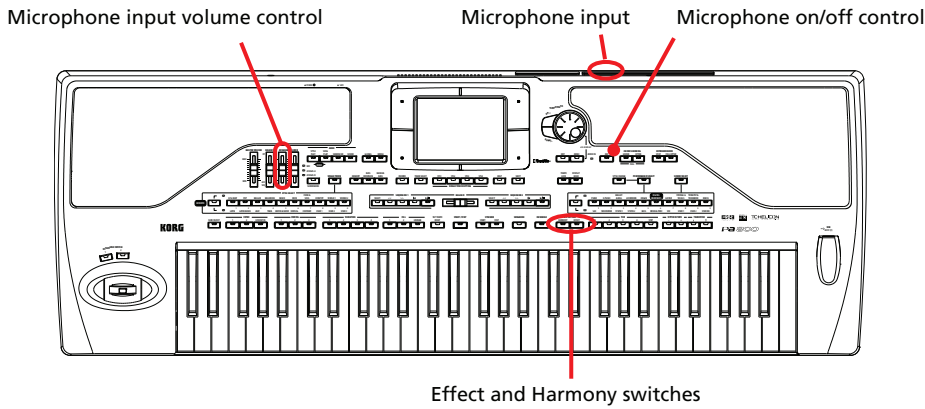

Connecting a microphone

To sing along with the Pa800, you must first connect a suitable microphone to AUDIO INPUT 1 (the one that goes to the Voice Processor). Any dynamic microphone is directly supported. To connect a phantom-powered condenser microphone, you need an external phantom power supply. You can also connect the microphone through an external mixer, and connect one of the mixer's line outputs to the AUDIO INPUT 1 of the Pa800.

- 1 Lower the Mic/In track volume by using the dedicated slider on the control panel.

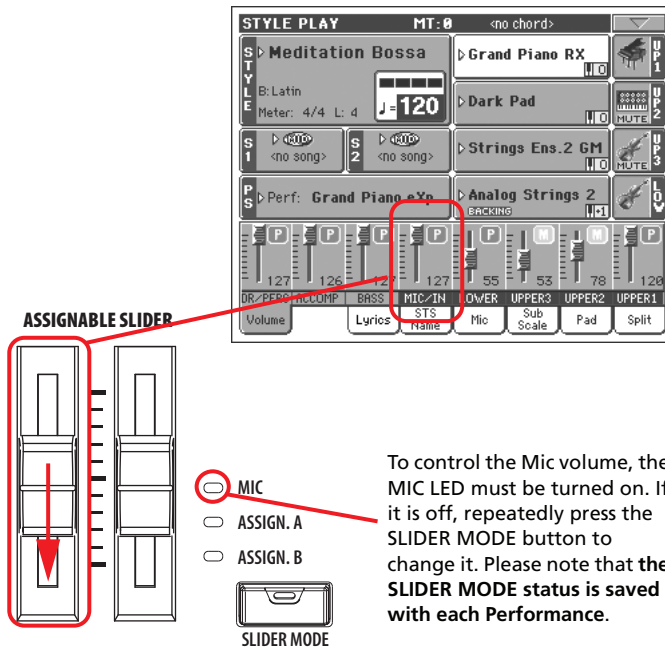

i Note: Lowering the Audio In track volume helps avoiding feedback. Feedback is caused by audio generated by the Pa800, returning to the audio circuitry via the microphone.

- 2 Connect a microphone.
- 3 Press the EFFECT and HARMONY buttons to turn their LED off, and deactivate the Voice Processor.

- 4 Go to the main page of the Style Play or Song Play mode, and select the Mic tab. Be sure the Mic input is not muted.

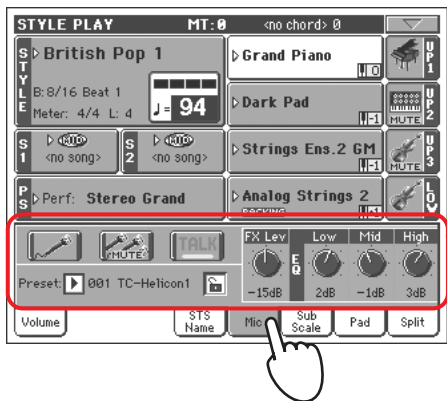

Mic panel. To test the microphone level, be sure the Mic Mute, Effects and Talk buttons are unchecked.

- 5 Sing into the microphone, and adjust the input gain and the Microphone volume, until you achieve the correct settings.

GAIN



AUDIO IN



Adjust the input level by using the GAIN knob next to the AUDIO INPUT 1. Sing into the microphone, and watch at the AUDIO IN LED on the control panel – it ought to stay green. If it goes orange too often (or even red), turn down the input gain; if it turns off too often, increase the input gain. No hint of distortion should be heard in the audio system when you sing.

i Note: You have a correct microphone volume setting when the AUDIO IN LED stays green most of the time. The AUDIO IN slider must be set accordingly, to compensate a too loud or weak incoming signal.

While you adjust the gain, gradually increase the Microphone volume, by using the corresponding slider.

ASSIGNABLE SLIDER

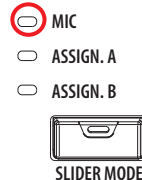
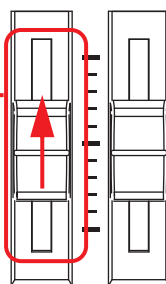

- 6 Press the EFFECT and HARMONY buttons to turn their LED on, and activate the Voice Processor.

- 7 Try the Play/Mute button of the Microphone panel, to mute/unmute the whole microphone section.



Microphone muted



Microphone set to play

i Note: This is the same play/mute control you can find in the "Mic In" channel strip of the Volume panel.

- 8 Touch the Volume tab to select the Volume panel.

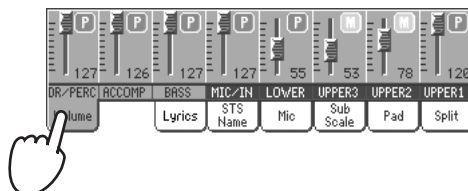

9 If you like, start a Style or Song. Adjust the microphone final volume using the dedicated slider.

10 Adjust the other settings, balancing the Style/Song and microphone with the BALANCE slider and the Microphone slider.

The settings for the BALANCE and MIC sliders are not saved in memory, so they stay consistent when selecting different Styles, Performances, Songs or Voice Processor settings.

Applying harmony to your voice

1 Be sure you are in Style Play mode, and select a Style you especially like.

2 Touch the Mic tab to show the Microphone panel, and select one of the available Voice Processor Presets.

Voice Processor Presets are settings for the various Voice Processor modules (Effects, Harmony). By selecting a Preset, all processing parameters may change.

A Voice Processor Preset is assigned to each Performance or STS. When selecting a different Performance or STS, the Voice Processor Preset may change (depending on the Mic panel lock status), changing the type of processing applied to your voice.

i Note: By default, Preset #1 is a solo voice; Preset #2 contains a three-voice harmony.

i Note: By default, the first Performance and STS have the harmony effect turned off, to avoid any unwanted processing from being applied to the microphone. When you select a Preset you like, you can save it to a Performance or STS (see "Saving your settings to a Performance" on page 41)

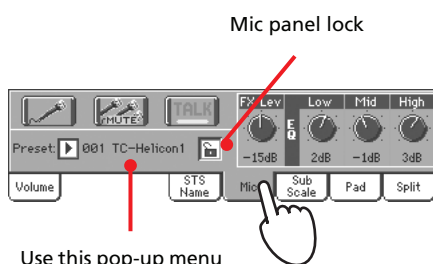

Use this pop-up menu to select a Voice Processor Preset.



3 If you like, start the Style.

4 Be sure the HARMONY LED is turned on on the control panel.

5 Play some chords, to let the Voice Processor create new voices with them.

6 Sing along with the chords and melody you play on the keyboard.

7 If it is playing, stop the Style.

Soloing your voice (TalkBack)

Sometimes, during a live show, you might like to talk to your audience. Use the TalkBack function to attenuate the music, and let your voice pass through clean and clear.

- 1 **While in the main page of the Style Play or Song Play mode, touch the Mic tab to see Voice Processor's settings.**
- 2 **During playback, touch the Talk button, making it appear depressed.**



- 3 **Sing or talk into the microphone.**

You'll hear background music has been made softer, while your voice will be heard *loud and proud*. The effects have probably changed, too.

- 4 **To turn the TalkBack function off, touch the Talk button again, making it appear relieved.**

The background music returns to the original volume.

Locking Voice Processor settings

If you like the selected Voice Processor Preset, and other settings you have made in the Microphone panel, you can “lock” them, to prevent them from changing each time you select a Performance, Style or STS that may be saved using different settings.

- 1 **While the Microphone panel is shown in the display, touch the lock icon to freeze it.**



Lock on. Voice Processor settings will not change when selecting a different Performance or STS.

- 2 **To unlock the settings, touch the lock icon again.**



Lock off. Voice Processor settings will change when selecting a new Performance or STS.

Recording a new Song

There are several ways to create a Song on the Pa800. The easiest and fastest is to use the Styles to record what you are playing in realtime on the keyboard, while the arranger gives you the accompaniment tracks.

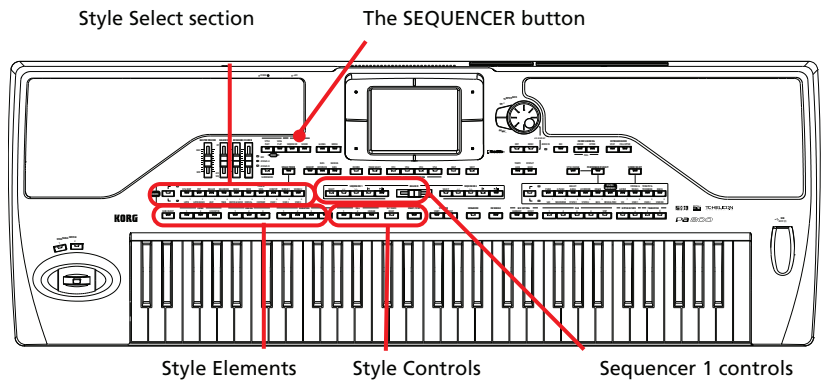

Entering Backing Sequence (Quick Record) mode

1 Press the **SEQUENCER** button to switch to the Sequencer mode.

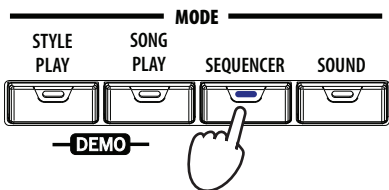

After pressing the SEQUENCER button, the main page of the Sequencer mode appears.

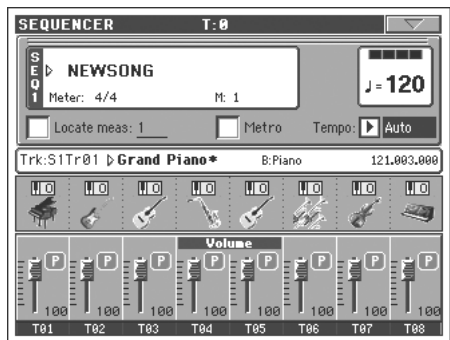

2 Press the **RECORD** button to open the Song Record Mode Select dialog box.

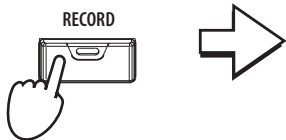

Press the RECORD button, to open the Song Record Mode Select dialog box



3 Select the Backing Sequence (Quick Record) option and touch OK to enter the Backing Sequence Record mode.

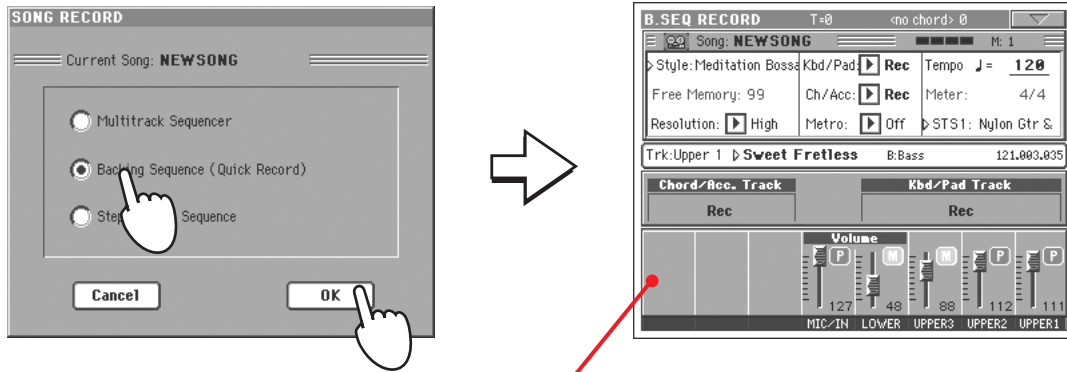

After choosing the Backing Sequence (Quick Record) option, the Backing Sequence Record page appears.

Preparing to record

When you enter Backing Sequence Record, the most recently used Style is already selected, and all tracks are ready to record. You could simply start recording as if you were playing in realtime with the Styles. However, there are some settings that you may wish to edit.

- **If you like, adjust any editable parameter in the display.**

Touch the Style parameter (or one the STYLE buttons) to open the Style Select window, and select a different Style (as seen on page 45).

Track(s) status. 'Rec' means they are ready to record. 'Play' means they are recorded and you can hear them. 'Mute' means they cannot be heard.

Measure counter. Negative numbers (-2, -1) are the precount, after which you can start recording.

Style's Tempo. Change it, if you like.

Style's Meter. You cannot change it.

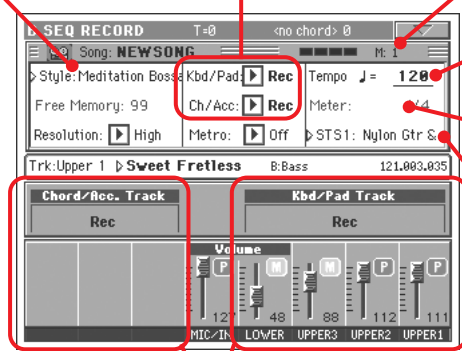

Grouped tracks. During Quick Record, you cannot access each separate Song track. For ease of use, just two 'master' tracks are provided: Kbd/Pad (Keyboard/Pads) and Ch/Acc (Chord/Accompaniment).

Recording

1 Select the Style Element you wish to use before starting to play.

Select one of the Intros to start with an introduction. Select any of the Variations before starting to record.

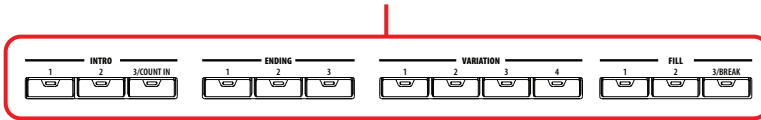

2 Start recording, by pressing the START/STOP button.

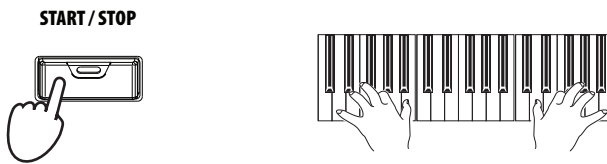

i Note: If you do not wish to start the Song with the Style playing, you can simply start recording by pressing the PLAY/STOP button in the SEQUENCER 1 section, and start the Style only later. The Style will start at the next beginning of the measure.

3 Play as if you were performing live with the Styles.

During recording, select any Style Element (Intro, Variation, Fill, Ending...) you like. You can also press START/STOP to stop the Style, and press it again to start the Style up again!

Please remember that, while recording in Backing Sequence Record mode, you cannot use the SYNCHRO, TAP TEMPO/RESET, BALANCE VOLUME controls.

4 When finished recording your Song, press the (PLAY/STOP) button in the SEQUENCER 1 section to exit recording, and return to the main page of the Sequencer mode.

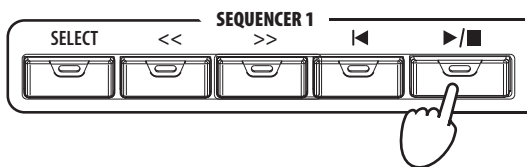

After pressing the PLAY/STOP button, the main page of the Sequencer mode appears again.

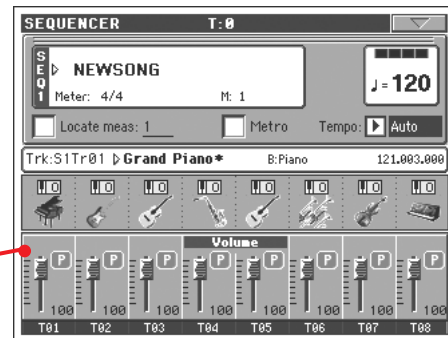

5 While in the main page of the Sequencer mode, press the (PLAY/STOP) button in the SEQUENCER 1 section to listen to the recorded Song.

The Backing Sequence Song has been converted to an ordinary Song. If you like it, you can save it to disk, and read it in Song Play mode, or with any external sequencer.

6 To edit the Song, press MENU to enter the Edit mode (see instructions starting from page 201).

Second-take recording (Overdubbing)

You may wish to re-record, and add one of the two “grouped” tracks, or overwrite a bad recording with a new one. Usually, you will record all chord and Style Element changes during the first take, and record Keyboard tracks and Pads during the second take.

- 1 Press the **RECORD** button to enter Record again. When the **Song Record Mode Select** dialog box appears, select **Backing Sequence (Quick Record)** again.
- 2 If you are recording just one of the “grouped” tracks, set the track to be preserved to the **Play** mode.

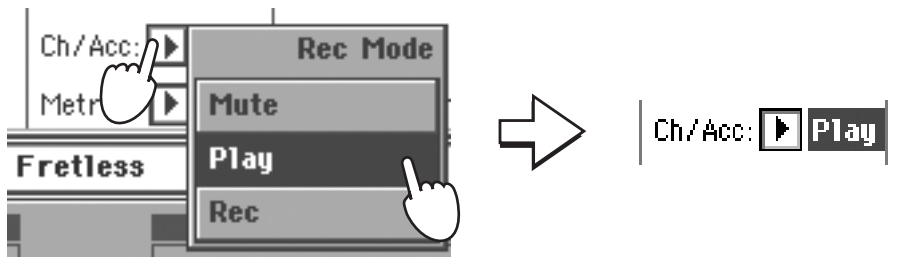

- 3 Repeat the recording process, and press the **▶/■ (PLAY/STOP)** button in the **SEQUENCER 1** section to stop recording and to return to the main page of the Sequencer mode.
- 4 While in the main page of the Sequencer mode, press the **▶/■ (PLAY/STOP)** button in the **SEQUENCER 1** section to listen to the recorded Song.

Again, the Backing Sequence Song has been converted to an ordinary Song.

Saving a Song to disk

After recording a Song that you like, it is a good idea to save it to disk, to avoid losing it when the instrument is turned off.

- 1 While in the main page of the Sequencer mode, touch the page menu icon to open the page menu.

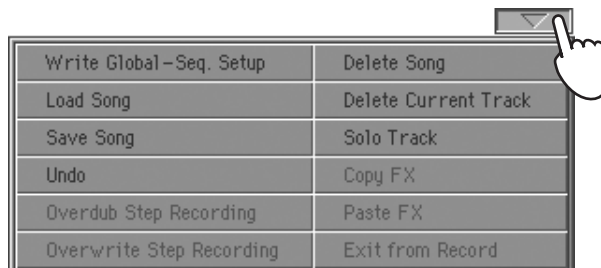

2 Select the Save song command to open the Save Song window.



After you select the Save song command, the Save Song page appears.

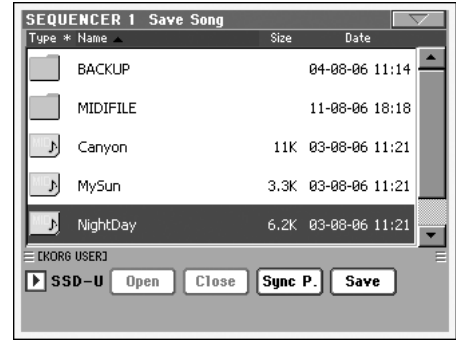

3 Select a device and folder where you want to save your Song.

If a Song is selected (highlighted) it will be overwritten. If no Song is selected, a new Song file will be created on the target device.
To deselect a selected Song, touch anywhere else in the Song list, or select the same storage device again.

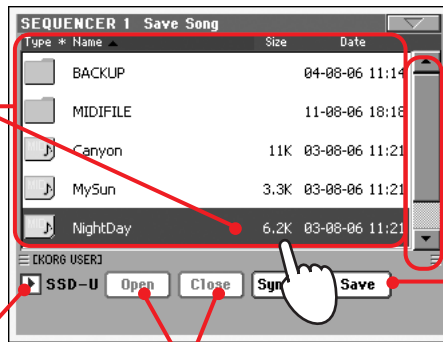

Use the scroll bar to see all Songs in the list. Keep SHIFT pressed and touch the Up/Down arrow to scroll to the next/previous alphabetic section. As an alternative, you can use the DIAL.

Touch the Save button to save the Song to the current folder.

Use the Device pop-up menu to select one of the available storage devices (SSD-U, hard drive...).

Use the Open and Close buttons to browse through the folders.



In case you prefer to exit this page without saving the Song, press the EXIT button.

4 Touch the Save button in the display to open the Save Song dialog box.

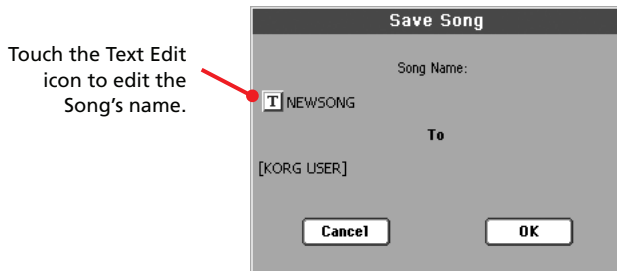

5 Touch OK in the display to save the Song to disk, or Cancel to stop the Save operation.

Reference

Selecting elements

The following windows are shown in the various operating modes, whenever you try to select a Sound, Performance, Style or Song.

Sound Select window

Touch the Sound area whereas it appears in the display, or one of the SOUND SELECT buttons on the control panel (provided the SOUND SELECT LED is lit), to open the Sound Select window. Use the SOUND SELECT buttons to go directly to the selected bank.

Press EXIT to exit from this page and go back to the previous page without selecting any Sound.

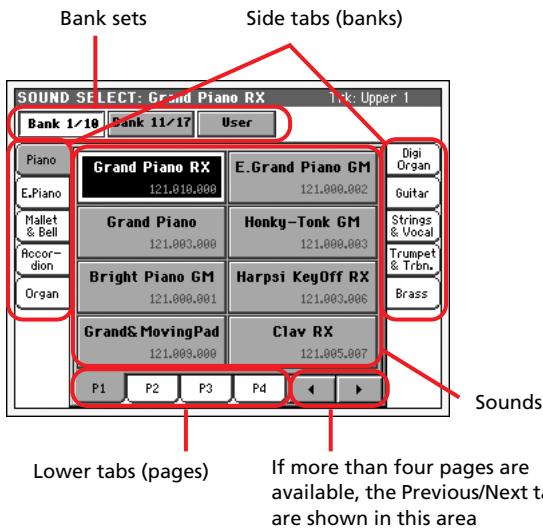

Note: Depending on the status of the “Auto Performance/Sound Select” parameter (see page 221), a Sound may be immediately selected when pressing one of the SOUND SELECT buttons. The latest selected Sound for that bank will be selected.

Bank sets

Selected set of banks (top or bottom row of Factory Styles, User banks).

Side tabs (banks)

Use these tabs to select a bank of Sounds. Each tab corresponds to one of the SOUND SELECT buttons on the control panel.

Lower tabs (pages)

Use these tabs to select one of the available pages in the selected bank.

If you press again the same PERFORMANCE/SOUND SELECT button on the control panel, the next page in the same bank is selected. This way, you do not need to touch one of the corresponding tabs in the display in order to select a different page.

Previous/Next tabs

Scroll the lower tabs to the left or the right, when additional tabs are available but cannot be seen in the display.

Sounds

Touch one of these buttons in the display to select a Sound. Unless the DISPLAY HOLD LED is turned on, the window automatically closes short after you select a Sound.

Program Change

Program Change number. Shown only when the “Show Program Change number” parameter is turned on in Global mode. (See page 221).

Performance Select window

Touch the Performance area whereas it appears in the display, or one of the PERFORMANCE SELECT buttons on the control panel (provided the PERFORMANCE SELECT LED is lit), to open the Performance Select window. Use the PERFORMANCE SELECT buttons to go directly to the selected bank.

Press EXIT to exit from this page and go back to the previous page without selecting any Performance.

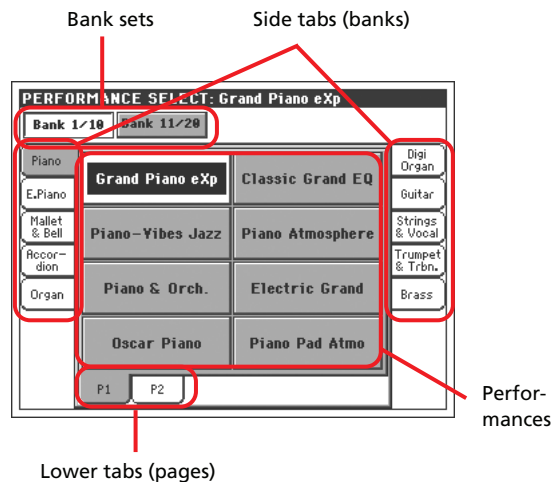

Note: Depending on the status of the “Auto Performance/Sound Select” parameter (see page 221), a Performance may be immediately selected when pressing one of the PERFORMANCE SELECT buttons. The latest selected Performance for that bank will be selected.

Bank sets

Selected set of banks (top or bottom row of Performances).

Side tabs (banks)

Use these tabs to select a bank of Performance. Each tab corresponds to one of the PERFORMANCE SELECT buttons on the control panel.

Lower tabs (pages)

Use these tabs to select one of the available pages in the selected bank.

If you press again the same PERFORMANCE/SOUND SELECT button on the control panel, the next page in the same bank is

selected. This way, you do not need to touch one of the corresponding tabs in the display in order to select a different page.

Performances

Touch one of these buttons in the display to select a Performance. Unless the DISPLAY HOLD LED is turned on, the window automatically closes short after you select a Performance.

Style Select window

Touch the Style area whereas it appears in the display, or one of the STYLE buttons on the control panel, to open the Style Select window. Use the STYLE buttons to go directly to the selected bank.

Press EXIT to exit from this page and go back to the previous page without selecting any Style.

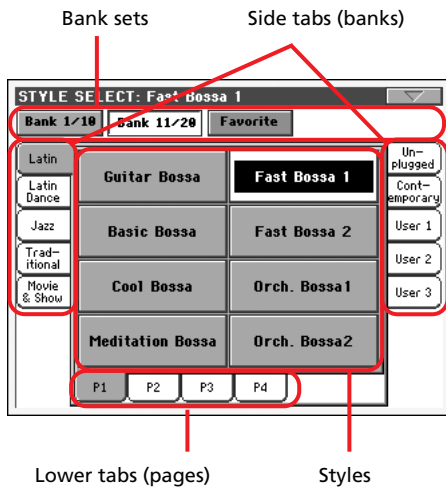

Note: Depending on the status of the “Auto Style Select” parameter (see page 221), a Style may be immediately selected when pressing one of the STYLE SELECT buttons. The latest selected Style for that bank will be selected.

Bank sets

Selected set of banks (top or bottom row, or Factory Styles).

Side tabs (banks)

Use these tabs to select a bank of Styles. Each tab corresponds to one of the STYLE buttons on the control panel.

Lower tabs (pages)

Use these tabs to select one of the available pages in the selected bank.

If you press again the same STYLE SELECT button on the control panel, the next page in the same bank is selected. This way, you do not need to touch one of the corresponding tabs in the display in order to select a different page.

Styles

Touch one of these buttons in the display to select a Style. Unless the DISPLAY HOLD LED is turned on, the window automatically closes short after you select a Style.

After selecting a Style from this window, and another Style is playing, the name of the new Style name begins to flash, meaning it is ready to start playing at the beginning of the next measure.

Style Select page menu

Touch the page menu icon to open the menu. Touch a command to select it. Touch anywhere in the display to close the menu without selecting a command.



Rename Favorite Bank

Choose this command from the page menu, and assign the Favorite Style banks any name you like.

The assigned name can be spanned over two lines, by separating them with the paragraph character (¶). For example, to write “World Music” on two lines, enter “World¶Music”.

Be careful not to write words exceeding the width of the side tabs of the Style Select window.

Pad Select window

Touch the Pad area whereas it appears in the display, to open the Pad Select window.

Press EXIT to exit from this page and go back to the previous page without selecting any Pad.

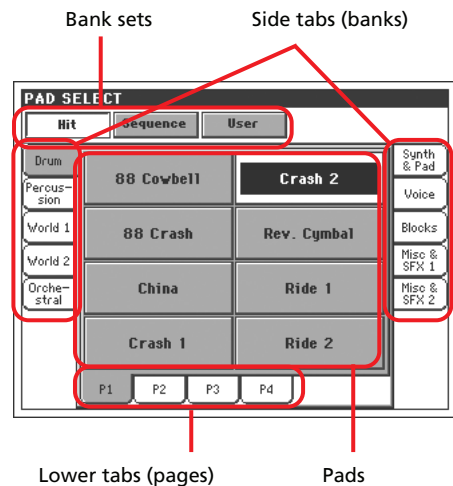

Bank sets

Selected set of banks, corresponding to different types of Pads. **Hit** are single-note, pre-programmed factory Pads. **Sequence** are sequence-based, pre-programmed factory Pads. **User** can be either single-note or sequence-based Pads, and can be user-recorded or modified.

Side tabs (banks)

Use these tabs to select a bank of Pads.

Lower tabs (pages)

Use these tabs to select one of the available pages in the selected bank.

Pad

Touch one of these buttons in the display to select a Pad. Unless the DISPLAY HOLD LED is turned on, the window automatically closes short after you select a Pad.

STS Select

Use the four SINGLE TOUCH SETTING button on the control panel, to select one of the four STS associated with the current Style or the selected SongBook entry.

Touch the STS Name tab in the main page of the Style Play or Song Play mode, or the Lyrics/STS tab in the SongBook mode, to see the name of the available STSs.

- In Style Play and Song Play mode:



- In SongBook mode:



Song Select window

This page appears when you touch one of the Song areas in the display, or one of the SELECT buttons in one of the SEQUENCER sections on the control panel.

Press EXIT to exit from this page and go back to the main page of the Song Play operating mode without selecting a Song.

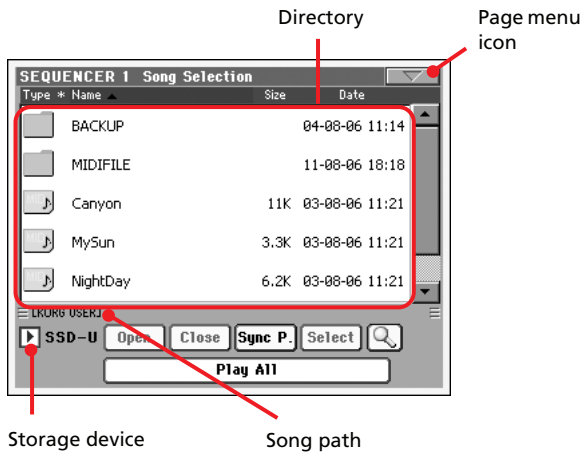

While in this page, select a Standard MIDI File, Karaoke or MP3 file (optional) for the selected Sequencer. A Jukebox file may only be assigned to Sequencer 1.

Note: There is a separate working directory for each onboard sequencer.

Directory

This is the list of the selected device's content.

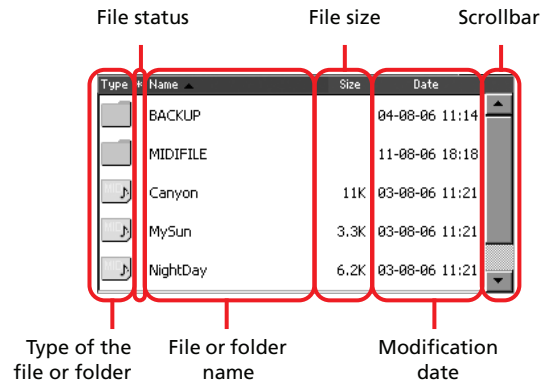

Use the scrollbar to scroll the list items.

As an alternative, you can use the TEMPO/VALUE controls to scroll.

Keep the SHIFT button pressed, and touch one of the arrows, to jump to the previous or next alphabetical section.

You can touch one of the labels on top of the list, to reorder the list items accordingly. By touching the label again, the order of the files switches between ascending and descending.

A list can contain several different types of files or folders.

Type icon	File/folder type
	Standard MIDI File (SMF)
	Karaoke file (KAR)
	MPEG Layer 3 (MP3)
	Jukebox file (JBX)
	Folder

A file or folder may be in one of the following status. (See "Protect" and "Unprotect" on page 260 for information on how to change the file status).

Status icon	File/folder status
	Protected
	Unprotected

Page menu icon

Touch the page menu icon to open the menu. See "Song Select page menu" on page 83 for more information.

Storage device

Use this pop-up menu to select one of the available storage devices.

Device	Type
SSD-U	User area of the internal SSD memory
HD	Hard disk (optional)
USB-F	Device connected to the front USB Host port
USB-R	Device connected to the rear USB Host port

The actual name (label) of the device may appear within square brackets ([]).

Song path

This line shows the current device path.

Open

Opens the selected folder (item whose icon looks like this one: ).

Close

Closes the current folder, returning to the parent (“upper”) folder.

Sync P. (Synchronized Path)

Touch this button to see the Song assigned to the selected Sequencer. This is useful to quickly return to it, after you have browsed through long directories and “dug” into different folders.

Select

Selects the highlighted item in the display. If a Song is already playing, it stops, and the new Song is ready to play. You are returned to the main page.

Search

The Search function allows for searching a Song file in the various media. See “Searching files” on page 244 for more information.

Play All

When this button is touched, all midifiles and MP3 files contained in the current directory are added to a new Jukebox list, that is automatically assigned to Sequencer 1. The order in which they are played depends on the current sorting method, i.e., how the files are shown in the display.

You can use this Jukebox list as any other list of this type (i.e., start the playback with SEQ1 PLAY/STOP, jump to the next Song in the list with SHIFT + >>, edit it in the Jukebox page...).

Note: A Jukebox list can include up to 127 Songs. If your folder contains more items, only the first 127 will be considered.

Hint: If you don’t want to lose the list when turning the instrument off, go to the Jukebox page and save it to disk as a “.JBX” file.

Selecting a Song by its ID number

Each Song in a folder on a device (up to 9,999) has a progressive ID number assigned. When the “Show Song Number” option is selected in the Song Select page menu (see below), you can see this number before the Song’s name in the Song Select window. You can use this number to select the Song by composing the corresponding number, speeding up the Song retrieval when you are using an hard disk filled with midifiles.



While in the Song Select window, press the SELECT button to open the keypad, and enter the number corresponding to the Song to be selected.

While in any page of the Song Play mode, press the SELECT button twice to open the keypad.

Note: If no Song corresponds to the dialed number, the “Song not available” message will appear.

Warning: While the directory may contain more than 9999 files, you can’t select Songs outside the 0001-9999 range when using the numeric keypad.

Song Select page menu

Touch the page menu icon to open the menu. Touch a command to select it. Touch anywhere in the display to close the menu without selecting a command.

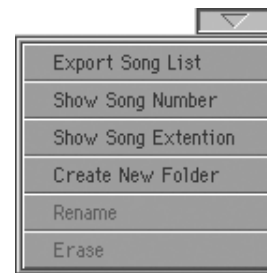

Export Song List

Select this command to save the current list as a text file to the SSD-U memory or the internal hard disk (if installed). This way, you will be able to print a list of Songs, to see which number matches each Song.

1. While in the Song Select window, select the folder whose Song list you wish to save as a text file.
2. Select the Export Song List command from the page menu.
3. A dialog box will appear, asking you to select either the SSD-U memory or the hard disk.

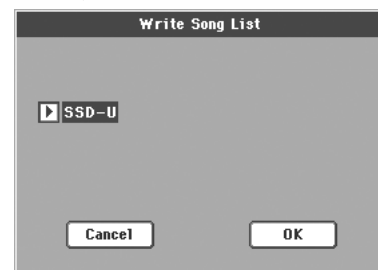

4. Select an option, and touch OK to confirm.

Note: The text file will contain a list of “*.mid”, “*.kar”, “.mp3” and “*.jbx” files only. Folders and different kinds of files will not be included.

When saved, the text file will be named after the selected folder. For example, a folder named “Dummy” will generate a “Dummy.txt” file. If a file with the same name already exists in the target, it will be overwritten without waiting for any confirmation. A file containing the list of all valid files contained into the root of the disk will generate a “Root.txt” file.

The list will include the progressive number assigned to each Song, file names, the total number of files in the list.

For the correct display and printing of the list on a personal computer, use a fixed size (i.e., non-proportional) character in your text editor.

Show Song Number

Check this option to make the Song’s progressive ID number appear in the list, next to each Song.

Show Song Extension

Check this option to make the file extension (“*.mid”, “*.kar”, “*.jbx”, “*.mp3”) appear in the list, at the end of each Song’s name.

Create New Folder

This command lets you create a new generic folder in the root of any device, or inside any other generic folder. You can’t create a “.SET” folder with this command, since this type of folder is reserved to the Save operations (and can be created with the New SET button in any Save page).



By touching the **T** (Text Edit) button you can open the Text Edit window. Enter the name, then touch OK to confirm and close the Text Edit window.

Rename

Available only when an item is selected in a list.

Use this function to change the name of an existing file or folder. You cannot change the 3-character extension of files and “.SET” folders, since they are used to identify the type of file or folder.

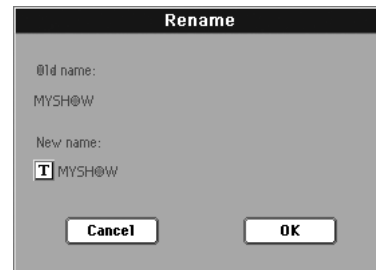

Touch the **T** (Text Edit) button to open the Text Edit window. Enter the new name, then touch OK to confirm and close the Text Edit window.

Erase

Use this command to delete the selected file or folder.

Style Play operating mode

The Style Play mode is the boot-up operating mode. When in this mode, you can play with Styles (i.e. automatic accompaniments), while playing with one to four tracks (Upper 1-3 and Lower) on the keyboard, and up to four Pad tracks. You can select different Sounds and Effects by selecting Performances and STSs. A different Voice Processor Preset may be selected by a Performance or STS. You can also use the SongBook to automatically select Styles for a desired music genre, while linking a text file containing Lyrics to a Style.

Style Play mode can also be used in Easy Mode (see page 6).

Start-up settings

Since Performance 1 of Bank 1 (Performance 1-1) is automatically selected when turning the instrument on, you can save to it your preferred start-up settings.

Select the Sounds, Effects, Voice Processor Preset, and other settings you would like to see automatically selected when turning the instrument on. Then select the “Write Performance” command from the page menu. When the Write Performance window appears, save the settings to Performance 1 of Bank 1. (See “Write Performance dialog box” on page 109).

Note: *If you like some settings to be preserved even when choosing different Performances, STSs and Styles, turn on the desired “locks” to avoid changes to the selected parameters (see “General Controls: Lock” on page 218). Save these locks to the Global (see “Write Global - Global Setup dialog box” on page 231).*

How Styles, Performances and STSs are linked together

Styles, Performances and STSs are linked in many ways.

- When the SINGLE TOUCH LED is steadily on or blinking, selecting a Style also changes Keyboard tracks (STS 1 is automatically selected). Performance settings are overridden.
- When the STYLE CHANGE LED is on, selecting a Performance also selects a Style (the one whose number is memorized with the Performance).
- Current track settings can be saved either in a Performance, an STS, or a Style Performance, depending on the page menu command you select.

Master Volume and Balance

While the MASTER VOLUME slider controls the general volume of the instrument, you can use the BALANCE slider to balance the Style Accompaniment and Pad tracks against the Keyboard tracks.

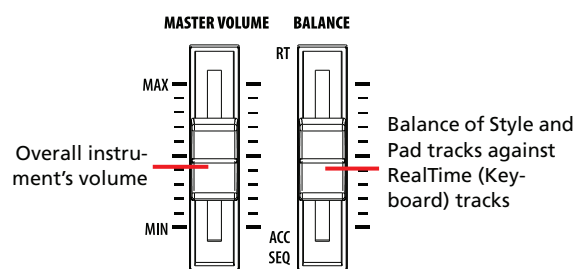

Note: *As an alternative, the BALANCE slider can also work as a volume control. See “Balance Slider” on page 221.*

Factory, User and Favorite Styles

There are three different types of Style locations:

- Factory Style banks (from “8/16 Beat” to “Contemporary”, i.e., from BANK01.STY to BANK17.STY) are the preloaded Styles, that you can’t usually edit (unless you don’t want to do so, by turning the protection off, see “Factory Style and Pad Protect” on page 264).
- User Style banks (from “User 1” to “User 3”, i.e., from USER01.STY to USER03.STY) are Styles loaded from an external device, created or edited by yourself (the User). These are banks conceived as a ‘workbench’ – a place where to manage Styles and banks before saving them to a final location. See the “Style Record mode” chapter on page 114 for information on how to edit or create Styles.
- Favorite Style banks (by default, from “Favorite 1” to “Favorite 10”, i.e., from FAVORITE01.STY to FAVORITE10.STY) are similar to User Styles, but you can rename the tabs in the Style Select window to create places for custom banks, or for additional music genres that are not already included among the supplied banks. See “The Favorite banks” on page 110 for information on how to manage these Styles.

Main page (Normal view)

This is the page you see after you turn the instrument on.

To access this page from another operating mode, press the STYLE PLAY button.

To return to this page from one of the Style Play edit pages, press the EXIT button.

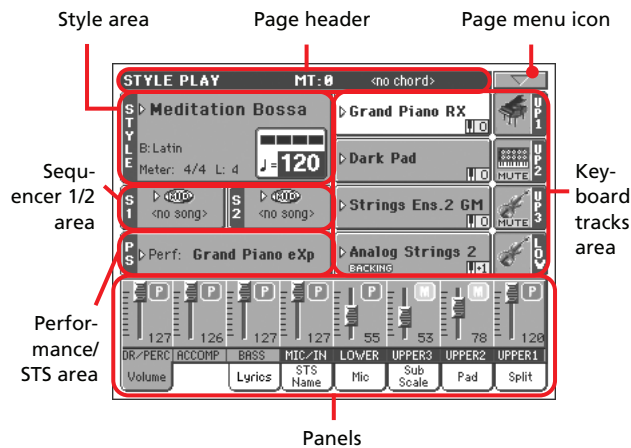

To switch between Normal view (Keyboard tracks, grouped Style tracks and Mic/In controls) and Style view (individual Style tracks), use the TRACK SELECT button. (See “Style Tracks view page” and “Volume panel” starting from page 88).

Page header

This line shows the current operating mode, transposition and recognized chord.

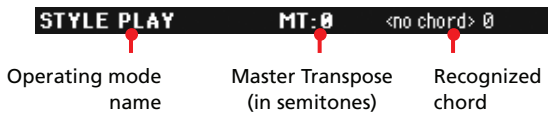

Operating mode name

Name of the current operating mode.

Master transpose

Master transpose value in semitones. This value can be changed using the TRANPOSE buttons on the control panel.

Note: Transpose may be automatically changed when selecting a different Performance or Style. It may also be changed when loading a Standard MIDI File generated with an instrument of the Korg Pa series.

To avoid transposing, the Master Transpose is “locked” by default. If you want to lock or unlock it, change the Master Transpose Lock parameter’s status (see “General Controls: Lock” on page 218), then write the Global to memory (see “Write Global - Global Setup dialog box” on page 231).

Recognized chord

Displays the recognized chord, when you play a chord on the keyboard. If no chord abbreviation is shown, no chord recogni-

tion mode has been selected by using the CHORD SCANNING buttons (see page 15).

Chords are shown according to the standard suggested in the book “Standardized Chord Symbol Notation (A Uniform System for the Music Profession)” by C. Roemer and C. Brandt (Roerick Music Co., 1976).

Page menu icon

Touch the page menu icon to open the menu. See “Page menu” on page 108 for more information.



Style area

This is where the Style name is shown, together with its tempo and meter parameters.

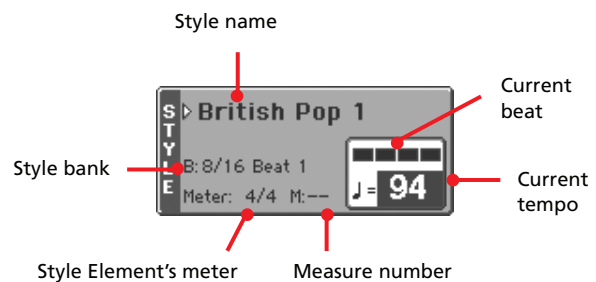

Style name

▶PERF

Currently selected Style. Touch the Style name to open the Style Select window. As an alternative, use the STYLE SELECT section on the control panel.

Style bank

▶PERF

Bank the current Style belongs to.

Style Element meter

Meter of the current Style Element.

Measure number

While the Style is playing, an ‘M’ appears, and it shows the current measure number of the current Style Element playing. While it is in stop, an ‘L’ appears, and it shows the total number of measures of the current Style Element.

Current beat

Beat number of the current measure, that is currently playing.

Current tempo

▶PERF ▶PERF^{Sty}

Metronome tempo (from 30 to 250). Select this parameter and use the TEMPO/VALUE controls to change the tempo.

As an alternative, you don’t need to select this parameter; just keep the SHIFT button pressed and use the DIAL to change the tempo.

To recall the Tempo stored in the current Style, press the DOWN/- and UP/+ buttons at the same time.

Note: Tempo may change while a Style Element is playing. Each Style Element may contain Tempo Change data.

Sequencer 1/2 area

This is where Songs assigned to the two onboard sequencers are shown.

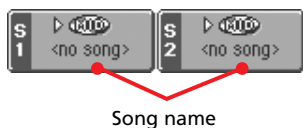

Song name

Name of Songs assigned to Sequencer 1 (S1) and Sequencer 2 (S2). You can select Songs while playing Styles, to have them ready when switching to Song Play mode.

The icon shows the type of the selected Song.



Standard MIDI File, often abbreviated as SMF (file extension: *.MID or *.KAR).



MPEG Layer-3 format, or MP3 (file extension: *.MP3) – available with the EXBP-Dual MP3 option installed. This is a compressed audio file, that may be generated on any personal computer, or on the Pa800 itself.



Only assignable to Sequencer 1. A Jukebox file (file extension: *.JBX) can be assigned to Sequencer 1, but its name is not shown in this area. The JBX icon appears, together with the name of the currently selected Song in the Jukebox list.

Performance/STS area

This is where the latest selected Performance or STS name is shown.

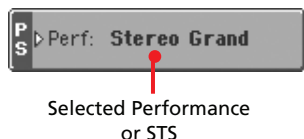

Selected Performance or STS

This is the latest selected Performance (PERF) or Single Touch Setting (STS).

Touch the name to open the Performance Select window (see “Performance Select window” on page 80). As an alternative, use the PERFORMANCE/SOUND SELECT section to select a different Performance.

To select a different STS, use the four SINGLE TOUCH SETTING buttons under the display.

Keyboard tracks area

This is where Keyboard tracks are shown.

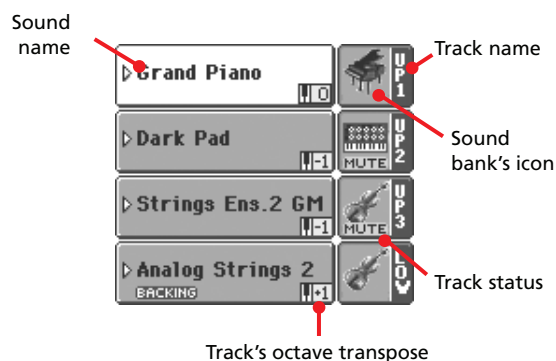

Sound name

▶PERF ▶STS

Name of the Sound assigned to the corresponding Keyboard track.

- If the track is already selected (white background), touch the Sound name to open the Sound Select window.
- If the track is not selected (dark background), first select it, then touch the Sound name to open the Sound Select window.

For more information about the Sound Select window, see “Sound Select window” on page 80.

Keyboard track octave transpose

▶PERF ▶STS

Non editable. Octave transpose of the corresponding track. To individually edit the octave transpose for each track, go to the “Mixer/Tuning: Tuning” edit page (see page 96).

You can also transpose all Upper tracks by using the UPPER OCTAVE buttons on the control panel.

Bass & Lower Backing icon

▶GBLSty

When the Bass & Lower Backing function is active, the Backing icon appears in the Lower track Sound area (see “Bass & Lower Backing” on page 107).

Keyboard track name

Non editable. Name of the corresponding track:

Abbreviation	Track	Hand
UP1	Upper 1	Right hand
UP2	Upper 2	
UP3	Upper 3	
LOW	Lower	Left hand

Sound bank's icon

▶PERF ▶STS

This picture illustrates the bank the current Sound belongs to.

Keyboard track status

▶PERF ▶STS

Play/mute status of the current track. Select the track, then touch this area to change the track status.

No icon Play status. The track can be heard.

MUTE Mute status. The track cannot be heard.

Panels

The lower half of the main page contains the various panels, you can select by touching the corresponding tabs. See more information in the relevant sections, starting from page 89.

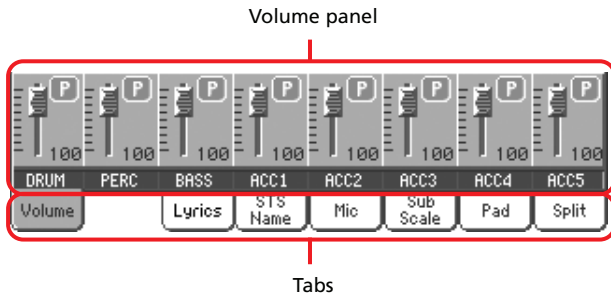

Style Tracks view page

Press the TRACK SELECT button to switch from the Normal view to the Style Tracks view. In this view, individual Style tracks are shown in the lower half of the display, while the upper half of the main page changes, to show parameters for the Style tracks.

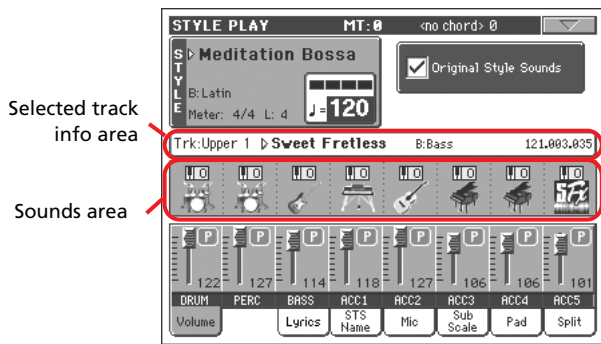

Press TRACK SELECT again to return to the Normal view (Keyboard tracks, grouped Style tracks, Mic/In controls).

Original Style Sounds ▶PERF ▶PERF^{Sty}

This parameter lets you assign different Sounds to the Style tracks, overriding the Sounds recorded into each Style Element pattern. These Sounds can be saved into a Performance or Style Performance with the “Write Performance” or “Write Current Style Performance” commands (see page 108).

Assigned Sounds, with this parameter turned on, are shown in the Sounds area of this page.

Note: When assigning a Sound to a Style track, the “Original Style Sounds” parameter is automatically turned off.

Note: This parameter can be saved with the Performance or Style Performance, and is automatically set to On or Off when you select a different Performance or Style, depending on the saved status.

On Style tracks always use the original Sounds recorded in each Style Element. If you assign a different Sound to a Style track, this parameter is automatically set to Off.

Off You can assign different Sounds to each Style track, and save them in a Performance or Style Performance. The selected Sounds are the same for all Style Elements (there are no different Sounds for each Style element).

Selected Track Info area

This line lets you see the Sound assigned to the selected track. It appears both in the main page, and in several edit pages.

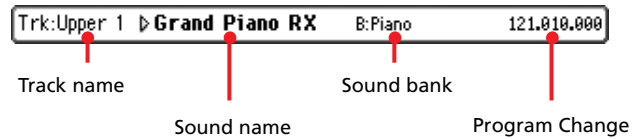

Track name

Name of the selected track.

Sound name ▶PERF ▶PERF^{Sty}

Sound assigned to the selected track. Touch anywhere in this area to open the Sound Select window, and select a different Sound.

Sound bank ▶PERF ▶PERF^{Sty}

Bank of the selected Sound.

Program Change ▶PERF ▶PERF^{Sty}

Program Change number sequence (Bank Select MSB, Bank Select LSB, Program Change).

Sounds area

This area lets you see Sounds and octave transposition for the eight Style tracks.

Style track's octave transpose icon

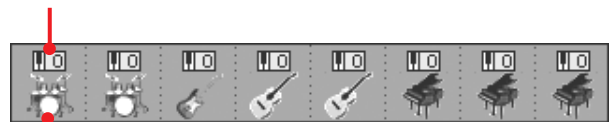

Sound bank's icon

Style track's octave transpose icon ▶PERF ▶PERF^{Sty}

Non editable. Octave transpose of the corresponding track. To change the octave transpose, use the UPPER OCTAVE buttons, or go to the “Mixer/Tuning: Tuning” edit page (see page 96).

Sound bank's icon ▶PERF ▶STS

This picture illustrates the bank the current Sound belongs to. Touch an icon a first time to select the corresponding track (detailed information are shown on the Selected Track Info area, see above). Touch it a second time to open the Sound Select window.

Volume panel

Touch the Volume tab to select this panel. This is where you can set the volume of each track, and mute/unmute tracks.

Use the TRACK SELECT button to switch between the Normal view (Keyboard and grouped Style tracks, Mic/In controls) and the Style Tracks view (separate Style tracks).

The **Normal view** shows grouped Style tracks, Mic/In controls, Keyboard tracks:

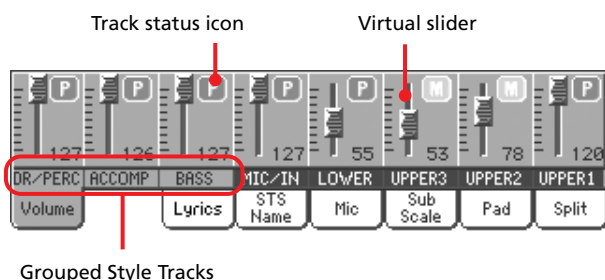

Grouped Style Tracks

Changing the volume of the grouped Style tracks (Dr/Perc, Accomp, Bass) is a global offset. When you choose a different Style, this offset does not change, and the average volume of the Style tracks remains the same.

Changes are not memorized to a Performance or Style Performance. They can be memorized to the Global-Style Play Setup, i.e., the preferences of the Style Play mode (see “Write Global-Style Setup” on page 108).

The **Style Tracks view** shows the separate Style tracks:

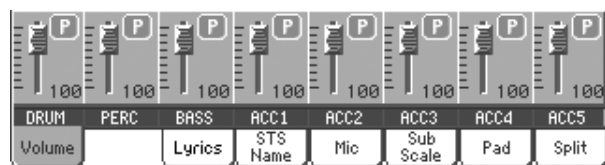

Here you can change the volume of each individual Style track. This mix is saved into each Style Performance and Performance, and can change when choosing a different Style.

Grouped Style tracks

►GBLVpp

These special sliders control several Style tracks at the same time.

Virtual slider (track volume)

►PERF ►PERF^{Sty} ►STS

Virtual sliders are a graphical display of each track’s volume. Touch the track’s area to select a track, and use TEMPO/VALUE controls to change the value (or touch and drag it in the display).

Hint: You can change the volume of all Keyboard or Style tracks at once by using the Assignable Sliders. Select a track of the same type of the tracks whose volume you want to change (e.g., the Upper 1 track to modify all Keyboard tracks). Then keep the SHIFT button pressed, and move one of the Assignable Sliders. See “ASSIGNABLE SLIDER” on page 11.

Track status icons

►PERF ►PERF^{Sty} ►STS

Play/mute status of the current track. Select the track, then touch the track area again to change its status.



Play status. The track can be heard.



Mute status. The track cannot be heard.

Track names

Under the sliders, a label for each track is shown. Use the TRACK SELECT button to switch between the various track views.

Track	Description
Normal View	
DR/PERC ^(a)	Grouped Drum and Percussion tracks.
ACCOMP ^(*)	Grouped Accompaniment tracks.
BASS ^(*)	Bass Style track.
MIC/IN ^(*)	Microphone (Voice Processor). Sources connected to the Audio Inputs, and directly sent to the outputs, are not controlled by this slider.
LOWER	Lower track.
UPPER1...3	Upper tracks.
Style Tracks View	
DRUM	Drum Style track.
PERC	Percussion Style track.
BASS	Bass Style track.
ACC1...5	Accompaniment Style tracks.

(a).Volume for these tracks is a global offset and is not memorized.

Lyrics panel

Lyrics can be associated to a Styles as a “.TXT” file. When in this panel, you can see:

- lyrics contained in a “.TXT” file linked to the latest-selected Style-based SongBook entry (see “Linked .TXT” on page 184).
- lyrics contained in a “.TXT” file loaded after selecting a Style (see “On-the-fly TXT loading” below).

Note: You cannot access Markers or the Score while you are in Style Play mode.

Style Lyrics side tab

This panel shows the lyrics contained in the “.TXT” file:

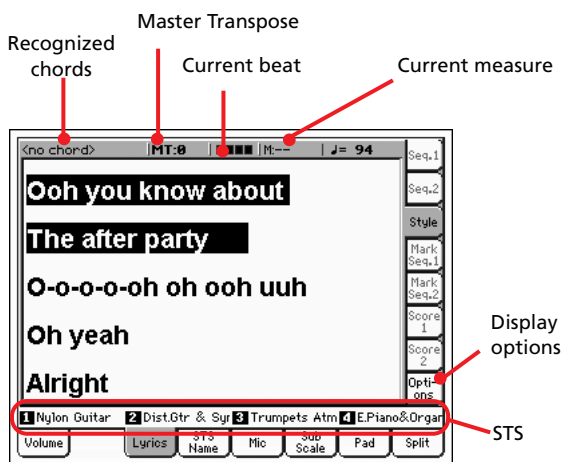

Please note that, unlike ordinary Lyrics, the text will not scroll automatically while the Style is playing back. You must scroll it with the DIAL or the vertical scrollbar. As an alternative, you can use an assignable switch or footswitch, with the Text Page Up or Text Page Down functions assigned, to scroll (respectively) to the previous or next text page.

Recognized chords

Chords recognized on the keyboard.

Master Transpose

Master transpose value in semitones. This value can be changed using the TRANSPOSE buttons on the control panel.

Current beat

Beat number of the current measure, that is currently playing.

Current measure

Current measure number.

STS

Name of the four selected Single Touch Settings (STS). Touch one of them to select it.

Options side tab

Options for the Lyrics page are the same as in Song Play mode. The Options pane preferences are saved into the Song Play Setup, not in the Style Setup. See “Write Global-Song Play Setup” on page 178 for more information.

On-the-fly TXT loading

When a SongBook entry does not contain a link to a “.TXT” file, the “No lyrics. Press SHIFT and touch here to load a TXT file” message appears in the display when you go to the Lyrics page.

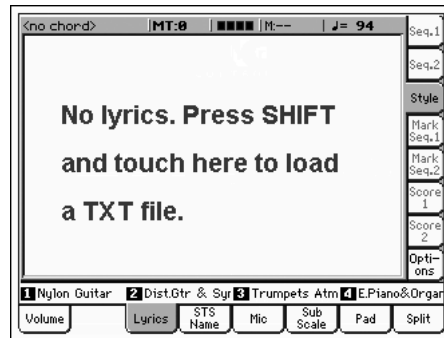

When this message appears, and you want to load a “.TXT” file, keep the SHIFT button pressed and touch the center of the display. A standard file selector appears, and lets you look for a “.TXT” file to be loaded while the current Style is playing.

Hint: When the file selector appears, you can use the Search () function to search a “.TXT” file in the various media. See “Searching files” on page 244 for more information.

STS Name panel

Touch the STS Name tab to select this panel. Single Touch Settings (STS) are memory locations for quickly choosing Keyboard Sounds, contained in each Style or SongBook entry. While in this panel, you can see the name of the four STSs belonging to the latest selected Style or SongBook entry. Touch one of the names to select the corresponding STS.



Note: You cannot edit STS names with this panel. To edit a name, select the STS to be renamed, then select the Write Single Touch Setting command from the page menu (see “Write Single Touch Setting dialog box” on page 109).

Mic panel

Touch the Mic tab to select this panel. This is where you can set the various Voice Processor options.

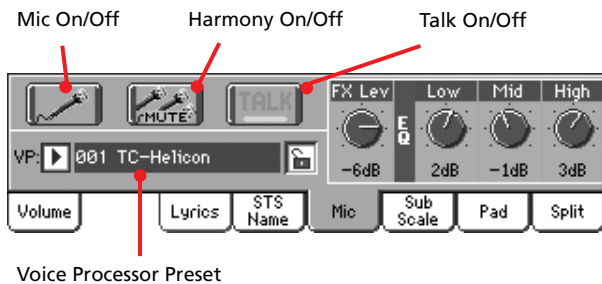

Voice Processor Preset

Mic On/Off

Use this switch to mute/unmute the microphone. This is the same as the MIC/IN Play/Mute icon in the Main page (see “Track status icons” on page 89).

Note: Any line signal entering the Audio Inputs, and not being sent to the Voice Processor, is not affected.

Harmony On/Off

►GBLV^{Pp}

Turns the Harmony module on/off.

Talk On/Off

►GBL^{Tk}

Use this switch to soften all music generated by the Pa800, and speak in the microphone at normal level. This is useful to address your audience, while automatically lowering the background music volume.



While this switch is turned on, all Voice Processor modules are momentarily turned off, except for Reverb, whose level is simply reduced to avoid losing clarity on the voice. Setting for the Talk function can be programmed on the Talk page (see “Voice Processor Setup: Talk” on page 234).



Depress this switch to return to the original settings.

Note: When you deactivate the Talk function, the Voice Processor Preset is recalled. Any unsaved change to the Preset will be lost.

VP Preset

►PERF ►STS

Use this pop-up menu to select one of the available Voice Processor Presets. Selecting a Preset may change all the above parameters, as well as other Voice Processor parameters. Presets can be freely edited (see “Voice Processor Preset: Preset” on page 235).

VP lock icon

►GBL^{Gbl}

This lock avoids changing the Voice Processor Preset when selecting a different Performance, STS or SongBook entry. This is useful if you want to use the same Preset while selecting different Performances, STSs or SongBook entries.

This lock is reset when turning the instrument off, unless you write Global settings to memory (see “Write Global - Global Setup dialog box” on page 231).

For more information on parameter locks, see “General Controls: Lock” on page 218.

FX Level

►GBLV^{Pp}

Use this control to set the overall effect level on the voice. This is the same as the “FX Level knob” found in the Voice Processor Preset > Effects page of the Global mode (see page 239). This parameter is saved in the Voice Processor Preset.

EQ Settings

►GBLV^{Pp}

Use these controls to set a global, three-band equalization applied to the voice. This is useful to fine-tune your voice to the acoustic environment of the room.

This is the same as the EQ controls found in the Voice Processor Setup > Dynamics/EQ page of the Global mode (see page 95).

- | | |
|------|--|
| Low | Low band. Increase it to add body to your voice, decrease it to remove boominess. |
| Mid | Mid band. Increase it to add clarity to your voice, decrease it to remove nasality. |
| High | High band. Increase it to add brilliance to your voice, decrease it to remove sibilance. |

Sub-Scale panel

Touch the Sub-Scale tab to select this panel. This panel replicates the “Mixer/Tuning: Sub Scale” edit page (see page 96).

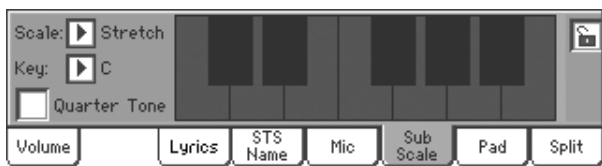

With the “Quarter Tone” box non-checked

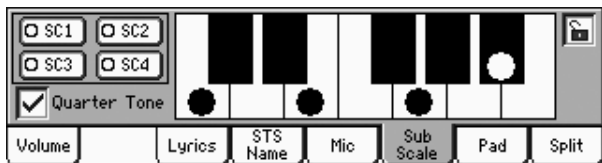

With the “Quarter Tone” box checked

Pad panel

Touch the Pad tab to select this panel. This is where you can assign a different Hit or Sequence Pad to each of the four pads, and see at a glance how pads are programmed. For more options, go to the “Pad/Switch: Pad” page (see page 105).

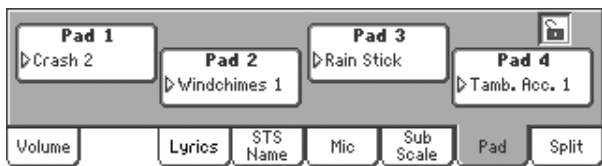

Pad assignment

▶PERF ▶PERF^{Sty} ▶SB 🔒

Name of the Hit or Sequence assigned to each Pad. Touch the box to make the Pad Select window appear (see “Pad Select window” on page 81).

Pads lock icon

▶GBL^{Gbl}

When locked, assignments to the pads remain unchanged when selecting a different Performance, Style or SongBook entry.

This lock is reset when turning the instrument off, unless you write Global settings to memory (see “Write Global - Global Setup dialog box” on page 231).

For more information on parameter locks, see “General Controls: Lock” on page 218.

Split panel

Touch the Split tab to select this panel. This is where you can set the split point and Chord Recognition mode.



Split Point

▶PERF ▶STS 🔒

Use this parameter to select a different split point. A full-range piano keyboard is shown in the display, divided at the selected split point. Upper tracks play on the right of this point, while the Lower track plays on the left.

Keyboard diagram

Touch anywhere on the keyboard diagram. A message will appear, asking you to press the new split point on the keyboard of your Pa800 (or to press the EXIT button to close the message with no changes).

Chord Recognition Mode

▶PERF ▶STS 🔒

This parameter allows you to decide how chords are recognized by the auto-accompaniment engine. Please note that when in Full or Upper Chord Scanning mode, the Fingered 3 mode is always selected, and you must always play at least three notes, to let a chord be recognized.

For more information on the various options, see “Chord Recognition Mode” on page 106.

Note: This parameter is the same you can find in the “Preferences: Style Preferences” page (see page 106).

Split Point and Chord Recognition lock icons

▶GBL^{Gbl}

When locked, Split Point and Chord Recognition mode remain unchanged when selecting a different Performance or STS.

These locks are reset when turning the instrument off, unless you write Global settings to memory (see “Write Global - Global Setup dialog box” on page 231).

For more information on parameter locks, see “General Controls: Lock” on page 218.

Edit menu

From any page, press the MENU button to open the Style Play edit menu. This menu gives access to the various Style Play edit sections.

When in the menu, select an edit section, or press EXIT or STYLE PLAY to exit the menu and return to the main page. To return to the main page, you can also select the Main Page menu item.

When in an edit page, press EXIT or the STYLE PLAY button to return to the main page of the Style Play operating mode.

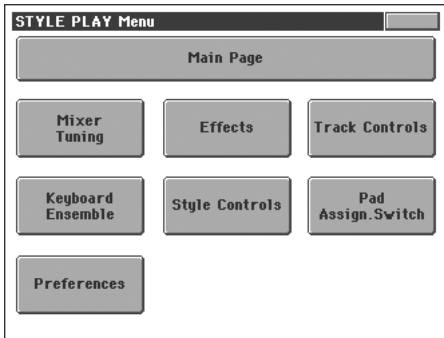

Each item in this menu corresponds to an edit section. Each edit section groups various edit pages, that may be selected by touching the corresponding tab on the lower part of the display.

Edit page structure

All edit pages share some basic elements.

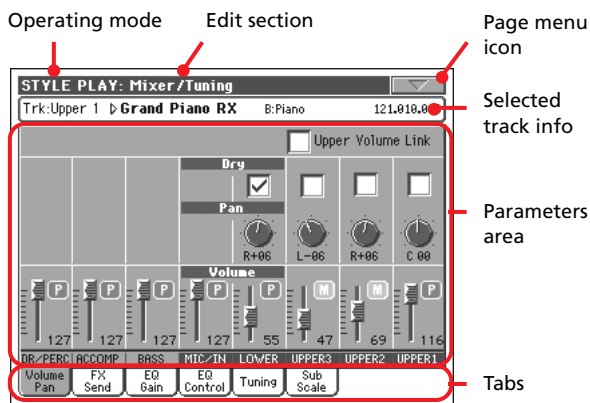

Operating mode

This indicates that the instrument is in Style Play mode.

Edit section

This identifies the current edit section, corresponding to one of the items of the edit menu (see “Edit menu” on page 93).

Page menu icon

Touch this icon to open the page menu (see “Page menu” on page 108).

Parameters area

Each page contains various parameters. Use the tabs to select one of the available pages. For detailed information on the various types of parameters, see sections starting from page 93.

Tabs

Use tabs to select one of the edit pages of the current edit section.

Mixer/Tuning: Volume/Pan

This page lets you set the volume and pan for each of the Keyboard or Style tracks. Volume settings are the same as in the Volume panel of the main page.

Use the TRACK SELECT button to switch from the Keyboard to the Style tracks, and vice versa.

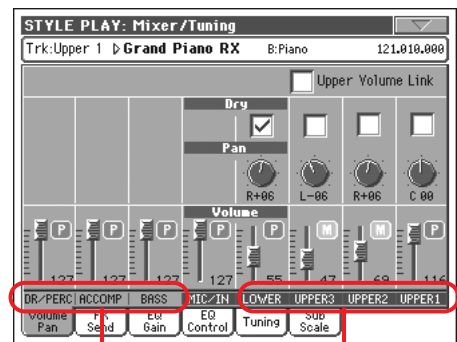

Grouped Style tracks

Keyboard tracks

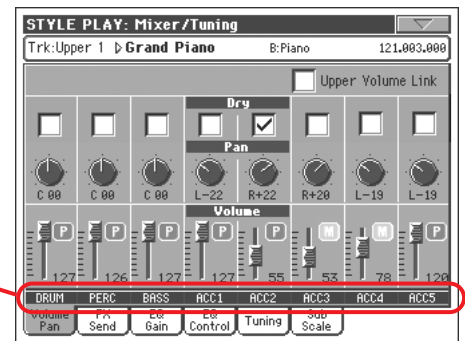

Individual Style tracks

Upper Volume Link

▶GBLSty

This parameter allows you to define if changing the volume for one of the Upper tracks, proportionally changes also the other Upper tracks.

Note: This parameter is the same you can find in the “Preferences: Style Play Setup” page (see page 107).

On When changing volume to one of the Upper tracks, volume for the other Upper tracks changes in proportion.

Off When changing volume to one of the Upper tracks, only that track's volume is changed. Other Upper tracks are left unchanged.

Dry ▶PERF ▶PERF^{Sty} ▶STS

Use this checkbox to turn the dry (direct) track signal on or off.

Note: If the track is sent to a separate output, no FX is sent to any output. To program the output status for each track, see “Audio Setup: Sty/Kbd” on page 227.

On When checked, the direct, dry signal is sent to the output, mixed with the FXs.

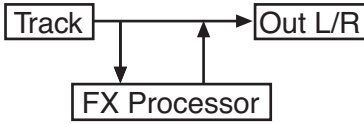

Off When unchecked, the direct, dry signal is removed from the audio output, and only sent to the FXs. The effected signal will still be panned (in stereo FXs only) according to the Pan value.

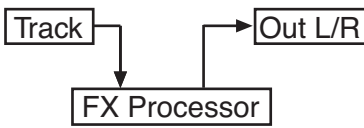

Pan ▶PERF ▶PERF^{Sty} ▶STS

Track position in the stereo field.

L-64...L-1 Left stereo channel.

C0 Center.

R+1...R+63 Right stereo channel.

Volume of grouped Style tracks ▶GBL^{Sty}

This parameter is a general offset applied to all Styles. While the balance between the individual Style tracks can change when choosing a different Style, the average volume, set here, will not change. This is useful to avoid sudden changes in volume when choosing different Styles.

Volume of individual tracks ▶PERF ▶PERF^{Sty} ▶STS

Track’s volume. This is the relative volume of each track, as saved in the Style, Performance or STS. It may change when choosing a different Style, Performance or STS.

0...127 MIDI value of the track’s volume.

Play/Mute icon ▶PERF ▶PERF^{Sty} ▶STS

Track’s play/mute status.

Play status. The track can be heard.

Mute status. The track cannot be heard.

Mixer/Tuning: FX Send

This page lets you set the level of the track’s direct (unaffected) signal going to the Internal FX processors. The effect processors included in Pa800 are connected in parallel, so you can decide which percentage of the direct signal can be effected.

In case you want to send all of a track’s signal to the effect (as when using “insert” effects, like Rotary, Distortion, EQ...), just set the Dry parameter to Off (see “Dry” above).

There are four Internal FX processors in Style Play mode (two for Keyboard tracks, two for Style and Pad tracks). You can assign them any kind of available effects, but we found it convenient to arrange them in the following way, for most of the Styles, STS and Performances included with the Pa800:

- FX A Reverb processor for the Style tracks.
- FX B Modulating FX processor for the Style tracks.
- FX C Reverb processor for the Realtime (Keyboard) tracks.
- FX D Modulating FX processor for the Realtime (Keyboard) tracks.

Use the TRACK SELECT button to switch from Keyboard to Style tracks, and vice-versa.

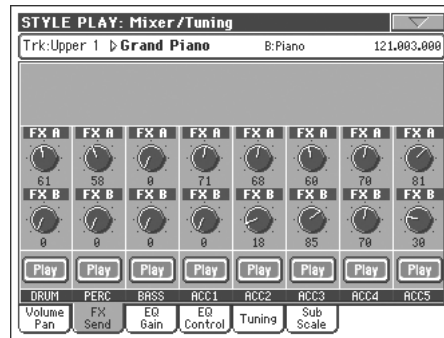
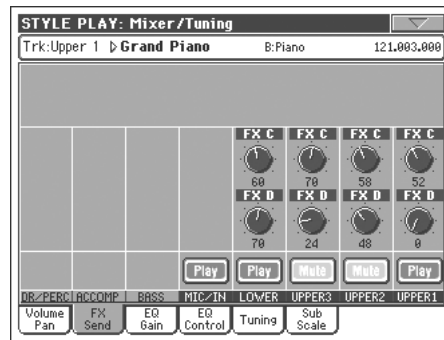

Send level (A...D) ▶PERF ▶PERF^{Sty} ▶STS

0...127 Level of the track (direct) signal sent to the effect processor.

Play/Mute icon ▶PERF ▶PERF^{Sty} ▶STS

Track’s play/mute status.

Play status. The track can be heard.

Mute status. The track cannot be heard.

Mixer/Tuning: EQ Gain

In this page you can set the three-band equalization (EQ) for each individual track.

Use the TRACK SELECT button to switch from the Keyboard to the Style tracks, and vice-versa.

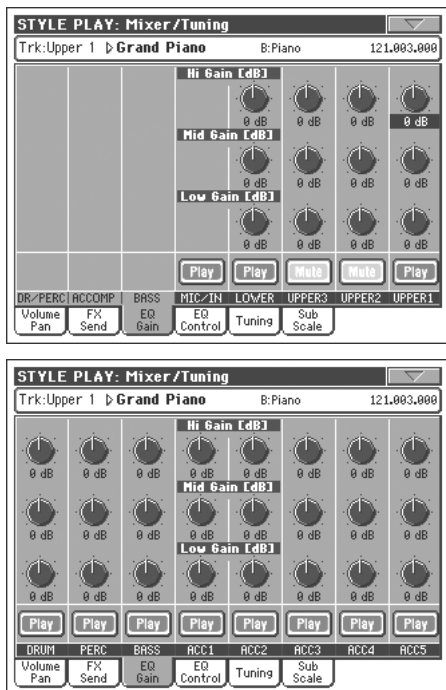

Hi (High) Gain [▶PERF](#) [▶PERF^{Sty}](#) [▶STS](#)

This parameter lets you adjust the high frequencies equalization on each individual track. This is a shelving curve filter. Values are shown in decibels (dB).

Mid (Middle) Gain [▶PERF](#) [▶PERF^{Sty}](#) [▶STS](#)

This parameter lets you adjust the middle frequencies equalization on each individual track. This is a bell curve filter. Values are shown in decibels (dB).

Low Gain [▶PERF](#) [▶PERF^{Sty}](#) [▶STS](#)

This parameter lets you adjust the low frequencies equalization on each individual track. This is a shelving curve filter. Values are shown in decibels (dB).

Play/Mute icon [▶PERF](#) [▶PERF^{Sty}](#) [▶STS](#)

Track's play/mute status.



Play status. The track can be heard.



Mute status. The track cannot be heard.

Mixer/Tuning: EQ Control

This page lets you reset or bypass track equalization, programmed in the previous page.

Use the TRACK SELECT button to switch from the Keyboard to the Style tracks, and vice-versa.

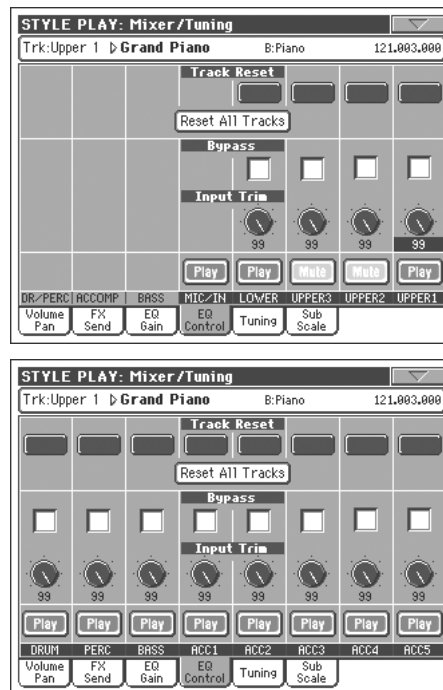

Track Reset buttons

Use these buttons to reset (i.e., “flatten”) equalization for the corresponding track.

Reset All Tracks button

Touch this button to reset (i.e., “flatten”) equalization for all tracks.

Bypass [▶PERF](#) [▶PERF^{Sty}](#) [▶STS](#)

Check any of these checkboxes to bypass equalization for the corresponding track. When bypassed, equalization has no effect on the track, but all parameters are preserved. When the box is unchecked, equalization is activated again with the original settings.

Input Trim [▶PERF](#) [▶PERF^{Sty}](#) [▶STS](#)

This knob allows you to limit the level of the signal passing through the equalizer. Extreme equalization values can overload the audio circuits and lead to distortion. This control lets you set equalization as desired, and at the same time avoid overloading.

Play/Mute icon [▶PERF](#) [▶PERF^{Sty}](#) [▶STS](#)

Track's play/mute status.



Play status. The track can be heard.



Mute status. The track cannot be heard.

Mixer/Tuning: Tuning

This page is where you can set the octave transpose and fine tuning for each track. Plus, you can program the Pitch Bend range for each track.

Use the TRACK SELECT button to switch from the Keyboard to the Style tracks, and vice-versa.

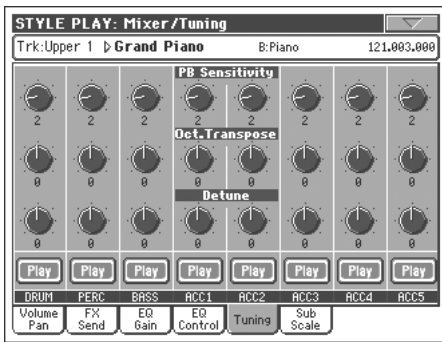
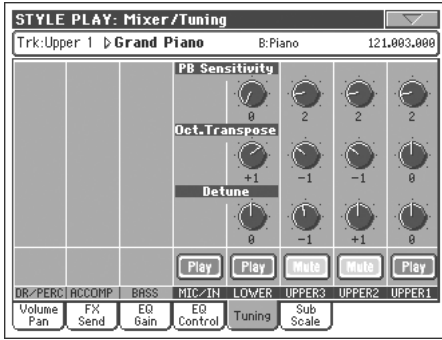

PB Sensitivity ▶PERF ▶PERF^{Sty} ▶STS

These parameters show the Pitch Bend range for each track, in semitones.

- 1...12 Maximum up/down pitch bend range (in semitones). 12 = ±1 octave.
- 0 No pitch bend allowed.

Octave Transpose ▶PERF ▶PERF^{Sty} ▶STS

This is the octave transpose value.

- 3 Lowest octave.
- 0 Standard tuning.
- +3 Highest octave.

Detune ▶PERF ▶PERF^{Sty} ▶STS

This is the fine tuning value.

- 64 Lowest pitch.
- 00 Standard tuning.
- +63 Highest pitch.

Play/Mute icon ▶PERF ▶PERF^{Sty} ▶STS

Track's play/mute status.

- Play status. The track can be heard.
- Mute status. The track cannot be heard.

Mixer/Tuning: Sub Scale

This page lets you program an alternative scale for the tracks selected with the "Scale Mode" parameter (see page 106). The remaining tracks (if any) use the basic scale set in Global mode (see "Main Scale" on page 217).

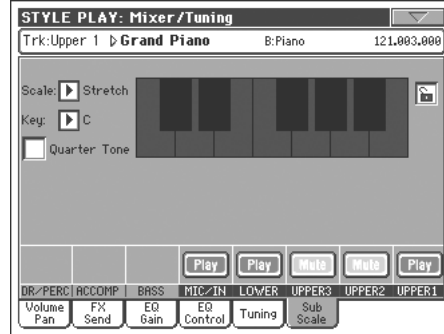

With the "Quarter Tone" box non-checked

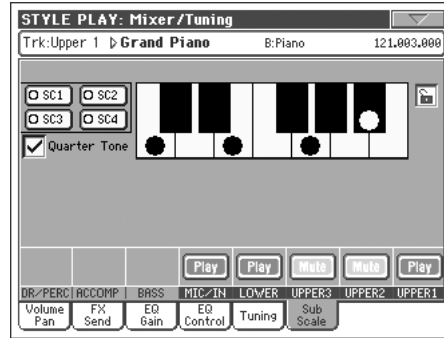

With the "Quarter Tone" box checked

Note: A different Scale can be associated to each Performance or STS.

Note: Quarter Tone selection can be received by MIDI (i.e., by an external sequencer or controller). Conversely, selection of Quarter Tone settings can be sent by the Pa800 to an external MIDI recorder as System Exclusive data.

Scale ▶PERF ▶STS

Selected scale. See "Scales" on page 318 for a list of the available scales. When selecting the User scale, the keyboard diagram on the right becomes active, letting you program a custom scale (see "How to create a custom scale by fine-tuning each note of the User scale" below).

Key ▶PERF ▶STS

This parameter is needed by some scales to set the preferred key (see "Scales" on page 318).

Quarter Tone

Check the Quarter Tone parameter to make the keyboard diagram active, and let the SC Preset buttons appear.

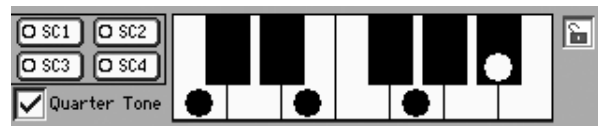

In the display, touch one of the four SC Preset buttons to recall the corresponding preset, and touch any note you want to lower a quarter tone down, making a big dot appear on the detuned note in the diagram. Touch the note again to make the dot disappear.

Scale alteration made in this page is momentary and is not saved to memory. It is only meant to allow for fast scale alteration while playing.

To make realtime changes faster, you can assign the Quarter Tone function also to a footswitch, an EC5 switch or an Assignable Switch (see below “How to use the Quarter Tone function with a footswitch, EC5 switch or Assignable Switch” for more information).

The use of SC Presets allows for immediate recall of previously programmed Quarter Tone scales (see below “How to use the Quarter Tone function with the SC Presets” for more information).

SC Preset buttons

These buttons appear only when the “Quarter Tone” parameter is checked. Use these buttons to recall the corresponding custom scale presets. See “How to use the Quarter Tone function with the SC Presets” below for information on how to use them.

Keyboard diagram

▶PERF ▶STS

When Quarter Tone is checked, or a User scale is selected, this diagram allows you to modify each note’s pitch.

Scale lock icon

▶GBL^{Gbl}

When locked, Scale parameters remain unchanged when selecting a different Performance or STS.

This lock is reset when turning the instrument off, unless you write Global settings to memory (see “Write Global - Global Setup dialog box” on page 231).

For more information on parameter locks, see “General Controls: Lock” on page 218.

How to create a custom scale by fine-tuning each note of the User scale

When the User scale is selected, the keyboard diagram becomes active. You can then change each note tuning in cents of a semitone (within a range of ±99 cents, referred to Equal tuning). This way, you can create a custom scale, you can save to a Performance or STS.

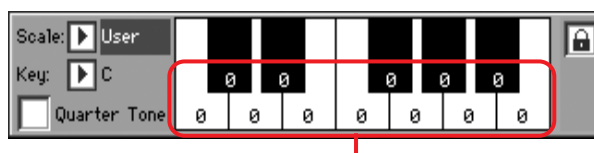

Fine tuning values

After selecting the User scale, touch a note in the keyboard diagram, and use TEMPO/VALUE controls to adjust the selected note tuning in cents.

Note: These settings can be saved to a Performance or STS, as described below.

How to use the Quarter Tone function with the SC Presets

When the Quarter Tone checkbox is checked, four SC Preset buttons appear, and you can select one of four SC Presets to recall a preset custom scale.

1. Program and save a custom scale into an SC Preset.

To do so, go to the Global mode, and reach the “General Controls: Scale” page. When programming is done, choose the “Write SC Preset” command from the page menu, then select one of the preset locations where to save the current settings (see “Write Quarter Tone SC Preset dialog box” on page 232).

2. Return to this page, and check the Quarter Tone checkbox to make SC Preset buttons appear.
3. Touch one of the SC Preset buttons to recall a preset custom scale.

Each preset contains a custom detuning of each note of the scale. It also memorizes the selected degree(s) of the scale (shown in the lower scale diagram).

When no preset is selected, the default scale is automatically recalled. This scale assigns a -50 cent value to all notes, and turns all scale degrees off.

You can select an SC Preset, also by assigning the relevant function to the Assignable Switch or Assignable Footswitch.

4. Use the keyboard diagram to turn the note detuning on or off.

Make a big dot appear to detune the corresponding note, or make it disappear to reset tuning.
5. Reset the original scale.

Uncheck the “Quarter Tone” checkbox to recall the main scale.

How to use the Quarter Tone function with a footswitch, EC5 switch or Assignable Switch

You can assign the “Quarter Tone” function to a footswitch, a Korg EC5 switch, or an Assignable Switch, to program a custom scale in realtime, for example to allow for those sudden scale change typical of Arabic music. These changes are not saved anywhere, so the scale is easily “wiped-out” when selecting a different Performance or STS, or when pressing the Quarter Tone pedal again.

Note: While in Style Play mode, you can create a custom scale, to be assigned to a Performance or STS, simply by selecting and editing a User scale, and saving any change to a Performance or STS. See “How to create a custom scale by fine-tuning each note of the User scale” above.

While in Global mode, you can create a custom scale and save it to one of the four SC Presets, and recall it by touching one of the SC Preset buttons in the display. Then, you can start your realtime scale editing from the selected preset. See “How to use the Quarter Tone function with the SC Presets” above.

1. Program a footswitch, one of the EC5 pedals, or an Assignable Switch, to be the Quarter Tone switch.

Simply go to the Global mode, and reach the “Controllers: Pedal/Switch” or “Controllers: EC5” page. There, you will find the “Pedal/Footswitch” and “EC5-A...E” parameters, to which you can assign the Quarter Tone function.

While still in Global mode, select the Write Global-Global Setup command from the page menu, to save these settings to the Global (see “Write Global - Global Setup dialog box” on page 231).

2. Lower some note pitches.

Keep the Quarter Tone pedal pressed. The keyboard will not play at this time. Press the notes you want to lower a quarter tone. Release the pedal.

3. Play with your new scale.

Notes you pressed on step 2 are now lowered of a quarter tone.

4. Reset the original scale.

Press and release the Quarter Tone pedal again, without playing any note. All pitches will be reset, and the scale selected by the Performance, STS will be recalled.

Effects: FX Select

This page allows you to select the A/B (Style and Pads) and C/D (Keyboard) effects.

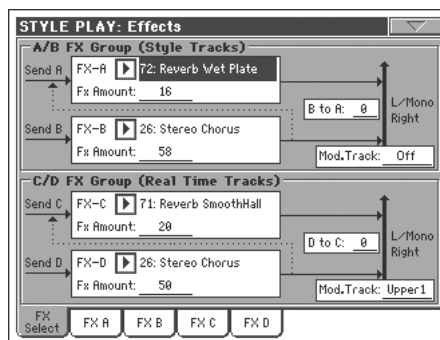

FX A...D

▶PERF ▶PERF^{Sty} ▶STS

Effects assigned to the corresponding effect processors. Usually, A and C are reverbs, while B and D are modulating effects (chorus, flanger, delay...). For a list of the available effects, see the “Advanced Edit” addendum in the Accessory CD.

Effects from A to D can be saved to a Performance. Effect A/B (Style and Pad tracks) can be saved to a Style Performance. Effects C/D (Keyboard tracks) can be saved to an STS.

FX Amount

▶PERF ▶PERF^{Sty} ▶STS

Volume of the effect, that is added to the dry (unaffected) signal.

B to A, D to C

▶PERF ▶PERF^{Sty} ▶STS

Amount of the B effect going back to the input of the A effect, or of the D effect going back to the input of the C effect.

Mod.Track (Modulating Track)

▶PERF ▶PERF^{Sty} ▶STS

Source track for modulating MIDI messages. You can modulate an effect parameter with a MIDI message generated by an internal physical controller.

Effects: FX A...D

These pages contain the editing parameters for the four effect processors. Here is an example of the FX A page, with the Reverb Smooth Hall effect assigned.

Selected effect

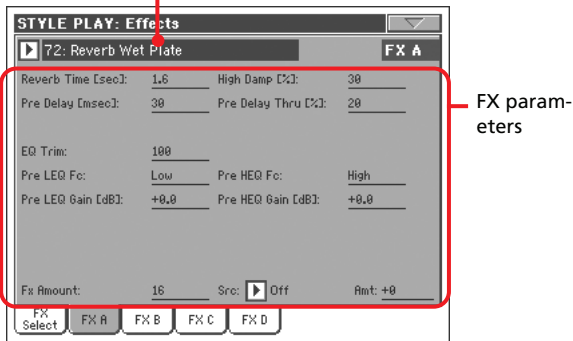

Selected effect

▶PERF ▶PERF^{Sty} ▶STS ▶STS^{SB}

Select one of the available effects from this pop-up menu. This is equivalent to the “FX A...D” parameters found in the “Effects: FX Select” page (see above).

Note: Effects can be different for each of the four editing pages.

FX parameters

▶PERF ▶PERF^{Sty} ▶STS ▶STS^{SB}

Parameters may be different, depending on the selected effect. See the “Advanced Edit” addendum in the Accessory CD for a list of available parameters for each effect type.

FX Amount

▶PERF ▶PERF^{Sty} ▶STS

Volume of the effect, that is added to the dry (unaffected) signal.

Src (Source)

▶PERF ▶PERF^{Sty} ▶STS ▶STS^{SB}

Modulation source. To select the track generating this message, see the “Mod.Track (Modulating Track)” parameters found in the “Effects: FX Select” page (see above). For a list of modulation source, see the “Advanced Edit” addendum in the Accessory CD.

Track Controls: Mode

This page lets you connect each track to the internal sound generator and to external MIDI devices. This is very useful to let a Style track drive an external expander, or play a digital piano with one of Pa800’s Keyboard tracks. In addition, here you can set the polyphony mode for each track.

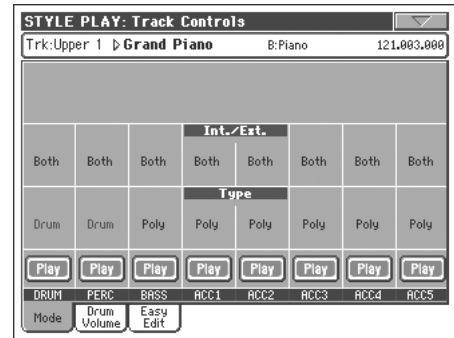
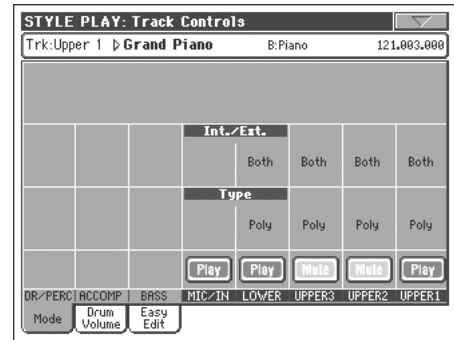

Int./Ext. (Internal/External)

▶PERF ▶PERF^{Sty} ▶STS

Internal The track plays the sounds generated by the internal sound engine. It does not play an external instrument connected to the MIDI OUT.

External The track plays an external instrument connected to the MIDI OUT. The connected device must receive on the MIDI channel associated with this track on the Pa800 (see “MIDI: MIDI Out Channels” on page 225).

A track set to this status does not play the internal sounds, therefore saving polyphony.

Instead of the assigned Sound name, the <E: aaa.bbb.ccc> indicator is shown on a track’s area in the Main page:

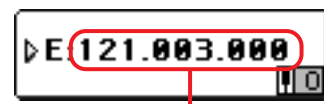

Control Change/Program Change area

This indicator begins with a remark saying the track is in External (“E”) mode, and continues with a strings of transmitted Control Change and Program Change data. This will let you know what the track is transmitting to the MIDI OUT. In the following example, CC#0 is the Control Change 0 (Bank Select MSB), CC#32 is the Con-

Control Change 32 (Bank Select LSB), PC is the Program Change:



When touching the Sound area, the numeric keypad appears, instead of the Sound Select window. You can enter the Control Change/Program Change bundle shown above, separating the three parts with a dot (.).

Both The track plays both the internal sounds and an external instrument connected to the MIDI OUT.

Type [▶PERF](#) [▶PERF^{Sty}](#) [▶STS](#)

Drum Drum/Percussion track. Set a track to Drum mode if you wish to separately adjust the volume and set a different output for each percussive family of the assigned Drum Kit Sound. (See “Track Controls: Drum Volume” on page 100, and “Audio Setup: Sty/Kbd” on page 226).

Note: Tracks set to Drum or Percussion mode while in Style Record (see “Track Type” on page 134), cannot be edited here. This option appears in grey. Other Style tracks cannot be set to Drum mode here.

Poly Tracks of this kind are polyphonic, i.e. they can play more than one note at the same time.

Mono Tracks of this kind are monophonic, i.e. each new note stops the previous note.

Mono Right A Mono track, but with priority assigned to the rightmost (highest) note.

Mono Left A Mono track, but with priority assigned to the leftmost (lowest) note.

Play/Mute icon [▶PERF](#) [▶PERF^{Sty}](#) [▶STS](#)

Track’s play/mute status.

 Play status. The track can be heard.

 Mute status. The track cannot be heard.

Track Controls: Drum Volume

In this page you can adjust the volume for each *family* of Drum and Percussion instrument for the selected track. A list of families is shown below.

These parameters can be accessed only on tracks set in Drum mode (see above). Use them on tracks with a Drum Kit assigned, or you will not be able to hear any change.

Note: All values are referred to the value of the original Sounds.

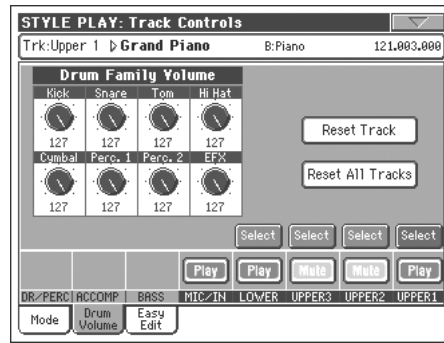

Drum families [▶PERF](#) [▶PERF^{Sty}](#) [▶STS](#)

- Kick** Kick drums volume.
- Snare** Snare drums volume.
- Tom** Toms volume.
- HiHat** Hi-Hat volume.
- Cymbal** Ride, Crash and other cymbals volume.
- Perc.1** Low-pitched percussions volume.
- Perc.2** High-pitched percussions volume.
- EFX** Special effects volume.

Select

Use these buttons to select the track to edit. The button corresponding to the selected track turns green.

Reset Track

Touch this button to reset all changes to percussive instrument volumes in the selected track.

Reset All Tracks

Touch this button to reset all changes to percussive instrument volumes in all tracks.

Play/Mute icon

▶PERF ▶PERF^{Sty} ▶STS

Track's play/mute status.



Play status. The track can be heard.



Mute status. The track cannot be heard.

How to adjust volume for a single Drum Family

Here is a quick example of the use of the Drum Volume function.

1. While in this page, press TRACK SELECT to see individual Style tracks.
2. Touch the Select button, in the display, above the Drum track.
3. Press START/STOP to let the Style go.
4. While listening to the Style, select the Cymb. knob, and use TEMPO/VALUE controls to turn the volume completely off.
You'll notice how all cymbals stops sounding.
5. Touch the Reset Track button in the display to recall the original cymbals volume.

Track Controls: Easy Edit

In this page you can edit the main parameters of the Sounds assigned to each track.

Note: All values refer to the value of the original Sound.



Parameters

▶PERF ▶PERF^{Sty} ▶STS

- Attack** Attack time. This is the time during which the sound goes from zero (at the moment when you strike a key) to it's maximum level.
- Decay** Decay time. Time to go from the final Attack level to the beginning of the Sustain.
- Release** Release time. This is the time during which the sound goes from the sustaining phase, to zero. The Release is triggered by releasing a key.
- Cutoff** Filter cutoff. This sets the sound brightness.
- Resonance** Use the Filter Resonance to boost the cutoff frequency.
- LFO Depth** Intensity of the Vibrato (LFO).
- LFO Speed** Speed of the Vibrato (LFO).
- LFO Delay** Delay time before the Vibrato (LFO) begins, after the sound starts.

Select

Use these buttons to select the track to edit. The button corresponding to the selected track turns green.

Reset Track

Touch this button to reset all changes to Sound parameters in the selected track.

Reset All Tracks

Touch this button to reset all changes to Sound parameters in all tracks.

Play/Mute icon

▶PERF ▶PERF^{Sty} ▶STS

Track's play/mute status.



Play status. The track can be heard.



Mute status. The track cannot be heard.

How to adjust sound parameters for a single Sound

Here is a quick example of the use of the Easy Sound Edit function.

1. If needed, while in this page press TRACK SELECT to see Keyboard tracks.
2. Touch the Select button, in the display, above the Upper 1 track.
3. While playing on the keyboard to hear the Sound, select the Cutoff knob, and use TEMPO/VALUE controls to turn its value completely off.
You'll notice how the filter progressively cuts out high frequencies, making the sound darker and mellower.
4. Touch the Reset Track button in the display to recall the original Cutoff value.

Keyboard/Ensemble: Keyboard Control

This page lets you enable/disable the Damper and Expression pedals, plus the Joystick, for each of the Keyboard tracks.



Damper

▶PERF ▶STS

On When you press the Damper pedal and release the keys, the track's sound is kept sustained.

Off The Damper pedal is not active on any track set to this status.

Joystick X

▶PERF ▶STS

This enables/disables the left/right movement of the Joystick (Pitch Bend, and sometimes a Sound parameter's control; for Pitch Bend settings, see "Mixer/Tuning: Tuning" on page 96).

Joystick Y

▶PERF ▶STS

This enables/disables the front/rear movement of the Joystick (Y+: Modulation, and sometimes a different Sound parameter's control; Y-: Various controls, or non-active).

Expression

▶PERF ▶STS

This parameter allows you to switch the Expression control on/off on each individual Keyboard track. The Expression control is a relative level control, always subtracted from the Volume value of the track.

As an example, imagine you have a Piano sound assigned to Upper 1, and a Strings sound assigned to Upper 2. If you turn the Expression switch on on Upper 2, and off on Upper 1, you can use a continuous pedal to control only the Strings' volume, while the Piano remains unchanged.

To program a pedal or Assignable Slider to act as an Expression control, see "Controllers: Pedal/Switch" on page 222 or "Controllers: Assignable Sliders" on page 222. You can only assign this function to a volume-type pedal, not to a switch-type one. Assign the "KB Expression" option to the pedal or Assignable Slider, then select Write Global-Global Setup from the page menu to save the setting to the Global.

Play/Mute icon

▶PERF ▶STS

Track's play/mute status.



Play status. The track can be heard.



Mute status. The track cannot be heard.

Keyboard/Ensemble: Key/Velocity Range

This page lets you program a key and dynamic (velocity) range for each of the Keyboard tracks.

Key range is useful to create a set of Keyboard tracks playing in different zones of the keyboard. For example, you may have french horns and woodwinds playing in the center range of the keyboard, while only woodwinds play on the higher range.

Velocity range is useful to create a sound made of up to three dynamic layers, assigning each of the Upper tracks to a different dynamic range.

As an example, you may assign the El.Piano 1 Program to the Upper 1, and the El.Piano 2 Program to the Upper 2 track. Then, set Upper 1 to [Bottom=0, Top=80], and Upper 2 to [Bottom=81, Top=127]. The El.Piano 1 will play when playing softer, the El.Piano 2 when playing louder.

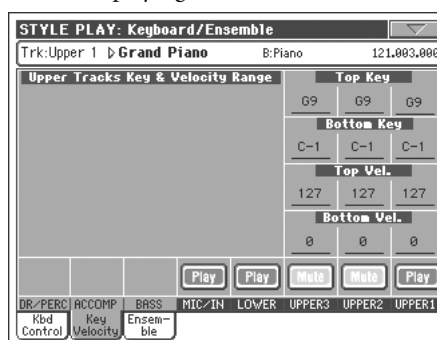

Top/Bottom Key (Key Range)

▶PERF ▶STS

This parameter pair sets the Top and Bottom key range for the track.

C-1...G9 Selected key.

Top/Bottom Vel. (Velocity Range)

▶PERF ▶STS

This parameter pair sets the Top and Bottom dynamic range for the track.

0 Lowest velocity value.

127 Highest velocity value.

Play/Mute icon

▶PERF ▶STS

Track's play/mute status.



Play status. The track can be heard.



Mute status. The track cannot be heard.

Keyboard/Ensemble: Ensemble

This page lets you program the Ensemble function. This function harmonizes the right-hand melody (played in realtime) using the recognized chords of the left-hand.

Note: The Ensemble function only works in Style Play mode, with the Split Keyboard Mode.

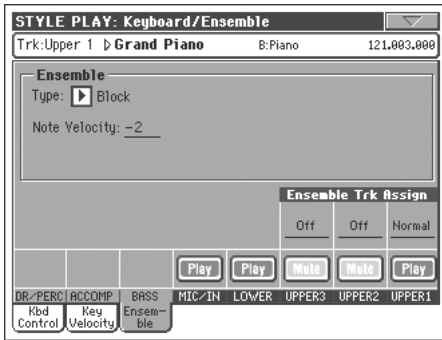

Ensemble

▶PERF ▶STS

Harmonization type.

- Duet Adds a single note to the melody.
- Close Adds a closed-position chord to the melody.
- Open 1 Adds an open-position chord to the melody.
- Open 2 As the above, but with a different algorithm.
- Block Block harmonization – very typical of jazz music.
- Power Ensemble Adds a fifth and an octave to the melody, as heard in hard rock.
- Fourths LO Typical of jazz, this option adds two perfect fourths under the melody.
- Fourths UP As the above, but with notes added over the melody.
- Fifths This adds a series of fifths below the original note.
- Octave Adds one or more octaves to the melody.
- Dual This option adds to the melody line a second note, at a fixed interval set with the “Note” parameter. When selecting this option, a transposition value appears (-24...+24 semitones to the original note).
- Brass Typical Brass section harmonization.
- Reed Typical Reed section harmonization.
- Trill When two notes are played on the keyboard, this option trills them. If three or more notes are played, only the last two are trilled. You can set the trill speed by using the Tempo parameter (see below).

- Repeat The played note is repeated in sync with the Tempo parameter (see below). When playing a chord, only the last note is repeated.
- Echo As the Repeat option, but with the repeated notes fading away after the time set with the Feedback parameter (see below).
- AutoSplit1 If more than a single Upper track is in play, the Upper 1 track plays the melody in mono, while the other Upper tracks play the chord notes. If only the Upper 1 track is in play, it plays polyphonically all the chord notes.
- AutoSplit2 Similar to AutoSplit1, but the Upper 1 track always plays the uppermost note.

Note Velocity

▶PERF ▶STS

This parameter sets the velocity difference between the right-hand melody and the added harmonization notes.

-10...0 Subtracted velocity value.

Tempo

▶PERF ▶STS

Note: This parameter only appears when the Trill, Repeat or Echo options are selected.

Note value for the Trill, Repeat or Echo Ensemble options. This is in sync with the Metronome Tempo.

Feedback

▶PERF ▶STS

Note: This parameter only appears when the Echo option is selected.

This parameter sets how many times the original note/chord is repeated by the Echo option.

Ensemble Track Assign

▶PERF ▶STS

Use these parameters to separately set Upper tracks for the Ensemble function.

- Off There is no harmonization on this track.
- Normal This track is included in the harmonization.
- Mute This track only plays the Ensemble notes, but not the original note.

Play/Mute icon

▶PERF ▶STS

Track's play/mute status.

 Play status. The track can be heard.

 Mute status. The track cannot be heard.

Style Controls: Drum/Fill

In this page you can select various general parameters for the Style.

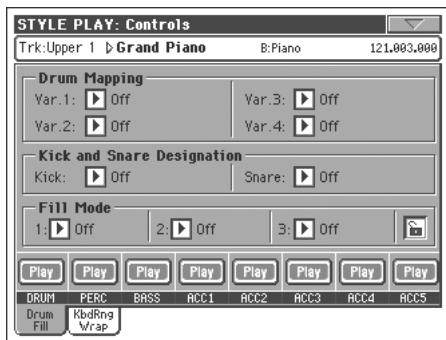

Drum Mapping (Var.1...Var.4) ▶PERF ▶PERF^{Sty}

The Drum Mapping lets you select an alternative arrangement of percussive instruments for the selected Drum Kit, without any additional programming. Just select a Drum Map, and some percussive instruments will be replaced with different instruments.

Off Standard mapping.

Drum Mapping 1...7

Drum Map number. Mapping 1 is “soft-sounding”, while mapping 7 is “loud-sounding”.

Kick and Snare Designation ▶PERF ▶PERF^{Sty}

The Kick Designation replaces the original Kick (Bass Drum) sound with a different Kick of the same Drum Kit, while the Snare Designation replaces the original Snare Drum sound with a different Snare of the same Drum Kit.

Hint: Select different Designations while listening to the Style, and see how they affect the Style. When you like the result, save your setting to a Performance or Style Performance.

Off Original Kick or Snare.

Type 1...3 Kick or Snare replacing the original one.

Fill Mode (1...3) ▶PERF ▶PERF^{Sty} 🔒

These parameters set a Variation to be automatically selected at the end of each of the three available Fills (1...3).

Off The same Variation, playing before selecting a Fill, will be selected again.

V1&V2 ... V3&V4

The specified Variations will be alternatively selected, when one of them is selected. For example, with the “V1&V2” option, if Variation 1 is selected, Variation 1 and Variation 2 will be alternatively selected after the end of the Fill.

Var.Up/Var.Down

The next higher/lower numbered Variation is selected, in cycle. After Variation 4, an Up command will select Variation 1. After Variation 1, a Down command will select Variation 4.

Var.Inc/Var.Dec

The next higher/lower numbered Variation is selected. When Variation 4 is reached, an Inc command will select Variation 4 again. When Variation 1 is reached, a Dec command will select Variation 1 again.

To Var.1...To Var.4

“Fill to Variation” (->1, ->2, ->3, ->4) automatically selects one of the four available Style Variations at the end of the fill.

Fill Mode lock icon ▶GBL^{Gbl}

This lock prevents the Fill Mode being changed when selecting a different Performance or Style.

This lock is reset when turning the instrument off, unless you write Global settings to memory (see “Write Global - Global Setup dialog box” on page 231).

For more information on parameter locks, see “General Controls: Lock” on page 218.

Track status ▶PERF ▶PERF^{Sty}

Track play/mute status. Touch these icons to change it.



Play status. The track can be heard.



Mute status. The track cannot be heard.

Style Controls: Keyboard Range On/Off / Wrap Around

In this page you can program the Wrap Around point, and turn on/off the Keyboard Range included in each Style tracks.



Keyboard Range On/Off ▶PERF ▶PERF^{Sty}

This parameter is an on/off switch for the Key Range parameter memorized into each Style Element track.

On The Keyboard Range is considered – provided it has been programmed (see “Style Element Track Controls: Keyboard Range” on page 132 in Style Record mode). When a track goes over the lower or higher Keyboard Range point, it is automatically transposed, to stay in the programmed range.

Off No Keyboard Range used.

Wrap Around

▶PERF ▶PERF^{Sty}

The wrap-around point is the highest register limit for the backing track. The accompaniment patterns will be transposed according to the detected chord. If the chord is too high, the Style tracks might play in a register that is too high, and therefore unnatural. If, however, it reaches the wrap-around point, it will be automatically transposed an octave lower.

The wrap-around point can be individually set for each track in semitone steps up to a maximum of 12 semitones, relative to the chord root set in Style Record mode (see “Key/Chord” on page 115).

It is advisable to set different Wrap Around points for each track, to avoid all tracks “jump” to a different octave at the same time.

1...12 Maximum transposition (in semitones) of the track, referred to the original key of the Style pattern.

Play/Mute icon

▶PERF ▶PERF^{Sty}

Track’s play/mute status.



Play status. The track can be heard.



Mute status. The track cannot be heard.

Pad/Switch: Pad

This page lets you select a different sound for each of the four PAD buttons.

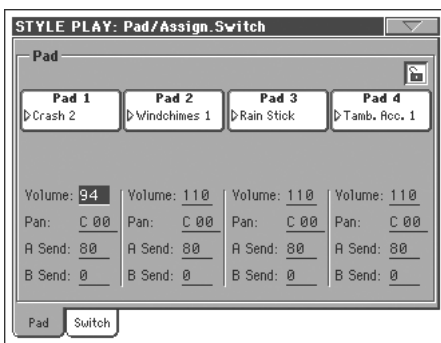

Note: You can also assign different Sounds from the Pad panel of the main page.

Pad assignment

▶PERF ▶PERF^{Sty} ▶SB

Name of the Hit or Sequence assigned to each Pad. Touch the box to make the Pad Select window appear (see “Pad Select window” on page 81).

Volume

▶PERF ▶PERF^{Sty} ▶SB

Volume for each of the four Pad tracks.

Pan

▶PERF ▶PERF^{Sty} ▶SB

Pan for each of the four Pad tracks.

-64...-1 Left stereo channel.
0 Center.
+1...+63 Right stereo channel.

A Send

▶PERF ▶PERF^{Sty} ▶SB

Send level to the A Internal FX processor (usually reverb) for each of the four Pad tracks.

B Send

▶PERF ▶PERF^{Sty} ▶SB

Send level to the B Internal FX processor (usually modulating effect) for each of the four Pad tracks.

Pad lock icon

▶GBL^{Gbl}

This lock avoids selecting a different Performance or STS changes also the Hit or Sequence Pads assigned to the Pads.

This lock is reset when turning the instrument off, unless you write Global settings to memory (see “Write Global - Global Setup dialog box” on page 231).

For more information on parameter locks, see “General Controls: Lock” on page 218.

Pad/Switch: Assignable Switch

This page lets you select a different function for each of the two ASSIGNABLE SWITCH buttons, located near the joystick.

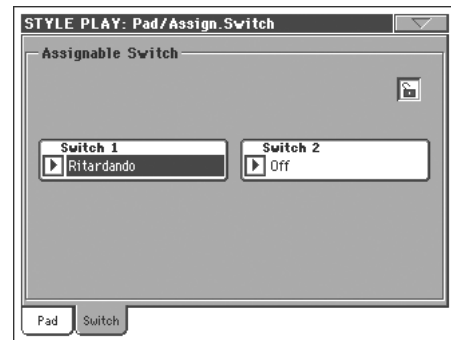

Switch 1 / 2

▶PERF ▶STS

Each of the ASSIGNABLE SWITCH buttons. Use these pop-up menus to assign a function to each switch. See “List of Assignable Switch functions” on page 317.

Assignable Switch lock icon

▶GBL^{Gbl}

This lock avoids selecting a different Performance or STS changes also the functions assigned to the switches.

This lock is reset when turning the instrument off, unless you write Global settings to memory (see “Write Global - Global Setup dialog box” on page 231).

For more information on parameter locks, see “General Controls: Lock” on page 218.

Preferences: Style Preferences

In this page you can set various general parameters for the Style play mode. Settings can be saved to a Performance, or STS.

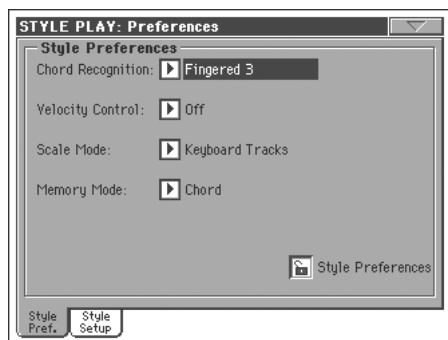

Chord Recognition Mode ▶PERF ▶STS

This parameter defines how chords are recognized by the auto-accompaniment engine. Please note that when in Full or Upper Chord Scanning mode, the Fingered 3 mode is always selected, and you must always play at least three notes, to let a chord be recognized.

Note: This parameter is the same you can find in the main page (see “Split panel” on page 92).

- Fingered 1** Play one or more notes, according to the selected Chord Scanning Mode. A full Major chord will be recognized even if only a single note is played.
- Fingered 2** You must always play two or more notes for a chord to be recognized. If you play just one note, a unison will be played. If you play a suspended chord (a root+5th), a suspended chord will be played. The full chord will be recognized when you play three or more notes.
- Fingered 3** You must always play three or more notes for a chord to be recognized. This option is automatically selected when selecting the FULL Chord Scanning mode.
- One Finger** You can also compose a chord using a simplified chord playing technique:
 - If you play only one note, a Major chord is recognized.
 - Play the root note, plus a white key on the left, for a 7th. For example, play C3 + B2 for a C7.
 - Play the root note, plus a black key on the left, for a Minor chord. For example, play C3 + Bb2 for a C minor.
 - Play the root note, plus a white and a black key on the left, for a Minor 7th. For example, play C3 + B2 + Bb2 for a C min 7.
- Expert** This mode is an extension of the Fingered 2, adding rootless and slashed chord recognition, often used in jazz, fusion, modern pop and light music.

This type of chord recognition is very useful to play piano chords typical of jazz piano players. You don't need to play the root note, doubling the note already played by the bass track.

Velocity Control ▶PERF ▶STS

Set this parameter to trigger one of the following functions simply by playing louder with your left hand. When playing with a velocity value higher than the value set by the “Velocity Control Value” parameter (see page 107), the selected function will be activated.

- This function only works in SPLIT Keyboard Mode, with the LOWER or no Chord Scanning mode selected.
- It does not work in FULL Chord Scanning mode, or in SPLIT Keyboard Mode, with the UPPER Chord Scanning mode selected.

- Off** The function is turned off.
- Break, Fill In 1, Fill In 2** When playing with a velocity higher than the trigger value on the Lower track, the selected element is automatically triggered.
- Start/Stop** You can start or stop the Style by playing harder on the keyboard.
- Bass Inversion** When playing with a velocity higher than the trigger value, the Bass Inversion function will be activated or deactivated.
- Memory** When playing with a velocity higher than the trigger value, the Memory function will be activated or deactivated.

Scale Mode ▶PERF ▶STS

This parameter defines which tracks are affected by the selected alternative scale (see “Scale” on page 96).

- Keyboard tracks** The scale will only affect Keyboard tracks.
- Upper tracks** The scale will only affect Upper 1-3 Keyboard tracks.
- All Tracks** The scale will affect all tracks (Keyboard, Style, Pads).

Memory Mode ▶PERF ▶STS

This parameter sets the way the MEMORY button works.

- Chord** When its LED is on, the MEMORY button keeps the recognized chord in memory. When its LED is off, the chord is reset when raising the hand from the keyboard.
- Chord + Lower** When its LED is on, the MEMORY button keeps the recognized chord in memory, and keeps the Lower track held until the next note or chord is played. When its LED is off, the chord is reset when raising the hand from the keyboard, and the Lower track is not sustained.
- Fixed Arr. + Lower** When its LED is on, the MEMORY button keeps the Lower track held until the next note or chord is played. When off, the Lower track is not sustained when raising the hand from the keyboard. The chord is always kept in memory.

Lock icon

▶GBL^{GBL}

All parameters in this page may be protected from selecting a different Performance or STS.

This lock is reset when turning the instrument off, unless you write Global settings to memory (see “Write Global - Global Setup dialog box” on page 231).

For more information on parameter locks, see “General Controls: Lock” on page 218.

Preferences: Style Play Setup

In this page you can set various general parameters for the Style Play mode.

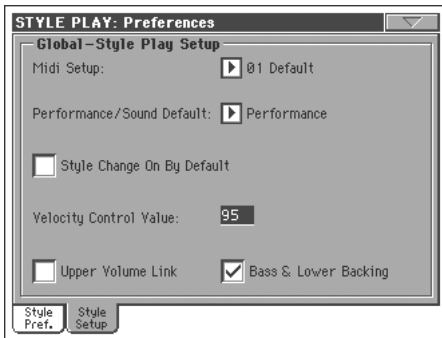

Note: These settings are stored in the Style Play Setup area of the Global file (together with all the other parameters marked with the ▶GBL^{Sty} abbreviation through the manual). After changing these settings, select the Write Global-Style Play Setup command from the page menu to save them to the Global.

Midi Setup

▶GBL^{Sty}

MIDI channels for the Style Play mode can be automatically configured by selecting a MIDI Setup with this parameter. See “MIDI” on page 263 for more information on using MIDI Setups.

Note: To automatically select a MIDI Setup when entering the Style Play mode, select the Write Global-Style Setup command from the page menu.

For detailed information on MIDI Setup settings, see “MIDI Setup” on page 314.

Note: After selecting a MIDI Setup, you can go to the Global mode and apply any change to each channel setting. To store these changes to a MIDI Setup, while still in Global mode select the Write Global-Midi Setup command from the page menu. All MIDI Setup can be freely customized and overwritten.

Hint: To restore the original MIDI Setups, load the original Factory data again (from the Accessory CD, or downloadable from www.korgpa.com).

Performance/Sound Default

▶GBL^{Sty}

Performance banks and Sound banks share the same buttons on the control panel. Use this parameter to define whether the PERFORMANCE SELECT or the SOUND SELECT LED must be on when you turn the instrument on.

Style Change On By Default

▶GBL^{Sty}

This parameter allows you to define the status of the STYLE CHANGE button at startup.

- On At startup, the LED of the STYLE CHANGE button will automatically turn on.
- Off At startup, the LED of the STYLE CHANGE button will stay off.

Velocity Control Value

▶GBL^{Sty}

Use this parameter to set a velocity value over which to automatically trigger the Style Start/Stop or select a Style Element (see “Velocity Control” above).

Upper Volume Link

▶GBL^{Sty}

This parameter allows you to define if changing the volume for one of the Upper tracks, proportionally changes also the other Upper tracks.

- On When changing volume to one of the Upper tracks, volume for the other Upper tracks changes in proportion.
- Off When changing volume to one of the Upper tracks, only that track’s volume is changed. Other Upper tracks are left unchanged.

Bass & Lower Backing

▶GBL^{Sty}

With this function, you can play a simple accompaniment with your left hand. For this to work, the SPLIT Keyboard Mode must be selected, and the Style must not be running. By default, this function is turned on.

- On If the Style is not playing, and you play chords with your left hand, the Sound assigned to the Lower track plays chord notes (even if the Lower track is muted), and a Bass sound plays the chord root. When you start the Style, the normal behavior is restored.

When the Bass & Lower Backing function is active, the Backing icon appears in the Lower track Sound’s area.

- Off If the Style is not playing, and the Lower track is muted, no sound can be heard when you play with your left hand. If the Lower track is set to play, you can hear the sound assigned to the Lower track.

Page menu

Touch the page menu icon to open the menu. Touch a command to select it. Touch anywhere in the display to close the menu without selecting a command.



Write Performance

Select this command to open the Write Performance dialog box, and save most of the current control panel settings to a Performance.

See “Write Performance dialog box” on page 109 for more information.

Write Single Touch Setting

Select this command to open the Write Single Touch Setting (STS) dialog box, and save Keyboard track settings to one of the Single Touch Settings (STS) of the current Style.

See “Write Single Touch Setting dialog box” on page 109 for more information.

Write Current Style Performance

Select this command to open the Write Current Style Performance dialog box, and save Style track settings to the Style Performance of the current Style.

See “Write Single Touch Setting dialog box” on page 109 for more information.

Write Global-Style Setup

Select this command to open the Write Global-Style Setup dialog box, and save global settings that are unique to the Style Play mode. These settings are programmed on the “Preferences: Style Play Setup” page (see page 107).

See “Write Global-Style Play Setup dialog box” on page 110 for more information.

Solo Track

Select the track to be soloed, and check this item. You will hear only the selected track, and the ‘Solo’ warning will flash on the page header.

Uncheck this item to exit the Solo function.

The Solo function works in a slightly different way, depending on the selected track:

- **Keyboard track:** The selected Keyboard track is the only track you can hear when playing on the keyboard. All other Keyboard tracks are muted. The status of the Style tracks is unaffected.
- **Style track:** The selected track is the only Style track you can hear. All other Style tracks are muted. The status of the Keyboard tracks is unaffected.
- **Grouped Style tracks:** *The Solo function does not work on these special tracks.*

SHIFT Keep the SHIFT button pressed and touch one of the tracks to solo it. Do the same on a soloed track to deactivate the Solo function.

Copy/Paste FX

You can copy a single, or all four effects, between Styles, Performances, STSs and Songs. To do this, choose the “Copy FX” and “Paste FX” commands from the page menu of the Style Play, Song Play or Sequencer modes.

To copy a single effect:

1. Select the source Song, Performance, Style or STS, then
 - go to the page of the single effect you want to copy (FX A, FX B, FX C, or FX D), *or*
 - go to the Effects > FX Select page, to copy all four effects. This may be useful if you want to copy two or three of the four effects into different Performances, Styles or STSs.
2. Choose the “Copy FX” command from the page menu.
3. Select the target Performance, Style or STS, then go to the page of the single effect you want to paste (FX A, FX B, FX C, or FX D).
4. Choose the “Paste FX” command from the page menu.

To copy all four effects:

1. Select the source Performance, Style or STS, then go to the Effects > FX Select page, to copy all four effects.
2. Choose the “Copy FX” command from the page menu.
3. Select the target Performance, Style or STS, then go to the page of the Effects > FX Select page.
4. Choose the “Paste FX” command from the page menu.

Easy Mode

Easy Mode allows you to use the Style Play and Song Play modes with an easier-to-use user interface. It is recommended to beginners, and to professionals alike that do not want to deal with the extra parameters of the Advanced mode.

At any time, you can manually turn the Easy Mode on/off with the Easy Mode command in the page menu of the Style Play and Song Play modes.

See “The Style Play page in detail” on page 7 for more information.

Write Performance dialog box

Open this window by selecting the Write Performance item from the page menu. Here, you can save all track settings, the selected Style number, various Style settings, and the selected Voice Processor Preset, to a Performance.

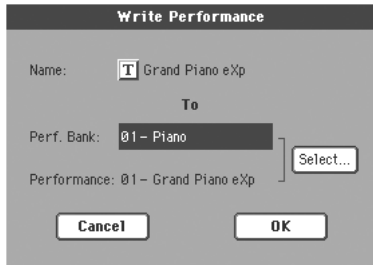

Parameters saved in the Performance are marked with the ▶PERF symbol through the user's manual.

[SHIFT] Keep the SHIFT button pressed and press one of the SOUND/PERFORMANCE buttons to open this window.

Name

Name of the Performance to be saved. Touch the **[T]** (Text Edit) button next to the name to open the Text Edit window.

Perf Bank

Target bank of Performances. Each bank corresponds to one of the PERFORMANCE/SOUND buttons. Use TEMPO/VALUE controls to select a different bank.

Performance

Target Performance location in the selected bank. Use TEMPO/VALUE controls to select a different location.

Select... button

Touch this button to open the Performance Select window, and select a target location.

Write Single Touch Setting dialog box

Open this window by selecting the Write Single Touch Setting item from the page menu. Here, you can save Keyboard track settings, and the selected Voice Processor Preset, to one of the four single Touch Settings (STS) belonging to the current Style.



Parameters saved in the STS are marked with the ▶STS symbol through the user's manual.

[SHIFT] Keep the SHIFT button pressed and press one of the SINGLE TOUCH SETTING buttons to open this window.

Name

Name of the STS to be saved. Touch the **[T]** (Text Edit) button next to the name to open the Text Edit window.

Current Style

Non editable. Settings are saved in one of the four STSs belonging to the current Style. This parameter displays the name of the "parent" Style.

STS

Target STS location. The name of the STS currently saved at the target location is shown. Use TEMPO/VALUE controls to select a different location.

Write Style Performance dialog box

Open this window by selecting the Write Style Performance item from the page menu. Here, you can save Style track settings to the Style Performance of the current Style.

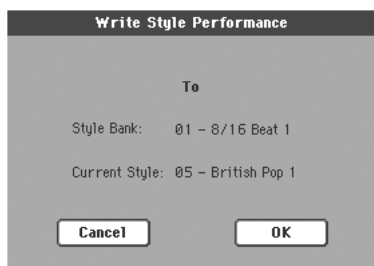

Parameters saved in the Style Performance are marked with the **PERF^{Sty}** symbol through the user's manual.

(SHIFT) Keep the SHIFT button pressed and press one of the STYLE buttons to open this window.

Style Bank

Non editable. Bank of Styles the current Style belongs to. Each bank corresponds to one of the STYLE buttons.

Current Style

Non editable. Name of the current Style.

Write Global-Style Play Setup dialog box

Open this window by selecting the Write Global-Style play Setup item from the page menu. Here, you can save various Style Preference settings (see "Preferences: Style Play Setup" on page 107), that are saved to the Global file.



Parameters saved in the Style Play Setup area of the Global are marked with the **GBL^{Sty}** symbol through the user's manual.

The Favorite banks

You can create a custom set of Styles, made of up to ten Favorite banks. You can assign a different name to these banks, in order to add musical genres not included among the Factory Styles.

When both LEDs of the leftmost STYLE button are lit, the FAVORITE banks are selected. No loading is required. Each bank can include up to 32 Styles; browse them using the PAGE buttons.

The Favorite Styles are contained in ten folders, automatically created by the Pa800 inside the FAVORITE folder in the SSD's root. Even if different names can be shown in the display, these folders have fixed names:

Folder name	FAVORITE bank buttons
FAVORITE01.STY	Bank 1
FAVORITE[02...09].STY	Bank 2...9
FAVORITE10.STY	Bank 10

Hint: New Styles are released from time to time on our website (www.korgpa.com).

Creating the Favorite banks

There are two ways to create the Favorite banks:

- While in Style Record mode, you can write the new or edited Style in the Favorite banks, as an alternative to the User Style banks. See the Style Record chapter for more information on saving a Style.
- While in Media mode, you can load any Style into the Favorite folders, as an alternative to the User Style banks. See the Media chapter for more information on the Load operations.

Renaming the Favorite banks

While the Style Select window is in the display, you can choose the "Rename Favorite Bank" command from the page menu, and assign the Favorite Style banks any name you like (see "Rename Favorite Bank" on page 81.).

The assigned name can be spanned over two lines, by separating them with the paragraph character (¶). For example, to write "World Music" on two lines, enter "World¶Music".

Be careful not to write words exceeding the width of the side tabs of the Style Select window.

Style Record mode

By entering the Style Record mode, you can create your own Styles, or edit an existing Style.

The Style structure

The term “Style” relates with music sequences automatically played by the arranger of the Pa800. A Style consists of a pre-defined number of **Style Elements (E)** (Pa800 features thirteen different Style Elements: Variation 1-4, Intro 1-3, Fill 1-3, Ending 1-3). When playing, these Style Elements can be selected directly from the control panel, using the corresponding buttons.

To explain the Style structure, we can use a tree-structure, as shown in the following diagram:

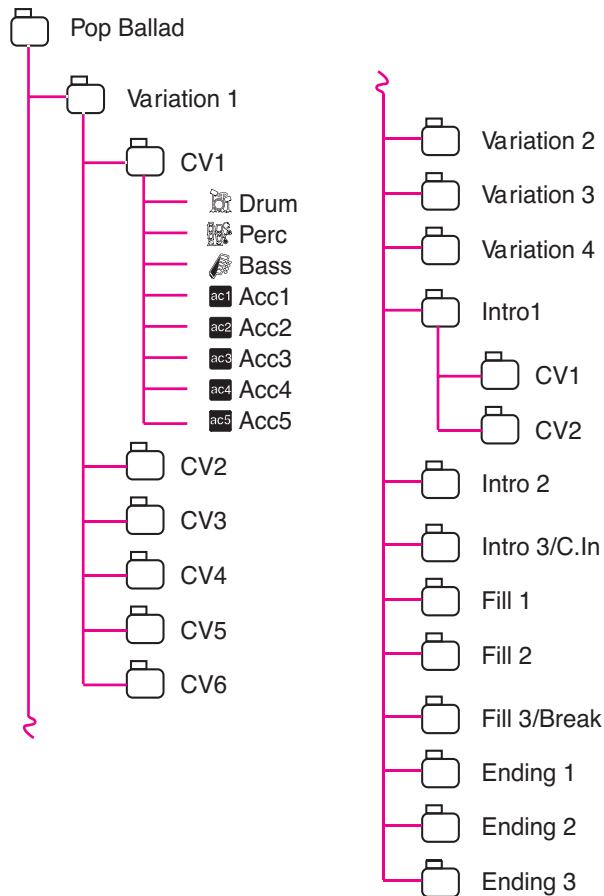

Each Style Element is made up of smaller units, called **Chord Variations (CV)**, but not all of them have the same number of CVs. Variations 1-4 have up to 6 CVs each, while the other Style Elements have only up to 2 CVs.

When you play on the chord recognition area (Lower, Upper or Full, depending on the Chord Scanning section on the control panel), the arranger scans the keyboard and determines which chord you are playing. Then, depending on the selected Style Element, it determines which Chord Variation (CV) should be played for the scanned chord. Which Chord Variation corresponds to each scanned chord is a setting of the Style: the **Chord Variation Table**. Each Style Element contains a Chord Variation Table, whose prototype is the following:

Chord	Chord Variations (CVs)	
	Variation 1-4	Intro 1-3, Fill 1-3, Ending 1-3
Maj	CV1 – CV6	CV1 – CV2
6		
M7		
M7b5		
Sus4		
Sus2		
M7sus4		
min		
m6		
m7		
m7b5		
mM7		
7		
7b5		
7sus4		
dim		
dimM7		
aug		
aug7		
augM7		
no 3rd		
no 3rd, no 5th		
b5		
dim7		

After deciding what CV to play, the arranger triggers the right sequence for each track. Since each sequence is written in a particular key (for example, CMajor, GMajor or Emin), the arranger transposes it according to the scanned chord. Notes in the sequence are carefully transposed, to make them work fine with all recognized chords.

Going deeper into the Style structure, we can see that each Chord Variation is made up of **Track Sequences**, and the Pa500 supports 8 different tracks. DRUM and PERC are used for drum and percussion sequences, BASS for bass and ACC1-5 are for accompaniment sequences (string, guitar, piano or other accompaniment instruments).

Just to summarize, when you play a chord on the chord recognition area, the arranger determines which Style Element is used, then determines which Chord Variation should be used for the played chord, then Style sequences for every track of that Chord Variation are transposed from the original chord to the recognized chord, and so on every time you play a chord.

Ordinary, Guitar and Drum tracks

There are different types of tracks (see “Track Type” on page 134), and each of them is treated in a different way by the arranger;

- **Acc (Accompaniment) and Bass tracks:** When a chord is recognized, the programmed chord notes are transposed to a suitable scale, according to the **Note Transposition Tables (NTT)**. The NTT allows you to record just some Chord Variations, and have all the notes play in the right place, avoiding dissonances and transposing the pattern notes to the notes of the recognized chord.
- **Drum & Perc (Percussion) tracks:** No transposition is applied. The original pattern plays always.
- **Gtr (Guitar) tracks:** When a chord is recognized, the arranger triggers single notes, strumming and arpeggios on a “virtual guitar”, keeping care of the way notes are played on the guitar keyboard.

What to record

Recording a Style is a matter of recording tracks, inside a series of Chord Variations, inside a series of Style Elements, inside the Style itself.

You don't need to record all Chord Variations for all Style Elements. It is often only needed to record just a Chord Variation for each Style Element. Exceptions are the Intro 1 and Ending 1, where we suggest to record both a Major and minor Chord Variations.

Pattern data vs. track data

While the Style Record mode is where you can create or edit music patterns for the Style, track parameters (like Volume, Pan, Octave Transpose, FX settings...) have to be edited in Style Play mode.

- After creating or editing music patterns in Style Record mode, save them by selecting the Write Style command from the page menu of the Style Record mode (see “Write Style dialog box” on page 138).
- After editing track parameters in Style Play mode, save them to the Style Performance by selecting the Write Style Performance command from the page menu of the Style Play mode (see “Write Style Performance dialog box” on page 110).

Sounds

There are two ways of assigning Sounds to the Style tracks.

- While in Style Record mode you can assign different Sounds to each Style Element (see “Sounds area” on page 117).

- While in Style Play mode, you can assign a single Sound to the Style Performance (together with the other track parameters), that remains the same for all Style Elements.

Which Sounds are used depends on the status of the “Original Style Sounds” parameter (see page 88).

Note: When assigning a Sound in Style Play mode, the “Original Style Sounds” is automatically turned off.

Style Import/Export

As an alternative to creating Styles on the Pa500, you can import a Standard MIDI Files (SMF) from your computer to a Pa800's Style. See “Import: Import SMF” on page 135 and “Export SMF” on page 137.

Entering the Style Record mode

While in the Style Play operating mode, press the RECORD button. The following page will appear in the display:



- Select **Record/Edit Current Style** to edit the current Style. If it is a Factory Style, you may not be able to save it at the original location (depending on the status of the “Factory Style and Pad Protect” parameter, see page 257); you will select a User Style instead.

When editing an existing Style, the original Style Performance is recalled, but the following parameters are reset to their default values: Drum Mapping (Off), Kick & Snare Designation (Off). This means that you can hear some differences between the Style in play and the same Style being edited; for example, resetting the Drum Mapping may lead to some instruments being replaced.

- Select **Record New Style** to start from a new, empty Style. A default Style Performance will be recalled. When finished recording, you will save the new Style onto a User Style location. (Styles can be saved onto Factory Style locations only when the “Factory Style and Pad Protect” parameter is set to Off – see page 257).

After editing the Style, please save it (see “Exit by saving or deleting changes” below) and exit the Style Record mode. Then, while in Style Play mode, edit the Style Performance to adjust track settings (Tempo, Volume, Pan, FX Send... see page 93 and following in the “Style Play operating mode” chapter) and save it by selecting the “Write Current Style Performance” from the page menu (see “Write Style Performance dialog box” on page 110).

Note: After a record or edit operation, the memory is automatically reorganized. Therefore, when you press START/STOP there is a delay before you can actually listen to the Style. This delay is higher with a Style containing more MIDI events.

Note: While in Record mode, the footswitch and EC5 pedals are disabled. On the contrary, volume/expression-type pedals can be used.

Exit by saving or deleting changes

When finished editing, you can save your Style in memory, or abort any change.

- To save changes, select the “Write Style” command from the page menu (see “Write Style dialog box” on page 138).
- To abort all changes, select the “Exit from Record” command from the page menu, or press the RECORD button, to exit from record and return to the main page of the Style Record mode.

Hint: Save often while recording, to avoid accidentally losing your changes to the Style.

Listening to the Style while in Edit mode

While you are in Style Record mode, you can listen to the selected Chord Variation or to the whole Style, depending on the page you are in.

To select a Chord Variation, go to the Main page of the Record/Edit mode (see “Element (Style Element)” and “Chord Var (Chord Variation)” on page 114).

- When you are in the Main, Event Edit, Quantize, Transpose, Velocity, or Delete pages, you can listen to the selected Chord Variation. Press START/STOP to check how it works. Press START/STOP again to stop the playback.
- When you are in the Sounds/Expression, Keyboard Range, Chord Table, Trigger/Tension, Delete All, Copy, Style Element Controls or Style Control pages, you can listen to the whole Style. Press START/STOP and play some chords to do your tests. Select any Style Element using the control panel buttons (VARIATION 1-4, INTRO 1-3, FILL 1-3, ENDING 1-3). Press START/STOP again to stop the playback.
- When you are in the Guitar Mode page, you can listen to the pattern you are programming, played in the selected Key.

Note: While in Style mode, the Fingered 3 Chord Recognition mode is automatically selected.

List of recorded events

The Style Record mode filters out some events that may cause wrong operation of the Style. Here are the recorded events, and the most important filtered-out events.

Control function	CC#
Allowed	
Note On	
RX Noise On	
Pitch Bend	
Channel After Touch	
Modulation	1
Breath	2
Pan	10
Expression	11
CC#12	12
CC#13	13
Damper (Hold 1)	64
Filter Resonance (Harmonic Content)	71
Low Pass Filter Cutoff (Brightness)	74
CC#80 (General Purpose #5)	80
CC#81 (General Purpose #6)	81
CC#82 (General Purpose #7)	82

Note: Some Control Change messages cannot be recorded directly by using Pa800 integrated controls.

All allowed controllers can be assigned to an Assignable Pedal/Slider/Switch.

MIDI Control Change messages inserted by using a software on an external computer are imported when using the import function (“Import: Import SMF” on page 135).

Some controllers are reset at the end of the pattern.

Main page - Record 1

After pressing the RECORD button, and having chosen whether you want to edit an existing Style or create a new one, the main page of the Style Record mode appears, with the tab “Record 1” selected.

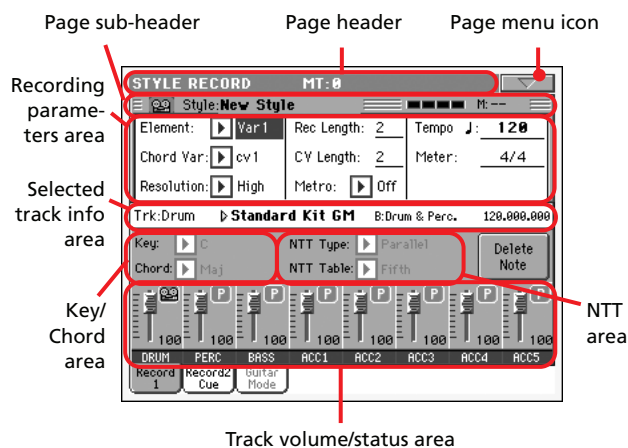

Recording parameters area

Element (Style Element)

This parameter lets you select a Style Element for editing. Each Style Element corresponds to a button on the control panel carrying the same name. After selecting a Style Element, select a Chord Variation for actual editing (see below).

Var1...End3

This is the selected Style Element

Chord Var (Chord Variation)

This parameter lets you select a Chord Variation for editing, after selecting the Style Element this Chord Variation belongs to.

Note: When this parameter and the assigned value is in small letters (cv1...cv6), the Chord Variation is empty; when it is in capitals (CV1...CV6), it is already recorded.

- If Style Element is Var1, Var2, Var 3 or Var4, you can select one of 6 Chord Variations to edit.
- If Style Element is Intro1, Intro2, Intro3, Fill1, Fill2, Fill3, Ending1, Ending2 or Ending3, you can select one of 2 Chord Variations to edit.

Resolution

Use this parameter to set the quantization during recording. Quantization is a way of correcting timing errors; notes played too soon or too later are moved to the nearest axis of a rhythmic “grid”, set with this parameter, thus playing perfectly in time.

Note: To quantize after recording, use the Quantize function in the Edit section (see “Style Edit: Quantize” on page 126).

High No quantization applied.

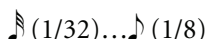

Grid resolution, in musical values. For example, when you select 1/16, all notes are moved to the nearest 1/16 division. When you select 1/8, all notes are moved to the nearest 1/8 division. A ‘3’ after the quantization value means triplet.



Rec Length (Recording Length)

▶STYLE

This parameter sets the recording length (in measures) of the selected track. Its value is always equal to, or a divider of, the Chord Variation Length (see next parameter).

This is not the total length of the Chord Variation, but just of the current track. For example, you may have a Chord Variation eight measures long, with a drum pattern repeating each two measures. If so, set the CV Length parameter to “8”, and the Rec

Page header

This line shows the current operating mode and transposition.

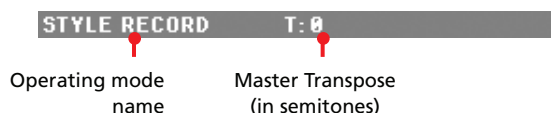

Operating mode name

Name of the current operating mode.

Master transpose

Master transpose value in semitones. This value can be changed using the TRANSPOSE buttons on the control panel.

Page menu icon

Touch this icon to open the page menu. See “Page menu” on page 138.

Page sub-header

This area shows some performing info on the Style.



Style in record/edit

Name of the Style currently in edit or record.

Beat counter

This indicator shows the current beat inside the current measure.

Measure number

Current measure you are recording.

Length parameter to “2” before starting recording the Drum track. When playing back the Style, saving it or executing any edit operation on the Style, the 2-measures pattern will be extended to the full 8-measures length of the Chord Variation.

Warning: If you assign CV Length a value lower than Rec Length, the value of Rec Length is not immediately updated in the display. Therefore, you are still free of changing the value of CV Length, before the measures exceeding its value are deleted (see warning in “CV Length (Chord Variation Length)” below).

However, if you press START/STOP to begin recording, the real Rec Length value is changed to the new one, even if the display still shows the old value.

For example, you may have CV Length = 4 and Rec Length = 4. If you set CV Length to 2, and press START/STOP to begin recording, Rec Length is still shown as 4, but it is in reality set to 2, and recording will cycle for just 2 measures. After you press START/STOP to stop recording, Rec Length is updated to 2, and all measures after the second measure are deleted.

CV Length (Chord Variation Length) ▶STYLE

This parameter sets the total length (up to 32 measures) for the selected Chord Variation. When playing a Style, this will be the length of the accompaniment pattern, when the chord corresponding to the Chord Variation is recognized on the keyboard.

Warning: If you reduce the Chord Variation Length after recording, any measure after the selected length will be deleted. Be very careful when setting the CV Length to a lower value after recording! If it happens, we suggest to exit from record without saving (see “Exit from Record” on page 138).

Metro (Metronome)

This is where you can set the metronome.

Off	No metronome click will be heard during recording. In any case, a one-bar precount will be played before starting recording.
On1	Metronome on, with a one-bar precount before starting recording.
On2	Metronome on, with a two-bar precount before starting recording.

Tempo

Select this parameter to use TEMPO/VALUE controls to set the tempo.

Hint: You can always change the Tempo, when other parameters are selected, by keeping the SHIFT button pressed, and rotating the DIAL.

Note: When recording tempo, old data is always replaced by the new data.

Note: The actual tempo of the Style will be the one shown when saving the Style Performance in Style Play mode (see “Current tempo” on page 86).

Meter ▶STYLE

This is the meter (time signature) of the Style Element. You can edit this parameter only when the Style Element is empty, i.e. before you begin recording anything.

Selected track info area

This line lets you see the Sound assigned to the selected track.

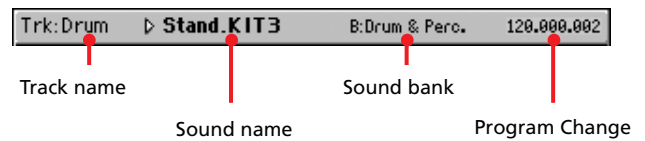

Track name

Name of the selected track.

Drum...Acc5 Style track.

Sound name ▶STYLE

Sound assigned to the selected track. The triangle means you can touch the name to open the Sound Select window, and select a different Sound.

Sound bank

Bank the selected Sound belongs to.

Program Change

Program Change number sequence (Bank Select MSB, Bank Select LSB, Program Change).

Key/Chord area

Key/Chord ▶STYLE

This parameter pair allows you to define the track’s original key and chord type, for the current Chord Variation. When in Style Play mode, this chord will be played back exactly as it was recorded, without any NTT processing (see above).

To record just one Chord Variation for a Style Element, the suggested original key/chord is “maj7” (with NTT = i-Series). Be very careful to play the 7th+ note (i.e., with a “Cmaj7th” key/chord, the B), to avoid the lack of notes, or a bad NTT conversion when playing different chords.

Note: To conform to Korg specifications, it is advisable to record both the “Major” and “minor” Chord Variations for the Intro 1 and Ending 1 Style Elements.

When you select a track, the original key/chord assigned to the selected track will be shown. All recorded tracks will play back on that key/chord. For example, if the original key/chord for the Acc1 track is A7th, when selecting the Acc1 track all the remaining tracks will play on the A7th key/chord.

In the example above, you will record the Acc1 track in the A-Major key, with notes pertaining to the A7th scale. This exact pattern will be recalled, when an A7th chord will be recognized.

Note: This does not apply to Guitar Mode, relying on a different rule. See “Main page - Guitar Mode” on page 118 for more information.

NTT Area

NTT Type/Table

▶STYLE

NTTs (Note Transposition Tables) are the sophisticated algorithms that allow Korg arrangers to convert recognized chords into musical patterns. The Note Transposition Table (NTT) determines how the arranger will transpose pattern notes, when a chord is recognized that does not exactly match the original chord of a Chord Variation. For example, if you only recorded a Chord Variation for the CMaj chord, when a CMaj7 is recognized on the keyboard the arranger must transpose some notes to create the missing 7th.

Note: These parameters cannot be selected with Drum, Percussion or Guitar tracks, and are therefore greyed out.

Note: NTT parameters are separately programmed for each track of the Style Element.

There are two general types of NTTs:

- When **Parallel** types are selected, notes are transposed inside the area set by the Wrap Around parameter. These tables are ideally suited to melody parts.

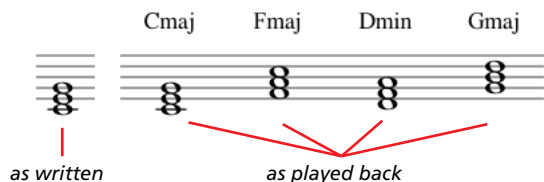

- When **Fixed** types are selected, the arranger moves as few notes as possible, making legato lines and chord changes more natural. They are ideally suited to chord tracks (strings, piano etc...).

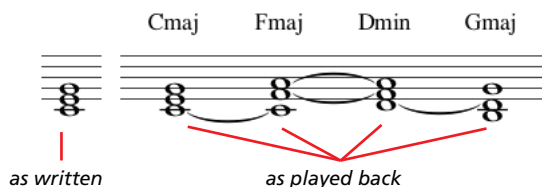

Note: To conform to Korg specifications, it is advisable to set the NTT to “No Transpose” on the Intro 1 and Ending 1.

Parallel/Root The root note (in CMaj = C) is transposed to the missing notes.

Parallel/Fifth The 5th note (in CMaj = G) is transposed to the missing notes.

As recorded with
NTT = Root or 5th
(Key/Chord = CMaj)



When you play a CM7
with NTT = Root



When you play a CM7
with NTT = 5th



Parallel/i-Series

All original patterns must be programmed on the “Maj7” or “min7” chords. When loading old Korg i-Series Styles, this option is automatically selected.

As recorded with
NTT = i-Series
(Key/Chord = CM7)



When you play a CMaj
with NTT = i-Series



When you play a C7
with NTT = i-Series



Parallel/No Transpose

The chord is not modified, and is moved to the new key unchanged. The pattern plays exactly the recorded notes, and is moved to the new key as is. This is the standard setting of Intro 1 and Ending 1 in Korg’s original Styles (where a chord progression is usually recorded, and should remain unchanged in any key).

Fixed/Chord

This table moves as few notes as possible, making legato lines and chord changes more natural. It is ideally suited to chord tracks (strings, piano etc...). Contrary to the Parallel mode, the programmed chord is not transposed according to the Wrap Around parameter, but always stays around its original position, looking for common notes between the chords.

Fixed/No Transpose

The programmed notes can only be transposed by the Master Transpose. They are never transposed when chords are changed.

Delete Note button

Use this command to delete a single note or a single percussive instrument from a track. For example, to delete a snare, keep the D2 note (corresponding to the snare) pressed.

1. Select a track.
2. Touch the “Delete Note” button, and keep it pressed.
3. Press START/STOP to start the Style.
4. When you reach the passage containing the note to be deleted, play the note on the keyboard. Keep it pressed, up to the last note to be deleted.
5. When finished, release the Delete button and the note to be deleted, and press START/STOP again to stop the Style.

Note: If the note is at the beginning of the pattern, press the note before starting the Style.

Tracks volume/status area

Virtual sliders

Touch the track’s area to select a track, and use TEMPO/VALUE controls to change the value (or touch and drag it in the display).

Track status icons

►STYLE

Status of tracks. Touch this icon to change the status.



Play status. The track can be heard.



Mute status. The track cannot be heard.



Record status. After starting recording, the track will receive notes from the keyboard and the MIDI IN connector.

Track names

Under the sliders, a label for each track is shown.

Drum...Acc5 Shown Style tracks.

Main page - Record 2/Cue

While in the main page, touch the “Record 2/Cue” tab to see this page. Most parameters in this page are the same as in “Main page - Record 1”. In addition, here you can see and select Sounds for each Style track, and the Cue mode for the Style Element.

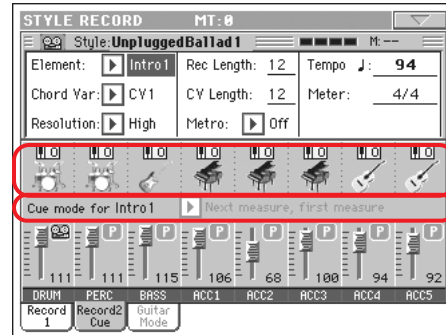

Sounds area
Cue area

Sounds area

This area lets you see Sounds and octave transposition for the eight Style tracks.

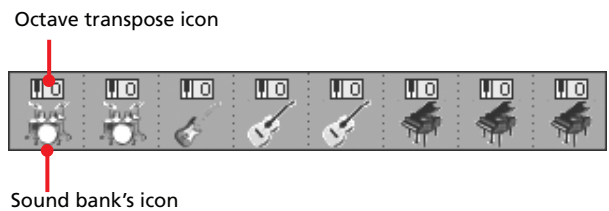

Octave transpose icon

Non editable. This indicator shows the track’s octave transposition. Tracks will be recorded with the selected octave transposition. To change this value, use the UPPER OCTAVE buttons, or go to the “Mixer/Tuning: Tuning” edit page in the Style Play mode (see page 96). Save this value to the Style Performance.

Sound bank’s icon

►STYLE

This picture illustrates the bank the current Sound belongs to. Touch an icon a first time to select the corresponding track (detailed information are shown on the Selected Track Info area, see the “Record 1” page above). Touch it a second time to open the Sound Select window.

Note: These Sounds can be replaced by Sounds selected by a Performance, provided the “Original Style Sounds” parameter is left unchecked in Style Play mode (see page 88).

Cue area

Cue mode for [Style element]

►STYLE

This parameter lets you decide how the current Style Element will enter after it has been selected. This setting is only available for the 'Variation' and 'Fill' Style Elements.

Immediate, first measure

The Style Element enters immediately, and begins from the first measure. *Only available on Fills.*

Immediate, current measure

The Style Element enters immediately, and begins from the current measure. *Only available on Fills.*

Next measure, first measure

The Style Element enters at the beginning of the next measure, and begins from the first measure of the new pattern. *Available on both Fills and Variations.*

Next measure, current measure

The Style Element enters at the beginning of the next measure, and begins from the current measure. *Only available on Variations.*

Main page - Guitar Mode

While in the main page, and a Guitar track has been selected, touch the "Guitar Mode" tab to see this page. This is where you can access Guitar Mode programming:

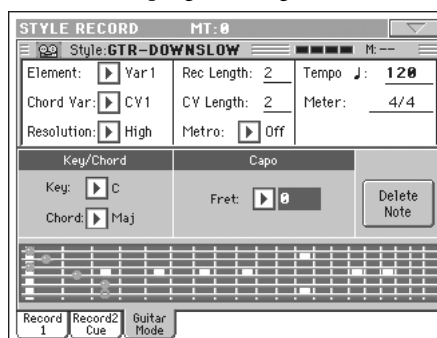

Note: To access this page, a Guitar track must first be selected (see "Track Type" on page 134). Otherwise, the Guitar Mode tab will remain grey (not selectable).

Note: When programming a Guitar track from an external sequencer, you must be sure the Guitar tracks is associated to the right channel. Go to the Global > MIDI > MIDI IN Channels page, and assign the corresponding Style track (usually Acc1 ~ Acc5) to the same channel of the Guitar track on the external sequencer. Then, go to the Style Record > Style Track Controls > Type/Tension/Trigger page, and set the track as a track of type "Gtr" (see "Track Type" on page 134).

Guitar Mode allows to easily create realistic rhythm guitar parts, without the artificial, unmusical playing typical of MIDI programming of guitar parts. Just record a few notes, and you will end up with realistic rhythm guitar tracks, where each chord is played according to its real position on the guitar, and not generated by simply transposing a written pattern.

Recording overview

Recording a Guitar track is unlike the other tracks, where you play the exact notes of a melody line. With Guitar tracks you play the keys corresponding to the strumming modes, or play an arpeggio by using the keys corresponding to the six strings (and the special keys corresponding to the root and fifth notes). The following sections describe the various control keys.

Recording strumming types

The lowest octave of the 61-key keyboard is dedicated to selecting a **strumming type**. By pressing these keys, you play fast strumming samples:

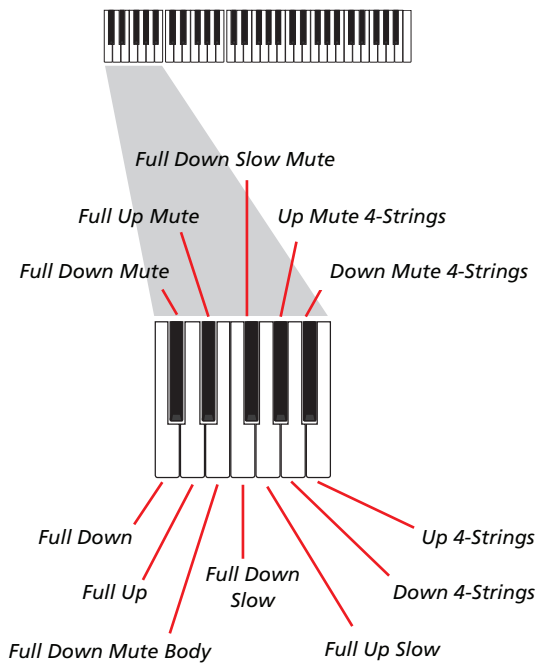

Recording single strings

The second octave of the 61-key keyboard is dedicated to selecting a **single string** (or more than one) for playing arpeggios or power chords. You can either play a free arpeggio with the six guitar chords assigned to the C~A keys, or play one of the faster sampled arpeggios on the higher keys. The root note is always available on the C# key, while the fifth note is always assigned to the D# key; with them, you can always play the lowest notes of an arpeggio. This octave also includes an 'all mute' key (F#):

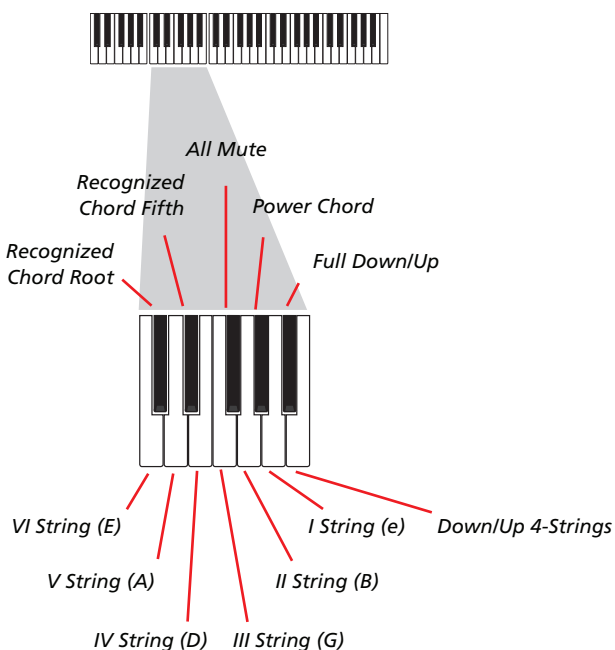

Recording RX Noises

Further on, the upper three octaves of the 61-key keyboard are used to trigger **RX Noises**:

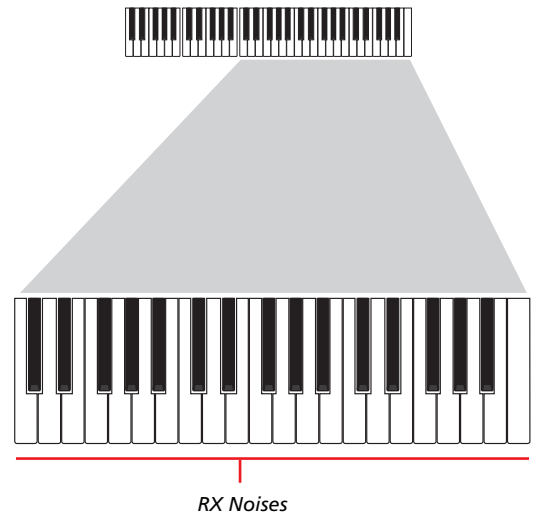

Selecting a Capo

Together with strumming types, single strings and RX Noises, you can choose a capo (capotasto). Note that this might prevent some single strings to sound, depending on the composed chord. You can always see with strings are playing and which are not, as described in the "Diagram" section below.

Choosing a Key/Chord

The pattern is recorded in the key indicated by the Key/Chord pair of parameters. However, this parameter is only considered during playback of the Intro 1 and Ending 1 Style Elements. With Intro 1 and Ending 1 (both Chord Variation 1 and 2) you can also enter a chord progression. This is done with the lowest MIDI octave (C-1 ~ B-1). Chord types are inserted by using velocity, as shown in the following table:

Vel.	Chord Type	Vel.	Chord Type
1	Major	2	Major 6th
3	Major 7th	4	Major 7th flatted 5th
5	Suspended 4th	6	Suspended 2nd
7	Major 7th suspended 4th	8	Minor
9	Minor 6th	10	Minor 7th
11	Minor 7th flatted 5th	12	Minor major 7th
13	Dominant 7th	14	7th flatted 5th
15	7th suspended 4th	16	Dimished
17	Diminished major 7th	18	Augmented
19	Augmented 7th	20	Augmented major 7th
21	Major w/o 3rd	22	Major w/o 3rd and 5th
23	Flatted 5th	24	Diminished 7th

Playing back the pattern

When in Style Play mode, the recorded Guitar pattern is transposed according to the chord recognized on the keyboard. The way it is transposed depends on the programmed pattern, with the chosen positions, strumming mods, etc...

Guitar mode parameters

Here is a detailed description of the parameters of the Guitar Mode page.

Key/Chord

►STYLE

This parameter pair allows you to define the track's original key and chord type. This parameter works in a different way than the other tracks. While with other tracks this is always the reference key used for NTT transposition, with Guitar tracks there is a difference, whether you are recording a Chord Variation contained in an Intro 1 or Ending 1 Style Element, or any other Chord Variation:

- With Intro 1 and Ending 1, this chord will be used as the reference key for the chord progression.
- With all the other Chord Variations, this chord will be used only for listening during recording. During playback in Style Play mode, the chord will follow chord recognition.

Capo (0, I...X)

►STYLE

A capo (from the Italian “capotasto”, “head of fingerboard”) is a movable bar attached to the fingerboard of the guitar, to uniformly raise the pitch of all the strings. Its use makes the strings shorter, therefore changing the timbre and position of the chords (but not its shape).

0	Open string – no capo.
I...X	Position of the capo over the fingerboard (i.e., “I” corresponds to the first fret, “II” to the second one, and so on).

Diagram

The diagram shows how a chord would be composed on the fingerboard. Here is the meaning of the various symbols:

Red dot	Fingered string (i.e., played note).
White dot	Fifth, playing on the D#2 key.
X	Non played or muted note.
Light grey bar	Barré (a finger crossing all the strings, like a mobile capo).
Dark grey bar	Capo.

Style Record procedure

There are two different methods for recording a Style: Realtime and Step.

- Realtime Recording allows you to record Style patterns in realtime.
- Step Recording allows you to create a new Style by entering single notes or chords in each track. This is very useful when transcribing an existing score, or needing a higher grade of detail, and is particularly suitable to create drum and percussion tracks.

In addition, you can program a Style on a personal computer, and then import it via the Import function (see “Import: Import SMF” on page 135).

Preparing to record

1. If you like to edit an existing Style, select that Style.
2. Press the RECORD button to enter the Style Record mode. You are prompted to select either the Current Style, or a New Style.

Select “record/edit Current Style” if you want to edit the current Style, or make a new Style starting from an existing one. Select “Record New Style” if you want to start from scratch with an empty Style.
3. After you select your preferred option, the main page of the Style Record mode will appear.
4. Select the Element (Style Element) and Chord Var (Chord Variation) parameters, to select the Chord Variation to be recorded/edited.

Note: For more information on the Style Elements and Chord Variations, and the Style structure in general, see “The Style structure” on page 111.
5. Use the Rec Length (Recording Length) parameter to set the length (in measures) of the pattern to record.
6. Use the Meter parameter to set the Style Element's meter.



Note: You can edit this parameter only if you selected the “Record New Style” option when entering the Record mode, or when editing an empty Style Element.
7. Select the Tempo parameter and set the tempo.
8. Touch the Record 2 tab to see the Sounds area. Here you can assign the right Sound to each Style track. You cannot select Digital Drawbars Sounds. (For more details, see “Sounds area” on page 117).
9. If needed, set the Octave Transpose for each track. *Note: The Octave Transpose will affect only the notes coming from the keyboard, and not from the arranger.*
10. At this point, if you want to do a Realtime Recording go on reading “Realtime Record procedure” below. Otherwise, if you prefer to do a Step Record, jump to “Step Record procedure” on page 121.

Realtime Record procedure

1. Select the track to record. Its status icon will turn to 'Record'. (For more details, see "Tracks volume/status area" on page 117).

Note: When entering the Record mode, a track is already in Record status. When you press START/STOP after entering the Record mode, you can immediately start recording.

If you like, you can try your part before recording:

- Mute the track, by repeatedly touching its status icon, until the  (Mute) status icon appears.
- Press START/STOP to let any recorded track play back, and practice on the keyboard.
- When you have finished practicing, press START/STOP to stop the arranger, and unmute the track by repeatedly touching its status icon, until the  (Record) status icon appears again.

2. While the shown status icon is Record, press START/STOP to begin recording. Depending on the "Metro" (metro-nome) option you selected, a 1- or 2-bars precount may play before the recording actually begins. When it begins, play freely. The pattern will last for some measures, according to the Rec Length value, then restart.

Since the recording will happen in overdub, you can add notes on any following passage. This is very useful to record different percussive instruments at any cycle on a Drum or Percussion track.

Note: While recording, track's **Keyboard Range** (see page 132) is ignored, and the track can play over the whole keyboard range. The **Local** parameter (see "Local Control On" on page 224) is also automatically set to On, to allow playing on the keyboard.

3. When finished recording, press START/STOP to stop the arranger. Select a different track, and go on recording the full Chord Variation.

Note: You can select a different track only when the arranger is not running.

4. When finished recording the Chord Variation, select a different Chord Variation or Style Element to go on recording the full Style.
5. When finished recording the new Style, select the "Write Style" command from the page menu, to open the Write Style dialog box (see "Write Style dialog box" on page 138) and save it to memory.

To exit the Style Record mode without saving any change, select the "Exit from Record" command from the page menu, or press the RECORD button.

Step Record procedure

1. While in the main page of the Style Record mode, select the "Overdub Step Recording" command from the page menu, to enter the Overdub Step Record mode.
2. The "Pos" parameter shows the current position.
 - If you do not want to insert a note or chord at the current position, insert a rest instead, as shown in step 4.
 - To jump to the next measure, filling the remaining beats with rests, touch the Next M. button in the display.
3. To change the step value, use the "Step Time values" area in the display.
4. Insert a note, rest or chord at the current position.
 - To insert a single note, just play it on the keyboard. The inserted note length will match the step length. You may change the velocity and relative duration of the note, by editing the "Duration" and "Velocity" parameters (see page 141).
 - To insert a rest, just touch the Rest button in the display. Its length will match the step value.
 - To tie the note to be inserted to the previous one, touch the Tie button in the display. A note will be inserted, tied to the previous one, with exactly the same name. You don't need to play it on the keyboard again.
 - To insert a chord or a second voice, see "Chords and second voices in Step Record mode" below.
5. After inserting a new event, you may go back by touching the Back button in the display. This will delete the previously inserted event, and set the step in edit again.
6. When the end of the pattern is reached, the "End of Loop" event is shown, and the recording restarts from the "001.01.000" position. Any note exceeding the pattern length, inserted at its end, will be reduced to fit the total length of the pattern.

At this point, you may go on, inserting new events in overdub mode (the previously inserted events will not be deleted). This is very useful when recording a drum or percussion track, where you may want to record the bass drum on a first cycle, the snare drum on the second cycle, and the hi-hat and cymbals during the following cycles.

7. When finished recording, touch the Done button in the display to exit the Step Record mode.

A dialog box appears, asking you to either cancel, discard or save the changes.

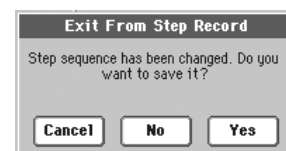

If you touch Cancel, exit is canceled, and you can continue editing. If you choose No, changes are not saved, and the Step Record window is closed. If you choose Yes, changes are saved, and the Step Record window is closed.

8. When back to the main page of the Style Record mode, you may turn all tracks to the play status, then press START/STOP to listen to the Style. Press START/STOP again to stop the playback.
9. From the main page of the Style Record mode, select either the "Write Style" or the "Exit from Record" command to exit from the Style record mode, respectively by saving the Style to memory (see "Write Style dialog box" on page 138), or by canceling any change.

Chords and second voices in Step Record mode

You are not obliged to insert single notes in a track. There are several ways to insert chords and double voices. Lets look at some.

Entering a chord. Simply play a chord instead of a single note. The event name will be the first note of the chord you pressed, followed by the "..." abbreviation.

Entering a chord made of notes with different velocity values. You can make the upper or lower note of a chord, for example, louder than the remaining ones, to let the most important stand out from the chord. Here is how to insert a three-note chord:

1. Edit the first note's Velocity value.
2. Press the first note and keep it pressed.
3. Edit the second note's Velocity value.
4. Press the second note and keep it pressed.
5. Edit the third note's Velocity value.
6. Press the third note, then release all notes.

Entering a second voice. You can insert passages where one note is kept pressed, while another voice moves freely.

Ex. 1:

The diagram for Ex. 1 illustrates two methods for entering chords in Step Record mode. At the top, a musical staff shows a sequence of notes: C, E, C, G. Below this, two piano keyboard diagrams show the corresponding key actions:

- Example 1:** The first step shows pressing E and C together. The second step shows releasing E while C remains held.
- Example 2:** The first step shows pressing G. The second step shows releasing both G and C together.

Ex.2:

The diagram for Ex. 2 illustrates a sequence of notes: C, G, C, G, C. The piano keyboard diagrams show the following actions:

- Step 1: Press C.
- Step 2: Press G (continue holding C).
- Step 3: Release G and C.

Ex.3:

The diagram for Ex. 3 illustrates a sequence of notes: C, F, C, G, C, D, C, E, C. The piano keyboard diagrams show the following actions:

- Step 1: Press F and C.
- Step 2: Release F (continue holding C).
- Step 3: Press G (continue holding C).
- Step 4: Release G (continue holding C).
- Step 5: Press D (continue holding C).
- Step 6: Release D (continue holding C).
- Step 7: Press E (continue holding C).
- Step 8: Release E and C.

Edit menu

From any page (apart for Step Record), press the MENU button to open the Style Record edit menu. This menu gives access to the various Style Record edit sections.

When in the menu, select an edit section, or press EXIT to exit the menu and return to the main page. To return to the main page, you can also select the Main Page menu item.

When in an edit page, press the EXIT button to return to the main page of the Style Record mode.

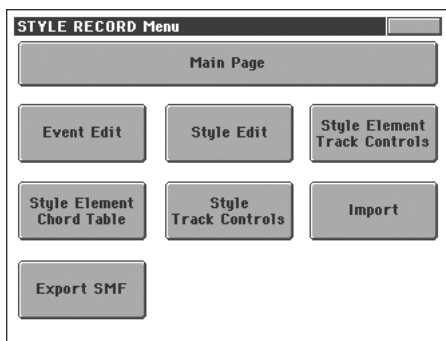

Note: While the Style is in play, you cannot access the Edit section pages from the main page (see page 114). Stop the playback before pressing MENU.

Note: When switching from the Edit section pages (Quantize, Transpose, Velocity, Delete) to the other pages, or vice-versa, the Style (if in play) is automatically stopped.

Edit page structure

Most edit pages share some basic elements.

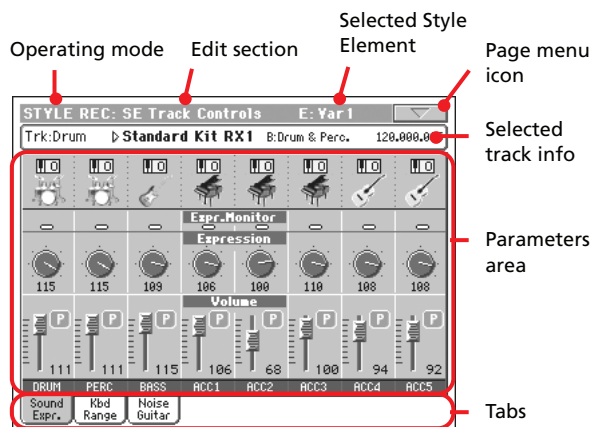

Other pages have a slightly different structure.

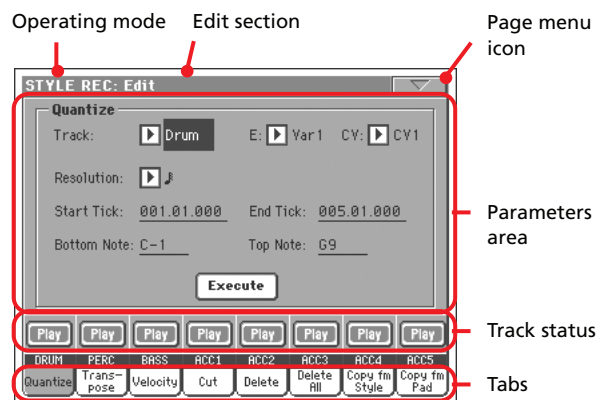

Operating mode

This indicates that the instrument is in Style Record mode.

Edit section

This identifies the current edit section, corresponding to one of the items of the edit menu (see “Edit menu” on page 123).

Selected Style Element

In Style Record mode, edits always happen on the selected Style Element.

Page menu icon

Touch this icon to open the page menu (see “Page menu” on page 138).

Parameters area

Each page contains various parameters. Use the tabs to select one of the available pages. For detailed information on the various types of parameters, see sections starting from page 124.

Track status

Use these buttons to mute/unmute tracks while editing.

Tabs

Use tabs to select one of the edit pages of the current edit section.

Event Edit: Event Edit

The Event Edit is the page where you can edit each single MIDI event of the selected Chord Variation. You can, for example, replace a note with a different one, or change its playing strength (i.e., velocity value). See “Event Edit procedure” on page 125 for more information on the event editing procedure.

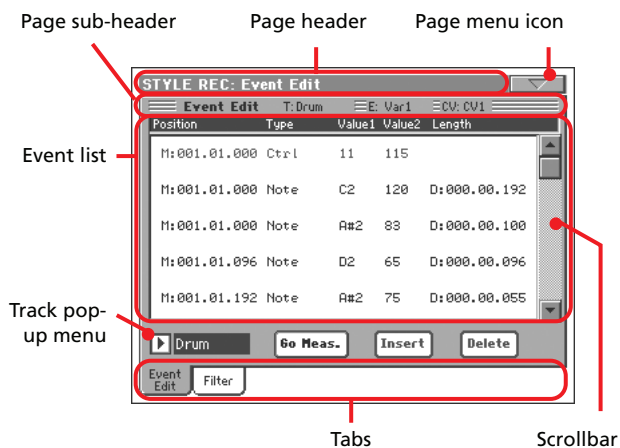

Page header

See “Page header” on page 114.

Page menu icon

Touch this icon to open the page menu. See “Page menu” on page 138.

Page sub-header

This area shows some performing info on the Song.

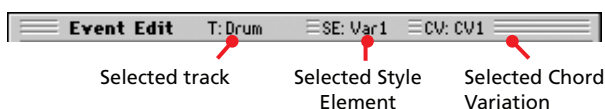

Selected track

Name of the track in edit. Use the Track pop-up menu to select one of the Style tracks.

SE/CV (Style Element/Chord Variation)

Selected Style Element and Chord Variation. This parameter cannot be edited. To select a different Style Element and Chord Variation, press EXIT to go back to the main page of the Style Record mode (see “Main page - Record 1” on page 114).

Event list

Use the Event list to see all events contained in the selected track in the selected Style Element.

Use the scrollbar to browse through the events. You can also scroll by using the SHIFT + DIAL combination.

Touch the event to be selected. Selected events are highlighted and can be heard.

Position

Position of the event, expressed in the form ‘aaa.bb.ccc’:

- ‘aaa’ is the measure
- ‘bb’ is the beat
- ‘ccc’ is the tick (each quarter beat = 384 ticks)

You can edit this parameter to move the event to a different position. You can edit a position in either of the following ways:

- select the parameter, and use the TEMPO/VALUE controls to change the value, or
- select the parameter, then touch it again; the numeric keypad will appear. Enter the new position by dialing in the three parts of the number, separated by a dot. Zeroes at the beginning can be omitted, as well as the least important parts of the number. For example, to enter position 002.02.193, dial “2.2.193”; to enter position 002.04.000 dial “2.4”; to enter position 002.01.000, simply dial “2”.

Type, Value 1, Value 2

Type and values of the event shown in the display. Depending on the selected event, the value may change. This parameter also shows the (greyed-out, so non-editable) “CC#11” (Expression) event at the beginning of the pattern, and the “End Of Loop” marking, when the end of a track is reached.

Event type	Value 1	Value 2
Note	Note name	Velocity
Ctrl	Control Change number	Control Change value
Bend	Bending value	–

To change the event type, select the Type parameter, then use the TEMPO/VALUE controls to select a different event type. A set of default values will be automatically assigned to the event.

To select and edit the event’s value, select the corresponding parameter, and use TEMPO/VALUE controls.

Length

Length of the selected Note event. The value format is the same as the Position value. This is only available for Note events.

Note: If you change a length of “000.00.000” to a different value, you can’t go back to the original value. This rather uncommon zero-length value may be found in some drum or percussion tracks.

Scrollbar

Use the scrollbar to browse the event through the list. (As an alternative, use Shift + Dial).

Other elements

Track pop-up menu

Use this pop-up menu to select the track to edit, inside the current Chord Variation.

Drum...Acc5 Style track.

Go Meas.

While the Style is not running, touch this button to open the Go to Measure dialog box:



When in this dialog box, select a target measure, and touch OK. The first event available in the target measure will be selected.

Insert

Touch the Insert button in the display to insert a new event at the current shown Position. The default values are Type = Note, Pitch = C4, Velocity = 100, Length = 192.

Delete

Touch the Delete button in the display to delete the event selected in the display.

Event Edit procedure

Here is the general procedure to follow for the event editing.

1. Select the Style to edit, and press the RECORD button. Select the “Current Style” option to enter recording. The main page of the Style Record mode will appear.
2. Select the “Element (Style Element)” and “Chord Var (Chord Variation)” parameters.
Note: For more information on the Style Elements and Chord Variations, and the Style structure in general, see “The Style structure” on page 111.
3. Press MENU, and select the Event Edit section. The Event Edit page appears (see “Event Edit: Event Edit” on page 124 for more information).
4. Press START/STOP to listen to the selected Chord Variation. Press START/STOP to stop it. Chord Scanning does not work, so you will listen the pattern at the original Key/Chord.
5. Touch the Filter tab to select the Filter page, and uncheck the filters for the event types you wish to see in the display (see “Event Edit: Filter” on page 126 for more information).
6. Touch the Event Edit tab to go back to the Event Edit page.
7. Use the Track pop-up menu to select the track to edit (see “Track pop-up menu” on page 125).

8. The list of events contained in the selected track (inside the Chord Variation selected on step 2) will appear in the display. Some events on the beginning of the Chord Variations, as well as the “EndOfTrk” event (marking its ending point) cannot be edited, therefore appearing in grey.
9. Scroll through the various events by using the scrollbar.
10. Select an event to be edited by touching it in the display. This is usually a note, that you can edit.

M:001.01.000 Note F#2 51 M:000.00.008

For more information on the event types and their values, see “Event Edit: Event Edit” on page 124.

11. Edit the event.
 - Select the “M” parameter. Use TEMPO/VALUE controls to change the event’s position.
 - Select the Type parameter. You may use TEMPO/VALUE controls to change the event type, as well as its Value 1 and Value 2.
 - If a Note event is selected, select the Length parameter, and use TEMPO/VALUE controls to change the event’s length.
12. You may use the Go Meas. command to go to a different measure (see “Go Meas.” on page 125)
13. As described in step 4, you may press START/STOP to listen how the pattern sounds after your changes. Press START/STOP again to stop the pattern running.
14. Touch the Insert button in the display to insert an event at the Position shown in the display (a Note event with default values will be inserted). Touch the Delete button in the display to delete the selected event.
15. When editing is complete, you may select a different track to edit (go to step 7).
16. When finished editing the selected Chord Variation, press EXIT to go back to the main page of the Style Record mode, then go to step 2 to select and edit a different Chord Variation.
17. When finished editing the whole Style, select the “Write Style” command from the page menu to open the Write Style dialog box (see “Write Style dialog box” on page 138), or select the “Exit from Record” command to cancel all changes.
 - Touch the **T** (Text Edit) button to enter the Text Edit dialog box. Enter a name and confirm by selecting OK.
 - Select a target memory location where to save the Style. The name of the Style already existing at the selected location is shown after the Style Bank-Location number.
Warning: If you select an existing Style and confirm writing, the older Style is deleted and replaced by the new one. Save the Styles you don’t want to lose to a storage device, before overwriting them.
18. Touch OK to save the Style to the internal memory, or Cancel to delete any changes made in Style Record mode. When the “Are you sure?” message appears, touch OK to confirm, or Cancel to go back to the “Write Style” dialog box.

Event Edit: Filter

This page is where you can select the event types to be shown in the Event Edit page.

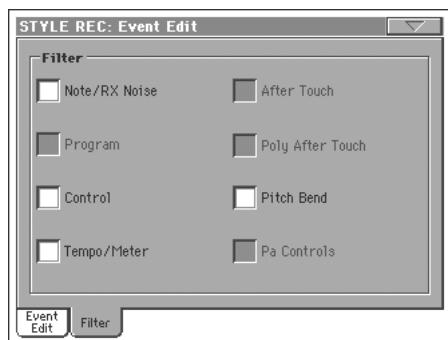

Turn On the filter for all event types you do not wish to see in the Event Edit page.

Note: Some of the events are “ghosted”, and non editable, since the corresponding events are not editable in a Style.

Note/RX Noise

Notes and RX Noises.

Control

Control Change events. Only the following Control Change numbers are allowed with Styles.

Control function	CC# (Control Change Number)
Modulation 1	1
Modulation 2	2
Pan	10
Expression ^(a)	11
CC#12	12
CC#13	13
Damper	64
Filter Resonance	71
Low Pass Filter Cutoff	74
CC#80	80
CC#81	81
CC#82	82

(a). Expression events cannot be inserted at the starting Position (001.01.000). An Expression value is already among the default “header” parameters of the Style Element.

Tempo/Meter Tempo and Meter changes (Master Track only).

Pitch Bend Pitch Bend events.

Style Edit: Quantize

The quantize function may be used to correct any timing mistake after recording, or to give the pattern a “groovy” feeling.

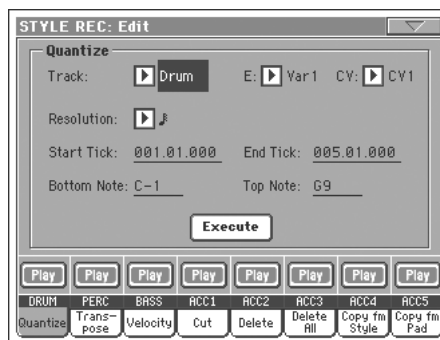

After setting the various parameters, touch Execute.

Track

Use this parameter to select a track.

All All tracks selected.

Drum...Acc5 Selected track.

E / CV (Style Element/Chord Variation)

Use these parameters to select the Style Element and Chord Variation for editing.

Resolution

This parameter sets the quantization after recording. For example, when you select 1/8, all notes are moved to the nearest 1/8 division. When you select 1/4, all notes are moved to the nearest 1/4 division.

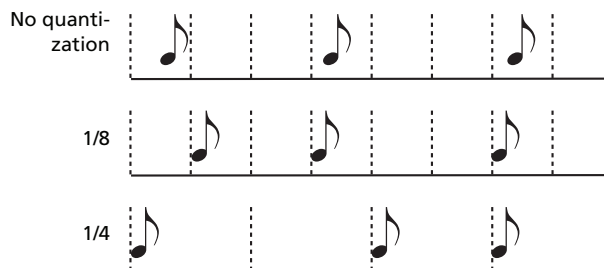

♪ (1/32)...♪ (1/4)

Grid resolution, in musical values. A “b...f” character added after the value means swing-quantization. A “3” means triplet.

Start / End Tick

Use these parameters to set the starting and ending points of the range to quantize.

If a Chord Variation is four measures long, and you want to select it all, the Start will be positioned at 1.01.000, and the End at 5.01.000.

Bottom / Top Note

Use these parameters to set the bottom and top of the keyboard range to quantize. If you select the same note as the Bottom and Top parameters, you can select a single percussive instrument in a Drum or Percussion track.

Note: These parameters are available only when a Drum or Percussion track is selected.

Execute

Touch this button to execute the operation set in this page.

Track status icon

Status of tracks. Touch this icon to change the status.



Play status. The track can be heard.



Mute status. The track cannot be heard.

Track names

Under the buttons, a label for each track is shown.

Style Edit: Transpose

In this page you can transpose the selected track(s).

Note: After transposing, please don't forget to readjust the "Key/Chord" parameter in the main page of the Style Record mode (see page 115).

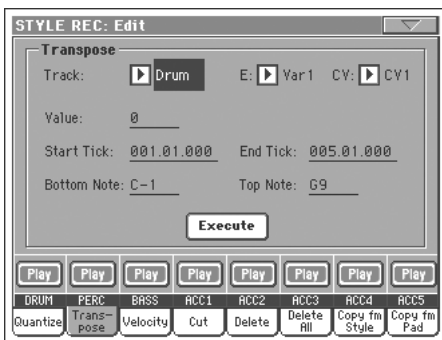

After setting the various parameters, touch Execute.

E / CV (Style Element/Chord Variation)

Use these parameters to select the Style Element and Chord Variation for editing.

Track

Use this parameter to select a track.

All All tracks selected, apart for tracks set in Drum mode (like the Drum and Percussion tracks). The whole selected Chord Variation will be transposed.

Drum...Acc5 Single selected track.

Value

Transpose value (± 127 semitones).

Start / End Tick

Use these parameters to set the starting and ending points of the range to be transposed.

If a Chord Variation is four measures long, and you want to select it all, the Start will be positioned at 1.01.000, and the End at 5.01.000.

Bottom / Top Note

Use these parameters to set the bottom and top of the keyboard range to be transposed. If you select the same note as the Bottom and Top parameters, you can select a single percussive instrument in a Drum or Percussion track. Since in a Drum Kit each instrument is assigned to a different note of the scale, transposing a percussive instrument means assigning the part to a different instrument.

Execute

Touch this button to execute the operation set in this page.

Track status icon

Status of tracks. Touch this icon to change the status.



Play status. The track can be heard.



Mute status. The track cannot be heard.

Track names

Under the buttons, a label for each track is shown.

Style Edit: Velocity

In this page you can change the velocity (dynamics) value of notes in the selected track. An Advanced mode is available, allowing you to select a velocity curve for the selected range. This is useful to create fade-ins or fade-outs.

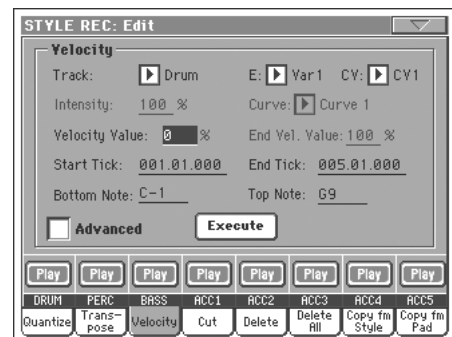

After setting the various parameters, touch Execute.

Note: When an RX Sound is assigned to the track being edited, the resulting sound may change, since this kind of Sounds is made of several different layers triggered by different velocity values.

Also, a fade-out may result in the level "jumping" up next to the zero, since a higher-level layer may be selected by low velocity values.

Track

Use this parameter to select a track.

All All tracks selected. The velocity for all notes of the whole selected Chord Variation will be changed.

Drum...Acc5 Selected track.

E / CV (Style Element/Chord Variation)

Use these parameters to select the Style Element and Chord Variation for editing.

Value

Velocity change value (± 127).

Start / End Tick

Use these parameters to set the starting and ending points of the range to be modified.

If a Chord Variation is four measures long, and you want to select it all, the Start will be positioned at 1.01.000, and the End at 5.01.000.

Bottom / Top Note

Use these parameters to set the bottom and top of the keyboard range to be modified. If you select the same note as the Bottom and Top parameters, you can select a single percussive instrument in a Drum or Percussion track.

Advanced

When this checkbox is checked, the “Intensity”, “Curve”, “Start Velocity Value” and “End Velocity Value” parameters can be edited.

Intensity

(Only available in Advanced mode). Use this parameter to specify the degree to which the velocity data will be adjusted toward the curve you specify in “Curve”.

0...100% Intensity value. With a setting of 0 [%], the velocity will not change. With a setting of 100 [%], the velocity will be changed the most.

Curve

(Only available in Advanced mode). Use this parameter to select one of the six curves, and to specify how the velocity will change over time.

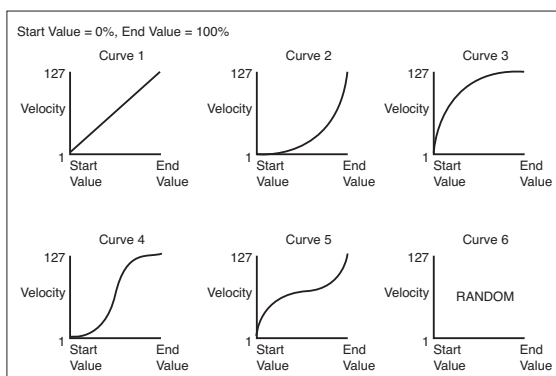

Start / End Vel. Value

(Only available in Advanced mode). Velocity change at the starting and ending ticks of the selected range.

0...100 Velocity change in percentage.

Execute

Touch this button to execute the operation set in this page.

Track status icon

Status of tracks. Touch this icon to change the status.



Play status. The track can be heard.



Mute status. The track cannot be heard.

Track names

Under the buttons, a label for each track is shown.

Style Edit: Cut

This function lets you quickly delete a selected measure (or a series of measures) from the selected Chord Variation. All following events are moved back, to replace the cut measure(s).

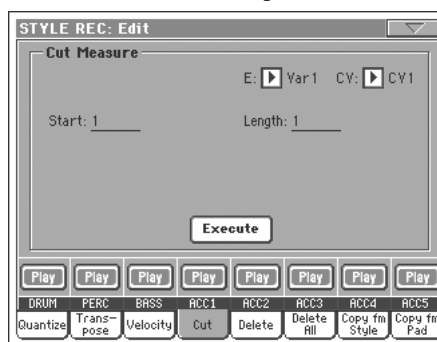

After setting the various parameters, touch Execute.

E / CV (Style Element/Chord Variation)

Use these parameters to select the Style Element and Chord Variation for editing.

Start

First measure to be cut.

Length

Number of measures to be cut.

Execute

Touch this button to execute the operation set in this page.

Track status icon

Status of tracks. Touch this icon to change the status.



Play status. The track can be heard.



Mute status. The track cannot be heard.

Track names

Under the buttons, a label for each track is shown.

Style Edit: Delete

This page is where you can delete MIDI events out of the Style. This function does not remove measures from the pattern. To remove whole measure, use the Cut function (see “Style Edit: Cut” on page 128)

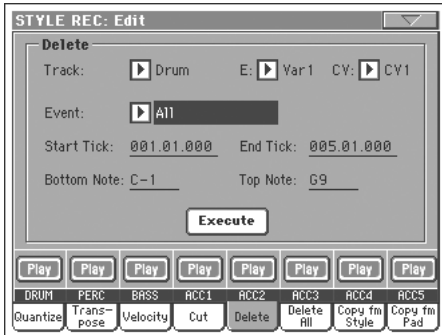

After setting the various parameters, touch Execute.

E / CV (Style Element/Chord Variation)

Use these parameters to select the Style Element and Chord Variation for editing.

Track

Use this parameter to select a track.

All All tracks selected. After deletion, the selected Chord Variation will remain empty.

Drum...Acc5 Selected track.

Event

Type of MIDI event to delete.

All All events. The measures are not removed from the Chord Variation.

Note All notes in the selected range.

Dup.Note All duplicate notes. When two notes with the same pitch are encountered on the same tick, the one with the lowest velocity is deleted.

After Touch After Touch events.

Note: This kind of data is automatically removed during recording.

Pitch Bend Pitch Bend events.

Prog.Change Program Change events, excluding the bundled Control Change #00 (Bank Select MSB) and #32 (Bank Select LSB).

Note: This kind of data is automatically removed during recording.

Ctl.Change All Control Change events, for example Bank Select, Modulation, Damper, Soft Pedal...

CC00/32...CC127

Single Control Change events. Double Control Change numbers (like 00/32) are MSB/LSB bundles.

Note: Some CC data are automatically removed during recording. See the table on page 113 for more information on the allowed data.

Start / End Tick

Use these parameters to set the starting and ending points of the range to delete.

If a Chord Variation is four measures long, and you want to select it all, the Start will be positioned at 1.01.000, and the End at 5.01.000.

Bottom / Top Note

Use these parameters to set the bottom and top of the keyboard range to delete. If you select the same note as the Bottom and Top parameters, you can select a single percussive instrument in a Drum or Percussion track.

Note: These parameters are available only when the All or Note option is selected.

Execute

Touch this button to execute the operation set in this page.

Track status icon

Status of tracks. Touch this icon to change the status.



Play status. The track can be heard.



Mute status. The track cannot be heard.

Track names

Under the buttons, a label for each track is shown.

Style Edit: Delete All

This function lets you quickly delete a selected Style Element or Chord Variation, or the whole Style.

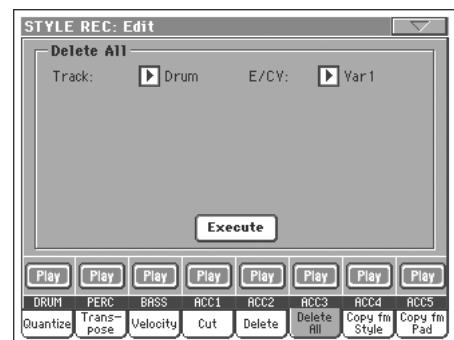

After setting the various parameters, touch Execute.

Track

All All tracks of the selected Style, Style Element or Chord Variation.

Drum-Acc5 Single track of the selected Style, Style Element or Chord Variation.

E / CV (Style Element/Chord Variation)

Use these parameters to select the Style Element and Chord Variation for editing.

All All Style Elements, i.e. the whole Style. When E/Track=All and CV=All, the whole Style is deleted, and all parameters are set to the default status.

Var1...CountIn Single Style Element.

V1-CV1...CI-CV2 Single Chord Variation.

Execute

Touch this button to execute the operation set in this page.

Track status icon

Status of tracks. Touch this icon to change the status.

 Play status. The track can be heard.

 Mute status. The track cannot be heard.

Track names

Under the buttons, a label for each track is shown.

Style Edit: Copy from Style

Here you can copy a track, Chord Variation or Style Element inside the same Style, or from a different one. Furthermore, you can copy a whole Style.

Warning: The Copy operation deletes all data at the target location (overwrite).

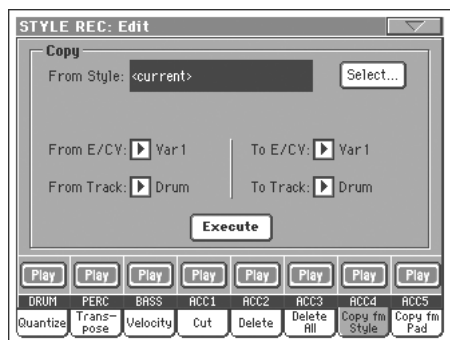

After setting the various parameters, touch Execute.

Note: If you copy too many events on the same “tick”, the “Too many events!” message appears, and the copy operation is aborted.

Note: When you copy over an existing Chord Variation, Program Change data is not copied, to leave the original Sounds unchanged for that Chord Variation.

From Style

Choose this option to select the source Style to copy the track, Chord Variation or Style Element from. Touch the **Select** button to open the Style Select window and select the source Style.

From... To E/CV (Style Element/Chord Variation)

Use these parameters to select the source and target Style Elements or Chord Variations.

Note: You can't copy from a Variation to a different Style Element (or vice-versa), because of their different structure.

All All Style Elements, i.e. the whole Style. You can't change the target, that is automatically set to All.

Var1...End2 Single Style Element.

V1-CV1...E2-CV2 Single Chord Variation.

From... To Track

Use this parameter to select the source and target track to copy. You can double a track, to strengthen a pattern.

All All tracks of the selected Style, Style Element or Chord Variation.

Drum-Acc5 Single track of the selected Style, Style Element or Chord Variation.

Execute

Touch this button to execute the operation set in this page.

Track status icon

Status of tracks. Touch this icon to change the status.

 Play status. The track can be heard.

 Mute status. The track cannot be heard.

Track names

Under the buttons, a label for each track is shown.

Copying to a Chord Variation of a different length

You can copy a Chord Variation to a different one of a different length. Just keep in mind the following:

- If the source length is a divider of the target length, the source Chord Variation will be multiplied to fit the target Chord Variation. For example, if the source is 4-measures long, and the target 8-measures, the source will be copied two times.

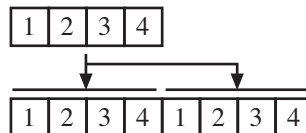

- If the source length is not a divider of the target length, the source Chord Variation will be copied for as many measures as can fit the target Chord Variation. For example, if the source is 6-measures long, and the target 8-measures,

the source will be copied once, then the first 2 measures will be copied to fit the remaining 2 measures.

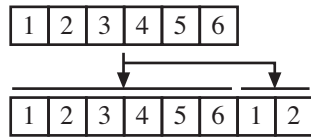

Note: Avoid copying to a Chord Variation with a different meter, for example a 4/4 Chord Variation onto a 3/4 one.

Style Edit: Copy from Pad

Here you can copy a Chord Variation from a Pad. Furthermore, you can copy a whole Pad.

Warning: The Copy operation deletes all data at the target location (overwrite).

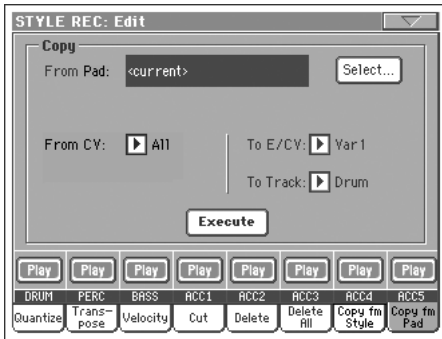

After setting the various parameters, touch Execute.

Note: If you copy too many events on the same “tick”, the “Too many events!” message appears, and the copy operation is aborted.

Note: When you copy over an existing Chord Variation, Program Change data is not copied, to leave the original Sounds unchanged for that Chord Variation.

From Pad

Choose this option to select the source Pad to copy the Chord Variation from. Touch the **Select** button to open the Pad Select window and select the source Pad.

From CV (Chord Variation)

Use this parameter to select the source Chord Variation.

All All Chord Variations, i.e. the whole Pad. You can't change the target, that is automatically set to All.

CV1...CV6 Single Chord Variation.

To CV (Chord Variation)

Use this parameter to select a target Chord Variation inside the current Style.

CV1...CV6 Target Chord Variation. Automatically set to All if the “From CV” parameter is also set to All.

To Track

Use this parameter to select the target track to copy.

All All tracks of the selected Style, Style Element or Chord Variation.

Drum-Acc5 Single track of the selected Style, Style Element or Chord Variation.

Execute

Touch this button to execute the operation set in this page.

Style Element Track Controls: Sound/Expression

In this page you can assign a different Sound to each track of the selected Style Element. Each Style Element can have different Sound; after saving the new Style, please don't forget to check the “Original Style Sounds” parameter in the Style Play mode (see page 88), to let the Style select the Sound bypassing the Style Performance settings.

In this page you can also check and modify the Expression (CC#11) value for each of the Style Element tracks. This lets you reduce the relative level of a track in a single Style Element, without reducing the overall Volume of the Style. This is a very useful control, when you have different Sounds assigned to the same track in different Style Elements, and the internal level of these Sounds must be different.

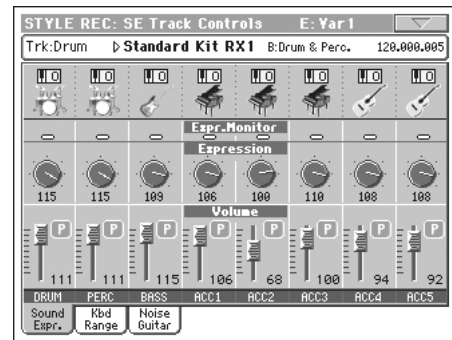

When in this page, press the corresponding button on the control panel to select a Style Element (VARIATION1 ... ENDING3).

To copy the settings of this page to another Style Element, use the “Copy Sound” and “Copy Expression” commands from the page menu (see “Copy Sounds dialog box” and “Copy Expression dialog box” starting from page 139).

Selected Track Info area

►STYLE

See “Selected track info area” on page 115 for detailed information.

Sounds area

►STYLE

See “Sounds area” on page 117 for detailed information.

Expression area

Expression Monitor

You can use these indicators to check if CC#11 (Expression) messages are contained in a track. Expression messages contained in a track can vary the volume of the track. It is very difficult to catch them out – unless you carefully read all the events in the Event Edit page.

This monitor should help you keeping track of them, and let you access Event Edit only on the tracks containing the messages. Press the START/STOP button to start playback, and look at the indicators. When one of them lights up, you can enter Event Edit on the corresponding track, and edit or remove the Expression messages.

Expression

►STYLE

Use these knobs to set the Expression (CC#11) value for the corresponding track. This value can be seen at the beginning of the Event Edit list (see “Event Edit: Event Edit” on page 124).

Different Expression values can be defined for each Style Element. This way, you can set a different volume in each Style Element, relative to the general Volume value set in the Style Header.

Expression leveling

You can quickly and easily adjust the Expression level of all tracks in a Style Element (Variation, Intro...). This allows for a more precise control over the volume level of all Style Element.

1. While in this page, select one of the Style Elements by pressing its button in the control panel.

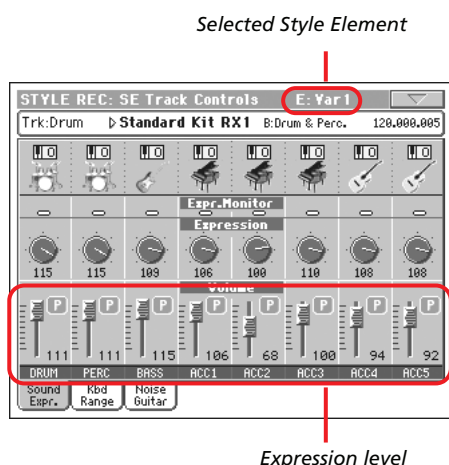

2. Keep the SHIFT button pressed, and move any Assignable Slider to proportionally change the Expression value of all Style Variation tracks.
3. Release the SHIFT button.
4. Repeat the above operation with all the desired Style Elements.

Note: A track's volume may be changed by an Expression event contained in a track. To check if any of these events exist in a track, let the Style Element play and look at the Expression Monitor in this same page. If one or more Expression events are found, go to the Event Edit page and delete it (or them)

Volume area

Use these controls to set the volume and status of each track. See page 117 for more information.

The Volume value is the same for the whole Style. Use the Expression controls to adjust the relative balance between tracks in each Style Element.

Style Element Track Controls: Keyboard Range

The Keyboard Range automatically transposes any pattern note that would otherwise play too high or too low in pitch, compared to the original acoustic instrument, when transposed by the arranger. This will result in a more natural sound for each accompaniment instrument.

For example, the lower limit for a guitar is E2. If you play a chord under the E2, the transposed pattern could exceed this limit, and sound unnatural. A Bottom limit set to E2 for the guitar track will solve the problem.

Different Keyboard Range values can be set for each Style Element.



Note: The Keyboard Range is ignored while recording. The selected track can play on the full range of the keyboard.

When in this page, press the corresponding button on the control panel to select a Style Element (VARIATION1 ... ENDING3).

To copy the settings of this page to another Style Element, use the “Copy Keyboard Range” command from the page menu (see “Copy Key Range dialog box” on page 140).

Top/Bottom

►STYLE

Use these parameters to set the bottom and top of the keyboard range for the corresponding track of the current Style Element.

Volume area

Use these controls to set the volume and status of each track. See page 117 for more information.

Style Element Track Controls: Noise/Guitar

The Noise/Guitar page is where you can set the RX Noise level and the 'human feel' of Guitar tracks.

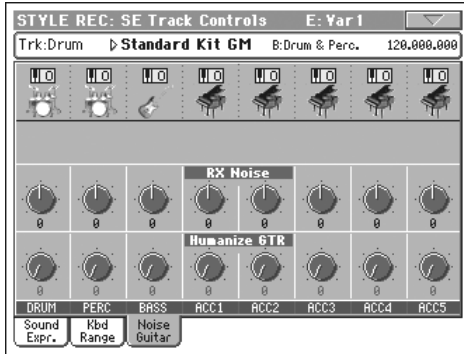

RX Noise

►STYLE

Use these controls to adjust the volume of RX Noises in the corresponding tracks. This control applies to all types of tracks (provided the Sound includes RX Noises).

Humanize GTR

►STYLE

Use these controls to apply a random value to the position, velocity and length of notes of Guitar tracks (see "Track Type" on page 134). This control has no effect on other types of track.

Style Element Chord Table: Chord Table

This is the page where you can assign a Chord Variation to each of the most important recognized chord. When a chord is recognized, the assigned Chord Variation will be automatically selected by the arranger to play the accompaniment.

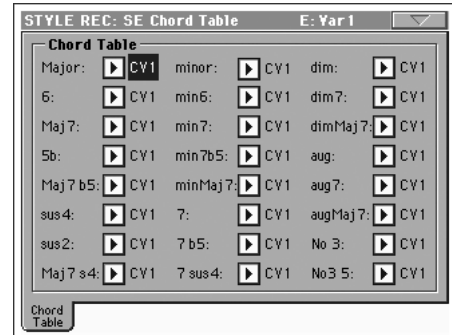

When in this page, press the corresponding button on the control panel to select a Style Element (VARIATION1 ... ENDING3).

Chord / Chord Variation

►STYLE

Use these parameters to assign a Chord Variation to each of the most important chords.

Style Track Controls: Type/Trigger/Tension

In this page you can set the Mode, Retrigger mode for the Style tracks, and activate/deactivate the Tension for the Accompaniment tracks.

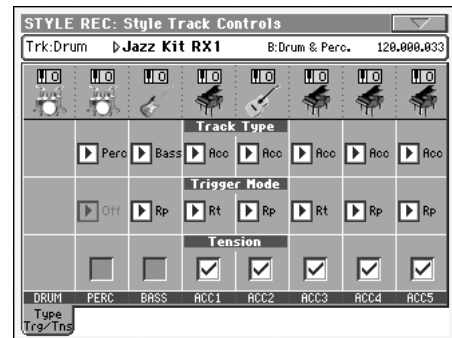

When in this page, press the corresponding button on the control panel to select a Style Element (VARIATION1 ... ENDING3).

Track Type

►STYLE

Use this parameter to set the type of the corresponding track.

- Drum Drum track. This type of track is not transposed by the arranger, and is used for Drum Kits made of Drum sounds. It can be affected by the Drum Mapping of the Style Play mode (see “Drum Mapping (Var.1...Var.4)” on page 104).
- Perc Percussion track. This type of track cannot be transposed, and is used for Drum Kit made of Percussion sounds. It is NOT affected by the Drum Mapping.
- Bass Bass track. This type of track always plays the root when changing chord.
- Acc Accompaniment track. This type of track can be used freely, for melodic or harmonic accompaniment patterns.
- Gtr Guitar track. This type of track uses Guitar Mode to create guitar strumming (see “Main page - Guitar Mode” on page 118). When this type is selected, the “Tension” parameter can no longer be edited.

Trigger Mode

►STYLE

This setting lets you define how Bass and Acc-type tracks are retriggered when the chord is changed.

- Off Each time you play a new chord, current notes will be stopped. The track will remain silent until a new note will be encountered in the pattern.
- Rt (Retrigger) The sound will be stopped, and new notes matching the recognized chord will be played back.
- Rp (Repitch) New notes matching the recognized chord will be played back, by repitching notes already playing. There will be no break in the sound. This is very useful on Guitar and Bass tracks.

Tension

►STYLE

Tension adds notes (a 9th, 11th and/or 13th) that have actually been played to the accompaniment, even if they haven't been written in the Style pattern. This parameter specifies whether or not the Tension included in the recognized chord will be added to the Acc-type tracks.

- On The Tension will be added.
- Off No Tension will be added.

Import: Import Groove

The Import Groove function allows the loading of MIDI Grooves (“.GRV” files) generated by the Slice function (see the “Time Slice” page of the Sampling mode, in the “Advanced Edit” addendum in the Accessory CD). By importing these data to a track, and assigning the Sound based on the sliced samples to the same track, you can play the original audio groove, and freely change its tempo.



Note: After importing a groove generated by a melody line (not by a percussive groove), the imported groove and samples will not be transposed together with the other Style tracks. Audio data cannot be transposed by the arranger.

Note: Please execute the Import Groove operation before turning the instrument off. All “.GRV” files generated by a Time Slice operation are deleted when turning the instrument off.

From

Use this parameter to select one of the MIDI Groove patterns (“.GRV” files) generated when saving data after a Time Slice operation.

To E/CV (Style Element/Chord Variation)

Use this parameter to select the target Style Element and Chord Variation.

To Track

Use this parameter to select the target track inside the selected Chord Variation. **The Percussion track is usually suggested**, since the Drum track is still suitable for standard Drum Kit sounds (count-in, break etc.). After importing the MIDI Groove pattern, assign the Sound, to which the sliced samples are assigned, to the track playing the MIDI Groove pattern.

Import: Import SMF

The Import SMF function allows you to import MIDI data from a Standard MIDI File (SMF) created on your preferred external sequencer, and transform them in a Chord Variation.

Note: You cannot use this function to import data from any generic Song. The Standard MIDI File to be imported must be programmed as if it was one of Pa800's Chord Variations.

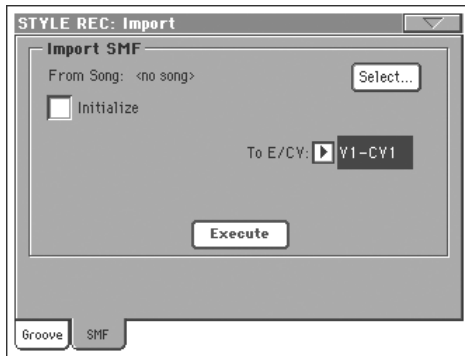

When importing an SMF, parameters like CV Length, Meter, Tempo Changes, Program Changes and Expression are recognized. These parameters will be imported as the header of the Style Element containing the Chord Variation, provided the "Initialize" parameter is checked, or the Style Element is empty.

Hint: It is a good idea to check the "Initialize" parameter when importing the first Chord Variation of a Style Element, and uncheck it when importing the following Chord Variations.

- Sounds assigned to each track can be imported, provided the Program Change, Bank Select MSB and LSB events are on the first 'tick' of the SMF. These data are loaded in the Style Element's header, and not as Sounds assigned to the Style Performance.

Note: Sounds in the Style Element header can be overridden by Sounds assigned to the Style Performance, by checking the "Original Style Sound" parameter in the main page of the Style Play mode (Style Track view).

- If the above data was not found on the first 'tick' of the imported SMF, Sounds must be manually assigned to each track. You can do this in the "Record 1" or "Record 2", or the "Sound/Expression" page of the Style Record mode.

- Key/Chord, Chord Table, Expression, and any other Style Variation parameter, must be manually programmed in the relevant Style Record pages.

- The starting Tempo, and each track's Volume, must be programmed as Style Performance data, and then saved in the Style Performance.

- Meter Change is not allowed, therefore not recognized.

- The Chord Variation length is the same as the imported SMF. You can change length by changing the value of the CV Length parameter, on the main page of the Style Record mode.

Hint: If a note extends beyond the last measure of the Chord Variation, an additional measure is appended (for example, if a note extends after the end of the fourth measure in a 4-measure pattern, a 5-measure Chord Variation will be generated). If so, change the CV Length value to reset the Chord Variation length. The exceeding note will be cut, to fit the new pattern length.

When programming a Chord Variation on an external sequencer, please assign each Style track to the correct MIDI channel, according to the following table.

Style Track	MIDI Channel
Bass	09
Drum	10
Percussion	11
Accompaniment 1	12
Accompaniment 2	13
Accompaniment 3	14
Accompaniment 4	15
Accompaniment 5	16

Note: Only SMF in format 0 can be loaded.

From Song

This is the name of the Standard MIDI File to be loaded. Touch the Select button to open the file selector, and select an ".SMF" file.

Select

Touch this button to open the file selector and load the SMF.

Initialize

Check this parameter if you want all settings of the target Style Element (i.e., Key/Chord, Chord Table, Sounds...) are reset when loading the SMF.

Hint: It is a good idea to check the "Initialize" parameter when importing the first Chord Variation of a Style Element, and uncheck it when importing the following Chord Variations.

To E/CV

Use this parameter to select a target Chord Variation.

Execute

After setting all parameters in this page, touch this button to import the Standard MIDI File into the target Chord Variation.

Importing an SMF separated by Markers into a Style

As an alternative to importing single Chord Variations, you can import a whole Style as an SMF separated by Markers, i.e., a single SMF containing all the Chord Variations (Variation 1, Variation 2, etc.) each one separated by a Marker (the same events used in Song Play mode).

1. While in this page, touch the Select button, and choose the Standard Midi File to be imported.
2. Keep the SHIFT button pressed.
3. Without releasing the SHIFT button, touch the Execute button in the display.
4. Release the SHIFT button.

When creating a new Style, we suggest to check the “Initialize” checkbox. Do not check it if the SMF you are loading was previously exported from a Style to be edited; in this case, it is very important to keep all the previous settings.

Style Tracks and MIDI Channels must be lined as in the previous table, as per Korg’s standard Style format definition.

Note: Tracks/MIDI Channels other than the above mentioned are ignored during the import procedure.

For a list of MIDI events supported during the import operations, please see “List of recorded events” on page 113. If any, the following events are stripped off and automatically transferred to the Style Element header during the import procedure:

- Time signature (this event is mandatory)
- Control Change bundle #00-32 (Bank Select MSB/LSB)
- Program Change
- Control Change #11 (Expression)

Control Change 00, Control Change 32 and Program Change messages must be placed at the very beginning of each Chord Variation (tick 0).

Whenever they are not saved in the SMF, Program Change, Control Change 00, 11 and 32, can be still programmed in Style Record mode, by using the edit features available.

Warning: Pa800 can only handle SMF format 0 (Zero). If you are in trouble importing your file, maybe your sequencer (or DAW) is exporting using a different format. Please refer to the software’s user’s manual.

The naming structure for the Markers inside the SMF is “EnCVn”, whose single components are shown in the following table:

Component	Meaning
E	Style Element ('v' = variation, 'i' = intro, 'f' = fill, 'e' = ending)
n	Style Element number ('1'~'4' for variations, '1'~'2' for all other style elements)
CV	Chord Variation ('cv' = chord variation – no other choices allowed)
n	Chord Variation number [1~6 for Variations, 1~2 for all others]

Warning: It is mandatory not to use capital letters in Marker names. Some examples of **valid** names:

'i1cv2' = Intro1 – Chord Variation 2

'v4cv3' = Variation 4 – Chord Variation 3

Examples of **non accepted** names:

'V1cv2', 'v1CV2', 'intro i1cv2', 'v1cv1 chorus'

The order of the Chord Variations inside the SMF is not relevant. They can be freely placed inside the SMF.

At the end of this page you can find a screenshot of a test file created in Steinberg Cubase, just as an example of how a SMF separated by Markers can look like. Considering analogies between actual workstations, it will not look much different in other applications like Logic, Digital Performer, Pro Tools or Sonar.

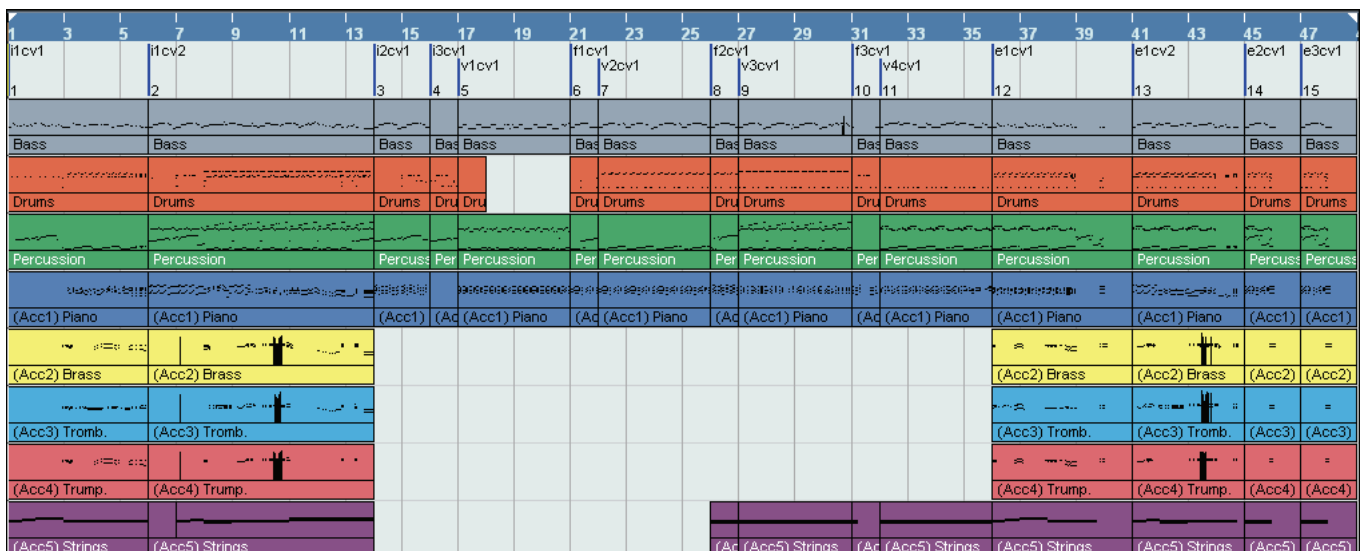

Export SMF

The Export SMF function allows you to export a Chord Variation as a Standard MIDI File (SMF), and edit it on your preferred external sequencer.



To Song

This (non editable) parameter shows the name of the Standard MIDI File to be generated. The (automatically assigned) name will be the same of the exported Chord Variation.

From E/CV

Use this pop-up menu to select one of the available Chord Variations from the current Style.

Execute

After selecting a Chord Variation, touch this button to export it as a Standard MIDI File. A standard file selector will appear. Select the target device and directory, then touch Save. After you touch Save, a dialog box appears, letting you assign a name to the file.

Exporting a Style as an SMF separated by Markers

As an alternative to exporting single Chord Variations to individual Standard MIDI Files, you can export a whole Style as an *SMF separated by Markers*, i.e., a single SMF containing all the Chord Variations (Variation 1, Variation 2, etc.) each one separated by a Marker (the same events used in Song Play mode).

1. While in this page, keep the SHIFT button pressed.
2. Without releasing the SHIFT button, touch the Execute button in the display.
3. Release the SHIFT button.
4. Assign a name to the Standard Midi File where to save the Style in edit.

This operation creates, in the selected device, an SMF format 0 (Zero), containing all the MIDI data included in the selected Style, with each Chord Variation starting from a different Marker (named as per the naming convention explained in the Import section above).

Each Chord Variation will include, at the very beginning (tick 0), the following informations:

- Time signature
- Control Change bundle #00-32 (Bank Select MSB/LSB)
- Program Change
- Control Change #11 (Expression)

Page menu

Touch the page menu icon to open the page menu. Touch a command to select it. Touch anywhere in the display to close the menu without selecting a command.



Write Style

Select this command to open the Write Style dialog box, and save the Style to the internal memory.

See “Write Style dialog box” on page 138 for more information.

Undo

Only available in Record mode. While in Record mode, cancels the latest recorded data and restores the previous situation. Selected a second time, it restores recorded data again (“Redo” function).

Copy Key/Ch (Copy Key/Chord) button

Select this command to open the Copy Key/Chord dialog box, and copy Key/Chord settings of the currently selected track to all other tracks of the same Chord Variation, or to the whole Style.

See “Copy Key/Chord dialog box” on page 139 for more information.

Copy Sound

Only available in some edit pages. While the Style Element Track Control edit section is selected, use this command to open the Copy Sound dialog box and copy all Sounds assigned to the current Style Element tracks to a different Style Element.

See “Copy Sounds dialog box” on page 139 for more information.

Copy Expression

Only available in some edit pages. While the Style Element Track Control edit section is selected, use this command to open the Copy Expression dialog box and copy all Expression values assigned to the current Style Element tracks to a different Style Element.

See “Copy Expression dialog box” on page 139 for more information.

Copy Keyboard Range

Only available in some edit pages. While the Style Element Track Control edit section is selected, use this command to open the Copy Keyboard Range dialog box and copy all Keyboard Range values for the current Style Element tracks to a different Style Element.

See “Copy Key Range dialog box” on page 140 for more information.

Copy Chord Table

Only available while in the Style Element Chord Table page. Select this command to open the Copy Chord Table dialog box (see “Copy Chord Table dialog box” on page 140).

Delete Current Track

Only available in the Main Record pages. Select this command to delete the selected track.

Overdub Step Recording

Only available in the Main Record pages. Select this command to open the Overdub Step recording window (see “Overdub Step Recording window” on page 140).

Solo Track

Select the track to be soloed, then check this item. You will hear only the selected track, and the ‘Solo’ warning will flash on the page header.

Uncheck this item to exit the Solo function.

SHIFT Keep the SHIFT button pressed and touch one of the tracks to solo it. Do the same on a soloed track to deactivate the Solo function.

Exit from Record

Select this command to exit from Record without saving changes to the Style.

Write Style dialog box

Open this window by choosing the Write Style item from the page menu. Here you can save the recorded or edited Style to memory, by choosing either a User or Favorite Style bank.

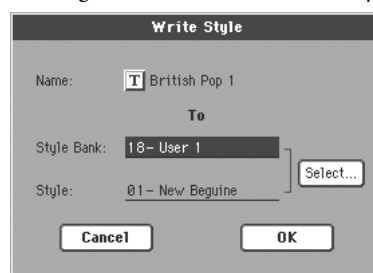

Parameters saved in the Style are marked with the ▶STYLE symbol through the user’s manual.

Name

▶STYLE

Name of the Style to be saved. Touch the **T** (Text Edit) button next to the name to open the Text Edit window.

Style Bank

Target bank of Styles. Each bank corresponds to one of the STYLE SELECT buttons. Use TEMPO/VALUE controls to select a different bank.

Style

Target Style location in the selected bank. Use TEMPO/VALUE controls to select a different location.

Note: A User or Favorite Style is usually prompted when writing a Style. However, you can overwrite a Factory Style, when the “Factory Style and Pad Protect” parameter is left unchecked (see page 257).

Select... button

Touch this button to open the Style Select window, and select a target location.



While in the Style Select window, use the buttons on top of the window to select either the User (Bank 11/20) or the Favorite banks.

Copy Key/Chord dialog box

Open this window by choosing the Copy Key/Chord item from the page menu. Here you can copy Key/Chord settings of the currently selected track to all other tracks of the same Chord Variation, or to the whole Style. This function is useful to speed-up pattern programming, and to avoid having different tracks in different keys within the same Chord Variation.



Current Chord Variation Tracks

The Key/Chord of the current track will be copied to all tracks of the current Chord Variation.

All Style Tracks

The Key/Chord of the current track will be copied to all tracks of the Style (i.e., all Chord Variations).

Copy Sounds dialog box

Open this window by choosing the Copy Sounds item from the page menu. Here you can copy all Sounds assigned to the current Style Element tracks to a different Style Element.



From Style Element

Non editable. Currently selected Style Element.

To Style Element

Target Style Element.

All Settings will be copied to all Style Element of the Style in edit.

Var1...CountIn

Single Style Element where to copy settings to.

Copy Expression dialog box

Open this window by choosing the Copy Expression item from the page menu. Here you can copy all Expression values assigned to the current Style Element tracks to a different Style Element.

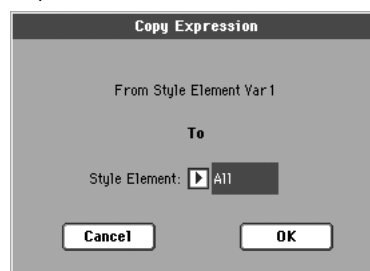

From Style Element

Non editable. Currently selected Style Element.

To Style Element

Target Style Element.

All Settings will be copied to all Style Element of the Style in edit.

Var1...CountIn

Single Style Element where to copy settings to.

Copy Key Range dialog box

Open this window by choosing the Copy Keyboard Range item from the page menu. Here you can copy all Keyboard Range values for the current Style Element tracks to a different Style Element.

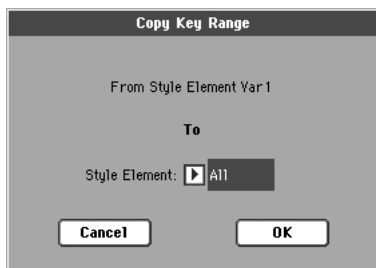

From Style Element

Non editable. Currently selected Style Element.

To Style Element

Target Style Element.

All Settings will be copied to all Style Element of the Style in edit.

Var1...CountIn Single Style Element where to copy settings to.

Copy Chord Table dialog box

Open this window by choosing the Copy Chord Table item from the page menu. Here you can copy the Chord Table of the current Style Element to a different Style Element.

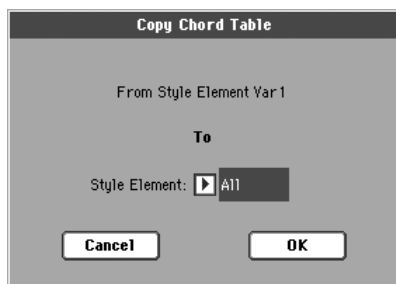

To Style Element

Target Style Element.

All Settings will be copied to all Style Element of the Style in edit.

Var1...CountIn Single Style Element where to copy settings to.

Overdub Step Recording window

The Step Record allows you to create a new Style by entering single notes or chords to each track, by playing them on the keyboard one at a time, with no need to play on time. This is very useful when transcribing an existing score, or needing a higher grade of detail, and is particularly suitable to create drum and percussion tracks.

To access this page, select the “Overdub Step Recording” command from the page menu.

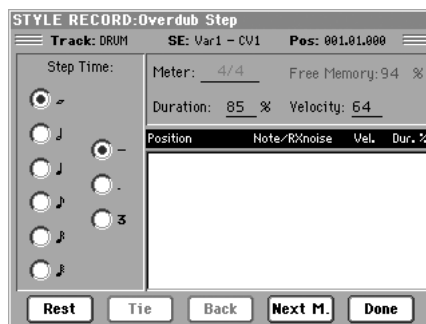

Track (Selected track)

Name of the selected track in record.

DRUM...ACC5
Style track.

SE (Selected Style Element)

See “Element (Style Element)” on page 114.

CV (Selected Chord Variation)

See “Chord Var (Chord Variation)” on page 114.

Pos (Position)

This is the position of the event (note, rest or chord) to be inserted.

Event list

Previously inserted events. You may delete this event, and set it in edit again, by touching the Back button.

Step Time values

Length of the event to be inserted.

- o ... Note value.
- Standard (-) Standard value of the selected note.
- Dot (.) Augments the selected note by one half of its value.
- Triplet (3) Triplet value of the selected note.

Meter

Meter of the current measure. This parameter cannot be edited. You can set the Meter in the main page of the Style Record mode, before actually starting recording (see step 6 on page 120 for more information).

Free Memory

Remaining memory for recording.

Duration

Relative duration of the inserted note. The percentage is always referred to the step value.

25%	Staccatissimo.
50%	Staccato.
85%	Ordinary articulation.
100%	Legato.

Velocity

Set this parameter before entering a note or chord. This will be the playing strength (i.e., velocity value) of the event to be inserted.

Kbd	Keyboard. You can select this parameter, by turning all counter-clockwise the dial. When this option is selected, the playing strength of the played note is recognized and recorded.
1...127	Velocity value. The event will be inserted with this velocity value, and the actual playing strength of the note played on the keyboard will be ignored.

Rest

Touch this button to insert a rest.

Tie

Touch this button to tie the note to be inserted to the previous note.

Back

Goes to the previous step, erasing the inserted event.

Next M. (Next Measure)

Goes to the next measure, and fills the remaining space with rests.

Done

Exits the Step Record mode. If you have inserted some notes, a dialog box appears, asking you to either cancel, discard or save the changes.

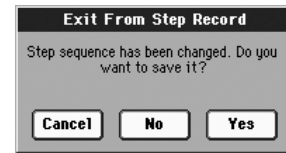

If you touch Cancel, exit is canceled, and you can continue editing. If you choose No, changes are not saved, and the Step Record window is closed. If you choose Yes, changes are saved, and the Step Record window is closed.

Pad Record mode

By entering the Pad Record mode, you can create your own Pads, or edit an existing Pad.

The Pad structure

A Pad is basically a single-track Style. Most of what applies to Style recording also applies to Pad recording.

There are two different categories of Pads:

- “Hit” Pads. While they are mostly used as non-transposing events, they can also be transposing notes or chords. Basically, they are single-note or single-chord Sequences (see below).
- “Sequence” Pads, i.e., complex single-track patterns, that can be transposed by playing different chords on the keyboard – exactly as a Style track. They are roughly equivalent to single-element, single-track, multi-chord variation Styles (see illustration).

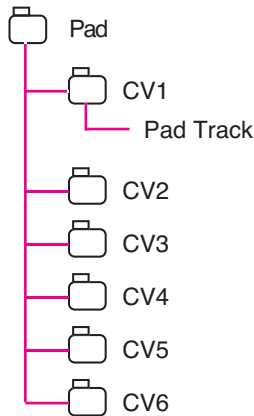

Each Pad is made up of up to six smaller units, called **Chord Variations (CV)**. Each Chord Variation is made of a single track (the Pad track).

Exactly as with the Styles, when playing a chord in the chord recognition area, the corresponding Chord Variation is recalled. Recognized chords are associated to a Chord Variation by means of the **Chord Variation Table**. Each Pad contains a Chord Variation Table.

As with the Styles, the **Note Transposition Tables (NTT)** applies to the Pads.

The same differences between the different types of tracks applies (see “Track Type” on page 153).

What to record

Recording a Pad is a matter of recording a single track, inside a series of Chord Variations, inside the Pad itself.

You don’t need to record all Chord Variations. It is often only needed to record just a Chord Variation.

Pattern data vs. track data

While the Pad Record mode is where you can create or edit music patterns for the Pad, track parameters (like Volume, Pan, FX settings...) have to be edited in Style Play mode.

- After creating or editing music patterns in Pad Record mode, save them by selecting the Write Pad command from the page menu of the Pad Record mode (see “Write Pad dialog box” on page 156).
- After editing Pad Track parameters in Style Play mode, save them to the Performance or Style Performance by selecting the Write Performance or Write Current Style Performance command from the page menu of the Style Play mode (see “Write Performance dialog box” on page 109 or “Write Style Performance dialog box” on page 110).

Entering the Pad Record mode

To enter Pad Record mode, go to the Style Play mode and press RECORD. The Style/Pad Record Select window appears.



- Select **Record/Edit Pad** to select an existing Pad to edit. If it is a Factory Pad, you may not be able to save it at the original location (depending on the status of the “Factory Style and Pad Protect” parameter in the Media > Preferences page); you will select a User Pad location instead.
- Select **Record New Pad** to start from a new, empty Pad. When finished recording, you will save the new Pad into a User Pad location. (Pads can be saved into Factory Pad locations only when the “Factory Style and Pad Protect” parameter is set to Off).

When you have finished recording or editing the Hit or Sequence Pad, please save it (see “Exit by saving or deleting changes” below) and exit the Pad Record mode.

Then, go to the Pad page of the Style Play or Song Play mode, assign the new Hit or Sequence to a Pad button, and adjust the various Pad settings (Volume, Pan, and A/B FX Send... see “Pad/Switch: Pad” on page 105). Finally, save the Pad settings by selecting the “Write Performance” or “Write Current Style Performance” command from the page menu.

Note: While in Record mode, the footswitch and EC5 pedals are disabled. On the contrary, volume/expression-type pedals can be used.

Exit by saving or deleting changes

When finished editing, you can save your Pad in memory, or cancel any change.

- To save changes, select the “Write Pad” command from the page menu (see “Write Pad dialog box” on page 156).
- To cancel all changes, select the “Exit from Record” command from the page menu, or press the RECORD button, to exit from record and return to the main page of the Style Record mode.

Hint: Save often while recording, to avoid accidentally losing your changes to the Pad.

Listening to the Pad while in Record/Edit mode

While you are in Pad Record or Pad Edit mode, you can listen to the selected Chord Variation. To select a Chord Variation, go to the Main page of the Record/Edit mode.

- When you are in the Main, Event Edit, Quantize, Transpose, Velocity, or Delete pages, you can listen to the selected Chord Variation. Press START/STOP to check how it works. Press START/STOP again to stop the playback.
- When you are in the Sounds/Expression, Keyboard Range, Chord Table, Trigger/Tension, Delete All, Copy, Style Element Controls or Style Control pages, you can listen to the whole Pad. Press START/STOP and play some chords to do your tests.

Note: In this mode, the pattern is always played back in loop, even if the “Pad Type” parameter is set to “One Shot” (see page 153).

Note: While in Pad Record mode, the Fingered 3 Chord Recognition mode is automatically selected.

Main page - Record 1

The Main - Record page of the Pad Record mode looks like a simplified version of the Main page of the Style Record mode, with just a single track to be recorded and no Style Elements to be chosen. The only addition is the “Pad Sync” parameter.

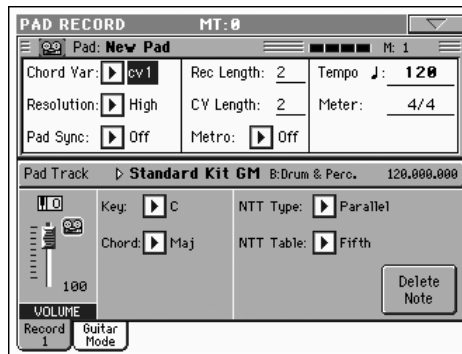

Please look at the User’s Manual for more information on the various parameters. Only general information and differences with the Style Record mode are described here.

Recording parameters area

Chord Var (Chord Variation)

This parameter lets you select one of the six available Chord Variations (CV1 ... CV6) for editing or recording.

Note: When this parameter and the assigned value is in small letters (cv1...cv6), the Chord Variation is empty; when it is in capitals (CV1...CV6), it is already recorded.

Resolution

Use this parameter to set the quantization during recording.

Pad Sync

▶PAD

This parameter allows you to set a synchronization mode for the Pad’s pattern.

Off No synchronization. The sequence will start as soon as you press the PAD button.

Continued The pattern will start immediately, in sync with the arranger’s or active sequencer’s tempo. Depending on the current position of the beat counter, it might not start from its very beginning; instead, it will continue from the current position.

For example, if the arranger’s or sequencer’s beat counter shows the third beat, and is playing tick 91, the Pad will start from its third beat, at tick 91.

The beat counter



This works exactly as if it was a Fill.

Beat The sequence will start at the next beat, in sync with the arranger's or sequencer's tempo. It will start from its very beginning (i.e., tick 1 or measure 1).

Rec Length (Recording Length) ▶PAD

This parameter sets the recording length (in measures) of the sequence. Its value is always equal to, or a divider of, the Chord Variation Length (see next parameter).

Warning: If you assign CV Length a value lower than Rec Length, the value of Rec Length is not immediately updated in the display. Therefore, you are still free of changing the value of CV Length, before the measures exceeding its value are deleted (see warning in "CV Length (Chord Variation Length)" below).

However, if you press START/STOP to begin recording, the real Rec Length value is changed to the new one, even if the display still shows the old value.

CV Length (Chord Variation Length) ▶PAD

This parameter sets the total length (up to 32 measures) for the selected Chord Variation. When playing a Style, this will be the length of the accompaniment pattern, when the chord corresponding to the Chord Variation is recognized on the keyboard.

Warning: If you reduce the Chord Variation Length after recording, any measure after the selected length will be deleted. Be very careful when setting the CV Length to a lower value after recording! If it happens, we suggest to exit from record without saving (see "Exit from Record" on page 155).

Metro (Metronome)

This is where you can set the metronome.

- Off** No metronome click will be heard during recording. In any case, a one-bar precount will be played before starting recording.
- On1** Metronome on, with a one-bar precount before starting recording.
- On2** Metronome on, with a two-bar precount before starting recording.

Tempo

Select this parameter to use TEMPO/VALUE controls to set the tempo.

Note: This value will not be recorded, and will only be used for testing the pattern at various speeds while editing or recording.

Hint: You can always change the Tempo, when other parameters are selected, by keeping the SHIFT button pressed, and rotating the DIAL.

Meter ▶PAD

This is the meter (time signature) of the sequence. You can edit this parameter only when the sequence is empty, i.e. before you begin recording anything.

Pad Track info area

This line lets you see the Sound assigned to the selected track.

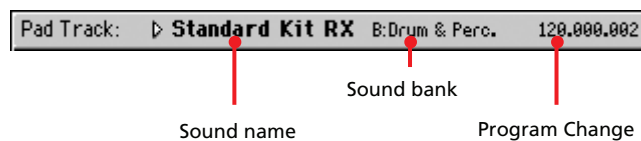

Sound name ▶PAD

Sound assigned to the Pad track. The triangle means you can touch the name to open the Sound Select window, and select a different Sound.

Sound bank ▶PAD

Bank the selected Sound belongs to.

Program Change ▶PAD

Program Change number sequence (Bank Select MSB, Bank Select LSB, Program Change).

Tracks volume/status area

Octave Transpose

This (non editable) indicator shows the current octave transposition. To change this value use the OCTAVE TRANSPOSE buttons on the control panel. 

While this value is not memorized with the Pad, the transposition is used during recording. For example, if you play a C4 and a +1 octave transposition is selected, a C5 is recorded.

Virtual slider

The virtual slider in the display shows the track's volume. To change the volume, touch the slider and use TEMPO/VALUE controls to change the value (or touch and drag it in the display).

This value is not saved with the Pad, and is only used to test the Pad's volume during editing or recording.

Track status icons

Status of the track. Touch this icon to change the status.



Play status. The track can be heard.



Mute status. The track cannot be heard.



Record status. After starting recording, the track will receive notes from the keyboard and the MIDI IN connector.

Key/Chord area

Key/Chord ▶PAD

This parameter pair allows you to define the track's original key and chord type, for the current Chord Variation. When playing the pattern back, this chord will be played back exactly as it was recorded, without any NTT processing (see below).

NTT Area

NTT Type/Table

▶PAD

NTTs (Note Transposition Tables) are the sophisticated algorithms that allow Korg arrangers to convert recognized chords into musical patterns. The Note Transposition Table (NTT) determines how the arranger will transpose pattern notes, when a chord is recognized that does not exactly match the original chord of a Chord Variation. For example, if you only recorded a Chord Variation for the CMaj chord, when a CMaj7 is recognized on the keyboard the arranger must transpose some notes to create the missing 7th.

Note: These parameters cannot be selected with Drum, Percussion or Guitar tracks, and are therefore greyed out.

Note: NTT parameters are separately programmed for each track of the Style Element.

There are two general types of NTTs:

- When **Parallel** types are selected, notes are transposed inside the area set by the Wrap Around parameter. These tables are ideally suited to melody parts.

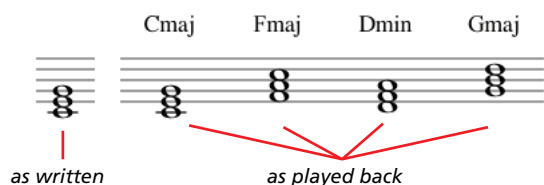

- When **Fixed** types are selected, the arranger moves as few notes as possible, making legato lines and chord changes more natural. They are ideally suited to chord tracks (strings, piano etc...).

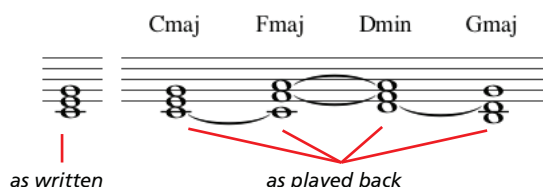

Note: To conform to Korg specifications, it is advisable to set the NTT to "No Transpose" on the Intro 1 and Ending 1.

Parallel/Root The root note (in CMaj = C) is transposed to the missing notes.

Parallel/Fifth The 5th note (in CMaj = G) is transposed to the missing notes.

As recorded with
NTT = Root or 5th
(Key/Chord = CMaj)



When you play a CM7
with NTT = Root



When you play a CM7
with NTT = 5th



Parallel/i-Series

All original patterns must be programmed on the "Maj7" or "min7" chords. When loading old Korg i-Series Styles, this option is automatically selected.

As recorded with
NTT = i-Series
(Key/Chord = CM7)



When you play a CMaj
with NTT = i-Series



When you play a C7
with NTT = i-Series



Parallel/No Transpose

The chord is not modified, and is moved to the new key unchanged. The pattern plays exactly the recorded notes, and is moved to the new key as is. This is the standard setting of Intro 1 and Ending 1 in Korg's original Styles (where a chord progression is usually recorded, and should remain unchanged in any key).

Fixed/Chord This table moves as few notes as possible, making legato lines and chord changes more natural. It is ideally suited to chord tracks (strings, piano etc...). Contrary to the Parallel mode, the programmed chord is not transposed according to the Wrap Around parameter, but always stays around its original position, looking for common notes between the chords.

Fixed/No Transpose

The programmed notes can only be transposed by the Master Transpose. They are never transposed when chords are changed.

Delete Note button

Use this command to delete a single note or a single percussive instrument from a track. For example, to delete a snare, keep the D2 note (corresponding to the snare) pressed.

1. Touch the "Delete Note" button, and keep it pressed.
2. Press START/STOP to start the Pad.
3. When you reach the passage containing the note to be deleted, play the note on the keyboard. Keep it pressed, up to the last note to be deleted.
4. When finished, release the Delete button and the note to be deleted, and press START/STOP again to stop the Pad.

Note: If the note is at the beginning of the pattern, press the note before starting the Pad.

Main page - Guitar Mode

While in the main page, and a Guitar track has been selected, touch the “Guitar Mode” tab to see this page. This is where you can access Guitar Mode programming:

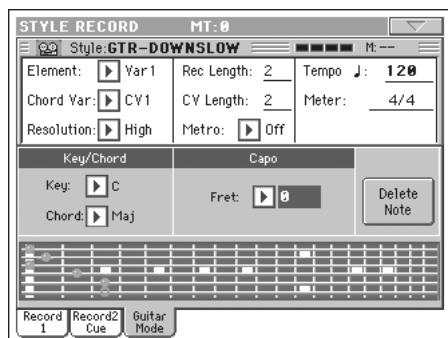

Note: To access this page, a Guitar track must first be selected (see “Track Type” on page 153). Otherwise, the Guitar Mode tab will remain grey (not selectable).

Note: When programming a Guitar track from an external sequencer, you must be sure the Guitar tracks is associated to the right channel. Go to the Global > MIDI > MIDI IN Channels page, and assign the corresponding Style track (usually Acc1 ~ Acc5) to the same channel of the Guitar track on the external sequencer. Then, go to the Style Record > Style Track Controls > Type/Tension/Trigger page, and set the track as a track of type “Gtr” (see “Track Type” on page 153).

Guitar Mode allows to easily create realistic rhythm guitar parts, without the artificial, unmusical playing typical of MIDI programming of guitar parts. Just record a few notes, and you will end up with realistic rhythm guitar tracks, where each chord is played according to its real position on the guitar, and not generated by simply transposing a written pattern.

Recording overview

Recording a Guitar track is unlike the other tracks, where you play the exact notes of a melody line. With Guitar tracks you play the keys corresponding to the strumming modes, or play an arpeggio by using the keys corresponding to the six strings (and the special keys corresponding to the root and fifth notes). The following sections describe the various control keys.

Recording strumming types

The lowest octave of the 61-key keyboard is dedicated to selecting a *strumming type*. By pressing these keys, you play fast strumming samples:

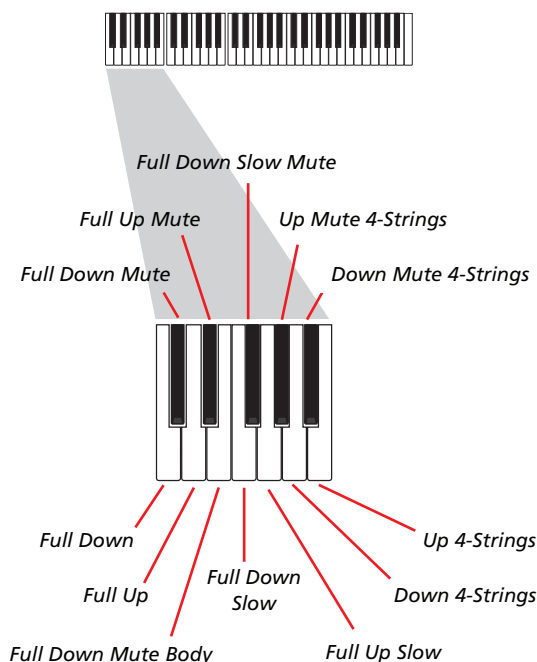

Recording single strings

The second octave of the 61-key keyboard is dedicated to selecting a *single string* (or more than one) for playing arpeggios or power chords. You can either play a free arpeggio with the six guitar chords assigned to the C~A keys, or play one of the faster sampled arpeggios on the higher keys. The root note is always available on the C# key, while the fifth note is always assigned to the D# key; with them, you can always play the lowest notes of an arpeggio. This octave also includes an ‘all mute’ key (F#):

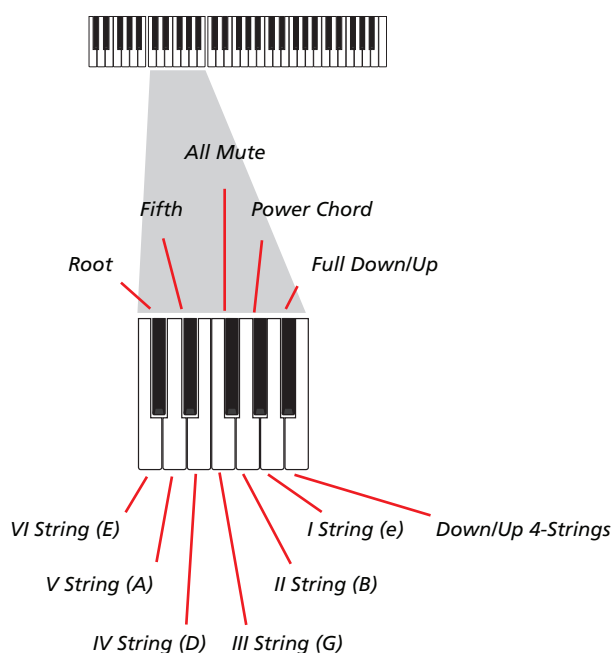

Recording RX Noises

Further on, the upper three octaves of the 61-key keyboard are used to trigger **RX Noises**:

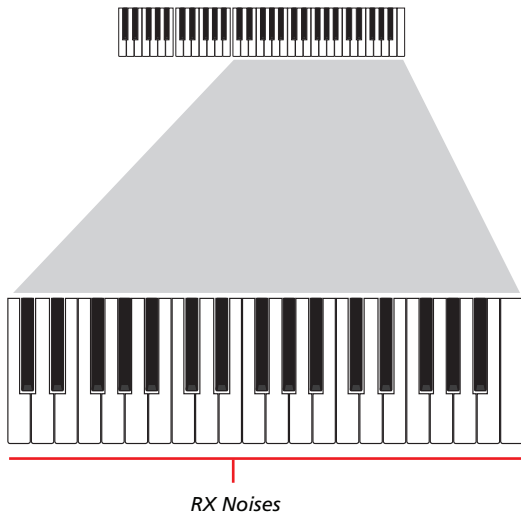

Selecting a Capo

Together with strumming types, single strings and RX Noises, you can choose a capo (capotasto). Note that this might prevent some single strings to sound, depending on the composed chord. You can always see with strings are playing and which are not, as described in the “Diagram” section below.

Choosing a Key/Chord

The pattern is recorded in the key indicated by the Key/Chord pair of parameters. However, this parameter is only considered during playback of the Intro 1 and Ending 1 Style Elements. With Intro 1 and Ending 1 (both Chord Variation 1 and 2) you can also enter a chord progression. This is done with the lowest MIDI octave (C-1 ~ B-1). Chord types are inserted by using velocity, as shown in the following table:

Vel.	Chord Type	Vel.	Chord Type
1	Major	2	Major 6th
3	Major 7th	4	Major 7th flatted 5th
5	Suspended 4th	6	Suspended 2nd
7	Major 7th suspended 4th	8	Minor
9	Minor 6th	10	Minor 7th
11	Minor 7th flatted 5th	12	Minor major 7th
13	Dominant 7th	14	7th flatted 5th
15	7th suspended 4th	16	Dimished
17	Diminished major 7th	18	Augmented
19	Augmented 7th	20	Augmented major 7th
21	Major w/o 3rd	22	Major w/o 3rd and 5th
23	Flatted 5th	24	Diminished 7th

Playing back the pattern

When in Style Play mode, the recorded Guitar pattern is transposed according to the chord recognized on the keyboard. The way it is transposed depends on the programmed pattern, with the chosen positions, strumming mods, etc...

Guitar mode parameters

Here is a detailed description of the parameters of the Guitar Mode page.

Key/Chord

▶PAD

This parameter pair allows you to define the track’s original key and chord type. This parameter works in a different way, when compared to the other tracks. While with other tracks this is always the reference key used for NTT transposition, with Guitar tracks there is a difference, whether you are recording a Chord Variation contained in an Intro or Ending Style Element, or a different Chord Variation:

- With most Chord Variations, this chord will be used only for listening during recording. During playback in Style Play mode, the chord will follow chord recognition.
- With Intro and Ending Chord Variations 1 and 2, this chord will be used as the reference key for the chord progression.

Capo (0, 1...X)

▶PAD

A capo (from the Italian “capotasto”, “head of fingerboard”) is a movable bar attached to the fingerboard of the guitar, to uniformly raise the pitch of all the strings. Its use makes the strings shorter, therefore changing the timbre and position of the chords (but not its shape).

- 0 Open string – no capo.
- 1...X Position of the capo over the fingerboard (i.e., “1” corresponds to the first fret, “II” to the second one, and so on).

Diagram

The diagram shows how a chord would be composed on the fingerboard. Here is the meaning of the various symbols:

- Red dot Fingered string (i.e., played note).
- White dot Fifth, playing on the D#2 key.
- X Non played or muted note.
- Light grey bar Barré (a finger crossing all the strings, like a mobile capo).
- Dark grey bar Capo.

Pad Record procedure

Recording a Pad is very similar to recording a Style. Please see the relevant chapter in the User’s manual.

Edit menu

When pressing the MENU button while in Pad Record mode, the Pad Record Edit Menu will appear.

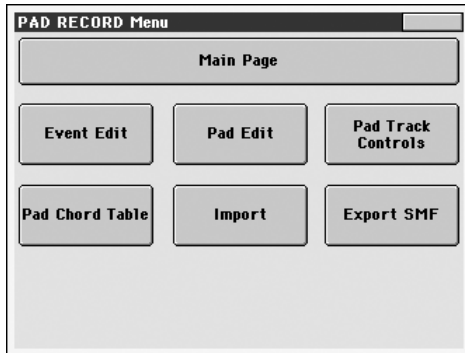

Note: The Pad Edit pages are a simplified version of the Style Edit pages. See the User's manual for information on the various parameters.

Note: While the Pad is in play, you cannot access the Edit section pages from the main page (see page 143). Stop the playback before pressing MENU.

Note: When switching from the Edit section pages (Quantize, Transpose, Velocity, Delete) to the other pages, or vice-versa, the Pad (if in play) is automatically stopped.

Edit page structure

Most edit pages share some basic elements.

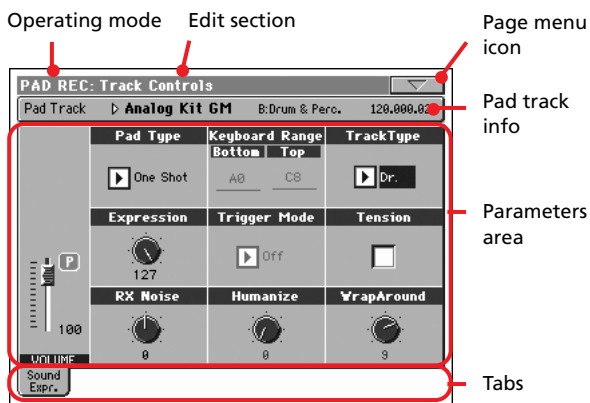

Other pages exhibit a slightly different structure.

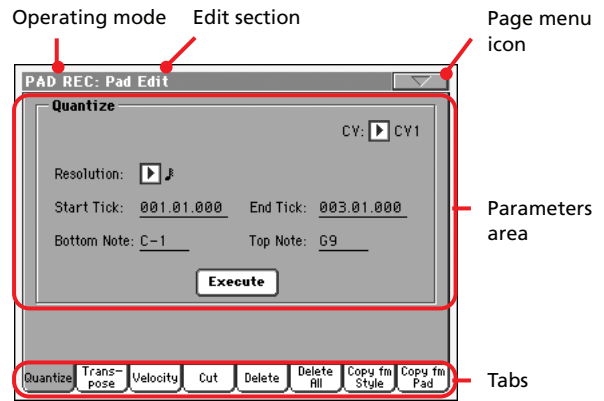

Operating mode

This indicates that the instrument is in Pad Record mode.

Edit section

This identifies the current edit section, corresponding to one of the items of the edit menu (see “Edit menu” on page 148).

Page menu icon

Touch this icon to open the page menu (see “Page menu” on page 155).

Parameters area

Each page contains various parameters. Use the tabs to select one of the available pages. For detailed information on the various types of parameters, see sections starting from page 148.

Tabs

Use tabs to select one of the edit pages of the current edit section.

Event Edit: Event Edit

The Event Edit is the page where you can edit each single MIDI event of the selected Chord Variation. You can, for example, replace a note with a different one, or change its playing strength (i.e., velocity value).

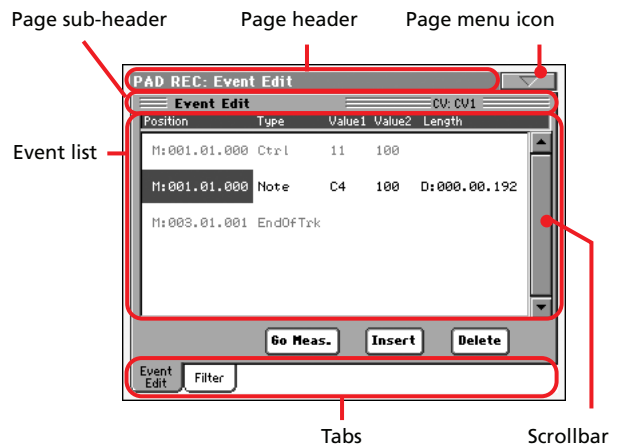

This is very similar to the Style Record's Event Edit page. See “Event Edit: Event Edit” on page 124 for more information on the event editing procedure.

Event Edit: Filter

This page is where you can select the event types to be shown in the Event Edit page.

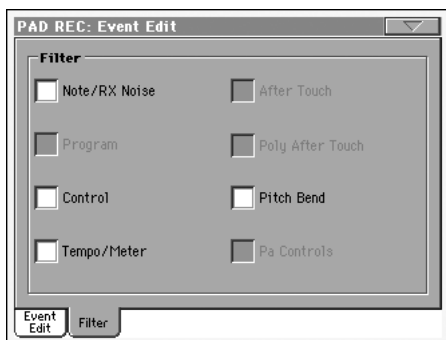

Turn On the filter for all event types you do not wish to see in the Event Edit page.

Note: Some of the events are “ghosted”, and non editable, since the corresponding events are not editable in a Pad.

This is very similar to the Style Record’s Event Edit Filter page. See “Event Edit: Filter” on page 126 for more information on the filter page.

Pad Edit: Quantize

The quantize function may be used to correct any timing mistake after recording, or to give the pattern a “groovy” feeling.

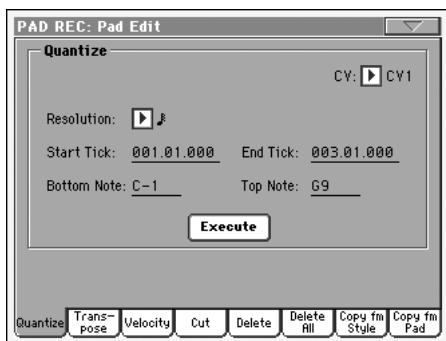

After setting the various parameters, touch Execute.

CV (Chord Variation)

Use this parameter to select the Chord Variation for editing.

Resolution

This parameter sets the quantization after recording.

Start / End Tick

Use these parameters to set the starting and ending points of the range to quantize.

Bottom / Top Note

Use these parameters to set the bottom and top of the keyboard range to quantize.

Execute

Touch this button to execute the operation set in this page.

Pad Edit: Transpose

In this page you can transpose the selected track(s).

Note: After transposing, please don’t forget to readjust the “Key/Chord” parameter in the main page of the Pad Record mode (see page 144).

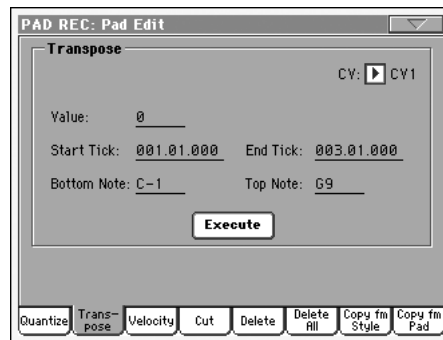

After setting the various parameters, touch Execute.

CV (Chord Variation)

Use this parameter to select the Chord Variation for editing.

Value

Transpose value (± 127 semitones).

Start / End Tick

Use these parameters to set the starting and ending points of the range to be transposed.

Bottom / Top Note

Use these parameters to set the bottom and top of the keyboard range to be transposed.

Execute

Touch this button to execute the operation set in this page.

Pad Edit: Velocity

In this page you can change the velocity (dynamics) value of notes in the selected track.

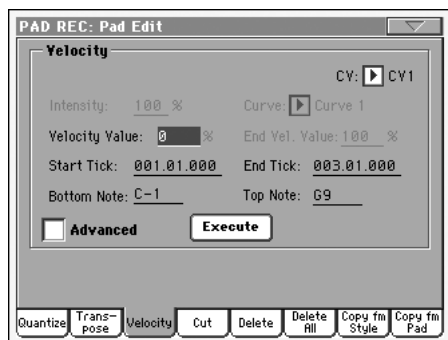

After setting the various parameters, touch Execute.

CV (Chord Variation)

Use this parameter to select the Chord Variation for editing.

Value

Velocity change value (± 127).

Intensity

(Only available in Advanced mode). Use this parameter to specify the degree to which the velocity data will be adjusted toward the curve you specify in “Curve”.

Curve

(Only available in Advanced mode). Use this parameter to select from six types of curve, and specify how the velocity will change over time.

Start / End Vel. Value

(Only available in Advanced mode). Velocity change at the starting and ending ticks of the selected range.

Start / End Tick

Use these parameters to set the starting and ending points of the range to be modified.

Bottom / Top Note

Use these parameters to set the bottom and top of the keyboard range to be modified.

Advanced

When this checkbox is checked, the “Intensity”, “Curve”, “Start Velocity Value” and “End Velocity Value” parameters can be edited.

Execute

Touch this button to execute the operation set in this page.

Pad Edit: Cut

This function lets you quickly delete a selected measure (or a series of measures) from the selected Chord Variation. All following events are moved back, to replace the cut measure(s).

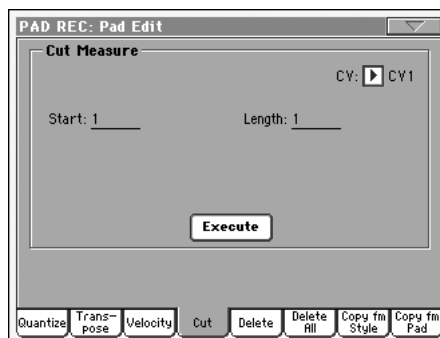

After setting the various parameters, touch Execute.

CV (Chord Variation)

Use this parameter to select the Chord Variation for editing.

Start

First measure to be cut.

Length

Number of measures to be cut.

Execute

Touch this button to execute the operation set in this page.

Pad Edit: Delete

This page is where you can delete MIDI events out of the Pad. This function does not remove measures from the pattern. To remove a whole measure, use the Cut function (see “Pad Edit: Cut” on page 150)



After setting the various parameters, touch Execute.

CV (Chord Variation)

Use this parameter to select the Chord Variation for editing.

Event

Type of MIDI event to delete.

All All events. The measures are not removed from the Chord Variation.

Note All notes in the selected range.

Dup.Note All duplicate notes. When two notes with the same pitch are encountered on the same tick, the one with the lowest velocity is deleted.

After Touch After Touch events.

Note: This kind of data is automatically removed during recording.

Pitch Bend Pitch Bend events.

Prog.Change Program Change events, excluding the bundled Control Change #00 (Bank Select MSB) and #32 (Bank Select LSB).

Note: This kind of data is automatically removed during recording.

Ctl.Change All Control Change events, for example Bank Select, Modulation, Damper, Soft Pedal...

CC00/32...CC127

Single Control Change events. Double Control Change numbers (like 00/32) are MSB/LSB bundles.

Note: Some CC data are automatically removed during recording. See the table on page 113 for more information on the allowed data.

Start / End Tick

Use these parameters to set the starting and ending points of the range to delete.

Bottom / Top Note

Use these parameters to set the bottom and top of the keyboard range to delete.

Note: These parameters are available only when the All or Note option is selected.

Execute

Touch this button to execute the operation set in this page.

Pad Edit: Delete All

This function lets you quickly delete a single Chord Variation, or the whole Pad.

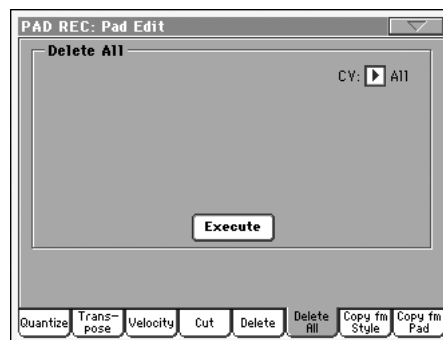

After setting the various parameters, touch Execute.

CV (Chord Variation)

Use this parameter to select the Chord Variation to be deleted.

All All Chord Variations, i.e. the whole Pad. After deletion, all parameters are set to the default status.

CV1...CV6 Single Chord Variation.

Execute

Touch this button to execute the operation set in this page.

Pad Edit: Copy from Style

Here you can copy a track from a Style, and transform it into a Pad pattern.

Warning: The Copy operation deletes all data at the target location (overwrite).

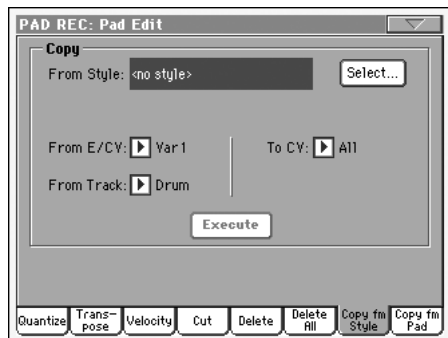

After setting the various parameters, touch Execute.

Note: If you copy too many events on the same “tick”, the “Too many events!” message appears, and the copy operation is aborted.

Note: When you copy over an existing Chord Variation, Program Change data is not copied, to leave the original Sounds unchanged for that Chord Variation.

From Style

Choose this option to select the source Style to copy the track from. Touch the **Select** button to open the Style Select window and select the source Style.

From E/CV (Style Element/Chord Variation)

Use this parameter to select the source Style Element and Chord Variation.

Var1...End2 A single Style Element, i.e., all Chord Variations.

V1-CV1...E2-CV2

A single Chord Variation.

From Track

Use this parameter to select the source track to copy.

Drum-Acc5 Single track of the selected Style Element or Chord Variation.

To CV (Chord Variation)

Use this parameter to select a target Chord Variation inside the current Pad.

CV1...CV6 Target Chord Variation.

Execute

Touch this button to execute the operation set in this page.

Pad Edit: Copy from Pad

Here you can copy a Chord Variation from a different Pad. Furthermore, you can copy a whole Pad.

Warning: The Copy operation deletes all data at the target location (overwrite).

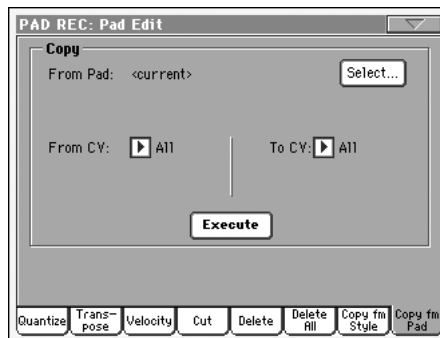

After setting the various parameters, touch Execute.

Note: If you copy too many events on the same “tick”, the “Too many events!” message appears, and the copy operation is aborted.

Note: When you copy over an existing Chord Variation, Program Change data is not copied, to leave the original Sounds unchanged for that Chord Variation.

From Pad

Choose this option to select the source Pad to copy the Chord Variation from. Touch the **Select** button to open the Pad Select window and select the source Pad.

From CV (Chord Variation)

Use this parameter to select the source Chord Variation.

All All Chord Variations, i.e. the whole Pad. You can't change the target, that is automatically set to All.

CV1...CV6 Single Chord Variation.

To CV (Chord Variation)

Use this parameter to select a target Chord Variation inside the current Pad.

CV1...CV6 Target Chord Variation. Automatically set to All if the “From CV” parameter is also set to All.

Execute

Touch this button to execute the operation set in this page.

Pad Track Controls: Sound/Expression

In this page you can assign a Sound to the Pad track, adjust its Volume (CC#07) and Expression (CC#11) values, and set various other parameters, like the Keyboard Range, Track Type, Trigger Mode, Tension and Wrap Around.



Sound/Bank ▶PAD

Sound assigned to the Pad track.

Pad Type ▶PAD

Use this parameter to decide if the Pad will play once or if it will loop.

Note: While in Pad Record mode, the pattern is always played back in loop, even if this parameter is set to “One Shot”.

One Shot When you press one of the PAD buttons, the corresponding Pad is only played once. This is useful for playing Hits or Sequences that must only play once.

Loop When you press one of the PAD buttons, the corresponding Pad plays up to the end, then continues playing from the start. Press STOP in the PAD section to stop it playing. This is useful for playing cyclic sequences.

Expression ▶PAD

Use this knob to set the Expression (CC#11) value for the Pad track. This value can be seen at the beginning of the Event Edit list.

The Expression is useful to balance the Pad with the other Pads. For example, if you want the Pad you are recording to be melower than the average, just lower the Expression value.

Volume

Use this slider to set the Volume (CC#07) value for the Pad track. This value is not saved with the Pad, and is only used to test the Pad’s volume during editing or recording.

Keyboard Range ▶PAD

The Keyboard Range automatically transposes any pattern note that would otherwise play too high or too low in pitch, compared to the original acoustic instrument, when transposed by the arranger. This will result in a more natural sound for the Pad instrument.

Note: The Keyboard Range is ignored while recording. The Pad track can play on the full range of the keyboard.

Trigger Mode ▶PAD

(Not available if Track Type = Drum). This setting lets you define how Bass and Acc-type tracks are retriggered when the chord is changed.

Off Each time you play a new chord, current notes will be stopped. The track will remain silent until a new note will be encountered in the pattern.

Rt (Retrigger) The sound will be stopped, and new notes matching the recognized chord will be played back.

Rp (Repitch) New notes matching the recognized chord will be played back, by repitching notes already playing. There will be no break in the sound. This is very useful on Guitar and Bass tracks.

Track Type ▶PAD

Use this parameter to set the type of the Pad track.

Drum Drum track. This type of track is not transposed by the arranger, and is used for Drum Kits, or for tracks that you don’t want to be transposed when playing a different chord.

Bass Bass track. This type of track always plays the root when changing chord.

Acc Accompaniment track. This type of track can be used freely, for melodic or harmonic accompaniment patterns.

Tension ▶PAD

Tension adds notes (a 9th, 11th and/or 13th) that have actually been played, even if they haven’t been written in the Pad pattern. This parameter specifies whether or not the Tension included in the recognized chord will be added to an Acc-type track.

On The Tension will be added.

Off No Tension will be added.

RX Noise ▶PAD

Use these controls to adjust the volume of RX Noises in the corresponding tracks. This control applies to all types of tracks (provided the Sound includes RX Noises).

Humanize GTR ▶PAD

Use these controls to apply a random value to the position, velocity and length of notes of Guitar tracks (see “Track Type” on page 153). This control has no effect on other types of track.

Wrap Around ▶PAD

The wrap-around point is the highest register limit for the Pad track. The Pad pattern will be transposed according to the detected chord. If the chord is too high, the Pad track might play in a register that is too high, and therefore unnatural. If, however, it reaches the wrap-around point, it will be automatically transposed an octave lower.

The wrap-around point can be individually set in semitone steps up to a maximum of 12 semitones, relative to the chord root set in the main page of the Pad Record mode (see “Key/Chord” on page 144).

1...12 Maximum transposition (in semitones) of the track, referred to the original key of the Pad pattern.

Pad Chord Table

This is the page where you can assign a Chord Variation to each of the most important recognized chord. When a chord is recognized, the assigned Chord Variation will be automatically selected by the arranger to play the Pad track.

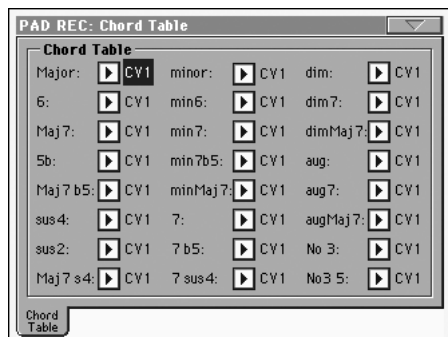

Chord / Chord Variation

►PAD

Use these parameters to assign a Chord Variation to each of the most important chords.

Import: Import Groove

The Import Groove function allows the loading of MIDI Grooves (".GRV" files) generated by the Slice function (see "Time Slice" in the Sampling mode). By importing these data to the Pad track, and assigning the Sound based on the sliced samples to the same track, you can play the original audio groove, and freely change its tempo.

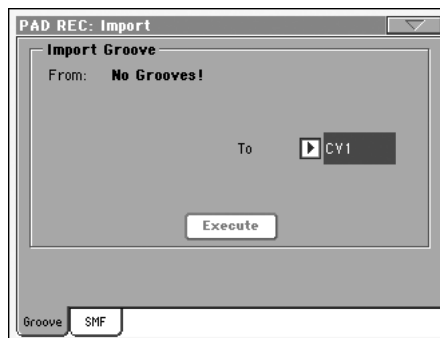

From

Use this parameter to select one of the MIDI Groove patterns (".GRV" files) generated when saving data after a Time Slice operation.

To CV (Chord Variation)

Use this parameter to select the target Chord Variation.

Import: Import SMF

The Import SMF function allows you to import MIDI data from a Standard MIDI File (SMF) created on your preferred external sequencer, and transform them in a Chord Variation.

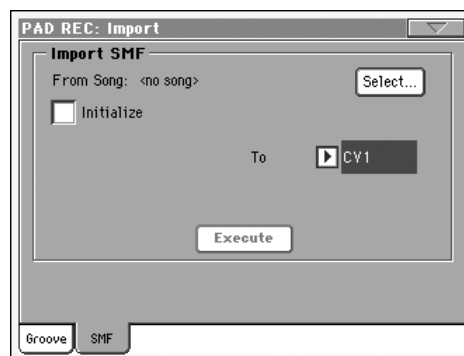

When programming a Chord Variation on the external sequencer, please assign the Pad track to the MIDI channel #10.

Note: Only SMF in format 0 can be loaded.

From Song

This is the name of the Standard MIDI File to be loaded. Touch the Select button to open the file selector, and select an ".SMF" file.

Select

Touch this button to open the file selector and load the SMF.

Initialize

Check this parameter if you want all Pad settings (i.e., Key/Chord, Chord Table, Sound...) are reset when loading the SMF.

Hint: It is a good idea to check this parameter when importing the first Chord Variation of the Pad, and uncheck it when importing the following Chord Variations.

To CV

Use this parameter to select a target Chord Variation.

Execute

After setting all parameters in this page, touch this button to import the Standard MIDI File into the target Chord Variation.

Export: SMF

The Export SMF function allows you to export a Chord Variation as a Standard MIDI File (SMF), and edit it on your preferred external sequencer.



To Song

This (non editable) parameters shows the name of the Standard MIDI File to be generated. The (automatically assigned) name will be the same of the exported Chord Variation.

From CV

Use this pop-up menu to select one of the available Chord Variations from the current Pad.

Execute

After selecting a Chord Variation, touch this button to export it as a Standard MIDI File. A standard file selector will appear. Select the target device and directory, then touch Save.

Page menu

Touch the page menu icon to open the page menu. Touch a command to select it. Touch anywhere in the display to close the menu without selecting a command.



Write Pad

When done recording or editing a Pad, and you want to save the changes, select this command to open the Write Pad dialog box, and save the Pad to the internal memory.

See “Write Pad dialog box” on page 156 for more information.

Undo

Only available in the Main page of the Pad Record mode, and in some Pad Edit pages. While in Record mode, cancels the latest recorded data and restores the previous situation. Selected a second time, it restores recorded data again (“Redo” function).

Delete Pad Track

Only available in the Main page of the Pad Record mode. Select this command to delete the Pad track.

Overdub Step Recording

Only available in the Main page of the Pad Record mode. Select this command to open the Overdub Step recording window (see the Style Record chapter in the User’s Manual for more information).

Exit from Record

Select this command to exit from Record without saving changes to the Pad.

Write Pad dialog box

Open this window by selecting the Write Pad item from the page menu. Here you can save the recorded or edited Pad to memory.

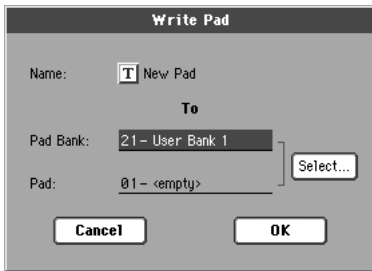

Parameters saved in the Pad are marked with the ▶PAD symbol through the user's manual.

Name ▶PAD

Name of the Pad to be saved. Touch the **T** (Text Edit) button next to the name to open the Text Edit window.

Pad Bank

Target Pad bank. Only User banks can be selected.

Pad

Target Pad location in the selected bank. Use TEMPO/VALUE controls to select a different location.

Note: A User Pad is usually prompted when writing a Pad. However, you can overwrite a Factory Pad, when the "Factory Style and Pad Protect" parameter is left unchecked (see page Media > Preferences).

Select... button

Touch this button to open the Pad Select window, and select a target location.

Song Play operating mode

The Song Play operating mode is where you can listen to Songs. Since the Pa800 is equipped with two onboard sequencers, you can play two Songs at the same time. This is very useful to mix between two Songs during a live performance. Songs can be in Standard MIDI File, Karaoke™ or MP3 (optionl) format.

You can play along with the Song with up to four Keyboard tracks (Upper 1-3, Lower). You can select different Sounds and Effects for Keyboard tracks by selecting Performances and STSs. A different Voice Processor Preset may be selected by a Performance or STS.

While in Song Play, you can use the SongBook to automatically select Songs for a desired music genre. With each Song entry in the SongBook, up to four STSs are associated.

Song Play mode can also be used in Easy Mode (see page 6).

Transport controls

You can use the separate transport controls for each of the two onboard sequencers. Use the SEQUENCER 1 controls for Sequencer 1, and SEQUENCER 2 controls for Sequencer 2. See “SEQUENCER 1 TRANSPORT CONTROLS” on page 14 for more information).

MIDI Clock

In Song Play mode the MIDI Clock is always generated by the internal sequencer, even if the Clock parameter is set to MIDI or USB (see “Clock Source” on page 224). While in this mode, Pa800 cannot receive MIDI Clock messages from the MIDI IN.

Pa800 transmits to the MIDI OUT and USB port only the MIDI Clock messages generated by Sequencer 1. For MIDI Clock messages to be sent, the “Clock Send” parameter must be activated (see “Clock Send” on page 224).

Tempo Lock and Link Mode

If you don't want the Tempo to change when selecting a new Song, turn on the TEMPO LOCK function. When the LED of this button is turned on, you can still manually change the Tempo with the DIAL.

When the Tempo Lock is activated, the Link Mode is also activated (see “Link Mode” on page 177). This makes both Sequencers use the same Tempo.

Master Volume, Balance, Sequencer Balance

While the MASTER VOLUME slider controls the general volume of the instrument, you can use the BALANCE slider (next to the MASTER VOLUME slider) to balance the Song tracks against the Keyboard and Pad tracks.

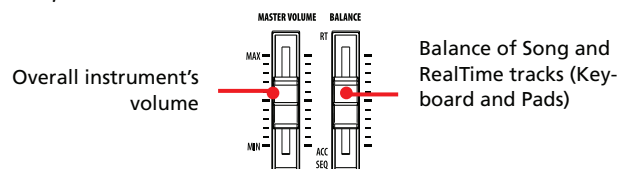

Use the SEQUENCER BALANCE slider to mix between Sequencer 1 and Sequencer 2. Move it to the center for the maximum volume of both sequencers.



Note: When this slider is fully moved to the right or the left, different Lyrics, Chords, Score and Markers can be shown, and a different Harmony Track can be selected.

Track parameters

Keyboard track settings made in Song Play mode may be saved to a Performance. You can then recall different settings by just selecting a single Performance.

Settings for Song tracks, like pan, volume and FX sends, depend on the midifile.

Changes to Song tracks made in Song Play mode cannot be saved to a midifile, and are only intended for realtime control. To permanently save changes to the various Song parameters, edit the midifile in Sequencer mode.

Standard MIDI Files and Sounds

The native Song file format of the Pa800 is the Standard MIDI File (SMF), an universal standard set by all manufacturers. You can read these files with any musical instrument or computer.

Differences may appear in sounds. If you recorded a Song on the Pa800 (Sequencer mode), using only General MIDI sounds, you can be confident you can play the same Song on virtually any other musical instrument or computer. If you used Korg native sounds, you cannot play back the same sounds on instruments from other manufacturers.

When you read SMFs in Song Play mode, there is no problem reading files made using only General MIDI sounds. Sounds could be different when playing a Song made on a different instrument: despite the wide compatibility of Pa800 with other non-standard formats, differences may arise.

If so, go to the Sequencer operating mode and load the SMF. Then, manually reassign the non-matching Sounds, replacing them with similar Sounds on the Pa800. Finally, save the SMF again, and you will be able to play it in Song Play mode with the correct Sounds.

NRPN Sound parameters

GM-compliant Standard MIDI Files can contain NRPN (#99, 98) Control Change messages. These messages are used to modify some Sound parameters before starting a Song. The following NRPN messages are recognized by the Pa800:

NRPN	CC#99 (MSB)	CC#98 (LSB)	CC#06 (Data Entry)
Vibrato Rate	1	8	0...127 ^(a)
Vibrato Depth	1	9	0...127 ^(a)
Vibrato Delay	1	10	0...127 ^(a)
Filter Cutoff	1	32	0...127 ^(a)
Resonance	1	33	0...127 ^(a)
EG Attack Time	1	99	0...127 ^(a)
EG Decay Time	1	100	0...127 ^(a)
EG Release Time	1	102	0...127 ^(a)
Drum Filter Cutoff	20	dd ^(b)	0...127 ^(a)
Drum Filter Resonance	21	dd ^(b)	0...127 ^(a)
Drum EG Attack Time	22	dd ^(b)	0...127 ^(a)
Drum EG Decay Time	23	dd ^(b)	0...127 ^(a)
Drum Coarse Tune	24	dd ^(b)	0...127 ^(a)
Drum Fine Tune	25	dd ^(b)	0...127 ^(a)
Drum Volume	26	dd ^(b)	0...127
Drum Panpot	28	dd ^(b)	0...127 ^(a)
Drum Rev Send (FX 1)	29	dd ^(b)	0...127 ^(a)
Drum Mod Send (FX 2)	30	dd ^(b)	0...127 ^(a)

(a). 64 = No change to the original parameter's value
 (b). dd = Drum Instrument No. 0...127 (C0...C8)

Note: These controls are reset when stopping the Song, or selecting a new Song.

Keyboard, Pad and Sequencer tracks

The Pa800 is equipped with a double sequencer. Each Song can play a maximum of 16 tracks, for a total of 32 sequencer tracks.

In addition, you can play the keyboard with four additional Keyboard tracks (Upper 1-3 and Lower). You can edit the Volume and Play/Mute status for these tracks on the main page of the Song Play mode (see illustration below).

While in Song Play mode, you can still select Performances or STSs from the latest selected Style. To select a different set of STSs, you must first select a different Style.

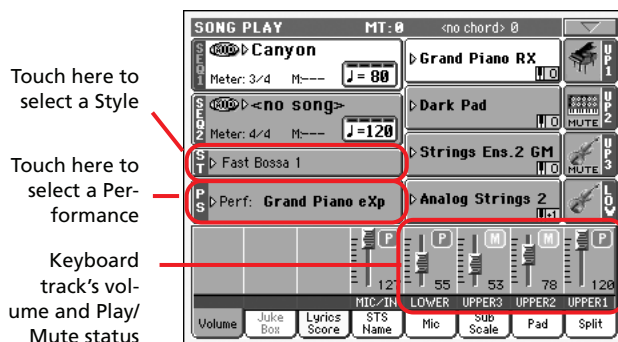

In addition to Keyboard tracks, selecting a different Style or SongBook entry may change sounds assigned to the PADS.

When you enter Song Play mode from the Style Play mode, Keyboard and Pad tracks are the same as in Style Play mode.

Main page

Press SONG PLAY to access this page from another operating mode.

Note: When switching from Style Play to Song Play, the Song Setup is automatically selected, and various track parameters and settings may change.

To return to this page from one of the Song Play edit pages, press the EXIT or SONG PLAY button.

To switch between Keyboard tracks (Normal view) and Song tracks (Song Tracks views), use the TRACK SELECT button. Pressed a first time, you will see tracks 1-8; a second press will show tracks 9-16; pressed again, you will go back to Keyboard tracks. (See “Song Tracks 1-8 and 9-16 pages” and “Volume panel” starting from page 161).

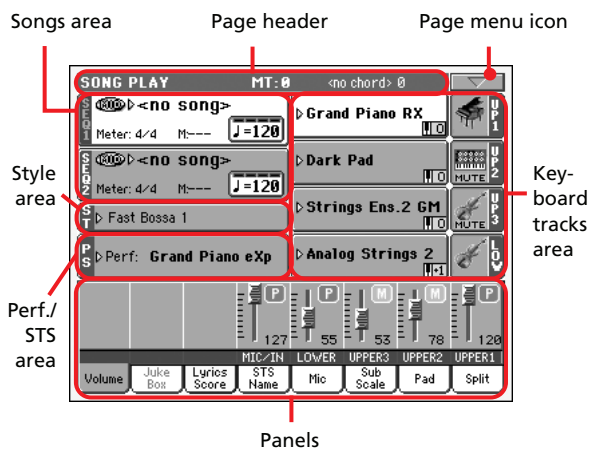

Page header

This line shows the current operating mode, transposition and recognized chord.

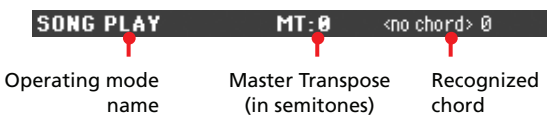

Operating mode name

Name of the current operating mode.

Master Transpose



Master Transpose value in semitones. This value can be changed using the TRANSPOSE buttons on the control panel.

Note: You can also transpose MP3 files. Keep in mind, however, that transposition is limited to the range -6...+5 semitones. This range is enough to cover all keys, but allows to avoid excessive audio degradation. Any further transposing will have no effect. So, you may see a +7 transpose value shown in the display, but the MP3 will still be limited to +5 semitones.

Note: Transpose may be automatically changed when selecting a different Performance. It may also be changed when loading a Standard MIDI File generated with an instrument of the Korg Pa series.

To avoid transposing, “lock” the Master Transpose parameter in the Global (see “General Controls: Lock” on page 218), then write the Global to memory (see “Write Global - Global Setup dialog box” on page 231).

Recognized chord

Displays the recognized chord, when you play a chord on the keyboard. If no chord abbreviation is shown, no chord recognition mode has been selected by using the CHORD SCANNING buttons (see page 15).

Page menu icon

Touch the page menu icon to open the menu. See “Page menu” on page 178 for more information.



Songs area

This is where Song names are shown, together with parameters depending on the selected type of Song.



This is how a Song’s area appears when a **Standard MIDI File** or **Karaoke** file has been selected:

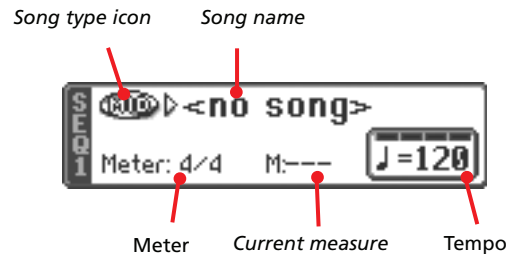

And this is how it appears when an **MP3 File** has been selected:

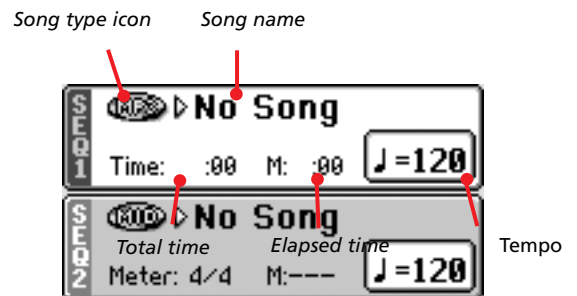

Seq. 1/2

A different Song may be assigned to each of the two onboard sequencers (Seq.1 and Seq.2). Each sequencer has its own parameters.

Song type icon

Songs of different types can be assigned to the sequencers. This icon shows the file type.



Standard MIDI File, often abbreviated as SMF (file extension: *.MID or *.KAR). The SMF (*.MID) is the industry standard song format, used by Pa800 as its basic Song format when recording a new Song. A MIDI Karaoke File (*.KAR) is an extension of the SMF format.



MPEG Layer-3 format, or MP3 (file extension: *.MP3) – available with the EXBP-Dual MP3 option installed. This is a compressed audio file, that may be generated on any personal computer, or on the Pa800 itself.



Only assignable to Sequencer 1. A Jukebox file (file extension: *.JBX) can be assigned to Sequencer 1, but its name is not shown in this area. The JBX icon appears, together with the name of the currently selected Song in the Jukebox list.

Note: To create or edit a Jukebox file, go to the Jukebox Edit page (see page 174).

Song name

Displays the name of the Song assigned to the corresponding sequencer.

- If the sequencer is already selected (white background), touch the Song name to open the Song Select window.
- If the sequencer is not selected (dark background), first select it, then touch the Song name to open the Song Select window.

When the Song Select window appears, you can select a single Song or a Jukebox file (see “Song Select window” on page 82).

If you select another Song while a Song is in play within the same Sequencer, the previous Song stops, and the new Song will be selected, ready to play.

To select a Song, an alternative is to press the SELECT button (on the control panel) corresponding to the desired sequencer. Press SELECT a second time to select a Song by dialing in its ID number (see “Selecting a Song by its ID number” on page 83).

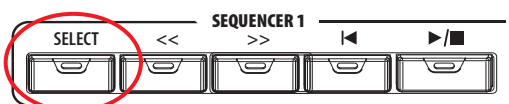

Meter

This parameter only appears when a Standard MIDI File or Karaoke file has been selected.

Current Song Time Signature.

Measure number

This parameter only appears when a Standard MIDI File or Karaoke file has been selected.

Current measure number.

Tempo

This parameter only appears when a Standard MIDI File or Karaoke file has been selected.

Metronome tempo. Select this parameter and use the TEMPO/VALUE controls to change the tempo. As an alternative, you don't need to select this parameter; just keep the SHIFT button

pressed and use the DIAL to change the tempo of the selected sequencer.

Hint: While in the main page, you can have the Tempo parameter of Sequencer 2 “on focus”, while Sequencer 1 is selected. In this situation, you can use the DIAL to change Tempo for Sequencer 2, and SHIFT + DIAL to change Tempo for Sequencer 1.

Total time

This parameter only appears when an MP3 file has been selected.

Total length (in minutes:seconds) of the selected MP3 file.

Elapsed time

This parameter only appears when an MP3 file has been selected.

Elapsed time (in minutes:seconds) of the MP3 file currently in play.

Tempo variation

This parameter only appears when an MP3 file has been selected.

Variation of the original MP3 file's tempo, inside a range of $\pm 30\%$ of the original tempo. When Tempo is changed, MP3 files are smoothly accelerated or slowed down (inside a range of $\pm 30\%$ of the original tempo). This may seem trivial, but it is really rocket-science instead, and is made possible by Korg sophisticated time-stretching algorithms.

Style area

Currently selected Style. You can select a Style while playing Songs, to have it ready when switching to Style Play mode. Also, this lets you change the Pad and STS settings (since Pads and STSs are recalled by a Style).

Touch the Style name to open the Style Select window. As an alternative, use the STYLE SELECT section on the control panel.



Selected Style

Performance/STS area

This is where the Performance or STS name is shown.

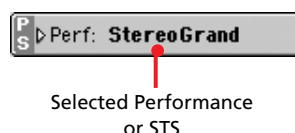

Selected Performance or STS

Selected Performance or STS

This is the latest selected Performance (PERF) or Single Touch Setting (STS).

Touch the name to open the Performance Select window. As an alternative, use the PERFORMANCE/SOUND SELECT section to select a different Performance.

To select a different STS from the latest selected Style, use the four SINGLE TOUCH SETTING buttons under the display.

Keyboard tracks area

This is where Keyboard tracks are shown.

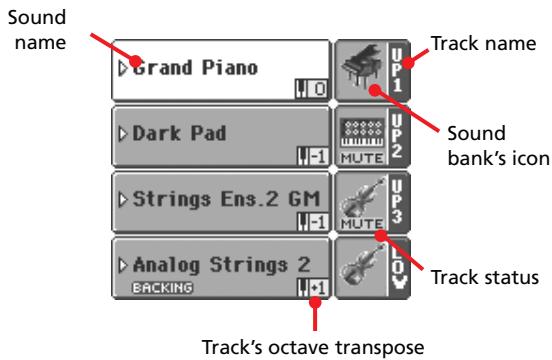

Sound name

▶PERF ▶STS

Name of the Sound assigned to the corresponding Keyboard track.

- If the track is already selected (white background), touch the Sound name to open the Sound Select window.
- If the track is not selected (dark background), first select it, then touch the Sound name to open the Sound Select window.

For more information about the Sound Select window, see “Sound Select window” on page 80.

Keyboard track octave transpose

▶PERF ▶STS

Non editable. Octave transpose of the corresponding track. To individually edit the octave transpose for each track, go to the “Mixer/Tuning: Tuning” edit page of the Song Play mode (see “Mixer/Tuning: Tuning” on page 96 for more details).

You can also transpose all Upper tracks by using the UPPER OCTAVE buttons on the control panel.

Keyboard track name

Non editable. Name of the corresponding track:

Abbreviation	Track	Hand
UP1	Upper 1	Right hand
UP2	Upper 2	
UP3	Upper 3	
LOW	Lower	Left hand

Sound bank's icon

▶PERF ▶STS

This picture illustrates the bank the current Sound belongs to.

Keyboard track status

▶PERF ▶STS

Play/mute status of the current track. Touch this icon to change the status.

No icon Play status. The track can be heard.

MUTE Mute status. The track cannot be heard.

Panels

The lower half of the main page contains the various panels, you can select by touching the corresponding tabs. See more information in the relevant sections, starting from page 162.

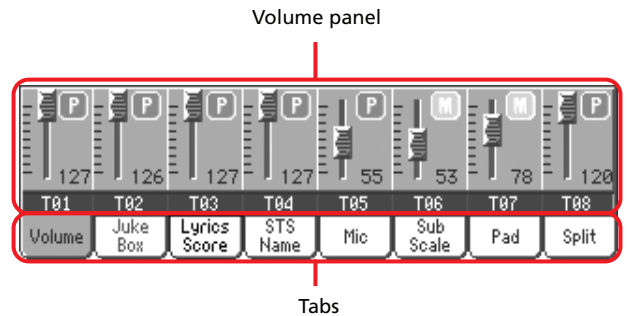

Song Tracks 1-8 and 9-16 pages

Repeatedly press the TRACK SELECT button to cycle between the Normal, Song Tracks 1-8 and Song Tracks 9-16 view. In Song Track views, the upper half of the main page changes, to show parameters for the Song tracks.

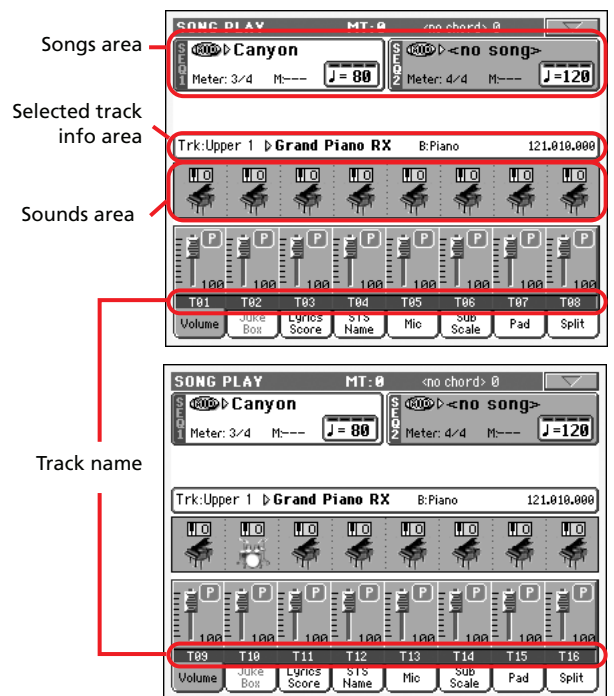

Press TRACK SELECT again to return to Normal view (Keyboard tracks). (See “Main page” on page 159).

Songs area

Despite a different layout, it works as the Song area in the Normal view.

Selected Track Info area

This line lets you see the Sound assigned to the selected track. Not only it is shown on the main page, but also in several edit pages.

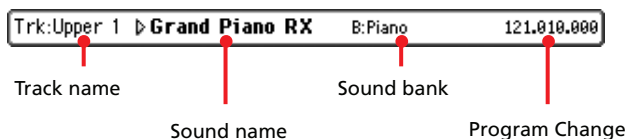

Track name

Name of the selected track.

Sound name

Sound assigned to the selected track. Touch anywhere in this area to open the Sound Select window, and select a different Sound.

Sound bank

Bank the selected Sound belongs to.

Program Change

Program Change number sequence (Bank Select MSB, Bank Select LSB, Program Change).

Sounds area

This area lets you see the octave transposition and Sound bank icon for the eight tracks currently displayed.

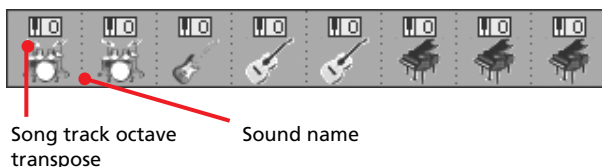

Song track octave transpose

Non editable. Octave transpose of the corresponding track. To edit the octave transpose, go to the “Mixer/Tuning: Tuning” edit page of the Song Play mode (see “Mixer/Tuning: Tuning” on page 96 for more details).

Sound bank's icon

This picture illustrates the bank the current Sound belongs to. Touch an icon a first time to select the corresponding track (detailed information are shown on the Selected Track Info area, see above). Touch it a second time to open the Sound Select window.

Volume panel

Touch the Volume tab to select this panel. This is where you can set the volume of each track, and mute/unmute tracks.

Use the TRACK SELECT button to switch from Normal (Keyboard and Mic/In tracks) to Song Tracks 1-8 and Song Tracks 9-16 views.

The **Normal view** shows Mic/In controls and Keyboard tracks:

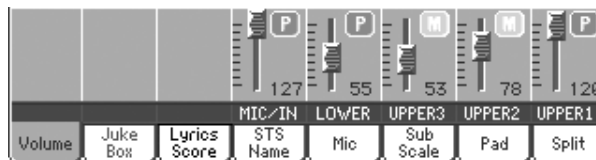

The **Song Tracks 1-8 view** shows individual Song tracks 1-8:

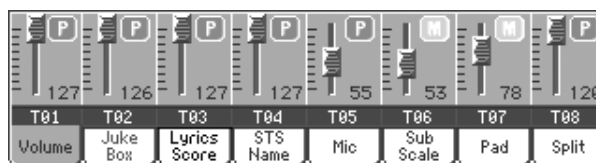

The **Song Tracks 9-16 view** shows individual Song tracks 9-16:

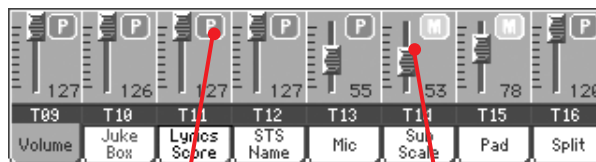

Track status icon

Virtual slider

Virtual sliders (track volume)

Virtual sliders are a graphical display of each track's volume. Touch the track's area to select a track, and use TEMPO/VALUE controls to change the value (or touch and drag it in the display).

The volume of Keyboard tracks may be saved to a Performance, while the Song track volume is not memorized.

Track status icons

▶PERF ▶STS ▶GBLSng

Play/mute status of the current track. Select the track, then touch this area to change the track status. The status of Keyboard tracks may be saved to a Performance or STS.

See “Keyboard track status” on page 161 for more information.



Play status. The track can be heard.



Mute status. The track cannot be heard.

Note: You can save this setting into the Global-Song Play Setup (by choosing the “Write Global-Song Play Setup” command from the page menu), to leave the track status unchanged when selecting a different Standard MIDI File. This way, you can leave, for example, the bass track in mute, and let your bassist play it live for the whole show.

However, the above is not true when reading a Standard MIDI File created with a Pa-Series instrument. These files do include special commands to force the Play/Mute status of each track.

Track names

Under the sliders, a label for each track is shown. Use the TRK. SEL button to switch between the various track views.

- MIC/IN Audio inputs. [*]
- UPPER1...3 Upper tracks.
- LOWER Lower track.
- T01...T16 Song tracks. [*]

[*] Volume for these tracks is not memorized.

Jukebox panel

When a Jukebox (JBX) file is assigned to Sequencer 1, you can use the list shown in this panel to browse the Jukebox list, and touch the Select button in the display to select a Song to play. This way, you can select any Song in the list as your starting Song, and manually change the order of the Songs to play.

Note: A Jukebox file can be assigned to Sequencer 1 only.

Note: This panel is only available after loading a Jukebox file.

Hint: To create or edit a Jukebox file, go to the Jukebox Edit page (see page 174). A quick way to create a Jukebox list is to touch the “Play All” button in the Song Select window (see page 83).

Warning: If you delete a Song included in the Jukebox list currently in play, the sequencer will stop, and the “No Song” message will appear. At this point, you can select the JukeBox tab to open the Jukebox panel, and select a different Song.

As an alternative, you can select the next Song by pressing SHIFT + >> (FAST FORWARD) in the SEQUENCER 1 section of the control panel, then press ►/■ (PLAY/STOP) in the SEQUENCER 1 section again.

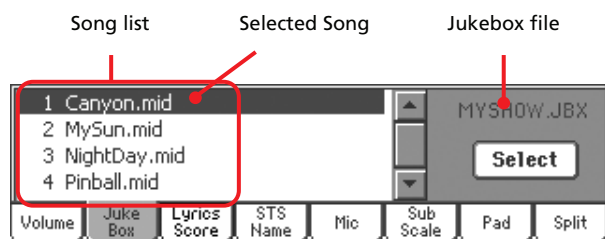

Song list

Use this list to browse through the Songs in the Jukebox list. Use the scrollbar to scroll the list.

Selected Song

Name of the Song currently in play. You can select a different Song from the list, and touch the Select button in the display to select it for playback.

Select button

Touch this button to select the Song highlighted in the list, and assign it to Sequencer 1. If a Song is already playing, it will be stopped, and the selected Song will start playing back.

Jukebox file

Name of the selected Jukebox file. To edit this file, see “Jukebox Editor” on page 174.

Transport controls for the Jukebox

When you select a Jukebox file, Sequencer 1 transport controls work in a slightly different way than with single Songs.

<< and >> Pressed alone, these buttons are the Rewind and Fast Forward commands.

SHIFT Keep the SHIFT button pressed, and press these buttons to scroll to the previous or next Song in the Jukebox list.

◀ (HOME) Returns to measure 1 of the current Song.

▶/■ (PLAY/STOP)

Starts or stops the current Song. When you stop the Song, it is stopped at the current position. Press HOME to go back to measure 1 of the current Song.

If the Jukebox panel is open, you can select the Song from which to start. See “Jukebox panel” above.

Lyrics / Score panel

Seq. Lyrics side tabs

These two panels show the lyrics and chord abbreviations. You can see the following types of lyrics and chords:

- lyrics contained in a Standard MIDI File or Karaoke™ file as Lyrics events, or in an MP3 with Lyrics file (in ID3 format – see www.id3.org).
- lyrics automatically loaded as a “.TXT” file with a Standard MIDI File, Karaoke™ or MP3 file. When a “.TXT” file exists in the same directory as a Standard MIDI File or MP3 file, and shares exactly the same name, it will be loaded with the “.MID” or “.MP3” file (see “Text files loaded with Standard MIDI Files and MP3 files” on page 164).
- lyrics contained in a “.TXT” file linked to the latest-selected Song-based SongBook entry (see “Linked .TXT” on page 184).
- when no lyrics data is contained in the Song, or linked to a SongBook entry, you can see lyrics contained in a “.TXT” file loaded after selecting a Song (see “On-the-fly TXT loading” below).

This is the priority of lyrics data shown in the display:

- TXT file linked to a SongBook entry, *overriding...*
- TXT file contained in the same folder as the Standard MIDI File or MP3 file, recalled by a SongBook entry, *overriding...*
- Lyrics events contained in the Standard MIDI File or MP3 file.

Lyrics will be shown only if they are compatible with a standard format that Pa800 can understand.

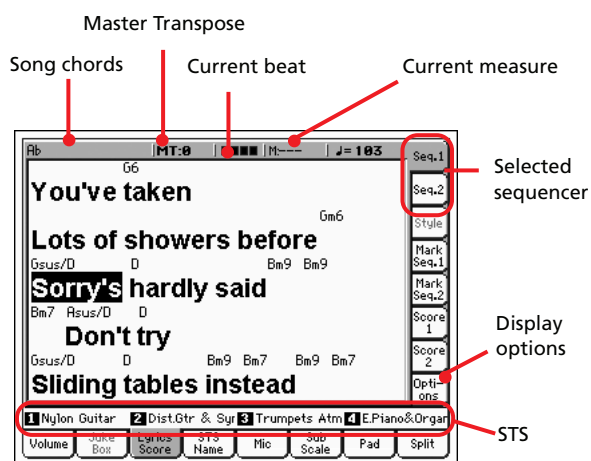

While the Song is playing, Lyrics contained in a Standard MIDI File or MP3 file flow in the display. Chord abbreviations (if any) will appear above the lyrics, in time with the music (depending on the “Show chords” parameter status, under the Options side tab). Lyrics at the current position are highlighted.

If the text has been loaded as a “.TXT” file, it will not scroll automatically while the Song is playing back. You must scroll it with the DIAL or the vertical scrollbar. As an alternative, you can use an assignable switch or footswitch, with the Text Page Up or Text Page Down functions assigned, to scroll (respectively) to the previous or next text page.

If both sequencers are playing, you can choose the Lyrics by moving the SEQUENCER BALANCE slider fully to the left (Seq 1) or to the right (Seq 2).

Song chords

Chords contained in the midfile (if any). This indicator may be easier to read than chords shown within the lyrics.

When changing the Master Transpose, chord abbreviations contained in a Standard MIDI File are transposed, and correctly shown in the display. Master Transpose must be activated on the Sequencer, but not on the Keyboard.

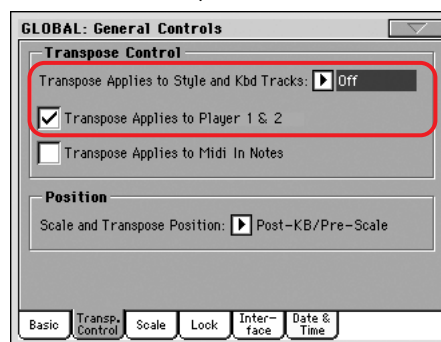

Master Transpose

Master transpose value in semitones. This value can be changed using the TRANSPOSE buttons on the control panel.

Current beat

Beat number of the current measure, that is currently playing.

Current measure

Current measure number.

Selected sequencer (SEQ 1/SEQ 2)

Use these side tabs to select a sequencer whose Song to show.

Note: You can have Sequencer 2 selected in the Main page of the Song Play mode, and Sequencer 1 selected in the Lyrics page, or vice-versa. This way, you can select a Song whose lyrics to display on the external video monitor, while selecting a different sequencer for editing operations.

STS

Name of the four selected Single Touch Settings (STS). Touch one of them to select it.

Text files loaded with Standard MIDI Files and MP3 files

When a “.TXT” file exists in the same directory as a Standard MIDI File or MP3 file, and shares exactly the same name, it will be loaded with the “.MID” or “.MP3” file, and can be seen in the Lyrics page.

As an example, if the file “MYSOING.TXT” exists in the same directory as the “MYSOING.MID” or “MYSOING.MP3” file, it is loaded together with the matching “.MID” or “.MP3” file.

However, unlike ordinary Lyrics, the text will not scroll automatically while the Song is playing back. You must scroll it with the DIAL. As an alternative, you can use an assignable switch or footswitch, with the Text Page Up or Text Page Down functions

assigned, to scroll (respectively) to the previous or next text page.

Note: When a “.TXT” file is loaded with the Song, it overrides any included Lyrics data.

On-the-fly TXT loading

When a Song does not contain any Lyrics metadata or has no “.TXT” file linked, the “No lyrics. Press SHIFT and touch here to load a TXT file” message appears in the display when you go to a Seq. Lyrics page.

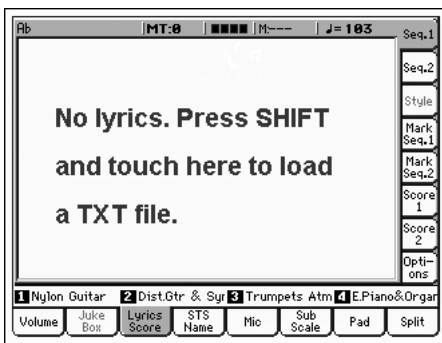

When this message appears, and you want to load a “.TXT” file, keep the SHIFT pressed and touch the center of the display. A standard file selector appears, and lets you look for “.TXT” file to be loaded while the current Song is playing.

Hint: When the file selector appears, you can use the Search (🔍) function to search a “.TXT” file in the various media. See “Searching files” on page 244 for more information.

Markers side tabs

Standard Song Markers contained in a midifile can be read with the Pa800, to quickly jump to a given position in the Song. Additionally, you can set your own marker points on-the-fly.

Touch one of these side tabs to access the Marker panel corresponding to one of the two sequencers.

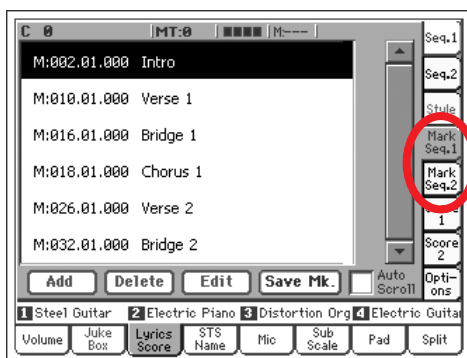

Note: Markers do not work when the Groove Quantize is activated.

Note: It is not advisable to program them with a Jukebox file assigned to Sequencer 1, since pressing PLAY/STOP would delete the markers.

How to add a marker:

1. Go to the Song Play > Mark Seq.1 (Seq.2) page.
2. Start the Song by pressing the SEQ.1 (SEQ.2) PLAY/STOP button (however, markers can be added even while the sequencer is not running).

3. When you reach the position you want to save as a marker, touch the Add button in the display.
 - If you touch Add within the first beats of the measure, the beginning of the current measure is saved as a marker.
 - If you touch Add within the last beat of the measure, the beginning of the following measure is saved as a marker.
4. Do the same for any following marker.
5. Stop the Song by pressing the SEQ.1 (SEQ.2) PLAY/STOP button.

How to jump to a saved marker:

1. Start the Song again.
2. When you want to jump to a saved marker, touch it in the display. The Song will jump to the saved position at the beginning of the next measure.

How to edit a marker:

1. Touch the marker to be edited in the display.
2. Touch the Edit button in the display to set the marker to edit. The Edit Marker window will appear.



3. While in Edit Marker window, you can edit the name and position of the marker being edited.

How to delete a marker:

1. Touch the marker to be deleted in the display.
2. Touch the Delete button in the display to delete the selected marker.

How to save the markers:

Touch the Save Mk button in the display to save all markers.

If you are not in the Lyrics/Score page, choose from the page menu the “Save Song Marker Seq.1” or “Save Song Marker Seq.2” (depending on the sequencer where you created the markers). The markers will be saved into the midifile.

Auto Scroll

Check this parameter if you want the current marker to be always visible in the display during playback, by making the list of markers scroll automatically.

Don’t check this parameter, if you prefer to prevent the list from scrolling. This is useful if you want a marker to remain in the display, ready to be selected as soon as you want to jump to its position, with no need to scroll the list to catch it out.

STS

Name of the four selected Single Touch Settings (STS). Touch one of them to select it.

Score side tabs

These tabs give access to the Score View pages. You can access them from the Lyrics / Score pane of the Song Play mode.



Touch here to see the score of the corresponding Song.

After having chosen either Song 1 or Song 2, the Score View page appears.

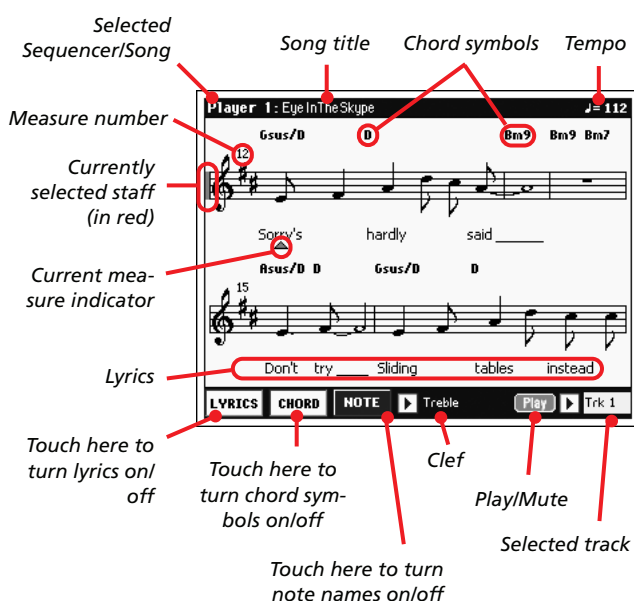

To exit from this page, press the EXIT button.

Note: Master or Track Transpose do not affect the Score display.

Selected Sequencer/Song

This is the name of the currently selected Sequencer (and Song). To select a different Sequencer, press the EXIT button to exit the Score View, and touch the tab corresponding to the other Sequencer.

When moving the SEQ-BALANCE, the shown score may change. When the SEQ-BALANCE is fully moved to the left, the score for Sequencer 1 is shown; when the SEQ-BALANCE is fully moved to the right, the score for Sequencer 2 is shown instead. (For this to happen, the “Lyrics/Score Balance Link” parameter in the Song Play > Preferences > General Control page must be checked, see page 177).

Song title

Name of the Song.

Tempo

Current Tempo of the Song (in BPM, Beats Per Minute).

Staff

The selected track is shown as traditional music notation. Depending on the content of the track, either notes or chords are shown. Pa800 takes care for you of ‘cleaning-up’ the score, so that it is always easy to read.

Several automatic operations are carried on to clean-up the score: Pa800 automatically quantizes to 1/16 notes, detects triplets, avoids note overlaps, understands syncopation, and draws beams according to the time signature. In addition, spacing and measure length are dynamic, and single, double and end measure bars are automatically added.

If a KeySign (Key Signature) event is found at position ‘001.01.000’ of the Song’s Master track, the correct key signature is also shown.

Currently selected staff marker

This red vertical line shows the approximate position of the playback, by indicating the current staff in play.

Current measure indicator

This red triangle shows the current measure in play.

Lyrics button

Touch this button to make the lyrics (if available) appear or disappear.

Chord button

Touch this button to make the chord symbols (if available) appear or disappear. Chords are shown either in the English or Italian system, depending on the selected Help language (see Global > Basic > Interface).

Note button

Touch this button to make the note name appear or disappear next to each note. Note names are shown either in the English or Italian system, depending on the selected Help language (see Global > Basic > Interface).

Clef

Touch here to open a pop-up menu, where to choose a clef from. Available clefs are:

- Treble Standard Treble clef (G₁).
- Treble+8 Treble clef with transposition one octave upper.
- Treble-8 Treble clef with transposition one octave lower.
- Bass Standard Bass clef (F₁).
- Bass-8 Bass clef with transposition one octave lower.

Play/Mute

Use this button to let the selected track play, or to mute it. If the track is muted, the score is still shown, so that you can play or sing it.

Hint: The “Melody Mute” function, that can be assigned to an assignable switch, footswitch or EC5 pedal, allows for muting the melody track of a Song (default: Track 4, see Song Play > Preferences > Track Setting > Melody). If your song has the melody part assigned to the same track, you can mute or unmute it by using this button, or the assigned switch/pedal.

Selected track

Touch here to open a pop-up menu where to chose the track to be shown from.

Hint: The vocals part is often assigned to Track 4.

Options side tab

Touch this side tab to access the Options panel, and adjust the various video settings (see details below).

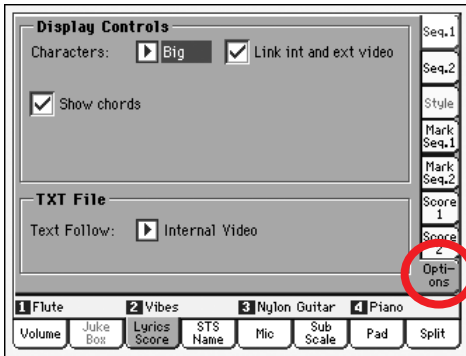

Display Controls

Use these parameters to define how lyrics are shown in the display. To set the external display, see “External Display” on page 230.

Characters

►GBL^{Sng}

Size of fonts. You can choose between a smaller and a bigger font.

Link int and ext video

►GBL^{Sng}

When checked, settings for the internal display are automatically mirrored to the external video monitor.

Show chords

►GBL^{Sng}

If this parameter is checked, chords are shown above lyrics in the display – provided the midifile contains them.

TXT File

Text Follow

►GBL^{Sng}

When linking a “.TXT” file to a Song, you scroll the text by using the Text Down and Text Up assignable commands. Unlike the reading of Lyrics events contained in a Standard MIDI File or MP3 file, there is no automatic scrolling, that makes the current verse start on top of the internal and the external display at the same time.

Therefore, text shown in the internal display and in the external video might begin with a different verse. This parameter lets you choose the internal or the external display as the one that must be perfectly lined.

Internal Video

When pressing the control corresponding to the Text Down command, the first line of the current page of text is shown on top of the internal video. The external video might not be perfectly lined. Choose this option if you are reading verses from the internal display.

External Video

When pressing the control corresponding to the Text Down command, the first line of the current page of text is shown on top of the external video. The internal video might not be perfectly lined. Choose this option is your audience is reading verses from an external video.

Note: When this option is selected, the text scrollbar disappears from the internal display.

Playing the keyboard while reading chords

When playing the keyboard while a Song is running, if you want to play the keyboard in C while seeing the original chords in the display, set to Off the “Transpose applies to Style and Kbd tracks...” parameter, and check the “Transpose applies to Sequencer 1/2” parameter (see page 217).

STS Name panel

Select this panel to see the name of the four available STSs. See “STS Name panel” on page 90 for details.

Mic panel

Select this panel to set parameters for the microphone input. See “Mic panel” on page 91 for details.

Sub-Scale panel

Select this panel to select a secondary scale for the Keyboard tracks. See “Mixer/Tuning: Sub Scale” on page 96 for details.

Pad panel

Select this panel to see which Hit or Sequence Pads are assigned to the four Pads. See “Pad panel” on page 92 for details.

Split panel

Select this panel to adjust the split point for the Keyboard tracks. See “Split panel” on page 92 for details.

Edit menu

From any page, press the MENU button to open the Song Play edit menu. This menu gives access to the various Song Play edit sections for the currently selected sequencer (see “Songs area” on page 161).

When in the menu, select an edit section, or press EXIT or SONG PLAY to exit the menu.

When in an edit page, press the EXIT or SONG PLAY button to go back to the main page of the Song Play operating mode.

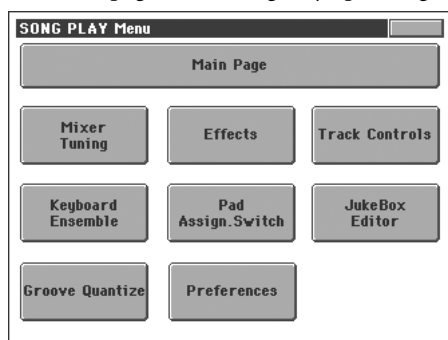

Each item in this menu corresponds to an edit section. Each edit section groups various edit pages, that may be selected by touching the corresponding tab on the lower part of the display.

Note: Some of the edit parameters are only meant for realtime. To see which parameters are saved in the Performance, STS or Global-Song Play Setup and which are not, see the “Parameters” chapter on page 344.

As a general rule, Keyboard track parameters can be saved in a Performance or SongBook STS, while Song track parameters could be saved in the Global-Song Play Setup.

Edit page structure

All edit pages share some basic elements.

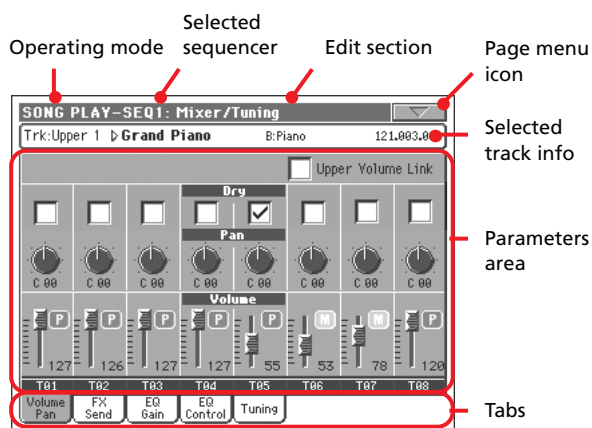

Operating mode

This indicates that the instrument is in Song Play mode.

Selected sequencer

Before entering edit, select one of the two sequencers, by using the Song area of the main page (see “Switching between sequencers during editing” below).

Edit section

This identifies the current edit section, corresponding to one of the items of the edit menu (see “Edit menu” on page 168).

Page menu icon

Touch this icon to open the page menu (see “Page menu” on page 178).

Parameters area

Each page contains various parameters. Use the tabs to select one of the pages. For detailed information on the various types of parameters, see sections starting from page 169.

Tabs

Use tabs to select one of the edit pages of the current edit section.

Switching between sequencers during editing

When you enter Edit mode, you can edit the selected sequencer’s parameters. The selected sequencer is always shown on the page header.



To select a sequencer, go to the main page of the Song Play mode, and select the sequencers you wish to edit. The selected sequencer is shown with a white background.



Mixer/Tuning: Volume/Pan

This page lets you set the volume and pan for each of the Keyboard or Song tracks.

Note: Song parameters cannot be saved when saving to a Performance or STS.

Note: A muted track may be reset when selecting a different Song.

Use the TRACK SELECT button to switch from the Keyboard to the Song tracks, and vice versa.

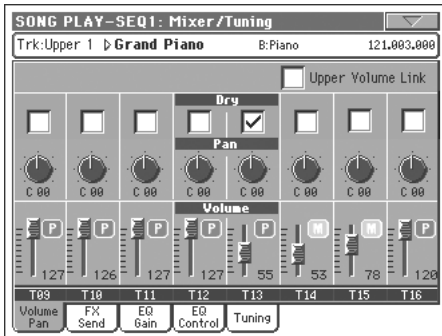
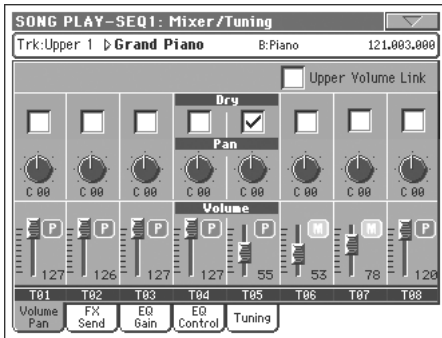
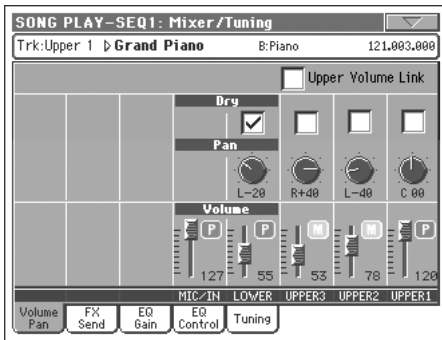

Upper Volume Link

►GBL^{Sty}

This parameter allows you to define if changing the volume for one of the Upper tracks, proportionally changes also the volume for the other Upper tracks.

To save this parameter status, go to the Style Play mode, then select the Write Global-Style Play Setup from the page menu (see “Write Global-Style Play Setup dialog box” on page 110).

Note: This parameter is the same you can find in the “Preferences: Style Play Setup” page of the Style Play mode (see page 107).

On When changing volume to one of the Upper tracks, volume for the other Upper tracks changes in proportion.

Off When changing volume to one of the Upper tracks, only that track’s volume is changed. Other Upper tracks are left unchanged.

Dry

►PERF ►STS

Use this checkbox to turn the dry (direct) track signal on or off.

Note: If the track is sent to a separate output, no FX is sent to any output. To program the output status for each track, see “Audio Setup: Seq1” and “Audio Setup: Seq2” on page 227.

On When checked, the direct, dry signal is sent to the output, mixed with the FXs.

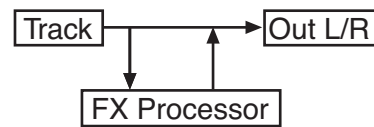

Off When unchecked, the direct, dry signal is removed from the audio output, and only sent to the FXs. The effected signal will still be panned (in stereo FXs only) according to the Pan value.

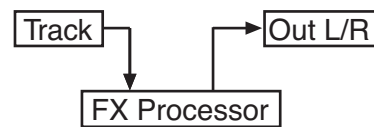

Pan

►PERF ►STS

Track position in the stereo field.

-64...-1 Left stereo channel.

0 Center.

+1...+63 Right stereo channel.

Volume

►PERF ►STS

Track’s volume.

0...127 MIDI value of the track’s volume.

Play/Mute icon

►PERF ►STS ►GBL^{Sty}

Track’s play/mute status. See “Keyboard track status” on page 161 for more information.

 Play status. The track can be heard.

 Mute status. The track cannot be heard.

Mixer/Tuning: FX Send

This page lets you set the level of the track's direct (unaffected) signal going to the Internal FX processors.

Note: Song parameters cannot be saved when saving to a Performance or STS.

The effect processors included in Pa800 are connected in parallel, so you can decide which percentage of the direct signal can be effected:

In case you want to send all of a track's signal to the effect (as when using "insert" effects, like Rotary, Distortion, EQ...), just set the Dry parameter to Off (see "Dry" above):

There are four Internal FX processors in Song Play mode. Usually, they are arranged as follows:

- FX A Reverb processor for Sequencer 1 and 2.
- FX B Modulating FX processor for Sequencer 1 and 2.
- FX C Reverb processor for Keyboard tracks.
- FX D Modulating FX processor for Keyboard tracks.

Depending on the status of the "Seq.2 FX Mode" parameter, Sequencer 2 might use the C/D effect pair (see page 177).

Furthermore, in Sequencer mode you can create Songs using all four effects (see "Effects: FX Select" on page 204).

Use the TRACK SELECT button to switch from Keyboard to Song tracks, and vice-versa.

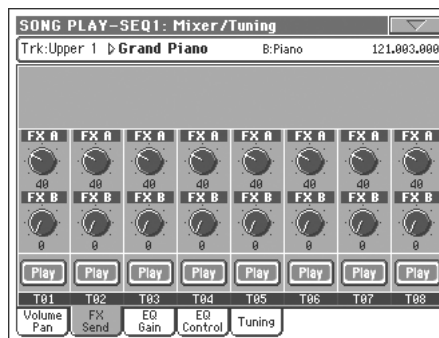

Note: When you stop, then start the Song again, or select a different Song, the default Song track settings are selected again. You can, however, pause the Song, change the effects, then exit from pause and start the Song again. Edit the Song in Sequencer mode to permanently change the effects.

Send level (A...D) ▶PERF ▶STS

0...127 Level of the track (direct) signal sent to the effect processor.

Play/Mute icon ▶PERF ▶STS ▶GBL^{Sng}

Track's play/mute status. See "Keyboard track status" on page 161 for more information.



Play status. The track can be heard.



Mute status. The track cannot be heard.

Mixer/Tuning: EQ Gain

In this page you can set the three-band equalization (EQ) for each individual track.

Use the TRACK SELECT button to switch from the Keyboard to the Song tracks, and vice-versa.

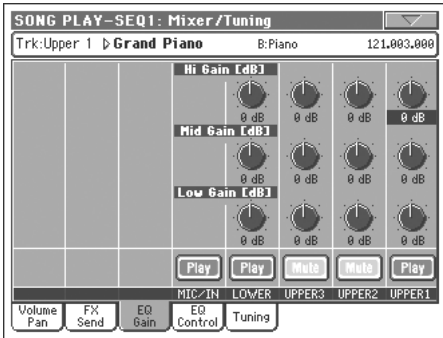

Note: The EQ is different for Sequencer 1 and Sequencer 2.

Hint: Track EQ can be memorized in the general preferences for the Song Play mode (they are named Song Play–Global Setup). This will help adapting the Pa800's sound to personal taste for any MIDI file you will ever play. Need a lighter Bass track? Save the right equalization, and the Bass will stay light with all the subsequent Songs.

Hi (High) Gain

▶PERF ▶STS ▶GBLSng

This parameter lets you adjust the high frequencies equalization on each individual track. This is a shelving curve filter. Values are shown in decibels (dB).

Mid (Middle) Gain

▶PERF ▶STS ▶GBLSng

This parameter lets you adjust the middle frequencies equalization on each individual track. This is a bell curve filter. Values are shown in decibels (dB).

Low Gain

▶PERF ▶STS ▶GBLSng

This parameter lets you adjust the low frequencies equalization on each individual track. This is a shelving curve filter. Values are shown in decibels (dB).

Play/Mute icon

▶PERF ▶STS ▶GBLSng

Track's play/mute status. See “Keyboard track status” on page 161 for more information.



Play status. The track can be heard.



Mute status. The track cannot be heard.

Mixer/Tuning: EQ Control

This page lets you reset or bypass track equalization, programmed in the previous page.

Use the TRACK SELECT button to switch from the Keyboard to the Song tracks, and vice-versa.

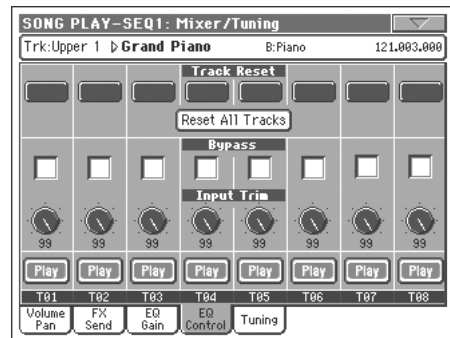
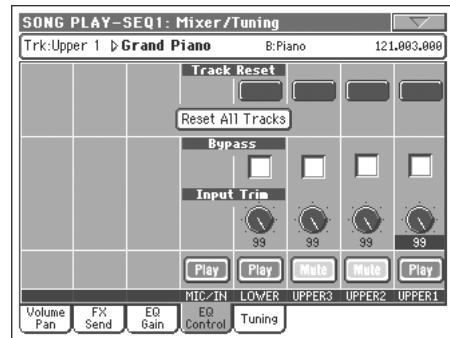

Track Reset buttons

Use these buttons to reset (i.e., “flatten”) equalization for the corresponding track.

Reset All Tracks button

Touch this button to reset (i.e., “flatten”) equalization for all tracks.

Bypass ▶PERF ▶STS

Check any of these checkboxes to bypass equalization for the corresponding track. When bypassed, equalization has no effect on the track, but all parameters are preserved. When the box is unchecked, equalization is activated again with the original settings.

Input Trim ▶PERF ▶STS

This knob allows you to limit the level of the signal passing through the equalizer. Extreme equalization values can overload the audio circuits and lead to distortion. This control lets you set equalization as desired, and at the same time avoid overloading.

Play/Mute icon ▶PERF ▶STS ▶GBL^{Sng}

Track’s play/mute status. See “Keyboard track status” on page 161 for more information.

 Play status. The track can be heard.

 Mute status. The track cannot be heard.

Mixer/Tuning: Tuning

Parameters in this page let you set various tuning settings. See “Mixer/Tuning: Tuning” on page 96 for details.

Parameters ▶PERF ▶STS

Note: Song track values edited in this page are not saved, and are only intended for realtime use.

Effects: FX Select

This page allows you to select effects to be assigned to the four Internal FX processors (A-D).

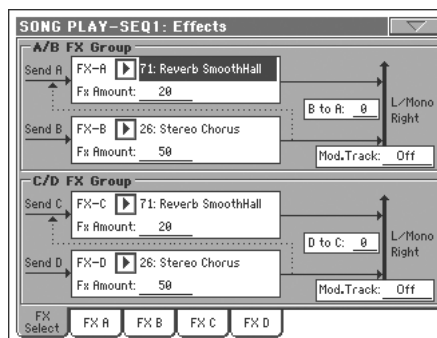

Note: When you stop the Song, or select a different Song, the default effects are selected again. You can, however, stop the Song, change the effects, then start the Song again with the new effects. Edit the Song in Sequencer mode to permanently change the effects.

Note: The default effect settings can be memorized in the Global-Song Play Setup, by choosing the “Write Global-Song Play Setup” command from the page menu (see page 178).

FX A...D ▶PERF ▶STS ▶GBL^{Sng}

Effects assigned to the corresponding effect processors. Usually, A and C are reverbs, while B and D are modulating effects (chorus, flanger, delay...). For a list of the available effects, see the “Advanced Edit” addendum in the Accessory CD.

FX Amount ▶PERF ▶STS ▶GBL^{Sng}

Volume of the effect, that is added to the dry (unaffected) signal.

B to A, D to C ▶PERF ▶STS ▶GBL^{Sng}

Amount of the B effect going back to the input of the A effect, or of the D effect going back to the input of the C effect.

Mod.Track (Modulating Track) ▶PERF ▶GBL^{Sng}

Source track for modulating MIDI messages. You can modulate an effect parameter with a MIDI message generated by a physical controller or a Song track.

Effects in Song Play mode

Pa800 is equipped with four effect processors, or DSPs (Digital Signal Processors), to process MIDI tracks. In Song Play mode you can have two or four effects at the same time, depending on the midifile you are reading.

Effects A and B are usually reserved to both sequencers and Pads, while effects C and D are usually reserved to Keyboard tracks.

Depending on the status of the “Seq.2 FX Mode” parameter, each effect pair could be reserved to a different Sequencer (see page 177).

You can also create Songs that make use of all four effects in Sequencer mode.

- A Song created on the Pa800 (in Sequencer mode) can use up to 4 effects (usually 2 reverbs + 2 modulating effects); each track may use the A/B or C/D pair.
- A Standard MIDI File or Karaoke™ file will only use 2 effects (usually 1 reverb + 1 modulating effect). This lets you use the remaining 2 effects for the Realtime tracks.
- When using both sequencers at the same time, and the “Seq.2 FX Mode” is set to “AB” mode (see page 177), they only use the A/B pair, while the C/D pair is reserved to the Keyboard tracks.
- When using both sequencers at the same time, and the “Seq.2 FX Mode” is set to “CD” mode (see page 177), Sequencer 1 uses the A/B pair, while Sequencer 2 uses the C/D pair, sharing it with Keyboard tracks.

Effects: FX A...D

These pages contain the editing parameters for the four effect processors. Here is an example of the FX A page, with the Reverb Smooth Hall effect assigned.

Selected effect

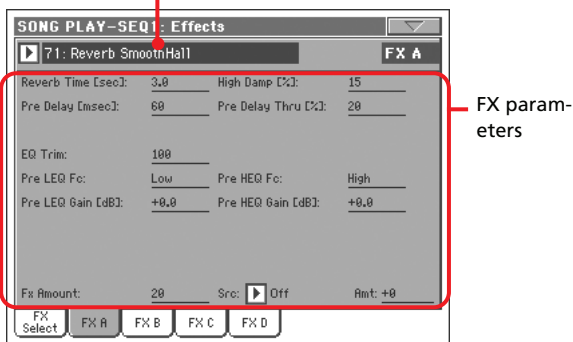

FX parameters

Selected effect ▶PERF ▶STS ▶GBL^{Sng}

Select one of the available effects from this pop-up menu. This is the same as the “FX A...D” parameters found in the “Effects: FX Select” page (see above).

FX parameters ▶PERF ▶STS ▶GBL^{Sng}

Parameters may differ, depending on the selected effect. See the “Advanced Edit” addendum in the Accessory CD for a list of available parameters for each effect type.

FX Amount ▶PERF ▶STS ▶GBL^{Sng}

Volume of the effect, that is added to the dry (unaffected) signal.

Src (Source) ▶PERF ▶STS ▶GBL^{Sng}

Modulation source. To select the track generating this message, see the “Mod.Track (Modulating Track)” parameters found in the “Effects: FX Select” page (see above). For a list of modulation sources, see the “Advanced Edit” addendum in the Accessory CD.

Track Controls: Mode

These parameters let you set the Internal/External, and the Poly/Mono status of Song tracks. See “Track Controls: Mode” on page 99.

Parameters ▶PERF ▶STS ▶GBL^{Sng}

Note: These parameters can be saved to the Global-Song Play Setup, by selecting the Write Global-Song Play Setup command from the page menu.

Track Controls: Drum Volume

These parameters let you adjust the volume for each percussive instrument family. See “Track Controls: Drum Volume” on page 173.

Parameters ▶PERF ▶STS

Note: Song track values edited in this page are not saved, and are only intended for realtime use.

Track Controls: Easy Edit

These parameters let you “fine-tune” edit parameters for Sounds assigned to the tracks. See “Track Controls: Easy Edit” on page 101.

Parameters ▶PERF ▶STS

Note: Song track values edited in this page are not saved, and are only intended for realtime use.

Keyboard/Ensemble: Keyboard Control

These parameters let you set parameters for the Keyboard tracks. See “Keyboard/Ensemble: Keyboard Control” on page 102.

Parameters ▶PERF ▶STS

Keyboard/Ensemble: Key/Velocity Range

These parameters let you select a note and velocity range for the Keyboard tracks. See “Keyboard/Ensemble: Key/Velocity Range” on page 102.

Parameters ▶PERF ▶STS

Keyboard/Ensemble: Ensemble

See “Keyboard/Ensemble: Ensemble” on page 103.

Parameters ▶PERF ▶STS

Pad/Switch: Pad

See “Pad/Switch: Pad” on page 105.

Parameters ▶PERF ▶STS

Pad/Switch: Assignable Switch

See “Pad/Switch: Assignable Switch” on page 105.

Parameters ▶PERF ▶STS

Jukebox Editor

The Jukebox function lets you play a list of Songs (127 max), at the simple touch of a button. You can play a Jukebox file by assigning it to Sequencer 1, after having selected it in the Song Select page, just as if it was an ordinary Song (see “Jukebox panel” on page 163).



In this page, you can create, edit and save a Jukebox file. A Jukebox list can contain Standard MIDI Files, Karaoke™ files, and MP3 files. (Note: MP3 files are only supported with the EXBP-Dual MP3 option installed).

If a Jukebox file is already selected into a Sequencer, you will enter this page with that file ready to be edited. Otherwise, you will enter this page with an empty list.

To create a new Jukebox file, touch Del All to remove all Songs from the current list. Add new Songs, then touch Save and enter a different name before confirming. A new Jukebox file will be saved to disk.

Move Up/Down

Use these button to move the selected item up or down in the list.

Add

Adds a Song at the end of the current list. You can add up to 127 Songs in a list.

Note: A Jukebox list can include only Songs contained in the same folder.

Hint: Instead of a single Song, you can select a Jukebox file, and add its whole content to the current Jukebox list.

Insert

Inserts a Song at the current position (i.e., between the selected item and the preceding one). All subsequent Songs are moved to the next higher-numbered slot. You can add up to 127 Songs in a list.

Note: A Jukebox list can include only Songs contained in the same folder.

Hint: Instead of a single Song, you can select a Jukebox file, and insert its whole content to the current Jukebox list.

Delete

This command lets you delete the selected Song from the list.

Del All

Select this command to delete the whole Jukebox list.

Save

Touch this button to save the Jukebox file to disk. The Save Jukebox File dialog box appears, allowing you to edit the name and save your file to disk.

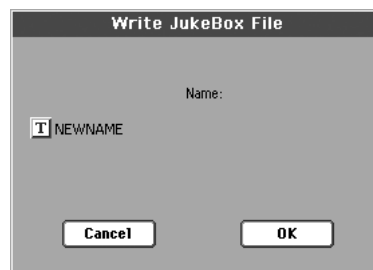

Touch the **T** (Text Edit) button to open the Text Edit window, and edit the name.

If you are editing an existing list, and do not change its name, the old file is overwritten. If you change it, a new file will be created on disk.

If you are saving a new list, the “NEWNAME.JBX” name is automatically assigned, and you can edit it.

Note: You can save your “.JBX” file only in the same folder as the Song files included in the list.

Groove Quantize

You can apply a realtime “groove-quantization” to Sequencer 1. Groove-quantization is a way of changing the music groove during the playback, moving notes to the nearest axis of a rhythmic “grid”. Please feel free to experiment: this function is a great source of musical inspiration.

To enable groove quantize, you can either use the command in this page, or check the Groove Quantize Enable command in the page menu.



Note: Groove Quantize parameters are not saved, as they are only intended for realtime use.

Enable

Enables/disables quantization. It is automatically set to Off each time the instrument is turned on, or when selecting a different Song.

Hint: You can enable/disable the Groove Quantize also by selecting the “Seq.1-Groove Quantize Enable” command from the page menu.

Note Start

Enables/disables quantization of the Note On event (i.e. beginning of the note).

Note Duration

Enables/disables quantization of the Note Off event (i.e. the length of the note).

Resolution

Coarse quantize grid resolution. This parameter is the main quantization value, to be varied with the Acc, Swing and Window values.

♪ (1/32)...♪ (1/4)

Grid resolution, in musical values (a “3” after the value means “triplet”). For example, when you select 1/8, all notes are moved to the nearest 1/8

division. When you select 1/4, all notes are moved to the nearest 1/4 division.

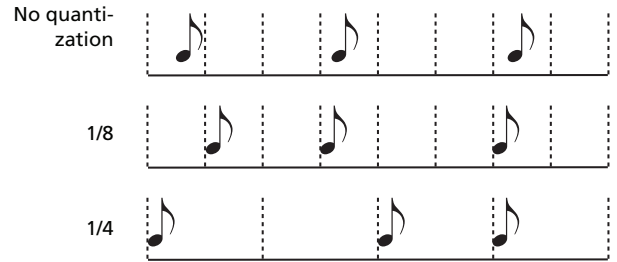

Accuracy

Accuracy percentage of quantize. For example, if Acc=50, and the note is 20 tics away from the coarse grid, it is moved to the grid of only 10 tics.

- 0 No accuracy. The quantize is not executed.
- 100 Maximum accuracy. The note is moved exactly to the grid position.

Swing

Asymmetry of quantization. Grid axis are moved to the nearest grid axis.

- 0 Even-numbered axis are totally moved over the previous odd-numbered axis.
- 50 Axis are perfectly equidistant.
- 100 Even-numbered axis are totally moved over the following odd-numbered axis.

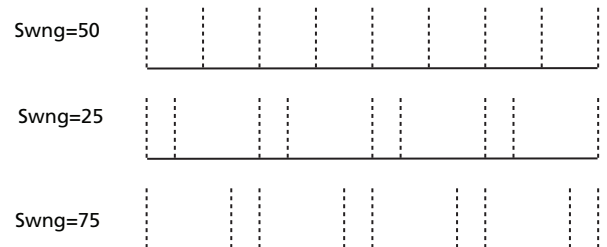

Window

Area of quantize intervention, bordering the grid axis.

- 0 The quantize window corresponds to the axis. No quantization happens.
- 100 The quantize window extends to the nearest window; all events are quantized.

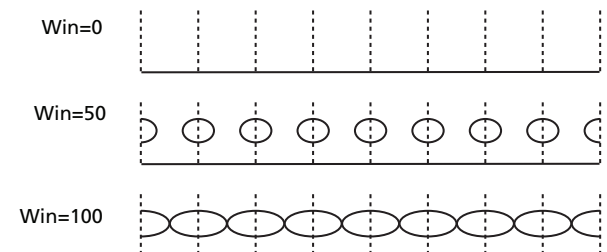

Preferences: Track Settings

In this page, you can set various general parameters referred to Song tracks.

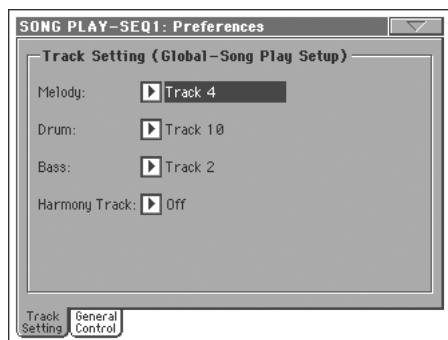

Note: These settings are stored in the Song Play Setup area of the Global file (together with all the other parameters marked with the **GBLSng** abbreviation in the manual). After changing these settings, select the Write Global-Song Play Setup command from the page menu to save them to the Global.

Melody

►GBLSng

This parameter selects the Song's Melody track. This track can be muted using the "Melody Mute" function, assignable to an Assignable Switch, Footswitch or EC5 pedal.

Drum

►GBLSng

This parameter selects the Song's Drum track. This track is left set to play (together with the Bass track) when selecting the "Drum&Bass" function, assignable to an Assignable Switch, Footswitch or EC5 pedal.

Bass

►GBLSng

This parameter selects the Song's Bass track. This track is left set to play (together with the Drum track) when selecting the "Drum&Bass" function, assignable to an Assignable Switch, Footswitch or EC5 pedal.

Harmony Track

►GBLSng

The Voice Processor gets the notes or chords from the track selected with this parameter.

Note: If "Global" is selected, notes or chords sent to the Voice Processor depend on the "Harmony Mode" and "Source" parameters of the Global mode (see page 236 for more information).

Off No track sends notes to the Harmony module of the Voice processor. Chords can still be received from the MIDI IN.

Seq.1-Track 1...16

Notes are sent from one of Sequencer 1's tracks.

Seq.2-Track 1...16

Notes are sent from one of Sequencer 2's tracks.

Seq.1+2Track1...16

Notes are sent by a track with the same name from both Sequencer 1 and Sequencer 2.

Note: When both sequencers are in play, the Voice Processor only receives notes from Sequencer 1 when the Balance slider is fully on the left, and only from Sequencer 2 when the Balance slider is fully on the right.

Global

Notes or chords received by the Voice Processor depend on the "Harmony Mode" parameter (see page 236):

- if the Chords option is selected, chords are sent from the Chord Scanning area of the keyboard.
- if the Notes option is selected, notes are sent (instead of chords).
- if the Shift or Scalic options are selected, notes or chords are ignored.

Preferences: General Control

In this page, you can set various general parameters.

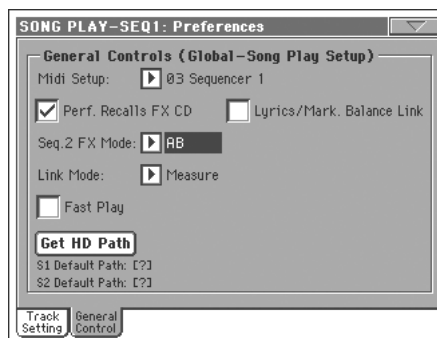

Note: These settings are stored in the Song Play Setup area of the Global file (together with all the other parameters marked with the **GBLSng** abbreviation through the manual). After changing these settings, select the Write Global-Song Play Setup command from the page menu to save them to the Global.

Midi Setup

►GBLSng

MIDI channels for the Song Play mode can be automatically configured by selecting a MIDI Setup with this parameter. See "MIDI" on page 263 for more information on using MIDI Setups.

Note: To automatically select a MIDI Setup when entering the Song Play mode, select the Write Global-Song Play Setup command from the page menu.

For detailed information on MIDI Setup settings, see "MIDI Setup" on page 314.

Note: After selecting a MIDI Setup, you can go to the Global mode and apply any change to each channel setting. To store these changes to a MIDI Setup, while still in Global mode select the Write Global-Midi Setup command from the page menu. All MIDI Setups can be freely customized and overwritten.

Hint: To restore the original MIDI Setups, load the original Factory data again (downloadable from www.korgpa.com).

Performance recalls FX CD ▶GBL^{Sng}

This parameter selects the effects mode for the Performance.

Off When selecting a Performance, no effect is selected.

On The Performance selects the C/D effect pair.

Note: When both this parameter and the “Seq.2 FX Mode” parameter are set to select the C/D effect pair, Sequencer 2 shares its effects with Keyboard tracks. Therefore, these effects can be changed either selecting a Song for Sequencer 2, or selecting a Performance.

Lyrics/Score Balance Link ▶GBL^{Sng}

This parameter allows you to use the SEQUENCER BALANCE slider to select the Sequencer whose lyrics, chords, markers or score will be shown in the built-in display or external monitor.

When the “Text Only” option is selected as the external display view mode, the slider allows you to choose whose lyrics and chords will be shown on the external monitor (see “External Display” on page 230 for more information).

Note: The external monitor can be connected only when the optional VIF4 video interface card is installed.

Off When moving the SEQUENCER BALANCE cross-fader, only the volume balance between Songs will be selected. The shown lyrics or markers will remain unchanged.

On When moving the SEQUENCER BALANCE slider fully to the left or the right, the corresponding Song will fade-in, and its lyrics, chords, markers and score will be selected and shown in the display or external monitor.

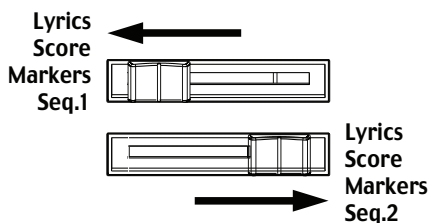

Link Mode ▶GBL^{Sng}

The two onboard Sequencers can work each one with a different Tempo (Off), or use both the same Tempo (various Link modes).

You can turn the Link Mode on by pressing the TEMPO LOCK button and turning its LED on (by default, Beat mode is selected the first time). This also turns the Tempo Lock function on.

Hint: You can always start both sequencers simultaneously, by keeping the SHIFT button held down while pressing one of the ▶/■ (PLAY/STOP) controls.

Off The sequencers Tempo are not linked. Each sequencer uses its own Tempo.

Measure The two sequencers Tempo are linked together. The Tempo data written into the Songs are ignored. Adjust the Tempo using the TEMPO/VALUE controls.

Start one of the sequencers, by pressing its own ▶/■ (PLAY/STOP) control. Then, start the other sequencer, by pressing the other ▶/■ (PLAY/STOP) control; the second sequencer starts at the next measure.

Beat The two sequencer’s Tempo are linked together. The Tempo data written into the Songs are ignored. Adjust the Tempo using the TEMPO/VALUE controls.

Start one of the sequencers, by pressing its own ▶/■ (PLAY/STOP) control. Then, start the other sequencer, by pressing the other ▶/■ (PLAY/STOP) control; the second sequencer starts at the next beat (quarter or octave, depending on the Song’s Time Signature).

Seq.2 FX Mode ▶GBL^{Sng}

This parameter selects the effects mode for Sequencer 2. When a 4-effects Song is loaded, all four effects are used, independently from this setting.

AB The A and B effect pair is used. Sequencer 2 shares its effects with Sequencer 1.

CD The C and D effect pair is used.

Note: When this parameter is set to CD, Sequencer 2 shares its effects with Keyboard tracks, so these effects can be changed either selecting a Song for Sequencer 2, or selecting a Performance (unless the “Performance recalls FX CD” parameter is left unchecked – see above).

Fast Play ▶GBL^{Sng}

When checked, this function allows to skip the empty setup beats at the beginning of a song, and immediately start from the first note. However, any setup data are read and considered.

Note: When Pa800 is driving an external musical instrument, the fast transfer of MIDI data to the MIDI OUT or USB port may cause a delay to the Song’s start. Therefore, we suggest to turn this function off when Pa800 is hooked to other instruments.

Get Hard Disk Path ▶GBL^{Sng}

Available only when a hard disk is installed.

Touch this button to see the current path of each sequencer. This lets you know where currently selected Songs are located in the disk.

If you save these paths to the Global, by selecting the “Write Global-Song Play Setup” command from the page menu, the first time you will open the Song Select window, after turning the instrument on, the selected path will be selected by default.

Page menu

Touch the page menu icon to open the menu. Touch a command to select it. Touch anywhere in the display to close the menu without selecting a command.



Write Performance

Select this command to open the Write Performance dialog box, and save most of the current control panel settings to a Performance.

See “Write Performance dialog box” on page 109 for more information.

Write Global-Song Play Setup

Select this command to open the Write Global-Song Play Setup dialog box, and save global settings that are unique to the Song Play mode.

See “Write Global-Song Play Setup dialog box” on page 179 for more information.

Save Song Marker Seq.1/2

Select this command to save the markers created in the corresponding sequencer (see “Markers side tabs” on page 165).

Export Jukebox List

Select this command to save the current Jukebox list as a text file to a disk. Here is how it works.

1. While a Jukebox file is assigned to the sequencer, select the Export Jukebox List command from the page menu.
2. A dialog box will appear, asking you to select either the internal SSD-U memory or a storage device connected to one of the USB Host ports.

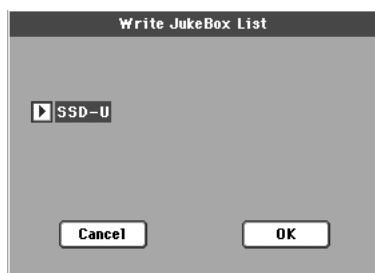

3. Select an option, and touch OK to confirm.

Note: When saved, the text file will be named after the selected Jukebox file. For example, a Jukebox file named “Dummy.jbx” will generate a “Dummy.txt” file. A new, unnamed Jukebox file will generate a “New_name.txt” file. If a file with the same name already exists on the target device, it will be overwritten without waiting for any confirmation.

The list will include the progressive number assigned to each Song, the file names, the total number of files in the list.

For the correct display and printing of the list on a personal computer, use a fixed size (i.e., non-proportional) character in your text editor.

Seq.1-Groove Quantize Enable

Enables/disables the groove quantize (see “Groove Quantize” on page 175). It is automatically unchecked each time the instrument is turned on, or when selecting a different Song.

Note: Groove Quantize only works on Sequencer 1.

Solo Track

Select the track of the current Sequencer to be soloed, and check this item. You will hear only the selected track, and the ‘Solo’ warning will flash on the page header.

Uncheck this item to exit the Solo function.

The Solo functions works in a slightly different way, depending on the selected track:

- **Keyboard track:** The selected Keyboard track is the only track you can hear when playing on the keyboard. All other Keyboard tracks are muted. Sequencer tracks are left in play status.
- **Song track:** The selected track is the only Song track you can hear. All other Song tracks are muted. Keyboard tracks are left in play status.

SHIFT Keep the SHIFT button pressed and touch one of the tracks to solo it. Do the same on a soloed track to deactivate the Solo function.

Copy/Paste FX

You can copy a single, or all four effects, between Styles, Performances, STSs and Songs. To do this, choose the “Copy FX” and “Paste FX” commands from the page menu of the Style Play, Song Play or Sequencer modes.

To copy a single effect:

1. Select the source Song, Performance, Style or STS, then
 - go to the page of the single effect you want to copy (FX A, FX B, FX C, or FX D), or
 - go to the Effects > FX Select page, to copy all four effects. This may be useful if you want to copy two or three of the four effects into different Performances, Styles or STSs.
2. Choose the “Copy FX” command from the page menu.
3. Select the target Performance, Style or STS, then go to the page of the single effect you want to paste (FX A, FX B, FX C, or FX D).
4. Choose the “Paste FX” command from the page menu.

To copy all four effects:

1. Select the source Performance, Style or STS, then go to the Effects > FX Select page, to copy all four effects.
2. Choose the “Copy FX” command from the page menu.
3. Select the target Performance, Style or STS, then go to the page of the Effects > FX Select page.
4. Choose the “Paste FX” command from the page menu.

Easy Mode

Easy Mode allows you to use the Style Play and Song Play modes with an easier-to-use user interface. It is recommended to beginners, and to professionals alike that do not want to deal with the extra parameters of the Advanced mode.

At any time, you can manually turn the Easy Mode on/off with the Easy Mode command in the page menu of the Style Play and Song Play modes.

See “The Song Play page in detail” on page 8 for more information.

Write Global-Song Play Setup dialog box

Open this dialog box by selecting the Write Global-Song Play Setup item from the page menu. Here, you can save various Song Preference settings (see “Preferences: Track Settings” on page 176), that are saved to the Global file.



Parameters saved in the Song Play Setup area of the Global are marked with the ►GBL^{Sng} symbol through the user’s manual.

SongBook

The SongBook is an onboard database that allows you to organize various “musical resources” (Style, Standard MIDI Files, KAR files, and – optionally – MP3 files) for easy retrieving.

The SongBook mode overlaps the Style Play and Song Play operating modes. When you select an entry from the database, the Style Play or Song Play mode is automatically selected, depending on the type of file associated with the entry.

In addition to helping you organize your shows, the SongBook allows you to associate up to four STSs to each Standard MIDI File or MP3 file, played back in Song Play mode. This way, it is easy to recall a complete setup for Keyboard tracks, effects, and the Voice Processor, for realtime playing over a midifile or MP3 file.

For more information on using the SongBook, see the Quick Guide (starting from page 60).

Note: SongBook entries do not include actual data, but only a pointer to a Style in memory, a Standard MIDI File, or an MP3 file. When you copy a SongBook file, referenced files are not copied with it.

Warning: If you load a SongBook list from a storage device (“SBD” file), the existing one in memory is deleted. Save your old SongBook list before loading a new one.

Book

The Book page contains the full database of song entries (i.e., an “SBD” file). While in this page, you can select an entry, and touch the Select button in the display to start playback.

If the “Enable List Edit” command is selected in the page menu (see above), the “Add to list” button becomes available, to let you add entries to the selected Custom List.

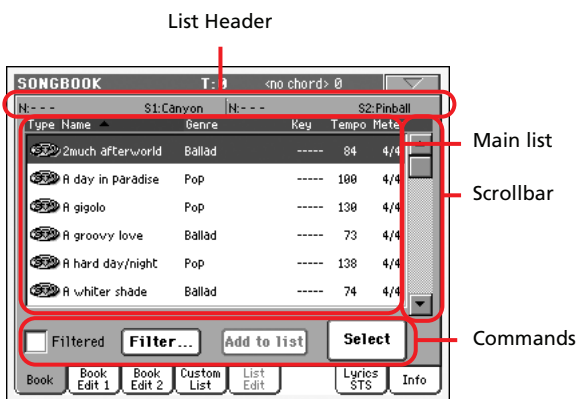

Each entry of this database may include the song’s author, name, genre, original key, tempo and meter. When selecting one of the entries, the associated Style, Standard MIDI File or MP3 file is automatically recalled.

List Header

The List Header may change, depending on the type of data associated with the selected entry.

- When a Style is associated to the entry, the currently selected entry’s name is shown on the left (“N:”), and the associated Style is shown on the right (“Style:”):

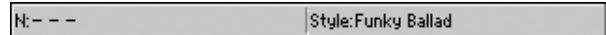

- When a Standard MIDI File or MP3 file is associated to the entry, the list header is split into two parts, with the left half referring to Sequencer 1, and the right one referring to Sequencer 2.

Information for the selected entry’s name (“N:”) and associated Standard MIDI File or MP3 file (“S1:” or “S2:”) is given for each sequencer:

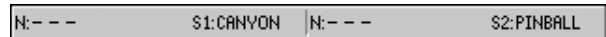

Note: If you select a different Style or Standard MIDI File or MP3 file, the entry’s name field (“N:”) returns blank (---), meaning the entry has been modified.

Main list

Full list of the SongBook database. Use the scrollbar (or the TEMPO/VALUE dial) to browse through the list.

You can touch one of the heading labels above the list to change the order in which entries are shown. For example, by touching the “Name” label, the list is alphabetically re-ordered according to the file names. The selected label turns red, showing the currently selected ordering.



The corresponding items in the page menu are automatically updated to reflect these changes (see “Sort by Type/Name/Genre/Artist/Key/Tempo/Meter” on page 187).

By touching the label again, the order of the files switches between ascending and descending.

Scrollbar

Use the scrollbar (or the TEMPO/VALUE dial) to scroll the entries.

Commands

Filtered

When this box is checked, only entries matching the selected filter criteria are shown in the Main list. The box is automatically checked when you exit from the Filter dialog box by touching OK (see below).

Filter...

Touch this button to open the Filter dialog box, and select one or more filter criteria, to show a restricted set of entries in the main list.

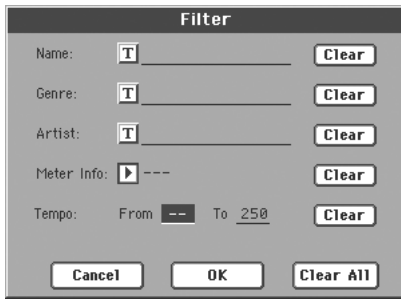

Touch the **T** (Text Edit) button next to the search criteria you want to edit (Name, Genre, or Artist). You can also select a Meter, or a range of Tempo values.

Touch the Clear button next to the search criterion you want to delete or set to a default value.

Touch Clear All to reset all search criteria, excluding Tempo.

Add to list

Select an entry, then touch this button to add the selected entry to the current Custom List (see “Custom List” on page 185).

Select

Touch this button to confirm selection of the highlighted entry in the main list. After touching this button, the name of the selected entry appears in the left upper corner of the display (“N:”).

When you select a song in any of the SongBook lists, its name appears in reversed text, over a dark-blue background. While in this situation, the song is selected, but not yet loaded.

When you touch the Select button in the display, the song will be loaded. The blue background turns to green, to show the Song has been loaded, and ready to play.

Numeric selection of entries

When in SongBook mode, you can select a SongBook entry by means of an unique number. Numbers associated with each entry are added in the Book Edit 2 page (see “Book Edit 2” on page 184).

To see the numbers while in the Book page, select the “Show Song Numbers (now Key)” command from the page menu:

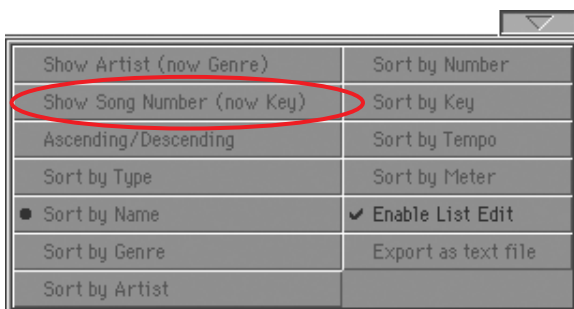

After you select this command, the “Num” column appears:

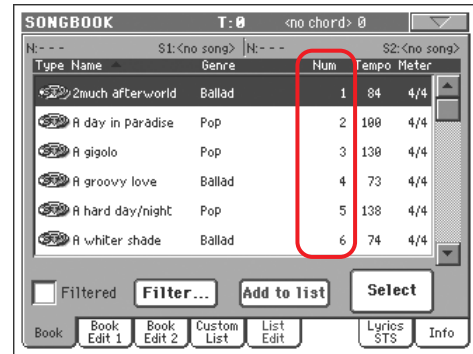

To see the “Key” column again, select the “Show Key (now Song Numbers)” command from the page menu.

To select a SongBook entry by entering its number, press the SONGBOOK button again while you are in any page of the SongBook mode. The numeric keypad will appear, allowing you to enter the number corresponding to the desired entry.

Selecting SongBook entries via MIDI

SongBook entries can be selected via MIDI (through the special Control channel), by using the NRPN dedicated Control Change messages #99 (MSB, with value 2) and #98 (LSB, with value 64). See “Selecting SongBook entries via MIDI” on next page.

Setting the special Control MIDI channel

First of all, go to the Global > MIDI > Setup/General Control page and select a MIDI Setup to be used when you will remotely select SongBook entries.

Then go to the Global > MIDI > Midi In Channel page, to assign a MIDI channel to the special Control channel. Assign the Control option to one of the sixteen available MIDI channels (usually one of the higher-numbered ones).

When done, save this setting to the current MIDI Setup by choosing the “Write Global-Midi Setup” command from the page menu.

If you plan to use a different MIDI channel for the Style Play and Song Play modes, repeat the above to create a second MIDI Setup.

Assigning a MIDI Setup to the Style Play and Song Play modes

Since SongBook entries dynamically recall the Style Play or the Song Play modes, **it is advisable to assign them the same MIDI Setup, or two different MIDI Setups with the Control channel assigned to the same MIDI channel.** This way, the same MIDI channel will be used to select a SongBook entry in either the Style Play or Song Play mode.

When one of the operating modes is recalled, the MIDI Setup memorized in the Style Play Setup or in the Song Play Setup will be automatically selected, and MIDI channels will be automatically configured.

To assign a MIDI Setup to each of the two operating modes:

- In Style Play mode, go to the Style Play > Preferences > Style Setup page, and select a MIDI Setup. Select the Write Global-Style Setup command from the page menu.

• In Song Play mode, go to the Song Play > Preferences > General Control page, and select the same MIDI Setup assigned to the Style Play mode. Select the Write Global-Song Play Setup command from the page menu.

Selecting SongBook entries via MIDI

When you are ready to remotely select SongBook entries, switch to the Style Play or Song Play mode.

At this point, Pa800 must receive on the special Control channel the NRPN Control Change messages #99 (MSB, with value 2) and #98 (LSB, with value 64) in fast succession, as an initialization string. This string must be sent only once, unless another NRPN control is sent on the same MIDI channel before selecting a different SongBook entry.

After the initialization string has been sent, you must send the selection string, made of two Control Change messages: CC#06 (Data Entry MSB) for the thousands and hundreds, and CC#38 (Data Entry LSB) for the tens and units. The range of the Data Entry controls, in this case, is 0~99 (instead of the typical 0~127).

The following examples show some typical situations.

- Send the following string to select SongBook entry #77:

Data 1	Data 2	
NRPN MSB	2	Initialization string (CC#99, 98)
NRPN LSB	64	
DataEnt MSB	0	Thousands and hundreds (00xx)
DataEnt LSB	77	Tens and units (xx77)

- Send the following string to select SongBook entry #100:

Data 1	Data 2	
NRPN MSB	2	Initialization string (CC#99, 98)
NRPN LSB	64	
DataEnt MSB	1	Thousands and hundreds (01xx)
DataEnt LSB	0	Tens and units (xx00)

- Send the following string to select SongBook entry #8563:

Data 1	Data 2	
NRPN MSB	2	Initialization string (CC#99, 98)
NRPN LSB	64	
DataEnt MSB	85	Thousands and hundreds (85xx)
DataEnt LSB	63	Tens and units (xx63)

Book Edit 1

The Book Edit 1 page is where you to add or modify SongBook entries.

Hint: Use the Filter in the Book page, to quickly find an entry to be edited.

The Book Edit 1 page with a Style-based entry:



The Book Edit 1 page with a Song-based entry:



Header

Name ▶SB

Name of the selected song entry. The name is assigned after you touch the Write button to save the entry to the SongBook list.

Resource ▶SB

Style or Standard MIDI File or MP3 file associated with the saved entry.

Warning: If you replace this resource with a different one, carrying the same media path and name (in case of a Standard MIDI File or MP3 file) or memory location number (in case of a Style), the SongBook entry will no longer point to the right data. Be careful not to delete or move a Style or a file associated with a SongBook entry from the original location.

Database Area

Genre ▶SB

Music genre associated with the entry.

Artist ▶SB

Name of the artist of the song associated with the entry.

Key Info ▶SB

Original key of the entry. The first field is the key name, the second one is the mode (major or minor).

Tempo ▶SB

Basic tempo of the Style, or starting tempo of the Standard MIDI File associated with the entry. This may change, if a Tempo Change event is included with the associated resource.

Note: Even if you can edit this value, the starting value of a Standard MIDI File is always considered, and overrides this value.

Note: You can edit this value even if an MP3 is associated to the SongBook entry. However, this is just an indicative value.

Meter Info ▶SB

Basic meter of the Style, or starting meter of the Standard MIDI File associated with the entry. This may change, if a Meter Change event is included with the associated resource.

M.Transp. (Master Transpose) ▶SB

Master Transpose. When the entry is selected, the Master Transpose for the whole instrument is automatically changed (unless the Master Transpose is locked).

Note: The Master Transpose value saved with the SongBook entry overrides any Master Transpose setting contained in the referenced Song.

Resource Area**Write Current Resource**

When checked, a reference to the selected resource is saved with the entry when touching Write. Saved resources are:

- the latest selected Style; this also saves the associated Pads and STSs.
- the SMF, KAR or MP3 file assigned to Sequencer 1, and shown on the right of this parameter; Pads and STSs associated to the latest selected Style are also saved.

Note: Only the SMF or KAR file assigned to Sequencer 1 will be saved in the SongBook entry. However, when recalling the entry, the Song will be assigned to either Sequencer, depending on which one is currently free and not in play.

When unchecked, no new resource will be saved with the entry. The original resource associated with the entry will be preserved when touching Write.

When touching New Song to create a new, blank entry, this parameter is automatically checked, and cannot be modified. A reference to the associated resource will be saved with the new entry.

Resource Name ▶SB

Name of the currently selected Style, Standard MIDI File or MP3 file. It may differ from the name of the resource already saved in the entry, shown on top of the page (see “Resource” above).

You can select a different resource, by just using the STYLE SELECT section, or the SEQ1–SELECT button on the control panel, to select a different Style, Standard MIDI File or MP3 file.

As an alternative, you can exit to the Style Play or Song Play mode, and select resources from there. Then, press the SONGBOOK button to return to the Book Edit page.

When you touch Write, a link to the selected resource(s) is saved with the entry (provided “Write Current Resource” is selected when saving). The resource(s) will be recalled when you selected the entry it is associated to.

Write STS ▶SB

When saving a SongBook entry, and this parameter is checked, you can save a single STS or all four Style’s STSs.

<STS Name> A single STS is saved to the chosen SongBook STS. The source are the Keyboard tracks, as they have been configured by selecting a Performance, Style STS, SongBook STS, or after manual editing.

When you touch Write and choose the Rename/Overwrite option, only the new STS is overwritten, while the others are left untouched.

All Current Style STS

All four STSs are saved to the current SongBook entry. The source STSs are those contained in the Style currently selected in Style Play mode.

When you touch Write and choose the Rename/Overwrite option, all STSs are overwritten.

STS Name ▶SB

Name of the current STS. Touch the **T** (Text Edit) button to open the Text Edit window, and modify the name.

To STS Location

One of the four STS available for each entry, where you can save the current settings for Keyboard tracks and the Voice Processor.

Buttons**New Song**

Touch this button to create a new entry. Settings are copied from the currently selected Style, or from the Standard MIDI File or MP3 file assigned to Sequencer 1. The selected resource will be shown in the “Resource Name” field (see above).

Del Song

Touch this button to delete the current entry.

Write

Touch this button to open the Write Song dialog box, and save the current entry to the main list of the SongBook.

Note: The maximum number of entries in a SongBook file is 3,000 entries.



To assign a different name to the entry, touch the **T** (Text Edit) button to open the Text Edit window.

Select an option to add the new entry to the SongBook:

- Select Rename/Overwrite to overwrite an existing entry, optionally changing its name. **Warning:** The older entry will be deleted!
- Select New Song to save a new entry to the SongBook database.

Book Edit 2

The Book Edit 2 page is where you select Style options to be memorized, link a “.TXT” file, and assign a unique number to the current entry.

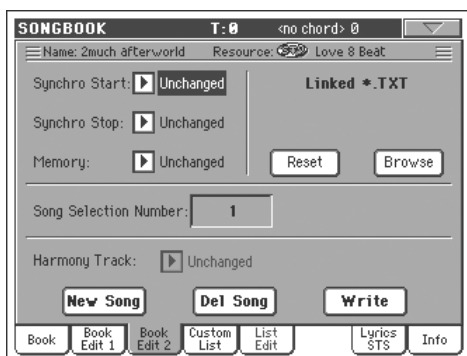

Synchro Start / Synchro Stop / Memory ▶SB

The status of these functions can be memorized in a SongBook entry.

Note: If the SongBook entry is based on a Song, Synchro Start and Synchro Stop appear in grey and cannot be modified, since they have no effect on a Song.

- Unchanged** When selecting this SongBook entry, the status of the corresponding function is left unchanged.
- Off** When selecting this SongBook entry, the status of the corresponding function is turned off.
- On** When selecting this SongBook entry, the status of the corresponding function is turned on.

Linked .TXT ▶SB

You can select a text (.TXT) file, and link it to the Style or Song associated with the current SongBook entry. When you select this entry, the text file is automatically loaded.

Text files can be seen in the display and in an external monitor (provided the VIF4 Video Interface has been installed). Since there is no automatic synchronization between this kind of lyrics and the associated songs, you must scroll them manually. This can be accomplished in either of two ways:

- When a “.TXT” file is selected, a special vertical scrollbar appears in the Lyrics/STS page of the SongBook mode. Touch it to scroll through the text during the performance. See “Lyrics/STS” on page 186.
- Scrolling is also possible by means of the Text Page Down/Up command, that can be assigned to a Footswitch, EC Switch or Assignable Switch.

This section of the Book Edit 2 page contains two buttons:

- Reset** Touch this buttons to unlink the text file from the entry.
- Browse** Touch this button to open a standard File Selector, and select a “.TXT” file to be linked to the current SongBook entry.

Song Selection Number ▶SB

Here you can select a unique number (up to 9,999) to be associated to the current SongBook entry. By typing this number after pressing the SONGBOOK button again, you will be able to quickly recall an entry from the Book page (see “Numeric selection of entries” on page 181).

Assigning a number is not mandatory, but may help you to organize your entries. For example, you can use the different 100s to create a different way of categorizing your entries by genre or age.

Each number can correspond only to a single entry. You cannot assign the same number to two or more different entries. Therefore, if you try to save a modified entry without first selecting a different Song Selection Number, and select the New Song option in the Write Song dialog box, the following error message will appear:

“This entry’s Song Selection Number has already been assigned. Please assign a different number”.

Should this happen, you will automatically be kept in the Book Edit 2 page. While there, assign a different number (while turning the Dial or pressing the UP/DOWN buttons, you are only allowed to select numbers that are still free) and try to save the entry again.

Harmony Track

When selecting a SongBook entry (pointing to a Standard MIDI File or MP3 file), the Harmony Track can be automatically selected.

Note: If the entry is based on a Style, this parameter is greyed out (non-selectable).

- Unchanged** The previously selected track is left unchanged.
- Track Number** The chosen track is selected when choosing the (SMF-based) SongBook entry.

Custom List

Use this page to select and use one of the available Custom Lists (contained in the “LISTDB.SBL” file saved in the same folder as the “.SBD” SongBook file). Custom Lists are lists made of entries extracted from the main SongBook list (as seen in the Book page). They allow the use of smaller, customized SongBook lists, suitable for a single gig or your own music tastes.

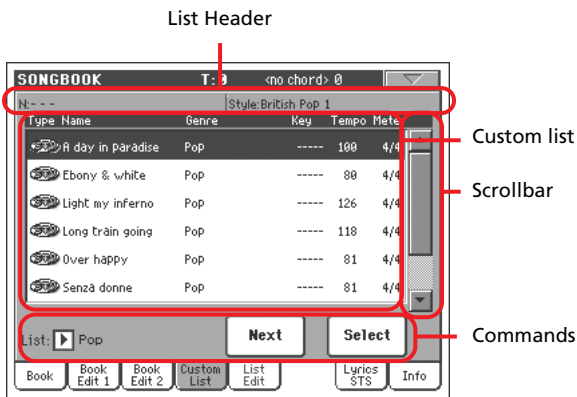

Hint: You can jump to this page by keeping **SHIFT** pressed, and pressing the **SONGBOOK** button.

List header

See “List Header” on page 180.

Custom list

List of files contained in the selected Custom List. Use the scrollbar to browse through the list. (As an alternative, use Shift + Dial).

Scrollbar

Use the scrollbar (or the TEMPO/VALUE controls) to scroll the entries.

Commands

List pop-up menu

Use this pop-up menu to select one of the available lists.

Next

Touch this button to select the next entry in the list.

Hint: You can assign this command to an Assignable Switch or Assignable Footswitch.

Select

Touch this button to confirm selection of the highlighted entry in the list. After touching this button, the name of the selected entry appears in the left upper corner of the display (“N:”).

Hint: This command is useful to browse through the list, and select an entry different than the following one in the list.

List Edit

This page is only available after checking the “Enable List Edit” command in the page menu (see page 187).

Use this page to edit the available Custom Lists. A Custom List is a set of SongBook entries, created by selecting items from the Main List.

To add entries to a Custom List, first create or select the list to be edited in this page. Then, go to the Book page, select the entry to be added, and touch the “Add to list” button. When finished adding entries, return to this page and edit the selected list.

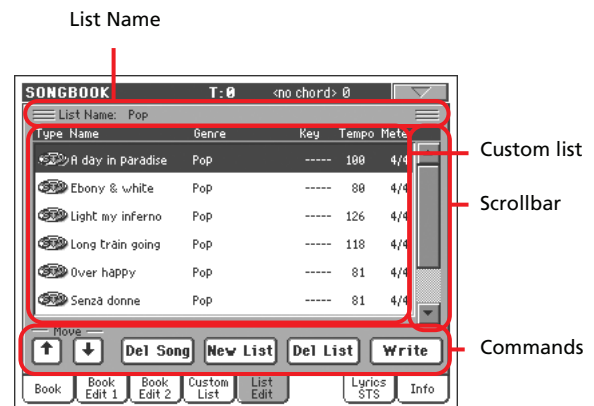

List Name

Name of the selected list. To select a Custom List, go to the “Custom List” page and use the List pop-up menu.

Custom list

List of songs contained in the selected Custom List. Use the scrollbar to browse through the list.

Scrollbar

Use the scrollbar (or the TEMPO/VALUE dial) to scroll the entries.

Commands

Move

Use these buttons to move the selected song entry up or down in the list.

Del Song

Touch this button to delete the selected song entry from the list.

New List

Touch this button to create a new, empty Custom List.

Note: The maximum number of Custom Lists in a SongBook file is 256 lists.

Del List

Touch this button to delete the current list.

Write

Touch this button to save changes to the selected Custom List.

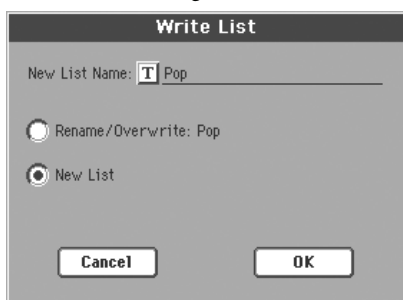

To assign a different name to the selected list, touch the **T** (Text Edit) button to open the Text Edit window.

Select an option to save the edited Custom List:

- Select Rename/Overwrite to overwrite an existing list, optionally changing its name. **Warning: The older list will be deleted!**
- Select New List to save a new Custom List in memory. This list will be available in the “Custom List” page.

Lyrics/STS

The Lyrics/STS page is where you can see lyrics, chords, scores, and select STSs.

Seq./Style Lyrics side tabs

These three panels show the lyrics and chord abbreviations. You can find more information on the types of data supported on page 164.

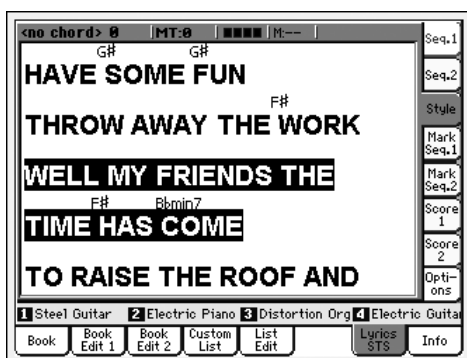

When a Song-based entry has been selected, you can see lyrics contained in a Standard MIDI File as Lyrics events, or in an MP3 with Lyrics file. In this case, text will automatically flow with the music.

You can also see lyrics contained in a “.TXT” file linked to a Style- or Song-based SongBook entry. In this case, unlike with ordinary Lyrics, the text will not scroll automatically while the Song is playing back. You must scroll it with the DIAL or the vertical scrollbar. As an alternative, you can use an assignable switch or footswitch, with the Text Page Up or Text Page Down functions assigned, to scroll (respectively) to the previous or next text page.

When no lyrics data is contained in the Song, or linked to a SongBook entry, and no “.TXT” file has been linked to the cur-

rent entry, you can see lyrics contained in a “.TXT” file loaded after selecting an entry (see “On-the-fly TXT loading” below).

When a “.TXT” file is associated to the current entry, a vertical scrollbar appears, allowing you to scroll to the previous or former text page during the performance.

Note: You cannot scroll a single line of text at a time; you always scroll by a whole page of text, either if you touch on the scrollbar or one of the small scrolling arrows.

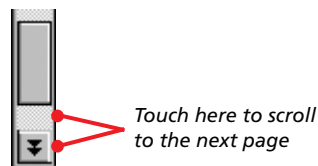

Lyrics as text files associated to a Song-Book entry

Lyrics can be associated to each SongBook entry (either Style or Song-based) as a “.TXT” file. See “Linked .TXT” on page 184 for more information on this issue.

On-the-fly TXT loading

When an entry does not contain any Lyrics metadata or has no “.TXT” file linked, the “No lyrics. Press SHIFT and touch here to load a TXT file” message appears in the display when you go to the Lyrics/STS page.

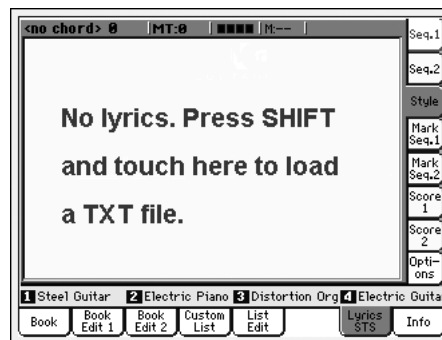

When this message appears, and you want to load a “.TXT” file, keep the SHIFT button pressed and touch the center of the display. A standard file selector appears, and lets you look for “.TXT” file to be loaded to be shown while the current Style or Song is playing.

Hint: When the file selector appears, you can use the Search () function to search a “.TXT” file in the various media. See “Searching files” on page 244 for more information.

Markers side tabs

See “Markers side tabs” on page 165 for more information.

Score side tabs

See “Score side tabs” on page 166 for more information.

Options side tabs

See “Options side tab” on page 167 for more information.

Info

Use the Info page to see the name of the selected entry, the associated resource(s), the total number of Songs in the SongBook, the number of filtered entries, the number of available Custom Lists, and the number of Songs in the current list.

- In case of an entry based on a Style:

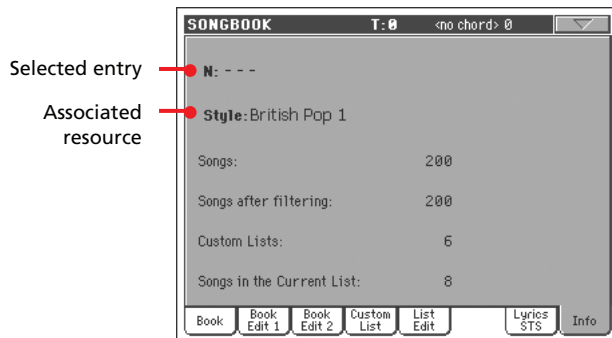

- In case of an entry based on Standard MIDI Files or MP3 files:

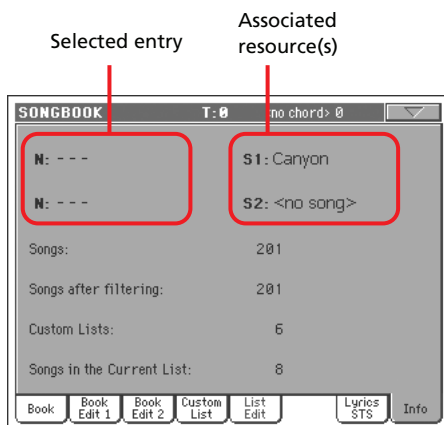

Selected entry

This parameter shows the currently selected entry. If it is blank (---), the latest selected entry has been modified, or no entry has been selected yet.

Associated resource

Style or Standard MIDI File or MP3 file associated to the selected entry.

Song number

Total number of entries in the SongBook list.

Filtered Song number

This parameter shows the number of entries shown in the Book page, after applying the selected filter. If no filter is selected, this matches the total number of entries in the SongBook list (see previous parameter).

Custom List number

This parameter shows the number of available Custom Lists.

Songs in the Current List

Number of entries in the selected Custom List.

Page menu

Touch the page menu icon to open the menu. Touch a command to select it. Touch anywhere in the display to close the menu without selecting a command.

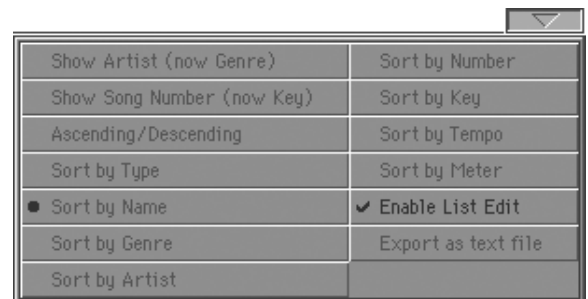

Artist/Genre

Select this command to toggle between the Artist and Genre column on the SongBook list, appearing in the Book and Custom List page.

Ascending/Descending

Select this command to toggle between the ascending and descending view order of the SongBook list. The sorting order is selected with one of the following commands.

Sort by Type/Name/Genre/Artist/Key/Tempo/Meter

Select one of these command to select the sorting order. The selected option is shown in red above the entry list.

Enable List Edit

Select this command, and make the checkmark appear, to make the List Edit page available.

Export as text file

Select this command to open the Export dialog box, and save the SongBook or Custom List as a text file. The selected filtering will be applied to the exported list, assuming the Filter button is checked.

The dialog box is a little different, depending on the page where you selected this command.

- Selected from the Book page:

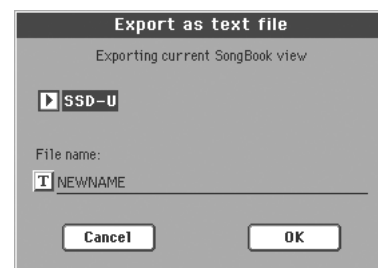

- Selected from the Custom List page:



Touch the **T** (Text Edit) button to open the Text Edit window and assign a name to the text file to be saved to a storage device.

Then, select either the internal SSD-U memory or the hard disk to save the file.

- Touch OK to confirm.

Sequencer operating mode

The Sequencer operating mode is the full-featured onboard sequencer, where you can create a Song from scratch, or edit it. You can also use this mode to edit the initial parameters of a Standard MIDI File, either made with an external sequencer or with Pa800's own sequencer.

You can save the new or edited Song as a Standard MIDI File (SMF, i.e., a file with the ".MID" extension), and play it back either in Song Play or Sequencer mode – or on any external sequencer.

Transport controls

To play back a Song, use SEQUENCER 1 transport controls (i.e., the one on the left side of the SEQUENCER area). While in Sequencer mode, you can only use Sequencer 1 controls. Sequencer 2 controls are deactivated. See "SEQUENCER 1 TRANSPORT CONTROLS" on page 14 for more information.

The Songs and the Standard MIDI File format

The native Song format for Pa800 is the Standard MIDI File.

When saving a Song as a SMF, an empty measure is automatically inserted to the beginning of the Song. This measure contains various Song initialization parameters.

When an SMF is loaded, the empty measure is automatically removed.

Songs and Voice Processor Presets

You can use the Voice Processor while in Sequencer mode. For this, just two settings are needed:

- Select the Song track where you are recording chords for the Voice Processor (see "Harmony Track" on page 211).
- Select the desired Voice Processor Preset (in the Voice Processor Preset section of the Global mode, see page 235).

Sequencer Play - Main page

Press SEQUENCER to access this page from another operating mode. In this page you can load a Song, and play it back using the transport controls for SEQUENCER 1 (see "Transport controls" above).

Note: When switching from Style Play to Sequencer mode, the Sequencer Setup is automatically selected, and various track parameters may change.

To return to this page from one of the Sequencer edit pages, press the EXIT or SEQUENCER button.

To switch between Song tracks 1-8 and 9-16, use the TRACK SELECT button.

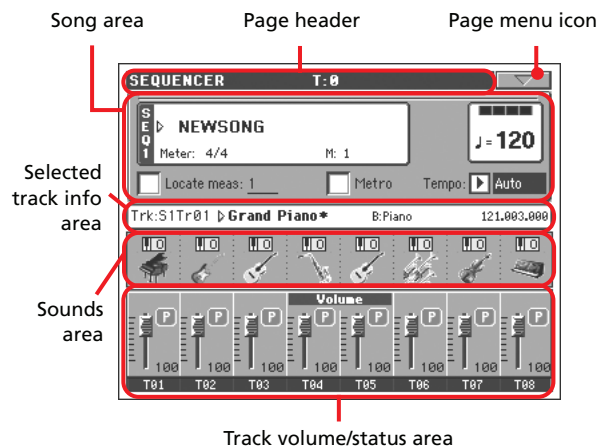

Page header

This line shows the current operating mode, transposition and recognized chord.



Operating mode name Master Transpose (in semitones)

Operating mode name

Name of the current operating mode.

Master Transpose

Master transpose value in semitones. This value can be changed using the TRANSPOSE buttons on the control panel.

Note: Transpose may be automatically changed when loading a Standard MIDI File generated with an instrument of the Korg Pa series. The Master Transpose Lock parameter in the Global (see "General Controls: Lock" on page 218) has no effect on the Sequencer.

Page menu icon

Touch the page menu icon to open the menu. See “Page menu” on page 211 for more information.



Song area

This is where the Song name is shown, together with its tempo and meter parameters, and the current measure.

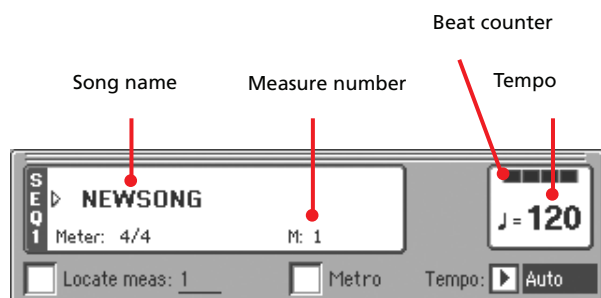

Song name

Displays the name of the selected Song. “NEWSONG” means that a new (blank) Song is selected, and you can record it.

Touch the Song name to make the Song Select window appear, allowing for selection of a different Song (see “Song Select window” on page 82).

To select a Song, you can also press the SELECT button in the SEQUENCER 1 section of the control panel. Press SELECT a second time to select a Song by dialing in its ID number (see “Selecting a Song by its ID number” on page 83).



Meter

Current Time Signature.

Measure number

Current measure number.

Tempo

Metronome tempo. Select this parameter and use the TEMPO/VALUE controls to change the tempo. As an alternative, when a different parameter is selected, or you are in a different page, keep the SHIFT button pressed and use the DIAL to change the tempo of the sequencer.

Locate measure

When checked, the measure shown by this parameter is a temporary start point of the song, instead of measure 1. When you press the ◀ (HOME) button, or use the << (REWIND) button to go back to the beginning, the Song returns to this point.

Metro

Check this box to turn the metronome on during playback.

Tempo (Tempo mode)

Use this menu to select the Tempo change mode.

Manual In this mode, you can change the Tempo using TEMPO/VALUE section controls. The Song will be played back using the manually selected tempo.

Auto The Tempo recorded to the Song will be used.

Selected track info area

This line lets you see the Sound assigned to the selected track. Not only it is shown on the main page, but also in several edit pages.

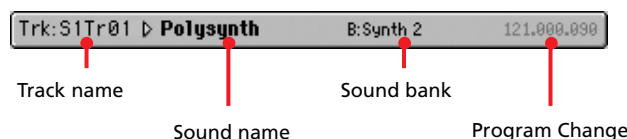

Track name

Name of the selected track.

Sound name

Sound assigned to the selected track. Touch anywhere in this area to open the Sound Select window, and select a different Sound.

Sound bank

Bank the selected Sound belongs to.

Program Change

Program Change number sequence (Bank Select MSB, Bank Select LSB, Program Change).

Sounds area

This area lets you see Sounds and octave transposition for the eight tracks currently displayed.

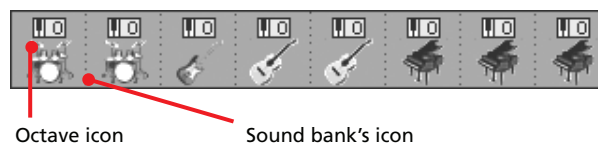

Song track octave transpose

Non editable. Octave transpose of the corresponding track. To edit the octave transpose, go to the “Mixer/Tuning: Tuning” edit page (see page 96 for programming information).

Sound bank's icon

This picture illustrates the bank the current Sound belongs to. Touch an icon a first time to select the corresponding track (detailed information are shown on the Selected Track Info area, see above). Touch it a second time to open the Sound Select window.

Track volume/status area

This area is where you can set the volume of each Song track, and mute/unmute tracks.

Use the TRACK SELECT button to switch between Song Tracks 1-8 and Song Tracks 9-16 views.

The **Song Tracks 1-8 view** shows individual Song tracks 1-8:

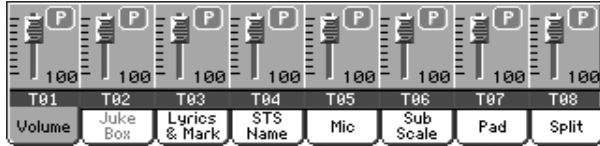

The **Song Tracks 9-16 view** shows individual Song tracks 9-16:

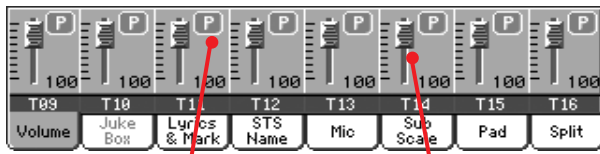

Track status icon

Virtual slider

Virtual slider (track volume)

Virtual sliders are a graphical display of each track's volume. Touch the track's area to select a track, and use TEMPO/VALUE controls to change the value (or touch and drag it in the display).

Track status icon

►SONG ►GBL^{Seq}

Play/mute status of the current track. Select the track, then touch this area to change the track status. The status of Song tracks is saved when saving the Song.



Play status. The track can be heard.



Mute status. The track cannot be heard.

Track names

Under the sliders, a label for each track is shown. Use the TRACK SELECT button to switch between tracks 1-8 and 9-16.

T01...T16 Song tracks.

Entering Record mode

To enter Record mode, press the RECORD button while you are in Sequencer mode. The following dialog box will appear:

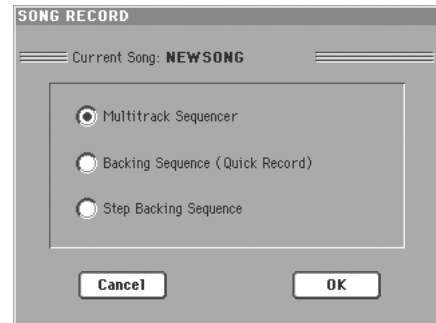

Select one of the three available recording options and touch OK (or Cancel if you don't want to enter Record mode).

Multitrack Sequencer

Full-featured sequencer. Select this option for classic multitrack recording. (See "Record mode: Multitrack Sequencer page" on page 192).

Backing Sequence (Quick Record)

Easy way of recording. Just play with Styles, and record your realtime performance.

Step Backing Sequence

Step-record. Edit chords and controls for the Style. Very useful if you are not a keyboard player.

Record mode: Multitrack Sequencer page

While in Sequencer mode, press the RECORD button and select the “Multitrack Sequencer” option. The Multitrack Sequencer page appears.

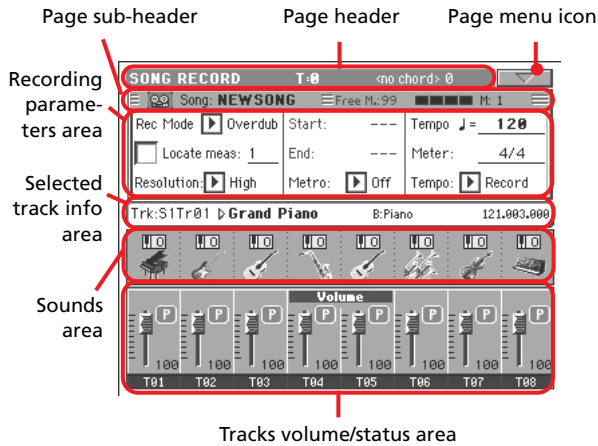

See “Multitrack recording procedure” on page 193 for information on the record procedure.

Page header

See “Page header” on page 189.

Page menu icon

See “Page menu icon” on page 190.

Page sub-header

This area shows some performing info on the Song.

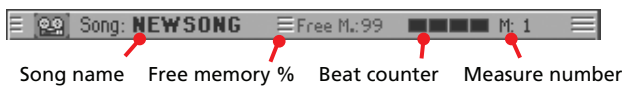

Song name

Name of the Song in record.

Free memory %

Percentage of remaining memory available for recording.

Beat counter

This indicator shows the current beat inside the current measure.

Measure number

Current measure you are recording.

Recording parameters area

Rec mode (Recording mode)

Set this parameter before starting record, to select a recording mode.

- Overdub** The newly recorded events will be mixed to any existing events.
- Overwrite** The newly recorded events will replace any existing events.
- Auto Punch** Recording will automatically begin at the “Start” position, and stop at the “End” position.

Note: The Auto Punch function will not work on an empty Song. At least one track must already be recorded.

- PedalPunch** Recording will begin when pressing a pedal set to the “Punch In/Out” function, and will finish when pressing the same pedal again.

Note: The Pedal Punch function will not work on an empty Song. At least one track must already be recorded.

Locate measure

When checked, the measure shown by this parameter is a temporary start point of the song, instead of measure 1. When you press the ►/■ (PLAY/STOP) button to stop recording, or use the << (REWIND) button to go back to the beginning, the Song returns to this point.

Resolution

Use this parameter to set the quantization during recording. Quantization is a way of correcting timing errors; notes played too soon or too late are moved to the nearest axis of a rhythmic “grid”, set with this parameter, thus playing perfectly in time.

- High** No quantization applied.

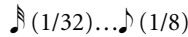

Grid resolution, in musical values. For example, when you select 1/16, all notes are moved to the nearest 1/16 division. When you select 1/8, all notes are moved to the nearest 1/8 division.

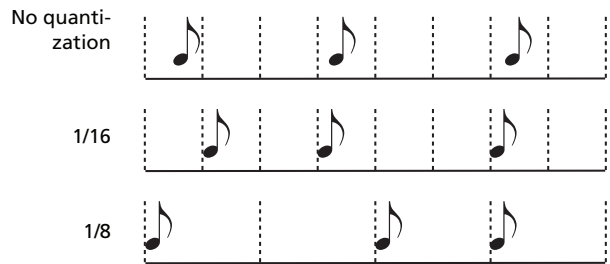

Start/End

Start and End locators. These parameters area available only when the “Auto Punch” recording mode is selected. They set the starting and ending points of the Punch recording.

Metro (Metronome)

This is the metronome heard during recording.

- Off** No metronome click will be heard during recording. A one-bar precount will be played before starting recording.
- On1** Metronome on, with a one-bar precount before starting recording.

On2 Metronome on, with a two-bar precount before starting recording.

Tempo

Select this parameter, and use the TEMPO/VALUE controls to set the tempo.

Note: You can always change the Tempo, when other parameters are selected, by keeping the SHIFT button pressed, and rotating the DIAL.

Meter

This is the basic meter (or time signature) of the Song. You can edit this parameter only when the Song is empty, i.e., before you begin recording anything. To insert a meter change in the middle of the Song, use the “Insert Measure” function (see page 209).

Tempo (Tempo mode)

This parameter sets the way tempo events are read or recorded.

Manual Manual reading. The latest manual Tempo setting (made using the TEMPO/VALUE controls) is considered the current Tempo value. No Tempo change events will be recorded. This is very useful to record the Song much slower than its actual Tempo.

Auto Auto reading. The Sequencer plays back all recorded Tempo events. No Tempo change events are recorded.

Record All Tempo changes made during recording will be recorded to the Master Track.

Note: The tempo is always recorded in overwrite mode (old data is replaced by the new data).

Selected track info area

This line lets you see the Sound assigned to the selected track. See “Selected track info area” on page 190 for more information.

Sounds area

This area lets you see Sounds and octave transposition for the eight tracks currently displayed. See “Sounds area” on page 190 for more information.

Track volume/status area

This area is where you can set the volume of each Song track, and change track status. See “Track volume/status area” on page 191.

Track status icons

Play/mute/record status of the current track. Select the track, then touch this area to change its status.



Play status. The track can be heard.



Mute status. The track cannot be heard.



Record status. After pressing ►/■ (PLAY/STOP) to start recording, the track will receive notes from the keyboard and the MIDI IN or USB Device connector.

Multitrack recording procedure

Here is the general procedure to follow for the Multitrack Recording.

1. Press SEQUENCER to enter Sequence mode.
2. Press the RECORD button, and select the “Multitrack Sequencer” option to enter the Multitrack Record mode. Now you can prepare your recording parameters. (For more details, see “Record mode: Multitrack Sequencer page” on page 192).
3. Be sure the Overdub or Overwrite recording options is selected (see “Rec mode (Recording mode)” on page 192).
4. Set the tempo. There are two ways of changing tempo:
 - Keep the SHIFT button pressed, and use the TEMPO/VALUE controls to change the tempo.
 - Move the cursor to the “Tempo” parameter, and use the TEMPO/VALUE controls to change tempo.
5. Use the TRACK SELECT button to switch between Song Tracks 1-8 and Song Tracks 9-16, and assign the right Sound to each track (see “Sound bank’s icon” on page 190).
6. Select the track to record. Its status icon will automatically change to Record (see “Track status icons” on page 193).
7. Use the “Locate measure” parameter to enter a measure where you want to start recording.
8. Press ►/■ (PLAY/STOP) to start recording. Depending on the Metro option you selected, a 1- or 2-bars precount may play before the recording actually begins. After precount, play freely.
 - If you selected the Auto Punch recording mode, the recording will begin only when reaching the Start point.
 - If you selected the Pedal Punch recording mode, press the pedal when you want to begin recording. Press it again to finish recording.

Note: The Punch functions will not work on an empty Song. At least one track must already be recorded.
9. When finished recording, press ►/■ (PLAY/STOP) to stop the sequencer. Select a different track, and go on recording the whole Song.
10. When finished recording the new Song, either press the RECORD button, or select the “Exit from Record” command from the page menu (see page 212).

Warning: Save the Song to a storage device, to avoid it is lost when turning the instrument off.

Note: When exiting the Record mode, the Octave Transpose is automatically reset to “0”.
11. If you wish, edit the new Song, by pressing the MENU button, and selecting the various edit pages.

Record mode: Step Record page

The Step Record allows you to create a new Song by entering single notes or chords to each track. This is very useful when transcribing an existing score, or needing a higher grade of detail, and is particularly suitable to create drum and percussion tracks.

To access this page, select the “Overdub Step Recording” or “Overwrite Step Recording” command from the page menu.

In Overdub Step Recording mode you will add to existing events, while in Overwrite Step Recording mode you will overwrite all existing events.

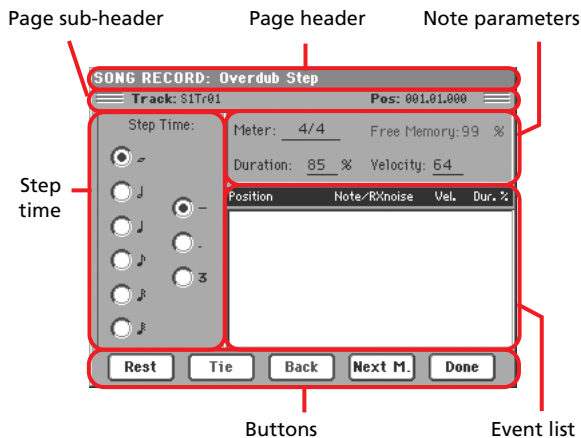

See “Step Record procedure” below, for information on the record procedure.

Page header

This line shows the current operating mode.

Page sub-header

Track

Name of the selected track in record.

S1Tr01...Tr16

Sequencer 1 track. In Sequencer mode, you always work with Sequencer 1.

Pos (Position)

This is the position of the event (note, rest or chord) to be inserted.

Step Time area

Step Time

Length of the event to be inserted.

- o ... ♪ Note value.
- Standard (–) Standard value of the selected note.
- Dot (.) Augments the selected note length by one half of its value.
- Triplet (3) Triplet value of the selected note.

Note parameter area

Meter

Time signature of the current measure. This parameter cannot be edited. You can set a Meter change by using the Insert function of the Edit menu, and inserting a new series of measures with a different Meter (see “Song Edit: Cut/Insert Measures” on page 209).

Free Memory

Available memory for recording.

Duration

Relative duration of the inserted note. The percentage is always referred to the step value.

- 50% Staccato.
- 85% Ordinary articulation.
- 100% Legato.

Velocity

Set this parameter before entering a note or chord. This will be the playing strength (i.e., velocity value) of the event to be inserted.

- Kbd Keyboard. You can select this parameter, by turning all counter-clockwise the dial. When this option is selected, the playing strength of the played note is recognized and recorded.
- 1...127 Velocity value. The event will be inserted with this velocity value, and the actual playing strength of the note played on the keyboard will be ignored.

Event list area

List of inserted events

Previously inserted events. You may delete the last of these events, and make it ready for a new event, by touching the Back button in the display.

- Position Position where the event has been inserted. The value is shown in the “measure.beat.tick” format.
- Note/RX Noise Name of the inserted Note or RX Noise. When entering a chord, a series of dots is shown after the name of the root note.
- Vel. Velocity of the inserted event.
- Dur.% Percentage duration of the inserted event.

Buttons

Rest

Touch this button to insert a rest.

Tie

Touch this button to tie the note to be inserted to the previous one. A note with the same pitch, and the specified length, will be created, and tied to the previous one.

Back

Goes to the previous step, erasing the inserted event.

Next M. (Next Measure)

Goes to the next measure, and fills the remaining space with rests.

Done

Exits the Step Record mode.

Step Record procedure

Here is the general procedure to follow for the Step Recording.

1. Press SEQUENCER to enter Sequencer mode.
2. Press the RECORD button, and select the “Multitrack Sequencer” option to enter the Multitrack Record mode. From the page menu, select the “Overdub Step Recording” or “Overwrite Step Recording” mode. At this point, the Step Record window will appear in the display.
3. The next event will be entered at the position shown by the Pos indicator in the upper right corner of the display.
 - If you don’t want to insert a note at this position, insert a rest instead, as shown in step 5.
 - To jump to the next measure, filling the remaining beats with rests, touch the Next M. button in the display.
4. To change the step value, use the Step Time parameters.
5. Insert a note, rest or chord at the current position.
 - To insert a single note, just play it on the keyboard. The inserted note length will match the step length. You may change the velocity and relative duration of the note, by editing the Velocity and Duration parameters. See “Velocity” and “Duration” on page 194.
 - To insert a rest, just touch the Rest button in the display. Its length will match the step value.
 - To tie the note to be inserted to the previous one, touch the Tie button in the display. A note will be inserted, tied to

the previous one, with exactly the same pitch. You don’t need to play it on the keyboard again.

- To insert a chord or a second voice, see “Chords and second voices in Step Record mode” on page 122 of the “Style Record mode” chapter.

6. After inserting a new event, you may go back by touching the Back button in the display. This will delete the previously inserted event, and set the step in edit again.
7. When finished recording, touch the Done button in the display. A dialog box appears, asking you to either cancel, discard or save the changes.

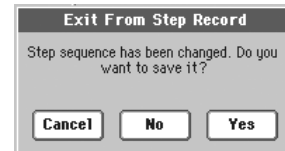

If you touch Cancel, exit is canceled, and you can continue editing. If you choose No, changes are not saved, and the Step Record window is closed. If you choose Yes, changes are saved, and the Step Record window is closed.

8. From the main page of the Multitrack Recording mode, either select the “Exit from Record” command from the page menu, or press the RECORD button to exit the Record mode.
9. While in the main page of the Sequencer mode, you may press the ►/■ (PLAY/STOP) button in the SEQUENCER 1 section to listen to the Song, or select the Save Song command from the page menu to save the Song to a storage device (see “Save Song window” on page 213).

Chords and second voices

With Pa800, you are not obliged to insert single notes in a track. There are several ways to insert chords and double voices. For more information, see “Chords and second voices in Step Record mode” on page 122 of the “Style Record mode” chapter.

Record mode: Backing Sequence (Quick Record) page

Backing Sequence (Quick Record) mode allows you to quickly record your live performance with the Styles. To make things easier, just two grouped tracks are provided: **Kbd/Pad** (Keyboard and Pads) to record keyboard and pads, and **Ch/Acc** (Chords/Accompaniment) to record Style commands and chords played on the keyboard.

While in Sequencer mode, press the RECORD button and select the “Backing Sequence (Quick Record)” option. The Backing Sequence (Quick Record) page appears.

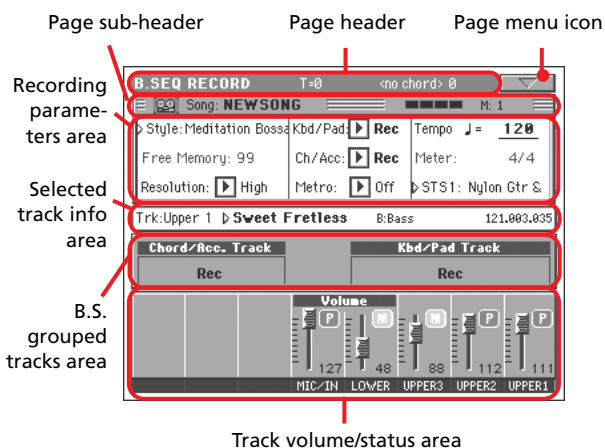

See “Backing Sequence (Quick Record) recording procedure” on page 197 for information on the record procedure.

Page header

See “Page header” on page 189.

Page menu icon

See “Page menu icon” on page 190.

Page sub-header

See “Page sub-header” on page 192.

Recording parameters area

Style

This parameter shows the selected Style. Either touch it, or press one of the STYLE buttons, to open the Style Select window and select a different Style (see “Style Select window” on page 81).

Free memory

Percentage of remaining memory for recording.

Resolution

Use this parameter to set the quantization during recording. Quantization is a way of correcting timing errors; notes played too soon or too late are moved to the nearest axis of a rhythmic “grid”, set with this parameter, thus playing perfectly in time.

High No quantization applied.

♪ (1/32)...♪ (1/8)

Grid resolution, in musical values. For example, when you select 1/8, all notes are moved to the nearest 1/8 division. When you select 1/4, all notes are moved to the nearest 1/4 division.



Chord/Acc, Kbd/Pad

These parameters let you define grouped track status during recording. This status is reflected by the big status indicator above the track sliders.

Play The Backing Sequence track is set to play. If there are recorded data, they will be heard while recording the other Backing Sequence track.

Mute The Backing Sequence track is muted. If this tracks has already been recorded, it will not be heard during recording of the other Backing Sequence track.

Rec The Backing Sequence track is in record. All previously recorded data will be deleted. After pressing ►/■ (PLAY/STOP) to start recording, the track will receive notes from the keyboard and the MIDI IN connector.

Ch/Acc: This Backing Sequence track groups all Style tracks, together with recognized chords and Style controls and Style Elements selection. After finishing recording, they will be saved as Song tracks 9-16, as in the following table:.

Chord/Acc track	Song track/Channel
Bass	9
Drum	10
Percussion	11
Accompaniment 1	12
Accompaniment 2	13
Accompaniment 3	14
Accompaniment 4	15
Accompaniment 5	16

Kbd/Pad: This Backing Sequence track includes the four Keyboard tracks and the four Pads. After finishing recording, they will be saved as Song tracks 1-8, as in the following table:

Kbd/Pad track	Song track/Channel
Upper 1	1
Upper 2	2
Upper 3	3
Lower	4
Pad 1	5
Pad 2	6
Pad 3	7
Pad 4	8

Metro (Metronome)

This parameter sets the metronome mode during recording.

Off	No metronome click will be heard during recording. A one-bar precount will be played before starting recording.
On1	Metronome on, with a one-bar precount before starting recording.
On2	Metronome on, with a two-bar precount before starting recording.

Tempo

Metronome tempo. Select this parameter and use the TEMPO/VALUE controls to change the tempo. As an alternative, when a different parameter is selected, or you are in a different page, keep the SHIFT button pressed and use the DIAL to change the tempo of the sequencer.

Meter

(*Non Editable*). This parameter shows the Time Signature of the selected Style for reference.

PERF or STS (Performance or STS)

This parameter shows the selected Performance or STS (depending on the latest item selected).

To select a Performance, either touch it, or press one of the PERFORMANCE/SOUND buttons (provided the PERFORMANCE SELECT LED is turned on), to open the Style Select window and select a different Performance (see “Style Select window” on page 81).

To select an STS, use the four SINGLE TOUCH SETTING buttons under the display.

Backing Sequence grouped tracks area

Grouped tracks status indicators

These giant indicators show the status of the Backing Sequence grouped tracks. They reflect the status of the Kbd/Pad and Ch/Acc parameters (see “Chord/Acc, Kbd/Pad” above).

Selected track info area

This line lets you see the Sound assigned to the selected track. See “Selected track info area” on page 190 for more information.

Track volume/status area

This area is where you can set the volume of each single Keyboard track, and mute/unmute tracks.

Virtual sliders (track volume)

Graphical display of each track’s volume. See “Virtual slider (track volume)” on page 191 for more information.

Individual track status icons

While you can change the status of all Keyboard tracks at once, by using the Kbd/Pad Backing Sequence track, you can also change the status of each single track. Touch this icon to change the status of the corresponding individual track.



Play status. The track can be heard.



Mute status. The track cannot be heard.

Track names

Under the sliders, a label for each track is shown.

MIC/IN	Audio inputs.
UPPER1...3	Upper tracks.
LOWER	Lower track.

Backing Sequence (Quick Record) recording procedure

Here is the general procedure to follow for the Backing Sequence (Quick) Recording.

1. Press SEQUENCER to enter the Song mode.
2. Press the RECORD button, and select the “Backing Sequence (Quick Record)” option to enter the Backing Sequence (Quick Record) mode. Now you can prepare your recording parameters. (For more details, see “Record mode: Backing Sequence (Quick Record) page” on page 196).
3. The latest selected Style is currently selected. If it is not the right one, select a different Style to start recording with. (See “Style Select window” on page 81).
4. The latest selected Performance or STS is currently selected. If you prefer, select a different Performance or STS. (See “Performance Select window” on page 80, and “STS Select” on page 82).
5. Select the status of the Backing Sequence grouped tracks, using the Kbd/Pad and Ch/Acc parameters. (Kbd/Pad stays for Keyboard and Pads; Ch/Acc stays for Chord and Accompaniment, i.e. the Style tracks). To record all you play on the keyboard, plus the automatic accompaniment, leave their status to Rec (see “Track status icons” on page 193).

Warning: Tracks set to REC are automatically overwritten when starting recording. Set a track to the PLAY or MUTE status, when you don’t want to delete it. For example, if you are recording a keyboard part on an existing Style track, set the Ch/Acc parameter to PLAY, and the Kbd/Pad track to REC.

6. Start recording by pressing the left ►/■ (PLAY/STOP) button or the START/STOP button.

- By pressing the left ►/■ (PLAY/STOP) button (or the START/STOP button), you can record a keyboard intro with no Style playing. After a count-in (see “Metro (Metronome)” on page 197), you can start recording.

Play a solo intro, then start the auto-accompaniment by pressing the START/STOP button.

- By pressing the START/STOP button you can start the Style right at the beginning of the Song.

Since you can use any Style control, you could start with the usual combinations (INTRO, ENDING, FILL... see “Selecting and playing a Style” on page 45 for more information).

Note: While in Backing Sequence mode, you can't record the SYNCHRO, TAP TEMPO/RESET, MANUAL BASS, ACCOMPANIMENT VOLUME controls.

7. Play your music. While recording you can even change the Style, or stop it by pressing START/STOP or one of the ENDINGS. While recording you can even start the style again, by pressing START/STOP.

8. When finished recording your performance, press the ►/■ (PLAY/STOP) button in the SEQUENCER 1 section. You will go back to the Sequencer Play Main page (see “Sequencer Play - Main page” on page 189).

At this point, you may press the ►/■ (PLAY/STOP) button in the SEQUENCER 1 section to listen to the new Song.

You may also edit the Song by pressing the MENU button (see “Edit menu” on page 201).

9. Save the song to a storage device (see “Save Song window” on page 213).

Warning: The recorded Song is in RAM (Random Access Memory), and will be deleted when turning the instrument off, switching to the Style Play or Song Play mode, or entering Record again. If you wish to preserve it, save the Song to a storage device.

Record mode: Step Backing Sequence page

The Step Backing Sequence mode allows you to enter single chords, to create or edit the Style (Chord/Acc) part of a Song. This mode lets you enter chords even if you are not a keyboard player, or fix any error made playing chords or selecting Style controls, during a Backing Sequence (Quick Record) recording.

In this mode, you can only edit Songs created using the Backing Sequence (Quick Record) recording mode. When saving a Song created using the Backing Sequence (Quick Record) recording mode, all Chord/Acc data is preserved, and can be loaded later, to be edited again by using the Step Backing Sequence mode.

While in Sequencer mode, press the RECORD button and select the “Step Backing Sequence” option. The Step Backing Sequence window appears.

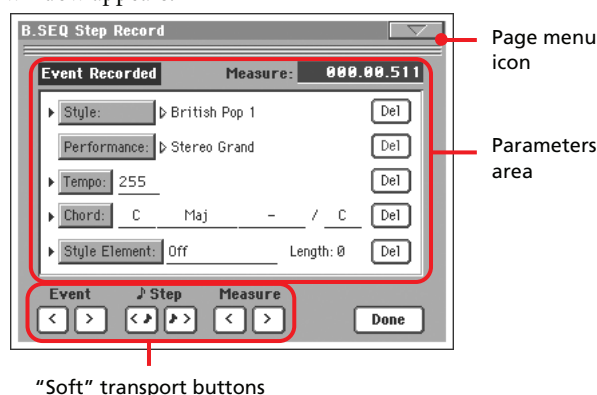

“Soft” transport buttons

See “Step Backing Sequence procedure” on page 200 for information on the record procedure.

Page menu icon

Touch the page menu icon to open the menu. See “Step Backing Sequence page menu” on page 200 for more information.

Parameters area

Side arrow (▶)

The small arrow next to a parameter means that its value is effective at the current position. For example, if you are at the “003.01.000” position, and an arrow lights up next to the Chord parameter, this means that a chord change happens at the “003.01.000” position.

Measure

This parameter shows the current position of the Step Editor. To go to a different position within the Song, use one of the following systems:

- Select this parameter, then use the TEMPO/VALUE controls to go to a different measure.
- Use the Measure buttons in the display to move to a different measure. Use the Step buttons in the display to move in steps of 1/8 (192 ticks). Use the Event buttons in the display to jump to the next event.

The locator value is shown in the “measure.beat.tick” format.

Measure	Measure or bar number.
Beat	Divider in the Time Signature ratio (e.g., a quarter in a 3/4 time).
Tick	Smallest position value. Both Pa800 internal sequencers feature a resolution of 384 ticks per quarter.

Style

This is the latest selected Style. To insert a Style change at the current position, touch the Style name to open the Style Select window, or follow the standard selecting procedure using the buttons of the STYLE SELECT section.

Note: Any Style Change inserted after the beginning of the measure (i.e., to a position other than Mxxx.01.000) will be effective at the following measure. For example, if a Style Change event has been inserted at M004.03.000, the selected Style will be effectively selected at M005.01.000. (This works exactly as in Style Play mode).

Note: When inserting a Style Change, you may also insert a Tempo Change at the same position. A Style Change will not automatically insert the Style’s Tempo.

Performance

This is the latest selected Performance. Select a Performance to recall the Style it links to. To insert a Performance change at the current position, touch the Performance name to open the Performance Select window, or follow the standard selecting procedure using the PERFORMANCE/SOUND SELECT section.

Note: The STYLE CHANGE LED is automatically turned on when entering the Chord/Acc Step Mode. This means that selecting a Performance automatically selects the Style memorized in the Performance.

The SINGLE TOUCH and STS buttons are automatically disabled, meaning that you can’t change Keyboard tracks while in Chord/Acc Step Mode.

Tempo

This is the Tempo Change parameter. To insert a Tempo Change event at the current position, select this parameter and use the TEMPO/VALUE controls to change its value.

Chord

The chord parameter is divided in four separate parts:

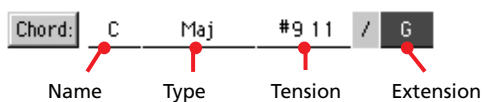

Select one of the parts, then use the TEMPO/VALUE controls to modify it. As an alternative, you can play a chord, and it will be automatically recognized. While recognizing a chord, the status of the BASS INVERSION button will be considered.

The lack of a chord (--) means that the accompaniment will not play at the current position (apart for the Drum and Percussion tracks). To select the “--” option, select the Name part of the Chord parameter, then use TEMPO/VALUE controls to select the very last value (C...B, Off).

Note: If you replace a chord with a different one, please remember that the Lower track (if recorded) will not be automatically changed, and may cause a dissonance against the accompaniment.

Style Element

This is the Style Element (i.e., a Variation, Fill, Intro, or Ending). The length of the selected Style Element is always shown by the “Length” parameter (see below).

“Off” means that the accompaniment will not play at the selected position – only Keyboard and Pad tracks will play.

Hint: Insert a Style Element Off event exactly where the automatic accompaniment must stop (at the end of the Song).

Length

This parameter will let you know where to place the following Style Element Change. For example, if you inserted an Intro event lasting for 4 measures, you can insert 4 empty measure after this event, and a Variation event at the end of the Intro, beginning at the 4th empty measure.

Del (Delete) button

When a side arrow (⬅) is shown next to a parameter, there is an event at the current position. You can touch the Del button next to it, to delete the event at the current position.

Hint: To delete all events starting from the current position, select the “Delete All from Selected” command from the page menu (see below).

“Soft” transport buttons



Use these buttons to move to the previous or next recorded event.



Use these buttons to go to the previous or next step (1/8, or 192 ticks). If an event is located before the previous or next step, the locator stops on that event. For example, if you are positioned on M001.01.000, and no event exists before M001.01.192, the > button moves to the M001.01.192 location. If an event exists on M001.01.010, the > button stops to the M001.01.010 location.

These commands are effective even if the Measure parameter is not selected.



Use these buttons to move to the previous or following measure. These commands are effective even if the Measure parameter is not selected.

Done button

Done

Touch this button to exit the Step Backing Sequence mode. All changes will be saved to memory.

Hint: Save the Song to a storage device, by selection the “Save Song” command from the page menu, to avoid losing it when turning the instrument off.

Step Backing Sequence page menu

Touch the page menu icon to open the menu. Touch a command to select it. Touch anywhere in the display to close the menu without selecting a command.

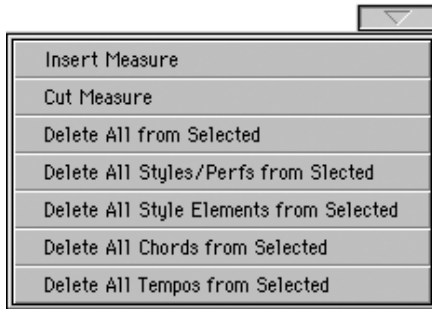

Insert Measure

Use this command to insert an empty measure starting from the current measure. All Chord/Acc events contained in the current measure will be moved to the following measure. The event at the Mxxx.xx.000 position (i.e., exactly at the beginning of the measure, like a Time Signature or Style change) will not be moved.

Cut Measure

Use this command to delete the current measure. All Chord/Acc event contained in the following measures will be moved one measure back.

Delete All from Selected

Use this command to delete events of all types, starting from the current position.

Note: All events on the very first tick (M001.01.000), like Perf, Style, Tempo, Chord, Style Element selection, cannot be deleted.

Delete All Styles/Perfs from Selected

Delete All Style Elements from Selected

Delete All Chords from Selected

Delete All Tempos from Selected

Select one of these commands to delete all events of the corresponding type, starting from the current position to the end of the Song. **To delete all events of the same type from the whole Song**, go back to the M001.01.000 position, and select one of these commands.

Note: All events on the very first tick (M001.01.000), like Perf, Style, Tempo, Chord, Style Element selection, cannot be deleted.

Step Backing Sequence procedure

Here is the general Step Backing Sequencer recording procedure.

Hint: Before entering Step Backing Sequence mode to edit an existing Song, select the “Save Song” command from the page menu, and save the Song to a storage device. This way, you will have a copy of the Song, in case you don’t like the results of your editing.

1. While in Sequencer mode, press the RECORD button, and choose the “Step Backing Sequence” recording option.
2. Select the Measure parameter, and go to the desired position in the Song, by using the TEMPO/VALUE controls. Alternatively, you can move the locator using the “soft” transport buttons in the display. See “Soft” transport buttons” on page 199.
3. Select the parameter type (Style, Performance, Tempo...) to insert, edit or delete at the current position. If an arrow (▶) appears next to a parameter, the shown event has been inserted at the current position.
4. Use the TEMPO/VALUE controls to modify the selected event. Delete it by touching the Del button next to the event. When editing a parameter without the arrow (▶) next to it, a new event is inserted at the current position.
5. Exit the Step Backing Sequence recording mode, by touching the Done button in the display.
6. Press ▶/■ (PLAY/STOP) in the SEQUENCER 1 section to listen to the consequence of your editing. If they are fine, save the Song to a storage device.

Edit menu

From any page, press the MENU button to open the Sequencer edit menu. This menu gives access to the various Sequencer edit sections.

When in the menu, select an edit section, or press EXIT to exit the menu.

When in an edit page, press EXIT or the SEQUENCER button to go back to the main page of the Sequencer operating mode.

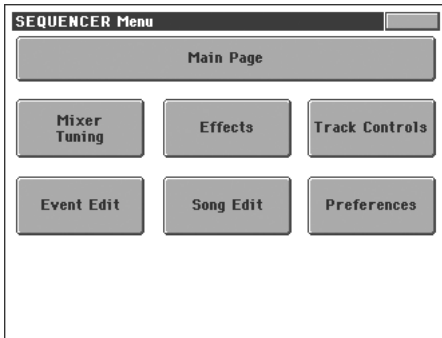

Each item in this menu corresponds to an edit section. Each edit section groups various edit pages, that may be selected by touching the corresponding tab on the lower part of the display.

Edit page structure

All edit pages share some basic elements.

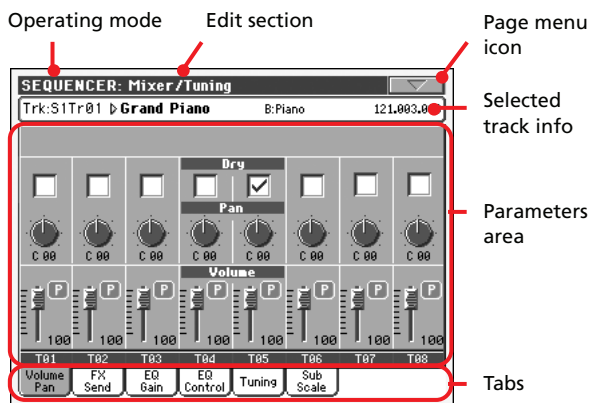

Operating mode

This indicates that the instrument is in Sequencer mode.

Edit section

This identifies the current edit section, corresponding to one of the items of the edit menu (see “Edit menu” on page 201).

Page menu icon

Touch this icon to open the page menu (see “Page menu” on page 211).

Parameters area

Each page contains various parameters. Use the tabs to select one of the pages. For detailed information on the various types of parameters, see sections starting from page 201.

Tabs

Use tabs to select one of the edit pages of the current edit section.

Mixer/Tuning: Volume/Pan

This page lets you set the volume and pan for each Song track.

Use the TRACK SELECT button to switch between Song tracks 1-8 and 9-16.

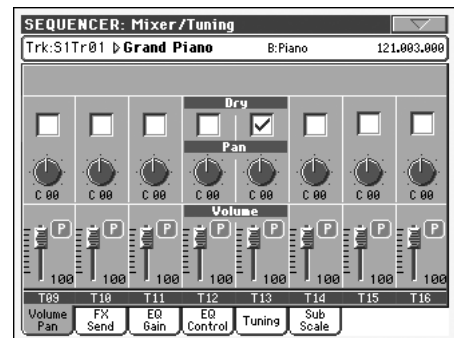
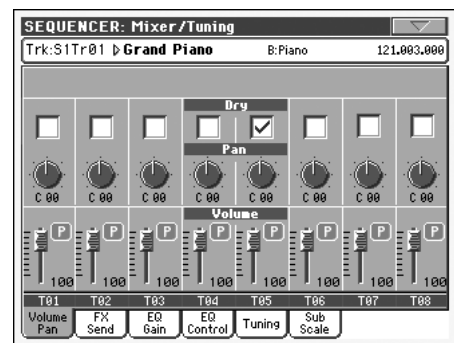

Dry

► SONG

Use this checkbox to turn the dry (direct) signal on or off.

Note: If the track is sent to a separate output, no FX is sent to any output. To program the output status for each track, see “Audio Setup: Seq1” on page 227.

On

When checked, the direct, dry signal is sent to the output, mixed with the FXs.

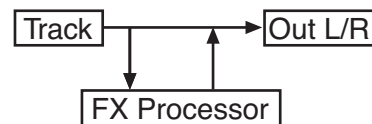

Off

When unchecked, the direct, dry signal is removed from the audio output, and only sent to the FXs. The effected signal will still be panned (in stereo FXs only) according to the Pan value.

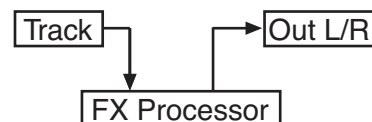

Pan

Track position in the stereo field.

L-64...L-1 Left stereo channel.

C 00 Center.

R+1...R+63 Right stereo channel.

Volume

Track's volume.

0...127 MIDI value of the track's volume.

Play/Mute icon

Track's play/mute status.

 Play status. The track can be heard.

 Mute status. The track cannot be heard.

► SONG

► SONG

► SONG

Mixer/Tuning: FX Send

This page lets you set the level of the track's direct (unaffected) signal going to the Internal FX processors. The effect processors included in Pa800 are connected in parallel, so you can decide which percentage of the direct signal can be effected.

In case you want to send all of a track's signal to the effect (as when using "insert" effects, like Rotary, Distortion, EQ...), just set the Dry parameter to Off (see "Dry" above).

There are four Internal FX processors in Sequencer mode, grouped in two pairs (AB and CD). Usually you will create Songs with only a pair (preferably AB), but you can create Songs using both FX pairs. We suggest to use A and C as reverb processors, and B and D as modulating effect processors.

Use the TRACK SELECT button to switch between Song tracks 1-8 and 9-16, and vice-versa.

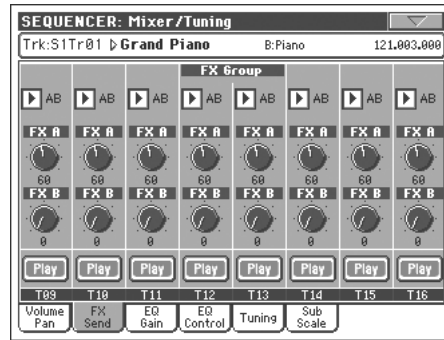
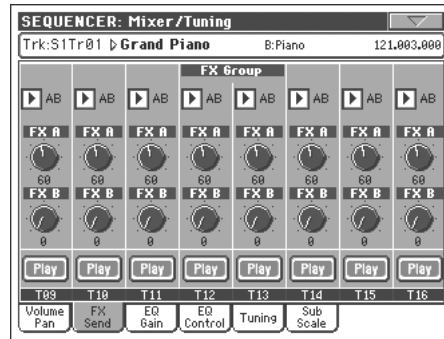

FX Groups

► SONG

Use this pop-up menu to select one of the two FX groups (AB or CD).

Send level

► SONG

0...127 Level of the track (direct) signal sent to the effect processor.

Play/Mute icon

► SONG

Track's play/mute status.

 Play status. The track can be heard.

 Mute status. The track cannot be heard.

Mixer/Tuning: EQ Gain

In this page you can set the three-band equalization (EQ) for each individual track.

Use the TRACK SELECT button to switch between Song tracks 1-8 and 9-16, and vice-versa.

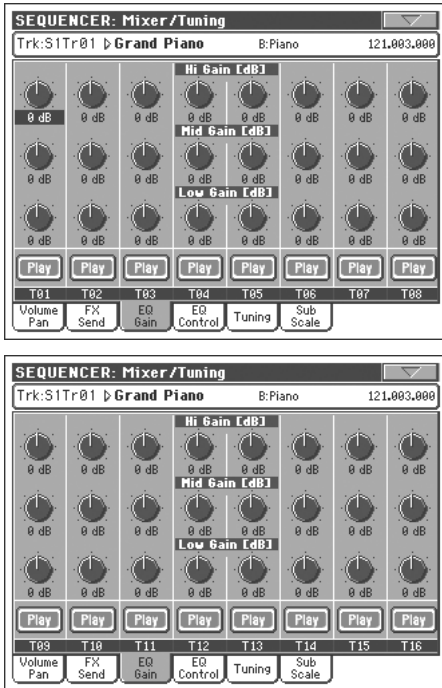

Hi (High) Gain ▶PERF ▶PERF^{Sty} ▶STS

This parameter lets you adjust the high frequencies equalization on each individual track. This is a shelving curve filter. Values are shown in decibels (dB).

Mid (Middle) Gain ▶PERF ▶PERF^{Sty} ▶STS

This parameter lets you adjust the middle frequencies equalization on each individual track. This is a bell curve filter. Values are shown in decibels (dB).

Low Gain ▶PERF ▶PERF^{Sty} ▶STS

This parameter lets you adjust the low frequencies equalization on each individual track. This is a shelving curve filter. Values are shown in decibels (dB).

Play/Mute icon ▶SONG

Track's play/mute status.



Play status. The track can be heard.



Mute status. The track cannot be heard.

Mixer/Tuning: EQ Control

This page lets you reset or bypass track equalization, programmed in the previous page.

Use the TRACK SELECT button to switch between Song tracks 1-8 and 9-16, and vice-versa.

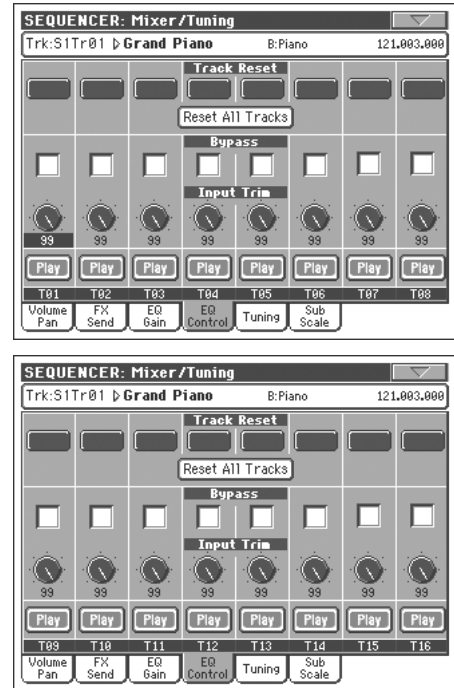

Track Reset buttons

Use these buttons to reset (i.e., “flatten”) equalization for the corresponding track.

Reset All Tracks button

Touch this button to reset (i.e., “flatten”) equalization for all tracks.

Bypass

Check any of these checkboxes to bypass equalization for the corresponding track. When bypassed, equalization has no effect on the track, but all parameters are preserved. When the box is unchecked, equalization is activated again with the original settings.

Input Trim

This knob allows you to limit the level of the signal passing through the equalizer. Extreme equalization values can overload the audio circuits and lead to distortion. This control lets you set equalization as desired, and at the same time avoid overloading.

Play/Mute icon ▶SONG

Track's play/mute status.



Play status. The track can be heard.



Mute status. The track cannot be heard.

Mixer/Tuning: Tuning

Parameters

► SONG

See “Mixer/Tuning: Tuning” on page 96.

Mixer/Tuning: Sub Scale

This page lets you program an alternative scale for the selected tracks (via the “Track Assign” parameter). The remaining tracks (if any) use the basic scale set in Global mode (see “Main Scale” on page 217).

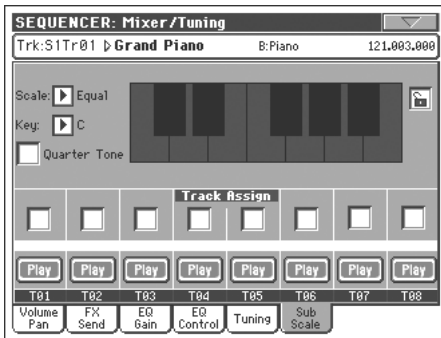

Note: Quarter Tone selection and activation of the Sub-Scale on each track of a Song, can be received by MIDI (i.e., by an external sequencer or controller). Conversely, selection of Quarter Tone settings, or activation of the Sub-Scale on each track of the Song, can be sent by the Pa800 to an external MIDI recorder as System Exclusive data.

Parameters

► SONG

See “Mixer/Tuning: Sub Scale” on page 96.

Track Assign

► SONG

Check the parameter corresponding to each track where the Sub-Scale must be used.

Play/Mute icon

► SONG

Track’s play/mute status.



Play status. The track can be heard.



Mute status. The track cannot be heard.

Effects: FX Select

This page allows you to select effects to be assigned to the four Internal FX processors (A-D).

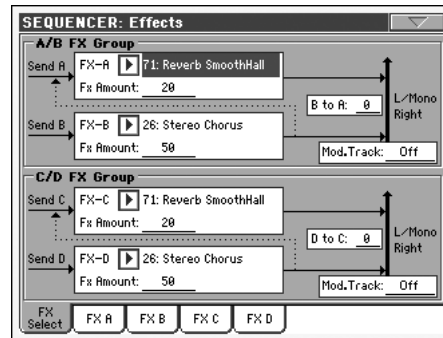

Note: When you stop the Song, or select a different Song, the default effects are selected again. You can, however, stop the Song, change the effects, then start the Song again. Save the Song to permanently change the effects.

FX A...D

► SONG

Effects assigned to the corresponding effect processors. Usually, A and C are reverbs, while B and D are modulating effects (chorus, flanger, delay...). For a list of the available effects, see the “Advanced Edit” addendum in the Accessory CD.

FX Amount

► SONG

Volume of the effect, that is added to the dry (unaffected) signal.

B to A, D to C

► SONG

Amount of the B effect going back to the input of the A effect, or of the D effect going back to the input of the C effect.

Mod.Track (Modulating Track)

► SONG

Source track for modulating MIDI messages. You can modulate an effect parameter with a MIDI message generated by a physical controller.

Effects: FX A...D

These pages contain the editing parameters for the four effect processors. Here is an example of the FX A page, with the Reverb Smooth Hall effect assigned.

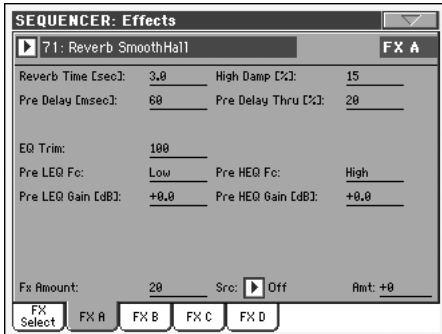

Selected effect

► SONG

Select one of the available effects from this pop-up menu. This is equivalent to the “FX A...D” parameters found in the “Effects: FX Select” page (see above).

Parameters

► SONG

Parameters may differ, depending on the selected effect. See the “Advanced Edit” addendum in the Accessory CD for a list of available parameters for each effect type.

Track Controls: Mode

Parameter

► SONG

See “Track Controls: Mode” on page 99.

Track Controls: Drum Volume

Parameter

► SONG

See “Track Controls: Drum Volume” on page 205.

Track Controls: Easy Edit

Parameter

► SONG

See “Track Controls: Easy Edit” on page 101.

Event Edit: Event Edit

The Event Edit is the page where you can edit each single MIDI event of the selected track. You can, for example, replace a note with a different one, or change its playing strength. See also “Event Edit procedure” on page 206 for more information on the event editing procedure.

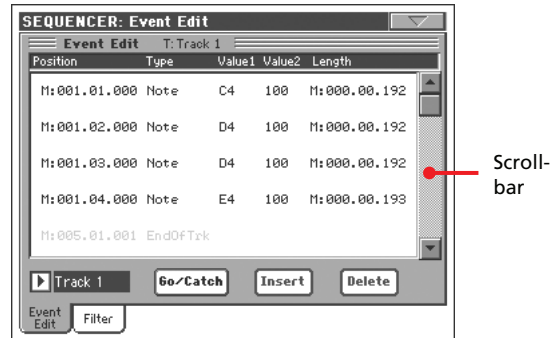

Position

Position of the event, expressed in the form ‘aaa.bb.ccc’:

- ‘aaa’ is the measure
- ‘bb’ is the beat
- ‘ccc’ is the tick (each quarter beat = 384 ticks)

You can edit this parameter to move the event to a different position. You can edit a position in either of the following ways:

- select the parameter, and use the TEMPO/VALUE controls to change the value, or
- select the parameter, then touch it again; the numeric keypad will appear. Enter the new position by dialing in the three parts of the number, separated by a dot. Zeroes at the beginning can be omitted, as well as the least important parts of the number. For example, to enter position 002.02.193, dial “2.2.193”; to enter position 002.04.000 dial “2.4”; to enter position 002.01.000, simply dial “2”.

Type

Type of the event shown in the display. To edit it, select the parameter and use the TEMPO/VALUE controls to change its value.

Value 1 and 2

Values of the event shown in the display. Depending on the selected event, the value may change. This parameter also shows the (non editable) “End Of Track” marking, when the end of the track is reached.

Here are the events contained in ordinary tracks (1-16).

Type	First value	Second value
Note	Note name	Velocity
RX Noise	Note name	Velocity
Prog	Program Change number	–
Ctrl	Control Change number	Control Change value
Bend	Bending value	–
Aftt	Mono (Channel) Aftertouch value	–
PAft	Note to which the Aftertouch is applied	Poly Aftertouch value

And here are the events contained in the Master track.

Type	First value	Second value
Tempo	Tempo change	–
Volume	Master Volume value	–
Meter	Meter change ^(a)	–
KeySign	Key Signature ^(b)	–
Scale	One of the available pre-set Scales	Root note for the selected Scale
UScale (User Scale)	Altered note	Note alteration ^(c)
QT (Quarter Tone)	Altered note	Note alteration (0, 50) ^(b)
QT Clear (Quarter Tone Clearing)	Reset of all Quarter Tone (QT) changes	–
FXType	One of the four available FX processors	Effect number ^(d)
FXSend	Feedback Send (B>A or D>C)	Feedback send level

- (a). Meter changes can't be edited or inserted separately from a measure. To insert a Meter change, use the Insert function in the Edit section and insert a series of measures with the new meter. Existing data can then be copied or entered to these measures
- (b). This is the key signature shown in the Score. If this event is missing, the Score will be shown as if it was in the key of C Major.
- (c). To edit User Scale and Quarter Tone settings, select the first value, then select the scale's degree to edit. Edit the second value to change the tuning of the selected note of the scale.
- (d). When selecting a different effect number during this edit, default settings will be assigned to this event.

To edit the event Type and Values, select the parameter and use the TEMPO/VALUE controls to change their value. In case of numeric values, you can also tap them twice to open the numeric keypad.

Length

Length of the selected Note event. The value format is the same as the Position value. Edit it in the same way.

Note: If you change a length of "000.00.000" to a different value, you can't go back to the original value. This rather uncommon zero-length value may be found in the drum and percussion tracks of Songs made in Backing Sequence mode.

Track

Use this pop-up menu to select the track to edit.

- Track 1...16 One of the ordinary tracks of the Song. These tracks contains musical data, like notes and controllers.
- Master This is a special track, containing Tempo changes, Meter changes, Scale and Transpose data, and the effect parameters.

Scrollbar

Use the scrollbar to browse the event through the list. You can also scroll by using the SHIFT + DIAL combination.

Go/Catch

This is a dual-function command.

- While the sequencer is not running, it works as a Go to Measure command. Touch it to open the Go to Measure dialog box:



When in this dialog box, select a target measure, and touch OK. The first event available in the target measure will be selected.

- While the sequencer is running, it works as a Catch Locator command. Touch it to show the event that is currently playing.

Insert

Touch the Insert button in the display to insert a new event at the current shown Position. The default values are Type = Note, Pitch = C4, Velocity = 100, Length = 192.

Note: You can't insert new events in an empty, non-recorded Song. To insert an event, you must first insert some empty measures by using the Insert Measure function (see "Song Edit: Cut/Insert Measures" on page 209).

Delete

Touch the Delete button in the display to delete the event selected in the display.

Note: The "End of Track" event cannot be deleted.

Event Edit procedure

Here is the general event editing procedure.

1. While in the Event Edit page, press ►/■ (PLAY/STOP) in the SEQUENCER 1 section to listen to the Song. Press it again to stop the Song.
2. Select the Filter page, and turn "Off" the filter for the event types you wish to see in the display (see "Event Edit: Filter" on page 207 for more information).
3. Return to the Event Edit page.
4. Use the "Track" pop-up menu to select the track to edit. The list of events contained in the selected track will appear in the display.

For more information on the event types and their values, see above.

5. Select the "Position" parameter. Use the TEMPO/VALUE controls (or touch the parameter again to open the numeric keypad) to change the event's position.
6. Select the "Type" parameter and use the TEMPO/VALUE controls to change the event type. Select the "Value 1 and 2" parameters and use the TEMPO/VALUE controls (or touch the parameter again to open the numeric keypad) to modify the selected value.

7. In the case of a Note event, select the Length parameter, and use the TEMPO/VALUE controls (or touch the parameter again to open the numeric keypad) to change the event's length.
 - While the sequencer is not running, you may touch the Go/Catch button in the display to go to a different measure (see "Go/Catch" above)
 - While the sequencer is running, you may use the Go/Catch button in the display to see the currently playing event in the display (see "Go/Catch" above).
 - Use SEQUENCER 1 transport controls to listen to the Song.
8. Touch the insert button in the display to insert an event at the Position shown in the display (a Note event with default values will be inserted). Touch the Delete button in the display to delete the selected event.
9. When the editing is complete, you may select a different track (go to step 4).
10. When finished editing the whole Song, select the Save Song command from the page menu to save the Song to a storage device. See "Save Song window" on page 213 for more information on saving a Song.

Event Edit: Filter

This page is where you can select the event types to be shown in the Event Edit page.

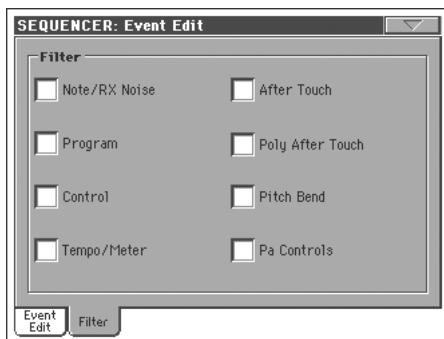

Turn On the filter for all event types you do not wish to see in the Event Edit page.

- Note/RX Noise Notes and RX Noises.
- Program Program Change events.
- Control Control Change events.
- Tempo/Meter Tempo and Meter changes (Master Track only).
- After Touch Mono (Channel) Aftertouch events.
- Poly After Touch Poly Aftertouch events.
- Pitch Bend Pitch Bend events.
- Pa Controls Controls exclusive of the Pa800, like the FX and Scale settings. These controls are recorded to the Master Track, and saved as System Exclusive data.

Song Edit: Quantize

The quantize function corrects any rhythm error after recording.



After setting the various parameters, touch Execute to start the operation.

Track

- All Quantize will apply to all tracks.
- Track 1...16 Quantize will apply only to the selected track.

Resolution

This parameter sets the quantization value. For example, when you select ♩ (1/8), all notes are moved to the nearest 1/8 division. When you select 1/4, all notes are moved to the nearest 1/4 division.

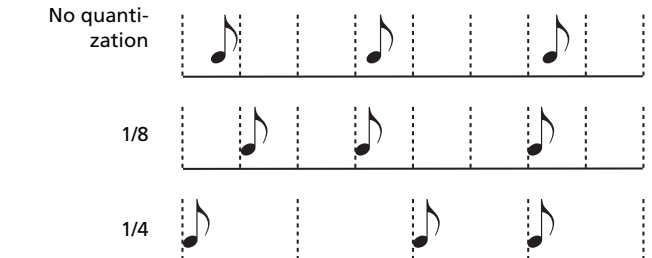

♩ (1/32)...♩ (1/4)

Grid resolution, in musical values. A "b...f" character added after the value means swing-quantization. A "3" means triplet.

Start / End Tick

Use these parameters to set the starting and ending points of the range to be quantized.

If you wish to select a four-measure sequence starting at the beginning of the Song, the Start will be positioned at 1.01.000, and the End at 5.01.000.

Bottom / Top Note

Use these parameters to set the bottom and top note of the keyboard range to quantize. If you select the same note as the Bottom and Top parameters, you can select a single percussive instrument in a Drum track.

Note: These parameters are available only when a Drum track is selected.

Song Edit: Transpose

Here you can transpose the Song, a track or a part of a track.

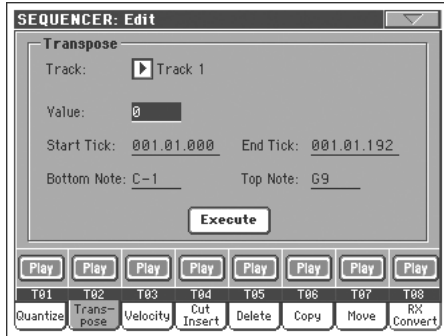

After setting the various parameters, touch Execute to start the operation.

Track

Use this parameter to select a track.

All All tracks selected (apart for Drum tracks).

Track 1...16 Selected track.

Value

Transpose value (± 127 semitones).

Start / End Tick

Use these parameters to set the starting and ending points of the range to transpose.

If you wish to select a four-measure sequence starting at the beginning of the Song, the Start will be positioned at 1.01.000, and the End at 5.01.000.

Bottom / Top Note

Use these parameters to set the bottom and top of the keyboard range to transpose. If you select the same note as the Bottom and Top parameters, you can select a single note, or a single percussive instrument in a Drum track.

Song Edit: Velocity

Here you can change the Velocity value for the notes. An Advanced mode is available, allowing you to select a velocity curve for the selected range. This is useful to create fade-ins or fade-outs.

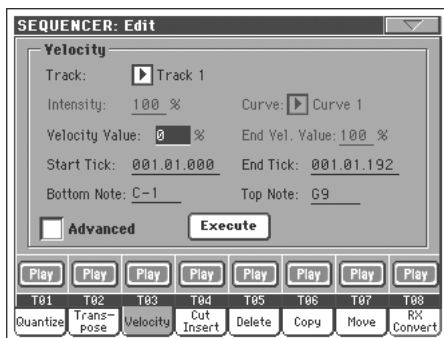

After setting the various parameters, touch Execute to start the operation.

Track

Use this parameter to select a track.

All All tracks selected.

Track 1...16 Selected track.

Value

Velocity change value.

Start / End Tick

Use these parameters to set the starting and ending points of the range to edit.

If you wish to select a four-measure sequence starting at the beginning of the Song, the Start will be positioned at 1.01.000, and the End at 5.01.000.

Bottom / Top Note

Use these parameters to set the bottom and top of the keyboard range to edit. If you select the same note as the Bottom and Top parameters, you can select a single percussive instrument in a Drum track.

Advanced

When this checkbox is checked, the “Intensity”, “Curve”, “Start Velocity Value” and “End Velocity Value” parameters can be edited.

Intensity

(Only available in Advanced mode). Use this parameter to specify the degree to which the velocity data will be adjusted toward the curve you specify in “Curve”.

0...100% Intensity value. With a setting of 0 [%], the velocity will not change. With a setting of 100 [%], the velocity will be changed the most.

Curve

(Only available in Advanced mode). Use this parameter to select one of the six curves, and to specify how the velocity will change over time.

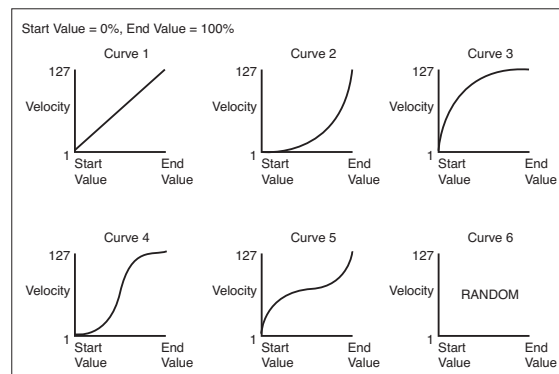

Start / End Vel. Value

(Only available in Advanced mode). Velocity change at the starting and ending ticks of the selected range.

0...100 Velocity change in percentage.

Song Edit: Cut/Insert Measures

In this page you can cut or insert measures from the Song.

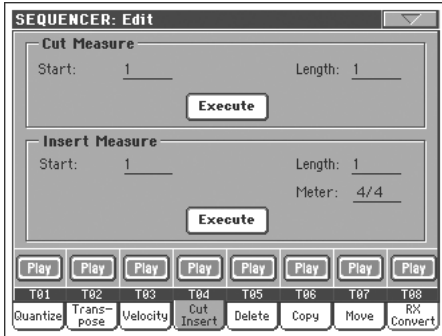

After selecting the Start and Length parameters, touch Execute to start the operation.

After the Cut, the following measures are moved back, to fill the cut measures.

After the Insert, the following measures are pushed forward to accommodate the inserted measures.

Start

First measure where to begin cutting/inserting.

Length

Number of measures to be cut/inserted.

Meter

Meter of the measures to be inserted.

Song Edit: Delete

This page is where you can delete MIDI events from the Song.

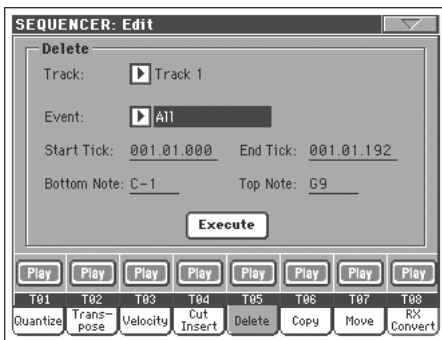

After setting the various parameters, touch Execute to start the operation.

Track

Use this parameter to select a track.

- All All tracks selected.
- Track 1...16 Selected track.
- Master Master track. This is where the Tempo, Scale and Effect events are recorded.

Event

- Type of MIDI event to delete.
- All All events. Measures will not be removed from the Song, and will remain empty.
- Note All notes in the selected range.
- Dup.Note All duplicate notes. When two notes with the same pitch are encountered on the same tick, the one with the lowest velocity is deleted.
- After Touch After Touch events.
- Pitch Bend Pitch Bend events.
- Prog.Change Program Change events, excluding the bundled Control Change #00 (Bank Select MSB) and #32 (Bank Select LSB).
- Ctl.Change All Control Change events, for example Bank Select, Modulation, Damper, Soft Pedal...
- CC00/32...CC127 Single Control Change events. Double Control Change numbers (like 00/32) are MSB/LSB bundles.

Start / End Tick

Use these parameters to set the starting and ending points of the range to edit.

If you wish to select a four-measure sequence starting at the beginning of the Song, the Start will be positioned at 1.01.000, and the End at 5.01.000.

Bottom / Top Note

Use these parameters to set the bottom and top of the keyboard range to delete. If you select the same note as the Bottom and Top parameters, you can select a single note, or a single percussive instrument in a Drum track.

Note: These parameters are available only when the All or Note options are selected.

Song Edit: Copy

Here you can copy tracks or phrases.

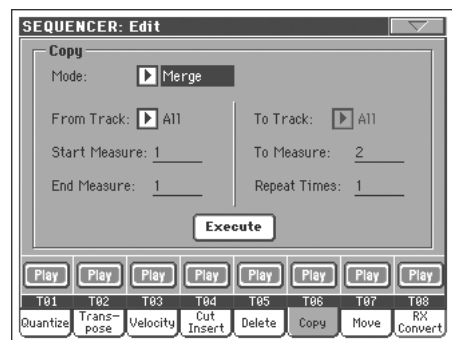

After setting the various parameters, touch Execute to start the operation.

Note: If you copy too many events on the same "tick", the "Too many events!" message appears, and the copy operation is aborted.

Mode

Use this parameter to select the Copy mode.

- Merge Copied data are merged with the data at the target position.
 - Overwrite Copied data replace all data at the target position.
- Warning:** Deleted data cannot be recovered!

From Track... To Track

- All All tracks. The target track cannot be selected.
- Track 1...16 Selected source and target tracks.

Start Measure... End Measure

These parameters are the starting and ending measure to copy. For example, if From Measure=1 and To Measure=4, the first four measures are copied.

To Measure

This parameter is the first of the target measures.

Repeat Times

Number of times the copy must be executed. Copies will be consecutive.

Song Edit: Move

Here you can shift a track forward or backward by just a few ticks or whole measures.

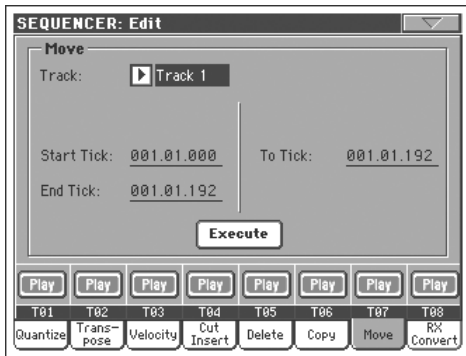

After setting the various parameters, touch Execute to complete the operation.

Track

Use these parameters to select the track you want to move.

- Track 1...16 Selected track.

Start / End Tick

These parameters set the starting and ending point of the range to move.

To Tick

This parameter allows you to set the target starting point of the moved track.

Song Edit: RX Convert

You can use the RX Convert page to convert notes of the midifile into RX Noises, and vice-versa. This will help programming Songs on an external sequencer.

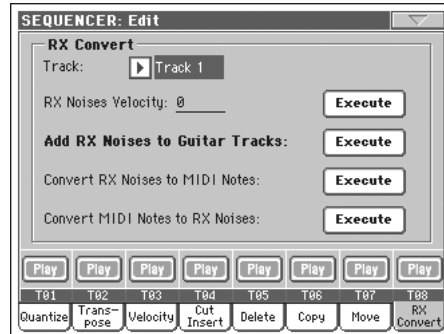

After having chosen a track to convert, touch Execute to complete the operation.

Track

Use these parameters to select the track containing the notes or RX Noises you want to convert.

RX Note Velocity

Use this parameter to adjust the volume level of the RX Noises in the selected track(s).

Add RX Noises to Guitar track

Use this parameter to automatically analyze the Standard MIDI File, and add RX Noises to Guitar tracks. This command scans a single track or the whole Standard MIDI File, looking for guitar strummings played by nylon, steel or electric guitars.

After scanning, a suitable Guitar sound will be automatically assigned to the relevant tracks, and RX Noises automatically added where needed.

This means that you can transform any flat SMF into an ultra-realistic song with a real guitar player inside – at the touch of a button!

Preferences: Sequencer Setup

In this page, you can select a MIDI Setup and the Harmony track for the Sequencer mode.

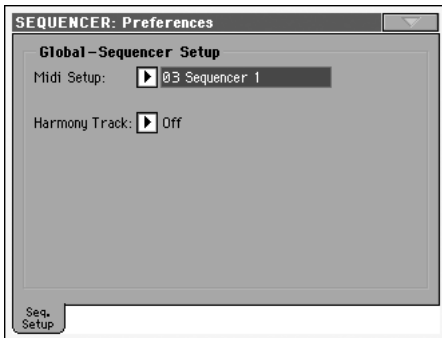

Note: These settings are stored in the Sequencer Setup area of the Global file. (Parameter of this kind are marked with the ▶GBL^{Seq} abbreviation through the manual). After changing these settings, select the Write Global-Sequencer Setup command from the page menu to save them to the Global.

Midi Setup ▶GBL^{Seq}

MIDI channels for the Sequencer mode can be automatically configured by selecting a MIDI Setup with this parameter. See “MIDI” on page 263 for more information on using MIDI Setups.

Note: To automatically select a MIDI Setup when entering the Sequencer mode, select the Write Global-Sequencer Setup command from the page menu.

For detailed information on MIDI Setup settings, see “MIDI Setup” on page 314.

Note: After selecting a MIDI Setup, you can go to the Global mode and apply any change to each channel setting. To store these changes to a MIDI Setup, while still in Global mode select the Write Global-Midi Setup command from the page menu. All MIDI Setups can be freely customized and overwritten.

Hint: To restore the original MIDI Setups, load the original Factory data again (available on the supplied Accessory CD, or downloadable from www.korgpa.com).

Harmony Track ▶GBL^{Seq}

The Voice Processor gets the chord notes from the track selected with this parameter.

Hint: Go to the Voice Processor Preset section of the Global mode to try different Voice Processor Presets while creating or editing a Song.

Off No track sends notes to the Harmony module of the Voice processor. Chords can still be received from the MIDI IN.

Seq.1-Track 1...16

Chords are sent from one of Sequencer 1 tracks.

Page menu

Touch the page menu icon to open the menu. Touch a command to select it. Touch anywhere in the display to close the menu without selecting a command.

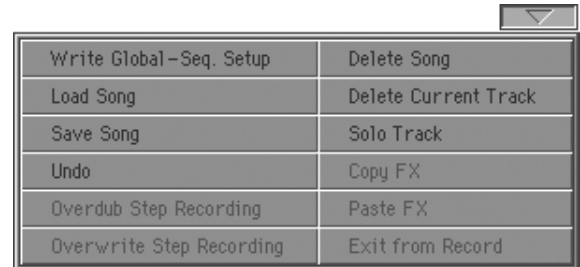

Write Global-Seq. Setup

Select this command to open the Write Global-Seq. Setup dialog box, and save global settings that are unique to the Sequencer mode. (See “Write Global-Sequencer Setup dialog box” on page 212).

Load Song

Select this command to open the Song Select window, and load a Song to the sequencer. (See “Song Select window” on page 212).

Save Song

Select this command to save the new or edited Song to a storage device as a Standard MIDI File. The file is automatically added the “.MID” extension. After selecting this command, the Save Song page appears (see “Save Song window” on page 213).

Warning: Turning the instrument off will delete the Song from memory. Save your Song to a storage device to avoid losing it.

Warning: The Song is also lost when switching from Sequencer to Style Play or Song Play mode, without previously saving the Song to a storage device.

Undo

When selecting this command, the latest operation is canceled, and data are reverted to the previous situation.

Overdub Step Recording

Only available in Record mode. Select this command to enter Overdub Step Record mode. This recording mode lets you enter events one at a time, adding events to the existing events. (See “Record mode: Step Record page” on page 194).

Overwrite Step Recording

Only available in Record mode. Select this command to enter Overwrite Step Record mode. This recording mode lets you enter events one at a time, overwriting all existing events. (See “Record mode: Step Record page” on page 194).

Delete Song

Select this command to delete the Song and create a new, blank Song.

Delete Current Track

Select this command to delete the track currently selected in the Track area (see “Track volume/status area” on page 193).

Solo Track

Select the track to be soloed, and check this item. You will hear only the selected track, and the ‘Solo’ warning will flash on the page header.

Uncheck this item to exit the Solo function.

SHIFT Keep the SHIFT button pressed and touch one of the tracks to solo it. Do the same on a soloed track to deactivate the Solo function.

Copy/Paste FX

You can copy a single, or all four effects, between Styles, Performances, STSs and Songs. To do this, choose the “Copy FX” and “Paste FX” commands from the page menu of the Style Play, Song Play or Sequencer modes.

To copy a single effect:

1. Select the source Song, Performance, Style or STS, then
 - go to the page of the single effect you want to copy (FX A, FX B, FX C, or FX D), or
 - go to the Effects > FX Select page, to copy all four effects. This may be useful if you want to copy two or three of the four effects into different Performances, Styles or STSs.
2. Choose the “Copy FX” command from the page menu.
3. Select the target Performance, Style or STS, then go to the page of the single effect you want to paste (FX A, FX B, FX C, or FX D).
4. Choose the “Paste FX” command from the page menu.

To copy all four effects:

1. Select the source Performance, Style or STS, then go to the Effects > FX Select page, to copy all four effects.
2. Choose the “Copy FX” command from the page menu.
3. Select the target Performance, Style or STS, then go to the page of the Effects > FX Select page.
4. Choose the “Paste FX” command from the page menu.

Exit from Record

Only available in Record mode. Select this command to exit the Record mode, and go back to the Main page of the Sequencer Play mode (see “Sequencer Play - Main page” on page 189).

Write Global-Sequencer Setup dialog box

Open this window by selecting the Write Global-Song Setup item from the page menu. Here, you can save MIDI Setups (see “Midi Setup” on page 211), that are saved to the Global file.

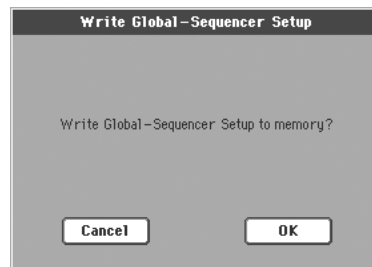

Parameters saved in the Sequencer Setup area of the Global are marked with the ▶GBL^{Seq} symbol through the user’s manual.

Song Select window

This window appears when you select the “Load Song” command from the page menu, or press the SONG SELECT button in the SEQUENCER 1 sections on the control panel. See “Song Select window” on page 82 for details.

Save Song window

The recorded Song is contained in RAM, and is lost when turning the instrument off. **The Song is also lost when you overwrite it in Record mode, or if you confirm the warning message when switching to the Style Play or Song Play mode.** You must save to a storage device any Song you wish to preserve.

This window appears when you select the “Save Song” command from the page menu.

Press EXIT to exit from this page and go back to the main page of the Sequencer operating mode without saving the Song.

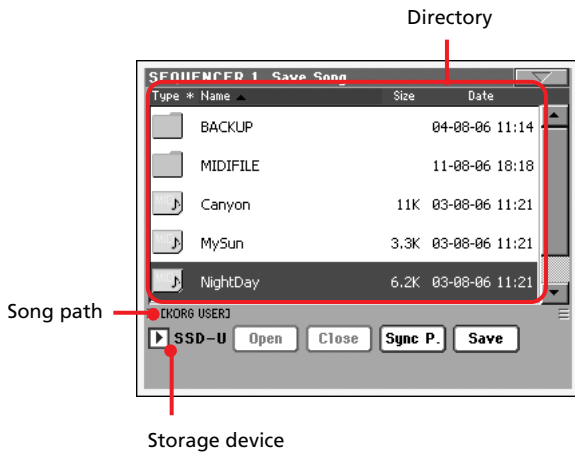

Song path

This line shows the path of the location where you are saving the Song.

Directory

This is the list of the selected device’s content.

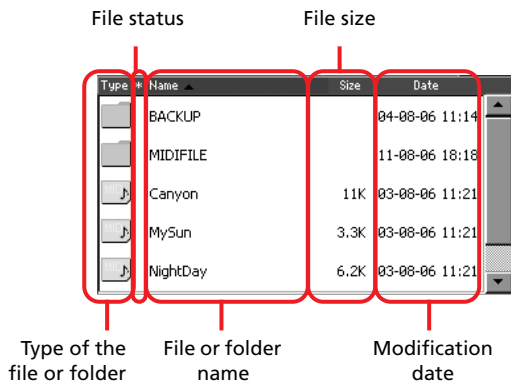

Use the scrollbar to scroll the list items.

As an alternative, you can select one of the items, and use the TEMPO/VALUE controls to scroll.

Keep the SHIFT button pressed, and press DOWN or UP, to jump to the previous or next alphabetical section.

Storage device

Use this pop-up menu to select one of the available storage devices where to save the Song.

Device	Type
SSD-U	User area of the internal SSD memory
HD	Hard disk (optional)
USB-F	Device connected to the front USB Host port
USB-R	Device connected to the rear USB Host port

The actual name (label) of the device may appear within square brackets ([]).

Open

Opens the selected folder (item whose icon looks like this: ).

Close

Closes the current folder, returning to the parent (“upper”) folder.

Sync P. (Synchronized Path)

Touch this button to see the Song assigned to the Sequencer. This is useful to quickly return to it, after you have browsed through long directories and “dug” into different folders.

Save

Touch this button to open the Save Song dialog box, and save the Song to the current directory.

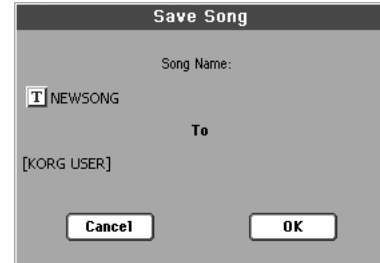

- If no file has been selected in the display, prior to touching Save, the “NewSong” default name will be automatically assigned to the Song.

Note: If a file is selected, just touch the storage device name to deselect it.

- If a file has been selected in the display, prior to touching Save, the name of the selected file will be automatically assigned to the Song.

In any of the above situations, touch the **T** (Text Edit) button to edit the Song name.

Warning: If a file with the same name is already in the current directory, a message will warn you. If you confirm, the existing file will be overwritten. Select a file before saving only if you want to overwrite it (i.e., in case you are saving changes to an existing file).

Empty measure at the beginning of the Standard MIDI File

When saving a Song as an SMF, an empty measure is automatically inserted to the beginning of the Song. This measure contains various Song initialization parameters.

Play/Mute status saved with the Song

When saving a Song, the Play/Mute status is saved with the Song. This status is preserved also when playing back the same Song in Song Play mode.

Master Transpose saved with the Song

When saving a Song, the Master Transpose value is saved with the Song. Since this value is saved as System Exclusive data, it is preserved also when playing back the Song in Song Play mode.

Hint: Since the Master Transpose is a global parameter, loading a Song with a non-standard transposition may result in unwanted transposing when loading other Songs that do not contain their own transposition data. To transpose a Song it is advisable to use the Transpose function in the Edit section of the Sequencer mode (see “Song Edit: Transpose” on page 208).

You may also lock the Master Transpose, to avoid unwanted transposition. See “General Controls: Lock” on page 218 of the Global chapter.

As a general rule, you should use the Master Transpose (TRANSPPOSE buttons on the control panel) when you need to transpose Keyboard tracks together with the Song. You should use the Edit mode Transpose function (see “Song Edit: Transpose” on page 208) when only the Song has to be transposed.

Note: The Master Transpose value is always shown on the page header:

SEQUENCER

T:0

Save Song procedure

1. If you are in Record mode, stop the sequencer and exit from the Record mode. Then go back to the main page of the Sequencer Play mode (see “Sequencer Play - Main page” on page 189).
2. Select the Save Song command from the page menu. The Save Song page appears.
3. Select the folder where you want to save the Song into. Use the Open and Close commands to browse open or close folders. Use the scrollbar to browse through the files.
4. When you are in the directory where you want to save your Song to, touch the Save button in the display.
 - To **overwrite** an existing file, select it before touching Save.
 - To **create** a new file, do not select any file before touching Save. The “NewSong” (“NEWSONG.MID” on a storage device) name will be automatically assigned to the Song.
5. After touching the Save button, the Save Song dialog box will appear.
6. If you like, touch the **T** (Text Edit) button to edit the name.
7. Touch OK to confirm saving, or Cancel to stop the Save operation.

Global edit mode

The Global edit environment is the place where you can set global functions, i.e. functions overriding the single Performance, STS or Style. This edit environment overlaps the current operating mode (Style Play, Song Play, Sequencer, Sound Edit).

What is it, and how the Global is structured

The Global is a file that can be written to memory (and may subsequently be saved to a storage device), containing global parameters for the whole instrument or each single operating mode.

Global parameters can be written to memory by selecting the various “Write Global...” commands from the page menus – each dedicated to one of the areas of the Global file. They can be saved to a storage device by using the ordinary Media operations.

Note: Saving or loading a “.SET” folder also saves or loads the Global file. Parameter changing may be avoided by turning the Lock on for any single parameter (or groups of parameters in the Lock page of the Global mode, see “General Controls: Lock” on page 218).

There are separate areas in the Global file, that may be separately written to memory, to avoid writing all global parameters at once when not needed:

- Global Setup, containing global parameters not linked to any single operating mode.
- Style Play Setup, containing global parameters for the Style Play mode, not linked to the single Performance, STS or Style.
- Song Play Setup, containing global parameters for the Song Play mode, not linked to the single Song.
- Sequencer Setup, containing global parameters for the Sequencer mode, not linked to the single Song.
- Media Preferences, containing preferences for the Media mode.
- MIDI Setup, containing the available MIDI Setups, i.e., settings for MIDI communication.
- Voice Processor Setup, containing lead voice setups for the Voice Processor.
- Voice Processor Presets, containing single presets for the Voice Processor.

Main page

There is no main page in the Global edit mode. When pressing EXIT, you exit the Global mode, and the underlying operating mode in the background is recalled.

Edit menu

From any page of the Global mode, press the MENU button to open the Global edit menu. This menu gives access to the various Global edit sections.

When in the menu, select an edit section, or press EXIT to exit the Global mode.

When in a page, press EXIT to go back to current operating mode in the background (Style Play, Song Play, Sequencer, Sound).

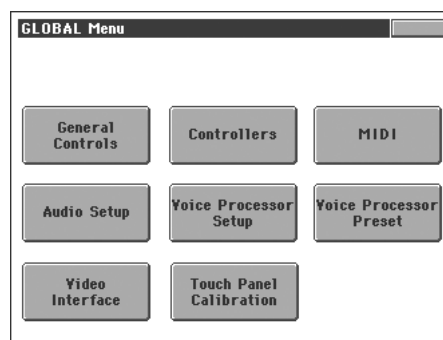

Each item in this menu corresponds to an edit section. Each edit section groups various edit pages, that may be selected by touching the corresponding tab on the lower part of the display.

Note: The Global mode is not available while in Record mode (Style Record, Pad Record, Song Record, Sampling).

Edit page structure

All edit pages share some basic elements.

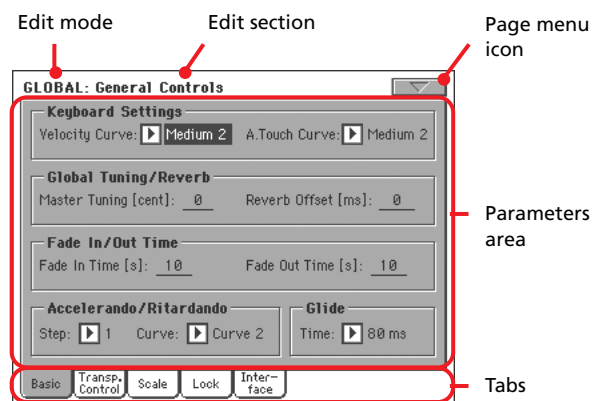

Edit mode

This indicates that the instrument is in Global mode.

Edit section

This identifies the current edit section, corresponding to one of the items of the edit menu (see “Edit menu” on page 215).

Page menu icon

Touch this icon to open the page menu (see “Page menu” on page 231).

Parameters area

Each page contains various parameters. Use the tabs to select one of the available pages. For detailed information on the various types of parameters, see sections starting from page 216.

Tabs

Use tabs to select one of the edit pages of the current edit section.

General Controls: Basic

This page contains various general parameters, setting the status of the keyboard, the fade in/out, and the accelerando/ritardando.

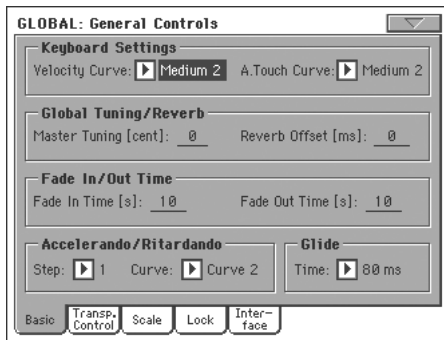

Keyboard Settings

Velocity Curve

►GBL^{Gbl}

This parameter sets the sensitivity of the keyboard to your touch. By default, it is set to Medium 2.

Fix No dynamic control available. Dynamic values are fixed, as in a classic organ.

Soft1 ... Hard3

Curves, from the lightest one to the hardest one.

A.Touch Curve

►GBL^{Gbl}

This parameter sets the sensitivity of the keyboard to the pressure you apply after first pressing a key.

Soft1 ... Hard3

Curves, from the lightest to the hardest one.

Off The aftertouch is turned off.

Global Tuning/Reverb

Master Tuning

►GBL^{Gbl}

This is the master tuning of the instrument (in cents of a semi-tone). Use it to adapt your keyboard tuning to an acoustic instrument, for example an acoustic piano.

-50 Lowest pitch.

0 Standard pitch (A4=440Hz).

+50 Highest pitch.

Reverb Offset

►GBL^{Gbl}

This is the master offset for all reverbs. Use it to adjust reverb tails to the room where you are playing. Use negative values when you are in a very reverberant room, positive values if the room is too dry.

By using this global control, you are not obliged to change the reverb time in each single Performance, STS, Style Performance, or Song.

-50 Less reverb.

0 Standard reverb.

+50 More reverb.

Fade In/Out Time

These parameters allows you to set the speed for the Fade In/Out function.

Fade In Time

►GBL^{Gbl}

Time for a full fade in (from zero to maximum volume), after you press the FADE IN/OUT button.

5...20 Fade time (in seconds).

Fade Out Time

►GBL^{Gbl}

Time for a full fade out (from maximum volume to zero), after you press the FADE IN/OUT button.

5...20 Fade time (in seconds).

Accelerando/Ritardando

These parameters lets you adjust the speed of the Accelerando and Ritardando functions.

Step

Speed of the Tempo change (from 1 to 6). With higher values, the step change is greater, and the speed will change faster. With lower values, the step change is smaller, and the speed will change more slowly.

Curve

Accelerando/ritardando curves (from 1 to 3). Experiment the various options, to see the one that best fit your taste.

Glide

Glide is a function you can assign to a footswitch. When the pedal is pressed, affected notes on Upper tracks are bent down, according to settings for the Pitch Bend on the same tracks. When the pedal is released, notes return to the normal pitch, at the speed defined by the “Time” parameter.

To change Pitch Bend values for each Upper track, see the “PB Sensitivity” parameter in the Style Play mode (see page 96)

Time

Time needed to notes affected by the Glide to return to the normal pitch.

General Controls: Transpose Control

This page is where you can select to which tracks the Master Transpose is applied to, and adjust some related parameter.

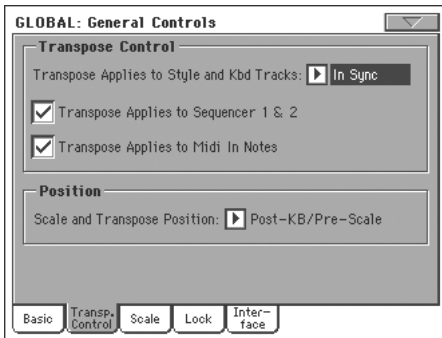

Hint: When playing the keyboard while a Song is running, if you want to play the keyboard in C while seeing the original chords in the display, set to Off the “Transpose applies to Style and Kbd tracks...” parameter, and check the “Transpose applies to Sequencer 1/2” parameter.

Transpose Control

Transpose applies to Style and Kbd tracks... ▶GBL^{Gbl}

Use this parameter to turn the Master Transpose on or off, and define the way it is applied, to Style and Keyboard tracks.

- Off No Master Transpose is applied to Style and Keyboard tracks.
- In Sync When you press either the TRANSPOSE [b] or [♯] buttons, the new transpose setting will not take effect until the first beat of the next measure is reached.
- In Realtime When you press either the TRANSPOSE [b] or [♯] buttons, the new transpose setting will occur when the next note is played for both the Style and Keyboard tracks individually.

The next key or chord you press will sound with the new transpose setting applied. (Note that if you play a Keyboard track prior to a new chord, the Keyboard track will play in the new key as the Style will continue to play in the old key until a new chord is entered).

Transpose applies to Sequencer 1/2 ▶GBL^{Gbl}

This flag lets you turn the Master Transpose on or off for the two onboard Sequencers.

Transpose applies to Midi In notes ▶GBL^{Gbl}

This flag lets you turn the Master Transpose on or off for Note messages received from MIDI IN.

Position

Scale and Transpose position

The Scale and Transpose Position allows you to define the relation between the Scale and the Master Transpose.

Post-KB/Pre-Scale

When this option is selected, notes will be transposed immediately after they leave the keyboard. The Scale will be applied to the transposed notes. For example, if you altered an E, and then set the Master Transpose to +1, the E key will play F, and the altered key will be E_b (that will play an altered E).

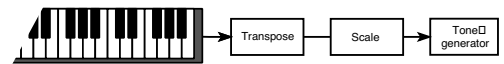

Post-KB & Scale

When this option is selected, all notes are transposed immediately before they enter the internal tone generator, or are sent to the MIDI OUT, but after the Scale. For example, if you altered an E, and set the Master Transpose to +1, the altered key will still be E (that will play an altered F).

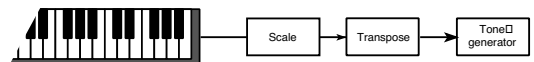

General Controls: Scale

This page lets you select the main (or basic) scale of the instrument.

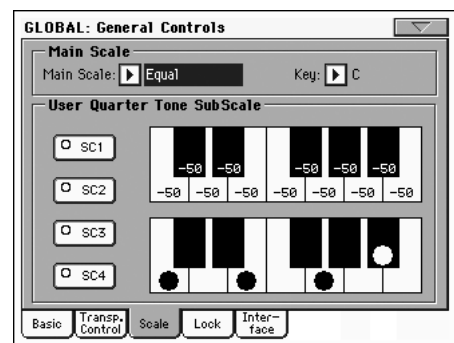

Main Scale ▶GBL^{Gbl}

This parameter sets the main scale (or temperament) for the whole instrument, apart for tracks where a different sub-scale has been selected by a Performance or STS (see “Scale Mode” on page 106, Style Play mode).

See “Scales” on page 318 for a list of available scales.

Note: You cannot select a User scale in Global mode.

Key ▶GBL^{Gbl}

This parameter is needed by some scales to set the preferred key (see “Scales” on page 318).

SC Preset buttons

Touch these buttons to recall the corresponding presets. Each preset contains a custom detuning of each note of the scale (shown in the upper scale diagram). It also memorizes the selected degree(s) of the scale (shown in the lower scale diagram).

When no preset is selected, the default scale is automatically recalled. This scale assigns a -50 cent value to all notes, and turns all scale degrees off.

You can select an SC Preset, also by assigning the relevant function to the Assignable Switch or Assignable Footswitch.

To save the current scale programming to a preset, while in this page choose the “Write Quarter Tone SC Preset” command from the page menu, then select one of the preset locations where to save the current settings (see “Write Quarter Tone SC Preset” on page 231).

Upper scale diagram

Use this diagram to set the detuning of each note of the scale.

-99...0...+99 Note detuning in cents. Zero is no detuning, ±50 is a full quarter tone up or down, ±99 is nearly one whole semitone up or down.

Lower scale diagram

Use this scale to turn detuning on or off. Applied detuning will depend on the programming set with the Upper scale diagram, or recalled by selecting one of the SC Presets.

When a note is detuned, a black dot appears in the corresponding note of the diagram.

General Controls: Lock

This page, split in four panes that can be selected by means of the corresponding side tabs, contains all the available locks, sometimes grouped under just a single lock. Locks prevent parameter values to be changed when loading data from a storage device, or selecting a different Performance, Style or STS.

Locks

► GBL^{Gbl}

All the available locks. Lock them to prevent changes due to loading or selecting different elements. These locks are also found in various other pages, next to the locked parameter.

Hint: To save the status of the various parameters as a fixed status for the Pa800, save all the parameters to Performance 1 of bank 1 (automatically selected when turning on the instrument), and save these locks to the Global.

• Lock–Tuning pane

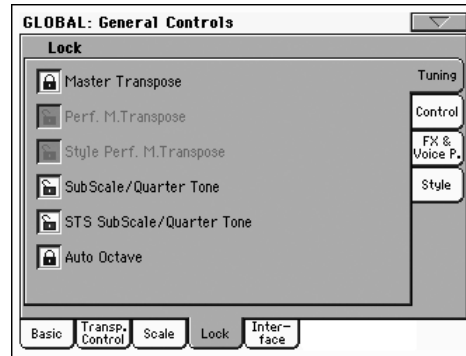

Master Transpose

When locked, master transpose is not automatically changed when selecting a different Performance or Style.

(See “Master transpose” on page 86).

Perf M. Transpose

When closed, this lock prevents a Performance change to modify the Master Transpose. When open, changing a Performance may also change the Master Transpose.

(See “Master transpose” on page 86).

Hint: In order to avoid having the Master Transpose setting change when selecting a different Style, use the general Master Transpose Lock (the first parameter in this page).

Note: When the Master Transpose Lock is closed, this parameter has no effect. However, the Master Transpose Lock also locks the Performance Transpose.

Style Performance Master Transpose Lock

When closed, this lock prevents a Style change to modify the Master Transpose. When open, changing a Style may also change the Master Transpose.

(See “Master transpose” on page 86).

Hint: In order to avoid having the Master Transpose setting change when selecting a new Performance or STS, use the general Master Transpose Lock (the first parameter in this page).

Note: When the Master Transpose Lock is closed, this parameter has no effect. However, the Master Transpose Lock also locks the Style Performance Transpose.

Sub Scale/Quarter Tone

When locked, selecting a Performance or STS will not change the Sub-Scale or Quarter Tone value.

(See “Sub-Scale panel” on page 92).

STS SubScale/Quarter Tone

When closed, this lock prevents an STS change to modify the SubScale/Quarter Tone settings, allowing for changing sounds and effects but not the scale. When open, changing an STS may also change these settings.

(See “Sub-Scale panel” on page 92).

Auto Octave This lock lets you decide if the instrument will automatically transpose the Upper tracks when switching between the FULL UPPER and the SPLIT Keyboard modes.

- If On, when switching to the FULL UPPER or SPLIT Keyboard Mode, the Upper tracks transposition is left unchanged.
- If Off, when switching to the FULL UPPER Keyboard Mode, the Upper tracks Octave Transpose is automatically set to “0”. When switching to the SPLIT Keyboard Mode, the Upper tracks Octave Transpose is automatically set to “-1”.

• **Lock-Control pane**

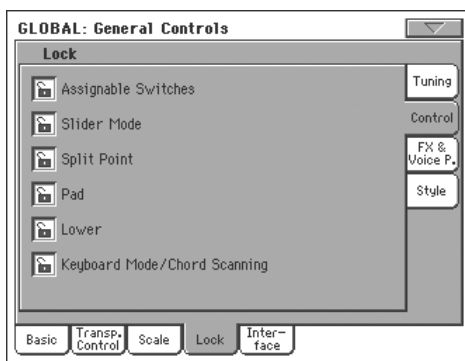

Assignable Switches

When locked, selecting a Performance or STS will not change the Assignable Switch assignment.

(See “Pad/Switch: Assignable Switch” on page 105).

Slider Mode When locked, selecting a Performance or STS will not change the selected status of the SLIDER MODE button.

(See “Assignable Slider Mic” on page 222).

Split Point When locked, selecting a Performance or STS will not change the split point.

(See “Split Point” on page 92).

Pad When locked, selecting a Performance or STS will not change the Pad assignment.

(See “Pad/Switch: Pad” on page 105).

Lower When this lock is closed, the Lower track remains unchanged when a different Style, Performance or STS is selected.

This is useful if, for example, you prefer to always play with the left hand muted and reserved only to playing chords for the arranger.

Hint: If you want the same Lower settings to be used during all your shows, save your preferred Lower settings to Performance 1-1 (automatically selected on startup), then close this lock and choose the “Write Global-Global Setup” from the page menu.

Keyboard Mode/Chord Scanning

When this lock is closed, the Keyboard Mode and Chord Scanning remain unchanged when a different Performance or STS is selected.

This is useful if, for example, you prefer to always play in Full Keyboard, with chords recognized on the whole keyboard range.

Note: The Keyboard Mode and Chord Scanning settings are reset when switching to a different operating mode.

Hint: If you want the same Keyboard Mode and Lower Scanning settings to be used during all your shows, save your preferred settings to Performance 1-1 (automatically selected on startup), then close this lock and choose the “Write Global-Global Setup” from the page menu.

• **Lock-FX & Voice Processor pane**

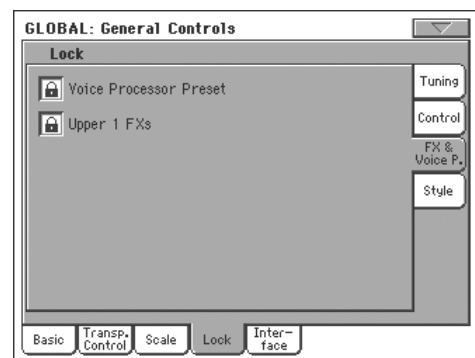

Voice Processor Preset

When locked, selecting a Performance or STS will not change the Voice Processor Preset.

(See “VP Preset” on page 91).

Upper 1 FXs In Sound mode, you can assign a Sound two effects (FX1 and FX2). When you assign a new Sound to the Upper 1 track, the FX1 and FX2 settings saved with that Sound can be automatically selected, overriding Performance/STS settings for this track. Whether Sound or Performance/STS effect parameters will be considered, depends on the status of this lock.

- If the Upper 1 FX Lock is turned on, when assigning a new Sound to the Upper 1 track, Performance/STS parameters are left untouched; selected effects, and FX Send values, are not changed.

- If the Upper 1 FX Lock is turned off, when assigning a new Sound to the Upper 1 track, Sound parameters are considered; selected effects, and FX Send values, are changed according to the Sound's stored data.

Note: If effects associated to the selected Sound are not compatible with effects already assigned to the CD FX block, C and/or D Send values on the other Keyboard tracks will be automatically set to zero.

For example, assume a chorus effect is assigned to the D effect processor. If the new Sound assigns a distortion effect to the D effect processor, the D Send value on the Upper 2, Upper 3, and Lower tracks will be set to zero, to avoid these tracks sound in the wrong way. This way, the Upper 1 track (usually the most important one for solo playing) will sound with the needed effect, while the other Keyboard tracks will just sound dry.

• Lock–Style pane

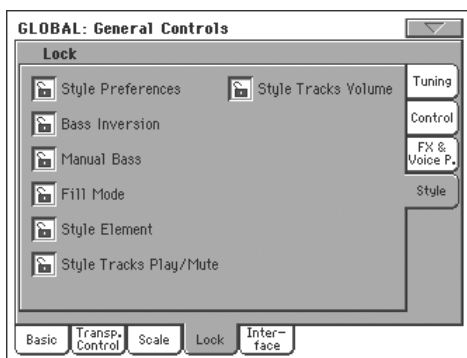

Style Preferences

When locked, selecting a Performance or STS will not change the value of parameters contained in the Style Preferences pages. By default, it is turned on.

(See “Preferences: Style Preferences” on page 106, and “Preferences: Style Play Setup” on page 107).

Bass Inversion

When locked, selecting a Performance or STS will not change the Bass Inversion status. Bass Inversion can also be assigned to one of the Assignable Switches or the Assignable Pedal.

(See “BASS INVERSION” on page 12).

Manual Bass

When locked, selecting a Performance or STS will not change the Manual Bass status.

(See “MANUAL BASS” on page 12).

Fill Mode

When locked, the selected Fill Mode will not change when selecting a different Performance or Style.

(See “Fill Mode (1...3)” on page 104).

Style Element When locked, selecting a different Style does not cause selecting a different Style Element.

Style Tracks Play/Mute Lock

When closed, this lock prevents a Style or Performance change to modify the Play/Mute status of the Style tracks. This way, you can, for example, turn the bass track off during a whole show, to allow your bassist to play it live. Also, you could mute all Acc tracks, to only play with the Drum and Bass tracks.

(See “Track status icons” on page 89).

Style Tracks Volume

When this lock is closed, the volume of the Style tracks remains unchanged when a different Style or Performance is selected.

This is useful if you create your own Styles, and like to dynamically adjust the volume by using the sliders as a mixer. It is not recommended with Factory Styles, each one already mixed at its best right at the factory.

General Controls: Interface

This page contains parameters related to the way messages are shown in the display.

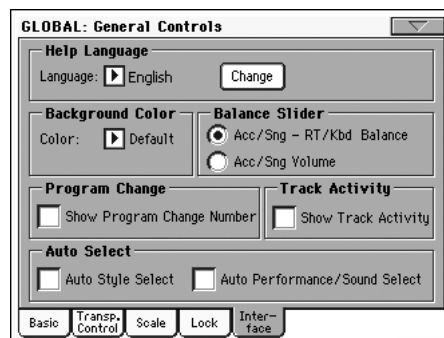

Help Language

Language



Use this pop-up menu to select one of the available languages for the online help system.

Change button

Touch this button to apply the selected language to the user's interface.

How to select the Help language

1. Since Pa800 must be reset at the end of this procedure, be sure to first save all unsaved data.
2. While in this page, select a language from the pop-up menu.
3. The Change button will start flashing in red. Touch it.

4. You will be asked if you want to save the Global, and select the new language. Touch Yes to confirm. The Global will be automatically saved, and the language selected.
5. A message will advise you to reboot the Pa800. Touch OK to close the message window.
6. Turn the Pa800 off, then on again.

Background color

Color

▶GBL^{Gbl}

Use this parameter to choose a different background color for the display. Possible choices are Default, and from 1 to 6.

Balance slider as the Acc/Seq-RT Volume

Balance Slider

▶GBL^{Gbl}

The BALANCE slider can either be used to mix between the Keyboard and Accompaniment/Song tracks, or to control the Accompaniment/Song Volume without changing the Keyboard tracks. This is always a relative control, whose effective maximum value is determined by the MASTER VOLUME slider position.

Note: The BALANCE slider only works in Style Play and Song Play modes. It does not work in Sequencer or Sound mode.

Acc/Sng - RT/Kbd Balance

While in Style Play and Song Play mode, the BALANCE slider balances the volume of the Keyboard (RT/Kbd) tracks, against the Style (Accompaniment), Pad and Song tracks.

Acc/Sng Volume

While in Style Play and Song Play mode, the BALANCE slider controls the volume of the Style (Accompaniment), Pad and Song tracks.

Program Change

Show Program Change number

▶GBL^{Gbl}

Check this parameter to show Program Change numbers next to Sound names in the Sound Select window. By default, this parameter is turned on.

Note: Program Change numbers are always shown in Sound Edit mode, and in the various Track Info areas.

Track Activity

Show Track Activity

▶GBL^{Gbl}

Use this parameter to turn on/off the Track Activity display. When it is turned on, you can monitor events coming from the tracks or the MIDI inputs. Incoming events are shown by the changing color of each track's label.

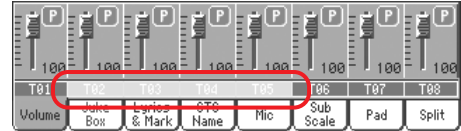

Here is the list of colors and their meaning:

- Red Data coming from the MIDI IN ports.
- Green Internal data, generated by the keyboard, pads, the Arranger or one of the Sequencers.
- Grey Either internally or externally generated data (or both at the same time).
- Dark Blue No data received.

Auto Select

Auto Style Select

▶GBL^{Gbl}

Auto Performance/Sound Select

▶GBL^{Gbl}

When one of these parameters is checked, the latest selected Style, Performance or Sound selected in a bank is immediately selected when pressing the bank button.

This way, you can assign your preferred Style, Performance or Sound to each control panel's button, and select it just with a single press.

However, the Style/Perf/Sound Select window still appears when you press one of the bank buttons, so you can select a different item if desired.

Note: Unless you save your settings by means of the "Write Global-Auto Select Setup" page menu command, the memorized Style, Performance or Sound is reset to the first one in each bank, when turning the instrument off and then on again.

Hint: You can save your preferred Performances into the first location of each bank. This way, by turning on this parameter, you will select your preferred Performance at the touch of a single button.

Also note that, by turning the "Factory Style and Pad Protect" and "Factory Sound Protect2 parameters off, you can do the same with the Styles and Sounds.

Controllers: Pedal/Switch

This page lets you select a function to the Assignable Pedal/Footswitch, and calibrate the Damper and Assignable Pedal/Footswitch.

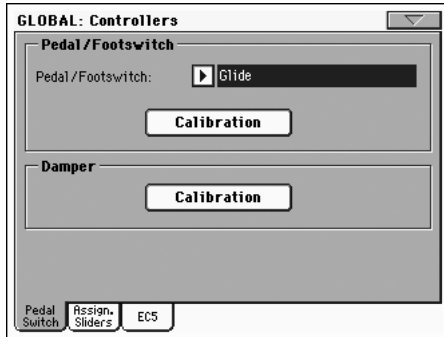

Pedal/Footswitch

Pedal/Footswitch

►GBL^{Gbl}

Function assigned to a continuous (i.e., volume/expression) pedal, or to a footswitch, connected to the ASSIGNABLE PDL/SW connector. See page 315 for a list of the assignable functions. The first functions are switch-type functions, while the remaining (starting from Master Volume) are continuous-like functions.

Calibration

►GBL^{Gbl}

Use this button to calibrate and choose the polarity of the pedal/footswitch.

1. Connect the pedal or footswitch to the ASSIGN PEDAL/SW connector on the back of the instrument.
2. Go to this page, and touch the “Calibration” button in the display. The following dialog box appears:

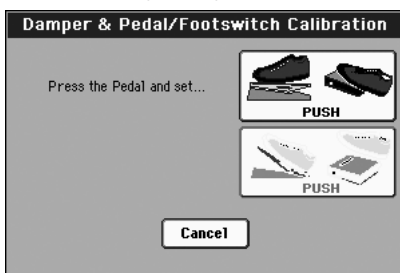

3. You are asked to set the pedal to the maximum value. Press the footswitch, or press the pedal to the maximum position (usually front pressed).
4. Touch the “Push” button in the display to confirm the maximum value. The following dialog box appears:

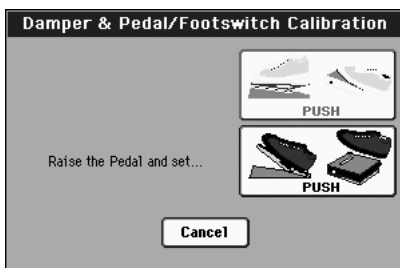

5. You are now asked to set the pedal to the minimum value. Release the footswitch, or press the pedal to the minimum position (usually back pressed).
6. Touch the “Push” button in the display to confirm the minimum value.
7. Check if the pedal or footswitch is working properly, assign it a function, then save by choosing the “Write Global-Global Setup” command from the page menu.

Note: After loading a new Operating System, an older Global file, a “SET” folder containing an older Global file, or a Backup file, you might need to re-calibrate the pedal/footswitch.

Damper

Calibration

►GBL^{Gbl}

Use this button to calibrate the action of the Damper pedal, and set the polarity of a Damper pedal different than the supplied one. See above for details about the procedure.

Controllers: Assignable Sliders

This page lets you program the two Assignable Sliders. Three sets are available (Mic, A and B). You can assign the preferred set by using the SLIDER MODE button on the control panel, respectively selecting the MIC, A or B mode. The status of the SLIDER MODE button can be saved with the Performance or STS.

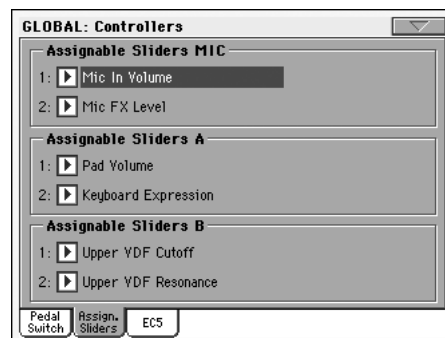

Assignable Slider Mic

►GBL^{Gbl}

Functions assigned to the corresponding sliders on the control panel, when the selected mode is MIC.

See “List of Assignable Pedal and Assignable Slider (A/B) functions” on page 316 for a list of the assignable functions.

Assignable Slider A, B

►GBL^{Gbl}

Functions assigned to the corresponding sliders on the control panel, when the selected mode is A or B.

See “List of Assignable Pedal and Assignable Slider (A/B) functions” on page 316 for a list of the assignable functions. The first functions are switch-type functions, while the remaining (starting from Master Volume) are continuous-like functions. Only continuous functions can be assigned to the sliders.

Controllers: EC5

This page lets you program each of the five switches of the KORG EC5 multiswitch controller.

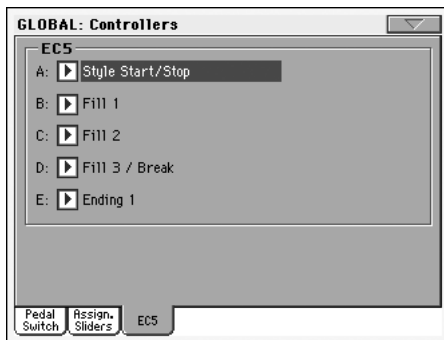

See “List of Footswitch and EC5 functions” on page 315 for a list of the assignable functions. The first functions are switch-type functions, while the remaining (starting from Master Volume) are continuous-like functions. Only switch functions can be assigned to the EC5 switches.

EC5-A...E

Each of the switches of a KORG EC5 multiswitch.

►GBL^{Gbl}

MIDI: MIDI Setup / General Controls

This page allows you to select a MIDI Setup, convert ordinary notes to RX Noises, and set global parameters for the MIDI communication.

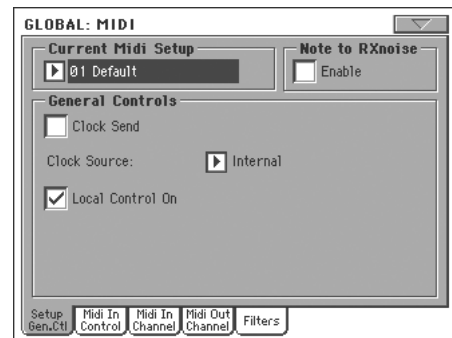

Current MIDI Setup

MIDI Setup

►GBL^{Sty} ►GBL^{Sng} ►GBL^{Seq}

MIDI channels can be automatically configured by selecting a MIDI Setup. Each of them lets you assign the best values to various MIDI parameters, to allow an easier connection with a particular MIDI controller. See “MIDI” on page 263 for more information on using MIDI Setups.

A different MIDI Setup may be automatically selected when entering the Style Play, Song Play or Sequencer modes. To select a MIDI Setup for these modes, see “Midi Setup” on page 107 for the Style Play mode, “Midi Setup” on page 176 for the Song Play mode, and “Midi Setup” on page 211 for the Sequencer mode.

For detailed information on MIDI Setup settings, see “MIDI Setup” on page 314.

Note: After selecting a MIDI Setup, you can apply any changes to each channel's settings. To store the changes in memory, select the Write Global-Midi Setup command in the page menu to save it to memory (see “Write Global - Midi Setup dialog box” on page 231).

Hint: To restore the original MIDI Setups, load the original Factory data again (downloadable from www.korgpa.com).

Note to RX Noise

RX Noises are special sounds that make Sounds be more realistic. They are usually located above C7, depending on the Sound.

Enable

When this parameter is turned on, notes received from MIDI, or performed by one of the internal sequencers, in the RX Noises range, are recognized and converted to RX Noises. When off, notes are not recognized.

Note: This parameter is automatically turned off when turning the instrument on again.

General Controls

Use these parameters to set MIDI Clock and Local Off.

Clock Send

►GBLMid

Use this parameter to turn the clock information on the MIDI OUT or USB Device port on or off. This parameter is common to all MIDI Setups.

Note: In Song Play mode, only the Tempo of Sequencer 1 will be sent to the MIDI OUT or USB Device port.

Off The Pa800 cannot send the MIDI Clock signal. You cannot slave another instrument to the Pa800, even when connected to the MIDI OUT or USB Device port.

On The Pa800 can send the MIDI Clock signal. You can slave another instrument to the Pa800 Tempo, Start/Stop and Play/Stop commands. Connect the other instrument to the Pa800 MIDI OUT or USB Device port.

Clock Source

This parameter selects the MIDI Clock source for the Style Play and Sequencer modes.

Note: In Song Play mode, the Internal clock is always used.

Note: The Clock parameter is always set to “Internal” each time you turn the instrument on.

Internal Internal, i.e. the clock generated by the Pa800 Sequencer 1 internal metronome.

Ext. MIDI External from the MIDI IN port. In Style Play or Sequencer mode, the Pa800 is slaved to an external device, connected to its MIDI IN port. The Start/Stop and Play/Stop commands, as well as the metronome tempo, cannot be selected from the control panel of the Pa800. Use the external device to set the tempo and start or stop the sequencer or arranger.

Ext. USB As the above, but referred to the USB Device port. See “Installing the Korg USB MIDI Driver” on page 329 for information on how to configure your computer for MIDI Over USB communication.

Local Control On

The Local parameter turns the keyboard on or off.

Note: The Local parameter is automatically reactivated each time you turn the instrument on.

On When you play the keyboard, MIDI data is sent to the internal sound generator. If tracks are assigned to a MIDI OUT channel, data is also sent to the MIDI OUT or USB Device port.

Off The keyboard is connected to the MIDI OUT, but cannot play the internal sound generator.

This is very useful when working with an external sequencer, to send notes and various MIDI messages from the integrated keyboard and controllers to the external sequencer, and then let the sequencer send them back to the sound generator, without overlapping. See the MIDI chapter.

MIDI: MIDI In Control

This page lets you program general parameters for the MIDI IN, like the Chord Recognition channel and MIDI parameters for the Voice Processor.

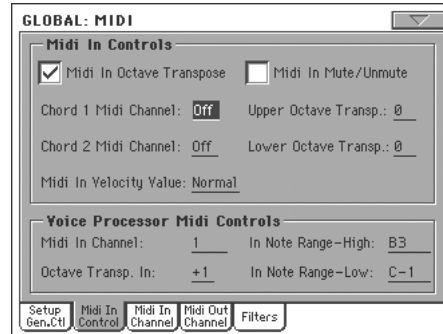

Midi In Controls

Midi In Octave Transpose

►GBLMid

Use this parameter to determine if the Octave Transpose is applied also to notes received on the MIDI IN or USB Device port.

On Notes received on the MIDI IN or USB Device port are transposed according to the Octave Transpose setting for each track.

Off Data received on the MIDI IN or USB Device port are not transposed.

Midi In Mute/Unmute

►GBLMid

Use this parameter to determine if a muted track can still play data received via MIDI.

On No data received via MIDI on a muted track can be played by Pa800.

Off Data received via MIDI on a muted track can still play on the Pa800.

Chord 1 Midi Channel

►GBLMid

Chord 2 Midi Channel

►GBLMid

Notes entering these channels are sent to the Chord Recognition engine.

There are two separate Chord channels. This is very useful when you must send chords to Pa800 on two different channels (like with some MIDI accordions).

Upper Octave Transp (Transpose)

►GBLMid

Octave transposition of data received on the MIDI IN for the Upper tracks. For example, if you select the +1 value, a received C4 will play a C5 on the Pa800.

This parameter may be useful to many MIDI accordion players, whose MIDI interface may transmit on an unexpected octave.

Lower Octave Transp (Transpose) ▶GBLMid

Octave transposition of data received on the MIDI IN or USB Device port for the Lower track. For example, if you select the +1 value, a received C4 will play a C5 on the Pa800.

This parameter may be useful to many MIDI accordion players, whose MIDI interface may transmit on an unexpected octave.

Midi In Velocity Value ▶GBLMid

Use this parameter to set a fixed velocity (dynamics) value for all received MIDI notes. This is useful when playing the Pa800 with an organ or a MIDI Accordion.

- Normal Normal velocity values are received.
- 40...127 All received velocity values are converted to the selected value.

Voice Processor Midi controls

Midi In Channel ▶GBLMid

Notes received on this channel are sent to the Harmony section of the Voice Processor.

Octave Transpose In ▶GBLMid

Octave transpose for all notes received via MIDI by the Harmony section of the Voice Processor.

In Note Range-High ▶GBLMid

In Note Range-Low ▶GBLMid

These parameters are the lowest and highest notes received by the Harmony section of the Voice Processor. Notes received out of this range are not recognized.

- Pad 1...4 One of the Pad tracks.
- Drum Drum track.
- Percussion Percussion track.
- Bass Bass track.
- Acc 1...5 One of the Auto-accompaniment tracks.
- Seq.1 Tr 01...16 One of Sequencer 1 tracks.
- Seq.2 Tr 01...16 One of Sequencer 2 tracks.
- Global Special channel to simulate the Pa800's integrated controls (keyboard, pedals, joystick) with an external keyboard or controller. MIDI messages coming on this channel are seen as if they were generated by Pa800's integrated controllers.
- Control On this special channel, the Pa800 receives MIDI messages to remotely select Styles, Performances, STS, Style Elements and SongBook entries. See tables on page 270 and following for more information on the received data

MIDI: MIDI Out Channels

In this page, you can assign Pa800 tracks to any of the MIDI OUT channels.

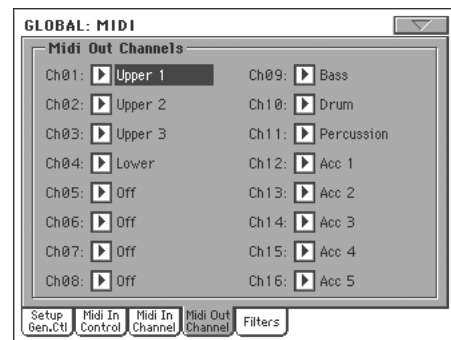

MIDI: MIDI In Channels

In this page, you can assign Pa800 tracks to any of the MIDI IN channels.

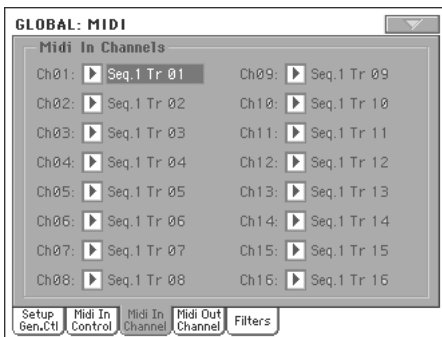

Channels ▶GBLMid

You can assign to each channel one of the following tracks:

- Off No track assigned.
- Lower Lower track.
- Upper 1...3 One of the Upper tracks.

Channels ▶GBLMid

You can assign to each channel one of the following tracks:

- Off No track assigned.
- Lower Lower track.
- Upper 1...3 One of the Upper tracks.
- Pad 1...4 One of the Pad tracks.
- Drum Drum track.
- Percussion Percussion track.
- Bass Bass track.
- Acc1...5 One of the Auto-accompaniment tracks.
- Seq.1 Tr 01...16 One of Sequencer 1 tracks.
- Seq.2 Tr 01...16 One of Sequencer 2 tracks.

Seq.1/2 Tr 01...16

Use these channels to send data generated by a track with the same name on either or both onboard sequencers at the same time.

Chord Use this channel to send notes recognized by the Chord Recognition engine to the MIDI OUT. This is useful, for example, to control an external Harmonizer from the Pa800, using the Lower track to play chords, even if the track is muted.

MIDI: Filters

Use this page to set up to 8 filters for the MIDI data received or sent by the Pa800.

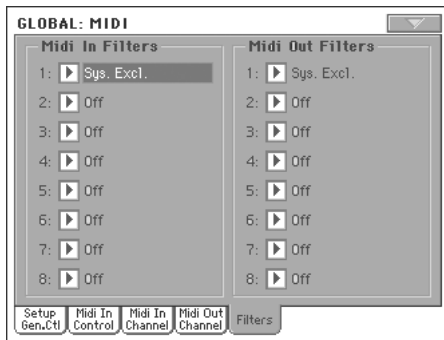

Midi In Filters

Selected MIDI IN filters.

- Off** No filter.
- Pitch Bend** Pitch Bend.
- MonoTouch** Mono (or Channel) After Touch.
- PolyTouch** Poly After Touch.
- PrgChange** Program Change.
- SysExcl** System Exclusive.
- All CC** All Control Change messages.
- 0...127** Control Change message #0...127. See "MIDI Data" on page 319 for a list of available Control Change messages.
- Notes** Note events.

Midi Out Filters

Selected MIDI OUT filters. See above for information on each filter type.

Audio Setup: Sty/Kbd

This page lets you connect Style, Keyboard and Pad tracks to the audio outputs.

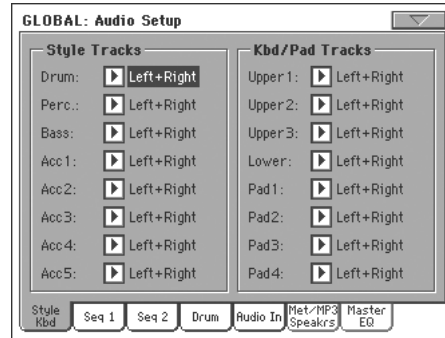

Tracks

►GBL^{Gbl}

Use these parameters to assign an audio output (OUTPUT section, on the back of the instrument) to each track.

Left + Right The selected track is connected to the Left & Right outs, in stereo. The track is also sent to the Internal FX processors (A and B for the Style and Pad tracks, C and D for the Keyboard tracks). You can set the volume using the MASTER VOLUME slider.

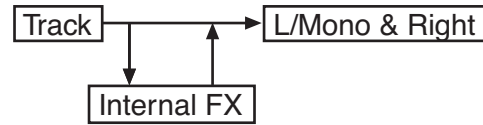

Out 1 + 2 The track is connected to the 1 & 2 sub-outs, in stereo. It is not sent to the Internal FX processors. The MASTER VOLUME slider has no effect on it.



Out 1 The selected track is connected to the sub-out 1. It is mixed to mono. It is not sent to the Internal FX processors. The MASTER VOLUME slider has no effect on it.

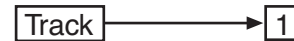

Out 2 The selected track is connected to the sub-out 2. It is mixed to mono. It is not sent to the Internal FX processors. The MASTER VOLUME slider has no effect on it.



►GBL^{Mid}

►GBL^{Mid}

Audio Setup: Seq1

This page lets you connect Sequencer 1 tracks to the audio outputs. These settings are also applied to the Sequencer mode.

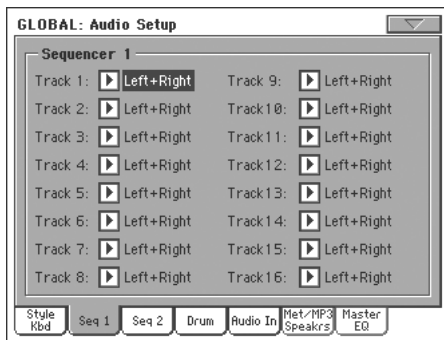

Tracks

►GBL^{Gbl}

Use these parameters to assign an audio output (OUTPUT section, on the back of the instrument) to each track.

See “Audio Setup: Sty/Kbd” on page 226 for more information.

Audio Setup: Seq2

This page lets you connect Sequencer 2 tracks to the audio outputs.

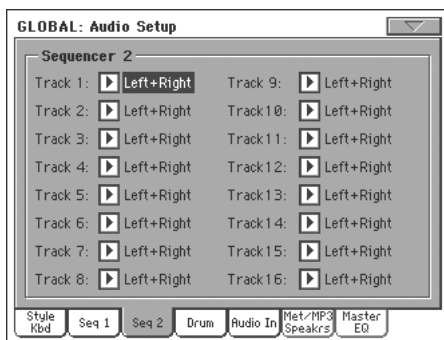

Tracks

►GBL^{Gbl}

Use these parameters to assign an audio output (OUTPUT section, on the back of the instrument) to each track.

See “Audio Setup: Sty/Kbd” on page 226 for more information.

Audio Setup: Drums

This page lets you route Drum Kit Sounds to the audio outputs.

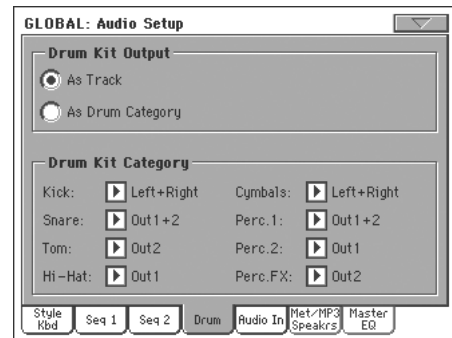

See “Audio Setup: Sty/Kbd” on page 226 for more information about the available audio outputs.

Drum Output

►GBL^{Gbl}

This parameter lets you decide if Drum Kit Sounds will be sent to the single output (or output pair) defined for the track they are assigned to, or each drum category will be sent to a different output.

Track

When this option is selected, Drum Kits will be sent to the output selected in one of the previous pages for the tracks they are assigned to.

Drum Category

When this option is selected, you can select a different output for each category of Drum Kit sounds. Use the “Drum Category” box below, to select an output for each category of percussive sounds.

Drum Category

►GBL^{Gbl}

Kick	Bass Drum category.
Snare	Snare Drum category.
Tom	Tom category.
Hi-Hat	Hi-Hat category.
Cymbals	Cymbals category.
Perc.1	Low-pitched percussion category.
Perc.2	High-pitched percussion category.
Perc. FX	Sound FX category.

Audio Setup: Audio In

This page lets you connect the Audio Inputs and the Voice Processor to the audio outputs.

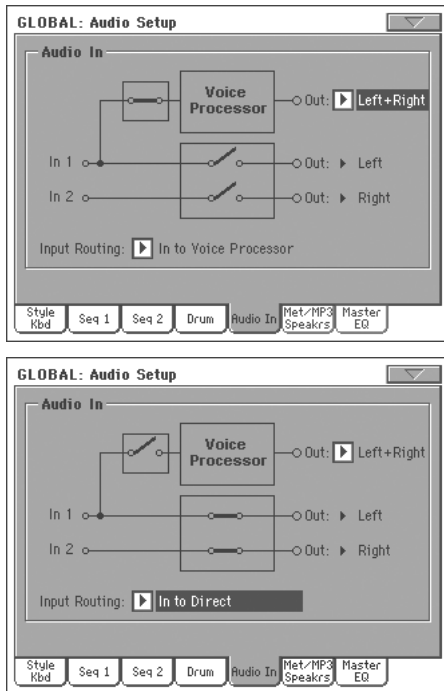

See “Audio Setup: Sty/Kbd” on page 226 for more information on the available audio outputs.

Input Routing

Use this pop-up menu to choose the routing of the Audio Input signal.

In to Voice Processor

Input 1 goes to the Voice Processor, while Input 2 is deactivated.

In to Direct Inputs 1 and 2 go to the final mix, together with the sounds generated by the Pa800. No Voice Processor effects are applied.

In 1

Input 1 may be routed to the Left output, or to the Voice Processor, depending on the status of the “Input Routing” parameter.

- If the selected routing is “In to Voice Processor”, it is sent to the Voice Processor.
- If the selected routing is “In to Direct”, it is sent to the Left output.

In 2

Input 2 may be routed to the Right output, or deactivated, depending on the status of the “Input Routing” parameter.

- If the selected routing is “In to Voice Processor”, it is deactivated.
- If the selected routing is “In to Direct”, it is sent to the Right output.

Voice Processor Out

▶GBL^{Gbl}

Use this parameter to assign an audio output (AUDIO OUTPUT section, on the back of the instrument) to the Voice Processor.

In 1/2 Out

Non editable. These output are fixed, and cannot be changed.

Audio Setup: Metro / MP3 / Speakers

This page lets you define various parameters for the Metronome, and turn the Speakers on/off.

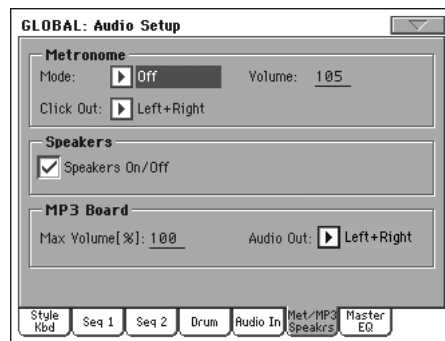

Metronome

Mode

▶GBL^{Gbl}

Use this parameter to activate the metronome for the Style Play and/or Song play operating modes.

Off	No metronome is heard.
Style	The metronome is always activated when playing a Style.
Song	The metronome is always activated when playing a Song.
Style+Song	The metronome is always activated when playing a Style or Song.

Volume

▶GBL^{Gbl}

Use this parameter to set the volume of the metronome.

Click Out

▶GBL^{Gbl}

The metronome’s click can be routed to any audio output.

Hint: When sending the click to your drum player, we suggest to select one of the sub-outs Out 1 and 2, to avoid it is sent to the audience through the Left+Right outputs.

Note: The selected Metronome Mode must not be Off, in order for the click to be sent to an audio output during playback.

See “Tracks” on page 226 for detailed information on the available outputs.

Speakers

Speakers On/Off

▶GBL^{Gbl}

Use this checkbox to turn speakers on or off. This option is useful when the instrument is connected to an external amplification system, and you don't need the speakers.

MP3 Board

This section only appears when the optional EXBP-Dual MP3 board has been installed.

Max Volume

▶GBL^{Gbl}

Use this parameter to set the maximum volume of the MP3 Player. This control lets you balance MP3 files against SMF Songs and Styles.

0...100 Max volume in percentage.

Audio Out

Use this parameter to select the audio output for the MP3 Player. See "Tracks" on page 226 for detailed information on the available outputs.

Audio Setup: Master EQ

In this page you can access the semi-parametric Master EQ. This EQ is placed at the end of the audio path, just before the audio outputs.



Note: When the Master EQ is enabled, polyphony is reduced to 118 notes.

Enable

▶GBL^{Gbl}

Use this checkbox to enable or disable the Master EQ.

Low Gain

▶GBL^{Gbl}

This parameter lets you adjust the low frequencies master equalization. This is a shelving curve filter. Values are shown in decibels (dB).

-18...+18dB Low gain value in decibels.

Mid (Middle) Gain

▶GBL^{Gbl}

This parameter lets you adjust the semi-parametric middle frequencies master equalization. This is a bell curve filter, centered around the frequency set with the Freq knob. Values are shown in decibels (dB).

-18...+18dB Middle gain value in decibels.

Mid (Middle) Freq

▶GBL^{Gbl}

This parameter lets you adjust the center frequency for the semi-parametric middle band. Values are shown in Hertz (Hz).

100Hz...10kHz

Center frequency in Hertz.

Hi (High) Gain

▶GBL^{Gbl}

This parameter lets you adjust the high frequencies master equalization. This is a shelving curve filter. Values are shown in decibels (dB).

-18...+18dB High gain value in decibels.

Voice Processor Setup and Preset sections

See the relevant "Voice Processor" chapter, starting from page 233.

Video Interface: Video Out

If your Pa800 is fitted with a Video Interface Board (VIF4), use this page to adjust its parameters.

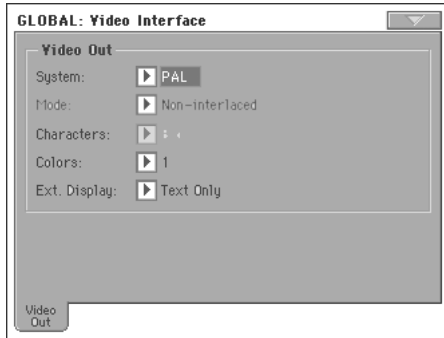

System

▶ GBL^{Gbl}

Selects the video standard (PAL or NTSC).

Mode

▶ GBL^{Gbl}

Experiment with this parameter to see if your external monitor produces better results with an interlaced or de-interlaced video signal.

Character

▶ GBL^{Gbl}

Select the character size (Big or Small).

Colors

▶ GBL^{Gbl}

Selects a color set for the lyrics and background.

1...5 Color set.

External Display

Use this parameter to decide what to show in the monitor connected to the Video Out port (optional, requires the VIF4 Video Interface).

Text Only *Default at startup.* Only Lyrics and Chords (if any) are shown in the external display.

Mirror The internal display of the Pa800 is duplicated ("mirrored") to the external display.

Touch Panel Calibration

From time to time (for example, after loading a new operating system), calibrating your Color TouchView™ display may be necessary to make pointing more precise. If so, use this page.



1. When in this page, first touch exactly inside the set of arrows in the upper left corner of the display.
2. The arrows will subsequently move to the other corners of the display. Touch exactly inside them.
3. Finally, touch Save to confirm the new calibration.



- In case you want to exit and cancel the calibration, press EXIT before completing the procedure.

Hint: To quickly reach this page from any other page, press GLOBAL to enter the Global mode, then press it again and keep it pressed, until this page appears.

Page menu

Touch the page menu icon to open the menu. Touch a command to select it. Touch anywhere in the display to close the menu without selecting a command.



Note: In each Global page, the only available Write Global options from the page menu are the ones relevant to the content of the current page. All other Write Global options are greyed out.

Write Global-Global Setup

Select this command to open the Write Global-Global Setup dialog box, and save global settings that are not tied to a single operative mode. These settings are programmed in the Global edit mode.

See “Write Global - Global Setup dialog box” on page 231 for information on the dialog box.

Write Global-Midi Setup

Select this command to open the Write Global-Midi Setup dialog box, and save the current MIDI settings to a MIDI Setup.

See “Write Global - Midi Setup dialog box” on page 231 for more information.

Write Global-Talk Configuration

Only available when the Talk is activated. Select this command to open the Write Global-Talk Configuration dialog box, and save the current Talk settings (see “Voice Processor Setup: Talk” on page 234).

See “Write Global - Talk Configuration dialog box” on page 232 for more information.

This parameter is automatically set to off when turning the instrument off.

Write Global-Voice Processor Setup

Select this command to open the Write Global-Voice Processor Setup dialog box, and save the current Voice Processor Setup settings (see from page 229).

See “Write Global - Voice Processor Setup dialog box” on page 232 for more information.

Write Global-Voice Processor Preset

Select this command to open the Write Global-Voice Processor Preset dialog box, and save the current Voice Processor Preset settings (see from page 235).

See “Write Global - Voice Processor Preset dialog box” on page 232 for more information.

Write Global-Auto Select Setup

Choose this command to save the preferred Styles, Sounds and Performances assigned to the control panel STYLE and PERFORMANCE/SOUND buttons, via the Auto Select functions (see page 221).

This way, the next time you will turn the Pa800 on, the preferred Styles, Sounds and Performances will be still assigned to the relevant buttons.

Write Quarter Tone SC Preset

Choose this command to open the Write SC Preset dialog box, and save the current scale settings in one of the four available SC Presets.

See “Write Quarter Tone SC Preset dialog box” on page 232 for more information.

Write Global - Global Setup dialog box

Open this dialog box by selecting the Write Global-Global Setup item from the page menu. Here, you can save most settings, programmed in the Global edit mode, to the Global file in memory.



Parameters saved in the Global Setup area of the Global are marked with the ▶GBL^{Gbl} symbol through the user’s manual.

Write Global - Midi Setup dialog box

Open this dialog box by selecting the Write Global-Midi Setup item from the page menu. Here, you can save all MIDI settings to a MIDI Setup, that is included in the Global file in memory.



Parameters saved in the MIDI Setup area of the Global are marked with the ▶GBL^{Mid} symbol through the user’s manual.

Name

Name of the MIDI Setup to be saved. Touch the **T** (Text Edit) button next to the name to open the Text Edit window and modify the name.

Midi Setup

One of the 8 available MIDI Setup locations, where to save current MIDI settings.

Write Global - Talk Configuration dialog box

(Only available when the Talk function is activated.) Open this dialog box by selecting the Write Global-Talk Configuration item from the page menu. Here, you can save Voice processor's Talk settings (see "Voice Processor Setup: Talk" on page 234).



Parameters saved in the Talk Configuration area of the Global are marked with the **▶GBLTik** symbol through the user's manual.

Write Global - Voice Processor Setup dialog box

Open this dialog box by selecting the Write Global-Voice Processor Setup item from the page menu. Here, you can save current settings for the Voice Processor Setup edit section (see starting from page 229).

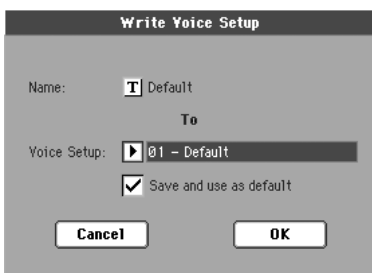

Parameters saved in the Voice Processor Setup area of the Global are marked with the **▶GBLVPs** symbol through the user's manual.

Name

Name of the VP Setup to be saved. Touch the **T** (Text Edit) button next to the name to open the Text Edit window and modify the name.

Voice Setup

One of the 16 available Voice Setup locations, where to save current VP Setup settings.

Save and use as default

Check this option when saving a VP Setup, you would like to be automatically selected when turning the instrument on.

Write Global - Voice Processor Preset dialog box

(Only available when the Talk function is NOT activated.) Open this dialog box by selecting the Write Global-Voice Processor Preset item from the page menu. Here, you can save current settings for the Voice Processor Preset edit section (see starting from page 235).



Parameters saved in the Voice Processor Preset area of the Global are marked with the **▶GBLVPp** symbol through the user's manual.

Name

Name of the VP Preset to be saved. Touch the **T** (Text Edit) button next to the name to open the Text Edit window and modify the name.

Voice Preset

One of the 128 available Voice Preset locations, where to save current VP Preset settings.

Write Quarter Tone SC Preset dialog box

Open this dialog box by selecting the Write Quarter Tone SC Preset item from the page menu. Here, you can save the current scale settings in one of the four available SC Presets.

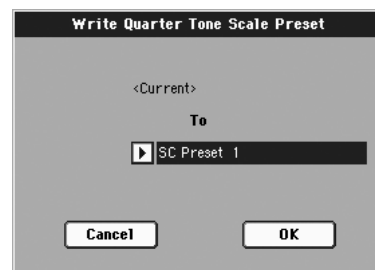

To

One of the 4 available SC Preset locations, where to save current scale settings.

Voice Processor

The Voice Processor applies effects and three-part harmony to your voice. Some dedicated controllers on the control panel allows you to quickly access the most often used functions:

- MIC On/Off button
- MIC volume slider
- MIC FX slider
- HARMONY on/off button
- EFFECT on/off button

In addition, you can edit the Voice Processor Setups (general settings for the singer's voice) and Presets (programming of various effects and harmony styles) in the dedicated pages of the Global edit mode, described in this chapter.

Accessing the Voice Processor edit pages

While in the Global edit mode, press the MENU button to access the edit section menu:

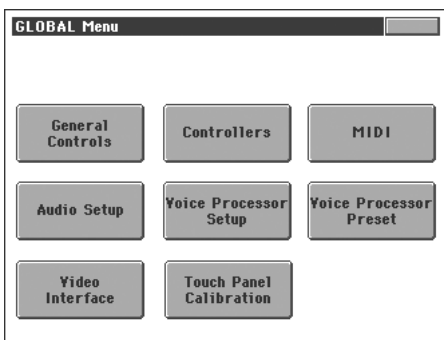

When this page appears, touch either the Voice Processor Setup or the Voice Processor Preset item to access the relevant edit pages.

An alternative way to access these pages is to keep the SHIFT button pressed, and press either the MIC (Setup page), HARMONY (Preset page) or EFFECT (Effects page) button on the control panel.

Voice Processor Setup: Setup

In this page you can select a Voice Processor Setup, and set some general parameters for the current Setup.

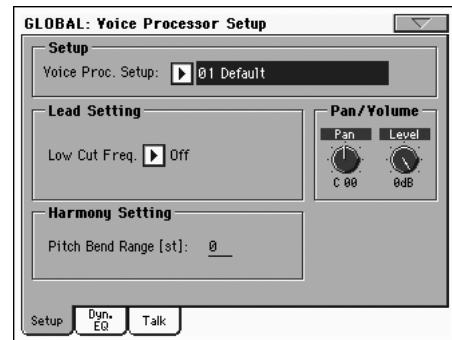

Setup

Voice Processor Setup

Use this parameter to select a Voice Processor Setup.

Setup parameters are global and do not change when a different preset is recalled. Setup parameters are all the parameters found in the Voice Processor Setup edit section, including Lead voice input level and pan, Compression/Gate, and EQ parameters among many others.

They are parameters that would typically be set for a given situation based on the singer, microphone or studio configuration and then left that way as a basis for the presets within the Voice Processor. If you change your microphone (or singer!) the EQ/Compression settings need to only be adjusted once in the setup section.

If you wish to save your setup settings, just select the "Write Global-Voice Processor Setup" command from the page menu (see page 232).

Lead Setting

Low Cut Frequency

►GBLVps

A low-cut filter can be activated on the Lead Voice. This filter allows for a cleaner signal from the microphone, by "cutting out" pops, room rumble and mic handling noise.

Off No low-cut filter applied.

60, 80, 120Hz Filter set to different frequencies. The frequencies below the set value are cut out.

Harmony Settings

This parameter is a general setting for the Harmony section voices, that is saved in the Voice Processor Setup. It will not change when a different Preset is selected.

Pitch Bend Range ▶GBL^{VPs}

Only available in Notes mode. Sets the range (in semitones) that MIDI pitch bend information will alter the pitch of the harmonies in Notes mode.

Pan/Volume

Pan knob ▶GBL^{VPs}

Adjusts panning for the Lead voice. L64 (panned fully left) to R63 (panned fully right).

Level knob ▶GBL^{VPs}

This parameter sets the Lead voice level.

Off Lead voice is turned off.

-30dB ... 0dB Lead voice level.

Voice Processor Setup: Dynamics / EQ

In this page you can adjust parameters for the Compressor/Gate and Equalizer, applied to the Lead and Harmony voices.



Assign

Dyn ▶GBL^{VPs}

Compressor/Gate assignment. The options are Off, Lead + Harmony, Harmony or Lead. The compressor has auto-makeup gain, so there are no output levels problems when selecting a different option.

Dynamics

The Voice Processor has dynamics processing optimized for vocals.

Thresh knob ▶GBL^{VPs}

Compressor Threshold. Range: 0 to -60 dB.

Ratio knob ▶GBL^{VPs}

Compression ratio. Range: 1.1:1 to 64:1.

Gate knob ▶GBL^{VPs}

Gate Threshold. Range: Off, -70dB to 0dB

EQ

The Voice Processor has an extremely flexible 3-band EQ with frequency and gain-adjustable high and low shelving bands, as well as a fully parametric band with Q control.

Low Gain knob ▶GBL^{VPs}

Low Shelving Frequency cut/boost. Range: ±12 dB.

Low Frequency knob ▶GBL^{VPs}

Low Shelving Frequency center frequency. Range: 80Hz...16kHz.

Mid Gain knob ▶GBL^{VPs}

Mid Band Frequency cut/boost. Range: ±12 dB.

Mid Frequency knob ▶GBL^{VPs}

Mid Band Frequency center frequency. Range: 80Hz...16kHz.

Mid Q knob ▶GBL^{VPs}

Resonance of the midband. Range is .1 (wide band) to 10 (very narrow band).

High Gain knob ▶GBL^{VPs}

High Shelving Frequency cut/boost. Range: ±12 dB.

High Frequency knob ▶GBL^{VPs}

High Shelving Frequency center frequency. Range: 80Hz...16kHz.

Voice Processor Setup: Talk

This page is where you can set the Talk function, to be used to address the audience, speaking over the background music. Parameter contained in this page are relative to programming parameters, and are used to attenuate the music when speaking.



After editing, you can save the Talk settings in memory, by choosing the “Write Global - Talk Configuration dialog box” command from the page menu (see “Write Global-Talk Configuration” on page 231).

Note: The “Write Global-Talk Configuration” command is only available when the Talk is activated.

Talk

Talk On/Off ▶GBL^{TK}

On/off switch for the Talk function. This is the same switch you can find in the Mic panel of the Style Play and Song Play modes.

This parameter is automatically set to off when turning the instrument off.

Note: When you deactivate the Talk function, the Voice Processor Preset is recalled. Any unsaved change to the Preset will be lost.

Mode

Auto (AutoTalk) ▶GBL^{TK}

When this parameter is checked, the Talk function automatically engages when the Sequencer or Arranger is stopped. This way, you can talk to the audience between two songs, without the need to touch the Talk On/Off button.

Mixer

FX Level knob ▶GBL^{TK}

Use this knob to attenuate the effects level. 0dB corresponds to no attenuation.

Master Volume Attenuation knob ▶GBL^{TK}

Use this knob to reduce the volume of all tracks (Keyboard, Style, Sequencer, Pad...). 0dB corresponds to no level reduction.

Reverb

Type ▶GBL^{TK}

Use this parameter to choose a reverb to be automatically selected when turning the Talk function on. These reverbs cannot be edited.

Hall	Smooth Hall
Wet Plate	Dry Plate
Room	Bright Room
Early Reflections	

Voice Processor Preset: Preset

This page allows you to select a Voice Processor Preset, as well as turning on or off the various Voice processor modules.



Preset

Voice Processor Preset ▶PERF ▶STS ▶STS^{SB}

Use this parameter to select a Voice Processor Preset. A Preset is the programming of all Voice Processor's harmony and effect parameters. A Preset is always saved in a Performance or STS. It is therefore recalled when selecting a Performance or STS.

If you wish to save your Preset settings, just select the "Write Global-Voice Processor Preset" command from the page menu (see page 231). The saved Preset will appear in the list of available Presets.

Harmony On/Off

These are "switches" for the voices generated by the Harmony section.

V1...V3 ▶GBL^{VP}

These checkboxes allow turning each of the three Harmony Voices On or Off, independent of the Level knob in the Harmony Voice page (see "Level knob" on page 238).

This is the same as the "Voice On/Off" checkbox (see page 237).

Master On/Off

These are “switches” for the various Voice Processor sections.

Lead ▶GBL^{Vpp}

This checkbox allows turning the lead voice On or Off, independent of the Lead Level knob in the Voice Processor Setup section (see “Level knob” on page 234). This is useful in creating presets where you want to hear harmony voices only.

Note: This parameter is only available when the Harmony section is turned on. If it is turned off, the Lead parameter is automatically set to On.

Harmony ▶GBL^{Vpp}

This checkbox allows the enabling/disabling of the Harmony module.

Effects ▶GBL^{Vpp}

This checkbox allows the enabling/disabling of the Voice Processor Effects module.

Voice Processor Preset: Harmony

In this page you can define general parameters for the Harmony module.

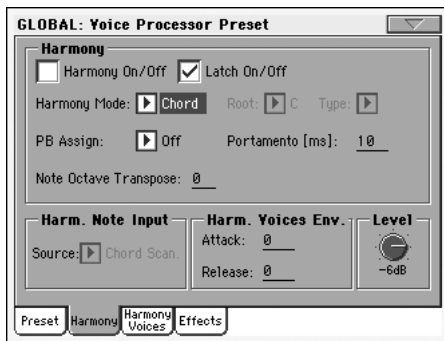

Harmony

Harmony On/Off ▶GBL^{Vpp}

This checkbox allows enabling/disabling of the Harmony module. It is the same control found in the “Preset” page.

Latch On/Off ▶GBL^{Vpp}

When enabled in Chord mode, the latest chord played remains active after the notes have been released from the keyboard. When enabled in Notes mode, the harmony voices will only respond to note input when the number of notes being played equals the harmony voices enabled. This ensures logical voice assignment when voices change. When Latch is On, the envelope parameters Attack and Release are not applicable.

Harmony Mode ▶GBL^{Vpp}

Assuming the selected “Harmony Track” is “Global” (see page 176), this parameter changes the current harmony mode. If a different option is selected, this parameter has no effect.

Available parameters are: Scalic (Scalic presets), Chord (Chordal presets), Shift, and Notes (Shift and Notes presets). See “Harmony and Tuning with the Voice Processor” on page 240 for a full description of each harmony mode.

Root ▶GBL^{Vpp}

In Scalic presets this sets the scale root.

Type ▶GBL^{Vpp}

In Scalic presets this sets the scale type. If the selected type is Custom, a Custom Map can be used (see “Custom Voice Mapping” on page 238).

PB Assign ▶GBL^{Vpp}

Pitch Bend control assignment. Allows assignment of the pitch bend to Pitch (applicable in Notes and Chord harmony modes).

Note: For this to work, a value other than zero must be assigned to the “Pitch Bend Range” in the “Voice Processor Setup: Setup” page (see page 234).

Portamento ▶GBL^{Vpp}

This is defined in milliseconds as the time to reach a target note when a harmony voice needs to change pitch.

Note Octave Transpose ▶GBL^{Vpp}

This transposes the harmony voices in Notes mode (see “Harmony Mode” on page 236). The value corresponds to octaves (± 4). This is useful when used in conjunction with “In Note Range-High” and “In Note Range-Low” parameters (see page 225).

When receiving notes from MIDI, this value is summed to the value of the “Octave Transpose In” parameter, found in the “MIDI: MIDI In Control” page (see page 224).

Harmony Note Input

In Style Play and Song Play mode, when the Harmony track is set to Global, the Voice Processor’s Harmony module can receive notes and chords from a source different than the Arranger’s Chord Scanning area. This way, you can continue sending chords to the Arranger with your left hand, while, for example, sending chords or notes to the Harmony module with your right hand.

Source ▶GBL^{Vpp}

Assuming the selected “Harmony Track” is “Global” (see page 176), this parameter allows you to select a source of notes for the Harmony module of the Voice Processor. If a different option is selected, this parameter has no effect.

Note: This parameter can only be edited when “Harmony Mode” is “Note” or “Shift” (see above). When the “Chord” Harmony Mode is selected, only the Chord Scanning option is available.

Chord Scanning

Notes are received from the same chord scanning area dedicated to the Arranger. For example, if the Lower chord scanning mode is selected on the control panel, notes for the Harmony are received from the Lower area of the keyboard.

- Lower Notes are received from the Lower area of the keyboard.
- Upper Notes are received from the Upper area of the keyboard.
- Full Keyb. Notes are received from the full range of the keyboard.

Harmony Voices Envelope

The envelope lets you set a different Attack and Release time for the harmony voices.

Note: The envelope can only work when the “Latch On/Off” parameter is turned off (see page 236).

Attack ▶GBLVpp

Sets the envelope attack time for harmony voices. Available only in Notes and Chord mode.

Release ▶GBLVpp

Sets the envelope release time for harmony voices. Available only in Notes and Chord mode.

Level

Level knob ▶GBLVpp

Sets the overall harmony voices level.

Voice Processor Preset: Harmony Voices

The Voice Processor can add up to three Harmony Voices to the Lead voice. Here you can adjust parameters for each individual voice.

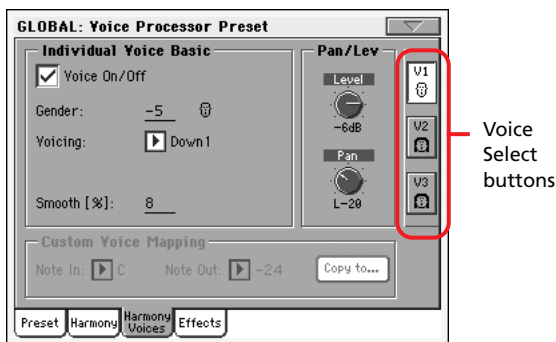

Voice Select buttons

V1...V3 ▶GBLVpp

Use these buttons to select one of the three available voices for editing.

Individual Voice Basic

Voice On/Off ▶GBLVpp

This checkbox allows enabling/disabling of the selected Harmony Voice. It is the same control found on the “Preset” page.

Gender ▶GBLVpp

This parameter sets the formant of the Harmony Voice. Use it to alter the character of the voice ranging from -50 (a big person with a deep voice) to 0 (no change) to +50 (mice/alien sound).

Voicing ▶GBLVpp

This parameter is used to set the voicing of the selected voice. This parameter means different things depending on the harmony mode of the preset.

Scalic Mode Presets

In this mode the Voicing parameter specifies the interval of the harmony note with respect to the input note in the scale. The range of values goes from --8, which is 2 octaves below the input note, to ++8 which is two octaves above the input note. For example, a setting of +3 will result in a harmony voice a third above the input voice, related to the current scale.

Chord Mode Presets

In this mode the Voicing parameter specifies the relation of the harmony note to the input note with respect to the current chord. In Chord mode presets, the harmony voices are always notes in the chord. A setting of Up1 will result in the harmony voice being the next note above the input voice in the chord. For instance, if the chord was C Major and the input note was an E, an Up1 setting would produce a G harmony voice, just above the input E.

The range of values goes from Down 5 to Unison to Up6. Additional values are Root1 and Root2 which give the root of the recognized chord as the harmony voice, and Bass1 and Bass2 (bass voicing) which give the lowest note received. Root2 and Bass2 are the higher pitch Root and Bass settings.

Shift Mode Presets

In this mode the voices are shifted relative to the input note. The values range from -24 semitones to +24 semitones.

Notes Mode Presets

In this mode there is no selectable voicing, since harmony voices exactly play received notes.

Smooth ▶GBLVpp

Sets how much of the input pitch nuance is applied to the output voice.

Pan/Level

Level knob

▶GBL^{VPp}

Sets the output level of the selected voice. Please note that there is also a master harmony voice level found in the “Harmony” page.

Pan knob

▶GBL^{VPp}

Adjusts the pan for the selected voice. L64 (panned fully left) to R63 (panned fully right).

Custom Voice Mapping

This area is only available in Scalic Mode, when Type is Custom (see “Voice Processor Preset: Harmony” on page 236).

Scale mode harmonies are basically pitch maps. For each input note in a scale you can define a resulting harmony note. The Voice Processor has pre-defined pitch maps for all the offered scale roots, types, and intervals.

The Custom voicing feature allows you to create your own pitch maps. For example, you could define a pitch map so that a C input produces an E output and a D input produces an A output. The best way to work with custom voicing is as follows:

- For a given harmony voice, select the scale root, type, and interval that most closely matches the desired voicing.
- Go to the “Note In” parameter and select the input note that requires a different harmony note.
- Go to the “Note Out” parameter and change the harmony note as desired.
- Select various other input notes and remap as desired. Repeat the above steps for each harmony voice. You can also copy a map from a voice to other voices.
- The custom map can be transposed under the Harmony page by changing the “Root” parameter.

Note In

▶GBL^{VPp}

Incoming note.

C ... B Original note.

Note Out

▶GBL^{VPp}

Resulting note when applying the custom map.

±24 Number of semitones above or under the received note.

UNI Unison. The same note received on the input is sent to the output.

NC No Change. The harmony voice will keep its previous pitch until the lead voice pitch changes to a non “NC” note.

Copy to... button

Use this button to copy the current custom map to another voice. When you touch the button, the Copy Custom Voice Mapping dialog box appears:

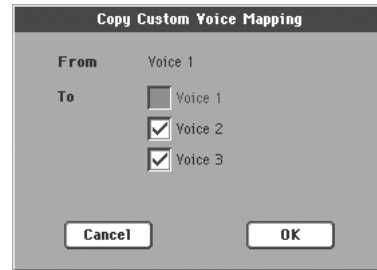

Check all desired target voices, then touch OK to confirm the copy.

Voice Processor Preset: Effects

This page allows to adjust the various effect parameters for the Voice Processor.



FX Mix

Lead to Delay knob

Lead to Delay effects send.

▶GBLVpp

Harmony to Delay knob

Harmony to Delay effects send.

▶GBLVpp

Reverb Level knob

Sets the overall volume of the Reverb effect.

▶GBLVpp

FX Level knob

Sets the overall volume of the Delay effect.

▶GBLVpp

Delay

Type

Use this parameter to select a Delay type.

▶GBLVpp

- Mono Mono delay.
- Stereo Maintains the panning of the sends.
- PingPong1 Sends the lead voice to the left effect end only.
- PingPong2 Sends the lead voice to the sends depending on the lead pan setting.

Delay

▶GBLVpp

Only available when Src = Manual (see below). Use this parameter to fine adjust (in milliseconds) the current delay time.

Feedback

▶GBLVpp

Delay feedback amount.

Src (Source)

▶GBLVpp

Use this parameter to set the source of the tempo for the delay.

MIDI Tempo is received from MIDI.

Manual The delay time is set using the “Delay” parameter.

R (Ratio)

▶GBLVpp

Sets the ratio between the tempo and the resulting delay. For example, “1:2” means that for each quarter note at the current tempo, the delay plays two notes. A value of “1:4” means that for each quarter note at the current tempo, the delay plays four notes, and so on.

Hi Freq Damp (High Frequency Damping)

▶GBLVpp

High Frequency Damping.

Reverb

Type

▶GBLVpp

The list of reverb types includes the following acoustic simulations.

Hall	Smooth Hall
Wet Plate	Dry Plate
Room	Bright Room
Early Reflections	

Pre Delay

▶GBLVpp

Reverb Pre-delay time. Sets the delay time prior to the reverb output. Large rooms typically have reverbs that start much later than the initial signal.

Reverb Time

▶GBLVpp

Reverb Decay Time. Length or the Reverb.

Pre LEQ Gain

▶GBLVpp

Reverb pre-equalization of the low frequencies. Specifies the characteristics of the reverbs low frequencies.

Pre HEQ Gain

▶GBLVpp

Reverb pre-equalization of the high frequencies. Specifies the characteristics of the reverbs high frequencies.

Harmony and Tuning with the Voice Processor

Harmony

Here's where we can go into a little more depth about harmonies. We've tried to keep it practical, focusing on what Voice Processor can do for you.

Harmony Modes

The Voice Processor has four different harmony modes, which give four unique methods of creating harmony. Once we get into describing the more complex harmony modes, we'll be showing you examples based on the C major scale. If you are unfamiliar with this scale we've shown C major here.

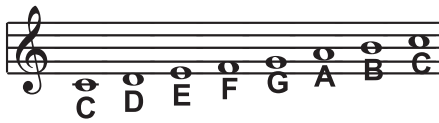

Notes Mode

In this mode, you provide the Voice Processor with specific note information to determine the pitch of the harmony voices. This is the most direct and flexible way of creating harmonies, allowing you to weave complex melodies and counter harmonies irrespective of your lead vocal.

Shift Mode

Also known as "Fixed Interval", this takes the pitch of your lead voice and creates harmonies a set number of semitones away, based on that pitch. The method of creating harmonies, using a fixed number of semitones relative to an input note or pitch, is called chromatic harmony, the theory of which we'll go into later. We consider this type of harmonizing to be non-intelligent because Voice Processor is not set to any particular key or scale. These are pure, parallel harmonies. The most common shift harmony voices are the 5th (7 semitones) and octave (12 semitones), ranging from two octaves below the input to two octaves above the input pitch.

Below is the C Major scale, showing third above chromatic scale harmony, as used in Voice Processor Shift Mode.

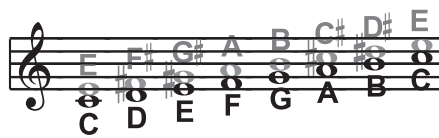

Black = Lead, Grey = Harmony

Chord (Chordal) Mode

Chordal harmonies take your chord information to create intelligent, diatonic harmonies based on your voice. To make "Chordal" harmonies, you need to input in real time the chords of the song. This may be done either by playing on the keyboard, via MIDI or through a programmed sequence of chords included in the Harmony Track of a Song.

In Chordal mode the Voice Processor will only create harmony voices that fall on the notes of the chord. Chordal harmonies are "intelligent" because they decipher the chord you're playing and the note you're singing to produce musically pleasing harmonies. When one note above is defined as a harmony voice (Up1), the next note from the chord above the input note is output for that harmony voice.

The subsequent illustration shows the harmony notes for the C major scale with a voicing selection of a C major chord and a single "one above".

Root: C, Chord Type: Maj, Voicing: Up1

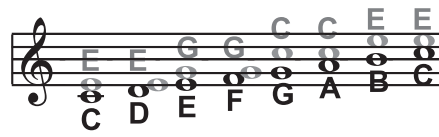

Black = Lead & Grey = Harmony

You might have noticed that each harmony note can cover more than one input note, or that each input note doesn't necessarily have a unique harmony note. For instance, C and D both have E as the 3rd above, E and F share G, and so on. This gives a more stepped sound to the harmony as the changes are both greater in magnitude and less frequent than when using other harmony methods (shift mode for example). The benefit of this method is that it is very easy to integrate vocal harmonies into your songs if you already know their chord progressions! The following lists the chords available with respect to the root of "C":

Major	C	E	G	
6	C	E	G	A
Maj7	C	E	G	B
M7sus4	C	F	G	B
min	C	E ^b	G	
min6	C	E ^b	G	A
min7	C	E ^b	G	B ^b
min7b5	C	E ^b	G ^b	B ^b
dim	C	E ^b	G ^b	[B ^{bb} (= A)]
7	C	E	G	B ^b
7b5	C	E	G ^b	B ^b
aug	C	E	G [#]	
aug7	C	E	G [#]	B ^b
sus4	C	F	G	
sus2	C	D	G	
7sus4	C	F	G	B ^b

Scale (Scalic) mode

Harmonies use key and scale information to create musically correct, diatonic harmonies. Most popular music uses a single scale, so you usually only have to input the information at the beginning of your song. “Scalic” harmonies are more dynamic than the chordal harmonies because there are unique harmony notes for each input note. The subsequent illustration shows the harmony notes for the C major scale with a voicing selection of a C major scale and a single “third above” harmony voice. You can see from the next diagram that the “Scalic” harmonies are intelligent and closely follow your lead voice for a tighter sound.

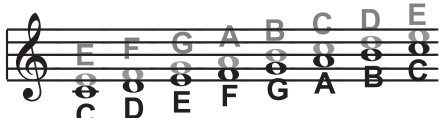

Black = Lead, Grey = Harmony

Under the Harmony page, is a parameter called “Smooth”. When set to 100% the harmony voices follow your input pitch, errors and all, but when set to 0% the harmonies will jump directly to the scalic harmony notes, kind of like a hard pitch correction on the harmony voice. Setting the Smooth parameter between 0 and 100% is like having variable amounts of pitch correction on the harmonies. Voice Processor has five pre-programmed harmony scales: three major, three minor and one custom per preset. To create a custom scale or pitch map see the

parameter description under “Custom Voice Mapping” on page 238.

It is also tricky to pick out the key in some songs. An example is “Sweet Home Alabama”. Listening, you might think this song is in the key of “D”, as that’s the first chord, but the harmonies actually work best in the key of “G” – try running the song through Voice Processor to hear for yourself.

Setting the scale can also take a bit of practice: for songs centered around the third or root of the scale it might not sound like there’s any noticeable differences between the three major or three minor scales. This is because your song doesn’t hit any of the scale’s altered notes. A melody centered around the fifth of the scale, (such as B in the key of E), highlights the differences between the scales. Try the “Sha Lala Lala ... La Tee Daa” chorus of Van Morrison’s “Brown Eyed Girl” (key: E, scale: major, 3rd above voicing) with each major scale to hear the audible difference between them. For the minor scales, Santana’s “Evil Ways” (key: G, scale: minor, 3rd above voicing) highlights the differences between the three minor scales.

The following table illustrates the third and fifth above for a given input note to illustrate the differences between the six different scales. “nc” means no change, in that the harmony voice will simply keep its previous pitch until the lead voice pitch changes to a non “nc” note.

	Lead Voice	C	C#	D	Eb	E	F	F#	G	G#	A	Bb	B
MAJ1	3rd above	E	nc	F	nc	G	A	nc	B	nc	C	D	D
	5th above	G	nc	A	nc	B	C	nc	D	nc	E	F	F
MAJ2	3rd above	E	nc	F	nc	G	A	nc	C	nc	C	D	D
	5th above	G	nc	A	nc	C	C	nc	E	nc	E	F	F
MAJ3	3rd above	E	nc	F	nc	G	A	nc	Bb	nc	C	D	D
	5th above	G	nc	A	nc	Bb	C	nc	D	nc	E	F	F
MIN1	3rd above	Eb	nc	F	G	nc	Ab	nc	Bb	C	nc	D	nc
	5th above	G	nc	Bb	Bb	nc	C	nc	D	Eb	nc	F	nc
MIN2	3rd above	Eb	nc	F	G	nc	A	nc	Bb	C	nc	D	nc
	5th above	G	nc	A	Bb	nc	C	nc	D	Eb	nc	F	nc
MIN3	3rd above	Eb	nc	F	G	nc	Ab	nc	B	C	nc	D	nc
	5th above	G	nc	A	Bb	nc	C	nc	D	Eb	nc	F	nc

Diatonic and Chromatic

We've described scalic and chordal harmonies as diatonic, and shift harmonies as chromatic; but what do those words mean? Look at a piano keyboard. Between middle "C" and the next "C" there are twelve keys – 7 white keys and 5 black keys. Each of those keys are pitched one semitone apart for a total of, you guessed it, 12 semitones. The chromatic scale uses all twelve semitone notes opposed to the diatonic scales. Thus there is only one chromatic scale, but 12 each of the major, minor, etc. diatonic scales (C major, C# major, D major, etc). Most of us have grown up hearing the traditional "doh ray me fah so la tee doh" diatonic scale, so that harmonies based on the diatonic scale sound correct.

What does this mean, harmony-wise? Diatonic scale harmonies can only use notes within specified scale or chord, so a "third above" harmony voice actually varies between three and four semitones above the lead note where the chromatic harmony would stay exactly four semitones (a major 3rd) above each note.

To recap: we have three different harmony modes that use chromatic or diatonic scales.

Shifting, which uses the chromatic, 12 semitone scale, changes the input pitch by a fixed number of semitones:

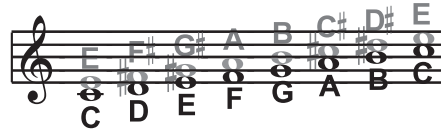

Chordal, which uses the root, third, fifth and sometimes seventh of the many diatonic scales, pitches the harmony voice to the closest note contained within the chord:

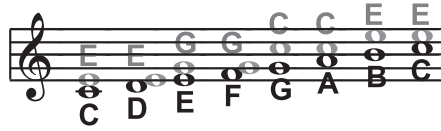

Scalic, which uses one of many diatonic scales, pitches the harmony voice to the nearest note contained within the scale:

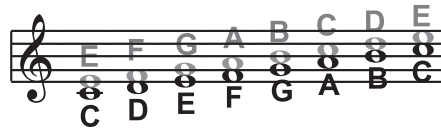

Theory aside, the best way to get great sound is to experiment with all of Voice Processor' possible harmony modes. Not only will you develop an intuitive sonic sense of what works best where, but by investigating different permutations and combinations you could discover some delightful sounds you might otherwise have missed.

Media edit mode

The Media edit mode is the place where you can manage files. This edit environment overlaps the current operating mode (Style Play, Song Play, Sequencer, Sound Edit).

Storage devices and internal memory

User-accessible storage devices

During a Media operation, files are usually exchanged between a storage device and the internal memory. You can access the following mass storage device types:

Abbreviation	Media type
SSD-U(ser)	20 MB of User-reserved area of the internal SSD Flash-ROM memory. Similar to a hard disk.
SSD-S(ystem)	Factory area of the internal SSD Flash-ROM memory. Only accessible when updating the Operating System and Musical Resources, or exchanging Factory Sound, Styles and Pads.
HD	Internal Hard Disk (optional with the HDIK-1 kit).
USB-F(ront)	USB memory device (like a pen drive) connected to the front USB Host port.
USB-R(ear)	USB memory device (like a pen drive) connected to the rear USB Host port.

A device can be selected by using the Device pop-up menu, shown in the lower left corner of most Media pages:

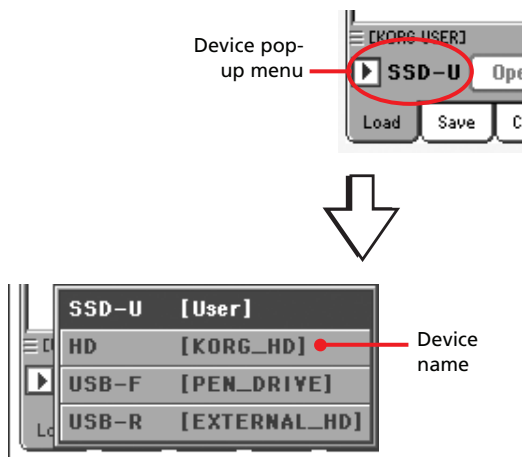

About the SSD

The SSD (Solid State Disk) is a non-volatile memory, whose content is preserved even after turning the instrument off. It is divided in the following separate areas:

SSD area	Content type
User PCM	Up to 64 MB of imported or recorded PCM Samples
System Area (SSD-S)	Operating System and Musical Resources (Styles, Pads, Sounds, Performances, STSs, Multisamples and Global settings). Includes the User and Favorite data.
User Area (SSD-U)	20 MB area reserved to the user. To be considered similar to a special type of hard disk.

SSD and the internal RAM memory

After turning the instrument on, all data contained in the System area of the SSD (Factory and User data) are transferred to a RAM memory. This memory is volatile, and will be deleted when turning the instrument off.

Before turning the instrument off, please remember to save any new or modified data, like Songs or Samples.

Supported device

The following table shows the types of storage devices that can be used with the Pa800.

Internal	External (USB Host)
SSD User (<i>supplied as standard</i>)	Hard Disk
Hard Disk (<i>optional</i>)	Pen Drive
	Floppy Disk
	Compact Disk (<i>read only</i>)

External devices, like hard disks or pen drives, support the FAT16 and FAT32 formats with long file names. NTFS (Windows NT/2000/XP/Vista), HFS (Mac OS 9) and HFS+ (Mac OS X) formats are not supported.

Selecting and deselecting files

While a file list is shown in the display, you can select any item by touching it. The selected item is highlighted.

You can deselect all items in any of the following ways:

- Touch an empty area in the file list (if available).
- Touch the Device pop-up icon, and select the current device again.

Searching files

The Search function allows for searching a file in the various media. You can open the Search window by touching the Search icon (🔍) while in the following pages:

- Song Selection
- On-the-fly TXT loading
- JukeBox Editor > Add
- SongBook > Edit2 > Browse
- Sampling > Load Sample
- Sampling > Import
- Media pages

Here is a typical Search window:

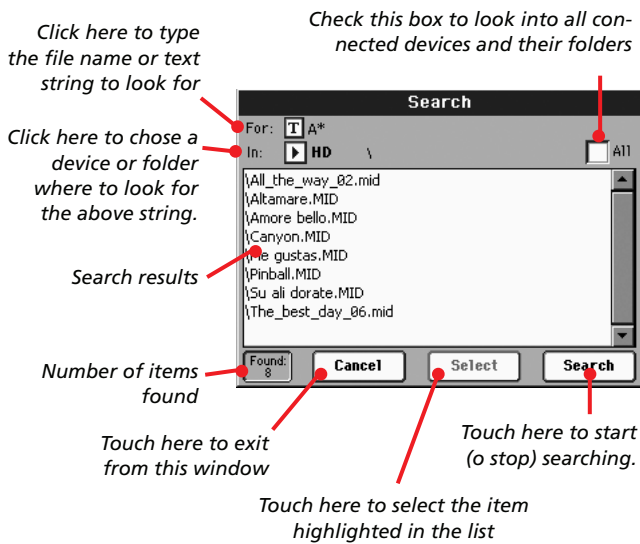

For

Touch the **T** (Text Edit) button to type the name (or part of) of the item(s) you are looking for. During search, you can use the wildcards “?” (any single character) and “*” (any sequence of characters).



For example, if you are looking for songs with names containing the word “love”, you can use the “*” wildcard to write something like “*love*”. This will find out “My love”, “Love is a wonderful thing”, and “War and love”.

Also, if you are looking for words that can be spelled in a slightly different way, you can use the “?” wildcard to find all occurrences; “gr?y” will find out both “gray” and “grey”.

Depending on the page you are in, file types are automatically filtered to match the current operating mode. For example, while in the Song Selection window, you can only search for files with the “.MID”, “.KAR” and “.MP3” extensions (MP3 files can be searched only if the EXBP-DualMP3 board is installed).

In addition to files, folders are searched. If you open a folder, the file selector shows its content, where you can then select one of the files it contains.

In

Use this pop-up menu to choose a device where to look in.

All

Check this box to search in all available devices: USB pen drive, internal SSD memory, internal hard disk (if installed)...

List

Search results are shown here. The full file path is shown, together with the matching file names.

Search

Once you have typed the string to search for, touch this button to execute the search. The name of this button changes to “Stop” (see below). The time needed to complete the search depends on the size of the device(s) and the number of files.

Note: Only one search a-time can be carried on. Please wait for the current search to be completed, or touch the Stop or Select button in the display to stop the current search and do a new one.

Hint: You can touch the Cancel button in the display, or press the EXIT button in the control panel, to exit from this window and carry on other operations. The search will go on in the background.

Stop

This button appears after you have touched the Search button in the display. While a search is going on, a series of dots (...) appears in this button. This means the search is going on and is not yet completed.



Touch this button to stop the ongoing search. The name of the button reverts to “Start” (see above). Any file found will remain in the display, until you do a new search.

Select

Touch this button to select the item highlighted in the list of matching items. You can select an item shown, even if the search is still going on.

Cancel

Touch this button to close the Search window. The current search will go on in the background, even if you exit this window and carry on any other operation.

Hint: This is equivalent to pressing the EXIT button in the control panel.

Found

This box shows the total number of items found and shown in the list.

File types

The following tables describe all the file and folder types the Pa800 can manage. Here are the files you can read or write with the Pa800.

Extension	File/folder type
SET	All the User data. (This is a folder containing other folders).
BKP	Backup file, created with the "Full Resource Backup" function of the Media > Utility page. (This is a folder containing other folders).
PKG	Operating System and Musical Resource files.
GBL	Global
VOC	Voice Processor Presets
PRF	Performance
PCG	Sound
PCM	Sample
STY	Style
PAD	Pad
SBD	SongBook
SBL	SongBook's Custom List
JBX	Jukebox
MID	Midi file (Standard MIDI File, SMF)
MP3 ^(a)	MP3 file

(a). To read and write MP3 files, the optional EXBP-Dual MP3 board is required.

Pa800 can also read (but not write) the following types of data.

Extension	File type
KAR	Karaoke file
PCG	Korg Triton Programs
KSF	Korg Trinity/Triton Sample
KMP	Korg Trinity/Triton Multisample
S	Akai Sample
P	Akai Program
AIF	AIFF audio files
WAV	WAVE audio files

Media structure

Each device (and the internal memory) can contain files and folders. Data in the Pa800 is slightly more rigidly structured than in a computer, due to the pre-configured type of data inside the instrument's memory. The diagram below shows the global structure of a Pa800 device.

Note: Style banks from 1 to 17 (Factory Styles) can be seen in Media mode only when the "Factory Style and Pad Protect" parameter is set to Off (see page 257), and only when loading or saving a single Style bank.

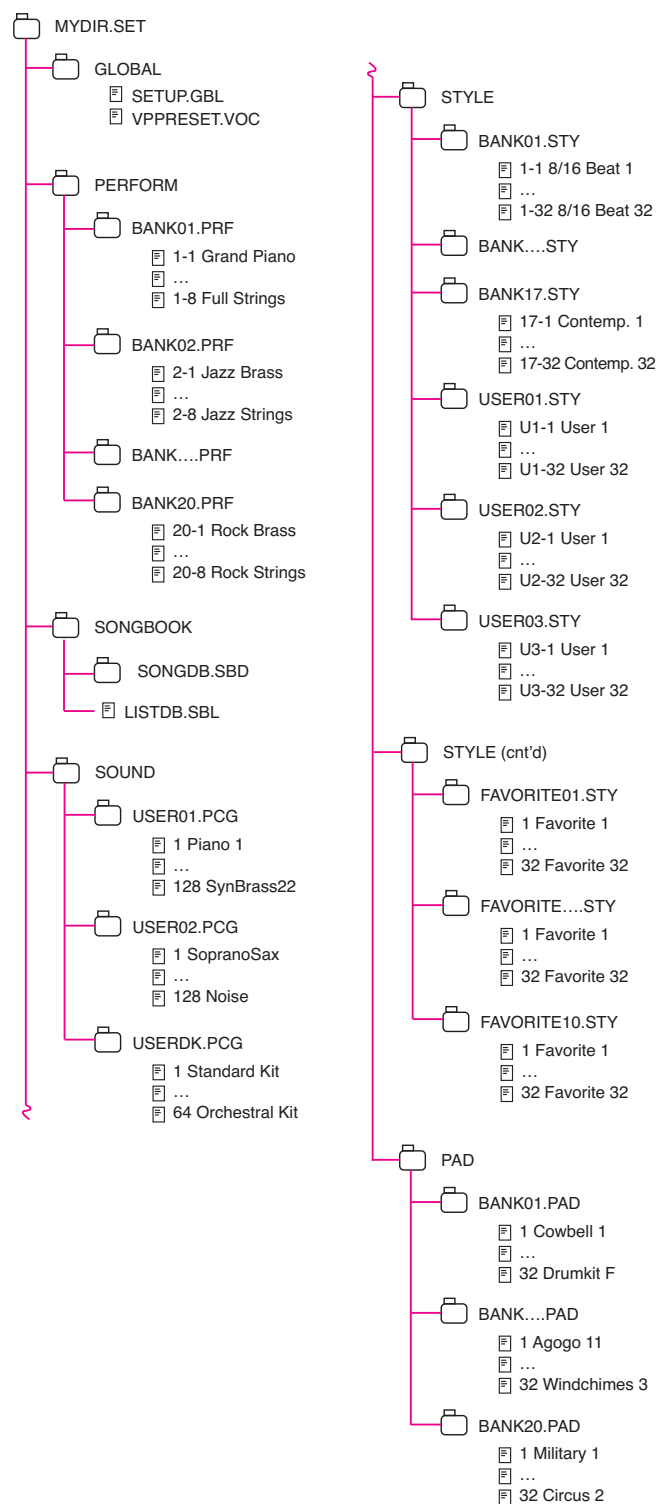

Main page

There is no main page in the Media edit mode. When pressing EXIT, you exit the Media mode, and the underlying operating mode in the background is recalled.

Page structure

All edit pages share some basic elements.

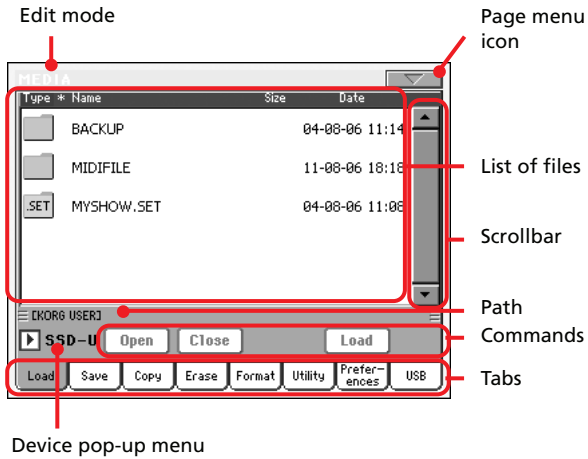

Edit mode

This indicates that the instrument is in Media mode.

Page menu icon

Touch this icon to open the page menu (see “Page menu” on page 259).

Path

Full path of the directory currently shown in the display.

List of files

This area shows the files and folder contained in the selected device.

You can touch one of the heading labels above the list to change the order in which files are shown. For example, by touching the “Name” label, the list is alphabetically re-ordered according to the file names. The selected label turns red, showing the currently selected ordering.



If you touch the red label again, the alphabetic order changes from ascending to descending, or vice-versa. The small arrow next to the label name shows the selected order.

The corresponding items in the page menu are automatically updated to reflect these changes (see “Ordered by Name” and “Ordered by Type” on page 260).

Scrollbar

Use the scrollbar to scroll the list. Touching the arrows will scroll one step at a time, while touching the bar will scroll one page at a time.

Touching the arrows while SHIFT is kept pressed jumps to the previous or next alphabetical section, or file/folder type (depending on the selected display order).

Device pop-up menu

Use this menu to select one of the available storage devices.

Commands

Commands may be different depending on the shown page. They are detailed in each relevant section.

Tabs

Use tabs to select one of the edit pages of the current edit section.

Navigation tools

When in a Media page, you can use any of the following commands to browse through the files and folders.

Scrollbar

See “Scrollbar” above.

TEMPO/VALUE controls

Use these controls scroll the list up or down.

Device pop-up menu

See “Device pop-up menu” above.

Load/Save/Copy/Erase button

Executes the media operation.

Open button

Opens the selected folder or directory (whose name begins with the “” icon).

Close button

Closes the current folder or directory, returning to the parent (“upper”) level.

Load

In this page you can load User data files (Performances, User Sounds, User Styles, the SongBook, User PCM, the Global) from an external device to the internal memory (SSD and RAM).

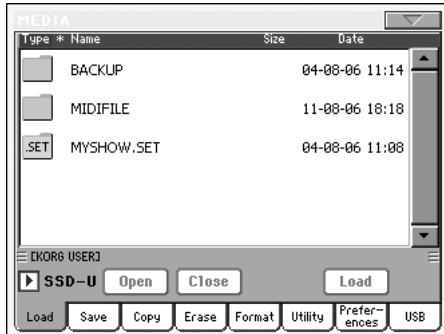

Note: While in this page, only data allowed for loading are shown. All other files are hidden.

Warning: When loading a “.SET” folder containing Sounds associated with PCM data (samples), all existing PCM data in memory are deleted. Save the data already in memory, before loading the new data.

To see if a “.SET” folder contains PCM data, open it and look for a “PCM” folder.

Hint: Load single Sounds, if you want to load new PCM data without deleting the ones already contained in memory. This will merge the existing data with the new ones.

Loading all the User data

You can load all the User data with a single operation.

1. If loading from an external device, connect the device to one of the USB Host ports.
2. Select the source device, by using the Device pop-up menu. When the device is selected, its content will appear in the display.
3. If the folder you are looking for is inside another folder, select this latter and touch the Open button to open it. Touch the Close button to go back to the parent folder.
4. Select the “.SET” folder containing the data you wish to load, and touch Load to confirm the selection.

Note: Most data loaded from an external device is merged with data already existing in memory. For example, if there is data in all three USER Style banks in memory (USER01, USER02, USER03), and there is only the USER01 Style bank in the external device, the USER01 bank is overwritten, while USER02 and USER03 banks are left unchanged.

As a result, you will have a STYLE folder in memory containing the USER01 bank you just loaded, and the old USER02 and USER03 banks.

Note: If the .SET folder you are loading contains one or more Sounds or Drum Kits making use of external PCM sample, the samples are automatically loaded (unless they are already in memory). This way, all needed samples are always loaded together with the Sounds or Drum Kits making use of them. See also “PCM Autoload” and “Load PCM button” on page 258.

Warning: When loading a “.SET” folder containing PCM data, all existing PCM data in memory are deleted. Save them before loading the folder, by selecting the “PCM” option during a Save All operation (see “Saving the full memory content” on page 251).

To see if a “.SET” folder contains PCM data, open it and look for a “PCM” folder.

To create a new .SET folder with PCM samples from different sources, see “Merging PCM samples from various sources” on page 261.

Loading all data of a specified type

You can load all User data of a specified type with a single operation.

1. If loading from an external device, connect the device to one of the USB Host ports.
2. Select the source device, by using the Device pop-up menu. When the device is selected, its content will appear in the display.
3. If the folder you are looking for is inside another folder, select the latter and touch the Open button to open it. Touch the Close button to go back to the parent folder.
4. Select the “.SET” folder containing the data you wish to load, and touch Open to open the “.SET” folder. A list of User data appears (Global, Performance, SongBook, Sounds, Style...).

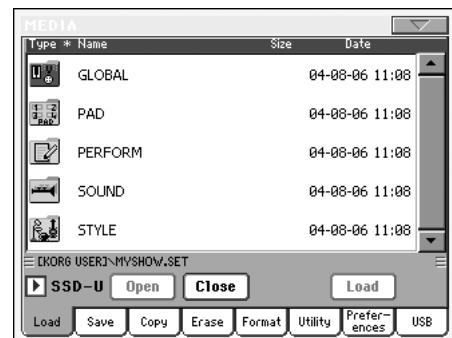

5. Select the folder containing the type of data you are looking for, and touch Load to confirm your selection.

Note: Data loaded from a storage device, and data already in memory are merged. For example, if there is data in all three USER Style banks in memory (USER01, USER02, USER03), and there is only the USER01 Style bank on a storage device, the USER01 bank is overwritten, while USER02 and USER03 banks are left unchanged.

As a result, you will have a STYLE folder in memory containing the USER01 bank you just loaded, and the old USER02 and USER03 banks.

Warning: When loading PCM data, all existing PCM data in memory are deleted. Save them before loading, by selecting the “PCM” option during a Save All operation (see “Saving the full memory content” on page 251).

Loading a single bank

You can load a single bank of User data (User Sounds, User Styles, Performances) with a single operation. A bank corresponds to a STYLE SELECT or PERFORMANCE/SOUND SELECT button.

1. If loading from an external device, connect the device to one of the USB Host ports.
2. Select the source device, by using the Device pop-up menu. When device is selected, its content will appear in the display.
3. If the folder you are looking for is inside another folder, select this latter and touch the Open button to open it. Touch the Close button to go back to the parent folder.
4. Select the “.SET” folder containing the data you wish to load, and touch Open to open the “.SET” folder. A list of User data appears (Global, Performance, SongBook, Sounds, Style...).

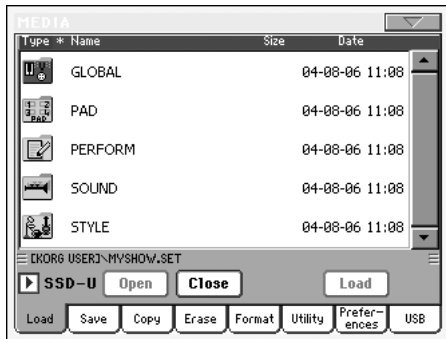

5. Select the folder containing the type of data you are looking for, and touch Open to open the selected folder. A list of User (and Favorite Style) banks appears.

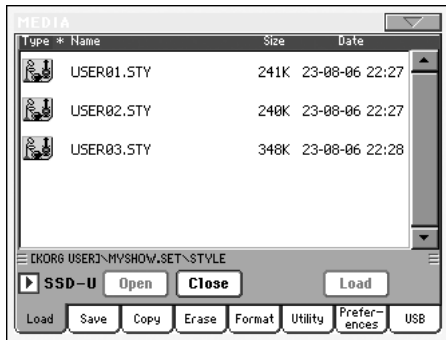

6. Select the bank you are looking for, and touch Load to confirm the selection. A dialog box appears, asking you to select one of the available User (or Favorite Style) banks in memory.

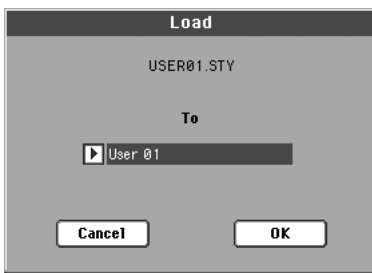

In the page above, the previously selected Style bank will be loaded into the bank 1 (USER1 button) in memory. The existing Styles in memory will be deleted and overwritten.

7. Select the target bank, and touch OK to load the source bank.

Warning: After confirming, all User data contained in the bank in memory is deleted.

Note: If Sounds or Drum Kits based on external PCM samples are deleted, choose the “Delete” command from the page menu of the Sampling mode to delete the unused samples (see the “Advanced Edit” addendum in the Accessory CD).

Note: If you are loading a bank of Sounds, and one or more Sounds or Drum Kits use an external PCM sample, the samples are automatically loaded (unless they are already in memory). This way, all needed samples are always loaded together with the Sounds or Drum Kits making use of them. See also “PCM Autoload” and “Load PCM button” on page 258.

Loading a single item

You can load a single User (or Favorite Style) item with a single operation.

1. If loading from an external device, connect the device to one of the USB Host ports.
2. Select the source device, by using the Device pop-up menu. When device is selected, its content will appear in the display.
3. If the folder you are looking for is inside another folder, select this latter and touch the Open button to open it. Touch the Close button to go back to the parent folder.
4. Select the “.SET” folder containing the data you wish to load, and touch Open to open the “.SET” folder. A list of User data appears (Global, Performance, SongBook, Sounds, Style...).

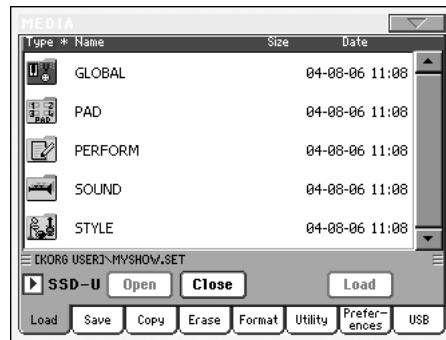

5. Select the folder containing the type of data you are looking for, and touch Open to open the selected folder. A list of User (or Favorite Style) banks appears.

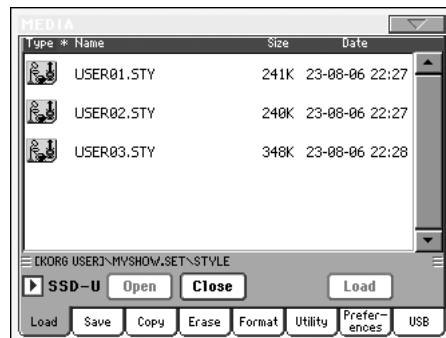

- Select the bank you are looking for, and touch Open to open it. A list of User (or Favorite Style) items appears.

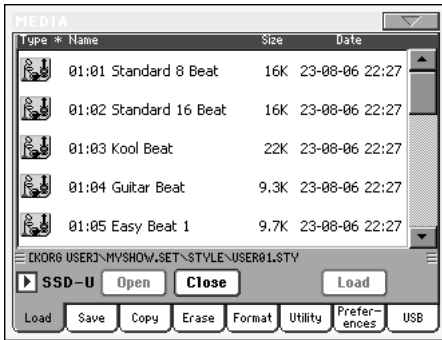

- Select the item you are looking for, and touch Load to confirm the load. A dialog box appears, asking you to select one of the available User (or Favorite Style) locations in memory.



In the dialog box above, the previously selected Style will be loaded into location 01 of the bank U01 (USER1 button) in memory. The existing Style at the same memory location will be deleted and overwritten.

Empty locations are named <empty>.

- Select the target location, and touch OK to load the source file.

Warning: After confirming, the item you are overwriting in memory will be deleted.

Note: If a Sound or Drum Kit based on external PCM samples is deleted, choose the “Delete” command from the page menu of the Sampling mode to delete the unused samples (see the “Advanced Edit” addendum in the Accessory CD).

Note: If you are loading a Sound or Drum Kit that makes use of an external PCM sample, the sample is automatically loaded (unless it is already in memory). This way, all needed samples are always loaded together with the Sound or Drum Kit making use of them. See also “PCM Autoload” and “Load PCM button” on page 258.

Loading Pa1X data

You can load Pa1X data exactly as if they were Pa800 data. Minor differences might exist between effect parameters. Also, keep in mind Voice Harmony is only 3 voices in the Pa800, while it is 4 voices in the Pa1X. Some other parameters are missing in the Voice Processor section.

At the same time, most Pa800 data can be read by any Pa1X (provided it is fitted with Operating System v. 3.0 or higher). However, keep in mind the following:

- Pa800 has a more extensive range of effects, that might not exist on the Pa1X.

- Due to the different content and organization, the Song-Book will point to different Styles.

Loading Pa80/60/50 data

You can load Pa80/60/50 data exactly as if they were Pa800 data. The only difference is that the “SOUND” folder of Pa800 is called “PROGRAM” in the Pa80/60/50. Therefore, to load Sounds from Pa80/60 disks, you must accomplish one of the following operations:

- Either rename the “PROGRAM” folder “SOUND” (by using a personal computer) before loading a “.SET” folder; or
- First load the “.SET” folder, then separately load the “.PCG” file from the “PROGRAM” folder.

Loading i-Series data

Pa800 is compatible with the Styles of the older i-Series instruments. You can load them as if they were ordinary Pa800 data.

- Copy the old i-Series data into an USB device, or transfer them to the internal SSD-U area or hard disk of the Pa800.
- Press MEDIA to go to the Media mode. Select the Load page if needed.
- While in the Load page, select the device containing the i-Series data from the Device pop-up menu.
- If you are reading an i30 file, select the “.SET” folder and touch the Open button in the display.
- Select the “.STY” folder.
- At this point, you can load the whole “.STY” folder, or open it and select a single Style.

- To load the whole folder, touch the Load button in the display. If it contains more than 16 Styles, they will be loaded into the USER banks sequentially, otherwise you will be prompted to select one of the three USER Style banks or the ten FAVORITE Style banks in memory. Once the target bank is selected, touch Load to load the bank. The “Are you sure?” message will appear. Touch OK to confirm, or Cancel to abort.

- To load a single Style, touch Open in the display to open the “.STY” folder. Since a conversion will be started at this point, please wait some seconds for the operation to be completed.

Select the Style to load, then touch Load. You will be prompted to select a target location in memory. Once the target location is selected, touch Load to load the Style. The “Are you sure?” message will appear. Touch OK to confirm, or Cancel to abort.

Note: Loading a whole “.SET” folder from an i30 file may take very long. You are advised to load a single bank or a single Style a time.

- Go to the Style Play mode, and select (one of) the loaded Style. Adjust the Tempo, then select the “Write Current Style Performance” to write changes to the Style Performance. Touch OK twice to confirm.
- Due to the difference in Sounds, you will probably want to make some adjustments to the old Styles, once they are

loaded in Pa800 (changing the Sound, Volume, Pan, Tempo, Drum Mapping, Wrap Around...).

9. To make the Sound assignment to the Style tracks effective, be sure the “Original Style Sounds” parameter is not checked (see page 88).
10. Save the Style Performance again. Select the “Write Current Style Performance” to write changes to the Style Performance. Touch OK to confirm.

Save

In this page, you can save User data from the internal memory to a mass storage device (like an hard disk or an USB pen drive). You can save single files, banks, or all the User and Favorite Style files of the internal memory (i.e., the SSD device).



Note: While in this page, only data allowed for saving are shown. All other files are hidden.

Here are the various types of files contained in the internal memory:

The file/folder type...	...contains...	...and will create on the target device...
All	All the User data in memory	A .SET folder
Style	The USER 01-03 Styles and the FAVORITE 01-10 Styles	A STYLE folder inside a .SET folder
Sound	The USER Sounds and Drum Kits	A SOUNDS folder inside a .SET folder
Pad	The USER Pads	A PAD folder inside the .SET folder
Perform (Performances)	The Performances	A PERFORM folder inside a .SET folder
SongBook	The SongBook database	A SONGBOOK folder inside a .SET folder
PCM	All the Multisamples contained in the SSD, and the Samples contained in RAM	A PCM folder inside a .SET folder
Global	The Global. All parameters marked with ▶GBL through the various chapters are saved in the Global. Voice Processor presets are saved too.	A GLOBAL folder inside a .SET folder. A .VOC file will be created inside the GLOBAL folder, containing Voice Processor presets

Saving the full memory content

You can save the full memory content with a single operation.

1. If saving to an external device, connect the device to one of the USB Host ports.
2. The full content (“All”) of the internal memory is already shown. Select it, and touch Save to confirm the selection. The list of files in the target device is shown.

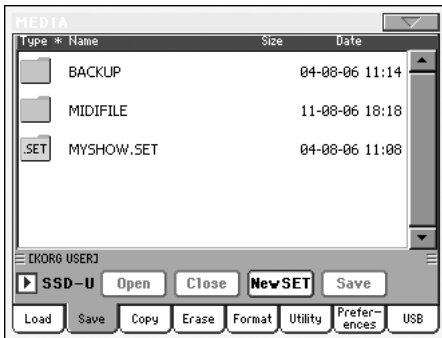

3. If needed, select a different target device, by using the Device pop-up menu. When the target device is selected, its content will appear in the display.
4. At this point, you can:
 - Touch the New SET button and create a new “.SET” folder (see “Creating a new “.SET” folder” on page 253), or
 - Select an existing “.SET” folder.
5. Touch Save to confirm. A dialog box appears, asking you to select the type of data to save:



In the above dialog box, check all data type you wish to save to a storage device.

6. Touch OK to confirm, or Cancel to abort.

Warning: After confirming, all data of the selected type in the target folder is deleted.

Saving all data of a specified type

In addition to the above, you can save all data of a specified type by selecting the corresponding folder.

1. If saving to an external device, connect the device to one of the USB Host ports.
2. The full content (“All”) of the internal memory is already shown. Select it, and touch Open to open it. A list of User data types appear (each type is a separate folder).

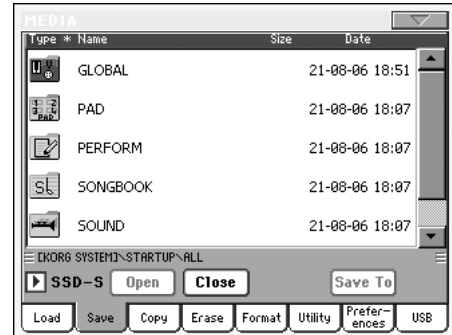

3. Select the folder containing the type of data you wish to save, and touch Save To to confirm the selection. The list of files of the target device is shown.

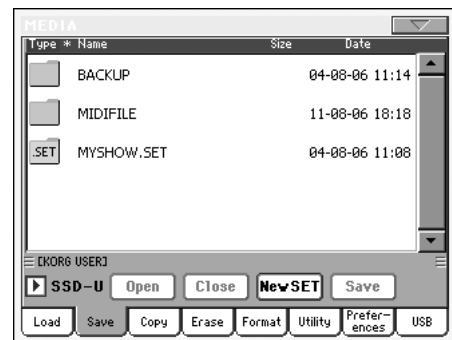

4. If needed, select a different target device, by using the Device pop-up menu. When the target device is selected, its content will appear in the display.
5. At this point, you can:
 - Touch the New SET button and create a new “.SET” folder (see “Creating a new “.SET” folder” on page 253), or
 - Select an existing “.SET” folder, and touch Save to confirm.

Warning: After confirming, all data of the selected type in the target folder is deleted.

Saving a single bank

You can save a single User bank with a single operation. A bank corresponds to a button on the control panel of the instrument (i.e. a button of the STYLE section).

1. If saving to an external device, connect the device to one of the USB Host ports.
2. The full content (“All”) of the internal memory is already shown. Select it, and touch Open to open it. A list of User data types appear (each type is a separate folder).

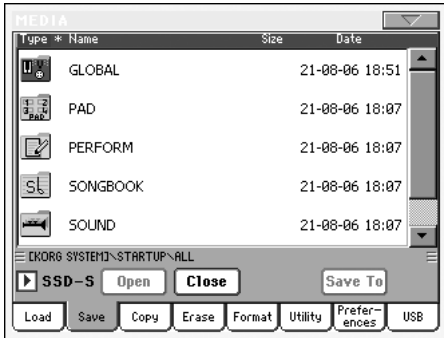

3. Select the folder containing the type of data you wish to save, and touch Open to open it. The list of contained banks is shown.

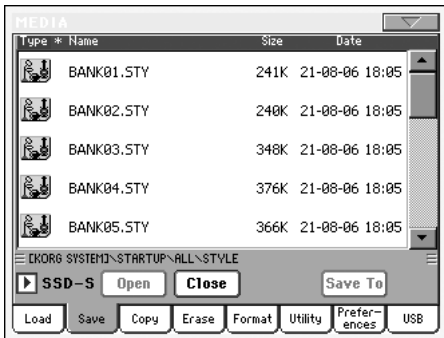

4. Select the bank to be saved, and touch Save To to confirm the selection. The list of files of the target device is shown.

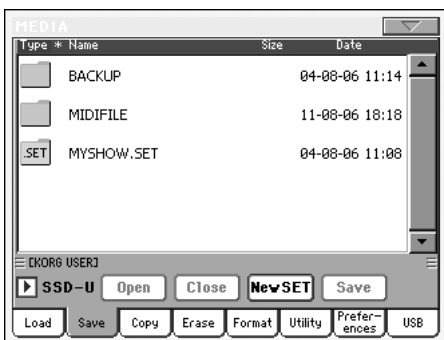

5. If needed, select a different target device, by using the Device pop-up menu. When the target device is selected, its content will appear in the display.
6. At this point, you can:
 - Touch the New SET button and create a new “.SET” folder (see “Creating a new “.SET” folder” on page 253), or
 - Select an existing “.SET” folder, and touch Save to confirm.

7. A dialog box appears, asking you to select one of the available User (or Favorite Style) locations inside the folder:



In the above dialog box, the previously selected bank of Styles will be saved to the bank User 01 (corresponding to the USER1 button) inside the selected folder. Three User banks are available.

8. Touch OK to confirm, or Cancel to abort.

Warning: After confirming, the same bank in the target folder is deleted.

Saving a single item

You can save a single User item with a single operation.

1. If saving to an external device, connect the device to one of the USB Host ports.
2. The full content (“All”) of the internal memory is already shown. Select it, and touch Open to open it. A list of User data types appear (each type is a separate folder).

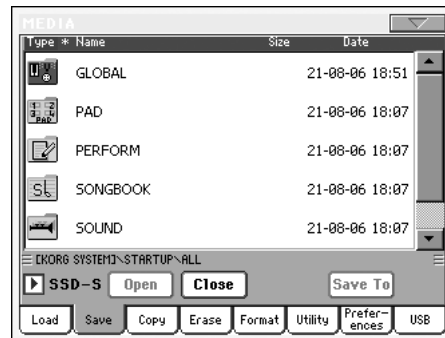

3. Select the folder containing the type of data you wish to save, and touch Open to open it. The list of contained banks is shown.

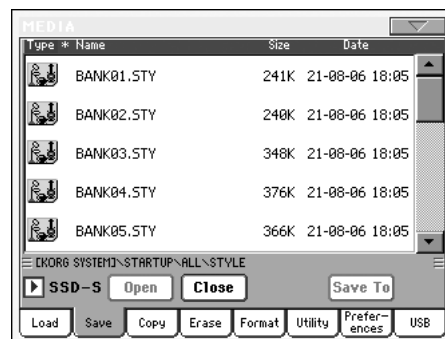

4. Select the desired bank, and touch Open to gain access to the single files.

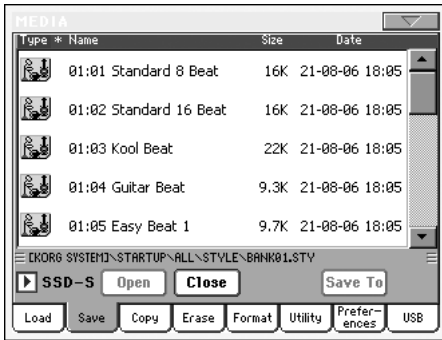

5. Once you have selected the file that you want to save, touch Save To to confirm the selection. The list of files of the target device is shown.

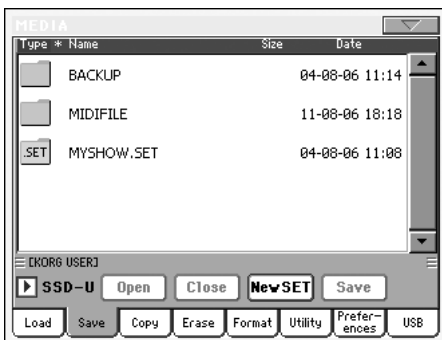

6. If needed, select a different target device, by using the Device pop-up menu. When the target device is selected, its content will appear in the display.
7. At this point, you can:
 - Touch the New SET button and create a new “.SET” folder (see “Creating a new “.SET” folder” on page 253), or
 - Select an existing “.SET” folder, and touch Save to confirm.
8. A dialog box appears, asking you to select one of the available User (or Favorite Style) locations inside the selected folder



In the above dialog box, the previously selected Style will be saved to location 01 inside the bank U01 (corresponding to the USER1 button) inside the selected folder.

9. Touch OK to confirm, or Cancel to abort.

Warning: After confirming, the same item in the target folder is deleted.

Creating a new “.SET” folder

Pa800 proprietary data must be saved in special folders with the “.SET” extension. These special folders can be saved inside ordinary folders.

When saving, you can save onto existing “.SET” folders, or you can create a new folder of this type. Here is how to do it.

1. When the directory of the target device is shown in the display, the “New SET” button appears among the buttons below the file list.



2. Touch the New SET button. A dialog box appears, asking you to enter a name for the new “.SET” folder.



3. Touch the **T** (Text Edit) button to open the Text Edit window. Enter the name, then touch OK to confirm and close the Text Edit window.
4. Touch OK to create the new folder and exit the dialog box.

Copy

In this page you can copy files and folders. Folders can be generic or “.SET” folders. In addition, you can copy the content of the generic folder you are in. You can copy inside the same device, or from a device to a different one (both devices must be connected to the Pa800 during the copy operation).

To preserve data structure integrity, during Copy operations you can't open “.SET” folders and copy only one of the files it contains. You can only open and go inside generic folders.

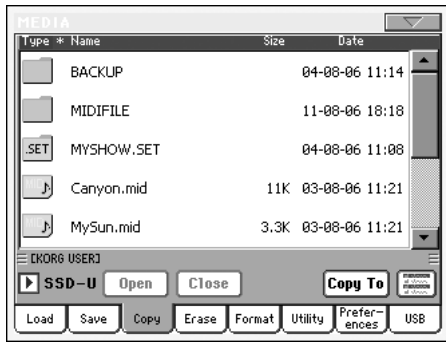

Copying a folder's content

If nothing is selected while a folder is open in the display, you can copy the folder's content, without copying the folder itself.

Note: During the Copy procedure, you can't open a “.SET” folder. You can, however, open any generic folder.

1. If copying from or to an external device, connect the device to one of the USB Host ports.
2. Select the source device, by using the Device pop-up menu.
3. If the folder you are looking for is inside another folder, select this latter and touch the Open button to open it. Touch the Close button to go back to the parent folder.
4. To copy the current folder's content, without copying the folder itself, do not select anything in the display.
5. Touch Copy To to confirm. The target device appears.

Note: If the selected device is not available, the “Device not found, or unknown format” message will appear. A different device will be automatically selected.

6. If needed, select the target device, by using the Device pop-up menu.
7. If you want to select a different folder, use the Open and Close buttons to move through the directories.
 - To copy into an existing generic folder (not a “.SET” folder), select that folder.
 - To copy into the current folder, do not select anything.
8. Once the target is selected, touch Copy.

If a file or folder with the same name of the source data already exists at the target location, the “Overwrite” dialog box will appear (see “Overwriting existing files or folders” on page 255).

During Copy, a dialog box shows the progress of the operation.



Copying a single file or folder

You can copy a single file or folder, from a generic folder to a different one. The file or folder must be located in the root (the main/highest level in the device hierarchy) or into a generic folder. You can't copy single files or folders from inside a “.SET” folder.

1. If copying from or to an external device, connect the device to one of the USB Host ports.
2. Select the source device, by using the Device pop-up menu.
3. Select the folder containing the file or folder you wish to copy. If it is contained in another folder, touch the Open button to open it. Touch Close to go back to the previous hierarchic level.
4. Touch Open to open the folder containing the file or folder to be copied.
5. Select the file or folder to be copied, then touch Copy To to confirm its selection. The target device appears.

Note: If the selected device is not available, the “Device not found, or unknown format” message will appear. A different device will be automatically selected.

6. If needed, select the target device, by using the Device pop-up menu.
7. When the target device content appears in the display, select the target folder. Touch Open to open a folder, or Close to close it.
8. Once the target is selected, touch Copy.

If a file or folder with the same name of the source data already exists at the target location, the “Overwrite” dialog box will appear (see “Overwriting existing files or folders” below).

Multiple file selection

While in the Copy and Erase pages of the Media mode, you can select several files or folders at the same time before executing the operation. Files or folders can be selected consecutively (i.e., in a row), or discontinuously (i.e., with other files or folders in the middle).

To choose either to select files in a consecutive or discontinuous way, use the Mode button on the right of the page command buttons, to choose an option for the SHIFT button:



Choose this option to select files or folders consecutively (i.e., in a row).



Choose this option to select files or folders discontinuously (i.e., with other files or folders in the middle).

To select more files or folders consecutively:

1. Touch the Mode button to choose the  option for the SHIFT button.
2. Select the first file or folder to be selected.
3. Press and keep the SHIFT button pressed.
4. Select the last file or folder to be selected.
5. Release the SHIFT button.

To select more files or folders discontinuously:

1. Touch the Mode button to choose the  option for the SHIFT button.
2. Select the first file or folder to be selected.
3. Press and keep the SHIFT button pressed.
4. Select a second file or folder to be selected.
5. While keeping the SHIFT button pressed, continue selecting the other files or folders to be selected.
6. Release the SHIFT button.

To deselect the files or folders:

- To deselect one or more file or folder, without deselecting everything, keep SHIFT pressed and touch the file or folder to be deselected.
- To deselect everything, select any other file or folder. All selected files and folders will be deselected.

Overwriting existing files or folders

When copying files, a file or folder with the same name of a source element might be found in the target device. In this case, Pa800 asks you if you want to overwrite it.

When a duplicate file or folder is met, the following dialog box appears:



Cancel	The procedure is interrupted.
No	The file or folder is not overwritten. The source file or folder is not copied. The procedure will continue with the other files and folders.
Yes	The file or folder is overwritten. The procedure will continue with the other files and folders.
Yes (to) All	The file or folder is overwritten. Any following duplicate file or folders will be overwritten as well, without this dialog box appearing again. The procedure will continue with the other files and folders.

Erase

The Erase function lets you erase files and folders from the devices.

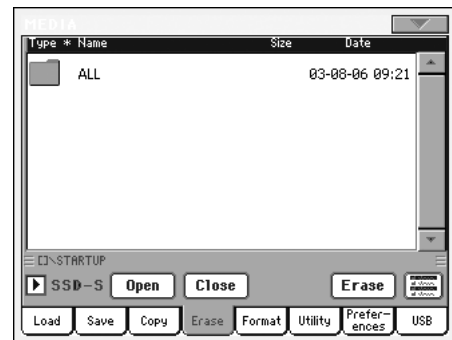

With the Erase function you will be able to select the internal system memory (SSD-S device), and erase files from there. You cannot, however, delete folders from the internal memory, since they are used by the operating system.

Erase procedure

1. If erasing from an external device, connect the device to one of the USB Host ports.
2. If needed, select a different device, by using the Device pop-up menu.
3. If the file or folder you are looking for is inside another folder, select this latter and touch the Open button to open it. Touch the Close button to go back to the parent folder.
4. Select the file or folder to erase.
5. Touch Erase to delete the selected item.

During erase, a dialog box shows the progress of the operation.

**Multiple file selection**

See “Multiple file selection” on page 254 for information on how to select more files or folders to be erased at the same time.

Format

The Format function lets you initialize a device. Pa800 uses a MS-DOS-compliant device format:

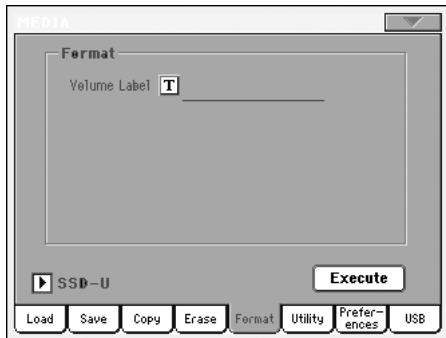

Warning: When formatting a device, all data it contains is lost forever!

Volume Label

Use this parameter to assign a name to the device to be formatted.

Touch the **T** (Text Edit) button to open the Text Edit window. Enter the name, then touch OK to confirm and close the Text Edit window.

Note: When changing the name to a device containing midifiles or MP3 files used by the SongBook, the links are broken. We suggest to give the device the same name it had before formatting.

Execute button

Touch this button, after setting all the options in this page, to execute the Format command.

Format procedure

Here is how to format a device.

1. If formatting an external device, connect the device to one of the USB Host ports.
2. Touch the Execute button in the display to confirm formatting.
3. The “If you confirm, all data in the media will be lost. Are you sure?” message appears in the display. Touch Yes to confirm, or No to cancel.

Note: When formatting the hard disk or an external USB device, an additional warning appears, to avoid accidental data loss.

Utility

This page includes a set of backup utilities.

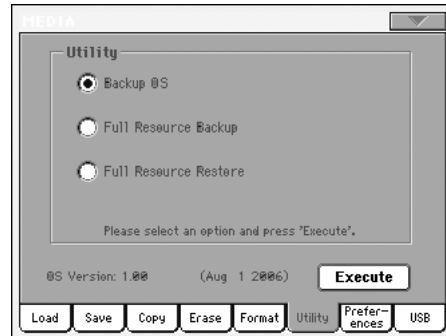

Backup OS

This command allows you to make a backup of the Operating System on a target device. A “.PKG” file will be created.

Note: Should you not do a backup and your internal data becomes damaged, you can download the most up-to-date data from www.korgpa.com. A copy of the original OS is also contained in the Accessory CD that comes with your Pa800.

1. In case you are making the backup on an external USB device, connect the device to one of the USB Host ports.

Be sure there is enough free space in your target device, or the Backup procedure will not be completed. The OS backup file requires about 6 MB.

2. Select the Backup OS command, then touch the Execute button in the display. The target device appears.

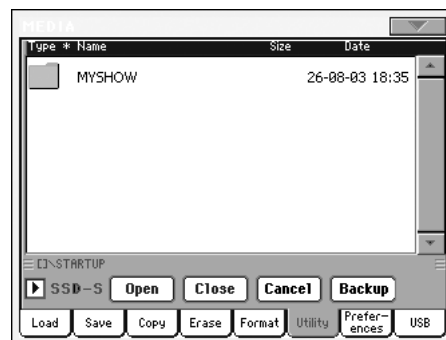

3. If needed, select a different device, by using the Device pop-up menu.
4. If you wish to save data inside another folder, select this latter and touch the Open button to open it. Touch the Close button to go back to the parent folder.
5. Select the folder where to save data, and touch Backup to save it. If nothing is selected, data will be saved to the current directory.

After touching Backup, a dialog box will appear, asking you to select a name for the backup file, and whether compression must be turned on or off during the backup.



Touch the **T** (Text Edit) button to open the Text Edit window. Enter the name, and confirm by touching OK.

We suggest you check Compression, to save space on the backup device. However, with compression turned on, the operation will last longer.

6. Touch OK to start the backup.
7. When finished, save the storage device in a safe place.

Full Backup Resources

This command allows you to make a backup of the Factory and User Musical Resources (excluding the Operating System) on a target device. A “.BKP” file will be created.

Note: Should you not do a backup and your internal data becomes damaged, you can download the original data from www.korgpa.com. A copy of the original data is also contained in the included Accessory CD.

Choose this command, and follow the procedure seen to backup the Operating System above. The required space on the target device depends on the amount of data to be backed-up.

Full Restore Resources

This command restores the backup of the internal Factory and User data, created with the “Full Backup Resources” command.

Warning: Don't play the keyboard while restoring data, and stay in the Media mode. Wait until the “Wait” message disappears.

1. In case you are restoring from an external USB device, connect the device to one of the USB Host ports.
2. Select the Full Restore Resources command, then touch Execute. The source device appears.
3. If needed, select a different device, by using the Device pop-up menu.
4. Browse through the files to find the backup file.
5. When the backup file (“.BKP” file) is in the display, select it and touch the Restore command.
6. When done, the instrument automatically restarts.

OS Version Number

This line shows the installed Operating System version. From time to time, check our web site (www.korgpa.com), to see if a newer, free version has been released.

Preferences

This page includes various protect options, plus the PCM Auto-load option.

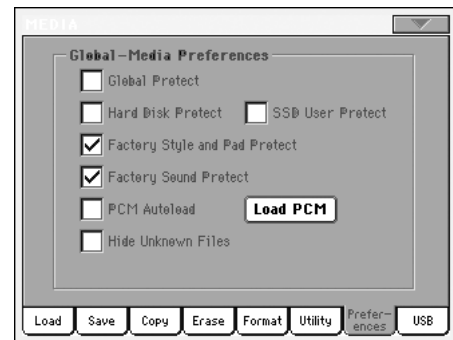

Global Protect ▶GBLMed

When loading a “.SET” file (see “Loading all the User data” on page 247), this parameter (if On) prevents Global parameters from being reprogrammed when loading all data. All Global parameters are therefore left unchanged.

When loading a single “.GLB” file, this parameter is ignored, and the Global is overwritten by the loaded data.

Note: This parameter is saved to memory, but not to a storage device.

Hard Disk Protect ▶GBLMed

When on, this parameter protects the hard disk from writing.

Note: This parameter is saved to memory, but not to a storage device.

SSD User Protect ▶GBLMed

When on, this parameter protects the User area on the SSD from writing.

Note: This parameter is saved to memory, but not to a storage device.

Factory Style and Pad Protect

When On, this parameter protects the Factory Styles (from the “8/16 BEAT” to the “CONTEMP.” bank) and Factory Pads (named “Hit” and “Sequence” in the Pad Select window) from being overwritten when loading data from a device. Furthermore, you can't access these banks when saving data.

When Off, you can load or save User Styles or Pads even into the Factory Style banks (from “8/16 BEAT” to “CONTEMP.”) and Factory Pad banks (named “Hit” and “Sequence” in the Pad Select window). This way, you customize personalize your Factory Style and Pad banks.

Please note that the Save All procedure always saves only the USER and FAVORITE Style banks.

Note: This parameter is automatically set to On when turning the instrument off.

Note: Should you accidentally delete some Factory Data, reload the Backup data, find the original Musical Resources in the supplied CD, or download the data from www.korgpa.com.

Factory Sound Protect

When On, this parameter prevents writing edited Sounds from the Edit Sound mode. When Off, you can freely save edited Sounds either in the Factory or User Sound area.

Note: This parameter is automatically set to On when turning the instrument off.

Note: If you accidentally delete some Factory Data, reload the Backup data, find the original Musical Resources in the supplied CD, or download the data from www.korgpa.com.

PCM Autoload

► GBL Med

When you import a Sound based on PCM Samples, or create a new Sound with Samples recorded in the Sampling mode, the Samples are stored in the SSD-S(ystem) internal memory.

When this parameter is set to On, these User PCM Samples are automatically loaded when turning the instrument on, so that you don't have to worry and deliberately load them.

However, since loading may take some time, you can choose whether to automatically load these Samples or not, in case you don't need these Sounds.

If Samples have not been automatically loaded when turning the instrument on, you can touch the Load PCM button in this page to load them.

- | | |
|-----|---|
| On | When turning the instrument on, User Samples used by some Sounds are automatically loaded from the SSD-S memory to the RAM memory. |
| Off | When turning the instrument on, external Samples used by some Sounds are not automatically loaded. Therefore, these Sounds will not sound, until you use the Load PCM button to load them to RAM. |

Load PCM button

Touch this button to load to RAM all PCM Samples used by some User Sounds loaded from an external device, or created in Sampling mode.

Not available if no User PCM Samples are used by any Sound, PCM Autoload is selected, or if the PCM Samples have already been loaded (either by pushing this button or by entering the Sampling mode).

Hide Unknown Files

When this option is checked, non-proprietary files are hidden when using Media operations, therefore making browsing directories easier.

USB

Use this page to enable or disable the USB Device port for file transfer.

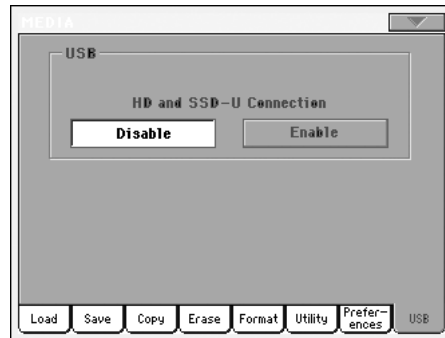

The USB Device port allows you to access the internal SSD-U and the (optional) internal hard disk from a personal computer (Windows or Macintosh), by just connecting the Pa800 to the computer's USB interface. This way, you can exchange files between the Pa800 and a personal computer (for example, for making a quick backup of Pa800 data on your computer, or moving midifiles to your Pa800).

Note: Windows 2000 and XP, as well as Mac OSX, can be directly connected to the Pa800. To connect a Windows 98 computer you need a dedicated driver, available from www.korgpa.com.





Note: While USB file transfer is enabled, you cannot access other functions on the Pa800.

HD and SSD-U Connection

Normally, the USB Device port is not enabled for file transfer on the Pa800 (it is always on, however, for MIDI connection). Touch the Enable button to turn it on, or the Disable button (with all the caveats) to turn it off.

- | | |
|--------|--|
| Enable | After connecting Pa800 to a personal computer by using a standard USB cable, touch this button to enable file transfer. In this case, Pa800 is the B USB device (called Device or Slave), while the personal computer is the A USB device (called Host or Master). |
|--------|--|

The MEDIA LED will start blinking, while the personal computer reads the internal SSD-U memory and the internal hard disk of the Pa800. When finished (this may take some minutes, depending on the hard disk size), the icons of the SSD-U and the hard disk will appear among the other storage devices connected to the computer:

	SSD-U	HD
Windows	 KORG USER (G:)	 KORG HD (H:)
Macintosh	 KORG USER	 KORG HD

Caveat: Do not modify “.SET” folders, or you will no longer be able to use them on the Pa800. Only use the USB connection for backup purpose, or to modify ordinary folders.

Note: After starting the USB connection, accessing Pa800 data from the computer may take some time, depending on the size of the hard disk and the data contained in the SSD-U or hard disk.

Disable Touch this button to disconnect the USB file transfer. Be careful to touch it only when you are absolutely sure data transfer has been completed.

Note: USB connection is also automatically disconnected when disconnecting the USB communication on the personal computer side.

To disconnect USB communication on a PC, you usually select the dedicated command by clicking on the USB device icon with the right mouse button. On the Mac, select the USB device icon, then select the Eject command or drag it to the eject icon in the Dock.

Hint: We suggest to disconnect USB connection from the personal computer, instead of touching this button on the Pa800.

Caveat: Do not disconnect USB communication before the personal computer has really finished transferring files. Sometimes, the on-screen indicator tells the procedure has been completed, BEFORE it is actually finished.

Disconnecting USB communication (or disconnecting the USB cable) before data transfer has been completed may cause loss of data.

Page menu

Touch the page menu icon to open the menu. Touch a command to select it. Touch anywhere in the display to close the menu without selecting a command.



Create New Folder

This command lets you create a new generic folder in the root of any device, or inside any other generic folder. You can't create a “.SET” folder with this command, since this type of folder is reserved to the Save operations (and can be created with the New SET button in any Save page).



By touching the **T** (Text Edit) button you can open the Text Edit window. Enter the name, then touch OK to confirm and close the Text Edit window.

Rename

Available only when an item is selected in a file list.

Use this function to change the name of an existing generic file or folder. To preserve consistency through the data structure, you cannot rename single files inside a “.SET” folder. Also, you cannot change the 3-character extension of files and “.SET” folders, since they are used to identify the type of file or folder.



Touch the **T** (Text Edit) button to open the Text Edit window. Enter the new name, then touch OK to confirm and close the Text Edit window.

Object(s) info

Select this command to see the size of any selected file or folder. Also, the number of files and directories (folders) it contains are shown.



Note: The *single file* size is always shown to the right of the file name in any file list:

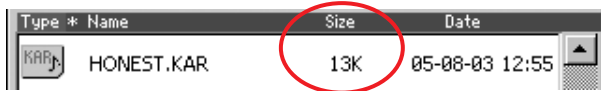

Device Info

Select this command to see various info on the selected device. To select a different device, use the Device pop-up menu on the lower left corner of most Media pages.



By touching the **T** (Text Edit) button you can open the Text Edit window. Enter the name (label) of the selected device, then touch OK to confirm and close the Text Edit window.

Warning: If you change the name of a device connected to the USB-F or USB-R port, and it contains midifiles used by some SongBook entries, these entries will be damaged (due to broken links to the resources contained in the device).

This does not affect resources contained in the SSD-U memory, or the (optional) internal hard disk.

Protect

Select this command to protect the selected file or folder from writing/erasing. The lock icon will appear next to the file or folder name.



Unprotect

Select this command to unprotect the selected file or folder – if protected.

Ordered by Name

Select this display option to see the list of files and folders in rough alphabetical order, with different file types mixed in the list. The Name label, above the file list, is shown in red.

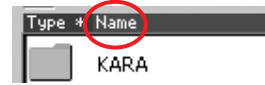

This command is the same as directly touching the Name label above the file list.

Ordered by Type

Select this display option to see the list of files and folders ordered by type. Inside any type group, files are still in alphabetical order. The Type label, above the file list, is shown in red.

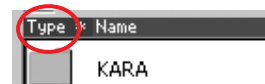

This command is the same as directly touching the Type label above the file list.

Order by Size

Select this display option to see the list of files and folders ordered by size. The Size label, above the file list, is shown in red.



This command is the same as directly touching the Size label above the file list.

Order by Date

Select this display option to see the list of files and folders ordered by date. The Date label, above the file list, is shown in red.

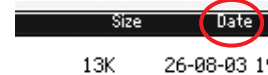

This command is the same as directly touching the Date label above the file list.

Ascending/Descending

Use this command to switch between the ascending (Numbers, A...Z) and descending (Z...A, Numbers) order.

This is the same as directly touching the red label above the file list.

Write Global-Media Preference

Select this command to open the Write Global-Media Preferences dialog box, and save settings made in the Preferences page (see “Preferences” on page 257).



Parameters saved in the Media Preferences area of the Global are marked with the **GBLMed** symbol through the user’s manual.

Care of mass storage devices

The Pa800 can save most of the data contained in memory on the internal hard disk (if fitted), or to external devices (like pen drives) connected to one of the USB Host ports. Here are some precautions when handling these devices.

Hard disk write protection

You can protect your hard disk from writing, by using the software protection found in Media mode (see “Hard Disk Protect” on page 257).

SSD-U write protection

You can protect the SSD-U memory from writing, by using the software protection found in Media mode (see “SSD User Protect” on page 257).

Precautions

- Do not remove a device or move the instrument while the device is operating.
- Make a backup copy of the data contained in a device, in order not to lose data forever in case of damage. You can backup your data to a personal computer, and from there to a CD or DVD. The internal SSD-U and (optional) hard disk can be backed up on a personal computer’s hard disk, by using the USB Device connection.
- Do not leave a USB device connected to the USB ports while carrying the instrument, or it may be damaged.
- Keep the memory devices or the instrument away from sources of magnetic fields, for example televisions, refrigerators, computers, monitors, speakers and transformers. Magnetic fields can alter the contents of the devices.
- Do not keep memory devices in very hot or wet places, do not expose them to direct sunlight and do not store them without use in dusty or dirty places.
- Do not place heavy objects on top of the devices.

Possible problems

- Magnetic fields, dirt, humidity and usage can damage data in a device. You can try to recover the data with disk repair utilities for personal computers. It is, however, advisable to always make a backup copy of your data.

Merging PCM samples from various sources

When you load a .SET folder, all PCM samples in memory are deleted. So, there is no way to merge different samples by loading complete .SET folders.

To merge samples from several sources, you must load single Sounds or Drum Kits based on external PCM samples.

Delete all samples and multisamples

1. If you want to delete all samples and multisamples already in memory, press the SOUND button to access the Sound mode, then press the RECORD button to access the Sampling mode.
2. While in Sampling mode, choose the “Delete Sample” command from the page menu. Check the “All Samples, Multi-Sample, DrumSamples” option, and touch OK to delete all samples and multisamples.

Warning: Before deleting, be sure to have a copy of any important data you don’t want to lose.

3. Choose the “Exit from Record” command from the page menu, to exit from the Sampling mode.

Create a new .SET of samples

1. Press the MEDIA button to access the Media mode. Go to the Load page.
2. Open a first .SET folder containing some of the PCM samples to merge. Open the SOUND folder, then one of the USER banks, and choose the first of the Sounds or Drum Kits based on samples you would like to load. Touch Load, and choose a target User location in memory.

The Sound or Drum Kit is loaded, together with the PCM samples it is based on.

3. Do the same with any subsequent Sound or Drum Kit whose samples you would like to load.
4. When finished loading, save a new .SET folder, being sure the PCM option is checked in the Save All dialog (see “Saving the full memory content” on page 251, or “Saving all data of a specified type” on page 251).

Bonus software

With Pa800, three “.SET” folders are supplied with the Accessory CD, with the whole content of Korg’s “Real Drums” and “Turkish/Arabic World” collections, originally available as separate cards for the Pa80/Pa60 series.

These are high quality sound sets, based on additional PCM Samples. Go to www.korgpa.com for more information.

To load these sounds, first copy either the REALDRUM.SET or TA_WORLD.SET folder to the SSD-U or internal hard disk (if installed) using the USB connection, then load them to memory. By loading the BONUS_SW.SET folder, you can load both collections at once.

Warning: *When loading the above folders, all User data in memory is deleted. Save important data, before loading the bonus software.*

Note: *After turning the instrument off, all samples are deleted from the RAM memory. You can either have them automatically reloaded when turning the instrument on again (see “PCM Auto-load” on page 258), or manually load them (see “Load PCM button” on page 258).*

MIDI

What is MIDI?

Here is a brief overview of MIDI, as related to the Pa800. If interested, you may find more information on the general use of MIDI in the various specialized magazines and dedicated books.

In general

MIDI stands for Musical Instruments Digital Interface. This interface lets you connect two musical instruments, or a computer and various musical instruments.

From a software point of view, MIDI is a protocol that describes messages for playing notes and controlling them. It is sort of a grammar to let different instruments and computers speak the same language, and let the one tell the other what to do.

From a physical point of view, MIDI messages can travel across two different types of connectors on the Pa800:

- The MIDI interface, that is composed of three different connectors. The MIDI IN receives data from another device; the MIDI OUT sends data to another device; the MIDI THRU sends to another device exactly what was received on the MIDI IN (this is useful to daisy-chain more instruments).
- The USB Device port, that replaces both the MIDI IN and OUT connectors with a single port and cable.

Both these devices are active at the same time. So, you can connect the Pa800 to a computer via the USB port, and connect another instrument's MIDI IN port to the MIDI THRU port of the Pa800.

Channels and messages

Basically, a MIDI or USB cable transmits 16 channels of data. Think to each MIDI channel as a TV channel: the receiver must be set on the same channel of the transmitter. The same happens with MIDI messages: when you send a Note On message on channel 1, it will be received on channel 1 only. This allows for multitimbricity: you can have more than one sound playing on the same MIDI instrument.

There are various messages, but here are the most commonly used:

Note On – This message instructs an instrument to play a note on a specific channel. Notes have both a name (C4 standing for the center C) and a number (60 being the equivalent for C4). A Note Off message is often used to say the note has been released. In some case, a Note On with value “0” is used instead.

Together with the Note On message, a Velocity value is always sent. This value tells the instrument how loud the note must play.

After Touch – This message is generated by pressing on the keyboard, after the note has been struck. It usually activates vibrato, or other sound parameters.

Pitch Bend (PB) – You can generate this message acting on the joystick (X direction). The pitch is translated up or down.

Program Change (PC) – When you select a Sound, a Program Change message is generated on the channel. Use this message, together with Control Change 00 and 32, to remotely select Pa800 data from a sequencer or a master keyboard.

Control Change (CC) – This is a wide array of messages, controlling most of the instrument parameters. Some examples:

- CC00, or Bank Select MSB, and CC32, or Bank Select LSB. This message pair is used to select a Sound Bank. Together with the Program Change message, they are used to select a Sound.
- CC01, or Modulation. This is the equivalent of pressing up the joystick. A vibrato effect is usually triggered on.
- CC07, or Master Volume. Use this controller to set the channel's volume.
- CC10, or Pan. This one sets the channel's position on the stereo front.
- CC11, or Expression. Use this controller to set the relative volume of tracks, with the maximum value matching the current setting of the CC07 control.
- CC64, or Damper Pedal. Use this controller to simulate the Damper pedal.

Tempo

Tempo is a global MIDI message, that is not tied to a particular channel. Each Song includes Tempo data.

Lyrics

Lyrics are non-standard MIDI events, made to display text together with the music. Pa800 can read many of the available Lyrics format on the market.

What is MIDI Over USB?

You can let the Pa800 communicate MIDI data with a computer using the USB Device port instead of the MIDI ports. This way, you can connect your Pa800 to a personal computer without the need of a dedicated MIDI interface.

Most Pa800 MIDI features can be used on a Windows XP or Mac OS X computer with no need of special software. However, for full and easy use of all MIDI features, we suggest you to install the “KORG USB MIDI Driver”, a special software that you can find in the CD that comes with your Pa800. Relevant instructions come with the software itself. See “Installing the Korg USB MIDI Driver” on page 329.

Standard MIDI Files

Midifiles, or Standard MIDI Files (a.k.a. SMF), are a practical way of exchanging songs between different instruments and computers. Pa800 uses the SMF format as its default song format, so reading a song from a computer, or saving a song that a computer software can read, is not a problem at all.

The Pa800 sequencers are compatible with the SMF in format 0 (all data in one track; it is the most common format) and 1 (multitrack). It can read the SMF in Song Play mode and modify/save them in Sequencer mode. It can save a song in SMF 0 format in the Sequencer mode.

When in Song Play mode, the Pa800 can also display SMF lyrics in Solton, M-Live (Midisoft), Tune1000, Edirol, GMX, HitBit, and XF formats, and the chord abbreviations of SMF in Solton, M-live (Midisoft), GMX, and XF format.

Note: The above trademarks are the property of their respective holders. No endorsement is intended by inclusion in this list.

Standard MIDI Files usually have the “.MID” or “.KAR” filename extension.

The General MIDI standard

Some years ago, the musical instruments world felt a need for some further standardization. Then, the General MIDI Standard (GM) was born. This extension of the basic MIDI sets new rules for compatibility between instruments:

- A minimum of 16 MIDI channels was required.
- A basic set of 128 Sounds, correctly ordered, was mandatory.
- The Drum Kit had a standard order.
- Channel 10 had to be devoted to the Drum Kit.

A most recent extension is the GM2, that further expands the Sounds database. The Pa800 is soundwise-compatible with the GM2 standard.

The Global channel

Any channels with the Global option assigned (see “MIDI: MIDI In Channels” on page 225) can simulate the Pa800 integrated keyboard. When the Pa800 is connected to a master keyboard, transmission should take place over the Global channel of the Pa800.

The MIDI messages received over a Global channel and not over a standard channel are affected by the buttons of the KEYBOARD MODE section, as well from the split point. Therefore, if the SPLIT button LED is lit up, the notes that arrive to the Pa800 over this channel will be divided by the split point into the Upper (above the split point) and Lower (below the split point) parts.

The notes that arrive to a Global channel are used for the chord recognition of the automatic accompaniment. If the KEY-

BOARD MODE is SPLIT, only the notes below the split point will be used. These notes will be combined with the ones of the special Chord 1 and Chord 2 channels.

The Chord 1 and Chord 2 channels

You can set two special Chord channels (see page 225) to send to the Pa800 notes for the chord recognition. The notes will be combined with the notes that go through the channel set as Global (Global notes are recognized only under the split point, if the SPLIT LED is lit up).

The Chord channels are not affected by the split point and the KEYBOARD MODE section of the control panel. All the notes – both above and below the split point – will be sent to the chord recognition.

The buttons of the CHORD SCANNING section have a particular effect on the Chord channels:

- if you have selected LOWER, the chord recognition mode will be set by the “Chord Recognition Mode” parameter in the Style Play mode (see page 106);
- if you have selected UPPER or FULL, the chord recognition mode will always be Fingered 3 (you need to play at least three notes in order for the chord to be detected). If Expert was selected before choosing UPPER or FULL, it will remain selected.

These two channels are especially useful for accordion players to assign a different Chord channel to the chords and the bass played with the left hand. In this way, chords and bass will participate to the creation of chords for the chord recognition of the automatic accompaniment.

The Control channel

You can set a MIDI IN channel as the Control channel (see page 225), to select Styles and Performance from an external device. See the Appendix for a list of messages corresponding to Pa800 internal data.

MIDI Setup

You can play Pa800 with an external controller, and use it simply as a powerful sound generator. To help you configure the MIDI channels, we have provided a set of MIDI Setups (see “Midi Setup” on page 107 for the Style Play mode, “Midi Setup” on page 176 for the Song Play mode, and “MIDI Setup” on page 223 for the Global mode).

We recommend you to consider each MIDI Setup as a starting point you can freely tweak. Once you have selected the most appropriate MIDI Setup for the connection to be made, you can modify the parameters as necessary and save them in a MIDI Setup (see “Write Global - Midi Setup dialog box” on page 231).

Connecting Pa800 to a Master keyboard

You can control the Pa800 with a master keyboard or any other MIDI keyboard. You only need to connect the MIDI OUT connector of the master keyboard to the MIDI IN connector of the Pa800. The master keyboard will become the integrated keyboard of the Pa800 if it transmits over the same channel programmed as Global in the Pa800.

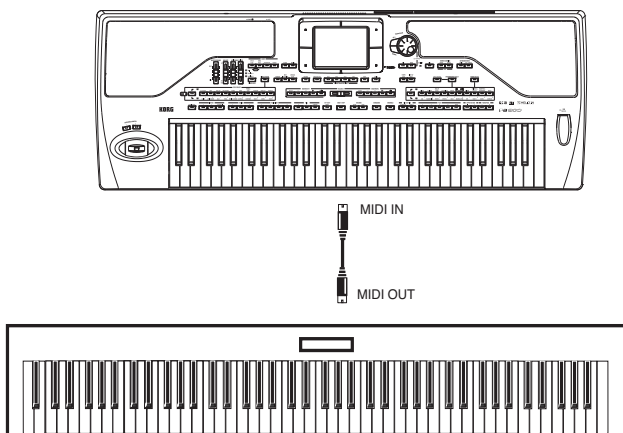

If the master keyboard transmits over the Global channel of the Pa800, the split point and the status of the KEYBOARD MODE section in the control panel will affect the notes received from the master keyboard.

Connections and settings

To connect the master keyboard to the Pa800 follow this procedure:

1. Connect the MIDI OUT connector of the master keyboard to the MIDI IN connector of the Pa800.
2. Program the master keyboard to transmit over the Global channel of the Pa800 (see “MIDI: MIDI In Channels” on page 225).

For information on the master keyboard programming, see the master keyboard own user’s manual.

3. Select the MIDI Setup parameter. You can do this by going to the “MIDI: MIDI Setup / General Controls” page of the Global mode, or in the dedicated page of the Style Play, Song Play or Sequencer mode (see “Midi Setup” on page 107, “Midi Setup” on page 176, and “Midi Setup” on page 211).

Note: A different MIDI Setup may be selected for the Style Play, Song Play and Sequencer modes. The “1-Default” MIDI Setup is automatically selected when entering the Sound Edit mode. MIDI settings are therefore modified when switching to a different operating mode. The current MIDI Setup is also shown in the Global mode.

4. Select the “Master Keyboard” MIDI Setup.

Note: Settings may change when new Global data is loaded from disk. To protect settings from loading, use the Global Protect function (see “Global Protect” on page 257).

5. To save the assigned MIDI Setup for the selected operative mode into the Global, select the “Write Global-Style Setup”, the “Write Global-Song Play Setup”, the “Write Global-Seq. Setup”, or the “Write Global-Global Setup” command from the page menu.
6. If needed, press one of the buttons in the MODE section to go to the desired operative mode.

Connecting the Pa800 to a MIDI accordion

There are various types of MIDI accordions, each one requiring different MIDI settings. Pa800 is provided with a series of “Accordion” MIDI Setups, each one suitable for a different MIDI accordion (see page 223).

Connection and settings

To connect the accordion to the Pa800 follow this procedure:

1. Connect the MIDI OUT connector of the accordion to the MIDI IN connector of the Pa800.
2. Select the MIDI Setup parameter. You can do this by going to the “MIDI: MIDI Setup / General Controls” page of the Global mode, or in the dedicated page of the Style Play, Song Play or Sequencer mode (see “Midi Setup” on page 107 and “Midi Setup” on page 176).

Note: A different MIDI Setup may be selected for the Style Play, Song Play and Sequencer modes. The “1-Default” MIDI Setup is automatically selected when entering the Sound Edit mode. MIDI settings are therefore modified when switching to a different operating mode. The current MIDI Setup is also shown in the Global mode.

3. Select one of the available “Accordion” MIDI Setups.
4. To save the assigned MIDI Setup for the selected operative mode into the Global, select the “Write Global-Style Setup”, the “Write Global-Song Play Setup”, the “Write Global-Seq. Setup”, or the “Write Global-Global Setup” command from the page menu.
5. If needed, press one of the buttons in the MODE section to go to the desired operative mode.

Connecting the Pa800 to an external sequencer

You can program a new song on an external sequencer, using Pa800 as a multi-timbral expander.

Connections and settings

In order to connect the Pa800 to a computer, you need to have a computer with the MIDI interface.

1. In case you will connect the computer and the Pa800 via the USB port, install the Korg USB MIDI Driver, as explained in “Installing the Korg USB MIDI Driver” on page 329.
2. Connect the Pa800 and the computer either via the USB Device port, or via the MIDI ports and a MIDI interface, as shown in the following diagram.

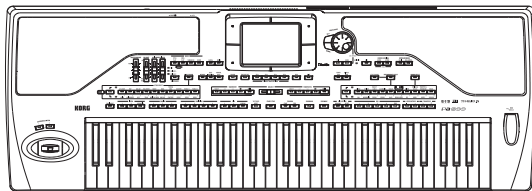
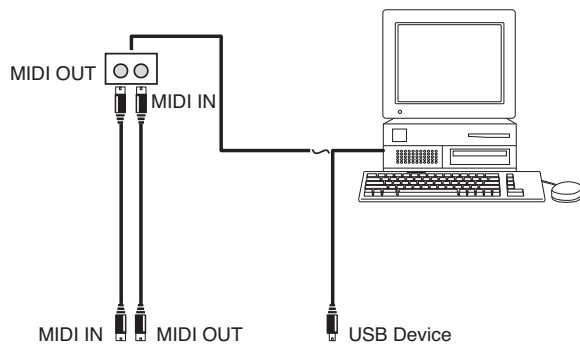

3. Activate the “MIDI Thru” function on the external sequencer.
4. Press GLOBAL, and go to the “MIDI: MIDI Setup / General Controls” page. uncheck the “Local Control On” parameter (see page 224). This is called the “Local Off status”.
5. Press SEQUENCER to go to the Sequencer mode. Go to the “Preferences: Sequencer Setup” page (see page 211). Select the “Extern.Seq.” MIDI Setup.

Note: Settings may change when new Global data is loaded from disk. To protect settings from loading, use the Global Protect function (see “Global Protect” on page 257).

6. Select the “Write Global-Seq. Setup” command from the page menu to save the assigned MIDI Setup to the Global.
7. Play the keyboard. Notes played on the keyboard go from the MIDI OUT of the Pa800 to the MIDI IN of the computer/MIDI interface (or go from the USB port of the Pa800, to the USB port of the computer).

Notes generated by the computer (i.e. a song played by its sequencer) are sent through the MIDI OUT of the MIDI interface to the MIDI IN connector of the Pa800 (or go from the USB port of the computer, to the USB port of the Pa800).

The Local Off

When the Pa800 is connected to an external sequencer, we recommend you to set the Pa800 in Local Off mode (see “Local Control On” on page 224) to avoid that the notes are simultaneously played by the keyboard and by the MIDI events sent by the external sequencer.

When the Pa800 is in Local Off, the Pa800 keyboard transmits data to the external sequencer, but not to the internal sound generation. The sequencer will receive the notes played on the Pa800 keyboard and send them to the selected track of the song. The track will transmit the data to the internal sound generation of the Pa800.

Note: In order to send data to the Pa800 sound generation, the “MIDI Thru” function must be activated in the external sequencer (normally active; the name may be different according to the type of sequencer). For more information refer to the instructions manual of the sequencer.

The Sounds

The song that is played back by the computer sequencer can select Pa800 Sounds through the MIDI messages Bank Select MSB, Bank Select LSB (bank selection, two messages), and Program Change (Sound selection). For a list of Sounds and MIDI values, see “Sounds (Program Change order)” on page 284.

A suggestion for those who program songs on computer: Even though it is not essential, you usually set the bass on channel 2, melody on channel 4, drum kit on channel 10, control of the Pa800 voice harmonizer on channel 5.

Playing another instrument with the Pa800

You can use the Pa800 as the master controller for your MIDI setup.

1. Connect the Pa800 MIDI OUT connector to the other instrument's MIDI IN.
2. Set the other instrument to the same channels you want to play from Pa800. For example, if you wish to play the Upper 1 and Upper 2 tracks with sounds of the other instrument, enable the other instrument to receive on the same channels Pa800 is transmitting from tracks Upper 1 and Upper 2 (by default, channels 1 and 2).
3. Set the master volume of the other instrument with its own volume controls.
4. Mute/unmute any track right from the Pa800. Adjust each track's volume by using Pa800 sliders.
5. Play the keyboard of the Pa800.

The Keyboard

Pa800's keyboard can drive up to four tracks via the MIDI OUT (Upper 1-3 and Lower). MIDI output channels are set in Global mode (see "MIDI: MIDI Out Channels" on page 225).

As a default situation ("1-Default" MIDI Setup), each of Pa800 Keyboard tracks transmit on the following channels:

Track	Out Channel
Upper1	1
Upper2	2
Upper3	3
Lower	4

When a track is muted, it cannot transmit any MIDI data to an external expander or sequencer connected Pa800's MIDI OUT.

To hear only the expander's sounds, you can lower the MASTER VOLUME control on the Pa800, or set the Keyboard tracks to the External status (see "Track Controls: Mode" on page 205).

The Sequencer

Any Sequencer's track can drive a channel on an external instrument. To set each track's MIDI output channel, see "MIDI: MIDI Out Channels" on page 225.

To hear only the expander's sounds, you can lower the MASTER VOLUME control on the Pa800, or set the Song tracks to the External status (see "Track Controls: Mode" on page 205).

Select the "Sequencer 1" or "Sequencer 2" MIDI Setup (depending on the Sequencer you are using on the Pa800) to set the channels as follows.

Track	Out Channel
Song 1...16	1...16

The Arranger

One of the most interesting aspect of MIDI, is that you can use your Pa800 to play an external instrument with its onboard arranger. Yes, it's hard to beat the audio quality of Pa800, but you could wish to use that old faithful synth you are still accustomed to...

To assign some of Pa800 Style tracks to an external instrument, set them to the External status (see "Track Controls: Mode" on page 205).

Select the "Default" MIDI Setup to set the channels as follows (this is the default status of Pa800).

Track	Out Channel
Bass	9
Drums	10
Percussion	11
Acc1...5	12...16

Appendix

Factory data

Styles

Note: You can remotely select Styles on the Pa800, by sending it Bank Select MSB (CC#0), Bank Select LSB (CC#32) and Program Change messages on the Control channel (see "MIDI: MIDI In Channels" on page 225).

#	CC0	CC32	PC	Bank: 8/16 Beat	CC0	CC32	PC	Bank: Pop	CC0	CC32	PC	Bank: Ballad
1	0	0	0	Standard 8 Beat	0	1	0	Guitar Pop	0	2	0	Modern Ballad
2			1	Standard 16 Beat			1	Easy Pop 1			1	Moonlight Ballad
3			2	Kool Beat			2	Easy Pop 2			2	Soft Ballad
4			3	Guitar Beat			3	Pop Groove			3	Funky Ballad
5			4	Easy Beat 1			4	British Pop			4	Guitar Ballad
6			5	Easy Beat 2			5	Pop Jazz			5	Easy Ballad
7			6	Real 8 Beat			6	Slow Latin Pop			6	Organ Ballad
8			7	Real 16 Beat			7	Pop Ballad			7	Blue Ballad
9			8	Soft 8 Beat			8	Pop 6/8			8	Folk Ballad 1
10			9	Soft 16 Beat			9	Slow Pop 6/8			9	Folk Ballad 2
11			10	Classic Beat			10	Pop 12/8			10	Groove Ballad
12			11	Pop 16 Beat			11	Pop Shuffle 1			11	Blues Ballad
13			12	Analog Beat 1			12	Pop Shuffle 2			12	Analog Ballad 1
14			13	Analog Beat 2			13	Pop Shuffle 3			13	Analog Ballad 2
15			14	8 Beat Analog 1			14	Pop Chart 1			14	Rock Ballad 1
16			15	8 Beat Analog 2			15	Pop Chart 2			15	Rock Ballad 2
17			16	Modern Beat			16	Pop Funk 1			16	Slow 6/8
18			17	Half Beat			17	Pop Funk 2			17	Ballad 6/8 1
19			18				18	Fast Pop			18	Ballad 6/8 2
20			19				19				19	Medium 6/4
21			20				20				20	Slow Waltz
22			21				21				21	Pop Hit Ballad
23			22				22				22	Color Ballad
24			23				23				23	Oriental Ballad
25			24				24				24	
26			25				25				25	
27			26				26				26	
28			27				27				27	
29			28				28				28	
30			29				29				29	
31			30				30				30	
32			31				31				31	

#	CC0	CC32	PC	Bank: Ballroom	CC0	CC32	PC	Bank: Dance	CC0	CC32	PC	Bank: Rock
1	0	3	0	Easy Listening	0	4	0	Club House	0	5	0	Pop Rock
2			1	Slow Band			1	Euro Trance			1	English Rock
3			2	Big Band Jump			2	Fashion Funk			2	Fire Rock
4			3	Big Band Fox			3	Dance Fever			3	Hard Rock
5			4	Big Band 40's			4	Funky Disco			4	Open Rock 1
6			5	50's Fox			5	Barry Dance			5	Open Rock 2
7			6	Organ Foxtrot			6	Sister & Girl			6	Heavy Rock
8			7	Organ Waltz			7	Philly Disco			7	Funky Rock
9			8	Waltz Ballad 1			8	Oriental Dance			8	Rock Oldie
10			9	Waltz Ballad 2			9	Groove It Up			9	Rock & Roll
11			10	Foxtrot 1			10	60's Dance			10	South Shuffle
12			11	Foxtrot 2			11	70's Disco 1			11	60's Rock
13			12	Fox Shuffle 1			12	70's Disco 2			12	Surf Rock
14			13	Fox Shuffle 2			13	80's Dance			13	Latin Rock 1
15			14	Quick Step 1			14	Miami Disco			14	Latin Rock 2
16			15	Quick Step 2			15	Love Disco			15	Slow latin rock
17			16	Slow Fox			16	Dance Motown			16	Slow Rock 1
18			17	Italian Fox			17	Soca Dance			17	Slow Rock 2
19			18	Operetta			18	Disco Gully			18	60's Slow Rock
20			19	Orchestral Tango			19	Dance Mix			19	Rock 6/8
21			20	English Tango			20	Disco Latin			20	Steely Rock
22			21	Italian Tango 1			21	House Garage			21	Abbey Rock
23			22	Italian Tango 2			22	House			22	SouthStrait Rock
24			23	Argentina Tango			23	Techno			23	Rock Beat
25			24	Irish Fox			24	Rap			24	Rock Shuffle
26			25	Twist			25	HipHop			25	Blues Shuffle
27			26	Jive			26				26	Light Rock
28			27	Pasodoble			27				27	
29			28	Hully Gully			28				28	
30			29				29				29	
31			30				30				30	
32			31				31				31	
#	CC0	CC32	PC	Bank: Funk & Soul	CC0	CC32	PC	Bank: Country	CC0	CC32	PC	Bank: World 1
1	0	6	0	Funk R&B	0	7	0	Country Strum	0	8	0	Oberkr. Waltz 1
2			1	Kool Funk			1	Country QuikStep			1	Oberkr. Waltz 2
3			2	Al Funk			2	Country Beat 1			2	Oberkr. Polka 1
4			3	Elektrik Funk			3	Country Beat 2			3	Oberkr. Polka 2
5			4	Classic Funk			4	Country Ballad 1			4	Schlager Polka
6			5	Black Funk			5	Country Ballad 2			5	Party Polka
7			6	Talkin' Jazz			6	Country 3/4			6	Alpen Ballade
8			7	Funky Sisters			7	Modern Country			7	Polka Pop
9			8	Rhythm & Blues			8	Country Pop			8	Bavarian Pop
10			9	Blues			9	Bar Country			9	ClassicSchlager1
11			10	Soul			10	Bluegrass			10	ClassicSchlager2
12			11	Gospel			11	Country Boogie			11	ClassicSchlager3
13			12	Gospel Swing			12	Country Shuffle 1			12	Organ Evergreens
14			13	Gospel Shuffle			13	Country Shuffle 2			13	Schlager Rhumba
15			14	Modern Gospel 1			14	Country 8 Beat			14	SchlagerShuffle1
16			15	Modern Gospel 2			15	Country 16 Beat			15	SchlagerShuffle2
17			16	Al Swing			16				16	Dance Schlager
18			17	Groove			17				17	Fox Schlager
19			18	Groove Funk			18				18	Medium Schlager
20			19	Jazz Funk			19				19	Disco Schlager
21			20	Motown Shuffle 1			20				20	Pop Schlager
22			21	Motown Shuffle 2			21				21	Alpen Rock
23			22				22				22	Rock Schlager
24			23				23				23	Volkst. Schlager
25			24				24				24	Country Schlager
26			25				25				25	Schlager 1
27			26				26				26	Schlager 2
28			27				27				27	Schlager 3
29			28				28				28	Schlager 4
30			29				29				29	Caribbean
31			30				30				30	Samba Medley
32			31				31				31	Party Mix

#	CC0	CC32	PC	Bank: World 2	CC0	CC32	PC	Bank: Latin	CC0	CC32	PC	Bank: Latin Dance
1	0	9	0	Hawaiian	0	10	0	Guitar Bossa	0	11	0	Brazilian Samba
2			1	Flamenco 4/4			1	Basic Bossa			1	Sambalegre
3			2	Flamenco 3/4			2	Cool Bossa			2	Samba
4			3	Banda 2/4			3	Meditation Bossa			3	Samba De Sol
5			4	Mexican Waltz			4	Fast Bossa 1			4	DiscoSamba
6			5	Celtic Dream			5	Fast Bossa 2			5	Mambo
7			6	Celtic Waltz			6	Orch. Bossa 1			6	Mambo 2000
8			7	Celtic Ballad			7	Orch. Bossa 2			7	Mambo Party
9			8	Scottish Reel			8	Modern Bossa			8	Salsa 1
10			9	Orchestral Waltz			9	Organ Bossa			9	Salsa 2
11			10	OrchestralBolero			10	Groove Bossa			10	Merengue 1
12			11	Minuetto			11	Natural Bossa			11	Merengue 2
13			12	Baroque			12	Cool Latin Jazz			12	Club Latin
14			13	New Age			13	Cha Cha 1			13	Gipsy Dance
15			14	Tarantella			14	Cha Cha 2			14	Rhumba
16			15	Raspa			15	Cha Cha 3			15	Cumbia
17			16	Orleans			16	Cuban Cha Cha			16	Calypso
18			17	Norteno			17	Pop Cha Cha			17	Lambada
19			18	Quebradita			18	Disco Cha Cha			18	Meneaito
20			19	Tejano			19	Latin Big Band			19	Macarena
21			20	Cajun			20	Latin Pop			20	Bomba
22			21	Zydeco			21	Lite Beguine			21	Tortura Dance
23			22	Mariachi			22	Beguine			22	Sabor
24			23	Hora			23	Bachata			23	Andean
25			24	9/8			24	Latin Bolero			24	Reggae 1
26			25	Vahde			25	Bayon			25	Reggae 2
27			26	2/4 Oyun			26	Habanera			26	
28			27	Ciftetelli			27	Guajira			27	
29			28	Halay			28				28	
30			29	5/8			29				29	
31			30	Oryantal			30				30	
32			31	Turkish Pop			31				31	
#	CC0	CC32	PC	Bank: Jazz	CC0	CC32	PC	Bank: Trad(itional)	CC0	CC32	PC	Bank: Movie & Show
1	0	12	0	Bigger Band	0	13	0	German Waltz 1	0	14	0	Hollywood 1
2			1	Medium BigBand1			1	German Waltz 2			1	Hollywood 2
3			2	Medium BigBand2			2	German Waltz 3			2	Broadway
4			3	Fast Big Band 1			3	Vienna Waltz			3	Show Time
5			4	Fast Big Band 2			4	Italian Waltz			4	The Avalon
6			5	Serenade Band			5	Musette Waltz			5	Tap Dance
7			6	Jazz Club			6	French Waltz			6	Movie Ballad
8			7	BeBop			7	Irish Waltz			7	Movie Swing
9			8	Slow Swing Brush			8	Laendler Waltz			8	Safari Swing
10			9	Swing Ballad 1			9	German Polka			9	Western Movie
11			10	Swing Ballad 2			10	Italian Polka 1			10	Mystery Man
12			11	Swing Ballad 3			11	Italian Polka 2			11	Cartoon Time
13			12	Orchestral Swing			12	Italian Polka 3			12	Horror Movie
14			13	Django			13	Italian Mazurka 1			13	Love Movie
15			14	Jazz Brush			14	Italian Mazurka 2			14	Cinema Ballad
16			15	Soft Jazz			15	Italian Mazurka 3			15	Love Ballad
17			16	Jazzy Blues			16	March			16	Christmas Waltz
18			17	70's Beat Groove			17	French March			17	Christmas Swing
19			18	Organ Swing			18				18	Theatre Swing
20			19	Organ Blues			19				19	Theatre March
21			20	50's Swing			20				20	Army Band
22			21	Medium Swing			21				21	
23			22	Vocal Swing			22				22	
24			23	Moon Swing			23				23	
25			24	Jazz Waltz 1			24				24	
26			25	Jazz Waltz 2			25				25	
27			26	5/4 Swing			26				26	
28			27	Stride			27				27	
29			28	Dixieland			28				28	
30			29	Charleston			29				29	
31			30				30				30	
32			31				31				31	

#	CC0	CC32	PC	Bank: Unplug(ged)	CC0	CC32	PC	Bank: Contemp(orary)	CC0	CC32	PC	Bank: User 1
1	0	15	0	Unplugged Ballad 1	0	16	0	Funky R&B	0	17	0	8 Beat Standard
2			1	Unplugged Ballad 2			1	AM : PM			1	16 Beat Standard
3			2	Unplugged Ballad 3			2	Little Boy			2	Rock Cha Cha
4			3	Unplugged Slow			3	Island View			3	Cha Cha
5			4	Desert Shuffle			4	Karma			4	Salsa
6			5	Serenade			5	Smooth Jazz			5	Bachata
7			6	Unplugged			6	Slow & jazzy			6	Rhumba
8			7	Meditando			7	Take beat			7	Flamenco
9			8	Unplugged Gtr 1			8	Swing HipHop			8	Modern Tango
10			9	Unplugged Gtr 2			9	Slow HipHop			9	Paso Dance
11			10	Unplugged Gtr 3			10	Hip Hindi Hop			10	Slow Waltz
12			11	Unplugged Gtr 4			11	Soft HipHop			11	Jive
13			12	Unplugged 8 Bt			12	HipHop Funk			12	Quick Step
14			13	Unplugged 16 Bt			13	Elektro Funk			13	Slow Fox
15			14	Slide Blues			14	Jazzy PopFunk			14	Reggaeton
16			15	Unplugged Rock			15	Pop Funk			15	Pop Ska
17			16	Unplugged Latin			16	Elektro Pop			16	Vocal Latin
18			17	Unplugged Swing			17	Modern Latin			17	Vocal Pop
19			18	Unplugged 3/4			18	Folk Beat			18	Cool Vocal
20			19	Acoustic Bld.3/4			19	Wave Jazz			19	Vocal Jazz
21			20				20	Little Shuffle			20	Orchestral Movie
22			21				21				21	Orchestral Bld
23			22				22				22	Ballad 6/8
24			23				23				23	Modern Ballad
25			24				24				24	Pop Rock Hit
26			25				25				25	Dance Hit
27			26				26				26	
28			27				27				27	
29			28				28				28	
30			29				29				29	
31			30				30				30	
32			31				31				31	
#	CC0	CC32	PC	Bank; User 2	CC0	CC32	PC	Bank: User 3	CC0	CC32	PC	Bank: Favorite 1~10
1	0	18	0		0	19	0		0	20-29	0	
2			1				1				1	
3			2				2				2	
4			3				3				3	
5			4				4				4	
6			5				5				5	
7			6				6				6	
8			7				7				7	
9			8				8				8	
10			9				9				9	
11			10				10				10	
12			11				11				11	
13			12				12				12	
14			13				13				13	
15			14				14				14	
16			15				15				15	
17			16				16				16	
18			17				17				17	
19			18				18				18	
20			19				19				19	
21			20				20				20	
22			21				21				21	
23			22				22				22	
24			23				23				23	
25			24				24				24	
26			25				25				25	
27			26				26				26	
28			27				27				27	
29			28				28				28	
30			29				29				29	
31			30				30				30	
32			31				31				31	

Style Elements

Note: You can remotely select the various Style Elements on the Pa800, by sending it Program Change messages on the Control channel (see “MIDI: MIDI In Channels” on page 225).

PC	Style Element	PC	Style Element	PC	Style Element	PC	Style Element	PC	Style Element
80	Intro 1	81	Intro 2	82	Intro 3/Count In	83	Variation 1	84	Variation 2
85	Variation 3	86	Variation 4	87	Fill 1	88	Fill 2	89	Fill 3/Break
90	Ending 1	91	Ending 2	92	Ending 3				

Note: The above Program Change numbers are given according to the 0-127 numbering system.

Style and Player controls

Note: You can remotely send various commands to the Style and Sequencers of the Pa800, by sending it Program Change messages on the Control channel (see “MIDI: MIDI In Channels” on page 225).

PC	Style Element	PC	Style Element	PC	Style Element	PC	Style Element	PC	Style Element
93	Fade In/Out	94	Memory	95	Bass Inversion	96	Manual Bass	97	Tempo Lock
98	Single Touch	99	Style Change	100	Start/Stop (Style)	101	Play/Stop (Ply 1)	102	Play/Stop (Ply 2)

Note: The above Program Change numbers are given according to the 0-127 numbering system.

Single Touch Settings (STS)

Note: You can remotely select Single Touch Settings (STS) on the Pa800, by sending it Bank Select MSB (CC#0), Bank Select LSB (CC#32) and Program Change messages on the Control channel (see “MIDI: MIDI In Channels” on page 225). If a Style is already selected, just send the Program Change message.

CC#0	CC#32	PC	STS	PC	STS	PC	STS	PC	STS
The same as the Style to which the STS belongs		64	STS 1	65	STS 2	66	STS 3	67	STS 4

Sounds (Bank order)

The following table lists all Pa800 Factory Sounds as they appear in the Banks accessed by pressing the SOUND buttons on the control panel.

Legend: The table also includes MIDI data used to remotely select the Sounds. **CC00:** Control Change 0, or Bank Select MSB. **CC32:** Control Change 32, or Bank Select LSB. **PC:** Program Change. **Bank:** Sound/Performance Select button.

Name	CC00	CC32	PC
Bank: Piano			
Grand Piano RX	121	10	0
Grand Piano	121	3	0
Bright Piano GM	121	0	1
Grand&MovingPad	121	9	0
E.Grand Piano GM	121	0	2
Honky-Tonk GM	121	0	3
Harpsi KeyOff RX	121	3	6
Clav RX	121	5	7
AcousticPiano GM	121	0	0
Classic Piano	121	4	0
Jazz Piano	121	5	0
Piano & Strings	121	7	0
M1 Piano	121	2	2
Honky Wide	121	1	3
Harpsi 16' RX	121	5	6
Synth Clav RX	121	6	7
Bright Piano RX	121	5	1
Rock Piano	121	8	0
Ac. Piano Wide	121	1	0
Ac. Piano Dark	121	2	0
90's Piano	121	3	2
2000's Piano	121	4	2
Harpsichord GM	121	0	6
Clav GM	121	0	7
Bright PianoWide	121	1	1
Piano & Pad	121	4	1
Piano Pad 1	121	2	1
Piano Pad 2	121	3	1
E. Grand Wide	121	1	2
Grand&FM Stack	121	7	2
Harpsi Octave	121	1	6
Clav Wah RX	121	2	7
Chorus Piano	121	5	2
Piano Layers	121	6	2
Piano & Vibes	121	6	0
Harpsi Wide	121	2	6
Harpsi Korg	121	4	6
Pulse Clav	121	1	7
Clav Snap	121	3	7
Sticky Clav	121	4	7
Grand RX DEMO	121	11	0
Bank: E. Piano			
Tine E.Piano RX	121	18	4
Club E. Piano	121	11	4
Suit E.Piano 1	121	20	4
Vintage EP	121	4	4
Dig. E. Piano	121	14	5
Classic Tines	121	9	5

Name	CC00	CC32	PC
Classic Wurly 1	121	17	4
FM Pad E.P.	121	15	5
Tine E.Piano	121	19	4
Studio EP	121	7	4
Suit E.Piano 2	121	21	4
Dyno Tine EP 1	121	10	4
Stereo Dig. EP	121	6	5
Classic Dig. EP	121	7	5
Classic Wurly 2	121	12	4
FM Stack E.P.	121	16	5
Thin E. Piano	121	9	4
Pro Dyno EP	121	5	4
Pro Stage EP	121	6	4
Dyno Tine EP 2	121	22	4
Hybrid EP	121	8	5
Phantom Tine	121	10	5
Soft Wurly	121	13	4
White Pad EP	121	13	5
E. Piano 1 GM	121	0	4
R&B E. Piano	121	8	4
Bell E. Piano 1	121	23	4
Bell E. Piano 2	121	24	4
E. Piano 2 GM	121	0	5
DW8000 EP	121	11	5
Tremolo Wurly	121	16	4
Sweeping EP	121	12	5
Detuned EP 1	121	1	4
60's E. Piano	121	3	4
EP1 Veloc.sw	121	2	4
Syn Piano X	121	5	5
Detuned EP 2	121	1	5
EP2 Veloc.sw	121	2	5
Hard Wurly	121	14	4
EP Phase	121	4	5
Vel. Wurly	121	15	4
EP Legend	121	3	5
EP+Damper1 DNC	121	25	4
EP+Damper2 DNC	121	26	4
Bank: Mallet & Bell			
Vibraphone 1 GM	121	0	11
Vibraphone 2	121	2	11
Vibraphone 3	121	3	11
Vibrap. Wide	121	1	11
Marimba GM	121	0	12
Marimba Wide	121	1	12
Marimba Key Off	121	2	12
Monkey Skuls	121	3	12
Xylophone GM	121	0	13
Balaphon	121	6	12
Celesta GM	121	0	8
Glockenspiel GM	121	0	9
Music Box GM	121	0	10
Sistro	121	1	9
Orgel	121	1	10
Digi Bell	121	4	98
Steel Drums GM	121	0	114
Warm Steel	121	1	114
Vs Bell Boy	121	2	98
Tubular Bell GM	121	0	14
Church Bell 1	121	1	14
Church Bell 2	121	3	14
Krystal Bell	121	3	98

Name	CC00	CC32	PC
Tinkle Bell GM	121	0	112
Carillon	121	2	14
Dulcimer GM	121	0	15
Santur	121	1	15
Kalimba GM	121	0	108
Kalimba 2	121	1	108
Mallet Clock	121	5	12
Gamelan	121	1	112
Bali Gamelan	121	2	112
Garbage Mall	121	3	112
Bank: Accordion			
Harmonica AT 1	121	3	22
Harmonica AT 2	121	4	22
Harmonica GM	121	0	22
Cassotto 16'	121	12	21
Cassotto	121	9	21
Master Accordion	121	23	21
Accordion 16,8,4'	121	3	23
Sweet Musette	121	11	21
Sweet Harmonica	121	1	22
Harmonica 2	121	2	22
Cassotto Or.Tune	121	13	21
Cassotto NorTune	121	14	21
Acc.Clarinet OT	121	19	21
Acc. Clarinet NT	121	20	21
Acc. Piccolo OT	121	21	21
Acc. Piccolo NT	121	22	21
Accordion16,8'	121	2	23
Acc.16,8,4' Plus	121	8	23
French Musette	121	18	21
2 Voices Musette	121	16	21
3 Voices Musette	121	17	21
Detune Accordion	121	15	21
Fisa Master	121	8	21
Fisa 16,8'	121	6	21
Accordion16,4'	121	7	23
Fisa 16,4'	121	7	21
Musette Clar.	121	5	21
Musette 1	121	3	21
Musette 2	121	4	21
Accordion GM	121	0	21
Tango Accord. GM	121	0	23
Tango Accordion2	121	10	23
Fisa Tango!	121	1	23
Akordeon	121	2	21
Accordion 2	121	1	21
Accordion 3	121	24	21
Acc.16,8' & Bass	121	4	23
Acc. & Acc. Bass	121	9	23
Accordion Bass	121	5	23
Arabic Accordion	121	10	21
Steirisch.Akk.1	121	25	21
Steirisch.Akk.2	121	26	21
Steirisch.Akk.3	121	27	21
Steirisch.Akk.4	121	28	21
Acc.Voice Change	121	6	23
Harmonica DNC	121	5	22
Bank: Organ			
Jimmy Organ V.	121	10	18
Perc. Organ GM	121	0	17
Perc. Organ 2	121	2	17

Name	CC00	CC32	PC
Perc. Organ 3	121	10	17
Perc. Organ 4 V.	121	9	17
Perc. Organ 5 V.	121	11	17
Classic Click	121	4	18
Perc.Short Decay	121	8	18
BX3 Rock 1 V.	121	10	16
BX3 Rock 2 V.	121	1	18
BX3 Rock 3 V.	121	5	18
BX3 Rock 4V.	121	12	18
Rock Organ GM	121	0	18
Rock Organ 2	121	11	18
Dirty B	121	3	18
Killer B	121	2	18
BX3 Full V.	121	6	16
BX3 Jazz V.	121	20	16
BX3 Jazz Pc. V.	121	9	18
BX3 Short Decay	121	7	17
Super BX Perc.	121	6	18
BX3 Gospel V.	121	21	16
Gospel Organ V.	121	13	16
Gospel Organ	121	9	16
Drawbars Slow V.	121	19	16
Drawbars Fast V.	121	18	16
Drawbars Org. GM	121	0	16
Drawbar Org. 2	121	3	16
Det.DrawbarsOrg.	121	1	16
Drawbars Organ	121	14	16
Old Wheels	121	3	17
Jazz Organ	121	8	16
Organ Low Pc. V.	121	4	17
Organ Low 1 V.	121	4	16
Organ Low 2 V.	121	15	16
Organ Mid V.	121	16	16
Organ Hi V.	121	17	16
Dark Organ 1 V.	121	7	16
Dark Organ 2 V.	121	5	16
Rotary Organ	121	8	17
Pipe Tutti 1	121	6	19
Pipe Tutti 2	121	8	19
Pipe Tutti 3	121	9	19
Pipe Tutti 4	121	10	19
Church Organ GM	121	0	19
Church Pipes	121	4	19
Church Oct. Mix	121	1	19
Full Pipes	121	5	19
Pipe Mixture	121	3	19
Pipe Flute 1	121	4	20
Pipe Flute 2	121	5	20
Flauto Pipes	121	3	20
Small Pipe	121	2	20
Puff Organ	121	1	20
Positive Organ	121	7	19
Detuned Church	121	2	19
Reed Organ GM	121	0	20
Det. Perc. Organ	121	1	17
VOX Legend	121	11	16
It. 60's Organ	121	2	16
M1 Organ	121	5	17
Dirty Jazz Organ	121	7	18
Arabian Organ	121	12	16
Big Theatre Org.	121	30	16
Theatre Organ 1	121	22	16

Name	CC00	CC32	PC
Theatre Organ 2	121	23	16
Theatre Organ 3	121	24	16
Theatre Organ 4	121	25	16
Tibia	121	26	16
Tibia 16/8/4'	121	27	16
Tibia & Vox	121	28	16
Post Horn Trem.	121	29	16
Tibia & Kinura	121	31	16
Tibia Vox Glock	121	32	16
Jimmy Organ DNC	121	13	18
Bank: Digi Organ			
Digital Drawbars	121	127	16
Bank: Guitar			
Nylon Gtr Pro1	121	8	24
Nylon Slide Pro	121	14	24
Steel Guitar Pro	121	19	25
12 Strings Pro	121	17	25
Soft Jazz Guitar	121	5	26
Single Coil Pro	121	14	27
5th Mute Gtr	121	21	28
Stereo Dist.Gtr	121	8	30
Nylon Gtr Pro2	121	11	24
Nylon Vel. Harm.	121	10	24
Pop Steel Gtr 1	121	21	25
Steel 12 String	121	5	25
JazzGtr SlidePro	121	6	26
Solid Guitar	121	21	27
Clean Funk RX1	121	10	28
Dist. Guitar RX1	121	9	30
Nylon Bossa	121	4	24
Spanish Guitar	121	6	24
Steel Slide Pro1	121	13	25
12 Strings Gtr	121	1	25
Club Jazz Gtr 1	121	2	26
Clean Guitar 2	121	20	27
Funk Stein RX1	121	12	28
Dist. Guitar RX2	121	10	30
Nylon Guitar GM	121	0	24
Nylon Key Off	121	2	24
Steel Guitar GM	121	0	25
Pop Steel Gtr 2	121	22	25
Club Jazz Gtr 2	121	3	26
Vintage S.1	121	19	27
Clean Mute Gtr	121	6	28
Distortion GtrGM	121	0	30
Nylon Guitar 2	121	15	24
Ac.Guitar KeyOff	121	5	24
Steel Guitar 3	121	20	25
Steel Guitar 2	121	4	25
Clean Jazz 1	121	22	27
Clean Gtr Pro1	121	13	27
Muted Guitar GM	121	0	28
Dist. Clean Gtr	121	11	30
Nylon Guitar 3	121	3	24
Brazilian Guitar	121	9	24
Steel Folk Gtr	121	9	25
Steel Slide Pro2	121	14	25
Jazz Guitar GM	121	0	26
Chorus Gtr Pro	121	18	27
Mute Vel. Gtr	121	2	28
Overdrive Gtr GM	121	0	29

Name	CC00	CC32	PC
Guitar Strings	121	7	24
Steel & Body	121	3	25
Pop Steel Slide	121	23	25
Finger Key Off	121	7	25
Clean Jazz 2	121	23	27
Tel. Middle	121	26	27
Clean Funk	121	8	28
Wet Dist. Guitar	121	6	30
Mandolin	121	2	25
Mandolin Key Off	121	10	25
Mandolin Trem.	121	11	25
Mandolin Ens. 1	121	26	25
Mandolin Ens. 2	121	27	25
Banjo GM	121	0	105
Banjo Key Off	121	1	105
Banjo RX	121	4	105
Sitar GM	121	0	104
Sitar 2	121	1	104
Sitar Tambou	121	2	104
Sitar Sitar	121	7	104
Indian Stars	121	3	104
Indian Frets	121	4	104
Tambra	121	6	104
Ukulele	121	1	24
Bouzouki	121	5	104
Kanoun 1	121	5	107
Kanoun 2	121	2	107
Kanoun Trem. 1	121	6	107
Kanoun Trem. 2	121	3	107
Kanoun Mix	121	4	107
Oud 1	121	5	105
Oud 2	121	2	105
Ac. Baglama 1	121	7	107
Ac. Baglama 2	121	8	107
Ac. Baglama Grp.	121	9	107
Shamisen GM	121	0	106
Koto GM	121	0	107
Taisho Koto	121	1	107
Finger Tips	121	8	25
Hackbrett	121	6	25
Reso. Guitar	121	12	25
Country Nu	121	11	27
Pedal Steel Gtr1	121	1	26
Pedal Steel Gtr2	121	4	26
Jazz Man	121	3	28
Tel. Bridge	121	27	27
54 E. Guitar	121	24	27
Guitarish	121	8	27
Mid Tone Gtr	121	2	27
Single Coil	121	6	27
Stra. Vel. Pro	121	16	27
Stra. Gtr Slide	121	17	27
Stra. Chime	121	5	28
New Stra.Guitar	121	7	27
Clean Guitar GM	121	0	27
Clean Gtr Pro2	121	15	27
Clean Guitar 3	121	25	27
Det. Clean Gtr	121	1	27
Soft Overdrive	121	2	29
Chorus Guitar	121	3	27
Vintage S.2	121	4	27
Proces.E.Guitar	121	5	27

Name	CC00	CC32	PC
L&R E.Guitar 1	121	9	27
L&R E.Guitar 2	121	10	27
R&R Guitar	121	4	28
Funky Cut Gtr	121	1	28
Rhythm E.Guitar	121	7	28
Muted Guitar 2	121	19	28
E.Gtr Harmonics	121	2	31
Solo Dist.Guitar	121	7	30
Dist. Steel Gtr	121	12	30
Gtr Harmonic GM	121	0	31
Feedback Guitar	121	1	30
Guitar Pinch	121	1	29
Power Chords	121	4	30
Joystick Gtr Y-	121	3	30
Mute Monster	121	5	30
Disto Mute	121	9	28
Dist.Rhythmic Gtr	121	2	30
Guitar Feedback	121	1	31
Nylon Gtr RX1	121	12	24
Nylon Gtr RX2	121	13	24
Steel Guitar RX1	121	15	25
Steel Guitar RX2	121	16	25
12 Strings RX	121	18	25
Pop SteelGtr RX1	121	24	25
Pop SteelGtr RX2	121	25	25
Vox Wah Chick RX	121	3	120
Funky Wah RX	121	12	27
Clean Funk RX2	121	11	28
Funk Stein RX2	121	13	28
Clean Guitar RX1	121	14	28
Clean Guitar RX2	121	15	28
Clean Guitar RX3	121	16	28
Clean Guitar RX4	121	17	28
Clean Guitar RX5	121	18	28
Clean Guitar RX6	121	20	28
RealNylon Gtr ST	121	16	24
Real Nylon Gtr	121	17	24
RealSteel Gtr ST	121	28	25
RealFolk Gtr ST1	121	29	25
RealFolk Gtr ST2	121	30	25
Real Steel Gtr	121	31	25
Real Folk Gtr	121	32	25
Real 12 Strings	121	33	25
Real El. Gtr ST1	121	28	27
Real El.Gtr ST2	121	29	27
Real El. Guitar1	121	30	27
Real El. Guitar2	121	31	27
Nylon Guitar DNC	121	18	24
Natural Nylon DNC	121	19	24
RealFolk Gtr DNC	121	34	25
Steel Gtr DNC	121	35	25
Jazz Guitar DNC	121	7	26
Crunch Gtr DNC	121	3	29
Bank: Strings & Vocal			
Violin Expr. 1	121	2	40
Violin & Viola	121	2	41
Concert Str.RX	121	23	48
Movie Strings 1	121	5	49
Analog Strings 1	121	5	50
Strings Ens. RX	121	22	48
Wuuh Choir	121	8	52
Scat V.& Bass1	121	17	52

Name	CC00	CC32	PC
Violin Expr. 2	121	4	40
Viola Expr.	121	1	41
Ensemble & Solo	121	11	48
Movie Strings 2	121	6	49
Analog Strings 2	121	2	50
i3 Strings	121	5	48
Oh-Ah Voices	121	9	52
Femal&Male Scat	121	14	52
Slow Violin	121	3	40
Strings Quartet	121	9	48
Full Strings	121	2	49
Stereo Strings	121	3	48
Master Pad	121	2	89
N Strings	121	6	48
Take Voices 1	121	4	52
Scat V.& Bass2	121	18	52
Slow Att.Violin	121	1	40
Chamber Strings	121	12	48
Arco Strings	121	7	48
Legato Strings	121	4	48
Sweeper Strings	121	1	49
Symphonic Bows	121	10	48
Ooh Slow Voice	121	3	52
Scat Voices RX	121	19	52
Orchestra Tutti1	121	14	48
Orchestra Tutti2	121	19	48
Orch. & Oboe 1	121	16	48
Orch. & Oboe 2	121	17	48
Strings & Horns	121	15	48
Orchestra&Flute	121	20	48
Strings & Glock.	121	18	48
Spiccato Strings	121	4	49
Violin GM	121	0	40
Viola GM	121	0	41
Cello GM	121	0	42
Contrabass GM	121	0	43
Tremolo Str. GM	121	0	44
Harp GM	121	0	46
Pizzicato Str.GM	121	0	45
Pizz. Ensemble	121	1	45
Pizz. Section	121	2	45
Double Strings	121	3	45
Octave Strings	121	8	48
60's Strings	121	2	48
Strings Ens.1 GM	121	0	48
Strings Ens.2 GM	121	0	49
Strings Ens. 3	121	21	48
Strings Ens. 4	121	3	49
Synth Strings1GM	121	0	50
Synth Strings2GM	121	0	51
Synth Strings 3	121	1	50
Synth Strings 4	121	6	50
Synth Strings 5	121	1	51
Strings & Brass	121	1	48
Arabic Strings	121	13	48
Fiddle GM	121	0	110
Male Scat	121	16	52
Femal Scat	121	15	52
Take Voices 2	121	5	52
Aah Choir	121	7	52
Choir Aahs GM	121	0	52
Choir Aahs 2	121	1	52

Name	CC00	CC32	PC
Grand Choir	121	11	52
Slow Choir	121	10	52
Voice Oohs GM	121	0	53
Ooh Choir	121	6	52
Ooh Voices	121	2	52
Choir Light	121	12	52
Synth Voice GM	121	0	54
Synth Voices 2	121	6	54
Cyber Choir	121	2	85
Odissey	121	4	50
Voice Lead GM	121	0	85
Choir Pad GM	121	0	91
Halo Pad GM	121	0	94
Full Vox Pad	121	9	91
Strings Choir	121	13	52
Analog Velve	121	3	50
Vocalesque	121	2	54
Fresh Breath	121	7	91
Ether Voices	121	1	85
Dream Voice	121	5	54
Humming	121	1	53
Analog Voice	121	1	54
Classic Vox	121	4	54
Doolally	121	2	53
Vocalscape	121	3	54
Heaven	121	3	91
Airways	121	3	53
Yang Chin	121	1	46
Movie Str.1 DNC	121	7	49
Movie Str.2 DNC	121	8	49
Scat Voices DNC	121	20	52
Bank: Trumpet & Trbn.			
Trumpet Expr.1	121	15	56
Trumpet Expr.2	121	4	56
Cornet Expr.	121	21	56
Sweet FlugelHorn	121	12	56
Trombone Expr. 1	121	6	57
Trombone Vel. 1	121	8	57
Hard Trombone	121	3	57
Wah Trumpet	121	2	59
Trumpet Pro 1	121	10	56
Cornet Pro 1	121	22	56
Trumpet Overb.	121	2	56
Flugel Horn Pro	121	13	56
Trombone Expr. 2	121	7	57
Trombone Vel. 2	121	9	57
Trombone Pro Vel	121	11	57
Mute Trumpet GM	121	0	59
Trumpet Pro 2	121	11	56
Trumpet Pro 3	121	16	56
Cornet Pro 2	121	23	56
Warm Flugel	121	8	56
Pitch Trombone	121	5	57
Trombone Vel. 3	121	10	57
Soft Trombone	121	4	57
Mute Trumpet 2	121	1	59
Concert Trumpet	121	19	56
Concert Trp.Pro	121	20	56
Alp Trumpet	121	17	56
Dual Trumpets	121	6	56
Trombone GM	121	0	57
Trombone 2	121	1	57

Name	CC00	CC32	PC
Bright Trombone	121	2	57
Trombone 3	121	12	57
Trumpet GM	121	0	56
Trumpet 2	121	14	56
BeBop Cornet	121	9	56
Flugel Horn	121	7	56
Trumpet Shake Y+	121	18	56
Mono Trumpet	121	3	56
Dark Trumpet	121	1	56
Trumpet Pitch	121	5	56
Tuba GM	121	0	58
Tuba Gold	121	2	58
Oberkr. Tuba	121	1	58
Dynabone	121	3	58
Ob.Tuba & E.Bass 1	121	4	58
Ob.Tuba & E.Bass 2	121	5	58
Trumpet DNC	121	24	56
Cornet DNC	121	25	56
Trombone DNC	121	13	57
Bank: Brass			
Big Band Brass 1	121	32	61
Big Band Brass 2	121	4	61
Tight Brass 1	121	27	61
Tight Brass 2	121	29	61
Tight Brass Pro	121	28	61
Big BandShake Y+	121	33	61
Trumpet Ens1 Y+	121	35	61
Trumpet Ens2 Y+	121	36	61
Trumpet Ens.	121	9	61
Trpts & Trombs	121	34	61
Trombone Ens.	121	10	61
Trombones	121	11	61
Trpts & Brass	121	7	61
Fat Brass	121	13	61
Dyna Brass 1	121	14	61
Dyna Brass 2	121	22	61
Glen & Friends	121	3	61
Glen & Boys	121	6	61
Sax & Brass	121	5	61
Brass & Sax	121	16	61
Mute Ensemble 1	121	3	59
Mute Ensemble 2	121	4	59
Flute Muted	121	6	73
Double Brass	121	24	61
French Horn GM	121	0	60
French Horn 2	121	1	60
French Section	121	2	60
Horns & Ensemble	121	4	60
Classic Horns	121	3	60
Attack Brass	121	8	61
Brass of Power	121	30	61
Sforzato Brass	121	23	61
Brass Section GM	121	0	61
Brass Section 2	121	1	61
Power Brass	121	21	61
Brass Expr.	121	15	61
Film Brass	121	17	61
Movie Brass	121	20	61
Brass Slow	121	18	61
Fanfare	121	19	61
Synth Brass 1GM	121	0	62
Synth Brass 2GM	121	0	63

Name	CC00	CC32	PC
Synth Brass 3	121	1	62
Synth Brass 4	121	1	63
Synth Brass 5	121	5	62
Synth Brass 6	121	5	63
Analog Brass 1	121	2	62
Analog Brass 2	121	2	63
Elektrik Brass	121	4	62
Jump Brass	121	3	62
Brass Pad	121	3	63
Brass Section 3	121	31	61
Orchestra Hit GM	121	0	55
Brass Fall	121	26	61
Tight Brass 3	121	2	61
Tight Brass 4	121	12	61
Brass Impact	121	4	55
Brass Hit	121	25	61
Euro Hit	121	3	55
Bass Hit Plus	121	1	55
Netherland Hit	121	8	55
6th Hit	121	2	55
Bank: Sax			
Alto Sax Expr.	121	9	65
Alto Sax RX	121	10	65
Tenor Sax Noise1	121	1	66
Tenor Sax Noise2	121	6	66
Sweet Soprano 1	121	3	64
Soprano Pro	121	2	64
Baritone Sax Pro	121	3	67
Breathy Baritone	121	2	67
Sweet Alto Sax 1	121	5	65
Soft Alto Sax	121	7	65
Tenor Sax Expr.1	121	7	66
Jazz Tenor 1	121	9	66
Sweet Soprano 2	121	4	64
Sweet Soprano 3	121	1	64
Baritone Sax GM	121	0	67
Baritone Sax 2	121	4	67
Alto Sax Pro	121	8	65
Sweet Alto Sax 2	121	6	65
Alto Sax GM	121	0	65
Alto Breath	121	1	65
Tenor Sax Expr.2	121	8	66
Jazz Tenor 2	121	10	66
Tenor Breath	121	3	66
Tenor Sax GM	121	0	66
Breathy Alto Sax	121	3	65
Alto Sax Growl	121	4	65
Soft Tenor	121	2	66
Tenor Growl	121	4	66
Folk Sax	121	5	66
Soprano Sax GM	121	0	64
Baritone Growl	121	1	67
Cool Sax Ens.	121	11	65
Sax Ensemble	121	2	65
Reed of Power	121	11	66
Alto Sax DNC	121	12	65
Tenor Sax DNC	121	12	66
Bank: Woodwind			
Flute Switch	121	2	73
Jazz Flute RX	121	10	73
Flute Frullato	121	4	73

Name	CC00	CC32	PC
Clarinet Pro 1	121	8	71
Oboe GM	121	0	68
Whistle RX1	121	3	78
Pan Flute GM	121	0	75
Nay	121	2	72
Jazz Flute Expr.	121	1	73
Flute Dyn. 5th	121	3	73
Flute GM	121	0	73
Clarinet Pro 2	121	9	71
Bassoon GM	121	0	70
Whistle RX2	121	4	78
Old Shakuhachi	121	1	77
HighlandBagPipes	121	3	109
Flute 2	121	9	73
Wooden Flute	121	7	73
Piccolo GM	121	0	72
Jazz Clarinet	121	1	71
Double Reed	121	1	68
Whistle Breathe	121	2	78
Blown Bottle GM	121	0	76
Bambu Flute	121	8	73
Orchestra Flute	121	5	73
Woodwinds	121	6	71
Small Orchestra	121	1	72
Clarinet Ens.	121	5	71
Section Winds 1	121	3	71
Section Winds 2	121	4	71
Reeds & Saxes	121	10	71
Shanai GM	121	0	111
English Horn GM	121	0	69
English Horn 2	121	1	69
Clarinet GM	121	0	71
Folk Clarinet	121	7	71
Recorder GM	121	0	74
Recorder 2	121	1	74
Whistle GM	121	0	78
Whistle 2	121	1	78
Bag Pipes GM	121	0	109
Uilleann BagPipes	121	2	109
War Pipes	121	1	109
Ocarina GM	121	0	79
Kawala	121	1	75
Shakuhachi GM	121	0	77
Shakuhachi 2	121	2	77
Hichiriki	121	2	111
Clarinet GM	121	0	71
Klarnet 1	121	11	71
Klarnet 2	121	12	71
Zurna 1	121	3	111
Zurna 2	121	1	111
Flute Click	121	1	121
Clarinet DNC	121	13	71
Flute DNC	121	11	73
Whistle DNC	121	5	78
Bank: Synth 1			
The Pad	121	4	89
Dark Pad	121	6	89
Analog Pad 1	121	8	89
Analog Pad 2	121	9	89
Vintage Pad	121	11	89
OB Pad	121	12	89
Dark Anna	121	13	89

Name	CC00	CC32	PC
Symphonic Ens.	121	14	89
Future Pad	121	5	91
Air Clouds	121	1	97
Tinklin Pad	121	3	97
Pods In Pad	121	4	97
Vintage Sweep	121	7	95
You Decide	121	8	95
Korgmatose	121	13	90
Reoccurring Astra	121	6	95
Money Pad	121	5	89
Tsunami Wave	121	6	91
Ravelian Pad	121	8	91
Astral Dream	121	1	95
Meditate	121	2	95
Reso Down	121	2	97
Sky Watcher	121	2	90
Super Sweep	121	4	90
Wave Sweep	121	5	90
Cross Sweep	121	6	90
Digi Ice Pad	121	2	101
Crimson 5ths	121	1	86
Freedom Pad	121	7	89
Noble Pad	121	5	97
Mellow Pad	121	4	95
Lonely Spin	121	1	100
Cinema Pad	121	5	95
Virtual Traveler	121	1	88
Synth Ghostly	121	2	100
Motion Ocean	121	1	96
Moon Cycles	121	5	102
Farluce	121	11	90
Bell Pad	121	6	98
Bell Choir	121	7	98
Warm Pad GM	121	0	89
Sweep Pad GM	121	0	95
Soundtrack GM	121	0	97
Sine Pad	121	1	89
Itopia Pad	121	1	91
Big Panner	121	4	63
Dance ReMix	121	10	91
Rave	121	6	97
Elastick Pad	121	7	97
Moving Bell	121	5	98
Analog Pad 3	121	10	89
Big Sweep Stab	121	12	90
Fresh Air 1	121	2	91
Fresh Air 2	121	11	91
Pop Synth Pad 1	121	4	91
Pop Synth Pad 2	121	12	91
80's Pop Synth	121	2	93
Wave Cycle DNC	121	3	96
Bank: Synth 2			
Old Portamento	121	3	80
Power Saw	121	5	81
Octo Lead	121	6	81
Electro Lead	121	2	87
Rich Lead	121	3	87
Thin Analog Lead	121	4	87
Dance Lead	121	4	80
Wave Lead	121	5	80
Sine Wave	121	6	80
Synchro City	121	2	84

Name	CC00	CC32	PC
Wild Arp	121	6	55
Express. Lead	121	5	87
HipHop Lead	121	6	87
Analog Lead	121	7	80
Seq Lead	121	7	81
Old & Analog	121	8	80
Phat Saw Lead	121	8	81
Glide Lead	121	9	81
Gliding Square	121	9	80
Flip Blip	121	7	55
Power Synth	121	3	89
Sine Switch	121	10	80
Reso Sweep	121	1	90
Synth Sweeper	121	3	90
Cosmic	121	1	93
Motion Raver	121	1	101
Sync Kron	121	3	84
Fire Wave	121	10	81
Digital PolySix	121	7	90
A Leadload	121	11	87
Noisy Stabb	121	8	90
Mega Synth	121	9	90
Tecno Phonic	121	10	90
Dark Element	121	3	95
Band Passed	121	3	102
Cat Lead	121	9	87
Pan Reso	121	4	102
Square Rez	121	11	80
Rezbo	121	11	81
Auto Pilot 1	121	14	38
Metallic Rez	121	4	84
Square Bass	121	7	87
Synth Pianoid	121	12	81
Brian Sync	121	5	84
Arp Twins	121	6	84
Arp Angeles	121	2	88
Big & Raw	121	8	87
Caribbean	121	2	96
Lead Square GM	121	0	80
Lead Saw GM	121	0	81
Calliope GM	121	0	82
Chiff GM	121	0	83
Charang GM	121	0	84
Fifths Lead GM	121	0	86
Bass & Lead GM	121	0	87
New Age Pad GM	121	0	88
Polysynth GM	121	0	90
Bowed Glass GM	121	0	92
Metallic Pad GM	121	0	93
Crystal GM	121	0	98
Atmosphere GM	121	0	99
Brightness GM	121	0	100
Lead Square 2	121	1	80
Lead Sine	121	2	80
Lead Saw 2	121	1	81
Lead Saw Pulse	121	2	81
Lead Double Saw	121	3	81
Seq. Analog	121	4	81
Wire Lead	121	1	84
Soft Wrl	121	1	87
OB Lead	121	10	87
LoFi Ethnic	121	7	84

Name	CC00	CC32	PC
Port Whine	121	12	80
2VCO Planet Lead	121	13	80
VCF Modulation	121	3	101
Bank: Bass			
Acous. Bass Pro1	121	3	32
Jazz Bass	121	9	32
Finger Bass GM	121	0	33
Finger Bass 2	121	6	33
The Other Slap	121	5	37
Finger Slap 1	121	12	33
Pick Bass 1	121	7	34
Fretless Bass GM	121	0	35
Acous. Bass Pro2	121	4	32
Acoustic Bass GM	121	0	32
Finger Bass 3	121	7	33
Finger Bass 4	121	10	33
Super Bass 1	121	1	36
Super Bass 2	121	2	36
Pick Bass 2	121	8	34
Sweet Fretless	121	3	35
Bass & Ride 1	121	6	32
Acoustic Bass 2	121	8	32
Finger Bass 5	121	15	33
Bright Finger B.	121	9	33
Slap Bass 1 GM	121	0	36
Slap Bass 2 GM	121	0	37
Picked E.Bass GM	121	0	34
Fretless Bass 2	121	1	35
Bass & Ride 2	121	2	32
Ac. Bass Buzz	121	1	32
Finger E.Bass1	121	2	33
Finger E.Bass2	121	3	33
Slap Bass 3	121	6	36
Slap Bass 4	121	6	37
Picked E.Bass 4	121	11	34
Fretless Bass 3	121	2	35
DarkWoody A.Bass	121	5	32
More mid! Bass	121	11	33
Chorus Fing.Bass	121	8	33
Finger E.Bass3	121	4	33
Woofer Pusher B.	121	6	35
Slap Bass 5	121	7	37
Dyna Slap Bass	121	3	37
Chorus Slap Bass	121	4	37
Dyna Bass	121	2	37
Finger Slap 2	121	1	33
Thumb Bass	121	1	37
Picked E.Bass 2	121	1	34
Ticktacing Bass	121	9	34
Picked E.Bass 3	121	2	34
Bass Mute	121	5	34
Fretless Bass 4	121	7	35
Synth Bass 1 GM	121	0	38
Synth Bass 2 GM	121	0	39
Synth Bass 3	121	18	38
Synth Bass 4	121	15	39
Stick Bass	121	5	33
Dark R&B Bass2	121	5	35
Bass&Gtr Double	121	6	34
FingerB.& Guitar	121	14	33
Bass & Guitar	121	4	34
Auto Pilot 2	121	13	39

Name	CC00	CC32	PC
Bass4 Da Phunk	121	14	39
Syn Bass Warm	121	1	38
Syn Bass Reso	121	2	38
Dark R&B Bass1	121	4	35
Attack Bass	121	1	39
Rubber Bass	121	2	39
Dr. Octave	121	16	38
Monofilter Bass	121	11	39
Synth Bass 80ish	121	9	39
Reso Bass	121	12	39
Autofilter Bass	121	10	39
Drive Bass	121	17	38
Nasty Bass	121	6	39
30303 Bass	121	5	38
Stein Bass	121	3	34
Euro Bass	121	4	39
Jungle Rez	121	5	39
30303 Square	121	6	38
Bass Square	121	7	38
Phat Bass	121	7	39
Syn Bass Res	121	8	38
Clav Bass	121	3	38
Hammer	121	4	38
Attack Pulse	121	3	39
Digi Bass 1	121	9	38
Blind as a Bat	121	12	38
Poinker Bass	121	8	39
Digi Bass 3	121	11	38
Jungle Bass	121	13	38
Hybrid Bass	121	15	38
Digi Bass 2	121	10	38
Techno Org.Bass	121	6	17
Organ Pedal 1	121	10	32
Organ Pedal 2	121	11	32
Acous. Bass RX	121	7	32
Finger Bass RX	121	13	33
SlapFing Bass RX	121	4	36
Picked Bass RX	121	10	34
SlapPick Bass RX	121	5	36
FunkSlap Bass RX	121	3	36
Finger Bass DNC	121	16	33
Bank: Drum & Perc.			
Standard Kit RX1	120	0	5
Standard Kit RX2	120	0	1
Standard Kit RX3	120	0	2
Standard Kit RX4	120	0	6
Ambient Kit RX	120	0	3
Pop Std. Kit RX	120	0	4
Electro Kit RX1	120	0	75
Electro Kit RX2	120	0	76
Brush Kit RX1	120	0	42
Brush Kit RX2	120	0	43
Brush Kit RX3	120	0	44
Hip Hop Kit RX	120	0	72
Jazz Kit RX1	120	0	33
Jazz Kit RX2	120	0	34
Jazz Kit RX3	120	0	35
Techno Kit RX	120	0	73
House Kit RX1	120	0	30
House Kit RX2	120	0	31
Power Kit RX1	120	0	18
Power Kit RX2	120	0	19

Name	CC00	CC32	PC
Dance Kit RX	120	0	74
Analog Kit	120	0	123
Jungle Kit	120	0	10
Electro Kit	120	0	122
Standard Kit 1	120	0	7
Bdrum&Sdrum Kit	120	0	50
Room Kit 1	120	0	120
Room Kit 2	120	0	12
Power Kit 1	120	0	121
Power Kit 2	120	0	17
HipHop Kit 1	120	0	9
HipHop Kit 2	120	0	13
Techno Kit 1	120	0	11
Techno Kit 2	120	0	14
Techno Kit 3	120	0	15
House Kit 1	120	0	26
House Kit 2	120	0	27
House Kit 3	120	0	28
Brush Kit 1	120	0	125
Brush Kit 2	120	0	41
Pop Std. Kit 1	120	0	89
Pop Std. Kit 2	120	0	90
Elektro Kit 1	120	0	96
Elektro Kit 2	120	0	97
Arabian Kit 1	120	0	51
Arabian Kit 2	120	0	117
Turkish Kit	120	0	118
Oriental PercKit	120	0	119
Standard Kit GM	120	0	0
Room Kit GM	120	0	8
Power Kit GM	120	0	16
Electro Kit GM	120	0	24
Analog Kit GM	120	0	25
Jazz Kit GM	120	0	32
Brush Kit GM	120	0	40
Orchestra Kit GM	120	0	48
SFX Kit GM	120	0	56
SFX Kit 2	120	0	57
Percussion Kit	120	0	64
Latin Perc. Kit1	120	0	65
Latin Perc. Kit2	120	0	68
Trinity Perc.Kit	120	0	66
i30 Perc. Kit	120	0	67
Synth Kit	120	0	58
Timpani GM	121	0	47
Agogo GM	121	0	113
Log Drum	121	4	12
Woodblock GM	121	0	115
Castanets	121	1	115
Taiko Drum GM	121	0	116
Concert BassDrum	121	1	116
Melodic Tom GM	121	0	117
Melodic Tom 2	121	1	117
Reverse Tom	121	2	117
Synth Drum GM	121	0	118
Rhythm Box Tom	121	1	118
Electric Drum	121	2	118
Reverse Snare	121	3	118
Reverse CymbalGM	121	0	119
Reverse Cymbal 2	121	2	119
Dragon Gong	121	1	119

Name	CC00	CC32	PC
Bank: SFX			
Goblins GM	121	0	101
Echo Drops GM	121	0	102
Star Theme GM	121	0	103
Gtr FretNoise GM	121	0	120
Breath Noise GM	121	0	121
Seashore GM	121	0	122
Bird Tweet GM	121	0	123
Ac. Bass String	121	2	120
Telephone GM	121	0	124
Helicopter GM	121	0	125
Applause GM	121	0	126
Gun Shot GM	121	0	127
Synth Mallet	121	1	98
Echo Bell	121	1	102
Echo Pan	121	2	102
Guitar Cut Noise	121	1	120
Rain	121	1	122
Thunder	121	2	122
Wind	121	3	122
Stream	121	4	122
Bubble	121	5	122
Dog	121	1	123
Horse Gallop	121	2	123
Bird Tweet 2	121	3	123
Telephone 2	121	1	124
Door Creak	121	2	124
Door	121	3	124
Scratch	121	4	124
Wind Chime	121	5	124
Car Engine	121	1	125
Car Stop	121	2	125
Car Pass	121	3	125
Car Crash	121	4	125
Siren	121	5	125
Train	121	6	125
Jet Plane	121	7	125
Starship	121	8	125
Burst Noise	121	9	125
Laughing	121	1	126
Screaming	121	2	126
Punch	121	3	126
Heart Beat	121	4	126
Footsteps	121	5	126
Machine Gun	121	1	127
Laser Gun	121	2	127
Explosion	121	3	127
Ice Rain GM	121	0	96
Jaw Harp	121	3	105
Hit in India	121	5	55
Stadium	121	6	126

Sounds (Program Change order)

The following table lists all Pa800 Factory Sounds in order of Bank Select-Program Change number.

Legend: The table also includes MIDI data used to remotely select the Sounds. **CC00:** Control Change 0, or Bank Select MSB. **CC32:** Control Change 32, or Bank Select LSB. **PC:** Program Change. **Bank:** Sound/Performance Select button.

CC00	CC32	PC	Name	Bank	GM2
121	0	0	AcousticPiano GM	Piano	✓
121	1	0	Ac. Piano Wide	Piano	✓
121	2	0	Ac. Piano Dark	Piano	✓
121	3	0	Grand Piano	Piano	
121	4	0	Classic Piano	Piano	
121	5	0	Jazz Piano	Piano	
121	6	0	Piano & Vibes	Piano	
121	7	0	Piano & Strings	Piano	
121	8	0	Rock Piano	Piano	
121	9	0	Grand&MovingPad	Piano	
121	10	0	Grand Piano RX	Piano	
121	11	0	Grand RX DEMO	Piano	
121	0	1	Bright Piano GM	Piano	✓
121	1	1	Bright PianoWide	Piano	✓
121	2	1	Piano Pad 1	Piano	✓
121	3	1	Piano Pad 2	Piano	
121	4	1	Piano & Pad	Piano	
121	5	1	Bright Piano RX	Piano	
121	0	2	E.Grand Piano GM	Piano	✓
121	1	2	E. Grand Wide	Piano	✓
121	2	2	M1 Piano	Piano	
121	3	2	90's Piano	Piano	
121	4	2	2000's Piano	Piano	
121	5	2	Chorus Piano	Piano	
121	6	2	Piano Layers	Piano	
121	7	2	Grand&FM Stack	Piano	
121	0	3	Honky-Tonk GM	Piano	✓
121	1	3	Honky Wide	Piano	✓
121	0	4	E. Piano 1 GM	E.Piano	✓
121	1	4	Detuned EP 1	E.Piano	✓
121	2	4	EP1 Veloc.sw	E.Piano	✓
121	3	4	60's E. Piano	E.Piano	✓
121	4	4	Vintage EP	E.Piano	
121	5	4	Pro Dyno EP	E.Piano	
121	6	4	Pro Stage EP	E.Piano	
121	7	4	Studio EP	E.Piano	
121	8	4	R&B E. Piano	E.Piano	
121	9	4	Thin E. Piano	E.Piano	
121	10	4	Dyno Tine EP 1	E.Piano	
121	11	4	Club E. Piano	E.Piano	
121	12	4	Classic Wurly 2	E.Piano	
121	13	4	Soft Wurly	E.Piano	
121	14	4	Hard Wurly	E.Piano	
121	15	4	Vel. Wurly	E.Piano	
121	16	4	Tremolo Wurly	E.Piano	
121	17	4	Classic Wurly 1	E.Piano	
121	18	4	Tine E.Piano RX	E.Piano	
121	19	4	Tine E.Piano	E.Piano	
121	20	4	Suit E.Piano 1	E.Piano	
121	21	4	Suit E.Piano 2	E.Piano	
121	22	4	Dyno Tine EP 2	E.Piano	

CC00	CC32	PC	Name	Bank	GM2
121	23	4	Bell E. Piano 1	E.Piano	
121	24	4	Bell E. Piano 2	E.Piano	
121	25	4	EP+Damper1 DNC	E.Piano	
121	26	4	EP+Damper2 DNC	E.Piano	
121	0	5	E. Piano 2 GM	E.Piano	✓
121	1	5	Detuned EP 2	E.Piano	✓
121	2	5	EP2 Veloc.sw	E.Piano	✓
121	3	5	EP Legend	E.Piano	✓
121	4	5	EP Phase	E.Piano	✓
121	5	5	Syn Piano X	E.Piano	
121	6	5	Stereo Dig. EP	E.Piano	
121	7	5	Classic Dig. EP	E.Piano	
121	8	5	Hybrid EP	E.Piano	
121	9	5	Classic Tines	E.Piano	
121	10	5	Phantom Tine	E.Piano	
121	11	5	DW8000 EP	E.Piano	
121	12	5	Sweeping EP	E.Piano	
121	13	5	White Pad EP	E.Piano	
121	14	5	Dig. E. Piano	E.Piano	
121	15	5	FM Pad E.P.	E.Piano	
121	16	5	FM Stack E.P.	E.Piano	
121	5	22	Harmonica DNC	Accordion	
121	0	6	Harpsichord GM	Piano	✓
121	1	6	Harpsi Octave	Piano	✓
121	2	6	Harpsi Wide	Piano	✓
121	3	6	Harpsi KeyOff RX	Piano	✓
121	4	6	Harpsi Korg	Piano	
121	5	6	Harpsi 16' RX	Piano	
121	0	7	Clav GM	Piano	✓
121	1	7	Pulse Clav	Piano	✓
121	2	7	Clav Wah RX	Piano	
121	3	7	Clav Snap	Piano	
121	4	7	Sticky Clav	Piano	
121	5	7	Clav RX	Piano	
121	6	7	Synth Clav RX	Piano	
121	0	8	Celesta GM	Mallet & Bell	✓
121	0	9	Glockenspiel GM	Mallet & Bell	✓
121	1	9	Sistro	Mallet & Bell	
121	0	10	Music Box GM	Mallet & Bell	✓
121	1	10	Orgel	Mallet & Bell	
121	0	11	Vibraphone 1 GM	Mallet & Bell	✓
121	1	11	Vibrap. Wide	Mallet & Bell	✓
121	2	11	Vibraphone 2	Mallet & Bell	
121	3	11	Vibraphone 3	Mallet & Bell	
121	0	12	Marimba GM	Mallet & Bell	✓
121	1	12	Marimba Wide	Mallet & Bell	✓
121	2	12	Marimba Key Off	Mallet & Bell	
121	3	12	Monkey Skuls	Mallet & Bell	
121	4	12	Log Drum	Drum & Perc.	
121	5	12	Mallet Clock	Mallet & Bell	
121	6	12	Balaphon	Mallet & Bell	
121	0	13	Xylophone GM	Mallet & Bell	✓
121	13	18	Jimmy Organ DNC	Organ	
121	0	14	Tubular Bell GM	Mallet & Bell	✓
121	1	14	Church Bell 1	Mallet & Bell	✓
121	2	14	Carillon	Mallet & Bell	✓
121	3	14	Church Bell 2	Mallet & Bell	
121	0	15	Dulcimer GM	Mallet & Bell	✓
121	1	15	Santur	Mallet & Bell	
121	0	16	Drawbars Org. GM	Organ	✓
121	1	16	Det.DrawbarsOrg.	Organ	✓
121	2	16	It. 60's Organ	Organ	✓

CC00	CC32	PC	Name	Bank	GM2
121	3	16	Drawbar Org. 2	Organ	√
121	4	16	Organ Low 1 V.	Organ	
121	5	16	Dark Organ 2 V.	Organ	
121	6	16	BX3 Full V.	Organ	
121	7	16	Dark Organ 1 V.	Organ	
121	8	16	Jazz Organ	Organ	
121	9	16	Gospel Organ	Organ	
121	10	16	BX3 Rock 1 V.	Organ	
121	11	16	VOX Legend	Organ	
121	12	16	Arabian Organ	Organ	
121	13	16	Gospel Organ V.	Organ	
121	14	16	Drawbars Organ	Organ	
121	15	16	Organ Low 2 V.	Organ	
121	16	16	Organ Mid V.	Organ	
121	17	16	Organ Hi V.	Organ	
121	18	16	Drawbars Fast V.	Organ	
121	19	16	Drawbars Slow V.	Organ	
121	20	16	BX3 Jazz V.	Organ	
121	21	16	BX3 Gospel V.	Organ	
121	22	16	Theatre Organ 1	Organ	
121	23	16	Theatre Organ 2	Organ	
121	24	16	Theatre Organ 3	Organ	
121	25	16	Theatre Organ 4	Organ	
121	26	16	Tibia	Organ	
121	27	16	Tibia 16/8/4'	Organ	
121	28	16	Tibia & Vox	Organ	
121	29	16	Post Horn Trem.	Organ	
121	30	16	Big Theatre Org.	Organ	
121	31	16	Tibia & Kinura	Organ	
121	32	16	Tibia Vox Glock	Organ	
121	0	17	Perc. Organ GM	Organ	√
121	1	17	Det. Perc. Organ	Organ	√
121	2	17	Perc. Organ 2	Organ	√
121	3	17	Old Wheels	Organ	
121	4	17	Organ Low Pc. V.	Organ	
121	5	17	M1 Organ	Organ	
121	6	17	Techno Org.Bass	Bass	
121	7	17	BX3 Short Decay	Organ	
121	8	17	Rotary Organ	Organ	
121	9	17	Perc. Organ 4 V.	Organ	
121	10	17	Perc. Organ 3	Organ	
121	11	17	Perc. Organ 5 V.	Organ	
121	0	18	Rock Organ GM	Organ	√
121	1	18	BX3 Rock 2 V.	Organ	
121	2	18	Killer B	Organ	
121	3	18	Dirty B	Organ	
121	4	18	Classic Click	Organ	
121	5	18	BX3 Rock 3 V.	Organ	
121	6	18	Super BX Perc.	Organ	
121	7	18	Dirty Jazz Organ	Organ	
121	8	18	Perc.Short Decay	Organ	
121	9	18	BX3 Jazz Pc. V.	Organ	
121	10	18	Jimmy Organ V.	Organ	
121	11	18	Rock Organ 2	Organ	
121	12	18	BX3 Rock 4 V.	Organ	
121	0	19	Church Organ GM	Organ	√
121	1	19	Church Oct. Mix	Organ	√
121	2	19	Detuned Church	Organ	√
121	3	19	Pipe Mixture	Organ	
121	4	19	Church Pipes	Organ	
121	5	19	Full Pipes	Organ	
121	6	19	Pipe Tutti 1	Organ	

CC00	CC32	PC	Name	Bank	GM2
121	7	19	Positive Organ	Organ	
121	8	19	Pipe Tutti 2	Organ	
121	9	19	Pipe Tutti 3	Organ	
121	10	19	Pipe Tutti 4	Organ	
121	0	20	Reed Organ GM	Organ	√
121	1	20	Puff Organ	Organ	√
121	2	20	Small Pipe	Organ	
121	3	20	Flauto Pipes	Organ	
121	4	20	Pipe Flute 1	Organ	
121	5	20	Pipe Flute 2	Organ	
121	0	21	Accordion GM	Accordion	√
121	1	21	Accordion 2	Accordion	√
121	2	21	Akordeon	Accordion	
121	3	21	Musette 1	Accordion	
121	4	21	Musette 2	Accordion	
121	5	21	Musette Clar.	Accordion	
121	6	21	Fisa 16,8'	Accordion	
121	7	21	Fisa 16,4'	Accordion	
121	8	21	Fisa Master	Accordion	
121	9	21	Cassotto	Accordion	
121	10	21	Arabic Accordion	Accordion	
121	11	21	Sweet Musette	Accordion	
121	12	21	Cassotto 16'	Accordion	
121	13	21	Cassotto Or.Tune	Accordion	
121	14	21	Cassotto NorTune	Accordion	
121	15	21	Detune Accordion	Accordion	
121	16	21	2 Voices Musette	Accordion	
121	17	21	3 Voices Musette	Accordion	
121	18	21	French Musette	Accordion	
121	19	21	Acc.Clarinet OT	Accordion	
121	20	21	Acc. Clarinet NT	Accordion	
121	21	21	Acc. Piccolo OT	Accordion	
121	22	21	Acc. Piccolo NT	Accordion	
121	23	21	Master Accordion	Accordion	
121	24	21	Accordion 3	Accordion	
121	25	21	Steirisch.Akk.1	Accordion	
121	26	21	Steirisch.Akk.2	Accordion	
121	27	21	Steirisch.Akk.3	Accordion	
121	28	21	Steirisch.Akk.4	Accordion	
121	0	22	Harmonica GM	Accordion	√
121	1	22	Sweet Harmonica	Accordion	
121	2	22	Harmonica 2	Accordion	
121	3	22	Harmonica AT 1	Accordion	
121	4	22	Harmonica AT 2	Accordion	
121	0	23	Tango Accord. GM	Accordion	√
121	1	23	Fisa Tango!	Accordion	
121	2	23	Accordion 16,8'	Accordion	
121	3	23	Accordion16,8,4'	Accordion	
121	4	23	Acc.16,8' & Bass	Accordion	
121	5	23	Accordion Bass	Accordion	
121	6	23	Acc.Voice Change	Accordion	
121	7	23	Accordion 16,4'	Accordion	
121	8	23	Acc.16,8,4' Plus	Accordion	
121	9	23	Acc. & Acc. Bass	Accordion	
121	10	23	Tango Accordion2	Accordion	
121	0	24	Nylon Guitar GM	Guitar	√
121	1	24	Ukulele	Guitar	√
121	2	24	Nylon Key Off	Guitar	√
121	3	24	Nylon Guitar 3	Guitar	√
121	4	24	Nylon Bossa	Guitar	
121	5	24	Ac.Guitar KeyOff	Guitar	
121	6	24	Spanish Guitar	Guitar	

CC00	CC32	PC	Name	Bank	GM2
121	7	24	Guitar Strings	Guitar	
121	8	24	Nylon Gtr Pro1	Guitar	
121	9	24	Brazilian Guitar	Guitar	
121	10	24	Nylon Vel. Harm.	Guitar	
121	11	24	Nylon Gtr Pro2	Guitar	
121	12	24	Nylon Gtr RX1	Guitar	
121	13	24	Nylon Gtr RX2	Guitar	
121	14	24	Nylon Slide Pro	Guitar	
121	15	24	Nylon Guitar 2	Guitar	
121	16	24	RealNylon Gtr ST	Guitar	
121	17	24	Real Nylon Gtr	Guitar	
121	18	24	Nylon Guitar DNC	Guitar	
121	19	24	Natural Nylon DNC	Guitar	
121	0	25	Steel Guitar GM	Guitar	√
121	1	25	12 Strings Gtr	Guitar	√
121	2	25	Mandolin	Guitar	√
121	3	25	Steel & Body	Guitar	√
121	4	25	Steel Guitar 2	Guitar	
121	5	25	Steel 12 String	Guitar	
121	6	25	Hackbrett	Guitar	
121	7	25	Finger Key Off	Guitar	
121	8	25	Finger Tips	Guitar	
121	9	25	Steel Folk Gtr	Guitar	
121	10	25	Mandolin Key Off	Guitar	
121	11	25	Mandolin Trem.	Guitar	
121	12	25	Reso. Guitar	Guitar	
121	13	25	Steel Slide Pro1	Guitar	
121	14	25	Steel Slide Pro2	Guitar	
121	15	25	Steel Guitar RX1	Guitar	
121	16	25	Steel Guitar RX2	Guitar	
121	17	25	12 Strings Pro	Guitar	
121	18	25	12 Strings RX	Guitar	
121	19	25	Steel Guitar Pro	Guitar	
121	20	25	Steel Guitar 3	Guitar	
121	21	25	Pop Steel Gtr 1	Guitar	
121	22	25	Pop Steel Gtr 2	Guitar	
121	23	25	Pop Steel Slide	Guitar	
121	24	25	Pop SteelGtr RX1	Guitar	
121	25	25	Pop SteelGtr RX2	Guitar	
121	26	25	Mandolin Ens. 1	Guitar	
121	27	25	Mandolin Ens. 2	Guitar	
121	28	25	RealSteel Gtr ST	Guitar	
121	29	25	RealFolk Gtr ST1	Guitar	
121	30	25	RealFolk Gtr ST2	Guitar	
121	31	25	Real Steel Gtr	Guitar	
121	32	25	Real Folk Gtr	Guitar	
121	33	25	Real 12 Strings	Guitar	
121	34	25	RealFolk Gtr DNC	Guitar	
121	35	25	Steel Gtr DNC	Guitar	
121	0	26	Jazz Guitar GM	Guitar	√
121	1	26	Pedal Steel Gtr1	Guitar	√
121	2	26	Club Jazz Gtr 1	Guitar	
121	3	26	Club Jazz Gtr 2	Guitar	
121	4	26	Pedal Steel Gtr2	Guitar	
121	5	26	Soft Jazz Guitar	Guitar	
121	6	26	JazzGtr SlidePro	Guitar	
121	7	26	Jazz Guitar DNC	Guitar	
121	0	27	Clean Guitar GM	Guitar	√
121	1	27	Det. Clean Gtr	Guitar	√
121	2	27	Mid Tone Gtr	Guitar	√
121	3	27	Chorus Guitar	Guitar	
121	4	27	Vintage S.2	Guitar	

CC00	CC32	PC	Name	Bank	GM2
121	5	27	Proces.E.Guitar	Guitar	
121	6	27	Single Coil	Guitar	
121	7	27	New Stra.Guitar	Guitar	
121	8	27	Guitarish	Guitar	
121	9	27	L&R E.Guitar 1	Guitar	
121	10	27	L&R E.Guitar 2	Guitar	
121	11	27	Country Nu	Guitar	
121	12	27	Funky Wah RX	Guitar	
121	13	27	Clean Gtr Pro1	Guitar	
121	14	27	Single Coil Pro	Guitar	
121	15	27	Clean Gtr Pro2	Guitar	
121	16	27	Stra. Vel. Pro	Guitar	
121	17	27	Stra. Gtr Slide	Guitar	
121	18	27	Chorus Gtr Pro	Guitar	
121	19	27	Vintage S.1	Guitar	
121	20	27	Clean Guitar 2	Guitar	
121	21	27	Solid Guitar	Guitar	
121	22	27	Clean Jazz 1	Guitar	
121	23	27	Clean Jazz 2	Guitar	
121	24	27	'54 E. Guitar	Guitar	
121	25	27	Clean Guitar 3	Guitar	
121	26	27	Tel. Middle	Guitar	
121	27	27	Tel. Bridge	Guitar	
121	28	27	Real El. Gtr ST1	Guitar	
121	29	27	Real El.Gtr ST2	Guitar	
121	30	27	Real El. Guitar1	Guitar	
121	31	27	Real El. Guitar2	Guitar	
121	0	28	Muted Guitar GM	Guitar	√
121	1	28	Funky Cut Gtr	Guitar	√
121	2	28	Mute Vel. Gtr	Guitar	√
121	3	28	Jazz Man	Guitar	√
121	4	28	R&R Guitar	Guitar	
121	5	28	Stra. Chime	Guitar	
121	6	28	Clean Mute Gtr	Guitar	
121	7	28	Rhythm E.Guitar	Guitar	
121	8	28	Clean Funk	Guitar	
121	9	28	Disto Mute	Guitar	
121	10	28	Clean Funk RX1	Guitar	
121	11	28	Clean Funk RX2	Guitar	
121	12	28	Funk Stein RX1	Guitar	
121	13	28	Funk Stein RX2	Guitar	
121	14	28	Clean Guitar RX1	Guitar	
121	15	28	Clean Guitar RX2	Guitar	
121	16	28	Clean Guitar RX3	Guitar	
121	17	28	Clean Guitar RX4	Guitar	
121	18	28	Clean Guitar RX5	Guitar	
121	19	28	Muted Guitar 2	Guitar	
121	20	28	Clean Guitar RX6	Guitar	
121	21	28	5th Mute Gtr	Guitar	
121	0	29	Overdrive Gtr GM	Guitar	√
121	1	29	Guitar Pinch	Guitar	√
121	2	29	Soft Overdrive	Guitar	
121	3	29	Crunch Gtr DNC	Guitar	
121	0	30	Distortion GtrGM	Guitar	√
121	1	30	Feedback Guitar	Guitar	√
121	2	30	Dist.Rhythmic Gtr	Guitar	√
121	3	30	Joystick Gtr Y-	Guitar	
121	4	30	Power Chords	Guitar	
121	5	30	Mute Monster	Guitar	
121	6	30	Wet Dist. Guitar	Guitar	
121	7	30	Solo Dist.Guitar	Guitar	
121	8	30	Stereo Dist.Gtr	Guitar	

CC00	CC32	PC	Name	Bank	GM2
121	9	30	Dist. Guitar RX1	Guitar	
121	10	30	Dist. Guitar RX2	Guitar	
121	11	30	Dist. Clean Gtr	Guitar	
121	12	30	Dist. Steel Gtr	Guitar	
121	0	31	Gtr Harmonic GM	Guitar	✓
121	1	31	Guitar Feedback	Guitar	✓
121	2	31	E.Gtr Harmonics	Guitar	
121	0	32	Acoustic Bass GM	Bass	✓
121	1	32	Ac. Bass Buzz	Bass	
121	2	32	Bass & Ride 2	Bass	
121	3	32	Acous. Bass Pro1	Bass	
121	4	32	Acous. Bass Pro2	Bass	
121	5	32	DarkWoody A.Bass	Bass	
121	6	32	Bass & Ride 1	Bass	
121	7	32	Acous. Bass RX	Bass	
121	8	32	Acoustic Bass 2	Bass	
121	9	32	Jazz Bass	Bass	
121	10	32	Organ Pedal 1	Bass	
121	11	32	Organ Pedal 2	Bass	
121	0	33	Finger Bass GM	Bass	✓
121	1	33	Finger Slap 2	Bass	✓
121	2	33	Finger E.Bass1	Bass	
121	3	33	Finger E.Bass2	Bass	
121	4	33	Finger E.Bass3	Bass	
121	5	33	Stick Bass	Bass	
121	6	33	Finger Bass 2	Bass	
121	7	33	Finger Bass 3	Bass	
121	8	33	Chorus Fing.Bass	Bass	
121	9	33	Bright Finger B.	Bass	
121	10	33	Finger Bass 4	Bass	
121	11	33	More mid! Bass	Bass	
121	12	33	Finger Slap 1	Bass	
121	13	33	Finger Bass RX	Bass	
121	14	33	FingerB.& Guitar	Bass	
121	15	33	Finger Bass 5	Bass	
121	16	33	Finger Bass DNC	Bass	
121	0	34	Picked E.Bass GM	Bass	✓
121	1	34	Picked E.Bass 2	Bass	
121	2	34	Picked E.Bass 3	Bass	
121	3	34	Stein Bass	Bass	
121	4	34	Bass & Guitar	Bass	
121	5	34	Bass Mute	Bass	
121	6	34	Bass&Gtr Double	Bass	
121	7	34	Pick Bass 1	Bass	
121	8	34	Pick Bass 2	Bass	
121	9	34	Ticktacing Bass	Bass	
121	10	34	Picked Bass RX	Bass	
121	11	34	Picked E.Bass 4	Bass	
121	0	35	Fretless Bass GM	Bass	✓
121	1	35	Fretless Bass 2	Bass	
121	2	35	Fretless Bass 3	Bass	
121	3	35	Sweet Fretless	Bass	
121	4	35	Dark R&B Bass1	Bass	
121	5	35	Dark R&B Bass2	Bass	
121	6	35	Woofier Pusher B.	Bass	
121	7	35	Fretless Bass 4	Bass	
121	0	36	Slap Bass 1 GM	Bass	✓
121	1	36	Super Bass 1	Bass	
121	2	36	Super Bass 2	Bass	
121	3	36	FunkSlap Bass RX	Bass	
121	4	36	SlapFing Bass RX	Bass	
121	5	36	SlapPick Bass RX	Bass	

CC00	CC32	PC	Name	Bank	GM2
121	6	36	Slap Bass 3	Bass	
121	0	37	Slap Bass 2 GM	Bass	✓
121	1	37	Thumb Bass	Bass	
121	2	37	Dyna Bass	Bass	
121	3	37	Dyna Slap Bass	Bass	
121	4	37	Chorus Slap Bass	Bass	
121	5	37	The Other Slap	Bass	
121	6	37	Slap Bass 4	Bass	
121	7	37	Slap Bass 5	Bass	
121	0	38	Synth Bass 1 GM	Bass	✓
121	1	38	Syn Bass Warm	Bass	✓
121	2	38	Syn Bass Reso	Bass	✓
121	3	38	Clav Bass	Bass	✓
121	4	38	Hammer	Bass	✓
121	5	38	30303 Bass	Bass	
121	6	38	30303 Square	Bass	
121	7	38	Bass Square	Bass	
121	8	38	Syn Bass Res	Bass	
121	9	38	Digi Bass 1	Bass	
121	10	38	Digi Bass 2	Bass	
121	11	38	Digi Bass 3	Bass	
121	12	38	Blind as a Bat	Bass	
121	13	38	Jungle Bass	Bass	
121	14	38	Auto Pilot 1	Synth 2	
121	15	38	Hybrid Bass	Bass	
121	16	38	Dr. Octave	Bass	
121	17	38	Drive Bass	Bass	
121	18	38	Synth Bass 3	Bass	
121	0	39	Synth Bass 2 GM	Bass	✓
121	1	39	Attack Bass	Bass	✓
121	2	39	Rubber Bass	Bass	✓
121	3	39	Attack Pulse	Bass	✓
121	4	39	Euro Bass	Bass	
121	5	39	Jungle Rez	Bass	
121	6	39	Nasty Bass	Bass	
121	7	39	Phat Bass	Bass	
121	8	39	Poinker Bass	Bass	
121	9	39	Synth Bass 80ish	Bass	
121	10	39	Autofilter Bass	Bass	
121	11	39	Monofilter Bass	Bass	
121	12	39	Reso Bass	Bass	
121	13	39	Auto Pilot 2	Bass	
121	14	39	Bass4 Da Phunk	Bass	
121	15	39	Synth Bass 4	Bass	
121	0	40	Violin GM	Strings & Vocal	✓
121	1	40	Slow Att.Violin	Strings & Vocal	✓
121	2	40	Violin Expr. 1	Strings & Vocal	
121	3	40	Slow Violin	Strings & Vocal	
121	4	40	Violin Expr. 2	Strings & Vocal	
121	0	41	Viola GM	Strings & Vocal	✓
121	1	41	Viola Expr.	Strings & Vocal	
121	2	41	Violin & Viola	Strings & Vocal	
121	0	42	Cello GM	Strings & Vocal	✓
121	0	43	Contrabass GM	Strings & Vocal	✓
121	0	44	Tremolo Str. GM	Strings & Vocal	✓
121	0	45	Pizzicato Str.GM	Strings & Vocal	✓
121	1	45	Pizz. Ensemble	Strings & Vocal	
121	2	45	Pizz. Section	Strings & Vocal	
121	3	45	Double Strings	Strings & Vocal	
121	0	46	Harp GM	Strings & Vocal	✓
121	1	46	Yang Chin	Strings & Vocal	✓
121	0	47	Timpani GM	Drum & Perc.	✓

CC00	CC32	PC	Name	Bank	GM2
121	0	48	Strings Ens.1 GM	Strings & Vocal	√
121	1	48	Strings & Brass	Strings & Vocal	√
121	2	48	60's Strings	Strings & Vocal	√
121	3	48	Stereo Strings	Strings & Vocal	
121	4	48	Legato Strings	Strings & Vocal	
121	5	48	i3 Strings	Strings & Vocal	
121	6	48	N Strings	Strings & Vocal	
121	7	48	Arco Strings	Strings & Vocal	
121	8	48	Octave Strings	Strings & Vocal	
121	9	48	Strings Quartet	Strings & Vocal	
121	10	48	Symphonic Bows	Strings & Vocal	
121	11	48	Ensemble & Solo	Strings & Vocal	
121	12	48	Chamber Strings	Strings & Vocal	
121	13	48	Arabic Strings	Strings & Vocal	
121	14	48	Orchestra Tutti1	Strings & Vocal	
121	15	48	Strings & Horns	Strings & Vocal	
121	16	48	Orch. & Oboe 1	Strings & Vocal	
121	17	48	Orch. & Oboe 2	Strings & Vocal	
121	18	48	Strings & Glock.	Strings & Vocal	
121	19	48	Orchestra Tutti2	Strings & Vocal	
121	20	48	Orchestra&Flute	Strings & Vocal	
121	21	48	Strings Ens. 3	Strings & Vocal	
121	22	48	Strings Ens. RX	Strings & Vocal	
121	23	48	Concert Str.RX	Strings & Vocal	
121	0	49	Strings Ens.2 GM	Strings & Vocal	√
121	1	49	Sweeper Strings	Strings & Vocal	
121	2	49	Full Strings	Strings & Vocal	
121	3	49	Strings Ens. 4	Strings & Vocal	
121	4	49	Spiccato Strings	Strings & Vocal	
121	5	49	Movie Strings 1	Strings & Vocal	
121	6	49	Movie Strings 2	Strings & Vocal	
121	7	49	Movie Str.1 DNC	Strings & Vocal	
121	8	49	Movie Str.2 DNC	Strings & Vocal	
121	0	50	Synth Strings1GM	Strings & Vocal	√
121	1	50	Synth Strings 3	Strings & Vocal	√
121	2	50	Analog Strings 2	Strings & Vocal	
121	3	50	Analog Velve	Strings & Vocal	
121	4	50	Odissey	Strings & Vocal	
121	5	50	Analog Strings 1	Strings & Vocal	
121	6	50	Synth Strings 4	Strings & Vocal	
121	0	51	Synth Strings2GM	Strings & Vocal	√
121	1	51	Synth Strings 5	Strings & Vocal	
121	0	52	Choir Aahs GM	Strings & Vocal	√
121	1	52	Choir Aahs 2	Strings & Vocal	√
121	2	52	Ooh Voices	Strings & Vocal	
121	3	52	Ooh Slow Voice	Strings & Vocal	
121	4	52	Take Voices 1	Strings & Vocal	
121	5	52	Take Voices 2	Strings & Vocal	
121	6	52	Ooh Choir	Strings & Vocal	
121	7	52	Aah Choir	Strings & Vocal	
121	8	52	Wuuh Choir	Strings & Vocal	
121	9	52	Oh-Ah Voices	Strings & Vocal	
121	10	52	Slow Choir	Strings & Vocal	
121	11	52	Grand Choir	Strings & Vocal	
121	12	52	Choir Light	Strings & Vocal	
121	13	52	Strings Choir	Strings & Vocal	
121	14	52	Femal&Male Scat	Strings & Vocal	
121	15	52	Femal Scat	Strings & Vocal	
121	16	52	Male Scat	Strings & Vocal	
121	17	52	Scat V.& Bass1	Strings & Vocal	
121	18	52	Scat V.& Bass2	Strings & Vocal	
121	19	52	Scat Voices RX	Strings & Vocal	

CC00	CC32	PC	Name	Bank	GM2
121	20	52	Scat Voices DNC	Strings & Vocal	
121	0	53	Voice Oohs GM	Strings & Vocal	√
121	1	53	Humming	Strings & Vocal	√
121	2	53	Doolally	Strings & Vocal	
121	3	53	Airways	Strings & Vocal	
121	0	54	Synth Voice GM	Strings & Vocal	√
121	1	54	Analog Voice	Strings & Vocal	√
121	2	54	Vocalesque	Strings & Vocal	
121	3	54	Vocalscape	Strings & Vocal	
121	4	54	Classic Vox	Strings & Vocal	
121	5	54	Dream Voice	Strings & Vocal	
121	6	54	Synth Voices 2	Strings & Vocal	
121	0	55	Orchestra Hit GM	Brass	√
121	1	55	Bass Hit Plus	Brass	√
121	2	55	6th Hit	Brass	√
121	3	55	Euro Hit	Brass	√
121	4	55	Brass Impact	Brass	
121	5	55	Hit in India	SFX	
121	6	55	Wild Arp	Synth 2	
121	7	55	Flip Blip	Synth 2	
121	8	55	Netherland Hit	Brass	
121	0	56	Trumpet GM	Trumpet & Trbn.	√
121	1	56	Dark Trumpet	Trumpet & Trbn.	√
121	2	56	Trumpet Overb.	Trumpet & Trbn.	
121	3	56	Mono Trumpet	Trumpet & Trbn.	
121	4	56	Trumpet Expr.2	Trumpet & Trbn.	
121	5	56	Trumpet Pitch	Trumpet & Trbn.	
121	6	56	Dual Trumpets	Trumpet & Trbn.	
121	7	56	Flugel Horn	Trumpet & Trbn.	
121	8	56	Warm Flugel	Trumpet & Trbn.	
121	9	56	BeBop Cornet	Trumpet & Trbn.	
121	10	56	Trumpet Pro 1	Trumpet & Trbn.	
121	11	56	Trumpet Pro 2	Trumpet & Trbn.	
121	12	56	Sweet FlugelHorn	Trumpet & Trbn.	
121	13	56	Flugel Horn Pro	Trumpet & Trbn.	
121	14	56	Trumpet 2	Trumpet & Trbn.	
121	15	56	Trumpet Expr.1	Trumpet & Trbn.	
121	16	56	Trumpet Pro 3	Trumpet & Trbn.	
121	17	56	Alp Trumpet	Trumpet & Trbn.	
121	18	56	Trumpet Shake Y+	Trumpet & Trbn.	
121	19	56	Concert Trumpet	Trumpet & Trbn.	
121	20	56	Concert Trp.Pro	Trumpet & Trbn.	
121	21	56	Cornet Expr.	Trumpet & Trbn.	
121	22	56	Cornet Pro 1	Trumpet & Trbn.	
121	23	56	Cornet Pro 2	Trumpet & Trbn.	
121	24	56	Trumpet DNC	Trumpet & Trbn.	
121	25	56	Cornet DNC	Trumpet & Trbn.	
121	0	57	Trombone GM	Trumpet & Trbn.	√
121	1	57	Trombone 2	Trumpet & Trbn.	√
121	2	57	Bright Trombone	Trumpet & Trbn.	√
121	3	57	Hard Trombone	Trumpet & Trbn.	
121	4	57	Soft Trombone	Trumpet & Trbn.	
121	5	57	Pitch Trombone	Trumpet & Trbn.	
121	6	57	Trombone Expr. 1	Trumpet & Trbn.	
121	7	57	Trombone Expr. 2	Trumpet & Trbn.	
121	8	57	Trombone Vel. 1	Trumpet & Trbn.	
121	9	57	Trombone Vel. 2	Trumpet & Trbn.	
121	10	57	Trombone Vel. 3	Trumpet & Trbn.	
121	11	57	Trombone Pro Vel	Trumpet & Trbn.	
121	12	57	Trombone 3	Trumpet & Trbn.	
121	13	57	Trombone DNC	Trumpet & Trbn.	
121	0	58	Tuba GM	Trumpet & Trbn.	√

CC00	CC32	PC	Name	Bank	GM2
121	1	58	Oberkr. Tuba	Trumpet & Trbn.	
121	2	58	Tuba Gold	Trumpet & Trbn.	
121	3	58	Dynabone	Trumpet & Trbn.	
121	4	58	Ob.Tuba & E.Bass 1	Trumpet & Trbn.	
121	5	58	Ob.Tuba & E.Bass 2	Trumpet & Trbn.	
121	0	59	Mute Trumpet GM	Trumpet & Trbn.	✓
121	1	59	Mute Trumpet 2	Trumpet & Trbn.	✓
121	2	59	Wah Trumpet	Trumpet & Trbn.	
121	3	59	Mute Ensemble 1	Brass	
121	4	59	Mute Ensemble 2	Brass	
121	0	60	French Horn GM	Brass	✓
121	1	60	French Horn 2	Brass	✓
121	2	60	French Section	Brass	
121	3	60	Classic Horns	Brass	
121	4	60	Horns & Ensemble	Brass	
121	0	61	Brass Section GM	Brass	✓
121	1	61	Brass Section 2	Brass	✓
121	2	61	Tight Brass 3	Brass	
121	3	61	Glen & Friends	Brass	
121	4	61	Big Band Brass 2	Brass	
121	5	61	Sax & Brass	Brass	
121	6	61	Glen & Boys	Brass	
121	7	61	Trpts & Brass	Brass	
121	8	61	Attack Brass	Brass	
121	9	61	Trumpet Ens.	Brass	
121	10	61	Trombone Ens.	Brass	
121	11	61	Trombones	Brass	
121	12	61	Tight Brass 4	Brass	
121	13	61	Fat Brass	Brass	
121	14	61	Dyna Brass 1	Brass	
121	15	61	Brass Expr.	Brass	
121	16	61	Brass & Sax	Brass	
121	17	61	Film Brass	Brass	
121	18	61	Brass Slow	Brass	
121	19	61	Fanfare	Brass	
121	20	61	Movie Brass	Brass	
121	21	61	Power Brass	Brass	
121	22	61	Dyna Brass 2	Brass	
121	23	61	Sforzato Brass	Brass	
121	24	61	Double Brass	Brass	
121	25	61	Brass Hit	Brass	
121	26	61	Brass Fall	Brass	
121	27	61	Tight Brass 1	Brass	
121	28	61	Tight Brass Pro	Brass	
121	29	61	Tight Brass 2	Brass	
121	30	61	Brass of Power	Brass	
121	31	61	Brass Section 3	Brass	
121	32	61	Big Band Brass 1	Brass	
121	33	61	Big BandShake Y+	Brass	
121	34	61	Trpts & Trombs	Brass	
121	35	61	Trumpet Ens1 Y+	Brass	
121	36	61	Trumpet Ens2 Y+	Brass	
121	0	62	Synth Brass 1GM	Brass	✓
121	1	62	Synth Brass 3	Brass	✓
121	2	62	Analog Brass 1	Brass	✓
121	3	62	Jump Brass	Brass	✓
121	4	62	Elektrik Brass	Brass	
121	5	62	Synth Brass 5	Brass	
121	0	63	Synth Brass 2GM	Brass	✓
121	1	63	Synth Brass 4	Brass	✓
121	2	63	Analog Brass 2	Brass	✓
121	3	63	Brass Pad	Brass	

CC00	CC32	PC	Name	Bank	GM2
121	4	63	Big Panner	Synth 1	
121	5	63	Synth Brass 6	Brass	
121	0	64	Soprano Sax GM	Sax	✓
121	1	64	Sweet Soprano 3	Sax	
121	2	64	Soprano Pro	Sax	
121	3	64	Sweet Soprano 1	Sax	
121	4	64	Sweet Soprano 2	Sax	
121	0	65	Alto Sax GM	Sax	✓
121	1	65	Alto Breath	Sax	
121	2	65	Sax Ensemble	Sax	
121	3	65	Breathy Alto Sax	Sax	
121	4	65	Alto Sax Growl	Sax	
121	5	65	Sweet Alto Sax 1	Sax	
121	6	65	Sweet Alto Sax 2	Sax	
121	7	65	Soft Alto Sax	Sax	
121	8	65	Alto Sax Pro	Sax	
121	9	65	Alto Sax Expr.	Sax	
121	10	65	Alto Sax RX	Sax	
121	11	65	Cool Sax Ens.	Sax	
121	12	65	Alto Sax DNC	Sax	
121	0	66	Tenor Sax GM	Sax	✓
121	1	66	Tenor Sax Noise1	Sax	
121	2	66	Soft Tenor	Sax	
121	3	66	Tenor Breath	Sax	
121	4	66	Tenor Growl	Sax	
121	5	66	Folk Sax	Sax	
121	6	66	Tenor Sax Noise2	Sax	
121	7	66	Tenor Sax Expr.1	Sax	
121	8	66	Tenor Sax Expr.2	Sax	
121	9	66	Jazz Tenor 1	Sax	
121	10	66	Jazz Tenor 2	Sax	
121	11	66	Reed of Power	Sax	
121	12	66	Tenor Sax DNC	Sax	
121	0	67	Baritone Sax GM	Sax	✓
121	1	67	Baritone Growl	Sax	
121	2	67	Breathy Baritone	Sax	
121	3	67	Baritone Sax Pro	Sax	
121	4	67	Baritone Sax 2	Sax	
121	0	68	Oboe GM	Woodwind	✓
121	1	68	Double Reed	Woodwind	
121	0	69	English Horn GM	Woodwind	✓
121	1	69	English Horn 2	Woodwind	
121	0	70	Bassoon GM	Woodwind	✓
121	0	71	Clarinet GM	Woodwind	✓
121	1	71	Jazz Clarinet	Woodwind	
121	2	71	Clarinet G	Woodwind	
121	3	71	Section Winds 1	Woodwind	
121	4	71	Section Winds 2	Woodwind	
121	5	71	Clarinet Ens.	Woodwind	
121	6	71	Woodwinds	Woodwind	
121	7	71	Folk Clarinet	Woodwind	
121	8	71	Clarinet Pro 1	Woodwind	
121	9	71	Clarinet Pro 2	Woodwind	
121	10	71	Reeds & Saxes	Woodwind	
121	11	71	Klarnet 1	Woodwind	
121	12	71	Klarnet 2	Woodwind	
121	13	71	Clarinet DNC	Woodwind	
121	0	72	Piccolo GM	Woodwind	✓
121	1	72	Small Orchestra	Woodwind	
121	2	72	Nay	Woodwind	
121	0	73	Flute GM	Woodwind	✓
121	1	73	Jazz Flute Expr.	Woodwind	

CC00	CC32	PC	Name	Bank	GM2
121	2	73	Flute Switch	Woodwind	
121	3	73	Flute Dyn. 5th	Woodwind	
121	4	73	Flute Frullato	Woodwind	
121	5	73	Orchestra Flute	Woodwind	
121	6	73	Flute Muted	Brass	
121	7	73	Wooden Flute	Woodwind	
121	8	73	Bambu Flute	Woodwind	
121	9	73	Flute 2	Woodwind	
121	10	73	Jazz Flute RX	Woodwind	
121	11	73	Flute DNC	Woodwind	
121	0	74	Recorder GM	Woodwind	✓
121	1	74	Recorder 2	Woodwind	
121	0	75	Pan Flute GM	Woodwind	✓
121	1	75	Kawala	Woodwind	
121	0	76	Blown Bottle GM	Woodwind	✓
121	0	77	Shakuhachi GM	Woodwind	✓
121	1	77	Old Shakuhachi	Woodwind	
121	2	77	Shakuhachi 2	Woodwind	
121	0	78	Whistle GM	Woodwind	✓
121	1	78	Whistle 2	Woodwind	
121	2	78	Whistle Breathe	Woodwind	
121	3	78	Whistle RX1	Woodwind	
121	4	78	Whistle RX2	Woodwind	
121	5	78	Whistle DNC	Woodwind	
121	0	79	Ocarina GM	Woodwind	✓
121	0	80	Lead Square GM	Synth 2	✓
121	1	80	Lead Square 2	Synth 2	✓
121	2	80	Lead Sine	Synth 2	✓
121	3	80	Old Portamento	Synth 2	
121	4	80	Dance Lead	Synth 2	
121	5	80	Wave Lead	Synth 2	
121	6	80	Sine Wave	Synth 2	
121	7	80	Analog Lead	Synth 2	
121	8	80	Old & Analog	Synth 2	
121	9	80	Gliding Square	Synth 2	
121	10	80	Sine Switch	Synth 2	
121	11	80	Square Rez	Synth 2	
121	12	80	Port Whine	Synth 2	
121	13	80	2VCO Planet Lead	Synth 2	
121	0	81	Lead Saw GM	Synth 2	✓
121	1	81	Lead Saw 2	Synth 2	✓
121	2	81	Lead Saw Pulse	Synth 2	✓
121	3	81	Lead Double Saw	Synth 2	✓
121	4	81	Seq. Analog	Synth 2	✓
121	5	81	Power Saw	Synth 2	
121	6	81	Octo Lead	Synth 2	
121	7	81	Seq Lead	Synth 2	
121	8	81	Phat Saw Lead	Synth 2	
121	9	81	Glide Lead	Synth 2	
121	10	81	Fire Wave	Synth 2	
121	11	81	Rezbo	Synth 2	
121	12	81	Synth Pianoid	Synth 2	
121	0	82	Calliope GM	Synth 2	✓
121	0	83	Chiff GM	Synth 2	✓
121	0	84	Charang GM	Synth 2	✓
121	1	84	Wire Lead	Synth 2	✓
121	2	84	Synchro City	Synth 2	
121	3	84	Sync Kron	Synth 2	
121	4	84	Metallic Rez	Synth 2	
121	5	84	Brian Sync	Synth 2	
121	6	84	Arp Twins	Synth 2	
121	7	84	LoFi Ethnic	Synth 2	

CC00	CC32	PC	Name	Bank	GM2
121	0	85	Voice Lead GM	Strings & Vocal	✓
121	1	85	Ether Voices	Strings & Vocal	
121	2	85	Cyber Choir	Strings & Vocal	
121	0	86	Fifths Lead GM	Synth 2	✓
121	1	86	Crimson 5ths	Synth 1	
121	0	87	Bass & Lead GM	Synth 2	✓
121	1	87	Soft Wrl	Synth 2	✓
121	2	87	Electro Lead	Synth 2	
121	3	87	Rich Lead	Synth 2	
121	4	87	Thin Analog Lead	Synth 2	
121	5	87	Express. Lead	Synth 2	
121	6	87	HipHop Lead	Synth 2	
121	7	87	Square Bass	Synth 2	
121	8	87	Big & Raw	Synth 2	
121	9	87	Cat Lead	Synth 2	
121	10	87	OB Lead	Synth 2	
121	11	87	A Leadload	Synth 2	
121	0	88	New Age Pad GM	Synth 2	✓
121	1	88	Virtual Traveler	Synth 1	
121	2	88	Arp Angeles	Synth 2	
121	0	89	Warm Pad GM	Synth 1	✓
121	1	89	Sine Pad	Synth 1	✓
121	2	89	Master Pad	Strings & Vocal	
121	3	89	Power Synth	Synth 2	
121	4	89	The Pad	Synth 1	
121	5	89	Money Pad	Synth 1	
121	6	89	Dark Pad	Synth 1	
121	7	89	Freedom Pad	Synth 1	
121	8	89	Analog Pad 1	Synth 1	
121	9	89	Analog Pad 2	Synth 1	
121	10	89	Analog Pad 3	Synth 1	
121	11	89	Vintage Pad	Synth 1	
121	12	89	OB Pad	Synth 1	
121	13	89	Dark Anna	Synth 1	
121	14	89	Symphonic Ens.	Synth 1	
121	0	90	Polysynth GM	Synth 2	✓
121	1	90	Reso Sweep	Synth 2	
121	2	90	Sky Watcher	Synth 1	
121	3	90	Synth Sweeper	Synth 2	
121	4	90	Super Sweep	Synth 1	
121	5	90	Wave Sweep	Synth 1	
121	6	90	Cross Sweep	Synth 1	
121	7	90	Digital PolySix	Synth 2	
121	8	90	Noisy Stabb	Synth 2	
121	9	90	Mega Synth	Synth 2	
121	10	90	Tecno Phonic	Synth 2	
121	11	90	Farluce	Synth 1	
121	12	90	Big Sweep Stab	Synth 1	
121	13	90	Korgmatose	Synth 1	
121	0	91	Choir Pad GM	Strings & Vocal	✓
121	1	91	Itopia Pad	Synth 1	✓
121	2	91	Fresh Air 1	Synth 1	
121	3	91	Heaven	Strings & Vocal	
121	4	91	Pop Synth Pad 1	Synth 1	
121	5	91	Future Pad	Synth 1	
121	6	91	Tsunami Wave	Synth 1	
121	7	91	Fresh Breath	Strings & Vocal	
121	8	91	Ravelian Pad	Synth 1	
121	9	91	Full Vox Pad	Strings & Vocal	
121	10	91	Dance ReMix	Synth 1	
121	11	91	Fresh Air 2	Synth 1	
121	12	91	Pop Synth Pad 2	Synth 1	

CC00	CC32	PC	Name	Bank	GM2
121	0	92	Bowed Glass GM	Synth 2	✓
121	0	93	Metallic Pad GM	Synth 2	✓
121	1	93	Cosmic	Synth 2	
121	2	93	80's Pop Synth	Synth 1	
121	0	94	Halo Pad GM	Strings & Vocal	✓
121	0	95	Sweep Pad GM	Synth 1	✓
121	1	95	Astral Dream	Synth 1	
121	2	95	Meditate	Synth 1	
121	3	95	Dark Element	Synth 2	
121	4	95	Mellow Pad	Synth 1	
121	5	95	Cinema Pad	Synth 1	
121	6	95	Reoccurring Astra	Synth 1	
121	7	95	Vintage Sweep	Synth 1	
121	8	95	You Decide	Synth 1	
121	0	96	Ice Rain GM	SFX	✓
121	1	96	Motion Ocean	Synth 1	
121	2	96	Caribbean	Synth 2	
121	3	96	Wave Cycle DNC	Synth 1	
121	0	97	Soundtrack GM	Synth 1	✓
121	1	97	Air Clouds	Synth 1	
121	2	97	Reso Down	Synth 1	
121	3	97	Tinklin Pad	Synth 1	
121	4	97	Pods In Pad	Synth 1	
121	5	97	Noble Pad	Synth 1	
121	6	97	Rave	Synth 1	
121	7	97	Elastic Pad	Synth 1	
121	0	98	Crystal GM	Synth 2	✓
121	1	98	Synth Mallet	SFX	✓
121	2	98	Vs Bell Boy	Mallet & Bell	
121	3	98	Krystal Bell	Mallet & Bell	
121	4	98	Digi Bell	Mallet & Bell	
121	5	98	Moving Bell	Synth 1	
121	6	98	Bell Pad	Synth 1	
121	7	98	Bell Choir	Synth 1	
121	0	99	Atmosphere GM	Synth 2	✓
121	0	100	Brightness GM	Synth 2	✓
121	1	100	Lonely Spin	Synth 1	
121	2	100	Synth Ghostly	Synth 1	
121	0	101	Goblins GM	SFX	✓
121	1	101	Motion Raver	Synth 2	
121	2	101	Digi Ice Pad	Synth 1	
121	3	101	VCF Modulation	Synth 2	
121	0	102	Echo Drops GM	SFX	✓
121	1	102	Echo Bell	SFX	✓
121	2	102	Echo Pan	SFX	✓
121	3	102	Band Passed	Synth 2	
121	4	102	Pan Reso	Synth 2	
121	5	102	Moon Cycles	Synth 1	
121	0	103	Star Theme GM	SFX	✓
121	0	104	Sitar GM	Guitar	✓
121	1	104	Sitar 2	Guitar	✓
121	2	104	Sitar Tambou	Guitar	
121	3	104	Indian Stars	Guitar	
121	4	104	Indian Frets	Guitar	
121	5	104	Bouzouki	Guitar	
121	6	104	Tambra	Guitar	
121	7	104	Sitar Sitar	Guitar	
121	0	105	Banjo GM	Guitar	✓
121	1	105	Banjo Key Off	Guitar	
121	2	105	Oud 2	Guitar	
121	3	105	Jaw Harp	SFX	
121	4	105	Banjo RX	Guitar	

CC00	CC32	PC	Name	Bank	GM2
121	5	105	Oud 1	Guitar	
121	0	106	Shamisen GM	Guitar	✓
121	0	107	Koto GM	Guitar	✓
121	1	107	Taisho Koto	Guitar	✓
121	2	107	Kanoun 2	Guitar	
121	3	107	Kanoun Trem. 2	Guitar	
121	4	107	Kanoun Mix	Guitar	
121	5	107	Kanoun 1	Guitar	
121	6	107	Kanoun Trem. 1	Guitar	
121	7	107	Ac. Baglama 1	Guitar	
121	8	107	Ac. Baglama 2	Guitar	
121	9	107	Ac. Baglama Grp.	Guitar	
121	0	108	Kalimba GM	Mallet & Bell	✓
121	1	108	Kalimba 2	Mallet & Bell	
121	0	109	Bag Pipes GM	Woodwind	✓
121	1	109	War Pipes	Woodwind	
121	2	109	Uilleann BagPipes	Woodwind	
121	3	109	HighlandBagPipes	Woodwind	
121	0	110	Fiddle GM	Strings & Vocal	✓
121	0	111	Shanai GM	Woodwind	✓
121	1	111	Zurna 2	Woodwind	
121	2	111	Hichiriki	Woodwind	
121	3	111	Zurna 1	Woodwind	
121	0	112	Tinkle Bell GM	Mallet & Bell	✓
121	1	112	Gamelan	Mallet & Bell	
121	2	112	Bali Gamelan	Mallet & Bell	
121	3	112	Garbage Mall	Mallet & Bell	
121	0	113	Agogo GM	Drum & Perc.	✓
121	0	114	Steel Drums GM	Mallet & Bell	✓
121	1	114	Warm Steel	Mallet & Bell	
121	0	115	Woodblock GM	Drum & Perc.	✓
121	1	115	Castanets	Drum & Perc.	✓
121	0	116	Taiko Drum GM	Drum & Perc.	✓
121	1	116	Concert BassDrum	Drum & Perc.	✓
121	0	117	Melodic Tom GM	Drum & Perc.	✓
121	1	117	Melodic Tom 2	Drum & Perc.	✓
121	2	117	Reverse Tom	Drum & Perc.	
121	0	118	Synth Drum GM	Drum & Perc.	✓
121	1	118	Rhythm Box Tom	Drum & Perc.	✓
121	2	118	Electric Drum	Drum & Perc.	✓
121	3	118	Reverse Snare	Drum & Perc.	
121	0	119	Reverse CymbalGM	Drum & Perc.	✓
121	1	119	Dragon Gong	Drum & Perc.	
121	2	119	Reverse Cymbal 2	Drum & Perc.	
121	0	120	Gtr FretNoise GM	SFX	✓
121	1	120	Guitar Cut Noise	SFX	✓
121	2	120	Ac. Bass String	SFX	✓
121	3	120	Vox Wah Chick RX	Guitar	
121	0	121	Breath Noise GM	SFX	✓
121	1	121	Flute Click	Woodwind	✓
121	0	122	Seashore GM	SFX	✓
121	1	122	Rain	SFX	✓
121	2	122	Thunder	SFX	✓
121	3	122	Wind	SFX	✓
121	4	122	Stream	SFX	✓
121	5	122	Bubble	SFX	✓
121	0	123	Bird Tweet GM	SFX	✓
121	1	123	Dog	SFX	✓
121	2	123	Horse Gallop	SFX	✓
121	3	123	Bird Tweet 2	SFX	✓
121	0	124	Telephone GM	SFX	✓
121	1	124	Telephone 2	SFX	✓

CC00	CC32	PC	Name	Bank	GM2
121	2	124	Door Creak	SFX	√
121	3	124	Door	SFX	√
121	4	124	Scratch	SFX	√
121	5	124	Wind Chime	SFX	√
121	0	125	Helicopter GM	SFX	√
121	1	125	Car Engine	SFX	√
121	2	125	Car Stop	SFX	√
121	3	125	Car Pass	SFX	√
121	4	125	Car Crash	SFX	√
121	5	125	Siren	SFX	√
121	6	125	Train	SFX	√
121	7	125	Jet Plane	SFX	√
121	8	125	Starship	SFX	√
121	9	125	Burst Noise	SFX	√
121	0	126	Applause GM	SFX	√
121	1	126	Laughing	SFX	√
121	2	126	Screaming	SFX	√

CC00	CC32	PC	Name	Bank	GM2
121	3	126	Punch	SFX	√
121	4	126	Heart Beat	SFX	√
121	5	126	Footsteps	SFX	√
121	6	126	Stadium	SFX	
121	0	127	Gun Shot GM	SFX	√
121	1	127	Machine Gun	SFX	√
121	2	127	Laser Gun	SFX	√
121	3	127	Explosion	SFX	√
123	7	16	Digital Drawbars	Digit.Drawbars	
121	64	0-127	...	User 1	
121	65	0-127	...	User 2	

DNC Sounds

The following table illustrates the DNC Sounds. **Note:** When a Performance contains Sounds making use of Sound Controllers 1 & 2 (SC1, SC2), these controllers are assigned to the Assignable Switches.

Sound name	CC00	CC32	PC	Legato	SC1	SC2	SCY+	SCY-	Cycle 1	Cycle 2	Random	AT Trg	Y+ Trg	Y- Trg	Res/Halo	
EP+Damper1 DNC (Electric Piano – P6)	121	25	4													•
	A classic Electric Piano, where pressing the Damper pedal adds two oscillators more (OSC #4 and #5) and totally different sounds (from the SFX bank). The Damper effect of a classic Electric Piano is also heard, thanks to the same principles of the Damper Resonance simulation.															
EP+Damper2 DNC (Electric Piano – P6)	121	26	4													•
	Press the Damper pedal to add Resonance, based on the same principles of the Grand Piano RX sound's Damper Resonance simulation.															
Harmonica DNC (Accordion – P6)	121	5	22		•	•	•	•	•			•				
	Cycle in action, again. The timbre smoothly changes from note to note. Use the Sound Controllers 1 to enable a Bend. Use the Sound Controller 2 to enable an Harmonics sound with a smoother attack, very handy when playing legato. Push the joystick forward to enable a swell attack. Pull the joystick back to slightly filter the sound, and hear a richer sound when the joystick is moved totally back. Several RX Noises are included. Press the Damper pedal down to hear the Breath sound.															
Jimmy Organ DNC (Organ – P10)	121	13	18	•												
	As in the authentic weighty monsters of the gone years, playing staccato or legato produce a different sound. The Percussion can only be heard when playing staccato. A nice modern touch is the additional Overdrive effect.															
Nylon Guitar DNC (Guitar – P20)	121	18	24	•	•	•							•			
	Legato playing allows for a smoother transition between notes. The Sound Controllers 1 and 2 will enable, respectively, the Slide Guitar or the Harmonics. Gradually pull the joystick back, and you will control the Body resonance. When releasing a key, you can clearly hear the release noise, and sometimes the Guitar Fret noise.															
Natural Nylon DNC (Guitar – P20)	121	19	24								•					
	Twelve oscillators playing randomly in turn. Since each oscillator is assigned a different multisample, or a different programming of the same multisample (Filter, Attack and Second Start parameters), this will result in a lively Guitar sound, capturing the infinite nuances of the fingering of a real guitar player.															
RealFolk Gtr DNC (Guitar – P20)	121	34	25	•	•	•							•			
	Legato playing allows for a smoother transition between notes. Use the Sound Controllers 1 and 2 to enable the Slide Guitar or Harmonics sounds. Press on the keys to activate the Vibrato. Pull the joystick back to trigger Body Noise. A typical Note Off sound is heard on Key Off. Sometimes the Guitar Fret noise can be heard.															
Steel Gtr DNC (Guitar – P21)	121	35	25	•												
	This Sound is very similar to Steel Gtr RX1, where a very complex sound is created by way of several velocity switches. This kind of Sound is very useful in Accompaniment tracks, thanks to the many nuances available (Harmonics, Mute, Slide...). Legato playing and other controls generate interesting timbral variations for better playability.															
Jazz Guitar DNC (Guitar – P21)	121	7	26	•	•	•	•									
	Legato playing allows for a smoother transition between notes. Use the Sound Controllers 1 and 2 to enable the Slide Gtr or Guitar Harmonic sounds. Push the joystick forward to trigger Auto Bending. When playing staccato, the Note Off noise is heard on Key Off.															
Crunch Gtr DNC (Guitar – P21)	121	3	29	•	•	•	•	•								
	Legato playing allows for a smoother transition between notes. Use the Sound Controllers 1 and 2 to enable the Slide Guitar or Mute Gtr sounds. Push the joystick forward to trigger a sound of Distorsion Gtr. Harmonics. Pull the joystick back to trigger Feedback. Sometimes the Guitar Fret noise can be heard.															
Movie Str.1 DNC (Strings/Vocals – P13)	121	7	49		•	•	•	•				•				
	This lush Orchestral Strings sound uses DNC controls to create a full set of performing situations. Push the joystick forward and you will hear the Strings Ensemble Tremolo sound. Or press the Sound Controller 1 or 2 to respectively enable the Viola or Pizzicato sounds. And when it's time for a resounding orchestral climax, press on the keys to activate the After Touch, and let the Timpani play. And, if the previous note was played with a velocity value higher than 70, the Orchestral Crash will play together with the Timpani. When it's time to step a little back, pull the joystick back to play a Violin.															
Movie Str.2 DNC (Strings/Vocals – P13)	121	8	49		•	•	•	•				•				
	As above, but in this case the Sound Controller 1 enables the Smooth Strings Ensemble sound.															
Scat Voices DNC (Strings/Vocals – P13)	121	20	52	•	•	•	•	•								
	Legato playing allows for a smoother transition between notes. Sound Controllers 1 and 2 will enable Bend Scat Voices or Slow Attack Choir sounds. Push the joystick forward to play different Scat Voices. Pull the joystick back to slightly filter the sound. The lower area of the keyboard plays a Scat Bass sound.															

Sound name	CC00	CC32	PC	Legato	SC1	SC2	SCY+	SCY-	Cycle 1	Cycle 2	Random	AT Trg	Y+ Trg	Y- Trg	Res/Halo
Trumpet DNC (Trump/Trbn – P6)	121	24	56	•	•	•	•							Filter	
Legato playing allows for a smoother transition between notes. You can also hear the typical Key On and Key Off noises. Use the Sound Controllers 1 and 2 to respectively hear the Trumpet's Doit and Fall DNC effects. Push the joystick forward to play a bending. The Breath DNC effect will play when pressing down the Damper pedal.															
Cornet DNC (Trump/Trbn – P6)	121	25	56	•	•	•	•							Filter	
Here, programming is very similar to the one seen for the Trumpet DNC Sound.															
Trombone DNC (Trump/Trbn – P7)	121	13	57	•	•	•	•							Filter	
Legato playing allows for a smoother transition between notes. The release noise is heard on Key Off. Use the Sound Controllers 1 and 2 to enable the Trombone Doit or Fall sounds. Push the joystick forward to trigger a bending. Press the Damper pedal down to hear the Breath sound.															
Alto Sax DNC (Sax – P5)	121	12	65	•	•	•	•							Filter	
Legato playing allows for a smoother transition between notes. Key On and Key Off noises can also be heard. Use the Sound Controllers 1 and 2 to enable the Soft Sax or Growl Sax sounds. Push the joystick forward to trigger a fall-down. Press the Damper pedal down to hear the Breath sound.															
Tenor Sax DNC (Sax – P5)	121	12	66	•	•	•	•							Filter	
Legato playing allows for a smoother transition between notes. Key On and Key Off noises can be heard. Use the Sound Controllers 1 and 2 to enable the Soft Sax or Straight Sax sounds. Push the joystick forward to trigger a fall-down. Press the Damper pedal down to hear the Breath sound.															
Clarinet DNC (Woodwinds – P7)	121	13	71	•	•	•	•	•							
Legato playing allows for a smoother transition between notes. Sound Controllers 1 and 2 will enable different bendings. Push the joystick forward to play a Clarinet with a crescendo attack. Pull the joystick back to slightly filter the sound, and hear a richer sound when the joystick is moved totally back. An RX Noise is heard on Key On and Key Off. Press the Damper pedal down to hear the Breath sound.															
Flute DNC (Woodwinds – P7)	121	11	73	•	•	•	•	•							
Legato playing allows for a smoother transition between notes. Sound Controllers 1 and 2 will enable Voice Flute or Frullato Flute sounds. Push the joystick forward to play Flute 5th. Pull the joystick back to play Octave Voice Flute. An RX Noise is heard on Key On and Key Off. Press the Damper pedal down to hear the Breath sound.															
Whistle DNC (Woodwinds – P8)	121	5	78		•	•	•								
You can use the Sound Controllers 1 and 2 to enable, respectively, the Gliss Whistle and the Sforzando Whistle DNC effects. By pushing the joystick forward while a note is sounding, you will listen a fall-down effect. The Whistle Breath will be randomly heard from time to time. Also, you can trigger it by just pressing down the Damper pedal.															
Wave Cycle DNC (Synth 1 Pad – P8)	121	3	96							•					
Cycle in action! Sixteen oscillators cycling between sixteen different synth sounds – a viable simulation of our timeless classic, the Wavestation.															
Finger Bass DNC (Bass – P13)	121	16	33	•	•	•	•	•							
Legato playing allows for a smoother transition between notes. Use the Sound Controllers 1 and 2 to enable the Slap Bass or Harmonics sounds. Push the joystick forward to trigger the Gliss Bass sound. Pull it back to trigger Bass Stop notes. A typical Note Off sound is heard on Key Off.															
Synth Kit (Drum/Perc – P8)	120	0	58												
A funny drum kit based on synthetic sounds.															

Drum Kits

The following table lists all Pa800 Factory Drum Kits in order of Bank Select-Program Change number.

Legend: The table also includes MIDI data used to remotely select the Drum Kits. **CC00:** Control Change 0, or Bank Select MSB. **CC32:** Control Change 32, or Bank Select LSB. **PC:** Program Change.

CC00	CC32	PC	Name	GM2
120	0	0	Standard Kit GM	√
120	0	1	Standard Kit RX2	
120	0	2	Standard Kit RX3	
120	0	3	Ambient Kit RX	
120	0	4	Pop Std. Kit RX	
120	0	5	Standard Kit RX1	
120	0	6	Standard Kit RX4	
120	0	7	Standard Kit 1	
120	0	8	Room Kit GM	√
120	0	9	HipHop Kit 1	
120	0	10	Jungle Kit	
120	0	11	Techno Kit 1	
120	0	12	Room Kit 2	
120	0	13	HipHop Kit 2	
120	0	14	Techno Kit 2	
120	0	15	Techno Kit 3	
120	0	16	Power Kit GM	√
120	0	17	Power Kit 2	
120	0	18	Power Kit RX1	
120	0	19	Power Kit RX2	
120	0	20-23 (remap to 16)		
120	0	24	Electro Kit GM	√
120	0	25	Analog Kit GM	√
120	0	26	House Kit 1	
120	0	27	House Kit 2	
120	0	28	House Kit 3	
120	0	29 (remap to 28)		
120	0	30	House Kit RX1	
120	0	31	House Kit RX2	
120	0	32	Jazz Kit GM	√
120	0	33	Jazz Kit RX1	
120	0	34	Jazz Kit RX2	
120	0	35	Jazz Kit RX3	
120	0	36-39 (remap to 32)		
120	0	40	Brush Kit GM	√
120	0	41	Brush Kit 2	
120	0	42	Brush Kit RX1	
120	0	43	Brush Kit RX2	
120	0	44	Brush Kit RX3	

CC00	CC32	PC	Name	GM2
120	0	45-47 (remap to 40)		
120	0	48	Orchestra Kit GM	√
120	0	49	Orchestra Kit GM	
120	0	50	Bdrum&Sdrum Kit	
120	0	51	Arabian Kit 1	
120	0	52-55 (remap to 48)		
120	0	56	SFX Kit GM	√
120	0	57	SFX Kit 2	
120	0	58	Synth Kit	
120	0	57-63 (remap to 56)		
120	0	64	Percussion Kit	
120	0	65	Latin Perc. Kit1	
120	0	66	Trinity Perc.Kit	
120	0	67	i30 Perc. Kit	
120	0	68	Latin Perc. Kit2	
120	0	69-71 (remap to 64)		
120	0	72	Hip Hop Kit RX	
120	0	73	Techno Kit RX	
120	0	74	Dance Kit RX	
120	0	75	Electro Kit RX1	
120	0	76	Electro Kit RX2	
120	0	77-88 (remap to 1)		
120	0	89	Pop Std. Kit 1	
120	0	90	Pop Std. Kit 2	
120	0	91 (remap to 3)		
120	0	92 (remap to 6)		
120	0	93-95 (remap to 1)		
120	0	96	Elektro Kit 1	
120	0	97	Elektro Kit 2	
120	0	98-115 (remap to 1)		
120	0	116 (remap to 51)		
120	0	117	Arabian Kit 2	
120	0	118	Turkish Kit	
120	0	119	Oriental PercKit	
120	0	120	Room Kit 1	
120	0	121	Power Kit 1	
120	0	122	Electro Kit	
120	0	123	Analog Kit	
120	0	124 (remap to 1)		
120	0	125	Brush Kit 1	
120	0	126-127 (remap to 1)		
			...	
120	64	0-63	User DrumKits (1-64)	

Multisamples

The following table lists all Pa800 Factory Multisamples.

* **OrigTune:** Original Tune, i.e., samples use the natural tuning of the original instrument, instead of the equal tuning. Beating may occur at the extreme pitch, when the sound is used in conjunction with other sounds.

0	GrandPiano_L	42	Gospel Organ Slow_L	84	E.Organ Full
1	GrandPiano_R	43	Gospel Organ Slow_R	85	E.Organ Dist
2	GrandPiano_L OrigTune	44	Gospel Organ Fast_L	86	Rotary Organ 1
3	GrandPiano_R OrigTune	45	Gospel Organ Fast_R	87	Rotary Organ 1LP
4	Tailpiece_L	46	16' 8' LF_L	88	Rotary Organ 2
5	Tailpiece_R	47	16' 8' LF_R	89	Super BX3
6	Tailpiece_L OrigTune	48	16' 8' LS_L	90	Super BX3LP
7	Tailpiece_R OrigTune	49	16' 8' LS_R	91	LeslieNoise LF_L
8	AcousticPiano_L	50	16' 8' 51/3 LF_L	92	LeslieNoise LF_R
9	AcousticPiano_R	51	16' 8' 51/3 LF_R	93	LeslieNoise LS_L
10	FX Pedal On_L	52	16' 8' 51/3 LS_L	94	LeslieNoise LS_R
11	FX Pedal On_R	53	16' 8' 51/3 LS_R	95	ON-Click (Organ)
12	FX Pedal Off_L	54	4' 22/3' 2' LF_L	96	OFF-Click (Organ)
13	FX Pedal Off_R	55	4' 22/3' 2' LF_R	97	Pipe Flute_L
14	FX Key Off_L	56	4' 22/3' 2' LS_L	98	Pipe Flute_R
15	FX Key Off_R	57	4' 22/3' 2' LS_R	99	Pipe Positive
16	M1 Piano	58	11/3' 13/5' 1' LF_L	100	Pipe Mixture
17	E.GrandPiano	59	11/3' 13/5' 1' LF_R	101	Pipe Full 1_L
18	E.Piano FM 1	60	11/3' 13/5' 1' LS_L	102	Pipe Full 1_R
19	E.Piano FM 1LP	61	11/3' 13/5' 1' LS_R	103	Pipe Full 2
20	E.Piano FM 2	62	16' 8' 51/3' Perc LF_L	104	E.Organ Church
21	E.Piano Suit Bright mp	63	16' 8' 51/3' Perc LF_R	105	Pipe Organ Tuentiana
22	E.Piano Suit Bright mf	64	16' 8' 51/3' Perc LS_L	106	Pipe Organ Reed
23	E.Piano Suit Bright f	65	16' 8' 51/3' Perc LS_R	107	Music Box
24	E.Piano Dyno mf	66	Theater Organ1	108	Music BoxLP
25	E.Piano Dyno f	67	Theater Org2	109	Kalimba
26	E.Piano Dyno ff	68	E.Organ CX 3	110	Marimba
27	E.Piano Dyno Soft	69	E.Organ Perc. O1W	111	MarimbaLP
28	E.Piano Dyno SoftLP	70	E.Organ Fast Click	112	Xylophone
29	E.Piano Stage Hard	71	E.Organ Perc. 1	113	Balaphone
30	E.Piano Stage HardLP	72	E.Organ Perc. 2	114	Vibraphone1
31	E.Piano Wurly Soft	73	E.Organ Perc. 3	115	Vibraphone1LP
32	E.Piano Wurly Hard	74	E.Organ Perc. 4	116	Vibraphone2
33	E.Piano Pad 1	75	M1 Organ1	117	Celesta
34	E.Piano Pad 1LP	76	M1 Organ2	118	CelestaLP
35	E.Piano Pad 2	77	Organ1	119	Glockenspiel
36	Clavi 1	78	Organ2	120	GlockenspielLP
37	Clavi 2	79	Organ2LP	121	Tubular Bell
38	Clavi 3	80	Organ3 Jazz	122	Log Drum
39	Clavi 4	81	BX3 & Perc. 3rd	123	Steel Drum Hard
40	Harpsichord	82	E.Organ Vox	124	Steel Drum HardLP
41	Harpsichord Key off	83	E.Organ Soft	125	Gamelan

126	FM Bell	175	Soprano Sax Vibrato	224	Pop Trumpet f
127	Flute	176	Soprano Sax Straight	225	Trumpet Expr.
128	Flute Frull	177	Sax Family Vibrato	226	Trumpet Slow mp
129	Voice Flute	178	French Musette	227	Trumpet Slow f
130	Jazz Flute	179	Musette1	228	Trumpet Tonguing mp
131	Flute Vibrato	180	Musette1LP	229	Trumpet Tonguing f
132	Flute Attack p	181	Accordion 16'	230	Trumpet Medium
133	Flute Attack f	182	Accordion 16' OrigTune	231	Trumpet Overblown
134	Piccolo	183	Accordion 8'	232	Trumpet Muted
135	Pan Flute	184	Accordion 8' OrigTune	233	Trumpet Wah wah
136	Pan Flute Attack	185	Accordion 4'	234	2 Trumpets mp _L
137	Tin Whistle	186	Accordion 4' OrigTune	235	2 Trumpets mp _R
138	Tin Whistle Voice	187	Accordion1	236	2 Trumpets f _L
139	Tin Whistle Attack	188	Accordion2	237	2 Trumpets f _R
140	Whistle Gliss	189	Fisa Bassoon	238	Trumpet Doit
141	Whistle No Vibr	190	Fisa Clarinet	239	Trumpet Fall
142	Whistle Sforz Vibr	191	Bandoneon	240	Stereo Brass Ensemble1_L
143	Whistle Sforz No Vibr	192	Volkst. Accordion	241	Stereo Brass Ensemble1_R
144	Whistle Slow Atk Vibr	193	Accordion Bass	242	Stereo Brass Ensemble2_L
145	Whistle Breath	194	Accordion Noise KeyOn	243	Stereo Brass Ensemble2_R
146	Shakuhachi	195	Accordion Noise KeyOff	244	Brass Ensemble1
147	Shakuhachi Atk	196	Accordion Change Voice	245	Brass Ensemble2
148	Bottle	197	Harmonica	246	Brass Ensemble2LP
149	Bottleizer	198	Harmonica Wah	247	Voice Female Wuuh
150	Recorder	199	Highland Bag Pipes	248	Voice Female Woh
151	Ocarina	200	Highland Drones	249	Voice Female Wah
152	Solo Clarinet	201	Uilleann Pipes	250	Voice Female Dah
153	Clarinet	202	Bag Pipes	251	Voice Male Wuh
154	Bass Clarinet	203	French Horn T1	252	Voice Male Woh
155	M1 DoubleReed	204	French Horn Ensemble	253	Voice Male Wah
156	Oboe	205	Flugel Horn Vibrato	254	Voice Male Dah
157	English Horn	206	Flugel Horn M1	255	Voice Scat Buh
158	Bassoon	207	Tuba f	256	Voice Scat Duh
159	Woodwind Ensemble	208	Tuba ff	257	Voice Scat Bah
160	Baritone Sax mf	209	Trombone Vibrato	258	Voice Scat Dah
161	Baritone Sax f	210	Trombone1 mf	259	Voice Choir
162	Baritone Sax Growl	211	Trombone1 ff	260	Voice Hoo
163	Tenor Sax Vibrato	212	Trombone2 Soft	261	Voice Pop Ooh
164	Tenor Sax Expressive	213	Trombone2 Bright	262	Voice Pop Ah
165	Tenor Sax mp	214	Trombone Muted	263	Doo Voice
166	Tenor Sax mf	215	2 Trombones mf _L	264	Doo VoiceLP
167	Tenor Sax Straight	216	2 Trombones mf _R	265	Solo Violin Vibrato
168	Tenor Sax M1	217	2 Trombones f _L	266	Violin
169	Alto Sax Vibrato1	218	2 Trombones f _R	267	Viola Expressive mf
170	Alto Sax Vibrato2	219	Trombone SlurUp	268	Viola Expressive ff
171	Alto Sax Vibrato2 Drive	220	Trombone Fall	269	Viola
172	Alto Sax p	221	Classic Trumpet p	270	Cello&Contrabass
173	Alto Sax mf	222	Classic Trumpet mf	271	Violin & Cello
174	Alto Sax Growl	223	Pop Trumpet mf	272	Strings Quartet

273	Strings Quartet Vibrato1	322	El. Guitar Le Mute p	371	E.Bass3 mf
274	Strings Quartet Vibrato2	323	El. Guitar Le Mute mf	372	E.Bass3 f Slap
275	Pizzicato	324	El. Guitar Le Ghost1	373	E.Bass4 Pick
276	StereoStrings Ensemble_L	325	El. Guitar Le Ghost2	374	E.Bass4 Harmo.
277	StereoStrings Ensemble_R	326	Tele Mute 5th pp	375	E.Bass4 Slap
278	Strings Ensemble	327	Tele Mute 5th p	376	E.Bass4 SlapHar
279	Strings Ensemble Tremolo	328	Tele Mute 5th mf	377	E.Bass4 LH Mute
280	Pizzicato Ensemble	329	Tele Mute 5th f	378	E.Bass4 RH Mute
281	Harp	330	Tele Mute 5th ff	379	E.Bass Gliss
282	Steel Guitar1 Pick p	331	Tele Mute 5th Key off	380	E.Bass Noise1
283	Steel Guitar1 Pick mf	332	El. Guitar Harmonics	381	E.Bass Noise2
284	Steel Guitar1 Pick f	333	El. Guitar Gliss Down	382	E.Bass5 Finger
285	Steel Guitar1 Mute	334	El. Guitar Gliss Up	383	E.Bass6 Finger
286	Steel Guitar1 Slide	335	El. Guitar Noise	384	E.Bass6 FingerLP
287	Steel Guitar2 p	336	El. Guitar Short Noise	385	E.Bass7 Finger
288	Steel Guitar2 mf	337	El. Guitar Fret Noise	386	E.Bass8 Pick
289	Steel Guitar2 f	338	Jazz Guitar1	387	E.Bass9 Pick Muted1
290	Steel Guitar2 Slap	339	Jazz Guitar2	388	E.Bass9 Pick Muted2
291	Steel Guitar2 Slide	340	Jazz Gib mellow p	389	E.Bass10 Pick
292	Nylon Guitar mp	341	Jazz Gib mellow mf	390	E.Bass10 PickLP
293	Nylon Guitar mf	342	Jazz Gib mellow f	391	E.Bass11 Thumb Bass
294	Nylon Guitar ff	343	Pedal Steel Guitar	392	E.Bass12 SlapBassThumb
295	Nylon GuitarAtk	344	Resonator Guitar	393	E.Bass12 SlapBassThumbLP
296	Ac. Guitar 12 Strings	345	Dist. Guitar	394	Fretless Bass 1
297	Ac. Guitar Harmonics1	346	Dist. Guitar1 Harmo.	395	Bass Harmonics
298	Ac. Guitar Harmonics2	347	Dist. Guitar2 Harmo.	396	Bass HarmonicsLP
299	Ac. Guitar Noise	348	Dist. Guitar2 Mute1	397	Sitar1
300	Guitar Fret Noise Off	349	Dist. Guitar2 Mute2	398	Sitar2
301	Guitar Noise Off	350	El. Guitar DistMuted p	399	Sitar & Tambura
302	Guitar Body	351	El. Guitar DistMuted mp	400	Santur
303	Guitar Noise Attack Off	352	El. Guitar PowerChord1	401	SanturLP
304	El. Guitar Stra 54 p	353	El. Guitar PowerChord2	402	Tambura
305	El. Guitar Stra 54 mf	354	El. Guitar PowerChord3	403	TamburaLP
306	El. Guitar Stra 54 f	355	Acoustic Bass1	404	Bouzouki
307	El. Guitar Tel Mid p	356	Acoustic Bass2 mf	405	BouzoukiLP
308	El. Guitar Tel Mid mf	357	Acoustic Bass2 f	406	Mandolin
309	El. Guitar Tel Mid f	358	Acoustic Bass3 mp	407	MandolinLP
310	El. Guitar Tel Bridge p	359	Acoustic Bass3 mp VAR	408	Mandolin Tremolo
311	El. Guitar Tel Bridge mf	360	Acoustic Bass3 mf	409	Mandolin Ensemble
312	El. Guitar Tel Bridge f	361	Acoustic Bass3 mf VAR	410	Banjo
313	El. Guitar Fend. Slide	362	Acoustic Bass3 f	411	BanjoLP
314	Clean Guitar Str p	363	Acoustic Bass3 f VAR	412	Ukulele
315	Clean Guitar Str f	364	E.Bass1 Finger	413	Shamisen
316	Clean Guitar Mute	365	E.Bass2 P.B.1	414	Koto
317	Clean Guitar Dead	366	E.Bass2 P.B.2	415	M.E. Oud
318	Clean Guitar Slap	367	E.Bass2 LH Stop	416	M.E. Oud Tek
319	Clean Guitar Slide	368	E.Bass2 RH Stop	417	M.E. Kanun1
320	El. Guitar Le Neck	369	E.Bass2 Harmo.	418	M.E. Kanun2
321	El. Guitar Le Bridge	370	E.Bass3 p	419	M.E. Kanun Tremolo

420	M.E. Baglama1	469	Gamelan XEQ	518	Bubble
421	M.E. Baglama2	470	Saw1	519	Dog
422	M.E. Zurna	471	Saw2	520	Gallop
423	M.E. Clarinet Tek	472	Saw3	521	Laughing
424	M.E. Clarinet	473	Pulse 02%	522	Telephone Ring
425	M.E. Nay	474	Pulse 05%	523	Scream
426	Mouth Harp1	475	Pulse 08%	524	Punch
427	Mouth Harp2	476	Pulse 16%	525	Heart Beat
428	Mouth Harp3	477	Pulse 33%	526	Footstep1
429	Mouth Harp4	478	Pulse 40%	527	Footstep2
430	Mouth Harp5	479	Square	528	Door Creak
431	Syn Flute Pad	480	Square MG	529	Door Slam
432	Syn Bass Reso1	481	Square JP	530	Car Engine
433	Syn Bass FM1	482	Triangle MG	531	Car EngineLP
434	Syn Bass FM1LP	483	Ramp	532	Car Stop
435	Syn Bass FM2	484	Ramp MG	533	Car Pass
436	Syn Bass FM2LP	485	Sine	534	Car Crash
437	Syn Bass TB	486	DWGS Syn Sine1	535	Train
438	RB Saw Bass	487	DWGS Syn Sine2	536	Helicopter
439	RB Square Bass	488	DWGS Organ1	537	Gun Shot
440	Chrom Res	489	DWGS Organ2	538	Machine Gun
441	Detuned Super	490	DWGS Bell1	539	Laser Gun
442	Detuned PWM	491	DWGS Bell2	540	Explosion
443	Synth Brass	492	DWGS Bell3	541	Wind
444	An.Strings1	493	DWGS Bell4	542	Timpani
445	An.Strings2	494	DWGS Clav.	543	Crash
446	Analog Vintage	495	DWGS Digi1	544	Crash Reverse
447	White Pad	496	DWGS Digi2	545	Orchestra Crash
448	N1 Air Vox	497	DWGS Wire1	546	Ride Jazz
449	Ether Bell	498	DWGS Wire2	547	Ride Edge1
450	Ether BellLP	499	DWGS Sync1	548	Ride Edge2
451	Lore	500	DWGS Sync2	549	HiHat Closed
452	Lore NT	501	DWGS Sync3	550	88 HiHat Open
453	Space Lore	502	Orchestra Hit	551	88 Cowbell
454	Wave Sweep1	503	Band Hit	552	88 Tom
455	Wave Sweep2	504	Impact Hit	553	88 Conga
456	Wave Sweep3	505	Brass Fall	554	88 Crash
457	Syn Ghostly	506	Vox Wah Gtr	555	Tom
458	Ghost	507	Vibe Chord	556	Tom Brush
459	Syn Air Pad	508	Zap1	557	Tom Process
460	Dream Str	509	Zap2	558	Electric Tom
461	Syn AirVortex	510	Stadium	559	Flexatone
462	Syn Palawan	511	Applause	560	Tambourine
463	Syn Clicker	512	Birds1	561	Agogo Bell
464	Cricket Spectrum	513	Birds2	562	Meditation Tree
465	Noise1	514	Crickets	563	Marc Tree
466	Noise2	515	Church Bell	564	Marc TreeLP
467	Noise Pad	516	Thunder	565	Cowbell
468	Swish Terra	517	Stream	566	Click

567	Temple Blocks	580	Cowbell & Claves	593	Stereo Snare1_L
568	Orchestra BD	581	Cabasa	594	Stereo Snare1_R
569	Castanet	582	Shaker	595	Stereo Snare2_L
570	Taiko	583	Cabasa & Shaker	596	Stereo Snare2_R
571	Djembe Open	584	Dumbek - Djambe - Udu	597	Large1_L
572	Djembe Mute	585	Caxixi	598	Large1_R
573	Chinese Gong	586	Tabla & Baya	599	Large2_L
574	Snare Ghost	587	WoodBlock & Castanet	600	Large2_R
575	Rain Stick	588	Mix Latin Perc	601	Large3_L
576	Congas	589	Kangaroo	602	Large3_R
577	Quinto & Bongos	590	DJ Eddie Set	603	Large4_L
578	Okonkolo	591	Stereo Snares1&2_L	604	Large4_R
579	Timbales	592	Stereo Snares1&2_R	605	Empty

Drum Samples

The following table lists all Pa800 Factory Drum Samples.

#	Sample	Family
0	BD Acoustic1 p	1
1	BD Acoustic1 mf	1
2	BD Acoustic1 f	1
3	BD Acoustic2 mf	1
4	BD Acoustic2 f	1
5	BD open p	1
6	BD open mf	1
7	BD open f	1
8	BD Peak	1
9	BD Dry 1	1
10	BD Dry 2	1
11	BD Dry 3	1
12	BD Normal	1
13	BD SoftRoom	1
14	BD Jazz	1
15	BD Pillow	1
16	BD Woofer	1
17	BD MondoKill	1
18	BD Terminator	1
19	BD Tubby	1
20	BD Gated	1
21	BD Tight	1
22	BD Squash	1
23	BD Black&Soul 1	1
24	BD Black&Soul 2	1
25	BD Black&Soul 3 dist	1
26	BD Black&Soul 4 noise	1
27	BD Black&Soul 5 Long	1
28	BD Black&Soul 6	1
29	BD Dance 1	1
30	BD Dance 2	1
31	BD Dance 3	1
32	BD House 1	1
33	BD House 2	1
34	BD House 3	1
35	BD House 4	1
36	BD House 5	1
37	BD Liquid	1
38	BD Techno 1	1
39	BD Techno 2	1
40	BD Hip 1	1
41	BD Hip 2	1
42	BD Hip 3	1
43	BD Hip 4	1
44	BD Kick1	1
45	BD Kick2	1
46	BD Ambient	1
47	BD Ambient Crackle	1
48	BD Ambient Rocker	1
49	BD Pop	1
50	BD Deep	1
51	BD Klanger	1
52	BD Electribe01	1
53	BD Electribe02	1
54	BD Electribe03	1

#	Sample	Family
55	BD Electribe04	1
56	BD Electribe05	1
57	BD Electribe06	1
58	BD Electribe07	1
59	BD Electribe08	1
60	BD Electribe09	1
61	BD Electribe10	1
62	BD Electribe11	1
63	BD Electribe12	1
64	BD Electribe13	1
65	BD Electribe14	1
66	BD Electribe15	1
67	BD Electribe16	1
68	BD Electribe17	1
69	Syn. BD1	1
70	Syn. BD2	1
71	Syn. BD3	1
72	Syn. BD4	1
73	Syn. BD Buzz	1
74	88 BD	1
75	BD Orchestra	1
76	SD Wood1 p	2
77	SD Wood1 mf	2
78	SD Wood1 f	2
79	SD Wood2 pp	2
80	SD Wood2 p	2
81	SD Wood2 mf	2
82	SD Wood2 f	2
83	SD Piccolo1 pp	2
84	SD Piccolo1 p	2
85	SD Piccolo1 mf	2
86	SD Piccolo1 f	2
87	SD Piccolo2 pp	2
88	SD Piccolo2 p	2
89	SD Piccolo2 mf	2
90	SD Piccolo2 f	2
91	SD Solid1 p	2
92	SD Solid1 mf	2
93	SD Solid1 f	2
94	SD Solid2 p	2
95	SD Solid2 mf	2
96	SD Solid2 f	2
97	SD Maple1 pp	2
98	SD Maple1 p	2
99	SD Maple1 mp	2
100	SD Maple1 mf	2
101	SD Maple1 f	2
102	SD Maple1 ff	2
103	SD Maple2 pp	2
104	SD Maple2 p	2
105	SD Maple2 mp	2
106	SD Maple2 mf	2
107	SD Maple2 f	2
108	SD Maple2 ff	2
109	SD Brass1 p	2
110	SD Brass1 mf	2
111	SD Brass1 f	2
112	SD Brass2 p	2

#	Sample	Family
113	SD Brass2 mf	2
114	SD Brass2 f	2
115	SD Roll	2
116	SD Ghost Roll	2
117	SD Ghost p	2
118	SD Ghost f	2
119	SD Snr Ghost1 a	2
120	SD Snr Ghost1 b	2
121	SD Snr Ghost2 a	2
122	SD Snr Ghost2 b	2
123	SD Snr Ghost2 c	2
124	SD Snr Signature p	2
125	SD Snr Signature mf	2
126	SD Snr Signature f	2
127	SD Snr Signature Rim mf	2
128	SD Snr Signature Rim f	2
129	SD Snr Signature Rim1	2
130	SD Snr Signature Rim2	2
131	Brush SD1 (swirl1)	2
132	Brush SD1 (swirl2)	2
133	Brush SD1 (swirl3)	2
134	Brush SD1 (swirl4)	2
135	Brush SD1	2
136	Brush SD2 (ghost1)	2
137	Brush SD2 (ghost2)	2
138	Brush SD2 (ghost3)	2
139	Brush SD2	2
140	Brush SD2 (fill) 4 shots	2
141	Brush SD2 (fill) 3 shots	2
142	Brush SD2 (fill) 2 shots	2
143	Brush SD3 Hit	2
144	Brush SD3 Tap1	2
145	Brush SD3 Tap2	2
146	Brush SD3 Swirl	2
147	SD Dry 1	2
148	SD Dry 2	2
149	SD Dry 3	2
150	SD Full Room	2
151	SD Off Center	2
152	SD Jazz Ring	2
153	SD Amb.Piccolo	2
154	SD Paper	2
155	SD Big Rock	2
156	SD Yowie	2
157	SD Trinity1	2
158	SD Trinity2	2
159	SD Stereo Gate	2
160	SD Processed	2
161	SD Cracker Room	2
162	SD Dance01	2
163	SD Dance02	2
164	SD Dance03	2
165	SD Dance04	2
166	SD Dance05	2
167	SD Dance06	2
168	SD Dance07	2
169	SD Dance08	2
170	SD Dance09	2

#	Sample	Family
171	SD Dance10	2
172	SD Dance11	2
173	SD Dance12	2
174	SD Dance13	2
175	SD Dance14	2
176	SD Dance15	2
177	SD Dance16	2
178	SD Dance17	2
179	SD Dance18	2
180	SD Dance19	2
181	SD Dance20	2
182	SD Dance21	2
183	SD Dance22	2
184	SD Dance23	2
185	SD Dance24	2
186	SD House1	2
187	SD House2	2
188	SD House3	2
189	SD House4	2
190	SD (BeatBox)	2
191	SD El. Funk1	2
192	SD El. Funk2	2
193	SD El. Funk3	2
194	SD Small	2
195	SD Rap	2
196	SD Noise	2
197	SD Reverse	2
198	SD Hip1	2
199	SD Hip2	2
200	SD Hip3	2
201	SD Hip4	2
202	SD Hip5	2
203	SD Hip6	2
204	SD Ringy	2
205	SD Tiny	2
206	SD Vintage1	2
207	SD Vintage2	2
208	SD Vintage3	2
209	SD Vintage4	2
210	SD Vintage5	2
211	SD Vintage6	2
212	SD AmbiHop	2
213	SD Brassier	2
214	SD Chili	2
215	SD Whopper	2
216	Syn. SD1	2
217	Syn. SD2	2
218	Syn. SD3	2
219	Syn. SD4	2
220	88 SD	2
221	99 SD	2
222	SD Orchestra	2
223	SD Orch. Roll	2
224	Rim Snr Signature Hi	2
225	Rim Snr Signature Mid	2
226	Rim Snr Signature Low	2
227	Rim Shot p	2
228	Rim Shot f	2
229	Rim House1	2
230	Rim House2	2
231	Rim Synth	2
232	RimTamb Synth	2

#	Sample	Family
233	Syn. Rim Click	2
234	88 Rim Shot	2
235	Sidestick mf	2
236	Sidestick f	2
237	Sidestick Dance	2
238	SideStick Dry	2
239	SideStick Amb	2
240	DrumStick Hit	2
241	FX SD Large Hall1	2
242	FX SD Large Hall2	2
243	FX Rim Large Hall1	2
244	FX Rim Large Hall2	2
245	Tom1 Open Hi p	4
246	Tom1 Open Hi p flam	4
247	Tom1 Open Hi f	4
248	Tom1 Open Hi f flam	4
249	Tom1 Open Mid p	4
250	Tom1 Open Mid p flam	4
251	Tom1 Open Mid f	4
252	Tom1 Open Mid f flam	4
253	Tom1 Open Low p	4
254	Tom1 Open Low p flam	4
255	Tom1 Open Low f	4
256	Tom1 Open Low f flam	4
257	Tom1 Open Floor p	4
258	Tom1 Open Floor p flam	4
259	Tom1 Open Floor f	4
260	Tom1 Open Floor f flam	4
261	Tom2 Hi p	4
262	Tom2 Hi f	4
263	Tom2 Mid p	4
264	Tom2 Mid f	4
265	Tom2 Low p	4
266	Tom2 Low f	4
267	Tom2 Floor p	4
268	Tom2 Floor f	4
269	Tom3 Hi	4
270	Tom3 Floor	4
271	Tom4 Hi	4
272	Tom4 Low	4
273	Tom4 Floor	4
274	Tom5 Hi	4
275	Tom5 Low	4
276	Tom6 Vintage Hi mp	4
277	Tom6 Vintage Hi mf	4
278	Tom6 Vintage Hi ff	4
279	Tom6 Vintage Mid mp	4
280	Tom6 Vintage Mid mf	4
281	Tom6 Vintage Mid ff	4
282	Tom6 Vintage Lo mp	4
283	Tom6 Vintage Lo mf	4
284	Tom6 Vintage Lo ff	4
285	Tom Processed	4
286	Tom Jazz Hi	4
287	Tom Jazz Floor	4
288	Tom Brush1 (sd open)	4
289	Tom Brush1 (sd close)	4
290	Tom Brush2 (sd open)	4
291	Tom Brush2 (sd close)	4
292	Tom Brush3 Hi mf	4
293	Tom Brush3 Hi ff	4
294	Tom Brush3 Mid mf	4

#	Sample	Family
295	Tom Brush3 Mid ff	4
296	Tom Brush3 Low mf	4
297	Tom Brush3 Low ff	4
298	Tom Brush4	4
299	88 Tom	4
300	E.Tom FM	4
301	E.Tom Real	4
302	HH1 Closed pp	3
303	HH1 Closed p	3
304	HH1 Closed mf	3
305	HH1 Closed f	3
306	HH1 Foot mp	3
307	HH1 Foot mf	3
308	HH1 Open mp	3
309	HH1 Open mf	3
310	HH2 Closed pp	3
311	HH2 Closed p	3
312	HH2 Closed mp	3
313	HH2 Closed mf	3
314	HH2 Closed f	3
315	HH2 Closed ff	3
316	HH2 Foot p	3
317	HH2 Foot f	3
318	HH2 Open p	3
319	HH2 Open f	3
320	HH3 Closed1	3
321	HH3 Closed2	3
322	HH3 Foot	3
323	HH3 Open1	3
324	HH3 Open2	3
325	HH3 Sizzle	3
326	HH4 Closed1	3
327	HH4 Closed2	3
328	HH4 Foot	3
329	HH4 FootOpen	3
330	HH4 Open	3
331	HH Old Close1	3
332	HH Old Open1	3
333	HH Old TiteClose	3
334	HH Old Close2	3
335	HH Old Open2	3
336	HH House Open1	3
337	HH House Open2	3
338	HH Hip	3
339	HH Alpo Close	3
340	HH Dance1	3
341	HH Dance2	3
342	88 HH Close	3
343	88 HH Open	3
344	99 HH Close	3
345	99 HH Open	3
346	Syn. HH Closed	3
347	Syn. HH Open	3
348	Crash 15'edge1	5
349	Crash 15'edge2	5
350	Crash 17'edge1	5
351	Crash 17'edge2	5
352	Crash 19'open1	5
353	Crash 19'open2	5
354	Crash 1	5
355	Crash 2	5
356	Crash Reverse	5

#	Sample	Family
357	Crash Dance 99	5
358	Crash DDD-1	5
359	88 Crash	5
360	Splash 8'edge1	5
361	Splash 8'edge2	5
362	Splash	5
363	China	5
364	Ride 20' mp1	5
365	Ride 20' mp2	5
366	Ride 20' mf1	5
367	Ride 20' mf2	5
368	Ride Edge1	5
369	Ride Edge2	5
370	Ride Cup	5
371	Ride Jazz	5
372	Ride Brush1	5
373	Ride Brush2	5
374	Ride Brush3	5
375	Ride Rivet	5
376	99 Ride Dance	5
377	Orchestra Cymbal	5
378	Finger Snaps	6
379	Claps1	6
380	Claps2	6
381	Claps3	6
382	Claps4	6
383	88 Claps	6
384	Dance Claps1	6
385	Dance Claps2	6
386	Dance Claps3	6
387	Dance Claps4	6
388	Dance Claps5	6
389	Dance Claps6	6
390	Dance Conga1 Lo-Open	6
391	Dance Conga1 Hi-Open	6
392	Dance Tambourine	7
393	88 Conga	6
394	88 Claves	6
395	88 Cowbell	7
396	88 Maracas	7
397	Syn. Bongo1	6
398	Syn. Bongo2	6
399	Syn. Castanet	6
400	Syn. Shaker	7
401	Syn. Noise	8
402	Syn. FX1	8
403	Syn. FX2	8
404	Syn. FX3	8
405	Syn. FX4	8
406	Syn. FX5	8
407	Syn. Perc. Ahh	8
408	Boom	8
409	Zap1	8
410	Zap2	8
411	Vinyl Hit	8
412	DJ Vinyl Sliced 01	8
413	DJ Vinyl Sliced 02	8
414	DJ Vinyl Sliced 03	8
415	DJ Vinyl Sliced 04	8
416	DJ Vinyl Sliced 05	8
417	DJ Vinyl Sliced 06	8
418	DJ Vinyl Sliced 07	8

#	Sample	Family
419	DJ Vinyl Sliced 08	8
420	DJ Vinyl Sliced 09	8
421	DJ Vinyl Sliced 10	8
422	DJ Vinyl Sliced 11	8
423	DJ Vinyl Sliced 12	8
424	DJ Vinyl Sliced 13	8
425	DJ Vinyl Sliced 14	8
426	DJ Vinyl Sliced 15	8
427	DJ Vinyl Sliced 16	8
428	DJ Vinyl Sliced 17	8
429	DJ Vinyl Sliced 18	8
430	DJ Vinyl Sliced 19	8
431	DJ Vinyl Sliced 20	8
432	DJ Vinyl Sliced 21	8
433	DJ Vinyl Sliced 22	8
434	DJ Vinyl Sliced 23	8
435	DJ Vinyl Sliced 24	8
436	DJ Scratch 01	8
437	DJ Scratch 02	8
438	DJ Scratch 03	8
439	DJ Scratch 04	8
440	DJ Scratch 05	8
441	DJ Scratch 06	8
442	DJ Hit Rub	8
443	DJ Vocal Rub1	8
444	DJ Vocal Rub2	8
445	DJ BD Rub	8
446	DJ SD Rub	8
447	Guero Long	6
448	Guero Short	6
449	Vibraslap	7
450	Samba Whistle	7
451	Cuica Hi	6
452	Cuica Lo	6
453	Tumba Open1 mf	6
454	Tumba Open1 f	6
455	Tumba Open2 mf	6
456	Tumba Open2 f	6
457	Tumba Open Flam	6
458	Tumba Glissando	6
459	Tumba Basstone	6
460	Tumba O.Slap Flam mf	6
461	Tumba O.Slap Flam f	6
462	Tumba Muffled	6
463	Conga1 Lo Basstone	6
464	Conga1 Lo Open mf	6
465	Conga1 Lo Open Slap	6
466	Conga1 Lo Glissando	6
467	Conga1 Lo Muffled	6
468	Conga1 Lo Closed	6
469	Conga1 Lo Closed Slap	6
470	Conga1 Lo Heel	6
471	Conga1 Lo Toe	6
472	Conga1 Hi Basstone mf	6
473	Conga1 Hi Basstone f	6
474	Conga1 Hi Open mf	6
475	Conga1 Hi Open Slap	6
476	Conga1 Hi Muffled	6
477	Conga1 Hi Closed	6
478	Conga1 Hi Closed Slap	6
479	Conga1 Hi Heel	6
480	Conga1 Hi Toe	6

#	Sample	Family
481	Conga2 Lo Open	6
482	Conga2 Lo Mt Slap	6
483	Conga2 Lo Slap	6
484	Conga2 Hi Open	6
485	Conga2 Hi Mute	6
486	Conga2 Hi Mt Slap	6
487	Conga2 Hi Slap1	6
488	Conga2 Hi Slap2	6
489	Conga2 Heel	6
490	Conga2 Toe	6
491	Quinto1 Open	6
492	Quinto1 Closed	6
493	Quinto1 Closed Slap	6
494	Quinto1 Toe	6
495	Quinto2 Basstone	6
496	Quinto2 Open mp	6
497	Quinto2 Open Flam	6
498	Quinto2 Open Slap	6
499	Quinto2 Muffled	6
500	Quinto2 C.Slap Flam p	6
501	Quinto2 C.Slap Flam f	6
502	Quinto2 Heel	6
503	Bongo1 Lo Muffled mp	6
504	Bongo1 Lo Muffled f	6
505	Bongo1 Lo Closed	6
506	Bongo1 Lo Flam	6
507	Bongo1 Lo MuffledFlam	6
508	Bongo1 Lo Stick	6
509	Bongo1 Lo StickEdge mf	6
510	Bongo1 Lo StickEdge f	6
511	Bongo1 Lo StickBounce	6
512	Bongo1 Lo Fingernail	6
513	Bongo1 Lo Cuptone	6
514	Bongo1 Lo Slap	6
515	Bongo1 Hi Open mf	6
516	Bongo1 Hi Open f	6
517	Bongo1 Hi Pops	6
518	Bongo1 Hi Hightone	6
519	Bongo1 Hi OpenFlam	6
520	Bongo1 Hi Fingernail	6
521	Bongo1 Hi Stick	6
522	Bongo1 Hi StickEdge mf	6
523	Bongo1 Hi StickEdge f	6
524	Bongo1 Hi StickBounce	6
525	Bongo1 Hi Cuptone	6
526	Bongo1 Hi Slap	6
527	Bongo2 Lo Open a	6
528	Bongo2 Lo Open b	6
529	Bongo2 Lo Mute	6
530	Bongo2 Hi Open a	6
531	Bongo2 Hi Open b	6
532	Bongo2 Hi Muffled	6
533	Bongo2 Hi Slap	6
534	Bongo2 Lo Heel	6
535	Bongo2 Lo Muffled	6
536	Bongo3 Lo Open	6
537	Bongo3 Lo Slap	6
538	Bongo3 Lo Stick	6
539	Bongo3 Hi Open	6
540	Bongo3 Hi Slap	6
541	Bongo3 Hi Stick1	6
542	Bongo3 Hi Stick2	6

#	Sample	Family
543	Okonkolo Boca Open mp	6
544	Okonkolo Boca Open mf	6
545	Okonkolo Boca Open f	6
546	Okonkolo Boca Open ff	6
547	Okonkolo Chacha Open mp	6
548	Okonkolo Chacha Open mf	6
549	Okonkolo Chacha Open f	6
550	Okonkolo Chacha Open ff	6
551	Okonkolo Chacha Slap mp	6
552	Okonkolo Chacha Slap mf	6
553	Okonkolo Chacha Slap f	6
554	Baya Open	6
555	Baya Ghe	6
556	Baya GheUp a	6
557	Baya GheUp b	6
558	Baya KaPalm	6
559	Baya KaToe a	6
560	Baya KaToe b	6
561	Baya Nail a	6
562	Baya Nail b	6
563	Baya Nail c	6
564	Baya Ge	6
565	Baya Up	6
566	Baya UpDown a	6
567	Baya UpDown b	6
568	Baya Mute1	6
569	Baya Mute2	6
570	Baya Mute3	6
571	Tabla1 Na	6
572	Tabla1 Open	6
573	Tabla1 Tin	6
574	Tabla1 Mute1	6
575	Tabla1 Mute2	6
576	Tabla1 Mute3	6
577	Tabla2 Tin a	6
578	Tabla2 Tin b	6
579	Tabla2 Na a	6
580	Tabla2 Na b	6
581	Tabla2 Na c	6
582	Tabla2 Tun a	6
583	Tabla2 Tun b	6
584	Tabla2 Tele a	6
585	Tabla2 Tele b	6
586	Tabla2 Tele c	6
587	Tabla2 Ti a	6
588	Tabla2 Ti b	6
589	Tabla2 Ti c	6
590	Tabla2 Tera	6
591	Taiko Open	6
592	Taiko Rim	6
593	Timbales1 Lo Open mp	6
594	Timbales1 Lo Open mf	6
595	Timbales1 Lo Edge mf	6
596	Timbales1 Lo Edge f	6
597	Timbales1 Lo RimShot	6
598	Timbales1 Lo Abanico	6
599	Timbales1 Lo Roll	6
600	Timbales1 Lo Mute mf	6
601	Timbales1 Lo Mute f	6
602	Timbales1 Lo Paila mf	7
603	Timbales1 Lo Paila f	7
604	Timbales1 Hi Open	6

#	Sample	Family
605	Timbales1 Hi Edge	6
606	Timbales1 Hi RimShot mf	6
607	Timbales1 Hi RimShot f	6
608	Timbales1 Hi RimShot ff	6
609	Timbales1 Hi Abanico1	6
610	Timbales1 Hi Abanico2	6
611	Timbales1 Hi Mute	6
612	Timbales1 Hi Paila mf	7
613	Timbales1 Hi Paila f	7
614	Timbales2 Lo Open	6
615	Timbales2 Lo Mute	6
616	Timbales2 Lo Rim	6
617	Timbales2 Hi Edge	6
618	Timbales2 Hi Rim1	6
619	Timbales2 Hi Rim2	6
620	Timbales2 Paila	7
621	Cowbell1	7
622	Cowbell2	7
623	Cowbell3	7
624	Cowbell4 Open	7
625	Cowbell4 Mute	7
626	Cowbell5 Open a	7
627	Cowbell5 Open b	7
628	Cowbell5 Mute	7
629	Cowbell6	7
630	Agogo Bell	7
631	Chacha Bell	7
632	Mambo Bell	7
633	Triangle Open	7
634	Triangle Mute	7
635	Sleigh Bell	7
636	Rap Sleigh Bell	7
637	Jingle Bell	7
638	Bells Open	7
639	Finger Cymbal	7
640	Marc Tree	7
641	Marc TreeLP	7
642	Flexatone	7
643	Chinese Gong	5
644	Claves1 Lo a	6
645	Claves1 Lo b	6
646	Claves1 Hi a	6
647	Claves1 Hi b	6
648	Claves2	6
649	Wood Block 1 a	6
650	Wood Block 1 b	6
651	Wood Block 2 a	6
652	Wood Block 2 b	6
653	Wood Block 3 a	6
654	Wood Block 3 b	6
655	Wood Block 4 a	6
656	Wood Block 4 b	6
657	Wood Block 5 a	6
658	Wood Block 5 b	6
659	Wood Block 6 a	6
660	Wood Block 6 b	6
661	Wood Block 7	6
662	Wood Block 8	6
663	Castanet 1 a	6
664	Castanet 1 b	6
665	Castanet 1 c	6
666	Castanet 2	6

#	Sample	Family
667	Castanet Single	6
668	Castanet Double	6
669	Timpani	1
670	Tsuzumi	6
671	Cabasa 1 L a Down	7
672	Cabasa 1 L a Up	7
673	Cabasa 1 L b Down	7
674	Cabasa 1 L b Up	7
675	Cabasa 1 S a Down	7
676	Cabasa 1 S a Up	7
677	Cabasa 1 S b Down	7
678	Cabasa 1 S b up	7
679	Cabasa 2 L Stack b	7
680	Cabasa 2 L Stack a	7
681	Cabasa 2 L Roll	7
682	Cabasa 2 S Stack a	7
683	Cabasa 2 S Stack b	7
684	Cabasa 2 S Roll	7
685	Cabasa 3 WS	7
686	Cabasa 3 Up	7
687	Cabasa 3 Down	7
688	Cabasa 3 Tap	7
689	Caxixi1 a	7
690	Caxixi1 b	7
691	Caxixi1 c	7
692	Caxixi2 a	7
693	Caxixi2 b	7
694	Caxixi2 c	7
695	Caxixi3 Hard	7
696	Caxixi3 Soft	7
697	Shaker1 Push a	7
698	Shaker1 Push b	7
699	Shaker1 Pull a	7
700	Shaker1 Pull b	7
701	Shaker1 Accent a	7
702	Shaker1 Accent b	7
703	Shaker1 Slow a	7
704	Shaker1 Slow b	7
705	Shaker1 Slow c	7
706	Shaker1 Roll a	7
707	Shaker1 Roll b	7
708	Shaker1 Roll c	7
709	Shaker2	7
710	Shaker3	7
711	Maracas Push	7
712	Maracas Pull	7
713	Dumbek a	6
714	Dumbek b	6
715	Dumbek c	6
716	Dumbek d	6
717	Dumbek e	6
718	Dumbek f	6
719	Dumbek g	6
720	Dumbek h	6
721	Dumbek i	6
722	Dumbek j	6
723	Dumbek k	6
724	Djembe L Basstone a	6
725	Djembe L Basstone b	6
726	Djembe L Basstone c	6
727	Djembe L Open	6
728	Djembe L OpenSlap	6

#	Sample	Family
729	Djembe L ClosedSlap	6
730	Djembe S Basstone a	6
731	Djembe S Basstone b	6
732	Djembe S Basstone c	6
733	Djembe Open	6
734	Djembe Mute	6
735	Djembe Slap	6
736	Djembe S Open	6
737	Djembe S Open Slap a	6
738	Djembe S Open Slap b	6
739	Djembe S Closed Slap a	6
740	Djembe S Closed Slap b	6
741	Djembe S Closed Slap c	6
742	Djembe Bass	6
743	Udu Open a	6
744	Udu Open b	6
745	Udu Open c	6
746	Udu Open d	6
747	Udu Slide a	7
748	Udu Slide b	7
749	Udu Half Open a	6
750	Udu Half Open b	6
751	Udu Half Open c	6
752	Udu Bell a	6
753	Udu Bell b	6
754	WD Brazillia1	2
755	WD Brazillia2	2
756	WD Ethno SD1	2
757	WD Ethno SD2	2
758	WD Ethno SD3	2
759	WD Ethno SD4	2
760	WD Ethno SD5	2
761	WD Ethno SD6	2
762	WD Kangaroo1	2
763	WD Kangaroo2	8
764	WD Kangaroo3	8
765	WD Kangaroo4	8
766	WD Kangaroo5	8
767	WD Kangaroo6	8
768	WD Kangaroo7	8
769	WD Kangaroo8	8
770	Tambourine Push	7
771	Tambourine Pull	7
772	Tambourine Acc1	7
773	Tambourine Acc2	7
774	Tambourine Mute1	6
775	Tambourine Mute2	6
776	Tambourine Open	6
777	M.E.1 Douf Rim Ak	6
778	M.E.1 Douf Tek Ak1	6
779	M.E.1 Douf Tek Ak2	6
780	M.E.1 Pand Open	6
781	M.E.1 Pand Pattern1	6
782	M.E.1 Pand Pattern2	6
783	M.E.1 Pand Pattern3	6
784	M.E.1 Pand Pattern4	6
785	M.E.1 Rek Dom Ak	7
786	M.E.1 Rek Jingle	7
787	M.E.1 Rik1	6
788	M.E.1 Rik2	6
789	M.E.1 Rik3	6
790	M.E.1 Sagat Half Open	7

#	Sample	Family
791	M.E.1 Sagat Close	7
792	M.E.1 Surdo L Mute	6
793	M.E.1 Surdo L Open	6
794	M.E.1 Tabla Medium	6
795	M.E.1 Tabla Dom	6
796	M.E.1 Tabla Flam	6
797	M.E.1 Tabla Rim	6
798	M.E.1 Tabla Tak	6
799	M.E.1 Timbales	7
800	M.E.1 Udu f Open	6
801	M.E.1 Alkis	6
802	M.E.1 Bandir Open	6
803	M.E.1 Bandir Closed	6
804	M.E.1 Bongo Roll	6
805	M.E.1 Darbuka1 Tek1	6
806	M.E.1 Darbuka1 Tek2	6
807	M.E.1 Darbuka1 Open	6
808	M.E.1 Darbuka1 Closed	6
809	M.E.1 Darbuka2	6
810	M.E.1 Darbuka3	6
811	M.E.1 Darbuka4	6
812	M.E.1 Darbuka D1	6
813	M.E.1 Darbuka D2	6
814	M.E.1 Darbuka D3	6
815	M.E.1 Darbuka5 D1	6
816	M.E.1 Darbuka5 D2	6
817	M.E.1 Darbuka5 D3	6
818	M.E.1 Darbuka6 Mute	6
819	M.E.1 Darbuka6 Open	7
820	M.E.1 Darbuka6 Rim	6
821	M.E.1 Darbuka6 Dom Ak	6
822	M.E.1 Kup1	6
823	M.E.1 Kup2	6
824	M.E.1 Ramazan Davul1	6
825	M.E.1 Ramazan Davul2	6
826	M.E.1 Ramazan Davul3	6
827	M.E.1 Tef1	7
828	M.E.1 Tef2	7
829	M.E.1 Tef3	7
830	M.E.2 BD Kick	1
831	M.E.2 SD	2
832	M.E.2 Asagum	6
833	M.E.2 Asmatek	6
834	M.E.2 Bendirgum	6
835	M.E.2 Bendirtek1	6
836	M.E.2 Bendirtek2	6
837	M.E.2 Dm1	6
838	M.E.2 Findik	6
839	M.E.2 Gum	6
840	M.E.2 Hollotokat	6
841	M.E.2 Islik1	8
842	M.E.2 Islik2	8
843	M.E.2 Kapital	6
844	M.E.2 Kasik1	6
845	M.E.2 Kasik2	6
846	M.E.2 Kasik3	6
847	M.E.2 Kasik4	6
848	M.E.2 Kemik	6
849	M.E.2 Kenar1	6
850	M.E.2 Kenartek	6
851	M.E.2 Ramazangum	6
852	M.E.2 Ramazantek	6

#	Sample	Family
853	M.E.2 Renk	6
854	M.E.2 Renkbir	6
855	M.E.2 Renkiki	6
856	M.E.2 Tefacik	6
857	M.E.2 Tefgum	6
858	M.E.2 Teftek1	6
859	M.E.2 Teftokat	6
860	M.E.2 Teftrill	6
861	M.E.2 Tefzil	6
862	M.E.2 Tek1	6
863	M.E.2 Tek2	6
864	M.E.2 Tekbir	6
865	M.E.2 Tokat	6
866	M.E.2 Toprgum	6
867	M.E.2 Toprtek1	6
868	M.E.2 Toprtek2	6
869	M.E.2 Toprtokat	6
870	M.E.2 TRILL1	6
871	M.E.2 Zil1	7
872	M.E.2 Zil2	7
873	M.E.2 Zil3	7
874	M.E.2 Zilgit	8
875	Orchestra Hit	8
876	Band Hit	8
877	Impact Hit	8
878	Metal Hit	8
879	Yeah!	8
880	Yeah! Solo	8
881	Uhh	8
882	Hit It	8
883	Uhhhh Solo	8
884	Comp Voice Noise	8
885	Stadium	8
886	Applause	8
887	Scream	8
888	Laughing	8
889	Footsteps1	8
890	Footsteps2	8
891	Click	8
892	Bird1	8
893	Bird2	8
894	Dog	8
895	Gallop	8
896	Crickets	8
897	Cat	8
898	Growl	8
899	Heart Beat	8
900	Punch	8
901	Tribe	8
902	Rainstick	8
903	Door Creak	8
904	Door Slam	8
905	Car Engine	8
906	Car Stop	8
907	Car Pass	8
908	Car Crash	8
909	Train	8
910	Helicopter	8
911	Gun Shot1	8
912	Gun Shot2	8
913	Machine Gun	8
914	Laser Gun	8

#	Sample	Family
915	Explosion	8
916	Thunder	8
917	Wind	8
918	Stream	8
919	Bubble	8
920	Church Bell	8
921	Telephone Ring	8
922	Xylophone Spectr	8
923	Cricket Spectrum	8
924	Air Vortex	8
925	Noise White	8
926	Noise FM Mod	8
927	Tubular	7
928	Gamelan	7
929	Tambura	7
930	Gtr Cut Noise1	8
931	Gtr Cut Noise2	8
932	Power Chord	8
933	Fret Noise	8
934	Dist. Slide1	8
935	Dist. Slide2	8
936	E.Gtr Pick1	8
937	E.Gtr Pick2	8
938	Gtr Scratch1	8
939	Gtr Scratch2	8
940	Amp Noise	8
941	Space Lore	8
942	Swish Terra	8
943	Hand Drill	8
944	Mouth Harp	8
945	Empty	1

Performances

All Performances are user-editable. Use the following table as a model for your own Performance lists.

Note: You can remotely select Performances on the Pa800, by sending it Bank Select MSB (CC#0), Bank Select LSB (CC#32) and Program Change messages on the Control channel (see "MIDI: MIDI In Channels" on page 225).

#	CC#0	CC#32	PC	Bank: 1	CC#0	CC#32	PC	Bank: 2	CC#0	CC#32	PC	Bank: 3	CC#0	CC#32	PC	Bank: 4
1	1	0	0		1	1	0		1	2	0		1	3	0	
2			1				1				1				1	
3			2				2				2				2	
4			3				3				3				3	
5			4				4				4				4	
6			5				5				5				5	
7			6				6				6				6	
8			7				7				7				7	
9			8				8				8				8	
10			9				9				9				9	
11			10				10				10				10	
12			11				11				11				11	
13			12				12				12				12	
14			13				13				13				13	
15			14				14				14				14	
16			15				15				15				15	
	CC#0	CC#32	PC	Bank: 5	CC#0	CC#32	PC	Bank: 6	CC#0	CC#32	PC	Bank: 7	CC#0	CC#32	PC	Bank: 8
1	1	4	0		1	5	0		1	6	0		1	7	0	
2			1				1				1				1	
3			2				2				2				2	
4			3				3				3				3	
5			4				4				4				4	
6			5				5				5				5	
7			6				6				6				6	
8			7				7				7				7	
9			8				8				8				8	
10			9				9				9				9	
11			10				10				10				10	
12			11				11				11				11	
13			12				12				12				12	
14			13				13				13				13	
15			14				14				14				14	
16			15				15				15				15	

	CC#0	CC#32	PC	Bank: 9	CC#0	CC#32	PC	Bank: 10	CC#0	CC#32	PC	Bank: 11	CC#0	CC#32	PC	Bank: 12
1	1	8	0		1	9	0		1	10	0		1	11	0	
2			1				1				1				1	
3			2				2				2				2	
4			3				3				3				3	
5			4				4				4				4	
6			5				5				5				5	
7			6				6				6				6	
8			7				7				7				7	
9			8				8				8				8	
10			9				9				9				9	
11			10				10				10				10	
12			11				11				11				11	
13			12				12				12				12	
14			13				13				13				13	
15			14				14				14				14	
16			15				15				15				15	
	CC#0	CC#32	PC	Bank: 13	CC#0	CC#32	PC	Bank: 14	CC#0	CC#32	PC	Bank: 15	CC#0	CC#32	PC	Bank: 16
1	1	12	0		1	13	0		1	14	0		1	15	0	
2			1				1				1				1	
3			2				2				2				2	
4			3				3				3				3	
5			4				4				4				4	
6			5				5				5				5	
7			6				6				6				6	
8			7				7				7				7	
9			8				8				8				8	
10			9				9				9				9	
11			10				10				10				10	
12			11				11				11				11	
13			12				12				12				12	
14			13				13				13				13	
15			14				14				14				14	
16			15				15				15				15	
	CC#0	CC#32	PC	Bank: 17	CC#0	CC#32	PC	Bank: 18	CC#0	CC#32	PC	Bank: 19	CC#0	CC#32	PC	Bank: 20
1	1	16	0		1	17	0		1	18	0		1	19	0	
2			1				1				1				1	
3			2				2				2				2	
4			3				3				3				3	
5			4				4				4				4	
6			5				5				5				5	
7			6				6				6				6	
8			7				7				7				7	
9			8				8				8				8	
10			9				9				9				9	
11			10				10				10				10	
12			11				11				11				11	
13			12				12				12				12	
14			13				13				13				13	
15			14				14				14				14	
16			15				15				15				15	

Pads

You can assign the following Hits or Sequences to the four Pads. Older sounds might be still assigned to the Pads when loading musical resources generated with an older operating system (see the following section).

#	HIT - Drum	#	HIT - Percussion	#	HIT - World 1	#	Hit - World 2	#	HIT - Orchestral	#	HIT - Synth&Pad
1	88 Cowbell	1	Agogo 1	1	Baja 1	1	Kup 1	1	Brass Fall	1	Cosmic
2	88 Crash	2	Agogo 2	2	Baja 2	2	Kup 2	2	Orch.Cymbal 1	2	VCF Modulation
3	China	3	Castanet 1	3	China Gong	3	Kup 3	3	Orch.Cymbal 2	3	Planet Lead
4	Crash 1	4	Castanet 2	4	Darbuka 1	4	Kup 4	4	Orch. Hit	4	Brightness
5	Crash 2	5	Conga Hi	5	Darbuka 2	5	Ramazan 1	5	Orch. Snare	5	Crystal
6	Rev. Cymbal	6	Conga Low	6	Darbuka 3	6	Ramazan 2	6	Orch. Sn. Roll	6	New Age Pad
7	Ride 1	7	Conga Mute	7	Darbuka 4	7	Ramazan 3	7	Timpani 1	7	Fifths Lead
8	Ride 2	8	Conga Slap	8	Darbuka 5	8	Rek Dom Ak	8	Timpani 2	8	Calliope
9	Ride Bell	9	Cowbell	9	Darbuka 6	9	Rik 1	9	Timpani 3	9	Caribbean
10	Splash	10	Cuica 1	10	Darbuka 7	10	Rik 2	10	Timpani 4	10	Rezbo
11	Sticks	11	Cuica 2	11	Darbuka 8	11	Rik 3	11	Orchestra Tutti	11	Digital Polixix
12	Rim-Shot	12	Jingle Bell	12	Davul	12	Sagat 1	12		12	Motion Raver
13	Hi Tom Flam	13	Long Guiro	13	Douf Rim Ak	13	Sagat 2	13		13	Moving Bell
14	Mid Tom Flam	14	Short Guiro	14	Dragon Gong	14	Tef 1	14		14	Elastick Pad
15	Low Tom Flam	15	Open Bells	15	Hollo 1	15	Tef 2	15		15	Rave
16	Tom Flam End	16	Rain Stick	16	Hollo 2	16	Tef 3	16		16	Dance Remix
17	Drum Single A	17	Tamb. Acc. 1	17		17	Tef 4	17		17	Vintage Sweep
18	Drum Single B	18	Tamb. Acc. 2	18		18	Tef 5	18		18	You Decide
19	Drum Single C	19	Tamb. Open	19		19	Tef 6	19		19	
20	Drum Single D	20	Tamb. Push	20		20		20		20	
21	Drum Sing.HouseA	21	Timbale Hi	21		21		21		21	
22	Drum Sing.HouseB	22	Timbale Low	22		22		22		22	
23	Drum Sing.HouseC	23	Timbale Rim 1	23		23		23		23	
24	Drum Sing.HouseD	24	Timbale Rim 2	24		24		24		24	
25	Drum Kit A	25	Triangle 1	25		25		25		25	
26	Drum Kit B	26	Triangle 2	26		26		26		26	
27	Drum Kit C	27	Vibra Slap	27		27		27		27	
28	Drum Kit D	28	Whistle 1	28		28		28		28	
29	Drum Kit E	29	Whistle 2	29		29		29		29	
30	Drum Kit F	30	Windchimes 1	30		30		30		30	
31		31	Windchimes 2	31		31		31		31	
32		32	Windchimes 3	32		32		32		32	

#	SEQ - Synth&Pad	#	SEQ - Misc&SFX	#		#		#		#	
1	Synth Seq 1	1	Military 1	1		1		1		1	
2	Synth Seq 2	2	Military 2	2		2		2		2	
3	Synth Seq 3	3	Military 3	3		3		3		3	
4	Synth Seq 4	4	Military 4	4		4		4		4	
5	Synth Seq 5	5	Horror 1	5		5		5		5	
6	Synth Seq 6	6	Horror 2	6		6		6		6	
7	Synth Seq 7	7	Horror 3	7		7		7		7	
8	Synth Seq 8	8	Horror 4	8		8		8		8	
9	Synth Seq 9	9	Lullaby 1	9		9		9		9	
10	Synth Seq 10	10	Lullaby 2	10		10		10		10	
11	Synth Seq 11	11	Nature - River	11		11		11		11	
12	Synth Portam. 1	12	Nature - Storm	12		12		12		12	
13	Synth Portam. 2	13	Metronome æ	13		13		13		13	
14	Synth Portam. 3	14	PreCount æ	14		14		14		14	
15	Synth Portam. 4	15	Metronome 4/4	15		15		15		15	
16	Synth Filter 1	16	PreCount 4/4	16		16		16		16	
17	Synth Filter 2	17	PreCount 4/4 Dbl	17		17		17		17	
18	Synth Pad Panned	18	Toccata	18		18		18		18	
19	Synth Master Pad	19	5th Intro	19		19		19		19	
20	Synth Dark Pad	20	Primavera	20		20		20		20	
21		21	Circus 1	21		21		21		21	
22		22	Circus 2	22		22		22		22	
23		23		23		23		23		23	
24		24		24		24		24		24	
25		25		25		25		25		25	
26		26		26		26		26		26	
27		27		27		27		27		27	
28		28		28		28		28		28	
29		29		29		29		29		29	
30		30		30		30		30		30	
31		31		31		31		31		31	
32		32		32		32		32		32	

Effects

The following table lists all Pa800 Factory Effects. Detailed information on each effect's parameter are contained in the "Advanced Edit" addendum that you can find in the Accessory CD.

FX assignable to FX processors A to D

1: Stereo Compressor	39: St. Auto Fade Mod.
2: Stereo Limiter	40: 2Voice Resonator
3: Multiband Limiter	41: Doppler
4: St.MasteringLimtr	42: Scratch
5: Stereo Gate	43: Grain Shifter
6: St.Parametric4EQ	44: Stereo Tremolo
7: St. Graphic 7EQ	45: St. Env. Tremolo
8: St.Exciter/Enhncr	46: Stereo Auto Pan
9: Stereo Isolator	47: St. Phaser + Trml
10: St. Wah/Auto Wah	48: St. Ring Modulator
11: St. Vintage Wah	49: Detune
12: St. Random Filter	50: Pitch Shifter
13: Multi Mode Filter	51: Pitch Shifter BPM
14: St. Sub Oscillator	52: Pitch Shift Mod.
15: Talking Modulator	53: Organ Vib/Chorus
16: Stereo Decimator	54: Rotary Speaker
17: St. Analog Record	55: L/C/R Delay
18: OD/Hi.Gain Wah	56: Stereo/CrossDelay
19: St. Guitar Cabinet	57: St. Multitap Delay
20: St. Bass Cabinet	58: St. Mod Delay
21: Bass Amp Model	59: St. Dynamic Delay
22: Bass Amp+Cabinet	60: St. AutoPanningDly
23: Tube PreAmp Model	61: Tape Echo
24: St. Tube PreAmp	62: Auto Reverse
25: MicModel+PreAmp	63: Sequence BPM Dly
26: Stereo Chorus	64: L/C/R BPM Delay
27: St.HarmonicChorus	65: Stereo BPM Delay
28: St. Biphase Mod.	66: St.BPM Mtap Delay
29: Multitap Cho/Delay	67: St.BPM Mod. Delay
30: Ensemble	68: St.BPMAutoPanDly
31: Polysix Ensemble	69: Tape Echo BPM
32: Stereo Flanger	70: Reverb Hall
33: St. Random Flanger	71: Reverb SmoothHall
34: St. Env. Flanger	72: Reverb Wet Plate
35: Stereo Phaser	73: Reverb Dry Plate
36: St. Random Phaser	74: Reverb Room
37: St. Env. Phaser	75: ReverbBrightRoom
38: Stereo Vibrato	76: Early Reflections
	77: P4EQ - Exciter
	78: P4EQ - Wah

- 79: P4EQ - Cho/Flng
- 80: P4EQ - Phaser
- 81: P4EQ - Mt. Delay
- 82: Comp - Wah
- 83: Comp - Amp Sim
- 84: Comp - OD/HiGain
- 85: Comp - P4EQ
- 86: Comp - Cho/Flng
- 87: Comp - Phaser
- 88: Comp - Mt. Delay
- 89: Limiter - P4EQ
- 90: Limiter-Cho/Flng
- 91: Limiter - Phaser
- 92: Limiter - Mt.Delay
- 93: Exciter - Comp
- 94: Exciter - Limiter
- 95: Exciter-Cho/Flng
- 96: Exciter - Phaser
- 97: Exciter - Mt.Delay
- 98: OD/HG - Amp Sim
- 99: OD/HG - Cho/Flng
- 100: OD/HG - Phaser
- 101: OD/HG - Mt.Delay
- 102: Wah - Amp Sim
- 103: Decimator - Amp
- 104: Decimator - Comp
- 105: AmpSim - Tremolo
- 106: Cho/Flng - Mt.Dly
- 107: Phaser - Cho/Flng
- 108: Reverb - Gate

FX assignable to FX processors B and D only

- 109: St.Mltband Limiter
- 110: PianoBody/Damper
- 111: OD/HyperGain Wah
- 112: GuitarAmp + P4EQ
- 113: BassTubeAmp+Cab.
- 114: St. Mic + PreAmp
- 115: Multitap Cho/Delay
- 116: St. Pitch Shifter
- 117: St. PitchShift BPM
- 118: Rotary SpeakerOD
- 119: L/C/R Long Delay
- 120: St/Cross Long Dly
- 121: Hold Delay
- 122: LCR BPM Long Dly
- 123: St. BPM Long Dly
- 124: Early Reflections

FX assignable to FX processor D only

- 125 : Vocoder

Assignable parameters

List of Footswitch and EC5 functions

The following functions can be assigned to a footswitch or Korg EC5's switch pedal.

Function	Meaning	
Off	No function assigned	
Style Start/Stop	Same functions of the control panel buttons with the same name	
Play Stop Seq1		
Play Stop Seq2		
Pause Seq1		
Pause Seq2		
Synchro Start		
Synchro Stop		
Tap Tempo/Reset		
Tempo Lock		
Ritardando		Progressively increases the Tempo value
Accelerando		Progressively decreases the Tempo value
Tempo Up	Increases the Tempo value	
Tempo Down	Decreases the Tempo value	
Intro 1	Same functions of the control panel buttons with the same name	
Intro 2		
Intro 3 / Count In		
Ending 1		
Ending 2		
Fill 1		
Fill 2		
Fill 3 / Break		
Variation 1		
Variation 2		
Variation 3		
Variation 4		
Variation Up		Selects the next Variation
Variation Down		Selects the previous Variation
Fade In/Out	Same functions of the control panel buttons with the same name	
Memory		
Bass Inversion		
Manual Bass		
Style Up	Selects the next Style	
Style Down	Selects the previous Style	
Single Touch	Same functions of the control panel buttons with the same name	
STS1		
STS2		
STS3		
STS4		
STS Up	Selects the next STS	
STS Down	Selects the previous STS	
Perform. Up	Selects the next Performance	
Perform. Down	Selects the previous Performance	

Function	Meaning
Style Change	Style number
Sound Up	Selects the next Sound
Sound Down	Selects the previous Sound
Transpose Down	Same functions of the control panel buttons with the same name
Transpose Up	
Upper Octave Up	
Upper Octave Down	
Punch In/Out	Turns Punch Recording on/off
FX A Mute	
FX B Mute	
FX C Mute	
FX D Mute	
FX All Mute	
Style-Upper1 Mute	
Style-Upper2 Mute	
Style-Upper3 Mute	
Style-Lower Mute	
Style-Drum Mute	
Style-Percussion Mute	
Style-Bass Mute	
Style-Acc1 Mute	
Style-Acc2 Mute	
Style-Acc3 Mute	
Style-Acc4 Mute	
Style-Acc5 Mute	
Style-Acc1-5 Mute	
Song-Melody Mute	Mute of Song track 4 (usually, the Melody track)
Song-Drum&Bass Mode	Mute of all tracks, apart for track 2 (usually Bass) and 10 (usually Drum)
Solo Selected Track	
Damper Pedal	
Soft Pedal	
Sostenuto Pedal	
Bass&Lower Backing	When the Style is not playing and you are in Split mode, you can play the Lower track with your left hand, while the Bass still plays the chord root. See "Bass & Lower Backing" on page 110.
Ensemble On/Off	
QuarterTone	Turns Quarter Tone on/off
Global-Scale	When the switch or footswitch is pressed, the Global > General Controls > Scale is recalled in the display.
SubScale Preset 1 (SC1)...4 (SC4)	Same functions of the SC Preset buttons in the display.
Chord Latch	Holds the recognized chord until the pedal is released
Chord Latch + Damper	Holds the recognized chord until the pedal is released, and sustains the tracks where the Damper has been turned on

Function	Meaning
Glide	When the pedal is pressed, affected notes on Upper tracks are bent down, according to settings for the Pitch Bend on the same tracks. When the pedal is released, notes return to the normal pitch, at the speed defined by the "Time" parameter (see "Glide" on page 216).
Audio In Mute	
Microphone Talk	Turns all Voice Processor effects down, to let you address the audience. See "Voice Processor Setup: Talk" on page 234.
Mic Lead On/Off	Momentary switch controls assigned to the Voice Processor. Press to activated, release to deactivate.
Mic Harmony On/Off	
Mic Effects On/Off	
Mic Latch On/Off	
FX CC12 Switch	Standard FX controllers
FX CC13 Switch	
Rotary Spkr On/Off	
Rotary Spkr Fast/Slow	
Drawbar Perc On/Off	
Drawbar Noise On/Off	
Text Page Up	These options let you move to the previous or next page, when reading a text file loaded with a Song (see "Text files loaded with Standard MIDI Files and MP3 files" on page 164) or Song Book entry (see "Lyrics as text files associated to a SongBook entry" on page 186).
Text Page Down	
SongBook Next	Moves to the next SongBook entry in the selected Custom List.
Pad 1	Same functions of the control panel buttons with the same name
Pad 2	
Pad 3	
Pad 4	
Pad Stop	
Sound Controller 1	To be used as triggers for two DNC parameter (transmit CC#80 or CC#81). When these functions are assigned to the selected physical controller, this latter becomes the corresponding Sound Controller (Sound Controller 1 or Sound Controller 2). You can then use this Sound Controller to control any of the DNC parameters.
Sound Controller 2	

List of Assignable Pedal and Assignable Slider (A/B) functions

The following functions can be assigned to a continuous pedal or to the Assignable Sliders (in A or B mode).

Function	Meaning
Off	No function assigned
Master Volume	
Keyboard Expression	
Joystick +X	Joystick right
Joystick -X	Joystick left
Joystick +Y	Joystick forward
Joystick -Y	Joystick backward
Upper VDF Cutoff	Filter cutoff (for Sounds assigned to the Upper tracks)
Upper VDF Resonance	Filter resonance (for Sounds assigned to the Upper tracks)
Mic In Volume	
Mic Lead Voice Volume	Continuous controls assigned to the Voice Processor.
Mic Harmony Output Volume	
Mic Lead to Delay	
Mic Harmony to Delay	
Mic Reverb Level	
Mic FX Level	
Mic EQ Gain Low	
Mic EQ Gain Med	
Mic EQ Gain High	
Mic EQ Gain Low	
FX CC12 Ctl	Standard FX controllers
FX CC13 Ctl	
Pad Volume	With this function assigned, you can control the proportional volume of all four Pads at the same time. Please note that the status of the Pad's volume, after having been modified with a pedal or slider, is made current, and will be saved in a Performance or STS by using the relevant Write procedure.

List of Assignable Slider (Mic) functions

The following functions can be assigned to the Assignable Sliders. (in Mic mode)

Function	Meaning
Off	No function assigned
Mic In Volume	
Mic Lead Voice Volume	Continuous controls assigned to the Voice Processor.
Mic Harmony Output Level	
Mic Lead to Delay	
Mic Harmony to Delay	
Mic Reverb Level	
Mic FX Level	
Mic EQ Gain Low	
Mic EQ Gain Med	
Mic EQ Gain High	

List of Assignable Switch functions

The following functions can be assigned to the Assignable Switches.

Function	Meaning
Off	No function assigned
Ritardando	Progressively increases the Tempo value
Accelerando	Progressively decreases the Tempo value
Style Up	Selects the next Style
Style Down	Selects the previous Style
Perform. Up	Selects the next Performance
Perform. Down	Selects the previous Performance
FX A Mute	
FX B Mute	
FX C Mute	
FX D Mute	
FX All Mute	
Style-Upper1 Mute	
Style-Upper2 Mute	
Style-Upper3 Mute	
Style-Lower Mute	
Style-Drum Mute	
Style-Percussion Mute	
Style-Bass Mute	
Style-Acc1 Mute	
Style-Acc2 Mute	
Style-Acc3 Mute	
Style-Acc4 Mute	
Style-Acc5 Mute	
Style-Acc1-5 Mute	
Song-Melody Mute	Mute of Song track 4 (usually, the Melody track)
Song-Drum&Bass Mode	Mute of all tracks, apart for track 2 (usually Bass) and 10 (usually Drum)
Solo Selected Track	
Bass&Lower Backing	Mutes all tracks, except for the Bass and Lower tracks
QuarterTone	Turns Quarter Tone on/off
Global-Scale	When the switch is pressed, the Global > General Controls > Scale is recalled in the display.
SubScale Preset 1 (SC1)...4 (SC4)	Same functions of the SC Preset buttons in the display.
Audio In Mute	
Microphone Talk	Turns all Voice Processor effects down, to let you address the audience. See "Voice Processor Setup: Talk" on page 234.
Mic Lead On/Off	Momentary switch controls assigned to the Voice Processor. Press to activate, release to deactivate.
Mic Latch On/Off	
FX CC12 Switch	Standard FX controllers
FX CC13 Switch	
Rotary Spkr On/Off	
Rotary Spkr Fast/Slow	
Drawbar Perc On/Off	

Function	Meaning
Drawbar Noise On/Off	
Text Page Up	These options let you move to the previous or next page, when reading a text file loaded with a Song (see "Text files loaded with Standard MIDI Files and MP3 files" on page 164) or Song Book entry (see "Lyrics as text files associated to a SongBook entry" on page 186).
Text Page Down	
SongBook Next	Moves to the next SongBook entry in the selected Custom List.
Sound Controller 1	To be used as triggers for two DNC parameter (transmit CC#80 or CC#81). When these functions are assigned to the selected physical controller, this latter becomes the corresponding Sound Controller (Sound Controller 1 or Sound Controller 2). You can then use this Sound Controller to control any of the DNC parameters.
Sound Controller 2	

Scales

The following is a list of scales (or tunings) you can select in various operating modes.

- Equal Equal tuning, the standard scale for modern Western music. It is made of 12 identical semitones.
- Pure Major Major chords in the selected key are perfectly tuned.
- Pure Minor Minor chords in the selected key are perfected tuned.
- Arabic An arabic scale, using quarters of tone. Set the Key parameter as follow:
 - C - for the "rast C/bayati D" scale
 - D - for the "rast D/bayati E" scale
 - F - for the "rast F/bayati G" scale
 - G - for the "rast G/bayati A" scale
 - A# - for the "rast Bb/bayati C" scale
- Pythagorean Pythagorean scale, based on the music theories of the great Greek philosopher and mathematician. It is most suitable for melodies.
- Werckmeister Late Baroque/Classic Age scale. Very suitable for XVIII Century music.
- Kirnberger Harpsichord scale, very common during the XVIII Century.
- Slendro Scale of the Indonesian Gamelan. The octave is divided in 5 notes (C, D, F, G, A). The remaining notes are tuned as in the Equal tuning.
- Pelog Scale of the Indonesian Gamelan. The octave is divided in 7 notes (all white keys, when Key is = C). The black keys are tuned as in the Equal tuning.
- Stretch Simulates the "stretched" tuning of an acoustic piano. Basically an equal tuning, the lowest notes are slightly lower, while the highest notes are slightly higher than the standard.
- User User scale, i.e. scale programmed by the user for the Style Play, Backing Sequence and Song Play modes. The user scale can be saved to a Performance, Style Performance, STS or Song. You can't select a User scale in Global mode.

MIDI Data

MIDI Controllers

The following is a table including all Control Change messages, and their effect on various Pa800 functions.

CC#	CC Name	Pa800 Function
0	Bank Select	Program selection
1	Mod1 (Y+)	Joystick forward
2	Mod2 (Y-)	Joystick backward
3	Undef. ctl	
4	Foot ctl	
5	Port.time	
6	Data ent.	
7	Volume	Track volume
8	Balance	
9	Undef. ctl	
10	Pan Pot	Track panning
11	Expression	Expression
12	Fx Ctl 1	CC#12
13	Fx Ctl 2	CC#13
14-15	Undef. ctl	
16	Gen.pc.1	
17	Gen.pc.2	
18	Slider	
19	Gen.pc.4	
20-31	Undef. ctl	
Control Change #32-63 are the LSB (Least Significant Byte) of Control Change #0-31, i.e. the MSB (Most Significant Byte), and are changed according to their MSB counterparts.		
64	Damper	Damper pedal
65	Portamento	
66	Sostenuto	Sostenuto pedal
67	Soft	Soft pedal
68	Legato	
69	Hold 2	
70	Sustain level	
71	F.Res.Hp	Filter resonance
72	Release	Release time
73	Attack	Attack time
74	F.CutOff	Filter cutoff (Brilliance)
75	Decay T.	Decay time
76	Lfo1 Sp.	Vibrato speed
77	Lfo1 Dpt	Vibrato depth
78	Lfo1 Dly	Vibrato initial delay
79	FilterEg	
80	Gen.pc.5	
81	Gen.pc.6	
82	Gen.pc.7	
83	Gen.pc.8	
84	Port.ctl	
85-90	Undef. ctl	

CC#	CC Name	Pa800 Function
91	Fx A/C	A/C (reverb) send level
92	Fx 2 ctl	
93	Fx B/D	B/D (modul.) send level
94	Fx 4 ctl	
95	Fx 5 ctl	
96	Data Inc	
97	Data Dec	
98	NRPN Lsb	See table below ^(*)
99	NRPN Msb*	See table below ^(*)
100	RPN Lsb	See MIDI Implementation Chart
101	RPN Msb	See MIDI Implementation Chart
102-119	Undefined ctl	
120	AllSOff	
121	Res Ctl	Reset All Controllers
122	LocalCt	
123	NoteOff	
124	OmniOff	
125	Omni On	
126	Mono On	
127	Poly On	

(*) The following NRPN messages are recognized by the Pa800:

NRPN	CC#99 (MSB)	CC#98 (LSB)	CC#06 (Data Entry)
Vibrato Rate	1	8	0...127 ^(a)
Vibrato Depth	1	9	0...127 ^(a)
Vibrato Decay	1	10	0...127 ^(a)
Filter Cutoff	1	32	0...127 ^(a)
Resonance	1	33	0...127 ^(a)
EG Attack Time	1	99	0...127 ^(a)
EG Decay Time	1	100	0...127 ^(a)
EG Release Time	1	102	0...127 ^(a)
Drum Filter Cutoff	20	dd ^(b)	0...127 ^(a)
Drum Filter Resonance	21	dd ^(b)	0...127 ^(a)
Drum EG Attack Time	22	dd ^(b)	0...127 ^(a)
Drum EG Decay Time	23	dd ^(b)	0...127 ^(a)
Drum Coarse Tune	24	dd ^(b)	0...127 ^(a)
Drum Fine Tune	25	dd ^(b)	0...127 ^(a)
Drum Volume	26	dd ^(b)	0...127
Drum Panpot	28	dd ^(b)	0...127 ^(a)
Drum Rev Send (FX 1)	29	dd ^(b)	0...127 ^(a)
Drum Mod Send (FX 2)	30	dd ^(b)	0...127 ^(a)

(a). 64 = No change to the original parameter's value
(b). dd = Drum Instrument No. 0...127 (C0...C8)

Note: These controls are reset when stopping the Song, or choosing a new Song.

Program Change messages used as remote commands

The following is a table including all Program Change messages, used as remote Style and Sequencer controls. These messages are to be sent on the Control channel (see “MIDI: MIDI In Channels” on page 225).

PC	Function	PC	Function	PC	Function	PC	Function	PC	Function
Style Elements									
80	Intro 1	81	Intro 2	82	Intro 3/Count In	83	Variation 1	84	Variation 2
85	Variation 3	86	Variation 4	87	Fill 1	88	Fill 2	89	Fill 3/Break
90	Ending 1	91	Ending 2	92	Ending 3				
Style and Sequencers Control									
93	Fade In/Out	94	Memory	95	Bass Inversion	96	Manual Bass	97	Tempo Lock
98	Single Touch	99	Style Change	100	Start/Stop (Style)	101	Play/Stop (Seq 1)	102	Play/Stop (Seq 2)

Note: The above Program Change numbers are given according to the 0-127 numbering system.

Control Change and Program Change message used as remote commands

The following is a table including all Control Change + Program Change messages, used as remote Style and Player controls. These messages are to be sent on the Control channel (see “MIDI: MIDI In Channels” on page 230). If a Style is already selected, just send the Program Change message.

CC#0	CC#32	PC	STS	PC	STS	PC	STS	PC	STS
The same as the Style to which the STS belongs		64	STS 1	65	STS 2	66	STS 3	67	STS 4

MIDI Implementation Chart

KORG Pa800
OS Version 2.0 - Nov. 04, 2008

Function		Transmitted	Recognized	Remarks
Basic Channel	Default	1-16	1-16	Memorized
	Changed	1-16	1-16	
Mode	Default		3	
	Messages	X	X	
	Altered	*****		
Note Number:		0-127	0-127	
	True Voice	*****	0-127	
Velocity	Note On	O 9n, V=1-127	O 9n, V=1-127	
	Note Off	X V=64	X	
Aftersustain	Poly (Key)	O	O	Sequencer data only *1
	Mono (Channel)	O	O	*1
Pitch Bend		O	O	
Control Change	0, 32	O	O	Bank Select (MSB, LSB) *1
	1, 2	O	O	Modulations *1
	6	O	O	Data Entry MSB *1
	38	O	O	Data Entry LSB *1
	7, 11	O	O	Volume, Expression *1
	10, 91, 93	O	O	Panpot, A/C FX Send, B/D FX Send *1
	64, 66, 67	O	O	Damper, Sostenuto, Soft *1
	65, 5	O	O	Portamento On/Off, Portamento Time *1
	71, 72, 73	O	O	Harmonic Content, EG time (Release, Attack) *1
	74, 75	O	O	Brightness, Decay Time *1
	76, 77, 78	O	O	Vibrato Rate, Depth, Delay *1
	98, 99	O	O	NRPN (LSB, MSB) *1, 2
	100, 101	O	O	RPN (LSB, MSB) *1, 3
120, 121	X	O	All sounds off, Reset all controllers *1	
Program Change		O 0-127	O 0-127	*1
	True #	*****	0-127	
System Exclusive		O	O	*4
System Common	Song Position	X	X	
	Song Select	X	X	
	Tune	X	X	
System Real Time	Clock	O	O	*5
	Commands	O	O	*5
Aux Messages	Local On/Off	X	X	
	All Notes Off	X	O (123-125)	
	Active Sense	O	O	
	Reset	X	X	
Notes	*1: Sent and received when MIDI Filters In and Out are set to Off in Global mode. *2: Drawbars settings, Sound parameters, Selection of SongBook entries. *3: LSB, MSB = 00,00: Pitch Bend range, =01,00: Fine Tune, =02,00: Coarse Tune. *4: Includes Inquiry and Master Volume messages, FX settings, Quarter Tone settings. GM Mode On. *5: Transmitted only when the Clock Send parameter (Global mode) is set to on.			

Mode 1:OMNI ON, POLY
Mode 3:OMNI OFF, POLY

Mode 2:OMNI ON, MONO
Mode 4:OMNI OFF, MONO

O: Yes
X: No

Recognized chords

The following pages show the most important chords recognized by the Pa800, when the selected Chord Recognition mode is Fingered 2 (see “Chord Recognition Mode” on page 106). Recognized chords may vary with a different Chord Recognition mode.

Major

3-note

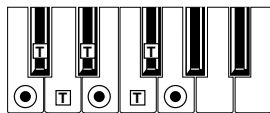

Major 6th

4-note

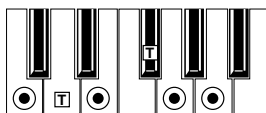

2-note



Major 7th

4-note

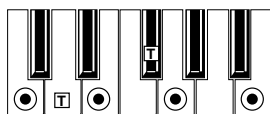

3-note

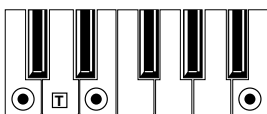

2-note



Sus 4

3-note

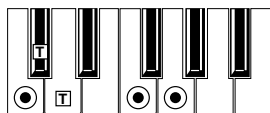

2-note

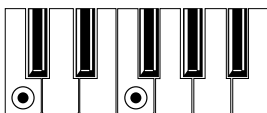

Sus 2

3-note

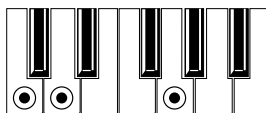

Dominant 7th

4-note

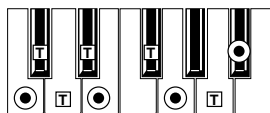

3-note

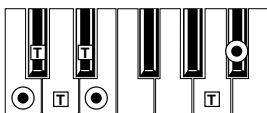

2-note



Dominant 7th Sus 4

4-note

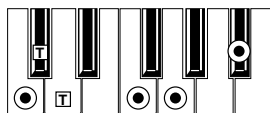

3-note

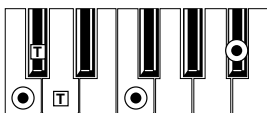

Dominant 7th ^b5

4-note

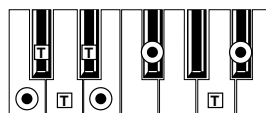

Major 7th ^b5

4-note

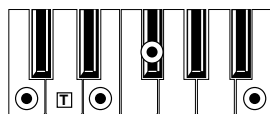

Major 7th Sus 4

4-note

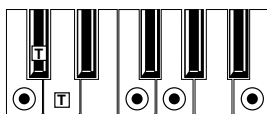

● = constituent notes of the chord

⊠ = can be used as tension

Minor

3-note

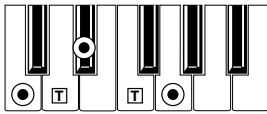

2-note

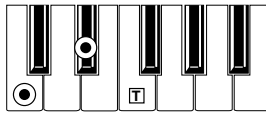

Minor 6th

4-note

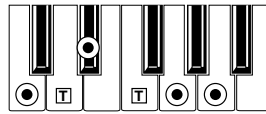

Minor 7th

4-note

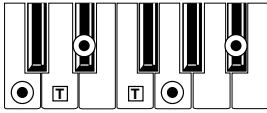

3-note

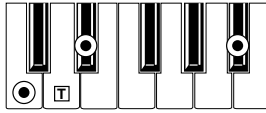

Minor-Major 7th

4-note

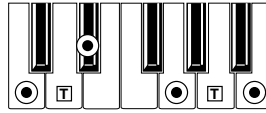

3-note

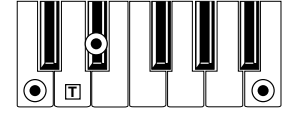

Diminished

3-note

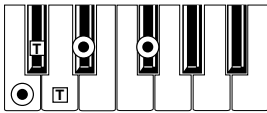

Diminished Major 7th

4-note

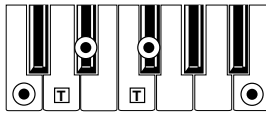

Minor 7th ^b5

4-note

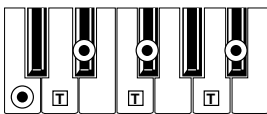

Augmented

3-note

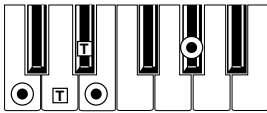

Augmented 7th

4-note

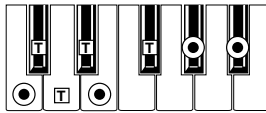

Augmented Major 7th

4-note

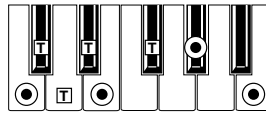

No 3rd

2-note



No 3rd, no 5th

1-note



● = constituent notes of the chord

□ = can be used as tension

Installing the MP3 Board (EXBP-Dual MP3)

You can install a Korg EXBP-Dual MP3 board into your Pa800. This user-installable card will let your Pa800 play and record MP3 files, allowing for easy music data exchange with any personal computer or stand-alone MP3 player.

Korg is not responsible for any damage or injury caused by incorrect installation.

Precautions

- Installation of the card is done at the user's own risk. Korg will assume no responsibility for any damage or injury resulting from its improper installation or use.
- Be sure to disconnect the instrument from the AC plug, before opening it.
- To prevent your body's static electricity from damaging the board's components, touch an unpainted metallic component before proceeding with the installation.

Installation

For installation, you will need a cross-point screwdriver and a pair of pliers (not supplied).

1. On the back of the instrument, unscrew the two screws (a) and extract the cover (b), to gain access to the MP3 Board slot.



2. Fully remove the cover (b) by unfastening the ground cable (c) and the attached power cable (d) fall inside the instrument. **Be very careful not to let the ground cable (c) and the attached power cable (d) fall inside the instrument.**

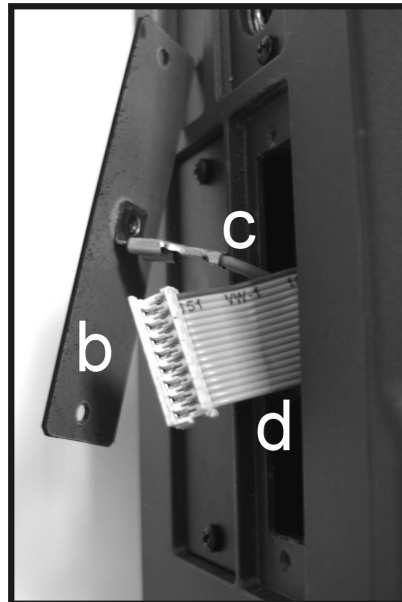

3. Extract the MP3 card (e) from its package, being careful not to touch any component on its surface with your fingers. Connect the ground cable (c) and the power cable (d) to the corresponding connectors on the MP3 card, as shown in the illustration.

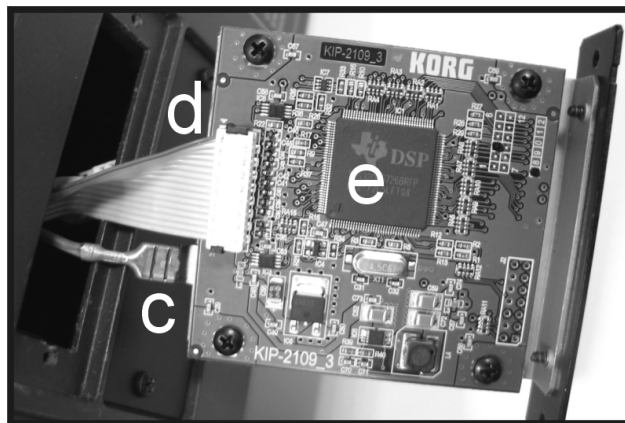

- Slide the MP3 card (e) inside the slot, as shown in the illustration.

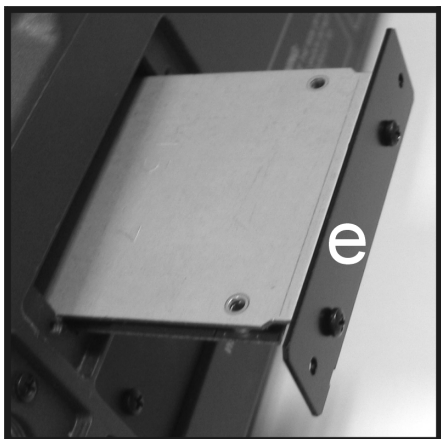

- Attach the MP3 card (e) to the instrument using the two previously removed screws (a).

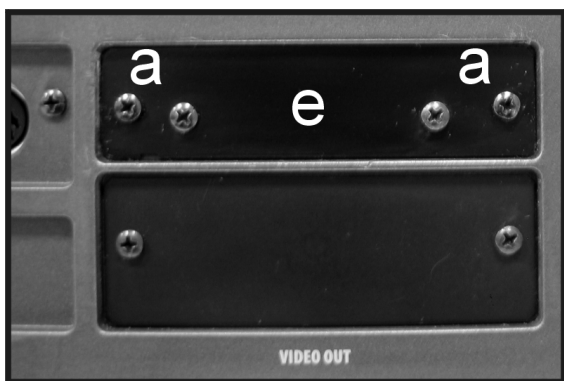

Playing MP3 files

Please see the relevant instructions in the “Song Play operating mode” chapter.

Recording MP3 files

If your Pa800 is fitted with the optional MP3 Board (EXBP-Dual MP3), you can record your performance as an MP3 file.

Note: You cannot enter MP3 Record mode while in Sequencer or Media mode.

Note: If recording with the Master EQ turned on, the EQ will be recorded into the MP3 file. This equalisation will be added to the one selected during playback. It is advisable to turn Master EQ off while recording, if the MP3 file has to be played back on the Pa800.

- All you play on the keyboard, the Styles and the Standard MIDI Files performed by the sequencer will be recorded. Also, audio entering the Audio Inputs is recorded (single microphone input with the “In to Voice Processor” option selected, or both inputs with the “In to Direct” option selected. See “Audio Setup: Audio In” on page 228). Harmony voices generated by the Voice Processor will be recorded as well.

- Playback of MP3 files will not be recorded.

To enter recording, keep the SHIFT button pressed, and press the RECORD button. The MP3 Record dialog box will appear.

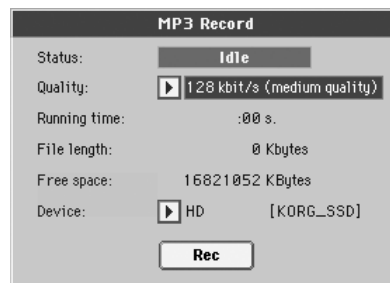

When not recording, the shown status is Idle.

Choose the preferred MP3 audio quality option, by means of the Quality pop-up menu. The higher the sound quality, the larger the MP3 file that will be generated.

Use the Device parameter to choose a location where to “spool” the recorded MP3 file. This is not the final destination of your file, since you will be able to choose a different location after recording. However, be sure there is space enough for the spooling file, by reading the Free space parameter.

Note: The default device is automatically selected as the spooling unit; use the Device pop-up menu to choose a different one. You can record on the internal SSD-U flash memory, the (optional) hard disk, or a device connected to one of the USB ports.

When done, touch the Rec button in the display to start recording. The Rec button changes to Stop, and can be touched again to stop recording. Also, the Idle label changes to Recording.

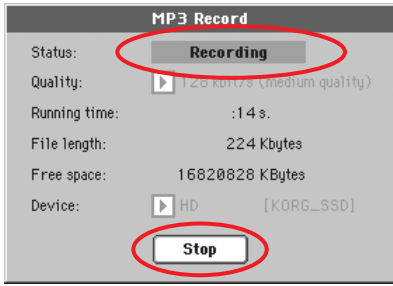

If you like, you can press the EXIT button to exit this dialog box and access the Style Play and Song Play pages. To enter the dialog box again, and see the file length or stop recording, press SHIFT+REC again.

During recording, if you exit from the MP3 Record dialog box while still recording, a big red 'R' will flash in the display.



During recording, you can use this dialog box to see the Recording time, file length, and the remaining space on disk. Maximum recording time depends on the available space in the selected device.

After touching Stop, recording will stop, and the following dialog box will appear:

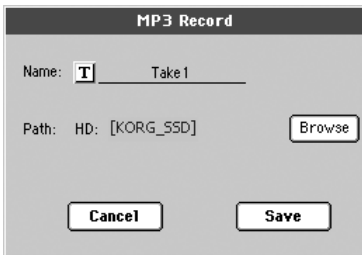

Touch the **T** (Text Edit) button to assign a name to the MP3 file. Touch the Browse button to select a device and directory where to save the file. Touch the Save button to save the file.

After saving, you can listen to the MP3 file in Song Play mode, as you do with any other Song.

The MP3 file can also be moved to a personal computer for further editing, via the USB interface.

Notes

Audio outputs

- Audio generated by the MP3 board can only be routed on the Left+Right audio outputs.

Playback

- MP3 files recorded with lower sampling rates may not sound very good. This is an unavoidable problem with MP3 files.

Recording

- You can record as an MP3 file everything you play with the Pa800, including your vocals (in other words, you can record your whole performance). However, you cannot record other MP3 files.

Devices

- It is not advisable to fill the target device too much during recording. Filling it may cause troubles with the recorded file.
- Regular care is recommended with your target device. Defragmenting and repairing internal devices can be made with any PC utility, while the Pa800 is connected via USB.

Installing the Video Interface (VIF4)

You can install a Korg VIF4 Video Interface into your Pa800. This interface will let you connect a video monitor, TV set, video recorder or video projector, to read lyrics on an external device. The card can be installed by the user. **Korg is not responsible for any damage or injury caused by incorrect installation of this card by unauthorized personnel.**

NTSC, PAL, SECAM

The VIF4 is compatible with the NTSC, PAL and SECAM TV standard. When connecting a SECAM-compliant TV set, select the PAL standard. However, in this latter case, the image will be shown in black and white.

Precautions

- Installation of the card is done at the user's own risk. Korg will assume no responsibility for any damage or injury resulting from its improper installation or use.
- Be sure to disconnect the instrument from the AC plug, before opening it.
- To prevent your body's static electricity from damaging the board's components, touch an unpainted metallic component before proceeding with the installation.

Installation

For installation, you will need a cross-point screwdriver and a pair of pliers (not supplied).

1. On the back of the instrument, unscrew the two screws (a) and extract the cover (b), to gain access to the video slot.



2. Fully remove the cover (b) by unfastening the ground cable (c) and the attached power cable (d) fall inside the instrument.

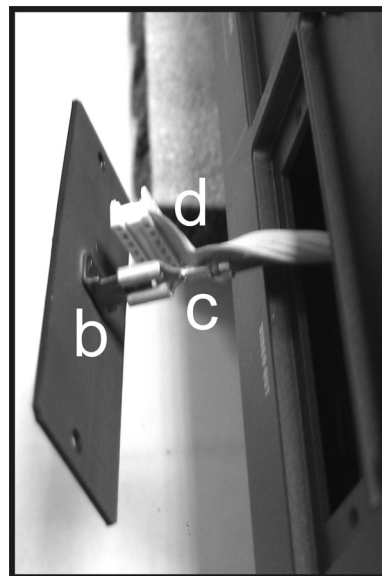

3. Extract the video card (e) from its package, being careful not to touch any component on its surface with your fingers. Connect the ground cable (c) and the power cable (d) to the corresponding connectors on the video card, as shown in the illustration.

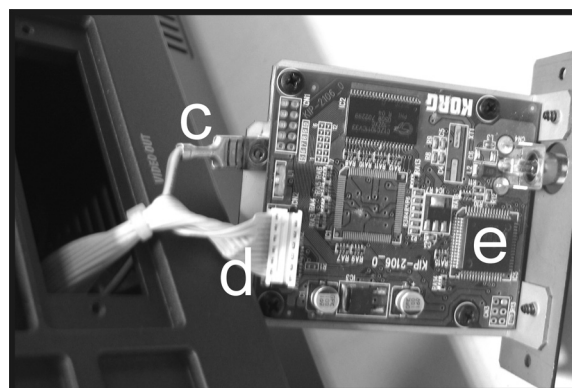

4. Slide the video card (e) inside the slot, and attach it to the instrument using the two previously removed screws (a).



Connections and setup

1. Connect the instrument's video output to the video input of the television set. Depending on the type of television set, you can use a cable of the type "RCA-to-RCA" (if the television set is equipped with a Video Composite input), or "RCA-to-SCART" (if the television set is equipped with a SCART connector). You can buy the needed cables at a store that sells television equipment.
2. Turn the instrument on, and press the GLOBAL button to gain access to the Global edit mode. Go to the "Video Interface: Video Out" page, and select the video standard (PAL or NTSC).
3. Select the "Write Global-Global Setup" command from the page menu to save the settings in memory. The Write Global-Global Setup dialog box will appear. Touch OK to confirm.
4. Turn the television set on, and tune it on the AV1 or AV2 input.
5. In the same page of the Global, use the Colors parameter to choose the preferred set of colors for the lyrics and the background.

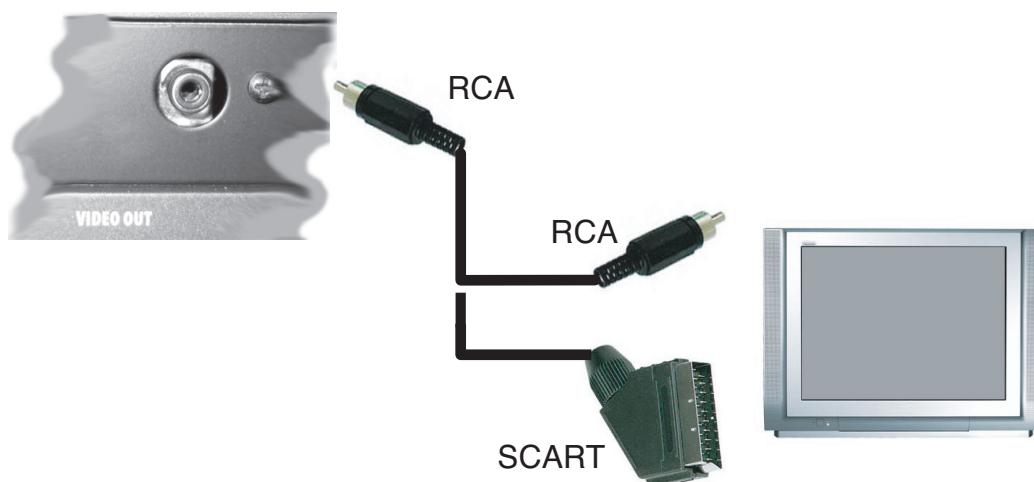

Installing the Korg USB MIDI Driver

The USB Device port can be used to transfer MIDI data between the Pa800 and a personal computer (this is called the *MIDI Over USB* function). This is useful when your computer is not fitted with a MIDI interface.

USB can be used in parallel with the MIDI ports. For example, you can connect your Pa800 to a sequencer running on your computer, and at the same time control another MIDI instrument connected to the MIDI ports of the Pa800.

Connecting the Pa800 this way makes it, at the same time, a MIDI input device, a controller, and a sound generator.

Connecting the Pa800 to a personal computer

Please install the KORG USB-MIDI Driver, before connecting the Pa800 to a personal computer. Be sure your personal computer meets the requirement shown on “KORG USB-MIDI Driver system requirements” below.

KORG USB-MIDI Driver system requirements

Windows

Computer: A computer with an USB port, that satisfies the requirements of Microsoft Windows XP.

Operating system: Microsoft Windows XP Home Edition / Professional / x64 Edition (a driver for the x64 Edition is in beta release.)

Macintosh

Computer: An Apple Macintosh with an USB port that satisfies the requirements of Mac OS X.

Operating system: Mac OS X version 10.3 or later.

Please note before use

Copyright to all software included in this product is the property of Korg Inc.

The license agreement for this software is provided separately. You must read this license agreement before you install this software. Your installation of this software will be taken to indicate your acceptance of this agreement.

Windows: Installing the KORG USB-MIDI Driver

Please connect the Pa800 to the computer via an USB cable only after having installed the KORG USB-MIDI Driver Tools.

Note: You must install a separate driver for each USB port you will use.

1. Insert the included CD into your CD-ROM drive.
2. Normally, the “KORG Pa800 Application Installer” will start up automatically.

If your computer is set so that the installer does not run automatically, double-click “KorgSetup.exe” on the CD.

3. Please follow the installation instructions appearing on-screen.
4. Restart the computer, and turn on the Pa800. Connect the Pa800 to the computer via an USB cable.
5. Select the following command from the task bar to open the installation instructions:

Start > all programs > KORG > KORG USB-MIDI Driver Tools > Installation manual

6. Select the following command from the task bar to open the installation program:

Start > all programs > KORG > KORG USB-MIDI Driver Tools > Install KORG USB-MIDI Device

7. Please follow the installation instructions appearing on-screen to install the KORG USB-MIDI Driver.

Driver's ports

After installation, the following ports will be shown in your MIDI application (e.g., sequencer) among the other MIDI devices:

PA800 KEYBOARD: This allows for reception of MIDI messages from the Pa800 (keyboard and controller's data) to the MIDI application running on the computer.

PA800 SOUND: This allows for transmission of MIDI messages from the MIDI application running on the computer, to the internal tone generator of the Pa800.

Mac OS X: Installing KORG USB-MIDI Driver

1. Insert the included CD into your CD-ROM drive.
2. Please double click on the “KORG USB-MIDI Driver.pkg” in the “KORG USB-MIDI Driver” folder inside the CD-ROM, to run the installer. Install it according to the instructions appearing on-screen.

Driver's ports

After installation, the following ports will be shown in you MIDI application (e.g., sequencer) among the other MIDI devices:

PA800 KEYBOARD: This allows for reception of MIDI messages from the Pa800 (keyboard and controller's data) to the MIDI application running on the Mac.

PA800 SOUND: This allows for transmission of MIDI messages from the MIDI application running on the Mac, to the internal tone generator of the Pa800.

Shortcuts

You can keep the SHIFT button pressed, and press another button on the control panel to directly jump to an edit page. Here is the list of “shortcuts”.

Shift +	Functions
Any operating modes	
Dial	Tempo Change
Scroll Arrows, or Up/Down	<i>When a list of Songs or SongBook entries is shown: Next/Previous alphabetical section. It also works in Media mode.</i>
Sound	Sends the Sound assigned to the selected track to the Sound mode
Global	Selects the Setup/General Controls page, MIDI section, of the Global mode. This is a quick way to jump to MIDI editing pages.
Media	Selects the Preferences page of the Media mode
Start/Stop	Panic
Slider Mode	Selects the Assignable Sliders page, Controllers section, of the Global mode
Fade In/Out	Selects the Fade In/Out parameter in the Basic page, Preferences section, of the Global mode
Synchro (either)	Selects the MIDI Setup parameter in the Setup/General Controls page, MIDI section, of the Global mode
Tempo Lock	Selects the Lock page, General Controls section, of the Global mode
Display Hold	Selects the Interface page, General Controls section, of the Global mode
SongBook	Selects the Custom List page of the SongBook mode
Transpose (either)	Selects the Transpose Control page, General Controls section, of the Global mode
Mic	Selects the Voice Processor Setup page of the Global mode
Harmony	Selects the Voice Processor Preset page of the Global mode
Effects	Selects the Voice Processor Effects page of the Global mode
Style Play mode	
Style Play	Selects the Style Setup page (Preferences section)
Memory	Selects the Style Preferences page (Preferences section)
Var or Fill	Selects the corresponding Style Element in the Drum/Fill page (Style Controls section)
Chord Scanning (either)	Selects the Chord Recognition parameter in the Split panel, Main Page
Keyboard Mode (either)	Selects the Key Velocity page (Keyboard/Ensemble section)

Shift +	Functions
Ensemble	Selects the Ensemble Type parameter in the Ensemble page, (Keyboard/Ensemble section)
Pad (any)	Selects the Pad page (Pad/Assignable Switches section)
Assignable Switch (any)	Selects the Switch page (Pad/Assignable Switches section)
Upper Octave (either)	Selects the Tuning page (Mixer/Tuning section)
Style	Opens the “Write Current Style Performance” window.
Sound/Performance	Opens the “Write Performance” window.
STS	Opens the “Write STS” window.
Song Play mode	
Song Play	Selects the General Control page (Preferences section)
Play/Stop–Seq 1 or 2	Sync Start of either sequencers
Upper Octave (either)	Selects the Tuning page (Mixer/Tuning section)
Keyboard Mode (either)	Selects the Key Velocity page (Keyboard/Ensemble section)
Pad (any)	Selects the Pad page (Pad/Assignable Switches section)
Assignable Switch (any)	Selects the Switch page (Pad/Assignable Switches section)
Sound/Performance	Opens the “Write Performance” window.
JukeBox mode	
>>	Play the next Song in the JukeBox list
<<	Play the previous Song in the JukeBox list
Sequencer mode	
Sequencer	Selects the Sequencer Setup page (Preferences section)
Upper Octave (either)	Selects the Tuning page (Mixer/Tuning section)

Other available shortcuts are the following, not requiring the SHIFT button to be pressed.

Style Play mode	
Up/Down (together)	Original Tempo
Global mode	
Global (keep it pressed)	Touch Panel Calibration

Troubleshooting

Problem	Solution	Page
General problems		
Power does not turn on	Make sure that (1) the power cable is plugged into the outlet, (2) the cable is plugged into the connector on the back of the instrument, (3) and is not damaged, (4) there are no problems with the mains.	
	Is the power switch turned ON?	
	If the power still does not turn on, contact your dealer or the nearest KORG Service Center.	
No sound	Is a jack connected to the HEADPHONES connector? This would disable the internal speakers.	23
	Check the connections to your amp or mixer.	24
	Make sure that all the components of the amplifying system are turned on.	
	Is the MASTER VOLUME slider of the Pa800 set to a position other than "0"?	23
	Is the Local parameter set to Off? Turn it On.	224
	Is the Speaker parameter set to Off? Turn it On.	229
	Is the Attack parameter value too high? Set it to a lower value, to let the sound start faster. Is the Volume parameter too low? Set it to a higher value.	93, 101
Lowest note are not played	When the SPLIT button is lit up, the keyboard will be divided into the Lower part (low notes, below the split point) and the Upper part (high notes, above the split point). Is the Lower track muted? Unmute it.	33
Wrong sounds	Do the USER banks contain modified data? Load the appropriate data for the Song or the Style you wish to playback.	247
	Has one of the USER Drum Kits been modified? Load the appropriate Drum Kits.	247
	Have the Styles or Performances been modified? Load the appropriate data (Styles or Performances).	247
Sound does not stop	Make sure that the damper switch polarity parameter is set correctly.	222
The selected Style or Song cannot start	Make sure that the Clock parameter is set to Internal. If you are using the MIDI Clock of another device, you must set the MIDI Clock parameter to MIDI or USB (depending on the port the Pa800 is hooked to the other device through) and make sure that the external device transmits MIDI Clock data.	224
Does not respond to MIDI messages	Make sure that all MIDI or USB cables are connected correctly.	263
	Make sure that the external device is transmitting through MIDI channels enabled to receive in the Pa800.	225
	Make sure that the MIDI IN Filters of the Pa800 do not prevent the reception of messages.	226
Percussive instruments are not played correctly	Make sure that the Drum track is set to Drum Mode and the external device has not transposition applied.	99, 205
Some "clicks" can be heard when playing a percussive instrument	This is part of the sound, and not a problem.	
A background noise can be heard after selecting a Performance, Style or STS	The selected Performance, Style or STS recalled the effect "17 St. Analog Record", simulating the noise of a old vinyl recording.	
The Voice Processor cannot be heard	The Vocoder effect has been assigned to the D FX processor. This deactivates the Voice processor.	
	Voice processor effects can only be applied to the microphone input	

Problem	Solution	Page
Media related problems		
Cannot format a device	Is the USB cable correctly connected?	
	Is the USB device correctly powered?	
	Is the device inserted correctly?	
	Is the write protect tab of the disk in the protect position?	
Cannot save data to a device	Is the device formatted?	256
	Is the device inserted correctly?	
	Is the write protect tab of the disk in the protect position?	
Cannot load data from a device	Is the device inserted correctly?	
	Does the device contain data compatible with the Pa800?	245
The message "Over Current Condition Detected on USB port: please remove the USB media" appears in the display	The USB device is probably defective, due to a short circuit, and cannot be used. While this will not damage the Pa800, it is advisable to remove the device.	

Technical specifications

Features	KORG Pa800
KEYBOARD	
Keyboard	61 keys with Velocity and Aftertouch
SOUND DATA	
Tone Generator	120 Voices, 120 Oscillators - EQ for each track - Filters with Resonance
Multitimbral-Parts	Internal: 40 channels - Midi: 16 channels
Factory Sounds	1,007 (incl. Stereo Piano and GM2 sounds) + 64 Drum Kits
User Sounds	256 Sounds - 64 Drum Kits
Digital Drawbars	9 Footages
Sound Edit	On-board full editing for Sounds and DrumKits
PCM RAM memory	64 MB
Sampling	Record, Edit, Time Slice, Load/Import, Export - PCM RAM Memory: 64MB standard
Effects	4 Stereo Master - TC Helicon for Vocal FX + Final Master EQ
Real Time Tracks	4 (Upper 1/2/3, Lower) - 4 Pads
Performances	320 User Programmable
STYLES DATA	
Factory Styles	Up to 544 locations - Preloaded Styles: 409
User Styles	96 User + 320 Favorite (all 960 styles are re-writable)
Arranger Tracks	8
Style Edit	Record & Edit functions, Guitar Mode, Import/Export SMF
Patterns/Chord Variations	Up to 42 patterns for each style including 3 Intros, 3 Endings, 3 Fills
Style Performance (STS)	Up to 960 × 4 (Real time tracks + Acc. tracks) all programmable
PCM Style Grooves	Using the internal PCM RAM memory
SEQUENCER	
XDS Double Sequencer	Separate transport controls for each Sequencer - Balance Slider
4 STS saved with the Song	In SongBook Mode
Tracks	16 + 16
Sequencer Edit	Record & Edit functions
Backing Sequence (Quick Record)	Real Time Record - Step Record & Edit
Lyrics/Chords	On-Screen (compatible with most popular formats)
Score View	On-Screen
OTHER FEATURES	
MP3	Optional with EXBP-Dual MP3 board. Records MP3 files, and plays two MP3 files at the same time. Tempo change ±30%. Transpose -6~+5 semitones.
Voice Processor	Voice technology by TC Helicon: 3 Parts Harmony, Reverb, Delay, Compressor, Eq.
SongBook and SongBook List	Fully Programmable
Arabic Scale	Programmable, with up to 4 SC Presets
Pads	4 + Stop button
Compatibility	i-Series: Styles - Pa-series: Style, Perf., Sound, Song, Song Book
Operating System	OPOS Multitasking System - Load while playing - Upgradable
Internal SSD Flash memory	256 MB for OS, PCM and all Resources (20 MB reserved to the SSD-User area)
USB for Memory Devices	Yes (2 slots - 1 Host Rear, 1 Host Front)
Hard Disk	Optional with Hard Disk Installation Kit
Amplification	2 × 22 W with Loudness and Semi-Parametric Master EQ
Speakers	4 Speakers (10 cm Woofer + Tweeter) - 2 way - Bass Reflex Box
USER INTERFACE	
Display	320 × 240 Graphical Color Touch Screen Display
Controls	Joystick - Dial - Up/+, Down/-
Programmable Controls	2 Switches + 2 Sliders
Cursors	Real Time: Master Volume - Acc/Seq-Real Time Volume Balance
Switches	Transpose, Memory, Bass Inversion, Manual Bass, Fade, Tap, Synchro, Ensemble
Help System	Multilanguage Hypertext - Contextual
CONNECTIONS	
MIDI	IN - OUT - THRU
USB	2 Host (2.0 Hi Speed) and 1 Device (1.1 Full Speed)
Outputs	4 Analog (Left/Right/Out1/Out2)

Features	KORG Pa800
Inputs	2 Inputs - 1: Mic/Line - 2: Line - with separate gains
Headphone	1 Front jack connection
Pedals	1 Damper - 1 Assignable Footswitch/Pedal - EC5
Power Supply	AC - Universal Voltage
OPTIONS	
USB Memory	Yes
Hard Disk	Hard Disk Installation Kit - not including the HD
CD - FD	Through USB Host - not internal
Video Interface	Graphic Video Interface VIF4 - NTSC/PAL board
MP3	Dual MP3 encoder/decoder EXBP-Dual MP3
Expression/Volume Pedal	Korg EXP-2 - Korg XVP-10
Multi-Switch Pedal	Korg EC5
Damper Pedal	Korg DS-1H (supporting half-pedaling)
Switch Pedal	Korg PS-1
PHYSICAL DATA	
Consumption	40 Watt
Dimensions (W x D x H)	43.7 x 15.3 x 7.1 inches (1110 x 388 x 181 mm) - without music rest
Weight	29,3 lbs (13,3 kg)

Index

A

Aftertouch Curve 216
 Arabic Scale 92, 96
 Assignable Sliders 11, 222
 Audio Inputs 15, 19, 24, 228
 Audio Outputs 19, 24, 226–229
 Auto Style/Perf/Sound Select 221
 Write 231

B

Backup 22, 256
 Balance (Keyboard/Style or Seq) 10, 23
 Balance (Sequencer) 14, 23
 Bank Select 266
 Bass & Lower Backing 107

C

Chord Scanning 15
 Lock 219
 Contrast 14, 15

D

Damper 24, 102
 Demo 24
 Display contrast 14, 15
 Display Hold 15
 Double Sequencer 14, 168
 Drum tracks 100, 104, 227

E

EC5 223
 Effects
 Copy 108, 178, 212
 Sequencer mode 202, 204
 Song Play mode 170, 172
 Style Play mode 94, 98, 204
 Ending 13
 Ensemble 103

F

Fade In/Out 216
 Favorite Styles 110
 Fill 13
 Footswitch 222
 Format 256

G

General MIDI 264
 Global 215–232
 Write
 Global Setup 231
 MIDI Setup 231, 232
 Sequencer Setup 212

Song Play Setup 179
 Style Play Setup 110
 Talk Configuration 232
 Voice Processor Preset 232
 Voice Processor Setup 232

Global channel 264
 Groove Quantize 175

H

Harmony track (Voice Processor) 176, 211
 in SongBook entries 184
 MIDI channel 225
 Note Input Source 236

I

Inputs 15, 19, 24, 228
 Intro 13

J

Jukebox 163, 174

K

Keyboard Mode 16
 Lock 219

L

Local Off 224, 266
 Lower Lock 219
 Lyrics 164, 186

M

Markers 165
 Master Transpose 17, 217
 Master Tune 216
 Master Volume 10, 23
 Media 243–262
 Backup 256
 Format 256
 Menu 15
 MIDI
 Clock 157, 224
 General MIDI 264
 Global channel 264
 IN channels 225
 Interface 19, 266
 OUT channels 225
 Setup 107, 176, 211, 223, 264
 Standard MIDI File 157, 189
 MIDI interface 19, 266
 MIDI Setup 107, 176, 211, 223, 264
 Write 231, 232
 Midifile 157, 189, 264
 Mode
 Pad Record 142–156

- Sequencer 189–214
- Song Play 157–160
- SongBook 180–188
- Style Play 85–110
- Style Record 111–141
- MP3 60, 87, 160, 164, 174, 180
 - Installation 324
 - Recording 325

O

- Octave Transpose 17, 96
 - Auto Octave 219
 - Midi In 224
- Operating Modes 11
- OS (Operating System)
 - Backup 22, 256
 - Update 22
- Outputs 19, 24, 226–229

P

- Pads 16, 105
- Pan
 - Pads 105
 - Song tracks 169, 202
 - Style tracks 94
- PANIC (SHIFT+START/STOP) 13
- PCM Autoload 258
- Pedals 222
- Performance 16, 85
 - Selecting 16, 80
 - Selecting (Auto) 221
 - Writing 109
- Pitch Bend 96, 204
- Program Change 266

Q

- Quarter Tone 92, 96

R

- RX 210

S

- Scale
 - Main scale 217
- Sequencer
 - Link mode 177
 - Sequencer 2 FX mode 177
 - Transport controls 14, 15
- Sequencer mode 189–214
- Shift 14
- Single Touch 12, 14
- Single Touch Setting (STS) 14
 - Selecting 14, 82
 - Writing 109
- Song
 - Markers 165
 - Play from disk 82, 212
 - Recording 191–200
 - Selecting 82, 212

- Standard MIDI File 264
- Song Play mode 157–160
- SongBook 180–188
- Sound
 - Editing 101, 173, 205
 - Selecting 16, 80
 - Selecting (Auto) 221
- Split Point 92, 264
- Standard MIDI File 157, 189, 264
- STS, *See* Single Touch Setting
- Style
 - Ending 13
 - Fill 13
 - Intro 33
 - Recording 111–141
 - Selecting 13, 81
 - Selecting (Auto) 221
 - Style Performance 85
 - Variation 13
- Style Performance
 - Selecting, *see* Style
 - Writing 110
- Style Play mode 85–110
- Style Record mode 111–141
- Synchro Start/Stop 14

T

- Talk
 - Auto On/Off 235
 - On/Off 91
 - Settings 234
 - Write settings 232
- Tap Tempo 13
- Tempo/Value section 15
- Touch Panel
 - Calibration 230
- Track Select 14
- Tracks
 - Drum/Percussion 100, 104, 227
 - Keyboard tracks 16, 85, 158
 - Octave Transpose 17
 - Sounds 16
 - Volume 93, 169, 201
- Transpose 17, 96
 - Auto Octave 219
 - Midi In 224

U

- Upper Volume Link 93, 107
- USB 258

V

- Variation 13
- Velocity Curve 216
- Video Interface 19, 230, 327
- Voice Processor
 - Harmony Track 176, 184, 211
 - MIDI channel 225
 - Note Input Source 236
- Voice Processor Preset
 - Editing 235

- Lock 219
- Writing 232
- Voice Processor Setup
 - Editing 229, 233
 - Writing 232
- Volume
 - Balance 85, 157
 - Balance (Keyboard/Style or Seq) 10, 23
 - Balance (Sequencer) 23
 - Individual tracks
 - Sequencer 201
 - Song Play 169
 - Style Play 93
 - Master 10, 23, 85, 157

KORG

Address

KORG ITALY SpA
Via Cagiata, 85
I-60027 Osimo (An)
Italy

Web

www.korgpa.com
www.korg.co.jp
www.korg.com
www.korg.co.uk

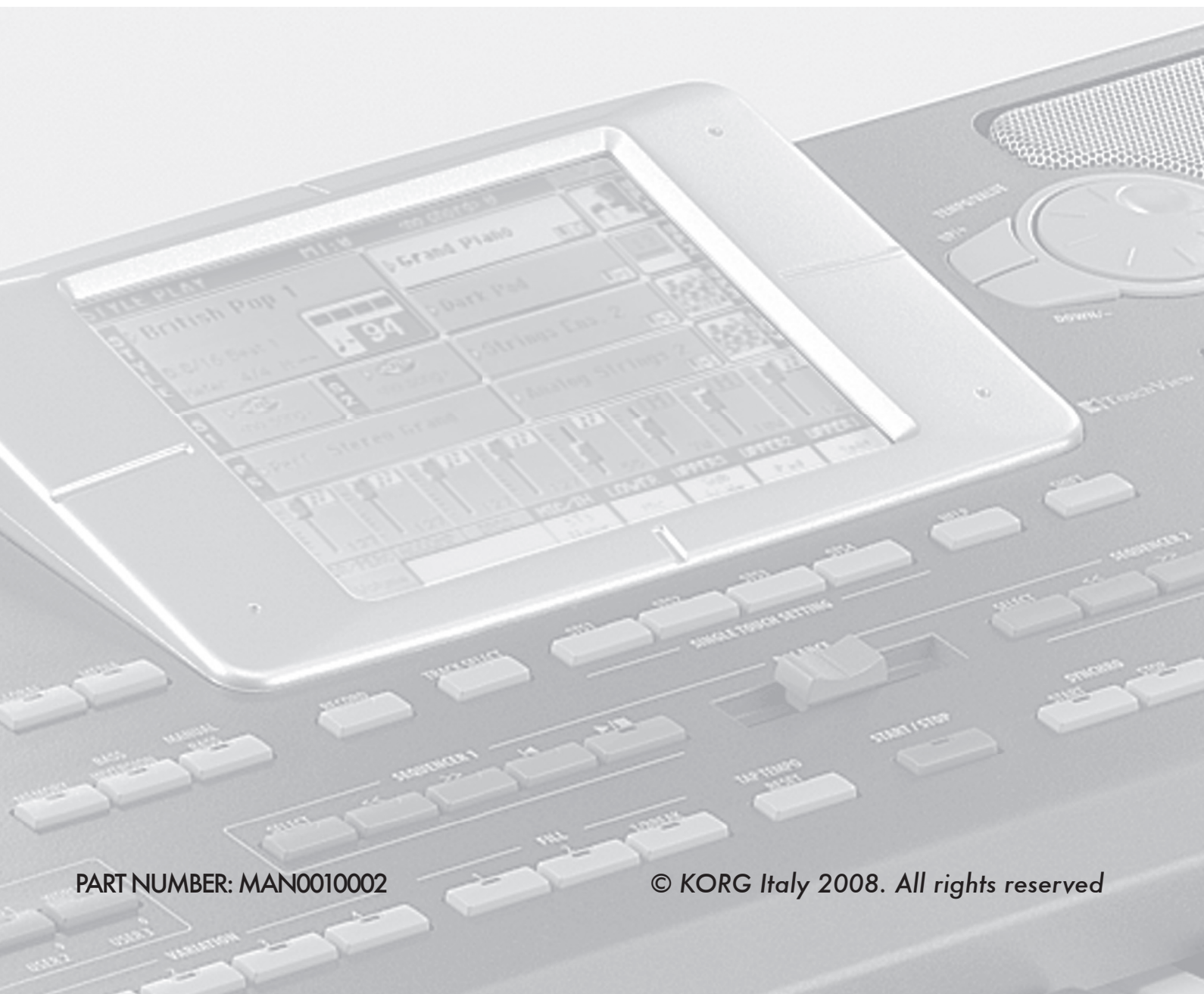

PART NUMBER: MAN0010002

© KORG Italy 2008. All rights reserved