

KORG

E 1

ENGLISH
OS Ver. 1.0

Pa588

professional
arranger

Advanced Edit



Table of Contents

Sound operating mode	1	LFO: LFO2	20
The MIDI channel	1	Effects: FX Select	20
How to select oscillators	1	Effects: FX1	21
Sounds, Drum Kits	1	Effects: FX2	21
Main page	1	Page menu	21
Edit menu	3	Write Sound dialog box	22
Edit page structure	3	Copy Oscillator dialog box	22
Basic: Sound Basic	3	Copy FX dialog box	22
Basic: OSC Basic	4	Copy Drum Kit dialog box	23
Basic: Vel/Key Zone	5	AMS (Alternate Modulation Source) list	24
DrumKit: Sample Setup (Drum Kits)	6	Effects	26
DrumKit: Voice Mixer (Drum Kits)	7	Dynamic Modulation sources	26
Pitch: Pitch Mod	8	Dynamics (Dynamic)	27
Pitch: Pitch EG	9	EQ and Filters (EQ/Filter)	31
Filter: Filter Type	11	Overdrive, Amp models, and Mic models (OD Amp Mic)	39
Filter: Filter Mod	12	Chorus, Flanger, and Phaser (Cho/Fln Phaser)	44
Filter: Filter LFO	13	Modulation and Pitch Shift (Mod./P.Shift)	50
Filter: Filter EG	14	Delay	61
Amp: Amp Level/Pan	16	Reverb and Early Reflections (Reverb ER)	71
Amp: Amp Mod	16	Mono-Mono Serial (Mono-Mono)	73
Amp: Amp EG	17	Double Size	90
LFO: LFO1	19		

Sound operating mode

The Sound operating mode is where you can listen to individual Sounds, and edit them.

To select a Sound, see the “Basic operations” chapter.

In this mode, the selected Sound can always be played across the full keyboard range.

While in a different operating mode, you can easily select the Sound to be edited when switching to the Sound mode. Just select the track the Sound to be edited is assigned to, then keep the SHIFT button pressed while pressing the SOUND button.

Hint: This is useful to see the Bank Select/Program Change numbers when programming a Song on an external sequencer.

Note: The Sound uses the same Scale of the latest selected Performance or STS.

The MIDI channel

In Sound mode, Pa588 receives and transmits on the same channel of the Upper 1 track. If the Global channel is assigned, notes can be received also on this channel. See “MIDI: MIDI In Channels” and “MIDI: MIDI Out Channels” in the Global chapter of the User’s Manual for more information.

How to select oscillators

While in an edit page requiring an oscillator to be selected for editing, use the vertical row of buttons on the right (1...16 max) to select one of the available oscillators. The number of available oscillators depends on the “Oscillators Count” parameter (see page 3).

If you cannot see the desired oscillator, press the scroll arrow, until the hidden oscillator is shown in the display.

When oscillators cannot be select, since the parameter contained in the current page are global and valid for the whole Sound, these buttons are greyed out, and cannot be selected.

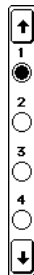

Sounds, Drum Kits

Pa588 features two different kinds of Sounds:

- Ordinary Sounds. These are normal instrument Sounds, like pianos, strings, basses.
- Drum Kits. These are drum and percussion kits, where each note of the keyboard is a different percussive instrument. You can find Drum Kits in the DRUM & PERC and USER DK banks.

Before pressing MENU to enter the edit environment, you should select a Sound of the type you wish to edit or create.

Note: Notes pointing to special Drum Kit features are marked by the **DRUM** icon.

Main page

Here is the main page of the Sound operating mode:

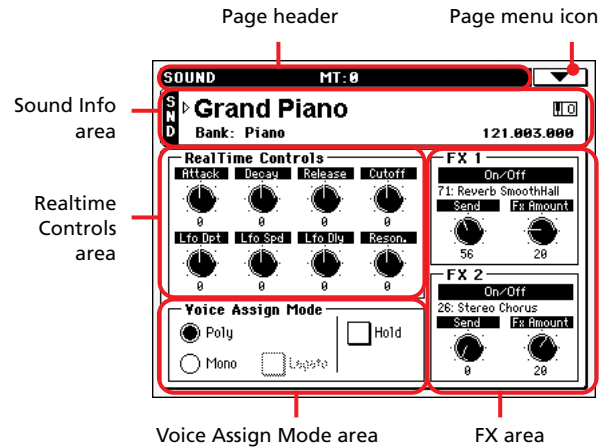

Page header

This line shows the current operating mode and transposition.



Operating mode name Master Transpose (in semitones)

Operating mode name

Name of the current operating mode.

Master transpose

Master transpose value in semitones. This value can be changed using the TRANSPOSE buttons on the control panel.

Page menu icon

Press the page menu icon to open the menu. See “Page menu” on page 21 for more information.



Sound Info area

This is where basic details for the Sound are shown. Press anywhere in this area to open the Sound Select window.

Sound name

Name of the Sound assigned to the corresponding Keyboard track.

Bank

Bank the current Sound belongs to.

Bank Select / Program Change sequence

Bank Select MSB / Bank Select LSB / Program Change numbers, in the form “CC00.CC32.PC”.

CC00	This section shows the value of the Control Change (CC) 00 message (or Bank Select MSB) for the selected Sound.
CC32	This section shows the value of the Control Change (CC) 32 message (a.k.a. Bank Select LSB) for the selected Sound.
PC	This section shows the value of the Program Change (PC) message for the selected Sound. Values are in the standard 0-127 MIDI numbering format. <i>Note: Some manufacturers could use the 1-128 numbering system; when connecting your Pa588 to an instrument of this kind, increment the PC value by 1 unit.</i>

Octave Transpose icon

Octave transpose value. Use the UPPER OCTAVE buttons to change this value.

Realtime Controls area

Controls in this area allow you to edit the main parameters of the Sounds assigned to each track. Touch one of them, and modify its value by using the TEMPO/VALUE dial (or moving your finger).

Note: All values refer to the original values of the Sound.

Note: When selecting the Write Sound command from the page menu, current parameter values, after editing the Realtime Controls, are saved with the Sound. After saving, Realtime Controls are set back to the default position.

Note: After selecting a different Sound, Realtime Control values are automatically set to zero.

Attack	Attack time. This is the time during which the sound goes from zero (at the moment when you strike a key) to its maximum level.
Decay	Decay time. Time to go from the final Attack level to the beginning of the Sustain.
Release	Release time. This is the time during which the sound goes from the sustaining phase, to zero. The Release is triggered by releasing a key.
Cutoff	Filter cutoff. This sets the sound brightness.
LFO Depth	Intensity of the Vibrato (LFO).
LFO Speed	Speed of the Vibrato (LFO).
LFO Delay	Delay time before the Vibrato (LFO) begins, after the sound starts.
Resonance	Use the Filter Resonance to boost the cutoff frequency.

Voice Assign Mode

Poly

The Sound will play polyphonically, allowing you play chords.

Mono

The Sound will play monophonically, producing only one note at a time.

Hold

Use this parameter to keep the notes sustained even after releasing the keys.

Note: Please remember the Hold must be On before playing the note to be held.

Legato

This parameter is available when the Mono option is selected.

Note: If “Legato” is On, certain multisamples or keyboard locations may produce an incorrect pitch.

On Legato is on. When multiple note-on's occur, the first note-on will retrigger the sound, and the second and subsequent note-on's will not retrigger.

When legato is on, multiple note-on's will not retrigger the voice. If one note is already on and another note is turned on, the first voice will continue sounding. The oscillator sound, envelope, and LFO will not be reset, and only the pitch of the oscillator will be updated. This setting is effective for wind instrument sounds and analog synth-type sounds.

Off Legato is off. Notes will always be retriggered when note-on occurs.

When legato is off, multiple note-on's will retrigger the voice at each note-on. The oscillator sound, envelope, and LFO will be reset (and retriggered) according to the settings of the Sound.

FX Area

In Sound mode, the Sound uses its own effects instead of relying on A-D effects. Two effect processors (FX1 and FX2) are available.

On/Off

Use this button to turn on or off the corresponding effect.

Note: When an effect parameter is edited, this parameter is automatically set to On.

Note: If the FX1 and FX2 effects have been set to Off, FX Send values are set to zero when saving the Sound.

Selected Effect

Non editable. This shows the effect assigned to the corresponding FX processor. To select a different effect, see “FX1/2” on page 20.

Send

Use this knob to adjust the level of the dry sound sent to the corresponding effect.

FX Amount

Volume of the effect, that is added to the dry (unaffected) signal.

Edit menu

From any page, press the MENU button to open the Sound edit menu. This menu gives access to the various Sound edit sections.

When in the menu, select an edit section, or press EXIT or SOUND to exit the menu and return to the main page. To return to the main page, you can also select the Main Page menu item.

When in an edit page, press EXIT or the SOUND button to return to the main page of the Sound operating mode.

- When an ordinary Sound is selected:

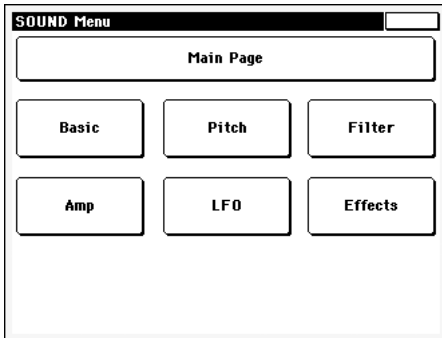

- When a Drum Kit is selected, the “Basic” section is replaced by the “DrumKit” section:

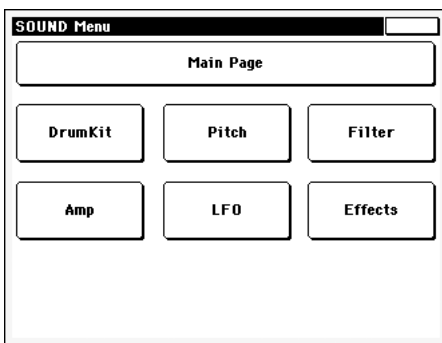

Each item in this menu corresponds to an edit section. Each edit section groups various edit pages, that may be selected by pressing the corresponding tab on the lower part of the display.

Edit page structure

All edit pages share some basic elements.

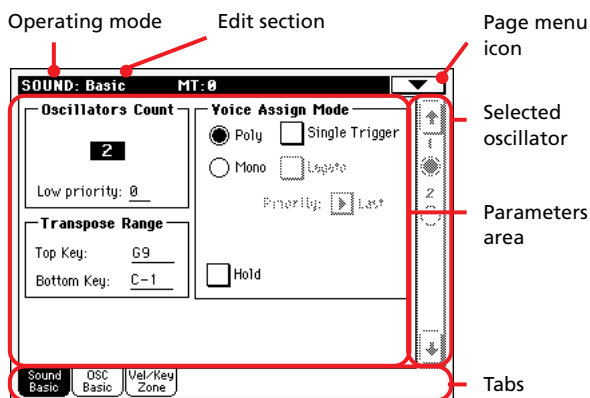

Operating mode

This indicates that the instrument is in Sound mode.

Edit section

This identifies the current edit section, corresponding to one of the items of the edit menu (see “Edit menu” on page 3).

Page menu icon

Press this icon to open the page menu (see “Page menu” on page 21).

Selected oscillator

Use these buttons to select the oscillator to edit.

Parameters area

Each page contains various parameters. Use the tabs to select one of the available pages. For detailed information on the various types of parameters, see sections starting from page 3.

Tabs

Use tabs to select one of the edit pages of the current edit section.

Basic: Sound Basic

Here you can make basic settings for the Sound, such as basic oscillator settings, the oscillator count, and the polyphonic mode.

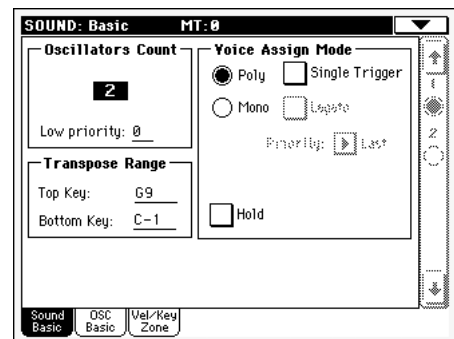

Oscillators Count

Use this box to specify the number of oscillators (up to 16) the Sound is based on.

The total amount of polyphony varies depending on the number of oscillators used by the Sound (a maximum of 80 with only 1 oscillator per voice).

Low priority

Use this parameter to decide if the highest-numbered oscillators must be turned off when more polyphony voices are needed. Keep in mind that, with a dense polyphony, missing oscillators might not even be heard.

- 0 No oscillator will be turned off in any case.
- 1 The highest-numbered oscillator will be turned off, if needed.
- 2 The two highest-numbered oscillators can be turned off, one after the other, if needed.

[n]...16 The n-numbered oscillators (up to 16) can be turned off, one after the other, if needed.

Voice Assign Mode

This is the polyphonic mode of the Sound.

Poly The Sound will play polyphonically, allowing you to play chords.

Mono The Sound will play monophonically, producing only one note at a time.

Single Trigger

This parameter is available when the selected mode is Poly.

On When the same note is played repeatedly, the previous note will be silenced before the next note is sounded, so that the notes do not overlap.

Off When the same note is played repeatedly, the previous note will not be silenced before the next note is sounded.

Legato

This parameter is only available when the selected mode is Mono. It is the same found on the main page of the Sound mode.

See “Legato” on page 2 for information on this parameter.

Priority

This parameter is available when the selected mode is Mono. It specifies which note will be given priority to play when two or more notes are played simultaneously.

Low Lowest note will take priority.

High Highest note will take priority.

Last Last note will take priority.

Hold

Use this parameter to keep the notes sustained even after releasing the keys.

Transpose Range

Use these parameters to set a range for transposition. Inside this range notes are transposed. Outside this range, they are not transposed. This is useful to avoid RX Sounds being transposed when transposing a Sound.

Basic: OSC Basic

The multisample(s) on which the Sound will be based can be selected here for each of the sixteen oscillators. Each oscillator can use 1 or 2 multisamples, each one assigned to the High or Low layer.

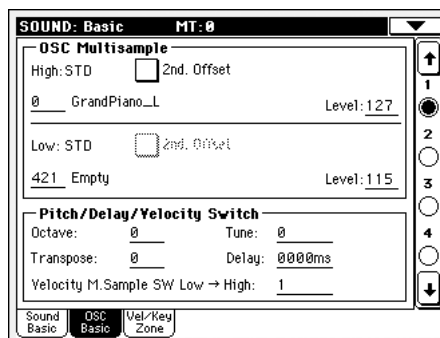

OSC Multisample

High/Low Multisample Number/Name

Use these parameters to select a different multisample for each of the High and Low layers. You can use velocity to switch between the two multisamples. Offset and Level can be adjusted independently for the High and Low multisamples.

The numeric field under the High or Low parameters it is for selecting a multisample. The multisample name appears on its right.

The multisample you select for the High layer will be triggered by velocities higher than the value of the “Velocity Multisample Switch Low-High” parameter (see page 5). If you do not wish to use velocity switching, set the switch to a value of 001, and select only the High multisample.

Note: Each multisample has an upper note range limit, and cannot produce sound when played above that limit.

2nd Offset

These parameters specify the point where the multisample(s) will begin to play. For some multisamples this parameter will not be available.

On The sound will begin from the offset location pre-determined for each multisample.

Off The sound will start from the beginning of the multisample waveform.

Level

These parameters specify the level of each multisample.

0...127 Multisample level.

Note: Depending on the multisample, high settings of this parameter may cause the sound to distort when a chord is played. If this occurs, lower the level.

Pitch/Delay/Velocity Switch

Octave

Use this parameter to adjust the pitch of the selected oscillator in octave units. The normal octave of the multisample is “0”.

-2...+1 Octave transposition.

Transpose

Use this parameter to adjust the pitch of the selected oscillator in semitone steps over a range of ± 1 octave.

-12...+12 Transposition in semitones.

Tune

Use this parameter to adjust the pitch of the sample in one-cent steps (a semitone is 100 cents) over a range of ± 1 octave.

-1200...+1200
Fine-tune value in cents.

Delay

This parameter sets a delay time from the note-on to the real beginning of the sound. With a setting of KeyOff, the sound will begin when note-off occurs. This is useful to create sounds such as the “click” that is heard when a harpsichord note is released. In this case, set the “Sustain” parameter to 0 (see page 14).

Key Off The sound will begin when the note is released.

0...5000ms Delay time in milliseconds.

Velocity Multisample Switch Low-High

This is the velocity value dividing the High and Low layers for the selected oscillator. Notes struck harder than this value will be played by the High multisample.

Basic: Vel/Key Zone

Here you can set a note and velocity range “window” for the selected oscillator.

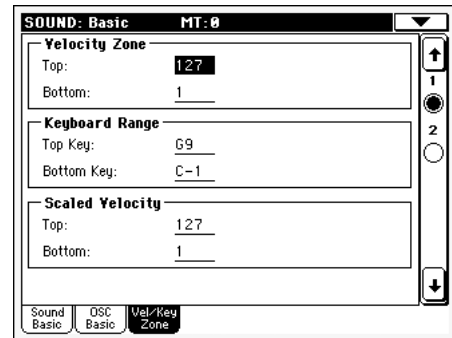

Velocity Zone

Here you can specify the velocity range for the selected oscillator.

Note: You cannot set the Bottom Velocity higher than the Top Velocity, nor the Top Velocity lower than the Bottom Velocity.

0...127 Assigned velocity.

Keyboard Range

Here you can specify the note range for the selected oscillator.

Note: You cannot set the Bottom Key higher than the Top key, nor the Top Key lower than the Bottom key.

C-1...G9 Assigned note.

Scaled Velocity

Use these parameters to scale velocity values received by the oscillator. By using the “Velocity Zone” function (see above), an oscillator may be limited to a restricted range (say, 10 to 20), that may result in weak dynamics when the associated sample is triggered.

By assigning a different value to these parameters, the restricted range will be converted to a wider range (for example, the lowest range value of 10 may be converted to a Scaled Velocity value of 0, and the highest range value of 20 may be converted to a Scaled Velocity value of 127). All values included between the minimum and maximum value are scaled accordingly.

As a consequence, you can create an RX Sound of guitar, by assigning the guitar fret noise to the 10~20 velocity range. When a dynamics value between 10~20 is received, the real velocity value is scaled to the Scaled Velocity values, and plays louder.

0...127 Assigned velocity value.

DrumKit: Sample Setup (Drum Kits)

This page appears when you edit a Drum Kit. Here you can select a different percussive sample for each key and layer.

DRUM Drum Kits use only one oscillator.

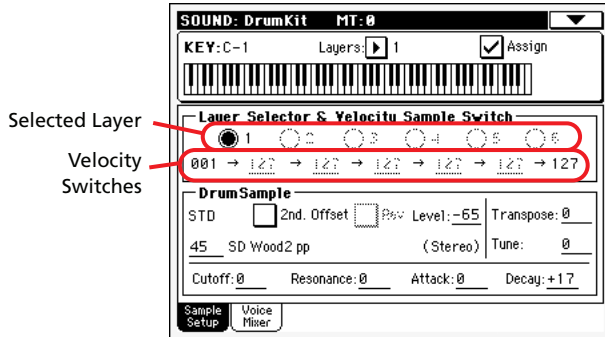

Key

Key

Key in edit. You can press a key on the keyboard, while this parameter is selected, to select a key.

Layers

Number of layers assigned to the selected key. Depending on the number of selected layers, you can have a different number of velocity switches.

Assign

Use this parameter to turn the sample on/off.

- On The sample is assigned to the selected key.
- Off The sample is not assigned. The sample assigned to the next highest assigned key is used instead.

Layer Selector & Velocity Sample Switch

Selected Layer

Use these radio buttons to select the layer to edit. The available layers depends on the “Layers” parameter.

Velocity Switches

Each of these values separates the two adjacent layers for the selected sample/key. Notes stricken harder than a velocity switch will be played by the layer on the right, while notes stricken softer are played by the layer on the left.

The first and last values are not editable, and are always 001 and 127 (respectively).

Drum Sample

Drum Sample Number/Name

Use this parameter to select a different Drum Sample for each layer. You can use velocity to switch between the available samples. Offset and Level can be adjusted independently for the various multisamples.

Use the numeric field to select the sample. The sample name appears on its right.

The sample you select for the current layer will be triggered by velocities higher than the value of the “Velocity Switches” parameter (see page 6). If you do not wish to use velocity switching, assign just one layer to the selected key, and assign a sample only to Layer 1.

Note: Each sample has an upper note range limit, and may not produce sound when played above that limit.

2nd Offset

These parameters specify the point where the sample will begin to play. For some samples this parameter will not be available.

- On The sound will begin from the offset location pre-determined for each sample.
- Off The sound will start from the beginning of the sample.

Level

This parameter specifies the level of the sample. For more information, see “Level” on page 4.

Mono/Stereo indicator

Non editable. This indicator tells if the selected sample is mono (one voice per note) or stereo (two voices per note).

Transpose

This parameter transposes the selected sample. Use it to change the pitch of the selected key.

- 0 No transposition applied.
- 64...+63 Transpose value in semitones.

Tune

Use this parameter to fine-tune the assigned sample.

- 0 Original tuning.
- 99...+99 Fine-tuning value in cents (1/100 of a semitone).

Cutoff

This parameter sets the cutoff frequency for the filter applied to the selected sample.

Resonance

This parameter sets the resonance for the filter applied to the selected sample.

Attack

This parameter is an offset to the selected sample’s EG Attack.

Decay

This parameter is an offset to the selected sample’s EG Decay.

DrumKit: Voice Mixer (Drum Kits)

This page appears when you edit a Drum Kit. Here you can set various parameters for the different percussive sample assigned to the selected key and layer.

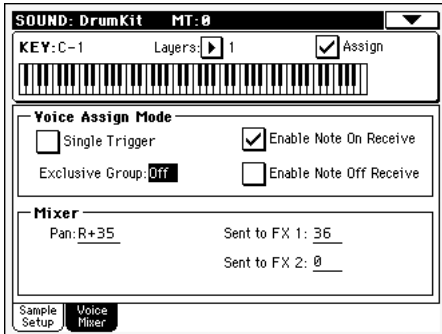

Key

See “Key” on page 6.

Voice Assign Mode

Single Trigger

Use this parameter to set the sample as a single-triggered one.

- On When the same key (note) is played repeatedly, the previous note will be stopped before the new note is triggered, so that they will not overlap.
- Off When the same key (note) is played repeatedly, the previous note will not be stopped before the new note is triggered.

Exclusive Group

Exclusive Groups are sets of mutually exclusive keys, stopping each other. For example, if the Open Hi-Hat and Closed Hi-Hat are assigned the same Exclusive Group, playing an Open Hi-Hat will stop the Closed Hi-Hat playing.

- None No Exclusive Group assigned. The selected key will not be stopped by any other key.
- 1...127 Exclusive Groups assigned to the selected key. When you play this key, all other keys assigned to the same Exclusive Group will be stopped, and this key will be stopped by other keys assigned to the same Exclusive Group.

Enable Note On Receive

Use this parameter to enable/disable the reception of the Note On (Key On) message.

- On The Note On message is normally received.
- Off The Note On message is not received. Therefore, the corresponding key is muted.

Enable Note Off Receive

Use this parameter to enable/disable the reception of the Note Off (Key Off) message.

- On The sound will stop as soon as you release the key.
- Off The sound will continue playing up to the end of the sample. The Note Off message is ignored.

Mixer

Pan

This parameter sets the position in the stereo panorama of the selected key.

Send FX1

This parameter sets the FX1 send level for of the selected key.

Send FX2

This parameter sets the FX2 send level for of the selected key.

Pitch: Pitch Mod

Here you can make pitch settings for each oscillator. These settings specify how keyboard location will affect the pitch of each oscillator, and select the controllers that will affect the oscillator pitch and specify the depth of control. You can also specify the amount of pitch change produced by the Pitch EG and by LFO1 and LFO2, switch portamento on/off and specify how it will apply.

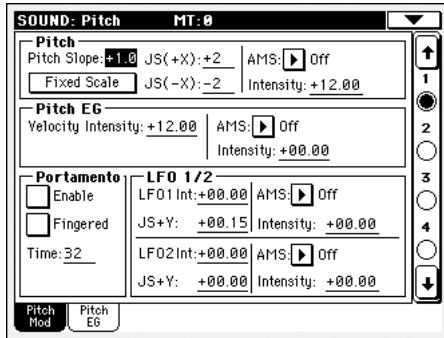

Pitch

Pitch Slope

Normally you will leave this parameter at +1.0. Positive (+) values will cause the pitch to rise as you play higher notes, and negative (-) values will cause the pitch to fall as you play higher notes.

With a value of 0, there will be no change in pitch, and the C4 pitch will sound regardless of the keyboard location you play.

The diagram shows how the Pitch Slope and pitch are related:

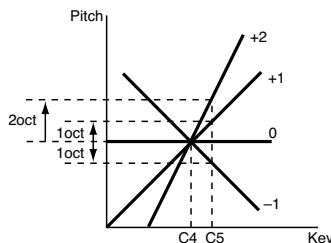

-1.0...+2.0 Pitch slope value.

Fixed Scale

When this parameter is turned on on an oscillator, Pitch Bend and Sub Scale have no effect on its tuning. The relevant parameters are greyed out and non-selectable:

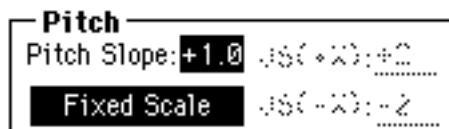

This is useful when assigning to the oscillator a noise (like the breath noise of a reed) with a fixed frequency, that must not change on different notes and different pitches.

JS (+X)

This parameter specifies how the pitch will change when the joystick is moved all the way to the right. A setting of 12 produces 1 octave of change.

For example if you set this to +12 and move the joystick all the way to the right, the pitch will rise one octave above the original pitch.

-60...+12 Maximum pitch change in semitones.

JS (-X)

This parameter specifies how the pitch will change when the joystick is moved all the way to the left. A setting of 12 produces 1 octave of change.

For example, if you set this to -60 and move the joystick all the way to the left, the pitch will fall five octaves below the original pitch. This can be used to simulate the downward swoops that a guitarist produces using the tremolo arm.

-60...+12 Maximum pitch change in semitones.

AMS (Alternate Modulation Source)

This parameter selects the source that will modulate the pitch of the selected oscillator. See "AMS (Alternate Modulation Source) list" on page 24.

Intensity

This parameter specifies the depth and direction of the effect produced by "AMS". With a setting of 0, no modulation will be applied. With a setting of 12.00, the pitch will change up to one octave.

For example, if you set "AMS" to After Touch and apply pressure to the keyboard, the pitch will rise if this parameter is set to a positive (+) value, or fall if this parameter is set to a negative (-) value. The range is a maximum of one octave.

-12.00...+12.00

Parameter value.

Pitch EG

The Pitch EG (Envelope Generator) is unique to all oscillators.

Velocity Intensity

This parameter specifies the depth and direction of the modulation that the pitch EG specified on "Pitch: Pitch EG" will apply to the pitch. With a setting of 12.00, the pitch will change a maximum of ± 1 octave.

-12.00...+12.00

Parameter value.

Pitch EG AMS (Alternate Modulation Source)

This parameter selects the source that will modulate the pitch EG of the selected oscillator. See "AMS (Alternate Modulation Source) list" on page 24).

Pitch EG Intensity

This parameter specifies the depth and direction of the effect that "AMS" will have. For example, if you set "AMS" to Velocity and set this value to +12.00, the velocity will control the range of pitch change produced by the pitch EG in a range of ± 1 octave.

As you play more softly, the pitch change will draw closer to the pitch EG levels.

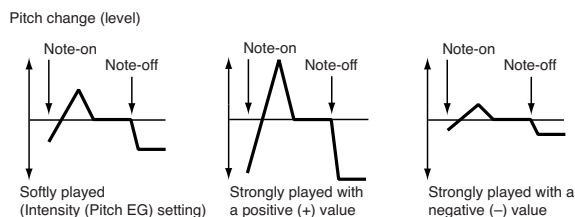

Note: “Intensity” (Pitch EG) and AMS will be added to determine the depth and direction of the pitch modulation applied by the pitch EG.

Portamento

Enabled

This parameter turns the portamento effect (smooth change in pitch from one note to the next) on/off, and specifies how it will be applied.

Note: Portamento will also be switched when CC#65 (Portamento SW) is received.

- On Portamento will be applied.
- Off Portamento will not be applied.

Fingered

This parameter specifies whether the portamento effect restarts or not with each note played.

- On Portamento will restart with each note.
- Off Portamento will not restart with each note.

Time

This parameter sets the portamento time. Increasing the value will produce a slower change in pitch.

- 000...127 Portamento time in MIDI value.

Pitch: Pitch EG

Here you can make settings for the pitch EG, which creates time-variant changes in the pitch of the oscillators. The depth of pitch change produced by these EG settings on the oscillators is adjusted by the “Intensity (AMS1/2 Intensity)” parameter (see page 10).

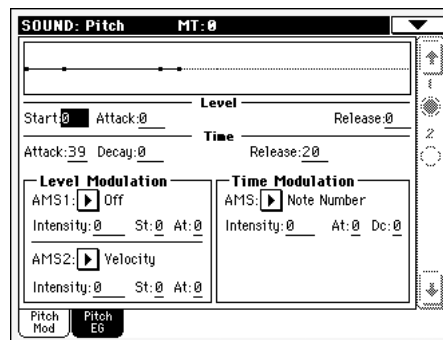

Diagram

The diagram on top of the page shows the Pitch envelope line.

Level

These parameters specify the amount of pitch change. The actual amount of pitch change will depend on the “Intensity (AMS1/2 Intensity)” parameter (see below). For example, with an “Intensity” setting of +12.00, a “Level” setting of +99 would raise the pitch one octave, and a “Level” setting of -99 would lower the pitch one octave.

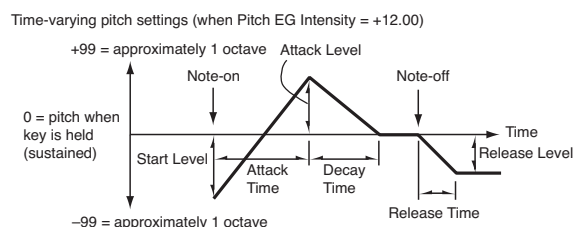

Start Level

Specifies the amount of pitch change at note-on.

- 99...+99 Parameter value.

Attack Level

Specifies the amount of pitch change when the attack time has elapsed.

- 99...+99 Parameter value.

Release Level

Specifies the amount of pitch change when the release time has elapsed.

- 99...+99 Parameter value.

Time

These parameters specify the time over which the pitch change will occur.

See diagram above.

Attack Time

Specifies the time over which the pitch will change from note-on until it reaches the pitch specified as the attack level.

0...99 Parameter value.

Decay Time

Specifies the time over which the pitch will change after reaching the attack level until it reaches the normal pitch.

0...99 Parameter value.

Release Time

Specifies the time over which the pitch will change from note-off until it reaches the pitch specified as the release level.

0...99 Parameter value.

Level Modulation

Pitch EG change (level) (AMS=JS-Y/Velocity, Intensity= positive (+) value)

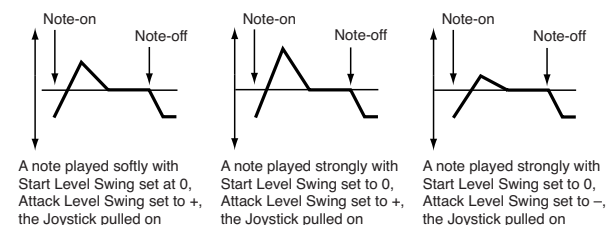

AMS1/2 (Alternate Modulation Source 1/2)

These parameters select the source that will control the pitch EG “Level” parameters (“AMS (Alternate Modulation Source) list” on page 24).

Intensity (AMS1/2 Intensity)

These parameters specify the depth and direction of the effect applied by “AMS1”. With a setting of 0, the levels specified by “Level” will be used.

For example if “AMS1” is After Touch, pressing the keys to turn it on will change the “Level” parameters of the Pitch EG. As the absolute value of “Intensity” is increased, the pitch EG levels will change more greatly when the key pressure is released. The direction of the change is specified by “St (Start Level Swing)” and “At (Attack Level Swing)”. When the key pressure is released, the pitch EG levels will return to their own settings.

If “AMS1” is set to Velocity, increasing the absolute value of “Intensity” will produce increasingly wider change in pitch EG levels for strongly-played notes. The direction of the change is specified by “St (Start Level Swing)” and “At (Attack Level Swing)”. As you play more softly, the pitch change will draw closer to the pitch EG levels.

-99...+99 Parameter value.

St (Start Level Swing)

This parameter specifies the direction of change in “Start Level” caused by “AMS1/2”. If “Intensity” is a positive (+) value, a setting of + will raise the EG level, and a setting of – will decrease it. With a setting of 0 there will be no change.

At (Attack Level Swing)

This parameter specifies the direction of change in “Attack Level” caused by “AMS1/2”. If “Intensity” is a positive (+) value, a setting of + will raise the EG level, and a setting of – will decrease it. With a setting of 0 there will be no change.

Time Modulation

Pitch EG changes (Time) (AMS = Velocity, Intensity = positive (+) value)

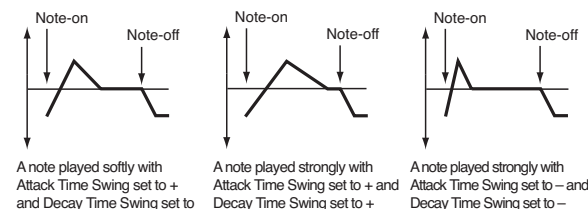

AMS (Alternate Modulation Source)

This parameter selects the source that will control the “Time” parameters of the pitch EG (see “AMS (Alternate Modulation Source) list” on page 24).

Intensity (AMS Intensity)

This parameter specifies the depth and direction of the effect that “AMS” will have on the “Time” parameters. With a setting of 0, the pitch EG times will be just as specified by the “Time” settings.

The alternate modulation value at the moment that the EG reaches each point will determine the actual value of the EG time that comes next.

For example, the decay time will be determined by the alternate modulation value at the moment that the attack level is reached.

When this parameter is set to values of 16, 33, 49, 66, 82, or 99, the specified EG times will speed up as much as 2, 4, 8, 16, 32, or 64 times respectively (or slowed down to 1/2, 1/4, 1/8, 1/16, 1/32, or 1/64 of the original time).

For example if “AMS” is set to Velocity, increasing the absolute value of “Intensity” will allow strongly-played notes to increase the changes in pitch EG “Time” values. The direction of the change is specified by “At (Attack Time Swing)” and “Dc (Decay Time Swing)”. As you play more softly, the pitch EG times will more closely approach the actual settings of the pitch EG.

-99...+99 Parameter value.

At (Attack Time Swing)

This parameter specifies the direction in which “AMS” will affect the “Attack Time” parameter. With positive (+) values of “Intensity”, a setting of + will cause the time to be lengthened, and a setting of – will cause the time to be shortened. With a setting of 0 there will be no change.

Dc (Decay Time Swing)

Specify the direction in which “AMS” will affect the “Decay Time”. With positive (+) values of “Intensity”, a setting of + will cause the time to be lengthened, and a setting of – will cause the time to be shortened. With a setting of 0 there will be no change.

Filter: Filter Type

Here you can make settings for the filters that will be used by the oscillators. You can select either a 24 dB/octave low pass filter with resonance, or a series connection of a 12 dB/octave low pass filter and a 12 dB/octave high pass filter.

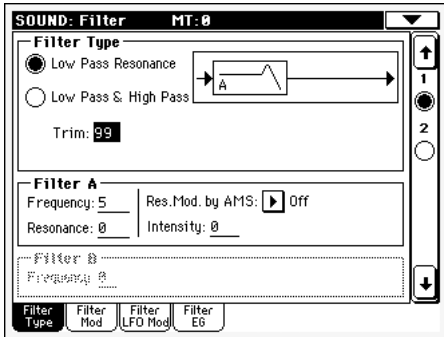

Filter Type

This parameter selects the type of filter (Low Pass Resonant, Low Pass & High Pass) for the selected oscillator.

Low Pass Resonance

When the Low Pass filter type is selected, only filter A will be activated.



Low Pass & High Pass

When the Low Pass & High Pass filter type is selected, the filter B will be activated.



Trim

Use this parameter to adjust the level at which the audio signal output from the selected oscillator is input to filter A.

Note: If this value is raised, the sound may distort if Resonance is set to a high value or when you play a chord.

00...99 Trim level.

Filter A

Frequency (Cutoff Frequency A)

This parameter specifies the cutoff frequency of filter A.

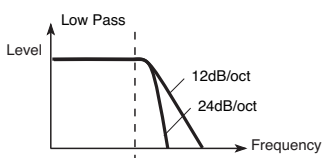

This is a filter that cuts the high-frequency region above the cutoff frequency. This is the most common type of filter, and is used to cut part of the overtone components, making an originally bright timbre sound more mellow (darker). When the "Filter Type" is Low Pass Resonance, the cutoff will have a steeper slope.

00...99 Cutoff frequency value.

Resonance (Resonance A)

The resonance emphasizes the overtone components that lie in the region of the cutoff frequency specified by "Frequency", producing a more distinctive sound. Increasing this value will produce a stronger effect.

00...99 Resonance value.

Res. Mod. by AMS (Resonance modulated by AMS)

Selects the source that will control the "Resonance" level. See "AMS (Alternate Modulation Source) list" on page 24.

The effect of resonance

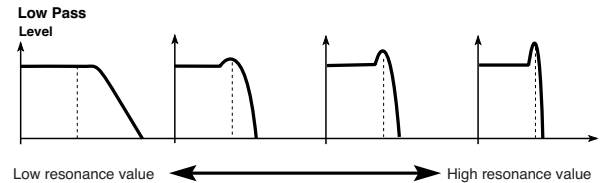

Intensity (AMS Intensity)

This parameter specifies the depth and direction of the effect that "Res. Mod. by AMS (Resonance modulated by AMS)" will have on the resonance level specified by "Resonance (Resonance A)".

For example if Velocity has been selected, changes in keyboard velocity will affect the resonance.

With positive (+) values, the resonance will increase as you play more strongly, and as you play more softly the resonance will approach the level specified by the "Resonance" setting.

With negative (-) values, the resonance will decrease as you play more strongly, and as you play more softly the resonance will approach the level specified by the "Resonance" setting.

The resonance level is determined by adding the "Resonance" and "Intensity (AMS Intensity)" values.

-99...+99 Parameter value.

Filter B

Frequency (Cutoff Frequency B)

This parameter specifies the cutoff frequency of filter B. This parameter will be displayed when "Filter Type" is set to Low Pass & High Pass.

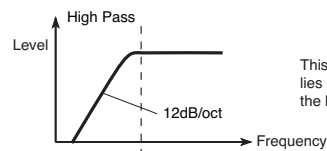

This filter cuts the low-frequency range that lies below the cutoff frequency. By cutting the lower overtones, it lightens the tone.

00...99 Cutoff frequency value.

Filter: Filter Mod

These settings let you apply modulation to the cutoff frequency (“Frequency”) of the filter for the selected oscillator to modify the tone.

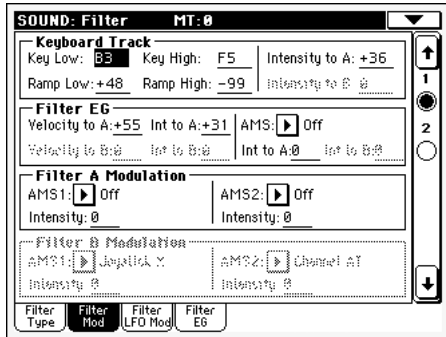

When “Filter Type” is Low Pass Resonance, parameters for filter B will not be editable (greyed out).

Keyboard Tracking

Key Low/High

These settings specify keyboard tracking for the cutoff frequency of the filter for the selected oscillator. The way in which the cutoff frequency is affected by the keyboard location you play can be specified by the “Key Low”, “Key High”, “Ramp Low” and “Ramp High” parameters.

Keyboard tracking will apply to the range below the specified Low note number, and above the specified High note number.

C-1...G9 Lowest/Highest note in the range.

Ramp Low/High

These parameter specifies the angle of keyboard tracking.

If “Intensity to A” and “Intensity to B” are set to +50, “Ramp Low” is set to -62 and “Ramp High” is set to +62, the angle of the change in cutoff frequency will correspond to the keyboard location (pitch). This means that the oscillation that occurs when you increase the “Resonance (Resonance A)” will correspond to the keyboard location.

If you set “Ramp Low” to +43 and “Ramp High” to -43, the cutoff frequency will not be affected by keyboard location. Use this setting when you do not want the cutoff frequency to change for each note.

-99...+99 Angle value.

Here is how cutoff frequency is affected by keyboard location and the Ramp setting (“Intensity to A” and “Intensity to B” = +50):

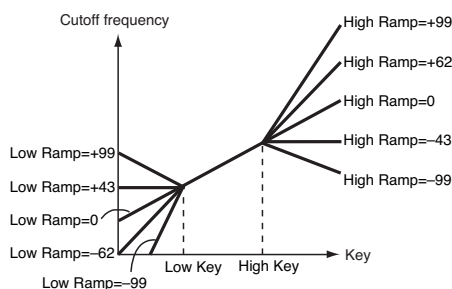

Tracking to A/B

These parameters specify the note numbers at which keyboard tracking will begin to apply, and set the “Intensity to A” and “Intensity to B” parameters to specify the depth and direction of the change applied to filters A and B.

For the range of notes between “Key Low” and “Key High”, the cutoff frequency will change according to the keyboard location (pitch).

-99...+99 Parameter value.

Filter EG

Changes in cutoff frequency

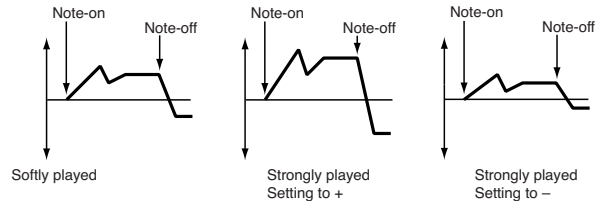

Velocity to A

This parameter specifies the depth and direction of the effect that velocity will have on the time-varying changes created by the filter EG (as set on “Filter: Filter EG”) to control the filter A cutoff frequency.

With positive (+) values, playing more strongly will cause the filter EG to produce greater changes in cutoff frequency. With negative (-) values, playing more strongly will also cause the filter EG to produce greater changes in cutoff frequency, but with the polarity of the EG inverted.

99...+99 Value of the Velocity to A parameter.

Velocity to B

This parameter specifies the depth and direction of the effect that velocity will have on the time-varying changes created by the filter EG to control the filter B cutoff frequency (see “Velocity to A”).

99...+99 Value of the Velocity to B parameter.

Int to A (Intensity to A)

Specifies the depth and direction of the effect that the time-varying changes created by the filter 1 EG will have on the filter A cutoff frequency.

With positive (+) settings, the sound will become brighter when the EG levels set by Filter EG “Level” and “Time” parameters are in the “+” area, and darker when they are in the “-” area.

With negative (-) settings, the sound will become darker when the EG levels set by Filter EG “Level” and “Time” parameters are in the “+” area, and brighter when they are in the “-” area.

-99...+99 Parameter value.

Int to B (Intensity to B)

Specifies the depth and direction of the effect that the time-varying changes created by the filter EG will have on the filter B cutoff frequency (see “Int to A (Intensity to A)”).

-99...+99 Parameter value.

AMS (EG Alternate Modulation Source)

Selects the source that will control the depth and direction of the effect that the time-varying changes produced by the filter EG will have on the cutoff frequency of filters A and B. See “AMS (Alternate Modulation Source) list” on page 24.

Int to A (Intensity to A)

Specifies the depth and direction of the effect that “AMS” will have on filter A. For details on how this will apply, refer to “Int to A (Intensity to A)”.

Int to B (Intensity to B)

Specifies the depth and direction of the effect that “AMS” will have on filter B. For details on how this will apply, refer to “Int to A (Intensity to A)”.

Note: The sum of the settings for “Velocity to A/B”, “Intensity to A/B”, and “(AMS) Intensity to A/B” will determine the depth and direction of the effect produced by the filter EG.

Filter A/B Modulation

AMS1 (Alternate Modulation Source 1 for filter A/B)

Selects the source that will control modulation of the filter A cutoff frequency. See “AMS (Alternate Modulation Source) list” on page 24.

Note: The filter B parameters will be displayed when “Filter Type” on page 11 is Low Pass & High Pass.

Intensity (Intensity to AMS1)

Specifies the depth and direction of the effect that “AMS1” will have.

When “AMS1” is JS X, a positive (+) value for this parameter will cause the cutoff frequency to rise when the joystick is moved toward the right, and fall when the joystick is moved toward the left. With a negative (–) value for this parameter, the opposite will occur.

This value is added to the setting of the Filter A “Frequency”.

AMS2 (Alternate Modulation Source 2 for filter A/B)

Selects the source that will control modulation of the filter A cutoff frequency (see “AMS (Alternate Modulation Source) list” on page 24).

Intensity (Intensity to AMS2)

Specifies the depth and direction of the effect that the selected source will have (see “Intensity (Intensity to AMS1)” on page 13).

Filter: Filter LFO

Here you can use the filter LFO to apply cyclic modulation to the cutoff frequency of the filter (for the selected oscillator) to create cyclical changes in tone.

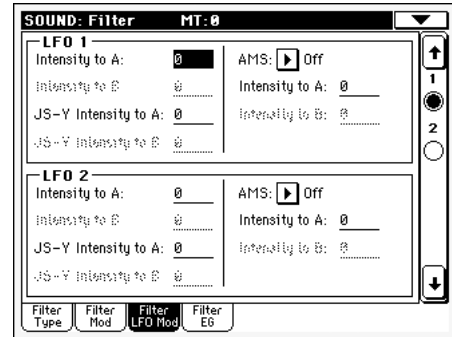

LFO 1

Intensity to A

Specifies the depth and direction of the modulation that LFO1 (set on “LFO: LFO1”) will have on the cutoff frequency of filter A. Negative (–) settings will invert the phase.

Change in cutoff

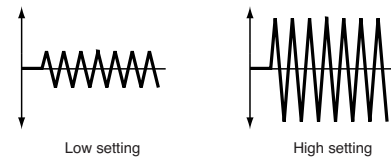

-99...+99 Parameter value.

Intensity to B

Specify the depth and direction of the modulation that LFO1 will have on the cutoff frequency of filter B (see “Intensity to A”).

-99...+99 Parameter value.

JS (Joystick) –Y Intensity to A

By moving the joystick in the Y direction (toward yourself), you can control the depth at which LFO1 modulates the cutoff frequency of filter A. This parameter specifies the depth and direction of the control.

Higher settings of this parameter will produce greater increases in the effect of LFO1 on the filter when the joystick is moved toward yourself.

-99...+99 Parameter value.

JS (Joystick) –Y Intensity to B

By moving the joystick in the Y direction (toward yourself), you can control the depth at which LFO1 modulates the cutoff frequency of filter B. This parameter specifies the depth and direction of the control (see “JS (Joystick) –Y Intensity to A”).

AMS (Filter LFO1 Alternate Modulation Source)

Select a source that will control the depth and direction of cutoff frequency change for both filters A and B. See “AMS (Alternate Modulation Source) list”.

Intensity to A

Specifies the depth and direction of the effect that “AMS” will have on filter A.

For example if “AMS” is After Touch, higher settings of this parameter will allow greater change to be applied to LFO1 when you apply pressure to the keyboard.

-99...+99 Parameter value.

Intensity to B

Specifies the depth and direction of the effect that “AMS” will have on filter B (see “Intensity to A”).

LFO 2

Adjusts the depth of the cyclic modulation applied by LFO2 (set on “LFO: LFO2”) to the cutoff frequency of filters A and B. For more information on the parameters see “LFO 1” above.

Filter: Filter EG

Here you can make settings for the EG that will produce time-varying changes in the cutoff frequency of filters A and B for the selected oscillator. The depth of the effect that these settings will have on the filter cutoff frequency is determined by the “Velocity” and “Intensity” parameters.

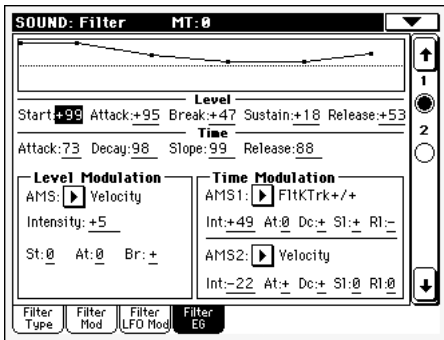

Diagram

The diagram on top of the page shows the Filter envelope line.

Filter envelope

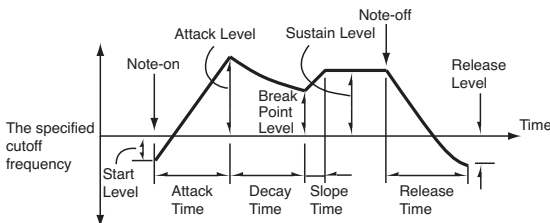

Level

These are the envelope segment levels. The result will depend on the filter that was selected in “Filter Type”. For example, with the Low Pass Resonance filter, positive (+) values of EG Intensity will cause the tone to be brightened by positive (+) levels, and darkened by negative (-) levels.

Start

This parameter specifies the change in cutoff frequency at the time of note-on.

-99...+99 Level value.

Attack

This parameter specifies the change in cutoff frequency after the attack time has elapsed.

-99...+99 Level value.

Break (Break Point)

This parameter specifies the change in cutoff frequency after the decay time has elapsed.

-99...+99 Level value.

Sustain

This parameter specifies the change in cutoff frequency that will be maintained from after the slope time has elapsed until note-off occurs.

-99...+99 Level value.

Release

This parameter specifies the change in cutoff frequency that will occur when the release time has elapsed.

-99...+99 Level value.

Time

These parameters specify the time over which the filter change will occur.

Attack

This parameter specifies the time over which the level will change from note-on until the attack level is reached.

0...99 Time value.

Decay

This parameter specifies the time over which the level will change from the attack level to the break point level.

0...99 Time value.

Slope

This parameter specifies the time over which the level will change after the decay time has elapsed until the sustain level is reached.

0...99 Time value.

Release

This parameter specifies the time over which the level will change after note-on occurs until the release level is reached.

0...99 Time value.

Level Modulation

Filter 1 EG changes (level) (AMS = Velocity, Intensity = a positive (+) value)

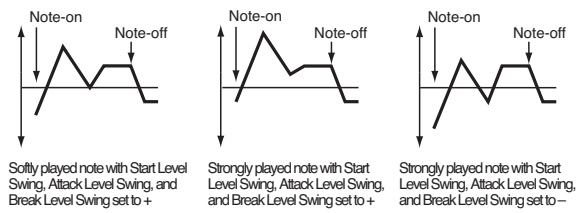

AMS (Alternate Modulation Source)

This parameter selects the source that will control the “Level” parameters of the filter EG (“AMS (Alternate Modulation Source) list” on page 24).

Intensity (AMS Intensity)

This parameter specifies the depth and direction of the effect applied by “AMS”. With a setting of 0, the levels specified by “Frequency (Cutoff Frequency A)” will be used.

For example, if “AMS” is Velocity, and you set “St (Start Level Swing)”, “At (Attack Level Swing)” and “Br (Break Level Swing)” to + and set “Intensity” to a positive (+) value, the EG levels will rise as you play more strongly. If “Intensity” is set to a negative (-) values, the EG levels will fall as you play more strongly.

-99...+99 Intensity value.

St (Start Level Swing)

This parameter specifies the direction in which “AMS” will affect “Start”. When “Intensity” has a positive (+) value, a setting of + for this parameter will allow “AMS” to raise the EG level, and a setting of - will allow “AMS” to lower the EG level. With a setting of 0 there will be no change.

At (Attack Level Swing)

This parameter specifies the direction in which “AMS” will affect “Attack”. When “Intensity” has a positive (+) value, a setting of + for this parameter will allow “AMS” to raise the EG level, and a setting of - will allow “AMS” to lower the EG level. With a setting of 0 there will be no change.

Br (Break Level Swing)

This parameter specifies the direction in which “AMS” will affect “Break (Break Point)”. When “Intensity” has a positive (+) value, a setting of + for this parameter will allow “AMS” to raise the EG level, and a setting of - will allow “AMS” to lower the EG level. With a setting of 0 there will be no change.

Time Modulation

Filter 1 EG changes (Time) (AMS = Velocity, Intensity = a positive (+) value)

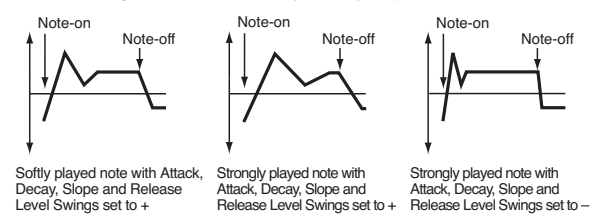

AMS1/2

Use this parameter to select the source that will control the “Time” parameters of the filter EG. See “AMS (Alternate Modulation Source) list” on page 24.

Int (AMS Intensity)

This parameter specifies the depth and direction of the effect that “AMS1/2” will have.

For example, if “AMS1/2” is set to FltKTr +/+, the EG “Time” parameters will be controlled by the Keyboard Tracking settings. With positive (+) values of this parameter, positive (+) values of “Ramp Low/High” will lengthen the EG times, and negative (-) values of “Ramp Low/High” will shorten the EG times. The direction of change is specified by “At (Attack Time Swing)”, “Dc (Decay Time Swing)”, “Sl (Slope Time Swing)”, and “Rl (Release Time Swing)”.

With a setting of 0, the times specified by “Frequency (Cutoff Frequency A)” will be used.

If “AMS1/2” is set to Velocity, positive (+) values of this parameter will cause EG times to lengthen as you play more strongly, and negative (-) values will cause EG times to shorten as you play more strongly.

-99...+99 Intensity value.

At (Attack Time Swing)

This parameter specifies the direction in which “AMS1/2” will affect the attack time. With positive (+) values of “Intensity”, setting this parameter to + will allow AMS to lengthen the time, and setting this parameter to - will allow AMS to shorten the time. With a setting of 0 there will be no change.

Dc (Decay Time Swing)

This parameter specifies the direction in which “AMS1/2” will affect the decay time. With positive (+) values of “Intensity”, setting this parameter to + will allow AMS to lengthen the time, and setting this parameter to - will allow AMS to shorten the time. With a setting of 0 there will be no change.

Sl (Slope Time Swing)

This parameter specifies the direction in which “AMS1/2” will affect the slope time. With positive (+) values of “Intensity”, setting this parameter to + will allow AMS to lengthen the time, and setting this parameter to - will allow AMS to shorten the time. With a setting of 0 there will be no change.

Rl (Release Time Swing)

This parameter specifies the direction in which “AMS1/2” will affect the release time. With positive (+) values of “Intensity”, setting this parameter to + will allow AMS to lengthen the time,

and setting this parameter to – will allow AMS to shorten the time. With a setting of 0 there will be no change.

Amp: Amp Level/Pan

These parameters control the volume and pan of the selected oscillator.

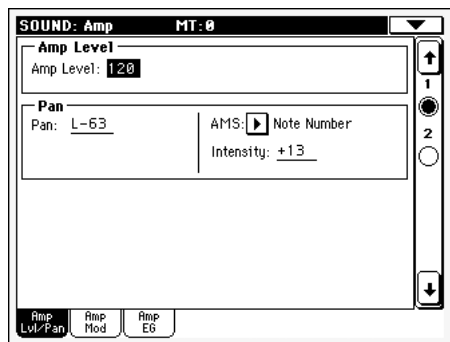

Amp Level

Volume of the selected oscillator.

Note: The volume of a Sound can be controlled by CC#7 (volume) and #11 (expression). The resulting level is determined by multiplying the values of CC#7 and #11. The Global MIDI channel is used for control.

0...127 Volume level.

Pan

Pan (stereo position) of the selected oscillator.

DRUM This parameter is not available when editing a Drum Kit. Use the individual Pan control for each key (see “Pan” on page 7).

Random The sound will be heard from a different location at each note-on.

L001 Places the sound at far left.

C064 Places the sound in the center.

R127 Places the sound to far right.

Note: This can be controlled by CC#10 (panpot). A CC#10 value of 0 or 1 will place the sound at the far left, a value of 64 will place the sound at the location specified by the “Pan” setting for each oscillator, and a value of 127 will place the sound at the far right. This is controlled on the global MIDI channel.

Pan modulation

AMS (Alternate Modulation Source)

Selects the source that will modify pan (see “AMS (Alternate Modulation Source) list” on page 24). This change will be relative to the “Pan” setting.

Intensity

Specifies the depth of the effect produced by “AMS”. For example, if “Pan” is set to C064 and “AMS” is Note Number, positive (+) values of this parameter will cause the sound to move toward the right as the note numbers increase beyond the C4 note (i.e.,

as you play higher), and toward the left as the note numbers decrease (i.e., as you play lower). Negative (–) values of this parameter will have the opposite effect.

-99...+99 Parameter value.

Amp: Amp Mod

These settings allow you to apply modulation to amp (for each oscillator) to modulate the volume.

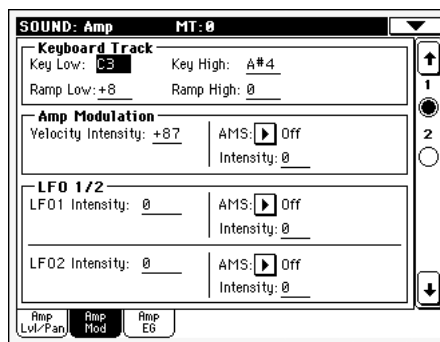

Keyboard Tracking

These parameters let you use keyboard tracking to adjust the volume of the selected oscillator. Use the “Key” and “Ramp” parameters to specify how the volume will be affected by the keyboard location that you play.

Key Low/High

These settings specify the note number at which keyboard tracking will begin to apply. The volume will not change between “Key Low” and “Key High”.

Keyboard tracking will apply to the range below the specified Low note number, and above the specified High note number.

C–1...G9 Lowest/Highest note in the range.

Ramp Low/High

These parameters specify the angle of keyboard tracking.

With positive (+) values of the “Ramp Low” parameter, the volume will increase as you play notes below the “Key Low” note number. With negative (–) values, the volume will decrease.

With positive (+) values of the “Ramp High” parameter, the volume will increase as you play notes above the “Key High” note number. With negative (–) values, the volume will decrease.

-99...+99 Angle value.

Here is an example of volume changes produced by keyboard location and “Ramp” settings:

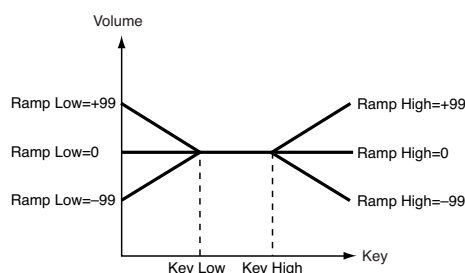

Amp Modulation

These parameters specify how the volume of the selected oscillator will be affected by velocity.

Velocity Intensity

With positive (+) values, the volume will increase as you play more strongly. With negative (-) values, the volume will decrease as you play more strongly.

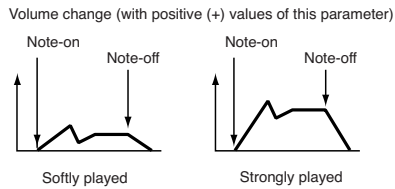

-99...+99 Intensity value.

AMS (Alternate Modulation Source)

Selects the source that will control the volume of the amp for the selected oscillator (See “AMS (Alternate Modulation Source) list” on page 24). “Velocity” cannot be selected.

Intensity

This parameter specifies the depth and direction of the effect that “AMS” will have. The actual volume will be determined by multiplying the value of the changes produced by the amp EG with the values of Alternate Modulation etc., and if the levels of the amp EG are low, the modulation applied by Alternate Modulation will also be less.

For example, if “AMS” is set to After Touch, positive (+) values of this parameter will cause the volume to increase when pressure is applied to the keyboard. However if the EG settings etc. have already raised the volume to its maximum level, the volume cannot be increased further.

With negative (-) values of this parameter, the volume will decrease when pressure is applied to the keyboard.

-99...+99 Intensity value.

Amp: Amp EG

These parameters let you create time-varying changes in the volume of the selected oscillator.

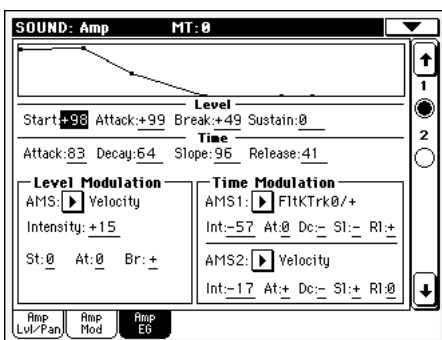

Diagram

The diagram on top of the page shows the Amplitude envelope line.

Level

These parameters are the level of the envelope segment.

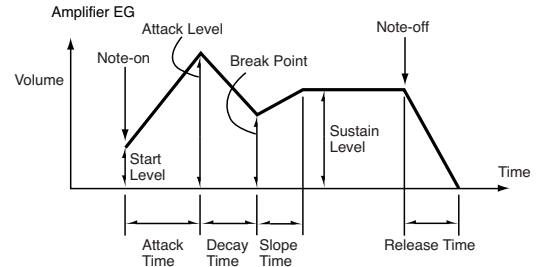

Start

This parameter specifies the volume level at note-on. If you want the note to begin at a loud level, set this to a high value.

0...99 Level value.

Attack

This parameter specifies the volume level that will be reached after the attack time has elapsed.

0...99 Level value.

Break

This parameter specifies the volume level that will be reached after the decay time has elapsed.

0...99 Level value.

Sustain

This parameter specifies the volume level that will be maintained from after the slope time has elapsed until note-off occurs.

0...99 Level value.

Time

These parameters specify the time over which the volume change will occur.

Attack

This parameter specifies the time over which the volume will change after note-on until it reaches the attack level. If the start level is 0, this will be the rise time of the sound.

0...99 Time value.

Decay

This parameter specifies the time over which the volume will change from when it reaches the attack level until it reaches the break point level.

0...99 Time value.

Slope

This parameter specifies the time over which the volume will change from when it reaches the break point level until it reaches the sustain level.

0...99 Time value.

Release

This parameter specifies the time over which the volume will change after note-off until it reaches 0.

0...99 Time value.

Level Modulation

Amp 1 EG changes (Level) (AMS=Velocity, Intensity = a positive (+) value)

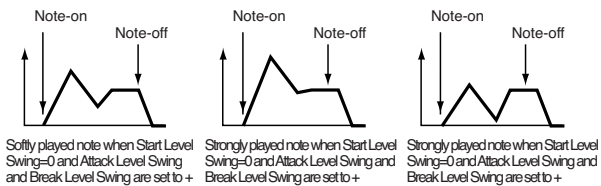

AMS (Alternate Modulation Source)

This parameter specifies the source that will control the “Level” parameters of the amp EG. See “AMS (Alternate Modulation Source) list” on page 24.

Intensity

This parameter specifies the depth and direction of the effect that “AMS” will have. For example, if “AMS” is Velocity, setting “St (Start Level Swing)”, “At (Attack Level Swing)” and “Br (Break Point Level Swing)” to + and setting “Intensity” to a positive (+) value will cause the amp EG volume levels to increase as you play more strongly. Setting “Intensity” to a negative (-) values will cause the amp EG volume levels to decrease as you play more strongly. With a setting of 0, the levels will be as specified on “Amp: Amp EG”.

-99...+99 Intensity value.

St (Start Level Swing)

This parameter specifies the direction in which “AMS” will change “Start”. If “Intensity” is set to a positive (+) value, setting this parameter to + will allow AMS to increase the EG level, and setting this parameter to - will allow AMS to decrease the EG level. With a setting of 0, no change will occur.

At (Attack Level Swing)

This parameter specifies the direction in which “AMS” will change “Attack”. If “Intensity” is set to a positive (+) value, setting this parameter to + will allow AMS to increase the EG level, and setting this parameter to - will allow AMS to decrease the EG level. With a setting of 0, no change will occur.

Br (Break Point Level Swing)

This parameter specifies the direction in which “AMS” will change “Break”. If “Intensity” is set to a positive (+) value, setting this parameter to + will allow AMS to increase the EG level, and setting this parameter to - will allow AMS to decrease the EG level. With a setting of 0, no change will occur.

Time Modulation

These parameters let you use an alternate modulation source to modify the amp EG times that were specified in “Time” on page 17.

Amp 1 EG changes (Time) (AMS=Amp KTrk +/+, Intensity = a positive (+) value) (When Amp Keyboard Track “Low Ramp” = a positive (+) value, and “High Ramp” = a positive (+) value)

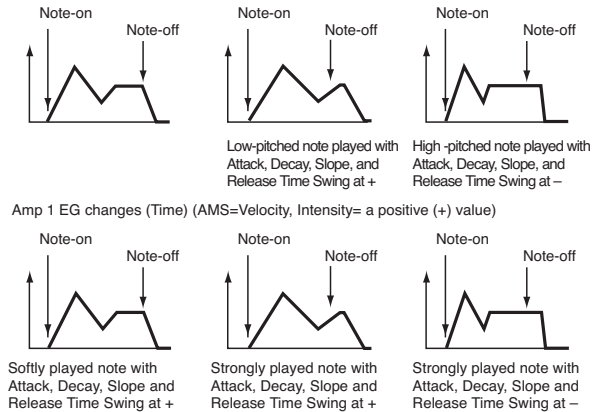

AMS1 (Alternate Modulation Source 1 - Time)

This parameter specifies the source that will control the “Time” parameters of the amp EG (see “AMS (Alternate Modulation Source) list” on page 24). With a setting of Off, there will be no modulation.

Intensity

This parameter specifies the depth and direction of the effect that “AMS1” will have. For example, if “AMS1(T)” is Amp KTrk +/+, the (Amp) Keyboard Track settings (see “Keyboard Tracking” on page 16) will control the EG “Time” parameters. With positive (+) values of this parameter, positive (+) values of “Ramp (Ramp Setting)” will cause EG times to be lengthened, and negative (-) values of “Ramp (Ramp Setting)” will cause EG times to be shortened. The direction of the change is specified by “At (Attack Time Swing)”, “Dc (Decay Time Swing)”, “Sl (Slope Time Swing)”, and “Rl (Release Time)”.

When “AMS1(T)” is Velocity, positive (+) values will cause EG times to lengthen as you play more strongly, and negative (-) values will cause EG times to shorten as you play more strongly. With a setting of 0, the EG times will be as specified by the “Level” parameters (see page 17).

At (Attack Time Swing)

This parameter specifies the direction of the effect that “AMS1” will have on “Attack”. With positive (+) values of “Intensity”, setting this parameter to + will allow AMS1 to lengthen the time, and setting it to - will allow AMS1 to shorten the time. With a setting of 0 there will be no effect.

Dc (Decay Time Swing)

This parameter specifies the direction of the effect that “AMS1” will have on “Decay”. With positive (+) values of “Intensity”, setting this parameter to + will allow AMS1 to lengthen the time, and setting it to - will allow AMS1 to shorten the time. With a setting of 0 there will be no effect.

SI (Slope Time Swing)

This parameter specifies the direction of the effect that “AMS1” will have on “Slope”. With positive (+) values of “Intensity”, setting this parameter to + will allow AMS1 to lengthen the time, and setting it to – will allow AMS1 to shorten the time. With a setting of 0 there will be no effect.

RI (Release Time)

This parameter specifies the direction of the effect that “AMS1” will have on “Release”. With positive (+) values of “Intensity”, setting this parameter to + will allow AMS1 to lengthen the time, and setting it to – will allow AMS1 to shorten the time. With a setting of 0 there will be no effect.

AMS2 (Alternate Modulation Source 2)

This is another alternate modulation source for the Amp EG. See above “AMS1” parameters.

LFO: LFO1

In this and the next page you can make settings for the LFO that can be used to cyclically modulate the Pitch, Filter, and Amp of each oscillator. There are two LFO units for each oscillator. By setting the LFO1 or LFO2 Intensity to a negative (–) value for Pitch, Filter, or Amp, you can invert the LFO waveform.

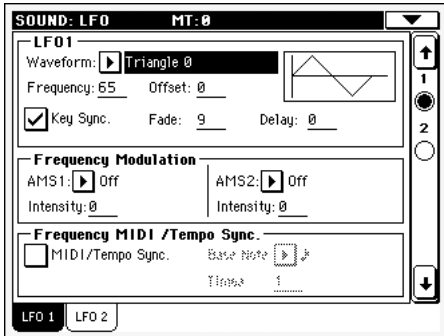

Waveform

This parameter selects the LFO waveform. The numbers that appear at the right of some of the LFO waveforms indicate the phase at which the waveform will begin.

Triangle 0		Triangle wave	Step Triangle - 4	
Triangle 90			Step Triangle - 6	
Triangle Random		Phase will change randomly at each key-in	Step Saw - 4	
Saw 0		Sawtooth down ↓	Step Saw - 6	
Saw 180			Random1 (S/H):	
Square		Square wave	Conventional sample & hold (S/H) in which the level changes randomly at fixed intervals of time	
Sine		Sine wave	Random2 (S/H):	
Guitar		Guitar vibrato	Both the levels and the time intervals will change randomly.	
Exponential Triangle			Random3 (S/H):	
Exponential Saw Down			The maximum level and minimum level will alternate at random intervals of time (i.e., a square wave with random period).	
Exponential Saw Up			Random4 (Vector)	
			Random5 (Vector)	
			Random6 (Vector)	

These types cause Random 1–3 to change smoothly. They can be used to simulate the instability of acoustic instruments etc.

Frequency

Set the LFO frequency. A setting of 99 is the fastest.

00...99 Frequency rate.

Offset

This parameter specifies the central value of the LFO waveform. For example, with a setting of 0 as shown in the following diagram, the vibrato that is applied will be centered on the note-on pitch. With a setting of +99, the vibrato will only raise the pitch above the note-on pitch, in the way in which vibrato is applied on a guitar.

When “Waveform” is set to Guitar, the modulation will occur only in the positive (+) direction even if you set “Offset” to 0.

Here are offset settings and pitch change produced by vibrato:



-99...+99 Offset value.

Key Sync

This parameter specifies if the LFO is synchronized to key strokes.

On The LFO will start each time you play a note, and an independent LFO will operate for each note.

Off The LFO effect that was started by the first-played note will continue to be applied to each newly-played note. (In this case, Delay and Fade will be applied only to the LFO when it is first started).

Fade

This parameter specifies the time from when the LFO begins to apply until it reaches the maximum amplitude. When “Key Sync.” is Off, the fade will apply only when the LFO is first started.

Here is how “Fade” affects the LFO (when “Key Sync” is On):

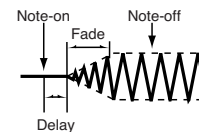

00...99 Fade rate.

Delay

This parameter specifies the time from note-on until the LFO effect begins to apply. When “Key Sync” is Off, the delay will apply only when the LFO is first started.

0...99 Delay time.

Frequency Modulation

You can use two alternate modulation sources to adjust the speed of the LFO1 for the selected oscillator.

AMS1 (Alternate Modulation Source1)

Selects the source that will adjust the frequency of the selected oscillator LFO1 (see “AMS (Alternate Modulation Source) list” on page 24). LFO1 can be modulated by LFO2.

Intensity (AMS1 Intensity)

This parameter specifies the depth and direction of the effect that “AMS1(F)” will have. When this parameter is set to a value of 16, 33, 49, 66, 82, or 99, the LFO frequency being can be increased by a maximum of 2, 4, 8, 16, 32, or 64 times respectively (or decreased by 1/2, 1/4, 1/8, 1/16, 1/32, or 1/64 respectively).

For example, if “AMS1(F)” is Note Number, positive (+) values of this parameter will cause the oscillator LFO to speed up as you play higher notes. Negative (–) values will cause the oscillator LFO to slow down as you play higher notes. This change will be centered on the C4 note.

If “AMS1(F)” is set to JS +Y, raising the value of this parameter will cause the oscillator LFO1 speed to increase as the joystick is moved away from yourself. With a setting of +99, moving the joystick all the way away from yourself will increase the LFO speed by approximately 64 times.

-99...+99 Intensity value.

AMS2 (Alternate Modulation Source2)

Intensity (AMS2 Intensity)

Make settings for a second alternate modulation source that will adjust the frequency of the oscillator LFO1 (see above “AMS1 (Alternate Modulation Source1)” and “Intensity (AMS1 Intensity)”).

Frequency MIDI/Tempo Sync

MIDI/Tempo Sync

This parameter enables/disables the LFO synchronization with Sequencer 1 Tempo.

On The LFO frequency will synchronize to the tempo (MIDI Clock) of Sequencer 1. In this case, the values you specified for “Frequency” (see page 19) and “Frequency Modulation” (see page 19) will be ignored.

Base Note

When “MIDI/Tempo Sync” is On, these parameters set a note length relative to “♩ (Tempo)” and the multiple (“Times”) that will be applied to it. These parameters will determine the frequency of the LFO1. For example if “Base Note” is ♩ (quarter note) and “Times” is 04, the LFO will perform one cycle every four beats.

Even if you change the “♩ (Tempo)” setting of Sequencer 1, the LFO will always perform one cycle every four beats.

DRUM This parameter is not available when editing a Drum Kit.

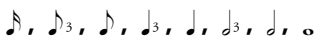

Note value.

Times

DRUM This parameter is not available when editing a Drum Kit.

1...16 Beats before restarting the cycle.

LFO: LFO2

Here you can make settings for the LFO2, which is the second LFO that can be applied to the selected oscillator. See “LFO: LFO1” for more information on the parameters value.

However in “Frequency Modulation”, the LFO cannot be selected as a modulation source in “AMS1” or “AMS2.”

Effects: FX Select

Here you can select two effects for the whole Sound, switch them on/off, and specify chaining.

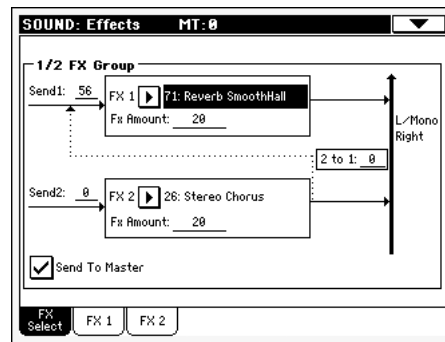

Note: For details on the effects, refer to the “Effects” chapter.

FX 1/2 Group

Send

Send level for each effect.

DRUM Drum samples have their own send level settings (see “Send FX1” and “Send FX2” on page 7). Use this parameter to adjust the general offset of the Drum Kit.

000...127 Effect level.

FX1/2

Use these parameters to select the effect type for effect 1/2. See the “Effects” chapter for more information.

Note: If 000: No Effect is selected, the output from the master effect will be muted.

FX Amount

Volume of the effect, that is added to the dry (unaffected) signal.

2>1

Use this parameter to send the output of effect 2 to the input of effect 1.

000...127 Level of the signal exiting the effect 2 going back to the effect 1.

Send to Master

This parameters allows you to decide if the direct + effected signal must go to the Master, or just the effected signal.

- On Only the effected signal will be sent to the Audio Outputs. The direct (non-effected) signal will not be sent.
- Off Both the effected signal and direct signals will be sent to the Audio Outputs.

Effects: FX1

In this page you can edit the effected assigned to the FX1 effect processor (usually reverb). See “Effects” on page 26 for more information.

Effects: FX2

In this page you can edit the effected assigned to the FX2 effect processor (usually modulating effect). See “Effects” on page 26 for more information.

Page menu

Press the page menu icon to open the menu. Press a command to select it. Press anywhere in the display to close the menu without selecting a command.

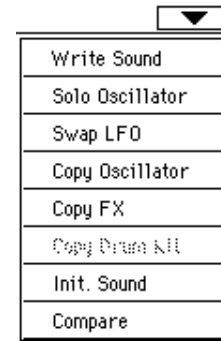

Write Sound

Select this command to open the Write Sound dialog box, and save all editing parameters to a Sound.

See “Write Sound dialog box” on page 22 for more information.

Solo Oscillator

Select this command to solo the selected oscillator, and mute the other oscillators. Select it again to unmute the other oscillators.

When this function is activated, the “Solo OSC [n]” indicator (n = oscillator number) blinks on the page header. While in this situation, you can select a different oscillator to be soloed.

Swap LFO

Select this command to replace LFO1 with LFO2, and vice-versa.

Copy Oscillator

Select this command to copy all settings between oscillators.

See “Copy Oscillator dialog box” on page 22 for more information.

Copy FX

Select this command to copy all FX settings from another Sound.

See “Copy FX dialog box” on page 22 for more information.

Copy Drum Kit

Select this command to copy the Drum Kit from a different Drum Kit.

See “Copy Drum Kit dialog box” on page 23 for more information.

Init Sound

Select this command to delete all parameters, and set them to a default value.

Compare

When this command is checked, original Sound parameter values are temporarily recalled, to compare them with edited

parameters. You cannot edit the Sound while you are in Compare mode.

While this function is on, the Compare indicator blinks on the page header.

Write Sound dialog box

Open this window by selecting the Write Sound item from the page menu. Here, you can save all Sound parameters to a Sound location in memory.

Warning: If you write over an existing Sound, the Sound will be deleted and replaced by the one you are saving (“overwrite”). Please save on a storage device any User Sound you don’t want to lose.

Note: DrumKits cannot be written over standard Sounds, nor vice versa.

Note: To save over a Factory Sound location, uncheck the Factory Sound Protect parameter in Media mode (see “Factory Sound Protect” in the Media chapter of the User’s Manual).

Warning: When replacing a Factory Sound, please be warned that all Performance, STSs, Styles and Songs making use of it will be modified as well. Use this feature with great care!

To restore the original data, please reload the original Musical Resources, downloadable from our web site (www.korgpa.com).

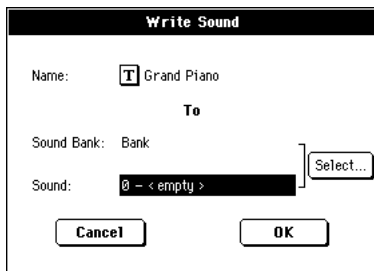

Name

Name of the Sound to be saved. Press the **T** (Text Edit) button next to the name to open the Text Edit window.

Sound Bank

Target bank of Sounds. Each bank corresponds to one of the PERFORMANCE/SOUND buttons. Use TEMPO/VALUE dial to select a different bank.

Sound

Target Sound location in the selected bank. Use TEMPO/VALUE dial to select a different location.

Select... button

Press this button to open the Sound Select window, and select a target location.

Copy Oscillator dialog box

Open this window by selecting the Copy Oscillator item from the page menu. Here, you can copy all settings between oscillators.

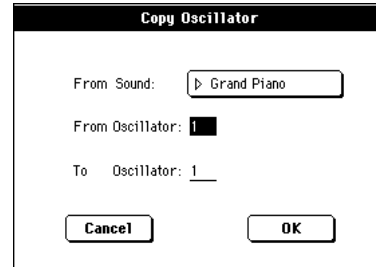

From Sound

Press this button to open the Sound Select window, and select the source Sound.

From Oscillator

Select the source oscillator to copy from.

To Oscillator

Target oscillator where to copy the source settings to.

Copy FX dialog box

Open this window by selecting the Copy FX item from the page menu. Here, you can copy all FX settings between FX processors.

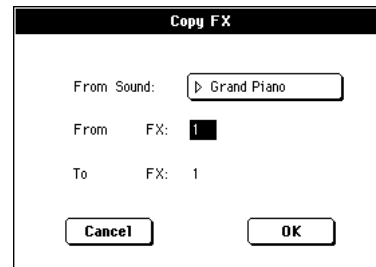

From Sound

Press this button to open the Sound Select window, and select the source Sound.

From FX

Select the source effect to copy from.

To FX

Target effect where to copy the source settings to.

Copy Drum Kit dialog box

Open this window by selecting the Copy Drum Kit item from the page menu. Here, you can copy settings from a range of keys of a Drum Kit.

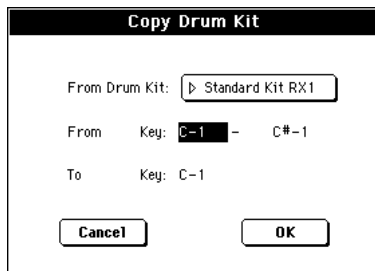

From Drum Kit

Press this button to open the Sound Select window, and select the source Drum Kit.

From Key

Select the source range of keys to copy from.

To Key

Target key. Settings are copied starting from this key, and upwards.

AMS (Alternate Modulation Source) list

Off	Do not use Alternate Modulation
Pitch EG	Pitch EG
Filter EG	Filter EG within the same oscillator
Amp EG	Amp EG within the same oscillator
LFO1	LFO1 within the same oscillator
LFO2	LFO2 within the same oscillator
Flt KTrk +/- (Filter Keyboard Track +/-)	Filter keyboard tracking within the same oscillator
Flt KTrk +/- (Filter Keyboard Track +/-)	Filter keyboard tracking within the same oscillator
Flt KTrk 0/+ (Filter Keyboard Track 0/+)	Filter keyboard tracking within the same oscillator
Flt KTrk +/-0 (Filter Keyboard Track +/-0)	Filter keyboard tracking within the same oscillator
Amp KTrk +/- (Amp Keyboard Track +/-)	Amp keyboard tracking within the same oscillator
Amp KTrk +/- (Amp Keyboard Track +/-)	Amp keyboard tracking within the same oscillator
Amp KTrk 0/+ (Amp Keyboard Track 0/+)	Amp keyboard tracking within the same oscillator
Amp KTrk +/-0 (Amp Keyboard Track +/-0)	Amp keyboard tracking within the same oscillator
Note Number	Note number
Velocity	Velocity
Poly AT (Poly After Touch)	Polyphonic After Touch (transmitted from the Pa588 only as sequence data)
Channel AT (Channel After Touch)	After Touch (Channel After Touch)
Joystick X	Joystick X (horizontal) axis
Joystick +Y	Joystick +Y (vertical upward) direction (CC#01)
Joystick Y	Joystick Y (vertical downward) direction (CC#02)
JS+Y & AT/2 (Joy Stick +Y & After Touch/2)	Joystick +Y (vertical upward) direction and After Touch
JS-Y & AT/2 (Joy Stick Y & After Touch/2)	Joystick Y (vertical downward) direction and After Touch
Ass.Pedal	Assignable foot pedal (CC#04)
CC#18	CC#18
CC#17	CC#17
CC#19	CC#19
CC#20	CC#20
CC#21	CC#21
Damper	Damper pedal (CC#64)
CC#65	Portamento switch (CC#65)
Sostenuto	Sostenuto pedal (CC#66)
CC#80	CC#80
CC#81	CC#81
CC#82	CC#82
CC#83	CC#83
Tempo	Tempo (tempo data from Sequencer 1 clock or external MIDI clock)

Flt KTrk +/- (Filter Keyboard Track +/-)

+/-

The direction of the effect will be determined by the sign of the “Ramp Low” setting, and by the opposite sign of the “Ramp High” setting (50 for a setting of +50, and -50 for a setting of 50).

Flt KTrk +/- (Filter Keyboard Track +/-)

Flt KTrk 0/+ (Filter Keyboard Track 0/+)

0/+

“Ramp Low” will have no AMS effect. The sign of the “Ramp High” setting will determine the direction of its effect.

Flt KTrk +/-0 (Filter Keyboard Track +/-0)

Amp KTrk +/- (Amp Keyboard Track +/-)

Amp KTrk +/- (Amp Keyboard Track +/-)

Amp KTrk 0/+ (Amp Keyboard Track 0/+)

Amp KTrk +/-0 (Amp Keyboard Track +/-0)

+/+

The direction of the effect will be determined by the sign (positive or negative) of the “Ramp Low” or “Ramp High” setting.

+/0

The sign of the “Ramp Low” setting will determine the direction of its effect. “Ramp High” will have no AMS effect.

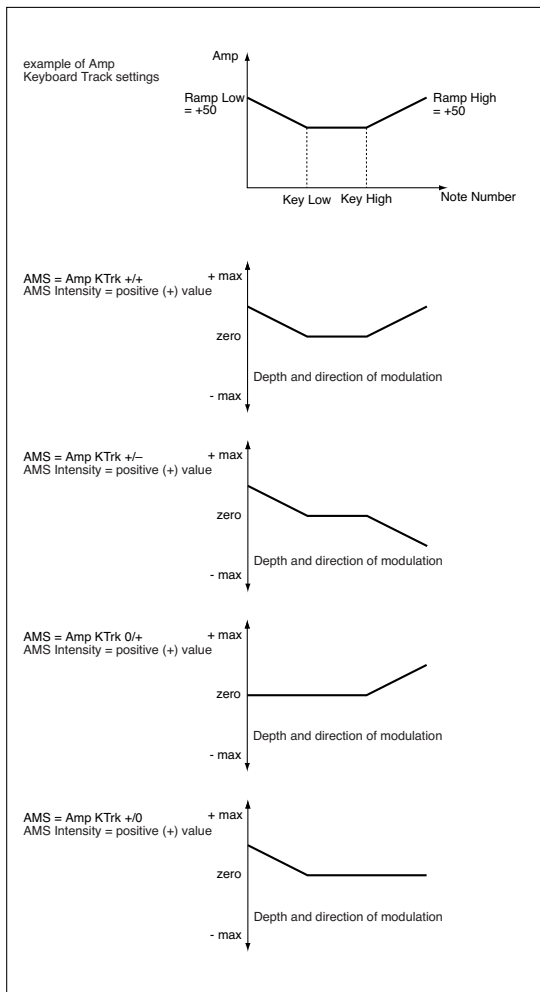

JS +Y & AT/2 (Joy Stick +Y & After Touch/2)

The effect will be controlled by the joystick +Y (vertically upward) and by after touch. In this case, the effect of after touch will be only half of the specified intensity.

JS Y & AT/2 (Joy Stick -Y & After Touch/2)

The effect will be controlled by the joystick Y (vertically downward) and by after touch. In this case, the effect of after touch will be only half of the specified intensity.

Effects

Pa588 is equipped with four powerful Effect Processors for the internal MIDI tracks (Upper, Lower, Style, Song, Pads).

Dynamic Modulation sources

When the **D_{mod}** symbol is encountered, a Dynamic Modulation can be applied to the corresponding parameter. Dynamic Modulation allows for realtime control of the effect. The following table shows the available modulation sources.

Modulation source	Note
Off	No modulation
Gate1	
Gate1+Dmpr	
Gate2	
Gate2+Dmpr	
Note Nr	Note Number
Velocity	Note Velocity
Expo Velocity	Exponential Note Velocity
AfterTouch	After Touch
JS X	Joystick Left/Right
JS+Y: CC#01	Joystick Forward
JS-Y: CC#02	Joystick Backward
MIDI(CC#04)	
MIDI(CC#12)	
MIDI(CC#13)	
MIDI(CC#16)	
MIDI(CC#18)	
MIDI(CC#17)	
MIDI(CC#19)	
MIDI(CC#20)	
MIDI(CC#21)	
MIDI(CC#17+)	
MIDI(CC#19+)	
MIDI(CC#20+)	
MIDI(CC#21+)	

Modulation source	Note
Damper: #64	
Prta.SW: #65	Portamento Switch
Sostenu: #66	Sostenuto Pedal
MIDI(CC#67)	
MIDI(CC#80)	
MIDI(CC#81)	
MIDI(CC#82)	
MIDI(CC#83)	
MIDI(CC#85)	
MIDI(CC#86)	
MIDI(CC#87)	
MIDI(CC#88)	
Tempo	

Some notes on the Gate parameters follow.

Gate1, Gate1+Dmpr (Gate1+Damper)

The effect is at maximum during note-on, and will stop when all keys are released. With **Gate1 + Dmpr**, the effect will remain at maximum even after the keys are released, as long as the damper (sustain) pedal is pressed.

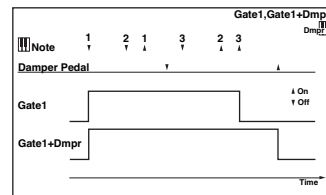

Gate2, Gate2+Dmpr (Gate2+Damper)

This is essentially the same as for Gate 1 or Gate 1 + Dmpr. However when **Gate 2** or **Gate 2 + Dmpr** are used as a dynamic modulation source for the EG, a trigger will occur at each note-on. (In the case of Gate 1 and Gate 1 + Dmpr, the trigger occurs only for the first note-on.)

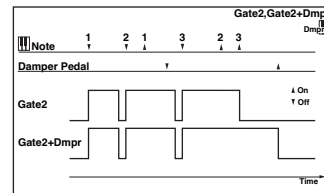

Dynamics (Dynamic)

000: No Effect

Select this option when you do not use any effects.

001: Stereo Compressor

This effect compresses the input signal to regulate the level and give a “punchy” effect. It is useful for guitar, piano, and drum sounds. This is a stereo compressor. You can link left and right channels, or use each channel separately.

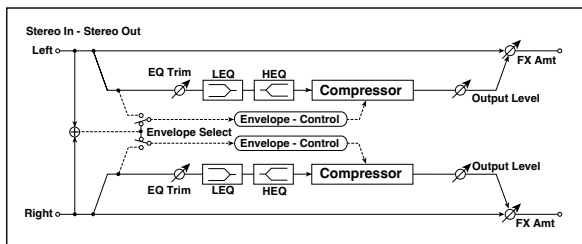

a	Envelope Select	L/R Mix, L/R Individually	Determines whether the left and right channels are linked or used separately	
b	Sensitivity	1...100	Sets the sensitivity	
c	Attack	1...100	Sets the attack level	
d	EQ Trim	0...100	Sets the EQ input level	
e	Pre LEQ Fc	Low, Mid-Low	Selects the cutoff frequency (low or mid-low) of the low-range equalizer	
	Pre HEQ Fc	High, Mid-High	Selects the cutoff frequency (high or mid-high) of the high-range equalizer	
f	Pre LEQ Gain [dB]	-15.0...+15.0	Sets the gain of the Low EQ	
	Pre HEQ Gain [dB]	-15.0...+15.0	Sets the gain of the High EQ	
g	Output Level	0...100	Sets the output level of the compressor	
	Src	Off...Tempo	Selects the modulation source for the compressor output level	
	Amt	-100...+100	Sets the modulation amount for the compressor output level	
h	FX Amount	0...100	Sets the balance between the effect and the dry input	
	Src	Off...Tempo	Selects a modulation source for FX Amount	
	Amt	-100...+100	Sets the modulation amount for FX Amount	

a: Envelope Select

This parameter selects whether the left and right channels are linked to control both signals simultaneously, or whether each channel is controlled independently.

b: Sensitivity

g: Output Level

The “Sensitivity” parameter sets the sensitivity of the compressor. If this parameter is set to a higher value, lower level sounds will be boosted. With a higher Sensitivity, the overall volume level is higher. To adjust the final volume level, use the “Output Level” parameter.

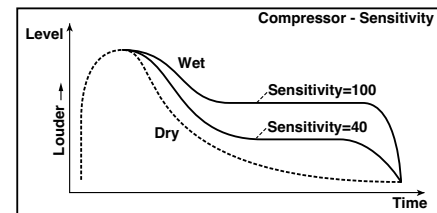

c: Attack

This parameter controls the attack level.

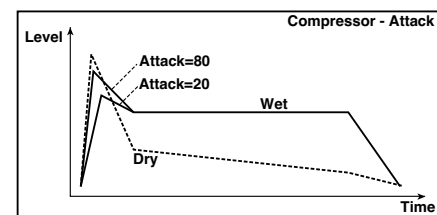

002: Stereo Limiter

The Limiter regulates the input signal level. It is similar to the Compressor, except that the Limiter compresses only signals that exceed the specified level to lower unnecessary peak signals. The Limiter applies a peaking-type EQ to the trigger signal (which controls the degree of the Limiter effect), allowing you to set any band width to be covered. This effect is a stereo limiter. You can link left and right channels, or use each channel individually.

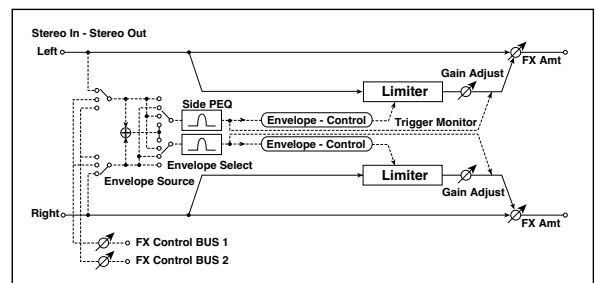

a	Envelope Select	L/R Mix, L Only, R Only, L/R Individually	Selects from linking both channels, controlling only from left channel, only from the right channel, or controlling each channel individually	
b	Ratio	1.0 : 1... 50.0 : 1, Inf : 1	Sets the signal compression ratio	
c	Threshold [dB]	-40...0	Sets the level above which the compressor is applied	
	Attack	1...100	Sets the attack time	
v	Release	1...100	Sets the release time	
	Gain Adjust [dB]	-Inf, -38...+24	Sets the output gain	
e	Src	Off...Tempo	Selects the modulation source for the output gain	
	Amt	-63...+63	Sets the modulation amount of the output gain	
f	Side PEQ Insert	Off, On	Toggles between on/off of the trigger signal's EQ	
	Trigger Monitor	Off, On	Switches between effect output monitor and trigger signal monitor	

g	Side PEQ Cutoff [Hz]	20...12.00k	Sets the EQ center frequency for the trigger signal	
	Q	0.5...10.0	Sets the EQ bandwidth for the trigger signal	
	Gain [dB]	-18.0...+18.0	Sets the EQ gain for the trigger signal	
h	FX Amount	0...100	Amount of FX added to the direct signal	
	Src	Off...Tempo	Table, "Dynamic Modulation sources," on page 26	
	Amt	-100...+100	Amount of modulation source	

a: Envelope Select

When L/R Mix is selected for this parameter, the left and right channels are linked to control the Limiter using the mixed signal. If L Only (or R Only) is selected, the left and right channels are linked, and the Limiter is controlled via only the left (or right) channel.

With L/R individually, the left and right channels control the Limiter individually.

b: Ratio

c: Threshold [dB]

e: Gain Adjust [dB]

This parameter sets the signal compression "Ratio". Compression is applied only when the signal level exceeds the "Threshold" value.

Adjust the output level using the "Gain Adjust" parameter, since compression causes the entire level to be reduced.

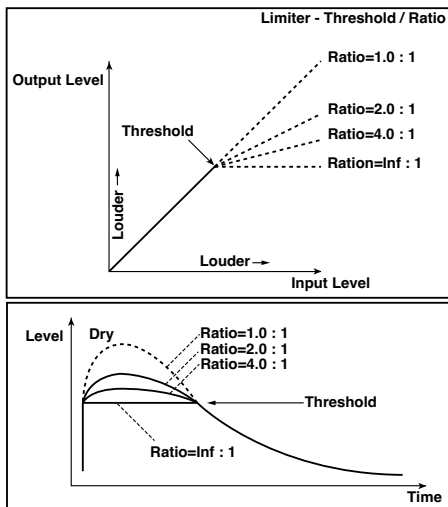

d: Attack

d: Release

These parameters set the attack time and release time. A higher attack time will cause the compression to be applied more slowly.

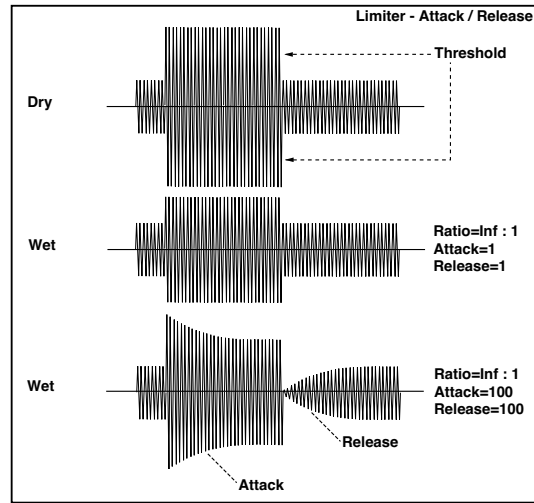

f: Trigger Monitor

Setting this parameter On will cause the trigger signal to be output, instead of the effect sound. Use this parameter to check the trigger signal with EQ applied.

Usually, set this to Off.

f: Side PEQ Insert

g: Side PEQ Cutoff [Hz]

g: Q

g: Gain [dB]

These parameters are used to set the EQ applied to the trigger signal.

The Limiter determines whether the compression is applied or not, based on the post-EQ trigger signal. Setting the equalizer allows you to set the Limiter to respond to any frequency band.

003: Multiband Limiter

This effect applies the Limiter to the low range, mid range, and high range of the input signal. You can control dynamics for each range to adjust the sound pressure of the low range, mid range, and high range in a different way from the EQ.

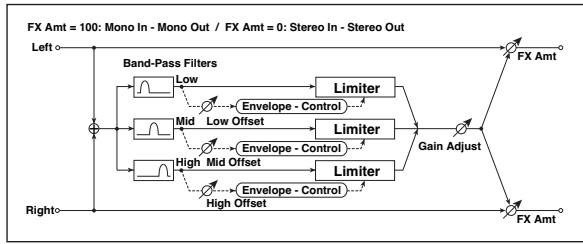

a	Ratio	1.0 : 1...50.0 : 1, Inf : 1	Sets the signal compression ratio	
b	Threshold [dB]	-40...0	Sets the level above which the compressor is applied	
c	Attack	1...100	Sets the attack time	
d	Release	1...100	Sets the release time	
e	Low Offset [dB]	-40...0	Gain of the low-range trigger signal	
f	Mid Offset [dB]	-40...0	Gain of the mid-range trigger signal	
g	High Offset [dB]	-40...0	Gain of the high-range trigger signal	
h	Gain Adjust [dB]	-Inf, -38...+24	Sets the output gain	D ^{mod}
	Src	Off...Tempo	Selects the modulation source for the output gain	
	Amt	-63...+63	Sets the modulation amount of the output gain	
i	FX Amount	0...100	Amount of FX added to the direct signal	D ^{mod}
	Src	Off...Tempo	Table , "Dynamic Modulation sources," on page 26	
	Amt	-100...+100	Amount of modulation source	

e: Low Offset [dB]

f: Mid Offset [dB]

g: High Offset [dB]

These parameters set the gain of the trigger signal.

For example, if you do not want to apply compression to the high range, reduce the "High Offset" value down below the "Threshold" level. In this way, the high range limiter will not respond, and compression will not be applied.

004: St.MasteringLimtr (Stereo Mastering Limiter)

This is a stereo limiter that is optimized for mastering songs.

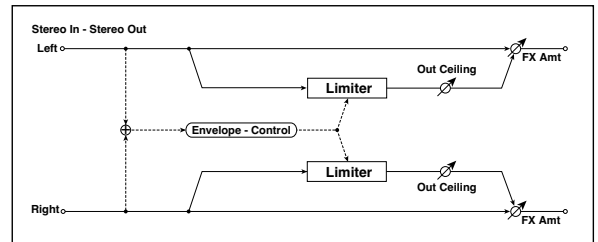

a	Threshold [dB]	-30.0...0.0	Sets the level above which the compressor is applied	
b	Out Ceiling [dB]	-30.0...0.0	Sets the output gain	
c	Release [msec]	0.50...1000.0	Sets the release time	
d	FX Amount	0...100	Amount of FX added to the direct signal	D ^{mod}
	Src	Off...Tempo	Table , "Dynamic Modulation sources," on page 26	
	Amt	-100...+100	Amount of modulation source	

005: Stereo Gate

This effect mutes the input signal when it falls below a specified level. You can also invert the on/off status of the gate, or use note-on/off messages to turn the gate on/off directly.

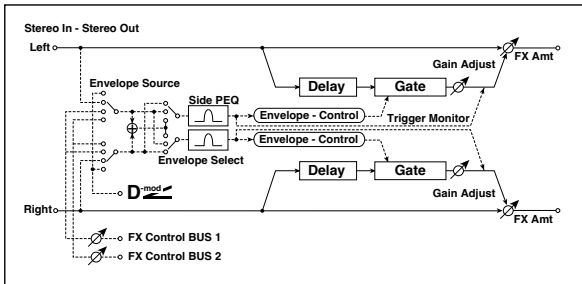

a	Envelope Source	D-mod, Input	Selects the source to control the gate: D-mod control, or use the input signal as a trigger	
b	Envelope Select	L/R Mix, L Only, R Only	Selects the control signal: left and right linked, left only, or right only	
	Src	Off...Tempo	Selects the source that will control the gate when Envelope Src = D-mod	
c	Threshold	0...100	Sets the level at which gating is applied	
	Polarity	+, -	Switches the polarity of gating	
d	Attack	1...100	Sets the attack time	
	Release	1...100	Sets the release time	
e	Delay Time [msec]	0...100	Sets the delay time for the gate input	
f	Side PEQ Insert	Off, On	Switches the trigger signal equalizer on/off	
	Trigger Monitor	Off, On	Switches between monitoring the effect output and the trigger signal	
g	Side PEQ Cutoff [Hz]	20...12.00k	Sets the center frequency of the equalizer for the trigger signal	
	Q	0.5...10.0	Sets the bandwidth of the equalizer for the trigger signal	
	Gain [dB]	-18.0...+18.0	Sets the gain of the equalizer for the trigger signal	
h	FX Amount	0...100	Amount of FX added to the direct signal	
	Src	Off...Tempo	Table, "Dynamic Modulation sources," on page 26	
	Amt	-100...+100	Amount of modulation source	

c: Threshold

d: Attack

d: Release

"Threshold" specifies the level at which gating occurs when "Envelope Select" is set to L/R Mix, L Only, or R Only.

"Attack" and "Release" specify the attack time and release time of the gate.

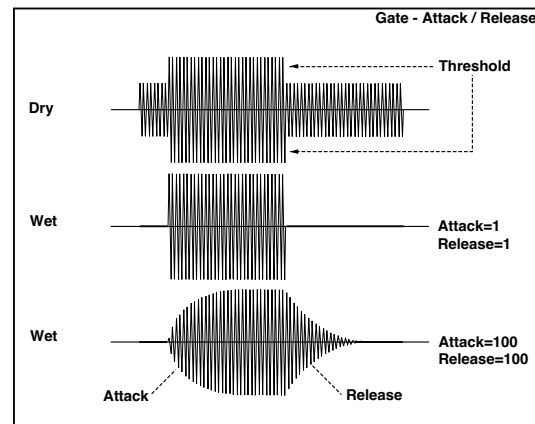
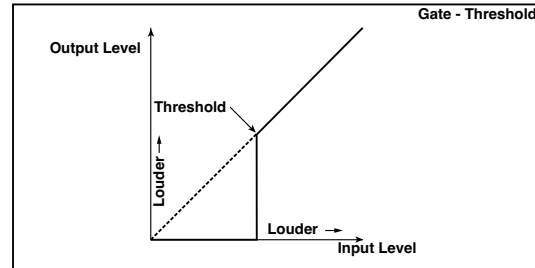

c: Polarity

This inverts the polarity of the gate on/off operation. With the "-" setting, the gate will close when the input signal exceeds the specified level. The direction in which the modulation source opens or closes the gate will also be reversed.

e: Delay Time [msec]

This sets the delay time for the input to the gate. When using shorter Attack Time settings, you can lengthen the Delay Time so that the sound is input after the gate opens.

EQ and Filters (EQ/Filter)

006: St.Parametric4EQ (Stereo Parametric 4-Band EQ)

This is a stereo 4-band parametric equalizer. You can select peaking type or shelving type for Band 1 and 4. The gain of Band 2 can be controlled by dynamic modulation.

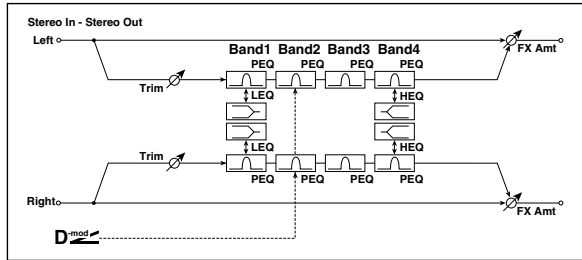

a	Trim	0...100	Sets the input level	
b	Band1 Type	Peaking, Shelving-Low	Selects the type of Band 1	
c	Band4 Type	Peaking, Shelving-High	Selects the type of Band 4	
d	Band2 Dynamic Gain Src	Off...Tempo	Selects the modulation source of the Band 2 gain	
	Amt [dB]	-18.0...+18.0	Sets the modulation amount of Band 2 gain	
e	Band1 Cutoff [Hz]	20...1.00k	Sets the center frequency of Band 1	
	Q	0.5...10.0	Sets the bandwidth of Band 1	
	Gain [dB]	-18.0...+18.0	Sets the gain of Band 1	
f	Band2 Cutoff [Hz]	50...10.00k	Sets the center frequency of Band 2	
	Q	0.5...10.0	Sets the bandwidth of Band 2	
	Gain [dB]	-18.0...+18.0	Sets the gain of Band 2	
g	Band3 Cutoff [Hz]	300...10.00k	Sets the center frequency of Band 3	
	Q	0.5...10.0	Sets the bandwidth of Band 3	
	Gain [dB]	-18.0...+18.0	Sets the gain of Band 3	
h	Band4 Cutoff [Hz]	500...20.00k	Sets the center frequency of Band 4	
	Q	0.5...10.0	Sets the bandwidth of Band 4	
	Gain [dB]	-18.0...+18.0	Sets the gain of Band 4	
i	FX Amount	0...100	Amount of FX added to the direct signal	
	Src	Off...Tempo	Table , "Dynamic Modulation sources," on page 26	
	Amt	-100...+100	Amount of modulation source	

- b: Band1 Type
- c: Band4 Type

Selects a filter type for Band 1 and 4.

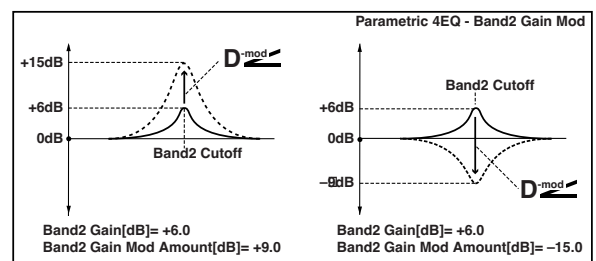
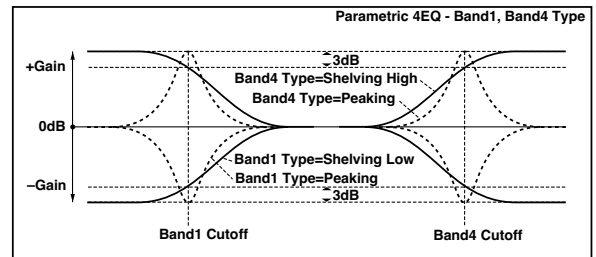

- e, f, g, h: Q

These parameters set the bandwidth of each equalizer. The higher the value, the narrower the band becomes.

- d: Band2 Dynamic Gain Src
- d: Amt [dB]

You can control the gain of Band 2 using the modulation source.

007: St. Graphic 7EQ (Stereo Graphic 7-Band EQ)

This is a stereo 7-band graphic equalizer. The bar graph of the gain setting for each band gives you a clear, visual idea of frequency responses. You can select a center frequency setting for each band from twelve types, according to the sound.

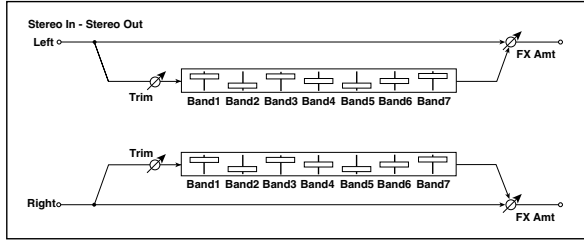

a	Type	1:Wide 1, 2:Wide 2, 3:Wide 3, 4:Half Wide 1, 5:Half Wide 2, 6:Half Wide 3, 7:Low, 8:Wide Low, 9:Mid, 10:Wide Mid, 11:High, 12:Wide High	Selects a combination of center frequencies for each band	
	b	Trim	0...100	Sets the input level
	c	Band 1 [dB]	-18.0...+18.0	Sets the gain of Band 1
	d	Band 2 [dB]	-18.0...+18.0	Sets the gain of Band 2
	e	Band 3 [dB]	-18.0...+18.0	Sets the gain of Band 3
	f	Band 4 [dB]	-18.0...+18.0	Sets the gain of Band 4
	g	Band 5 [dB]	-18.0...+18.0	Sets the gain of Band 5
h	Band 6 [dB]	-18.0...+18.0	Sets the gain of Band 6	
i	Band 7 [dB]	-18.0...+18.0	Sets the gain of Band 7	
j	FX Amount	0...100	Amount of FX added to the direct signal	
	Src	Off...Tempo	Table , "Dynamic Modulation sources," on page 26	
	Amt	-100...+100	Amount of modulation source	

a: Type

This parameter selects a combination of center frequencies for each band. The center frequency of each band is shown in the right of the screen.

You can configure a 21-Band Graphic EQ ranging from 80 Hz to 18 kHz if you route three Graphic 7-Band EQ effects in series, with a setting of 7:Low, 9:Mid, and 11:High for each EQ.

008: St.Exciter/Enhncr (Stereo Exciter/Enhancer)

This effect is a combination of the Exciter, which adds a punch to the sound and the Enhancer, which adds spread and presence.

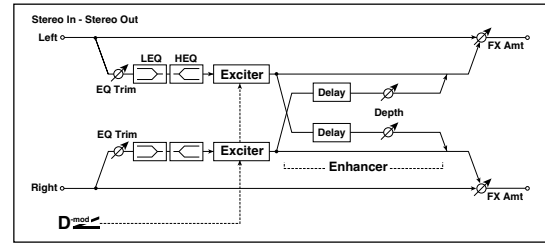

a	Exciter Blend	-100...+100	Sets the intensity (depth) of the Exciter effect	
	Src	Off...Tempo	Selects the modulation source of the Exciter intensity	
	Amt	-100...+100	Sets the modulation amount of the Exciter intensity	
b	Emphasis Freq	0...70	Sets the frequency to be emphasized	
	Src	Off...Tempo	Selects the modulation source of the frequency to be emphasized	
	Amt	-70...+70	Sets the amount of modulation of the frequency to be emphasized	
c	Enhancer Delay L [msec]	0.0...50.0	Sets the delay time for the Enhancer left channel	
d	Enhancer Delay R [msec]	0.0...50.0	Sets the delay time for the Enhancer right channel	
e	Enhancer Depth	0...100	Sets the determines to what degree the Enhancer effect is applied	
	Src	Off...Tempo	Selects the modulation source of the Enhancer width	
	Amt	-100...+100	Sets the modulation amount of the Enhancer width	
f	EQ Trim	0...100	Sets the 2-band EQ input level	
g	Pre LEQ Fc	Low, Mid-Low	Selects the cutoff frequency (low or mid-low) of the low-range equalizer	
	Pre HEQ Fc	High, Mid-High	Selects the cutoff frequency (high or mid-high) of the high-range equalizer	
h	Pre LEQ Gain [dB]	-15.0...+15.0	Gain of the Lo EQ	
	Pre HEQ Gain [dB]	-15.0...+15.0	Gain of the High EQ	
i	FX Amount	0...100	Amount of FX added to the direct signal	
	Src	Off...Tempo	Table , "Dynamic Modulation sources," on page 26	
	Amt	-100...+100	Amount of modulation source	

a: Exciter Blend

This parameter sets the depth (intensity) of the Exciter effect. Positive values give a frequency pattern (to be emphasized) different from negative values.

b: Emphasis Freq

This parameter sets the frequency to be emphasized. Higher values will emphasize lower frequencies.

c: Enhancer Delay L [msec]

d: Enhancer Delay R [msec]

These parameters set the delay time for the Enhancer left and right channel. Specifying a slightly different delay time for the left and right channel will add a stereo image, depth, and width to the sound.

009: Stereo Isolator

This is a stereo effect that separates the input signal into low, mid, and high-frequency bands, and controls the volume of each band independently. For example you can separately boost or cut the kick, snare, and hi-hat sounds from a drum signal in realtime.

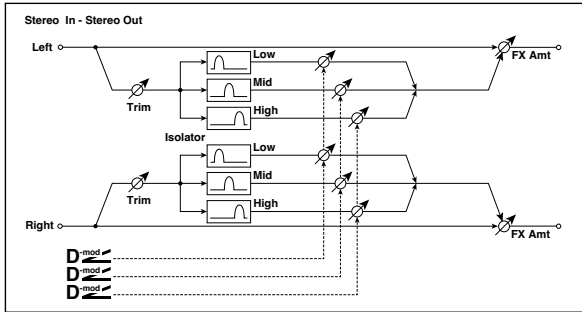

a	Trim	0...100	Sets the input level	
b	Low/Mid [Hz]	100...500	Sets the frequency at which the low and mid bands are divided	
c	Mid/High [Hz]	2000...6000	Sets the frequency at which the mid and high bands are divided	
d	Low Gain [dB]	-Inf, -59...+12	Sets the low-frequency gain	D-mod
	Src	Off...Tempo	Selects the source that will modulate low-frequency gain	
	Amt	-72...+72	Sets the amount by which the low-frequency gain will be modulated	
e	Mid Gain [dB]	-Inf, -59...+12	Sets the mid-frequency gain	D-mod
	Src	Off...Tempo	Selects the modulation source for mid-frequency gain	
	Amt	-72...+72	Sets the amount by which the mid-frequency gain will be modulated	
f	High Gain [dB]	-Inf, -59...+12	Sets the high-frequency gain	D-mod
	Src	Off...Tempo	Selects the modulation source for high-frequency gain	
	Amt	-72...+72	Sets the amount by which the high-frequency gain will be modulated	
g	FX Amount	0...100	Amount of FX added to the direct signal	D-mod
	Src	Off...Tempo	Table, "Dynamic Modulation sources," on page 26	
	Amt	-100...+100	Amount of modulation source	

010: St. Wah/Auto Wah (Stereo Wah/Auto Wah)

This stereo wah effect allows you to create sounds from vintage wah pedal simulation to auto-wah simulation, and much broader range settings.

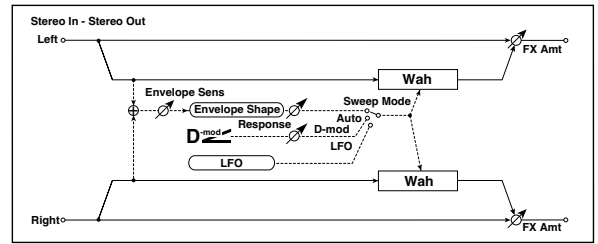

a	Frequency Bottom	0...100	Sets the lower limit of the wah center frequency	
	Frequency Top	0...100	Sets the upper limit of the wah center frequency	
b	Sweep Mode	Auto, D-mod, LFO	Selects the control from auto-wah, modulation source, and LFO	
	Src	Off...Tempo	Selects the modulation source for the wah when Sweep Mode=D-mod	D-mod
	Respon	0...100	Sets the response speed when Sweep Mode = Auto or D-mod	
c	Envelope Sens	0...100	Sets the sensitivity of auto-wah	
	Envelope Shape	-100...+100	Sets the sweep curve of auto-wah	
d	LFO Frequency [Hz]	0.02...20.00	Sets the speed of the LFO	D-mod
	Src	Off...Tempo	Selects a modulation source for LFO speed	
	Amt	-20.00...+20.00	Sets the modulation amount of LFO speed	
e	MIDI Sync	Off, On	When this is on, the LFO speed is set by BPM, Base Note, and Times, instead of Frequency	AB
	BPM	MIDI, 40.00...300.00	MIDI syncs to the system tempo; 40-300 sets the tempo manually for this individual effect	
	Base Note	♩, ♪, ♫, ♮	Selects the type of notes that specify the LFO speed	
	Times	x1...x32	Sets the number of notes that specify the LFO speed	
f	Resonance	0...100	Sets the resonance amount	
	Low Pass Filter	Off, On	Switches the wah low pass filter on and off	
g	Output Level	0...100	Sets the output level of the effect sound	D-mod
	Src	Off...Tempo	Selects the modulation source that will control the effect output level	
	Amt	-100...+100	Sets the modulation amount of the effect output level	
h	FX Amount	0...100	Amount of FX added to the direct signal	D-mod
	Src	Off...Tempo	Table, "Dynamic Modulation sources," on page 26	
	Amt	-100...+100	Amount of modulation source	

a: Frequency Bottom

a: Frequency Top

The sweep width and direction of the wah filter are determined by the “Frequency Top” and “Frequency Bottom” settings.

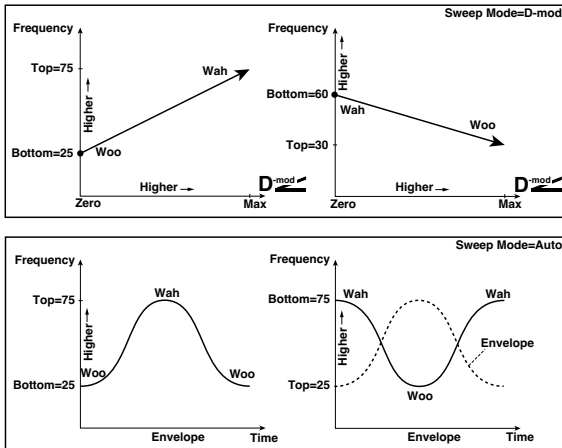

b: Sweep Mode

This parameter changes the wah control mode. Setting “Sweep Mode” to Auto will select an auto-wah that sweeps according to envelope changes in the input signal level. Auto-wah is frequently used for funk guitar parts and clav sounds.

When “Sweep Mode” is set to D-mod, you can control the filter directly via the modulation source in the same way as a wah pedal.

When “Sweep Mode” is set to LFO, the effect uses LFO to sweep in cycle.

c: Envelope Sens

This parameter sets the sensitivity of auto-wah. Increase the value if the input signal is too low to sweep. Reduce the value if the input signal is so high that the filter is stopped temporarily.

c: Envelope Shape

This parameter determines the sweep curve for auto-wah.

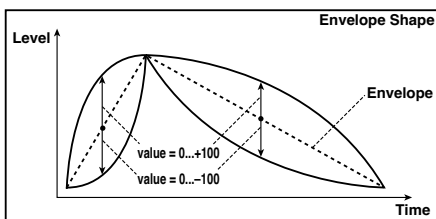

d: LFO Frequency [Hz]

e: MIDI Sync

When “MIDI/Tempo Sync”=Off, the LFO speed uses the LFO Frequency parameter setting. When “MIDI/Tempo Sync”=On, the LFO speed follows the “BPM”, “Base Note”, and “Times” settings.

e: BPM

e: Base Note

e: Times

One cycle of LFO sweep is obtained by multiplying the length of a note (♩) (selected for “Base Note”, in relation to the tempo specified in “BPM”, or the MIDI Clock tempo if “BPM” is set to MIDI) by the number specified in the Times parameter.

011: St. Vintage Wah (Stereo Vintage/Custom Wah)

This effect simulates the tonal character of a vintage wah pedal. You can customize the tone and range settings.

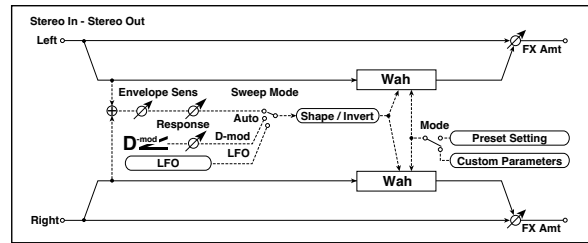

a	Mode	Preset, Custom	Selects either preset or custom settings	
	Shape	-100...+100	Sets the curve of the sweep	
	Invert	Off, On	Inverts the polarity of the sweep	
b	Frequency Bottom	0...100	Sets the lower limit of the wah center frequency when Mode = Custom	
	Frequency Top	0...100	Sets the upper limit of the wah center frequency when Mode = Custom	
c	Resonance Bottom	0...100	Sets the lower limit of resonance amount when Mode=Custom	
	Resonance Top	0...100	Sets the upper limit of resonance amount when Mode=Custom	
d	Sweep Mode	Auto, D-mod, LFO	Selects the control from auto-wah, modulation source, and LFO	
	Src	Off...Tempo	Selects the modulation source for the wah when Sweep Mode=D-mod	D-mod
	Manual	0...100	Sets the center frequency when Sweep Mode=D-mod and Source=Off	
e	Envelope Sens	0...100	Sets the auto-wah sensitivity	
	Response	0...100	Sets the speed of response when Sweep Mode=Auto or D-mod	
f	LFO Frequency [Hz]	0.02...20.00	Sets the speed of the LFO	D-mod
	Src	Off...Tempo	Selects a modulation source for LFO speed	
	Amt	-20.00...+20.00	Sets the modulation amount of LFO speed	
g	MIDI Sync	Off, On	When this is on, the LFO speed is set by BPM, Base Note, and Times, instead of Frequency	MIDI Sync
	BPM	MIDI, 40.00...300.00	MIDI syncs to the system tempo; 40-300 sets the tempo manually for this individual effect	
	Base Note	♩...	Selects the type of notes that specify the LFO speed	
	Times	x1...x32	Sets the number of notes that specify the LFO speed	
h	Output Level	0...100	Sets the output level of the effect sound	D-mod
	Src	Off...Tempo	Selects the modulation source that will control the effect output level	
	Amt	-100...+100	Sets the modulation amount of the effect output level	
i	FX Amount	0...100	Amount of FX added to the direct signal	D-mod
	Src	Off...Tempo	Table, “Dynamic Modulation sources,” on page 26	
	Amt	-100...+100	Amount of modulation source	

a: Shape

This parameter specifies the sweep curve of the wah. It applies to all control via auto-wah, modulation source, and LFO, and lets you adjust subtle nuances of the wah effect.

- a: Mode
- b: Frequency Bottom
- b: Frequency Top
- c: Resonance Bottom
- c: Resonance Top

If Mode=Preset, this simulates a vintage wah pedal. In this case, internally fixed values are used for Frequency Bottom/Top and Resonance Bottom/Top, and these settings will be ignored. The settings for Frequency Bottom/Top and Resonance Bottom/Top are valid if Mode=Custom.

012: St. Random Filter (Stereo Random Filter)

This stereo band pass filter uses a step-shape waveform and random LFO for modulation. You can create a special effect from filter oscillation.

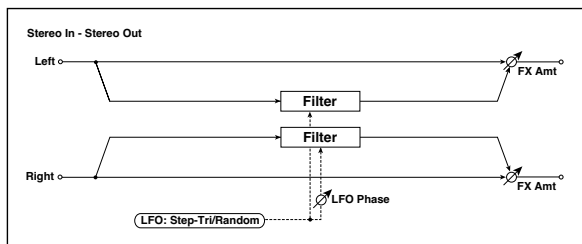

a	LFO Waveform	Step-Tri, Random	Selects the LFO Waveform	
	LFO Phase [degree]	-180...+180	Sets the LFO phase difference between the left and right	
b	LFO Frequency [Hz]	0.02...20.00	Sets the speed of the LFO	D ^{mod}
	Src	Off...Tempo	Selects the modulation source used for both LFO speed and step speed	
	Amt	-20.00...+20.00	Sets the modulation amount of LFO speed	
c	LFO Step Freq [Hz]	0.05...50.00	Sets the LFO step speed (speed that changes in steps)	D ^{mod}
	Amt	-50.00...+50.00	Sets the modulation amount of LFO step speed	
d	MIDI Sync	Off, On	When this is on, the LFO speed is set by BPM, Base Note, and Times, instead of Frequency	ASIO
	BPM	MIDI, 40.00...300.00	MIDI syncs to the system tempo; 40-300 sets the tempo manually for this individual effect	
	Base Note	♪...♩	Selects the type of notes that specify the LFO speed	
	Times	x1...x32	Sets the number of notes that specify the LFO speed	
e	Step Base Note	♪...♩	Selects the type of notes to specify the LFO step speed	ASIO
	Times	x1...x32	Sets the number of notes to specify the LFO step speed	
f	Manual	0...100	Sets the filter center frequency	
	Src	Off...Tempo	Selects the modulation source for the filter center frequency	
	Amt	-100...+100	Sets the modulation amount for the filter center frequency	
g	Depth	0...100	Sets the modulation depth of filter center frequency	D ^{mod}
	Src	Off...Tempo	Selects the modulation source of filter modulation	
	Amt	-100...+100	Sets the modulation amount of filter modulation	
h	Resonance	0...100	Sets the resonance amount	
i	FX Amount	-100...0...100	Amount of FX added to the direct signal	D ^{mod}
	Src	Off...Tempo	Table , "Dynamic Modulation sources," on page 26	
	Amt	-100...+100	Amount of modulation source	

a: LFO Phase [degree]

Offsetting the left and right phases alters how modulation is applied to the left and right channels, creating a swelling affect.

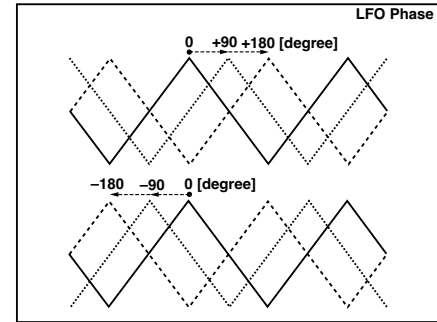

a: LFO Waveform

b: LFO Frequency [Hz]

c: LFO Step Freq [Hz]

When "LFO Waveform" is set to Step-Tri, LFO is a step-shape, triangle waveform. The "LFO Frequency" parameter sets the original triangle waveform speed. Changing the "LFO Step Freq" parameter enables you to adjust the width of the steps.

When "LFO Waveform" is set to Random, the "LFO Step Freq" parameter uses a random LFO cycle.

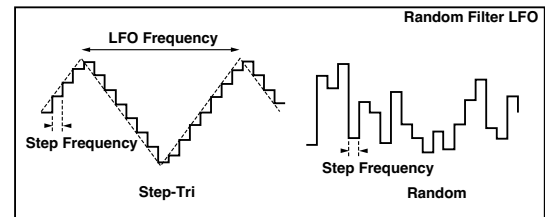

d: BPM

e: Step Base Note

e: Times

The width of an LFO step, or a cycle of random LFO, is obtained by multiplying the length of a note (♪...♩) (selected for "Step Base Note", in relation to the tempo specified in "BPM," or the MIDI Clock tempo if "BPM" is set to MIDI) by the number specified in the "Times" parameter.

i: FX Amount

The effect sound's phase will be reversed when you set this parameter in the negative range of values.

013: St. MultiModeFilter (Stereo Multi Mode Filter)

This is a multi-mode filter with four types; low pass, high pass, band pass, and band reject. You can use LFO or dynamic modulation to vary the cutoff frequency or resonance.

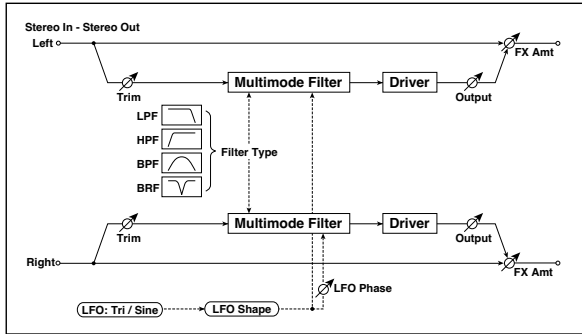

a	Type	LPF, HPF, BPF, BRF	Selects the type of filter	
	Trim	0...100	Sets the input level	
b	Cutoff	0...100	Sets the cutoff frequency (center frequency)	
	Src	Off...Tempo	Selects the modulation source of the cutoff	
	Amt	-100...+100	Sets the modulation amount of the cutoff	
c	Resonance	0...100	Sets the resonance amount	
	Src	Off...Tempo	Selects the source that will modulate the amount of resonance	
	Amt	-100...+100	Sets the amount by which the resonance will be modulated	
d	LFO Waveform	Triangle, Sine	Selects the LFO Waveform	
	Phase [degree]	-180...+180	Sets the LFO phase difference between the left and right	
e	Depth	0...100	Sets the depth to which the LFO will modulate the cutoff frequency	
	LFO Frequency [Hz]	0.02...20.00	Sets the speed of the LFO	
f	Src	Off...Tempo	Selects a modulation source for LFO speed	
	Amt	-20.00...+20.00	Sets the modulation amount of LFO speed	
	MIDI Sync	Off, On	When this is on, the LFO speed is set by BPM, Base Note, and Times, instead of Frequency	
	BPM	MIDI, 40.00...300.00	MIDI syncs to the system tempo; 40-300 sets the tempo manually for this individual effect	
g	Base Note		Selects the type of notes that specify the LFO speed	
	Times	x1...x32	Sets the number of notes that specify the LFO speed	
h	Drive SW	Off, On	Switches distortion on/off within the filter	
	Output Level	0...100	Sets the output level	
i	Drive Gain	0...100	Sets the distortion amount	
	Low Boost	0...100	Sets the amount of low-range boost	
	FX Amount	0...100	Amount of FX added to the direct signal	
	Src	Off...Tempo	Table , "Dynamic Modulation sources," on page 26	
	Amt	-100...+100	Amount of modulation source	

014: St. Sub Oscillator (Stereo Sub Oscillator)

This effect adds very low frequencies to the input signal. It is very useful when simulating a roaring drum sound or emphasizing powerful low range. This effect is different from the equalizer in that you can add very low range harmonics. You can also adjust the oscillator frequency to match a particular note number, for use as an octaver.

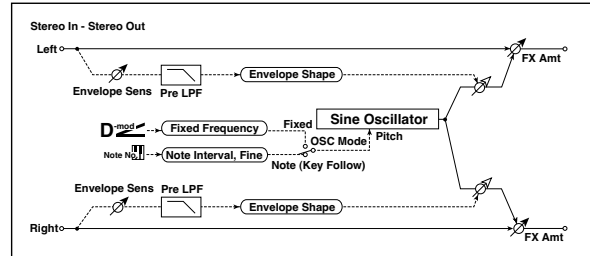

a	OSC Mode	Note (Key Follow), Fixed	Determines whether the oscillator frequency follows the note number or whether it is fixed	
b	Note Interval	-48...0	Sets the pitch difference from the note number when OSC Mode=Note (Key Follow)	
	Note Fine	-100...+100	Fine adjustment of the oscillator frequency	
c	Fixed Frequency [Hz]	10.0...80.0	Sets the oscillator frequency when OSC Mode=Fixed	
	Src	Off...Tempo	Selects the modulation source for the oscillator frequency when OSC Mode=Fixed	
	Amt	-80...+80	Sets the oscillator frequency modulation amount when OSC Mode=Fixed	
d	Envelope Pre LPF	1...100	Sets the upper limit of the frequency range for which very low harmonics are added	
e	Envelope Sens	0...100	Sets the sensitivity with which very low harmonics are added	
	Envelope Shape	-100...+100	Sets the oscillator's volume envelope curve	
f	FX Amount	0...100	Amount of FX added to the direct signal	
	Src	Off...Tempo	Table , "Dynamic Modulation sources," on page 26	
	Amt	-100...+100	Amount of modulation source	

- a: OSC Mode
- b: Note Interval
- b: Note Fine

The "OSC Mode" parameter selects the oscillator operation mode. When Note (Key Follow) is selected, the oscillator's frequency is determined based on the note number, allowing you to use it as an octaver. The "Note Interval" parameter sets the pitch offset from the original note number by semitone steps. The "Note Fine" parameter allows you to fine-tune in steps of cents.

d: Envelope Pre LPF

This parameter sets the upper limit of the frequency range to which very low harmonics are added. Adjust this parameter if you do not want to add lower harmonics to the higher range.

015: Talking Modulator

This effect adds an unusual character, like a human voice, to the input signal. Modulating the tone via dynamic modulation, you can create an interesting effect that sounds as if the guitar or synthesizer is talking.

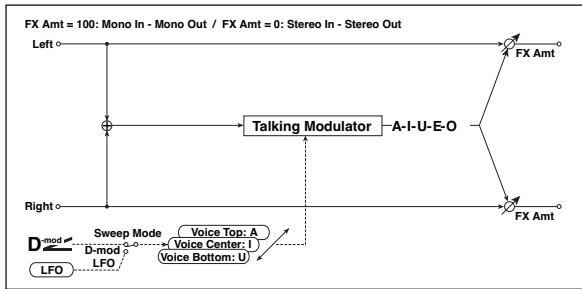

a	Sweep Mode	D-mod, LFO	Switches between modulation source control and LFO control	
b	Manual Voice Control	Bottom, 1...49, Center, 51...99, Top	Voice pattern control	
	Src	Off...Tempo	Selects the modulation source that controls the voice pattern	D-mod
c	Voice Top	A, I, U, E, O	Selects a vowel sound at the top end of control	
d	Voice Center	A, I, U, E, O	Selects a vowel sound in the center of control	
e	Voice Bottom	A, I, U, E, O	Selects a vowel sound at the bottom end of control	
f	Formant Shift	-100...+100	Sets the frequency to which the effect is applied	
	Resonance	0...100	Sets the Level of resonance of the voice pattern	
g	LFO Frequency [Hz]	0.02...20.00	Sets the speed of the LFO	D-mod
	Src	Off...Tempo	Selects a modulation source for LFO speed	
	Amt	-20.00...+20.00	Sets the modulation amount of LFO speed	
h	MIDI Sync	Off, On	When this is on, the LFO speed is set by BPM, Base Note, and Times, instead of Frequency	ASync
	BPM	MIDI, 40.00...300.00	MIDI syncs to the system tempo; 40-300 sets the tempo manually for this individual effect	
	Base Note		Selects the type of notes that specify the LFO speed	
	Times	x1...x32	Sets the number of notes that specify the LFO speed	
i	FX Amount	0...100	Amount of FX added to the direct signal	D-mod
	Src	Off...Tempo	Table, "Dynamic Modulation sources," on page 26	
	Amt	-100...+100	Amount of modulation source	

- c: Voice Top
- d: Voice Center
- e: Voice Bottom

These parameters assign vowels to the top, center, and bottom position of the controller.

E.g.: When "Voice Top"=A, "Voice Center"=I, and "Voice Bottom"=U:

If "Sweep Mode" is set to D-mod and Ribbon is selected as the modulation source, moving your finger from the right to left of the ribbon controller will change the sound from "a" to "i," then "u."

If Sweep Mode is set to LFO, the sound will change cyclically from "a" to "i," "u," "i," then "a."

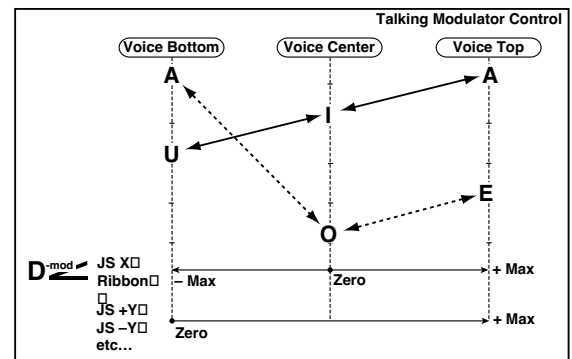

f: Formant Shift

This parameter adjusts the frequency level to which the effect is applied. If you wish to apply the effect to a higher-range sound, set this parameter to a higher value; to apply the effect to a lower-range sound, set this to a lower value.

f: Resonance

This parameter sets the intensity of resonance for the voice pattern. A larger value will add more character to the sound.

016: Stereo Decimator

This effect creates a rough sound like a cheap sampler by lowering the sampling frequency and data bit length. You can also simulate noise unique to a sampler (aliasing).

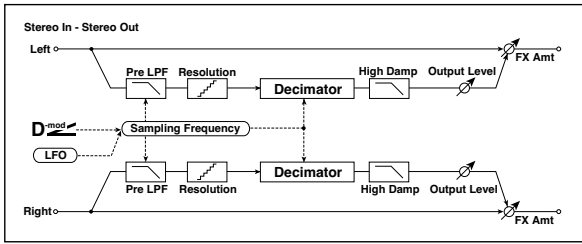

a	Pre LPF	Off, On	Selects whether the harmonic noise caused by a decrease in sampling frequency is generated or not	
	High Damp [%]	0...100	Sets the ratio of cut of the high range	
b	Sampling Freq [Hz]	1.00k...48.00k	Sets the sampling frequency	D-mod
	Src	Off...Tempo	Selects the modulation source of the sampling frequency	
	Amt	-48.00k...+48.00k	Sets the modulation amount of the sampling frequency	
c	LFO Frequency [Hz]	0.02...20.00	Sets the speed of the LFO	D-mod
	Src	Off...Tempo	Selects a modulation source for LFO speed	
	Amt	-20.00...+20.00	Sets the modulation amount of LFO speed	
d	MIDI Sync	Off, On	When this is on, the LFO speed is set by BPM, Base Note, and Times, instead of Frequency	
	BPM	MIDI, 40.00...300.00	MIDI syncs to the system tempo; 40-300 sets the tempo manually for this individual effect	
	Base Note		Selects the type of notes that specify the LFO speed	
	Times	x1...x32	Sets the number of notes that specify the LFO speed	
e	Depth	0...100	Sets the depth of the sampling frequency LFO modulation	D-mod
	Src	Off...Tempo	Selects the LFO modulation source of the sampling frequency	
	Amt	-100...+100	Sets the LFO modulation amount of the sampling frequency	
f	Resolution	4...24	Sets the data bit length	
g	Output Level	0...100	Sets the output level	D-mod
	Src	Off...Tempo	Selects the modulation source for the output level	
	Amt	-100...+100	Sets the modulation amount of the output level	
h	FX Amount	0...100	Amount of FX added to the direct signal	D-mod
	Src	Off...Tempo	Table, "Dynamic Modulation sources," on page 26	
	Amt	-100...+100	Amount of modulation source	

a: Pre LPF

If a sampler with a very low sampling frequency receives very high-pitched sound that could not be heard during playback, it could generate pitch noise that is unrelated to the original sound. Set "Pre LPF" to On to prevent this noise from being generated.

If you set the "Sampling Freq" to about 3 kHz and set "Pre LPF" to Off, you can create a sound like a ring modulator.

f: Resolution

g: Output Level

If you set a smaller value for the "Resolution" parameter, the sound may be distorted. The volume level may also be changed. Use "Output Level" to adjust the level.

017: St. Analog Record (Stereo Analog Record)

This effect simulates the noise caused by scratches and dust on analog records. It also reproduces some of the modulation caused by a warped turntable.

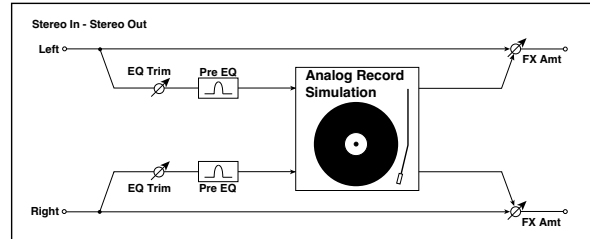

a	Speed [RPM]	33 1/3, 45, 78	Sets the r.p.m. of a record	
b	Flutter	0...100	Sets the modulation depth	
c	Noise Density	0...100	Sets the noise density	
	Noise Tone	0...100	Sets the noise tone	
	Noise Level	0...100	Sets the noise level	D-mod
d	Src	Off...Tempo	Selects the modulation source for the noise level	
	Amt	-100...+100	Sets the modulation amount of the noise level	
	Click Level	0...100	Sets the click noise level	D-mod
e	Src	Off...Tempo	Selects the modulation source for the click noise level	
	Amt	-100...+100	Sets the modulation amount of the click noise level	
f	EQ Trim	0...100	Sets the EQ input level	
	Pre EQ Cutoff [Hz]	300...10.00k	Sets the EQ center frequency	
g	Q	0.5...10.0	Sets the EQ band width	
	Gain [dB]	-18.0...+18.0	Sets the EQ gain	
	FX Amount	0...100	Amount of FX added to the direct signal	D-mod
h	Src	Off...Tempo	Table, "Dynamic Modulation sources," on page 26	
	Amt	-100...+100	Amount of modulation source	

b: Flutter

This parameter enables you to set the depth of the modulation caused by a warped turntable.

e: Click Level

This parameter enables you to set the level of the click noise that occurs once every rotation of the turntable. This simulation reproduces record noise, and the noise generated after the music on a vinyl record finishes.

Overdrive, Amp models, and Mic models (OD Amp Mic)

018: OD/Hi.Gain Wah (Overdrive/Hi.Gain Wah)

This distortion effect utilizes an Overdrive mode and a Hi-Gain mode. Controlling the wah effect, the 3-band EQ, and the amp simulation will allow you to create versatile distortion sounds. This effect is suitable for guitar and organ sounds.

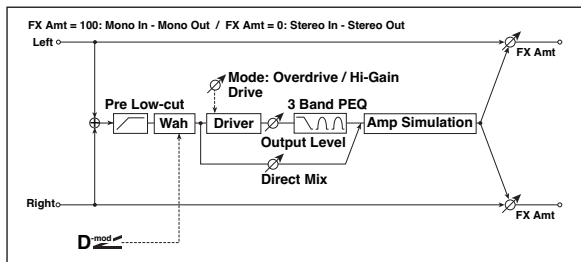

a	Wah	Off, On	Switches Wah on/off	D-mod
	Src	Off...Tempo	Selects the modulation source that switches the Wah on and off	
	Sw	Toggle, Moment	Selects the switching mode for the modulation source that switches the Wah on and off	
b	Wah Sweep Range	-10...+10	Sets the range of Wah	
	Wah Sweep Src	Off...Tempo	Selects the modulation source that controls the Wah	
c	Drive Mode	Overdrive, Hi-Gain	Switches between overdrive and hi-gain distortion	
d	Drive	1...100	Sets the degree of distortion	
	Pre Low-cut	0...10	Sets the low range cut amount of the distortion input	
e	Output Level	0...50	Sets the output level	D-mod
	Src	Off...Tempo	Selects the modulation source for the output level	
	Amt	-50...+50	Sets the modulation amount of the output level	
f	Low Cutoff [Hz]	20...1.00k	Sets the center frequency for Low EQ (shelving type)	
	Gain [dB]	-18...+18	Sets the gain of Low EQ	
g	Mid1Cutoff [Hz]	300...10.00k	Sets the center frequency for Mid/High EQ 1 (peaking type)	
	Q	0.5...10.0	Sets the band width of Mid/High EQ 1	
	Gain [dB]	-18...+18	Sets the gain of Mid/High EQ 1	
h	Mid2 Cutoff [Hz]	500...20.00k	Sets the center frequency for Mid/High EQ 2 (peaking type)	
	Q	0.5...10.0	Sets the band width of Mid/High EQ 2	
	Gain [dB]	-18...+18	Sets the gain of Mid/High EQ 2	
i	Direct Mix	0...50	Sets the amount of the dry sound mixed to the distortion	
	Speaker Simulation	Off, On	Switches the speaker simulation on/off	
j	FX Amount	0...100	Amount of FX added to the direct signal	D-mod
	Src	Off...Tempo	Table, "Dynamic Modulation sources," on page 26	
	Amt	-100...+100	Amount of modulation source	

a: Wah

The Wah parameter switches the wah effect on/off.

a: Sw

This parameter sets how the wah effect is switched on and off via the modulation source.

When "Sw" = Moment, the wah effect is usually turned off. It is turned on only when you press the pedal or operate the joystick.

MIDI When a value for the modulation source is less than 64, "off" speed is selected, and when the value is 64 or higher, "on" is selected.

When "Sw" = Toggle, the wah effect is switched between on and off each time you press the pedal or operate the joystick.

MIDI The switch will be turned on/off each time the value of the modulation source exceeds 64.

b: Wah Sweep Range

b: Wah Sweep Src

This parameter sets the sweep range of the wah center frequency. A negative value will reverse the direction of sweep. The wah center frequency can be controlled by the modulation source specified in the "Wah Sweep Src" parameter.

d: Pre Low-cut

Cutting the signal in the low range before it is input to the Distortion will create a sharp distortion.

d: Drive

e: Output Level

The degree of distortion is determined by the level of input signal and the setting of "Drive". Raising the "Drive" setting will cause the entire volume level to increase. Use the "Output Level" parameter to adjust the volume level. The "Output Level" parameter uses the signal level input to the 3-Band EQ. If clipping occurs at the 3-Band EQ, adjust the "Output Level" parameter.

019: St. Guitar Cabinet (Stereo Guitar Cabinet)

This simulates the acoustical character of a guitar amp's speaker cabinet.

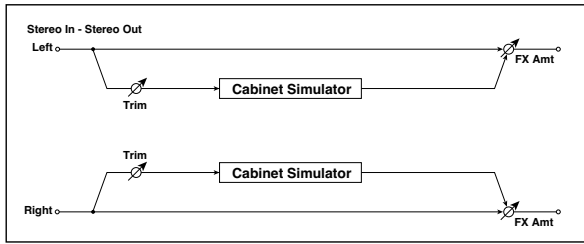

a	Trim	0...100	Sets the input level	
b	Type		Selects the type of the cabinet	
		TWEED - 1x12	Open-back cabinet with one 12" speaker, typically used for blues	
		TWEED - 4x10	Open-back cabinet with four 10" speakers	
		BLACK - 2x10	Open-back cabinet with two 10" speakers	
		BLACK - 2x12	American open-back cabinet with two 12" speakers	
		VOX AC15 - 1x12	Vox AC15 open-back cabinet with one 12" "Blue" speaker	
		VOX AC30 - 2x12	Vox AC30 open-back cabinet with two 12" "Blue" speakers	
		VOX AD412 - 4x12	VOX AD412 closed-back cabinet with four 12" speakers	
		UK H30 - 4x12	Closed-back classic cabinet with four 30W 12" speakers	
UK T75 - 4x12	Closed-back cabinet with four 75W 12" speakers			
US V30 - 4x12	Closed-back cabinet with four 30W 12" speakers			
c	Air	0...100	Sets the mic position	
d	FX Amount	0...100	Amount of FX added to the direct signal	
	Src	Off...Tempo	Table, "Dynamic Modulation sources," on page 26	
	Amt	-100...+100	Amount of modulation source	

020: St. Bass Cabinet (Stereo Bass Cabinet)

This simulates the acoustical character of a bass amp's speaker cabinet.

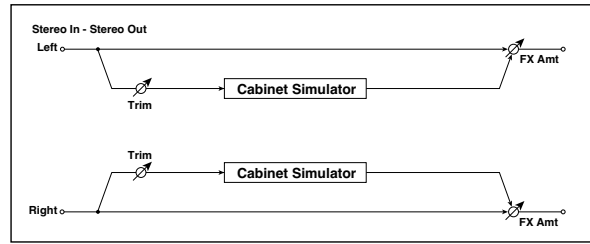

a	Trim	0...100	Sets the input level	
b	Cabinet Type		Selects the cabinet type	
		LA - 4x10	Four 10" speakers / LA sound cabinet	
		MODERN - 4x10	Four 10" aluminum-cone speakers / modern cabinet	
		METAL - 4x10	Four 10" aluminum-cone speakers / modern cabinet	
		CLASSIC - 8x10	Eight 10" speakers / classic cabinet	
		UK - 4x12	Four 12" speakers / UK-manufactured cabinet	
		STUDIO - 1x15	One 15" speaker / studio combo cabinet	
		JAZZ - 1x15	One 15" speaker / jazz combo cabinet	
		VOX AC100 - 2x15	Two 15" speakers / cabinet for Vox AC100	
		US - 2x15	Two 15" speakers / US-manufactured cabinet	
		UK - 4x15	Four 15" speakers / UK-manufactured cabinet	
		LA - 1x18	One 18" speaker / LA sound cabinet	
		COMBI - 1x12 & 1x18	One 12" and one 18" speaker combination cabinet	
		c	FX Amount	0...100
c	Src	Off...Tempo	Table, "Dynamic Modulation sources," on page 26	
	Amt	-100...+100	Amount of modulation source	

021: Bass Amp Model

This simulates a bass amp.

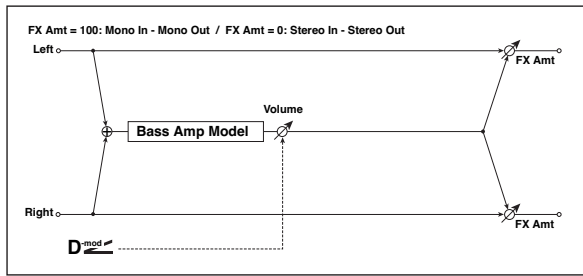

a	Amp Type	LA STUDIO	Selects the amplifier type An amp that is typical of the LA sound.	
		JAZZ	A combo amp favored by jazz bassists.	
		GOLD PANEL	An amp distinctive for its eye-catching gold panel and clean sound.	
		SCOOPED	An amp typical of 80's sounds.	
		VALVE2	A tube amp suitable for rock.	
		VALVE	A tube amp with the ULTRA LO switch turned ON.	
		CLASSIC	A tube amp whose basic character changes according to the setting of the value dial.	
b	Volume	0...100	Sets the output level	
	Src	Off...Tempo	Selects the modulation source for the output level	
	Amt	-100...+100	Sets the modulation amount of the output level	
c	Bass	0...100	Sets the bass (low range) level	
d	Middle	0...100	Sets the middle (mid range) level	
	Mid Range	0...4	Sets the mid-frequency range	
e	Treble	0...100	Sets the treble (high range) level	
f	Presence	0...100	Sets the presence (high-frequency tone)	
g	FX Amount	0...100	Amount of FX added to the direct signal	
	Src	Off...Tempo	Table , "Dynamic Modulation sources," on page 26	
	Amt	-100...+100	Amount of modulation source	

022: Bass Amp+Cabinet (Bass Amp Model+Cabinet)

This simulates a bass amp and speaker cabinet.

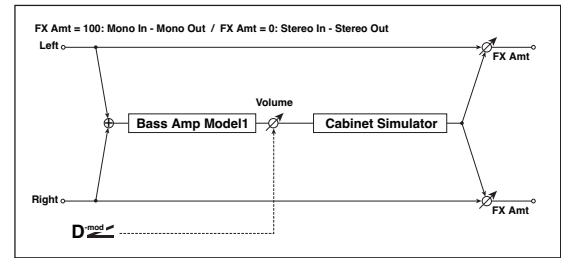

a	Amp Type	LA STUDIO, JAZZ, GOLD PANEL, SCOOPED, VALVE2, VALVE, CLASSIC	Selects the type of the amplifier			
		Volume	0...100		Sets the output level	
		b	Src		Off...Tempo	Selects the modulation source for the output level
			Amt		-100...+100	Sets the modulation amount of the output level
		c	Bass		0...100	Sets the bass (low range) level
		d	Middle		0...100	Sets the middle (mid range) level
			Mid Range		0...4	Sets the mid-frequency range
e	Treble	0...100	Sets the treble (high range) level			
f	Presence	0...100	Sets the presence (high-frequency tone)			
g	Cabinet Simulator	Off, On	Switches the cabinet simulator on/off			
h	Cabinet Type	LA - 4x10, MODERN - 4x10, METAL - 4x10, CLASSIC - 8x10, UK - 4x12, STUDIO - 1x15, JAZZ - 1x15, VOX AC100 - 2x15, US - 2x15, UK - 4x15, LA - 1x18, COMBI - 1x12 & 1x18	Selects the cabinet type			
		FX Amount	0...100		Amount of FX added to the direct signal	
		i	Src		Off...Tempo	Table , "Dynamic Modulation sources," on page 26
Amt	-100...+100		Amount of modulation source			

a: Amp Type

h: Cabinet Type

Recommended Combinations of Bass Amp Models and Cabinets:

Amp Type	Cabinet Type
LA STUDIO	LA - 4x10, LA - 1x18
JAZZ	JAZZ - 1x15
GOLD PANEL	MODERN - 4x10
SCOOPED	METAL - 4x10
VALVE2	CLASSIC - 8x10
VALVE	CLASSIC - 8x10
CLASSIC	COMBI - 1x12 & 1x18

023: Tube PreAmp Model (Tube PreAmp Modeling)

This effect simulates a two-stage vacuum tube preamp. You can make individual settings for two vacuum tubes connected in series. This lets you create the warm sound typical of vacuum tubes.

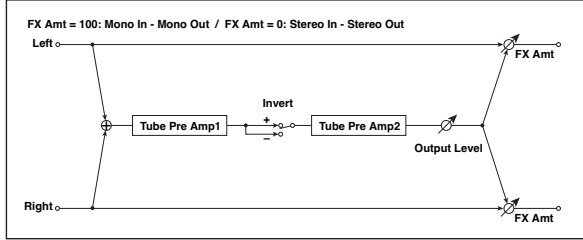

a	Tube1 Low Cut [Hz]	Thru, 21...8.00k	Sets the cutoff frequency for the low cut filter of stage 1	
	High Cut [Hz]	53...20.00k, Thru	Sets the cutoff frequency for the high cut filter of stage 1	
b	Tube1 Gain [dB]	-24.0...+24.0	Sets the input gain for stage 1	
	Saturation [%]	0...100	Sets the input/output response for stage 1	
c	Tube1 Bias	0...100	Sets the bias voltage for stage 1	
d	Tube1 Phase	Normal, Wet Invert	Turns phase reversal on/off	
e	Tube2 Low Cut [Hz]	Thru, 21...8.00k	Sets the cutoff frequency for the low cut filter of stage 2	
	High Cut [Hz]	53...20.00k, Thru	Sets the cutoff frequency for the high cut filter of stage 2	
f	Tube2 Gain [dB]	-24.0...+24.0	Sets the input gain for stage 2	
	Saturation [%]	0...100	Sets the input/output response for stage 2	
g	Tube2 Bias	0...100	Sets the bias voltage for stage 2	
h	Tube2 Output Level [dB]	-48.0...+0.0	Sets the output level	
i	FX Amount	0...100	Amount of FX added to the direct signal	
	Src	Off...Tempo	Table, "Dynamic Modulation sources," on page 26	
	Amt	-100...+100	Amount of modulation source	

b, f: Saturation [%]

With higher settings of this value, the waveform will change at high gain levels, tending to cause distortion. Lower settings of this value will produce linear response.

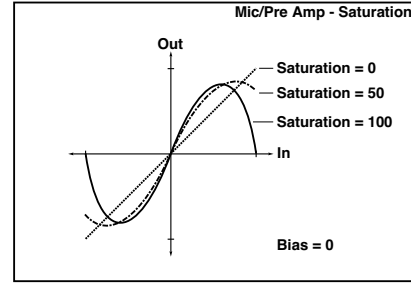

c: Tube1 Bias

This expresses the effect that changes in vacuum tube bias have on the distortion of the waveform. Higher settings of this value will produce distortion even at low gain levels. Since this will also change the overtone structure, you can use it to control the tonal character.

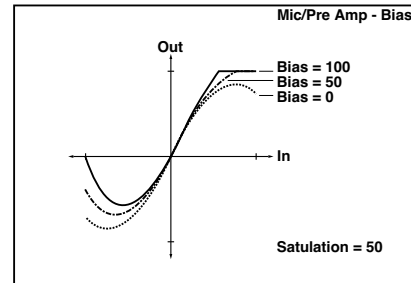

d: Tube1 Phase

With the Wet Invert setting, the phase of the signal will be inverted between stage 1 and stage 2. Since "Bias" is applied to the inverted signal in stage 2, this will change the tonal character.

024: St. Tube PreAmp (Stereo Tube PreAmp Modeling)

This is a stereo vacuum tube preamp simulator (See “023: Tube PreAmp Model (Tube PreAmp Modeling)” on page 42.).

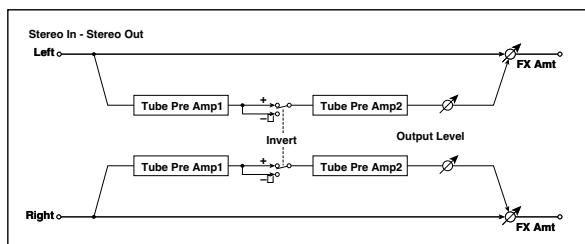

025: Mic Model+PreAmp (Mic Modeling + PreAmp)

This effect simulates a mic and vacuum tube preamp. You can choose from various types of mic and positions to create differing sonic characters.

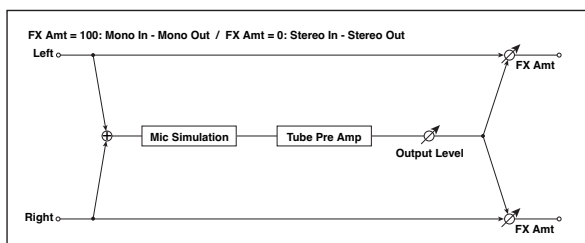

a	Mic Type	Vintage Dynamic, Multi Condenser, Percussion Condenser, Drums Dynamic, Vocal Dynamic, Multi Dynamic, Vocal Condenser, Vocal Tube, Kick Dynamic	Selects the type of mic	
b	Mic Position	Close, On, Off, Far	Sets the mic placement distance	
c	Tube Low Cut [Hz]	Thru, 21...8.00k	Sets the frequency of the low cut filter	
	High Cut [Hz]	53...20.00k, Thru	Sets the frequency of the high cut filter	
d	Tube Gain [dB]	-24.0...+24.0	Sets the input gain to the vacuum tube preamp	
	Saturation [%]	0...100	Sets the input/output response of the preamp	
e	Tube Bias	0...100	Sets the bias level of the preamp	
f	Tube Output Level [dB]	-48.0...+0.0	Sets the output level of the preamp	
g	FX Amount	0...100	Amount of FX added to the direct signal	D ^{mod}
	Src	Off...Tempo	Table, "Dynamic Modulation sources," on page 26	
	Amt	-100...+100	Amount of modulation source	

b: Mic Position

This expresses the effect that the mic position has on the sound. The Close setting is the closest mic position, and the Far setting is the farthest.

Chorus, Flanger, and Phaser (Cho/Fln Phaser)

026: Stereo Chorus

This effect adds thickness and warmth to the sound by modulating the delay time of the input signal. You can add spread to the sound by offsetting the phase of the left and right LFOs from each other.

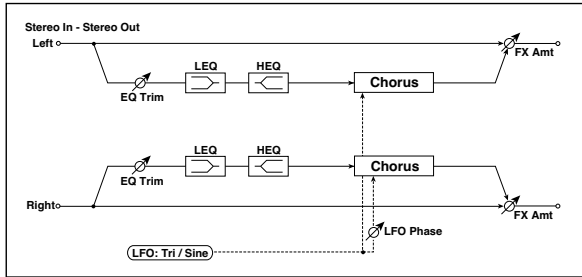

a	LFO Waveform	Triangle, Sine	Selects the LFO Waveform	
	LFO Phase [degree]	-180...+180	Sets the LFO phase difference between the left and right	
b	LFO Frequency [Hz]	0.02...20.00	Sets the speed of the LFO	
	Src	Off...Tempo	Selects a modulation source for LFO speed	
	Amt	-20.00...+20.00	Sets the modulation amount of LFO speed	
c	MIDI Sync	Off, On	When this is on, the LFO speed is set by BPM, Base Note, and Times, instead of Frequency	
	BPM	MIDI, 40.00...300.00	MIDI syncs to the system tempo; 40-300 sets the tempo manually for this individual effect	
	Base Note		Selects the type of notes that specify the LFO speed	
	Times	x1...x32	Sets the number of notes that specify the LFO speed	
d	L Pre Delay [msec]	0.0...50.0	Sets the delay time for the left channel	
	R Pre Delay [msec]	0.0...50.0	Sets the delay time for the right channel	
e	Depth	0...100	Sets the depth of LFO modulation	
	Src	Off...Tempo	Selects the modulation source for the LFO modulation depth	
	Amt	-100...+100	Sets the modulation amount of the LFO modulation depth	
f	EQ Trim	0...100	Sets the EQ input level	
g	Pre LEQ Fc	Low, Mid-Low	Selects the cutoff frequency (low or mid-low) of the low-range equalizer	
	Pre HEQ Fc	High, Mid-High	Selects the cutoff frequency (high or mid-high) of the high-range equalizer	
h	Pre LEQ Gain [dB]	-15.0...+15.0	Gain of the Low EQ	
	Pre HEQ Gain [dB]	-15.0...+15.0	Gain of the High EQ	
i	FX Amount	-100...0...100	Amount of FX added to the direct signal	
	Src	Off...Tempo	Table, "Dynamic Modulation sources," on page 26	
	Amt	-100...+100	Amount of modulation source	

d: L Pre Delay [msec]

d: R Pre Delay [msec]

Setting the left and right delay time individually allows you to control the stereo image.

027: St.HarmonicChorus (Stereo Harmonic Chorus)

This effect applies chorus only to higher frequencies. This can be used to apply a chorus effect to a bass sound without making the sound thinner. You can also use this chorus block with feedback as a flanger.

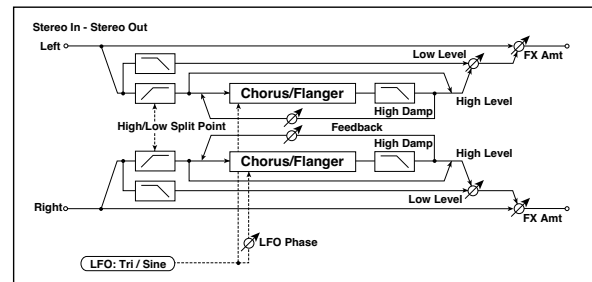

a	LFO Waveform	Triangle, Sine	Selects the LFO Waveform	
	LFO Phase [degree]	-180...+180	Sets the LFO phase difference between the left and right	
b	LFO Frequency [Hz]	0.02...20.00	Sets the speed of the LFO	
	Src	Off...Tempo	Selects a modulation source for LFO speed	
	Amt	-20.00...+20.00	Sets the modulation amount of LFO speed	
c	MIDI Sync	Off, On	When this is on, the LFO speed is set by BPM, Base Note, and Times, instead of Frequency	
	BPM	MIDI, 40.00...300.00	MIDI syncs to the system tempo; 40-300 sets the tempo manually for this individual effect	
	Base Note		Selects the type of notes that specify the LFO speed	
	Times	x1...x32	Sets the number of notes that specify the LFO speed	
d	Pre Delay [msec]	0.0...50.0	Sets the delay time from the original sound	
e	Depth	0...100	Sets the depth of LFO modulation	
	Src	Off...Tempo	Selects the modulation source of the LFO modulation depth	
	Amt	-100...+100	Sets the modulation amount of the LFO modulation depth	
f	High/Low Split Point	1...100	Sets the frequency split point between the low and high range	
g	Feedback	-100...+100	Sets the feed back amount of the chorus block	
	High Damp [%]	0...100	Sets the high range damping amount of the chorus block	
h	Low Level	0...100	Sets the low range output level	
	High Level	0...100	Sets the high range (chorus) output level	
i	FX Amount	0...100	Amount of FX added to the direct signal	
	Src	Off...Tempo	Table, "Dynamic Modulation sources," on page 26	
	Amt	-100...+100	Amount of modulation source	

f: High/Low Split Point

This parameter sets the frequency that splits the high and low range. Only the high range will be sent to the chorus block.

g: Feedback

Sets the feedback amount of the chorus block. Increasing the feedback will allow you to use the effect as a flanger.

028: St. Biphase Mod. (Stereo Biphase Modulation)

This stereo chorus effect adds two different LFOs together. You can set the Frequency and Depth parameters for each LFO individually. Depending on the setting of these LFOs, very complex waveforms will create an analog-type, unstable modulated sound.

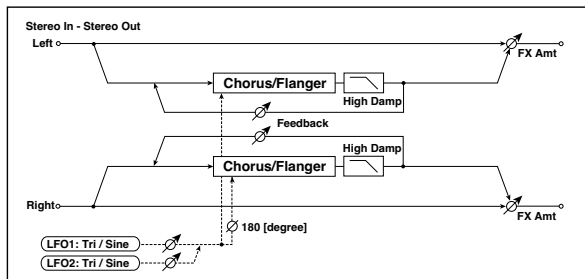

a	LFO1 Waveform	Triangle, Sine	Selects LFO1 waveform	
	LFO2	Triangle, Sine	Selects LFO2 waveform	
	Phase Sw	0 deg, 180 deg	Switches the LFO phase difference between left and right	
b	LFO1 Frequency [Hz]	0.02...30.00	Sets the LFO1 speed	
	Src	Off...Tempo	Selects the modulation source of LFO1&2 speed	
	LFO1 Amt	-30.00...+30.00	Sets the modulation amount of LFO1 speed	
c	LFO2 Frequency [Hz]	0.02...30.00	Sets the LFO2 speed	
	Amt	-30.00...+30.00	Sets the modulation amount of LFO2 speed	
d	Depth1	0...100	Sets the depth of LFO1 modulation	
	Src	Off...Tempo	Selects the modulation source of LFO1&2 modulation depth	
	Amt	-100...+100	Sets the modulation amount of LFO1 modulation depth	
e	Depth2	0...100	Sets the depth of LFO2 modulation	
	Amt	-100...+100	Sets the modulation amount of LFO2 modulation depth	
f	L Pre Delay [msec]	0.0...50.0	Sets the delay time for the left channel	
	R Pre Delay [msec]	0.0...50.0	Sets the delay time for the right channel	
g	Feedback	-100...+100	Sets the feedback amount	
	High Damp [%]	0...100	Sets the damping amount in the high range	
h	FX Amount	-100...0...100	Amount of FX added to the direct signal	
	Src	Off...Tempo	Table, "Dynamic Modulation sources," on page 26	
	Amt	-100...+100	Amount of modulation source	

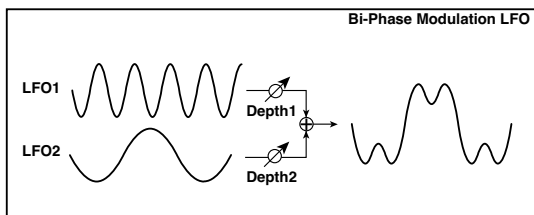

029: Multitap Cho/Delay (Multitap Chorus/Delay)

This effect has four chorus blocks with a different LFO phase. You can create a complex stereo image by setting each block's delay time, depth, output level, and pan individually. You can also fix some of the chorus blocks to combine the chorus and delay effects.

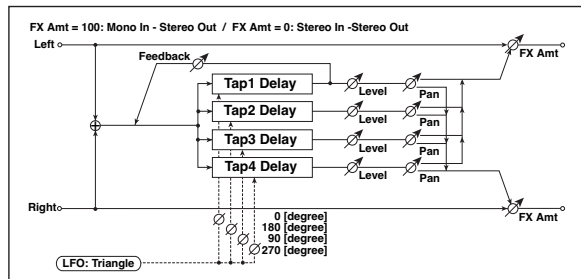

a	LFO Frequency [Hz]	0.02...13.00	Sets the speed of the LFO	
	Tap1 (000) [msec]	0...1000	Sets the Tap1 (LFO phase=0 degrees) delay time	
	Depth	0...30	Sets the Tap1 chorus depth	
b	Level	0...30	Sets the Tap1 output level	
	Pan	L6...L1, C, R1...R6	Sets the Tap1 stereo image	
	Tap2 (180) [msec]	0...1000	Sets the Tap2 (LFO phase=180 degrees) delay time	
c	Depth	0...30	Sets the Tap2 chorus depth	
	Level	0...30	Sets the Tap2 output level	
	Pan	L6...L1, C, R1...R6	Sets the Tap2 stereo image	
d	Tap3 (090) [msec]	0...1000	Sets the Tap3 (LFO phase=90 degrees) delay time	
	Depth	0...30	Sets the Tap3 chorus depth	
	Level	0...30	Sets the Tap3 output level	
e	Pan	L6...L1, C, R1...R6	Sets the Tap3 stereo image	
	Tap4 (270) [msec]	0...1000	Sets the Tap4 (LFO phase=270 degrees) delay time	
	Depth	0...30	Sets the Tap4 chorus depth	
f	Level	0...30	Sets the Tap4 output level	
	Pan	L6...L1, C, R1...R6	Sets the Tap4 stereo image	
	Tap1 Feedback	-100...+100	Sets the Tap1 feedback amount	
g	Src	Off...Tempo	Selects the modulation source of Tap1 feedback amount and effect balance	
	Amt	-100...+100	Sets the Tap1 feedback amount and modulation amount	
g	FX Amount	0...100	Amount of FX added to the direct signal	
	Src	Off...Tempo	Table, "Dynamic Modulation sources," on page 26	
	Amt	-100...+100	Amount of modulation source	

030: Ensemble

This Ensemble effect has three chorus blocks that use LFO to create subtle shimmering, and gives three dimensional depth and spread to the sound, because the signal is output from the left, right, and center.

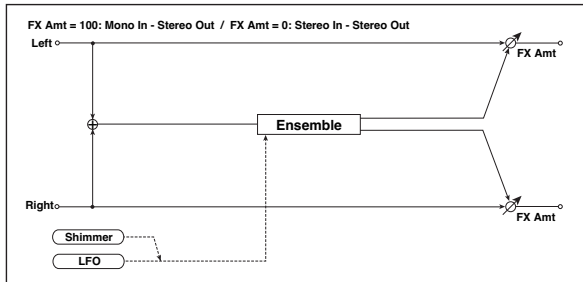

a	Speed	1...100	Sets the speed of the LFO	
	Src	Off...Tempo	Selects a modulation source for LFO speed	
	Amt	-100...+100	Sets the modulation amount of LFO speed	
b	Depth	0...100	Sets the depth of LFO modulation	
	Src	Off...Tempo	Selects the modulation source of the LFO modulation depth	
	Amt	-100...+100	Sets the modulation amount of the LFO modulation depth	
c	Shimmer	0...100	Sets the amount of shimmering of the LFO waveform	
d	FX Amount	0...100	Amount of FX added to the direct signal	
	Src	Off...Tempo	Table, "Dynamic Modulation sources," on page 26	
	Amt	-100...+100	Amount of modulation source	

c: Shimmer

This parameter sets the amount of shimmering of the LFO waveform. Increasing this value adds more shimmering, making the chorus effect more complex and richer.

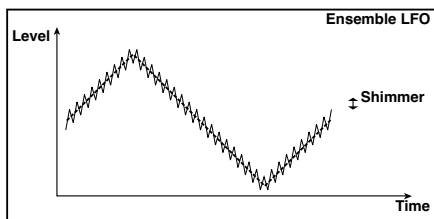

031: Polysix Ensemble

This models the ensemble effect built into the classic Korg PolySix programmable polyphonic synthesizer.

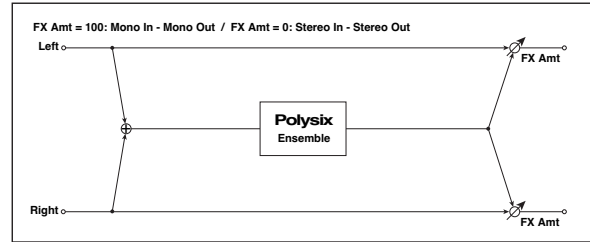

a	Depth	0...100	Sets the depth of the effect	
	Src	Off...Tempo	Selects the modulation source that will control the effect depth	
	Amt	-100...+100	Sets the amount by which the effect depth will be modulated	
b	FX Amount	0...100	Amount of FX added to the direct signal	
	Src	Off...Tempo	Table, "Dynamic Modulation sources," on page 26	
	Amt	-100...+100	Amount of modulation source	

032: Stereo Flanger

This effect gives a significant swell and movement of pitch to the sound. It is more effective when applied to a sound with a lot of harmonics. This is a stereo flanger. You can add spread to the sound by offsetting the phase of the left and right LFOs from each other.

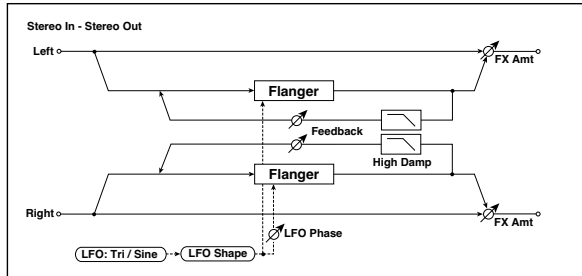

a	Delay Time [msec]	0.0...50.0	Sets the delay time from the original sound	
b	LFO Waveform	Triangle, Sine	Selects the LFO Waveform	
	LFO Shape	-100...+100	Changes the curvature of the LFO Waveform	
c	LFO Phase [degree]	-180...+180	Sets the LFO phase difference between the left and right	
d	LFO Frequency [Hz]	0.02...20.00	Sets the speed of the LFO	D ^{mod}
	Src	Off...Tempo	Selects a modulation source for LFO speed	
	Amt	-20.00...+20.00	Sets the modulation amount of LFO speed	
e	MIDI Sync	Off, On	When this is on, the LFO speed is set by BPM, Base Note, and Times, instead of Frequency	ASync
	BPM	MIDI, 40.00...300.00	MIDI syncs to the system tempo; 40-300 sets the tempo manually for this individual effect	
	Base Note	♪...♭	Selects the type of notes that specify the LFO speed	
	Times	x1...x32	Sets the number of notes that specify the LFO speed	
f	Depth	0...100	Sets the depth of LFO modulation	
g	Feedback	-100...+100	Sets the feedback amount	
	High Damp [%]	0...100	Sets the feedback damping amount in the high range	
h	FX Amount	-100...0...100	Amount of FX added to the direct signal	D ^{mod}
	Src	Off...Tempo	Table, "Dynamic Modulation sources," on page 26	
	Amt	-100...+100	Amount of modulation source	

g: Feedback

h: FX Amount

The peak shape of the positive and negative "Feedback" value is different. The harmonics will be emphasized when the effect sound is mixed with the dry sound if you set a positive value for both "Feedback" and "FX Amount", and if you set a negative value for both "Feedback" and "FX Amount".

g: High Damp [%]

This parameter sets the amount of damping of the feedback in the high range. Increasing the value will cut high-range harmonics.

033: St. Random Flanger (Stereo Random Flanger)

The stereo effect uses a step-shape waveform and random LFO for modulation, creating a unique flanging effect.

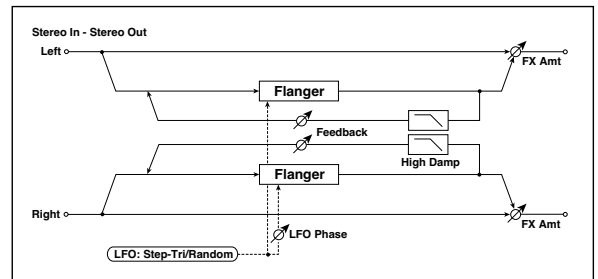

a	Delay Time [msec]	0.0...50.0	Sets the delay time from the original sound	
b	LFO Waveform	Step-Tri, Random	Selects the LFO Waveform	
	LFO Phase [degree]	-180...+180	Sets the LFO phase difference between the left and right	
c	LFO Frequency [Hz]	0.02...20.00	Sets the speed of the LFO	D ^{mod}
	Src	Off...Tempo	Selects the modulation source used for both LFO speed and step speed	
	Amt	-20.00...+20.00	Sets the modulation amount of LFO speed	
d	LFO Step Freq [Hz]	0.05...50.00	Sets the LFO step speed (speed that changes in steps)	D ^{mod}
	Step Amt	-50.00...+50.00	Sets the modulation amount of LFO step speed	
e	MIDI Sync	Off, On	When this is on, the LFO speed is set by BPM, Base Note, and Times, instead of Frequency	ASync
	BPM	MIDI, 40.00...300.00	MIDI syncs to the system tempo; 40-300 sets the tempo manually for this individual effect	
	Base Note	♪...♭	Selects the type of notes that specify the LFO speed	
	Times	x1...x32	Sets the number of notes that specify the LFO speed	
f	Step Base Note	♪...♭	Selects the type of notes to specify the LFO step speed	ASync
	Times	x1...x32	Sets the number of notes to specify the LFO step speed	
g	Depth	0...100	Sets the depth of LFO modulation	
h	Feedback	-100...+100	Sets the feedback amount	
	High Damp [%]	0...100	Sets the feedback damping amount in the high range	
i	FX Amount	-100...0...100	Amount of FX added to the direct signal	D ^{mod}
	Src	Off...Tempo	Table, "Dynamic Modulation sources," on page 26	
	Amt	-100...+100	Amount of modulation source	

034: St. Env. Flanger (Stereo Envelope Flanger)

This Flanger uses an envelope generator for modulation. You will obtain the same pattern of flanging each time you play. You can also control the Flanger directly using the modulation source.

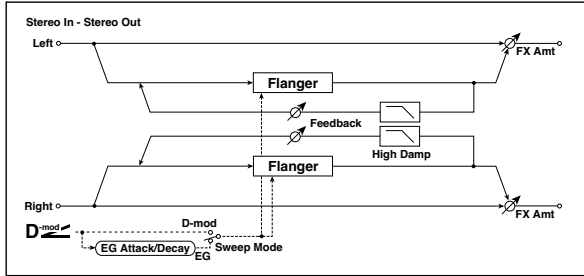

a	L Dly Bottom [msec]	0.0...50.0	Sets the lower limit of the left-channel delay time	
	L Dly Top [msec]	0.0...50.0	Sets the upper limit of the left-channel delay time	
b	R Dly Bottom [msec]	0.0...50.0	Sets the lower limit of the right-channel delay time	
	R Dly Top [msec]	0.0...50.0	Sets the upper limit of the right-channel delay time	
c	Sweep Mode	EG, D-mod	Determines whether the flanger is controlled by the envelope generator or by the modulation source	
	Src	Off...Tempo	Selects the modulation source that triggers the EG (when Sweep Mode = EG), or the modulation source that causes the flanger to sweep (when Sweep Mode = D-mod)	D-mod
d	EG Attack	1...100	Sets the EG attack speed	
	EG Decay	1...100	Sets the EG decay speed	
e	Feedback	-100...+100	Sets the feedback amount	
f	High Damp [%]	0...100	Sets the feedback damping amount in the high range	
g	FX Amount	-100...0...100	Amount of FX added to the direct signal	D-mod
	Src	Off...Tempo	Table , "Dynamic Modulation sources," on page 26	
	Amt	-100...+100	Amount of modulation source	

c: Sweep Mode

c: Src

This parameter switches the flanger control mode. With "Sweep Mode" = EG, the flanger will sweep using the envelope generator. This envelope generator is included in the envelope flanger, and not related to the Pitch EG, Filter EG, or Amp EG.

The "Src" parameter selects the source that starts the envelope generator. If you select, for example, Gate, the envelope generator will start when the note-on message is received.

When "Sweep Mode" = D-mod, the modulation source can control the flanger directly. Select the modulation source using the "Src" parameter.

MIDI The effect is off when a value for the modulation source specified for the "Src" parameter is smaller than 64, and the effect is on when the value is 64 or higher. The Envelope Generator is triggered when the value changes from 63 or smaller to 64 or higher.

d: EG Attack

d: EG Decay

Attack and Decay speed are the only adjustable parameters on this EG.

035: Stereo Phaser

This effect creates a swell by shifting the phase. It is very effective on electric piano sounds. You can add spread to the sound by offsetting the phase of the left and right LFOs from each other.

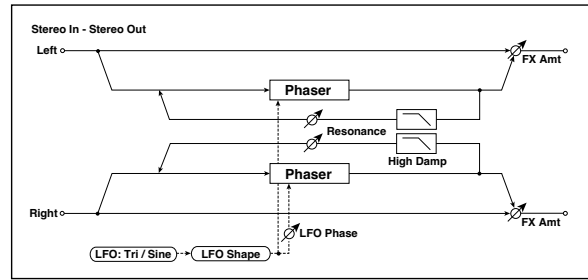

a	LFO Waveform	Triangle, Sine	Selects the LFO Waveform	
	LFO Shape	-100...+100	Changes the curvature of the LFO Waveform	
b	LFO Phase [degree]	-180...+180	Sets the LFO phase difference between the left and right	
c	LFO Frequency [Hz]	0.02...20.00	Sets the speed of the LFO	D-mod
	Src	Off...Tempo	Selects a modulation source for LFO speed	
	Amt	-20.00...+20.00	Sets the modulation amount of LFO speed	
d	MIDI Sync	Off, On	When this is on, the LFO speed is set by BPM, Base Note, and Times, instead of Frequency	ASync
	BPM	MIDI, 40.00...300.00	MIDI syncs to the system tempo; 40-300 sets the tempo manually for this individual effect	
	Base Note	♪...♭	Selects the type of notes that specify the LFO speed	
	Times	x1...x32	Sets the number of notes that specify the LFO speed	
e	Manual	0...100	Sets the frequency to which the effect is applied	D-mod
	Src	Off...Tempo	Selects the modulation source for the LFO modulation	
	Amt	-100...+100	Sets the modulation amount of the LFO modulation	
f	Depth	0...100	Sets the depth of LFO modulation	D-mod
	Src	Off...Tempo	Selects the modulation source for the LFO modulation depth	
	Amt	-100...+100	Sets the modulation amount of the LFO modulation depth	
h	Resonance	-100...+100	Sets the resonance amount	
	High Damp [%]	0...100	Sets the resonance damping amount in the high range	
j	FX Amount	-100...0...100	Amount of FX added to the direct signal	D-mod
	Src	Off...Tempo	Table , "Dynamic Modulation sources," on page 26	
	Amt	-100...+100	Amount of modulation source	

h: Resonance

i: FX Amount

The peak shape of the positive and negative Feedback value is different. The harmonics will be emphasized when the effect sound is mixed with the dry sound, if you set a positive value for both "Resonance" and "FX Amount", and if you set a negative value for both "Resonance" and "FX Amount".

h: High Damp [%]

This parameter sets the amount of damping of the resonance in the high range. Increasing the value will cut high-range harmonics.

036: St. Random Phaser (Stereo Random Phaser)

This is a stereo phaser. The effect uses a step-shape waveform and random LFO for modulation, creating a unique phasing effect.

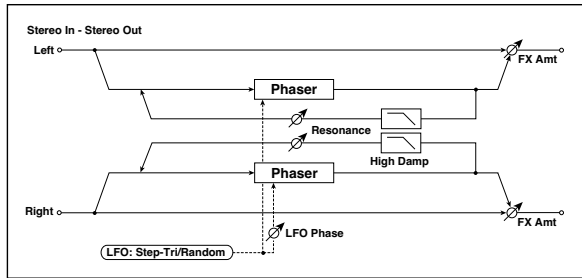

a	LFO Waveform	Step-Tri, Step-Sin, Random	Selects the LFO Waveform	
	LFO Phase [degree]	-180...+180	Selects the LFO phase difference between the left and right	
b	LFO Frequency [Hz]	0.02...20.00	Selects the speed of the LFO	D ^{mod}
	Src	Off...Tempo	Selects the modulation source commonly used for LFO speed and step speed	
c	Amt	-20.00...+20.00	Selects the modulation amount of LFO speed	
	LFO Step Freq [Hz]	0.05...50.00	Selects the LFO step speed	D ^{mod}
d	Amt	-50.00...+50.00	Selects the modulation amount of LFO step speed	
	MIDI Sync	Off, On	When this is on, the LFO speed is set by BPM, Base Note, and Times, instead of Frequency	AJDR
e	BPM	MIDI, 40.00...300.00	MIDI syncs to the system tempo; 40-300 sets the tempo manually for this individual effect	
	Base Note		Selects the type of notes that specify the LFO speed	
f	Times	x1...x32	Selects the number of notes that specify the LFO speed	
	Step Base Note		Selects the type of notes to specify the LFO step speed	AJDR
g	Times	x1...x32	Selects the number of notes to specify the LFO step speed	
	Manual	0...100	Selects the frequency to which the effect is applied	
h	Src	Off...Tempo	Selects the modulation source for the LFO modulation	
	Amt	-100...+100	Selects the modulation amount of the LFO modulation	
i	Depth	0...100	Selects the depth of LFO modulation	
	Resonance	-100...+100	Selects the resonance amount	
j	High Damp [%]	0...100	Selects the resonance damping amount in the high range	
	FX Amount	-100...0...100	Amount of FX added to the direct signal	D ^{mod}
k	Src	Off...Tempo	Table, "Dynamic Modulation sources," on page 26	
	Amt	-100...+100	Amount of modulation source	

037: St. Env. Phaser (Stereo Envelope Phaser)

This stereo phaser uses an envelope generator for modulation. You will obtain the same pattern of phasing each time you play. You can also control the Phaser directly using the modulation source.

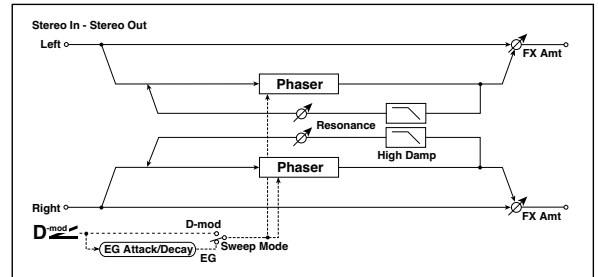

a	L Manu Bottom	0...100	Selects the lower limit of the frequency range for the effect on the left channel	
	L Manu Top	0...100	Selects the upper limit of the frequency range for the effect on the left channel	
b	R Manu Bottom	0...100	Selects the lower limit of the frequency range for the effect on the right channel	
	R Manu Top	0...100	Selects the upper limit of the frequency range for the effect on the right channel	
c	Sweep Mode	EG, D-mod	Determines whether the flanger is controlled by the envelope generator or by the modulation source	
	Src	Off...Tempo	Selects the modulation source that triggers the EG (when EG is selected for Sweep Mode), or modulation source that causes the flanger to sweep (when D-mod is selected for Sweep Mode)	D ^{mod}
d	EG Attack	1...100	Selects the EG attack speed	
	EG Decay	1...100	Selects the EG decay speed	
e	Resonance	-100...+100	Selects the resonance amount	
f	High Damp [%]	0...100	Selects the resonance damping amount in the high range	
g	FX Amount	-100...0...100	Amount of FX added to the direct signal	D ^{mod}
	Src	Off...Tempo	Table, "Dynamic Modulation sources," on page 26	
	Amt	-100...+100	Amount of modulation source	

Modulation and Pitch Shift (Mod./P.Shift)

038: Stereo Vibrato

This effect causes the pitch of the input signal to shimmer. Using the AutoFade allows you to increase or decrease the shimmering speed.

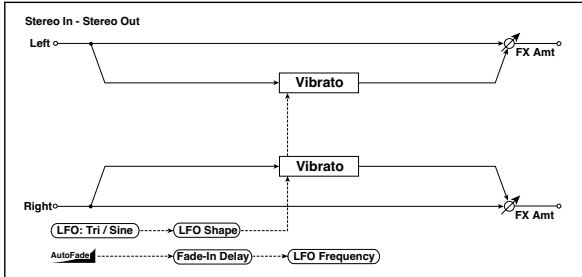

a	AUTOFADE Src	Off...Tempo	Selects the modulation source that starts AutoFade	
b	Fade-In Delay [msec]	00...2000	Sets the fade-in delay time	
	Fade-In Rate	1...100	Sets the rate of fade-in	
c	LFO Waveform	Triangle, Sine	Selects the LFO Waveform	
	LFO Shape	-100...+100	Changes the curvature of the LFO Waveform	
d	LFO Frequency Mod	D-mod, AUTOFADE	Switches between D-mod and AUTOFADE for the LFO frequency modulation	
e	LFO Frequency [Hz]	0.02...20.00	Sets the speed of the LFO	
	Src	Off...Tempo	Selects a modulation source for LFO speed	
f	Amt	-20.00...+20.00	Sets the modulation amount of LFO speed	
	MIDI Sync	Off, On	When this is on, the LFO speed is set by BPM, Base Note, and Times, instead of Frequency	
	BPM	MIDI, 40.00...300.00	MIDI syncs to the system tempo; 40-300 sets the tempo manually for this individual effect	
	Base Note		Selects the type of notes that specify the LFO speed	
g	Times	x1...x32	Sets the number of notes that specify the LFO speed	
	Depth	0...100	Sets the depth of LFO modulation	
	Src	Off...Tempo	Selects the modulation source of the LFO modulation depth	
h	Amt	-100...+100	Sets the modulation amount of the LFO modulation depth	
	FX Amount	0...100	Amount of FX added to the direct signal	
	Src	Off...Tempo	Table, "Dynamic Modulation sources," on page 26	
	Amt	-100...+100	Amount of modulation source	

a: AUTOFADE Src

b: Fade-In Delay [msec]

b: Fade-In Rate

d: LFO Frequency Mod

When "LFO Frequency Mod" is set to AUTOFADE, you can use the modulation source selected in "AUTOFADE Src" as a trigger to automatically fade in the modulation amount. When "MIDI Sync" is set to On, you cannot use this.

The "Fade-In Rate" parameter specifies the rate of fade-in. The "Fade-In Delay" parameter determines the time from AutoFade modulation source On until the fade-in starts.

The following is an example of fade-in where the LFO speed is increased from "1.0Hz" to "4.0Hz" when a note-on message is received.

AUTOFADE Src=Gate1, LFO Frequency Mod=AUTOFADE, LFO Frequency [Hz]=1.0, Amt=3.0

The effect is off when a value for the dynamic modulation source specified for the "AUTOFADE Src" parameter is smaller than 64, and the effect is on when the value is 64 or higher. The AutoFade function is triggered when the value changes from 63 or smaller to 64 or higher.

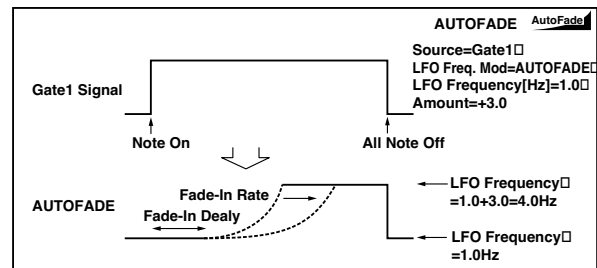

039: St. Auto Fade Mod. (Stereo Auto Fade Modulation)

This stereo chorus/flanger effect enables you to control the LFO speed and effect balance using auto fade, and you can spread the sound by offsetting the phase of the left and right LFOs from each other.

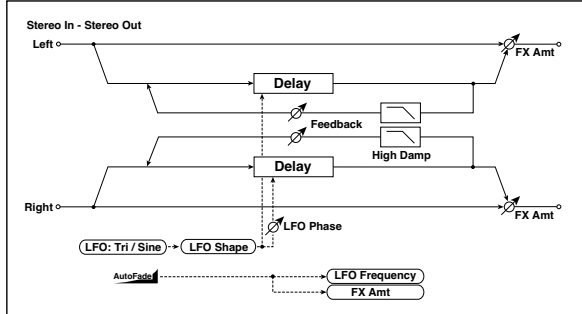

a	AUTOFADE Src	Off...Tempo	Selects the modulation source that starts AutoFade	
	Fade-In Delay [msec]	00...2000	Sets the fade-in delay time	
	Rate	1...100	Sets the rate of fade-in	
b	LFO Frequency Mod	D-mod, AUTOFADE	Switches between D-mod and AUTOFADE for the LFO frequency modulation	
	Wet/Dry Mod	D-mod, AUTOFADE	Switches between D-mod and AUTOFADE for the effect balance modulation	
c	LFO Waveform	Triangle, Sine	Selects the LFO Waveform	
	LFO Shape	-100...+100	Changes the curvature of the LFO Waveform	
d	LFO Phase [degree]	-180...+180	Sets the LFO phase difference between the left and right	
e	LFO Frequency [Hz]	0.02...20.00	Sets the speed of the LFO	
	Src	Off...Tempo	Selects a modulation source for LFO speed	
	Amt	-20.00...+20.00	Sets the modulation amount of LFO speed	
f	L Delay Time [msec]	0.0...500.0	Sets the left channel delay time	
	R Delay Time [msec]	0.0...500.0	Sets the right channel delay time	
g	Depth	0...200	Sets the depth of LFO modulation	
h	Feedback	-100...+100	Sets the feedback amount	
	High Damp [%]	0...100	Sets the feedback damping amount in the high range	
i	FX Amount	-100...0...100	Amount of FX added to the direct signal	
	Src	Off...Tempo	Table, "Dynamic Modulation sources," on page 26	
	Amt	-100...+100	Amount of modulation source	

040: 2Voice Resonator

This effect resonates the input signal at a specified pitch. You can set the pitch, output level, and pan settings for two resonators individually. You can control the resonance intensity via an LFO.

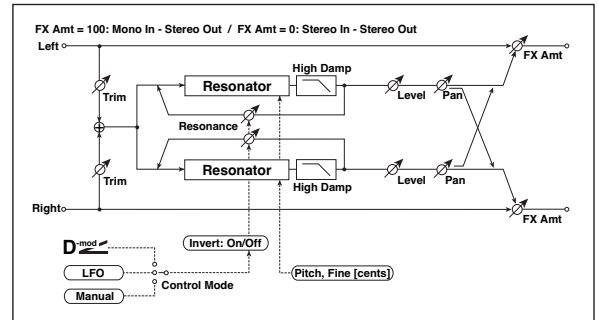

a	Control Mode	Manual, LFO, D-mod	Switches the controls of resonance intensity	
	LFO/D-mod Invert	Off, On	Reverses the Voice 1 and 2 control when LFO/D-mod is selected	
b	LFO Frequency [Hz]	0.02...20.00	Sets the speed of the LFO	
	D-mod Src	Off...Tempo	Selects the modulation source that controls resonance intensity	
c	MIDI Sync	Off, On	When this is on, the LFO speed is set by BPM, Base Note, and Times, instead of Frequency	
	BPM	MIDI, 40.00...300.00	MIDI syncs to the system tempo; 40-300 sets the tempo manually for this individual effect	
	Base Note		Selects the type of notes that specify the LFO speed	
	Times	x1...x32	Sets the number of notes that specify the LFO speed	
d	Mod. Depth	-100...+100	Sets the amount of resonance intensity control via LFO/D-mod	
	Trim	0...100	Sets the input level at the resonator	
e	Voice1: Pitch	C0...B8	Sets the voice 1 Pitch for resonance	
	Fine [cents]	-50...+50	Fine-adjusts the voice 1 pitch for resonance	
	Level	0...100	Sets the Voice1 output level	
f	Voice1: Resonance	-100...+100	Sets the intensity of resonance when Control Mode = Manual	
	High Damp [%]	0...100	Sets the damping amount of resonant sound in the high range	
	Pan	L6...L1, C, R1...R6	Sets the Voice1 stereo image	
g	Voice2: Pitch	C0...B8	Sets the voice 2 Pitch for resonance	
	Fine [cents]	-50...+50	Fine-adjusts the voice 2 pitch for resonance	
	Level	0...100	Sets the Voice2 output level	
h	Voice2: Resonance	-100...+100	Sets the intensity of resonance when Control Mode = Manual	
	High Damp [%]	0...100	Sets the damping amount of resonant sound in the high range	
	Pan	L6...L1, C, R1...R6	Sets the Voice2 stereo image	
i	FX Amount	0...100	Amount of FX added to the direct signal	
	Src	Off...Tempo	Table, "Dynamic Modulation sources," on page 26	
	Amt	-100...+100	Amount of modulation source	

a: Control Mode

f: Voice 1: Resonance

h: Voice 2: Resonance

This parameter determines the resonance intensity.

When “Control Mode” = Manual, the “Resonance” parameter sets the intensity of resonance. If the “Resonance” parameter has a negative value, harmonics will be changed, and resonance will occur at a pitch one octave lower.

When “Control Mode” = LFO, the intensity of resonance varies according to the LFO. The LFO sways between positive and negative values, causing resonance to occur between specified pitches an octave apart in turn.

When “Control Mode” = D-mod, the resonance is controlled by the dynamic modulation source. If JS X or Ribbon is assigned as the modulation source, the pitch an octave higher and lower can be controlled, similar to when LFO is selected for Control Mode.

a: LFO/D-mod Invert

When “Control Mode” = LFO or D-mod, the controlled phase of either Voice 1 or 2 will be reversed. When the resonance pitch is set for Voice 1 (Resonance has a positive value), Voice 2 will resonate at a pitch an octave below (Resonance has a negative value).

f: Voice 1: Pitch

f: Fine [cents]

h: Voice 2: Pitch

h: Fine [cents]

The Pitch parameter specifies the pitch of resonance by note name. The “Fine” parameter allows for fine adjustment in steps of cents.

g: High Damp [%]

i: High Damp [%]

This sets the amount of damping amount for the high frequencies of the resonant sound. Lower values create a metallic sound with a higher range of harmonics.

041: Doppler

This effect simulates the “Doppler effect” of a moving sound with a changing pitch, similar to the siren of an passing ambulance. Mixing the effect sound with the dry sound will create a unique chorus effect.

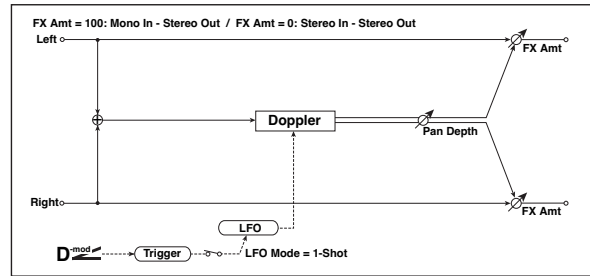

a	LFO Mode	Loop, 1-Shot	Switches LFO operation mode	
	Src	Off...Tempo	Selects the modulation source of LFO reset	
b	LFO Sync	Off, On	Switches between LFO reset on and off when LFO Mode is set to Loop	
c	LFO Frequency [Hz]	0.02...20.00	Sets the speed of the LFO	
	Src	Off...Tempo	Selects a modulation source for LFO speed	
d	Amt	-20.00...+20.00	Sets the modulation amount of LFO speed	
	MIDI Sync	Off, On	When this is on, the LFO speed is set by BPM, Base Note, and Times, instead of Frequency	
e	BPM	MIDI, 40.00...300.00	MIDI syncs to the system tempo; 40-300 sets the tempo manually for this individual effect	
	Base Note		Selects the type of notes that specify the LFO speed	
	Times	x1...x32	Sets the number of notes that specify the LFO speed	
f	Pitch Depth	0...100	Sets the pitch variation of the moving sound	
	Src	Off...Tempo	Selects the modulation source of pitch variation	
g	Amt	-100...+100	Sets the modulation amount of pitch variation	
	Pan Depth	-100...+100	Sets the panning of the moving sound	
h	Src	Off...Tempo	Selects the modulation source of panning	
	Amt	-100...+100	Sets the modulation amount of panning	
i	FX Amount	0...100	Amount of FX added to the direct signal	
	Src	Off...Tempo	Table, “Dynamic Modulation sources,” on page 26	
j	Amt	-100...+100	Amount of modulation source	

a: LFO Mode

a: Src

b: LFO Sync

The “LFO Mode” parameter switches LFO operation mode. When Loop is selected, the Doppler effect will be created repeatedly. If “LFO Sync” is set to On, the LFO will be reset when the modulation source specified with the “Src” parameter is turned on.

When “LFO Mode” is set to 1-Shot, the Doppler effect is created only once when the modulation source specified in the “Src” field is turned on. At this time if you do not set the “Src” parameter, the Doppler effect will not be created, and no effect sound will be output.

MIDI The effect is off when a value for the modulation source specified for the “Src” parameter is smaller than 64, and the effect is on when the value is 64 or higher. The Doppler effect is triggered when the value changes from 63 or smaller to 64 or higher.

e: Pitch Depth

With the Doppler effect, the pitch is raised when the sound approaches, and the pitch is lowered when the sound goes away. This parameter sets this pitch variation.

f: Pan Depth

This parameter sets the width of the stereo image of the effect sound. With larger values, the sound seems to come and go from much further away. With positive values, the sound moves from left to right; with negative values, the sound moves from right to left.

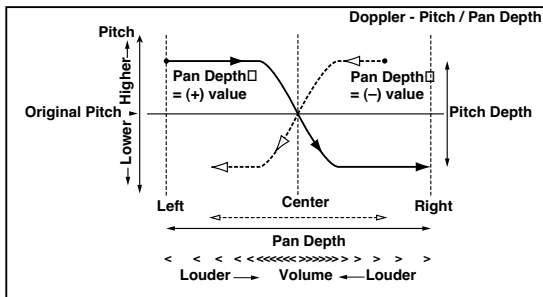

042: Scratch

This effect is applied by recording the input signal and moving the modulation source. It simulates the sound of scratches you can make using a turntable.

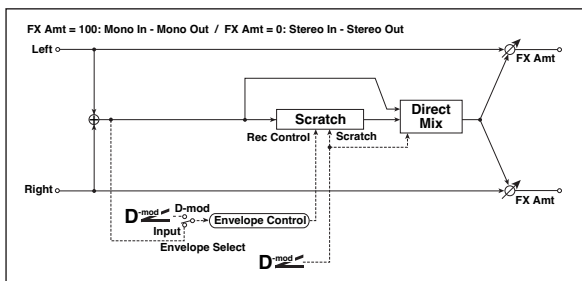

a: Scratch Source

b: Response

The Scratch Source parameter enables you to select the modulation source that controls simulation. The value of the modulation source corresponds to the playback position. The Response parameter enables you to set the speed of the response to the modulation source.

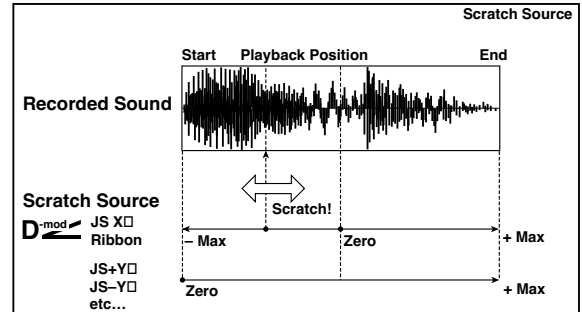

c: Envelope Select

c: Src

d: Threshold

When “Envelope Select” is set to D-mod, the input signal will be recorded only when the modulation source value is 64 or higher.

When “Envelope Select” is set to Input, the input signal will be recorded only when its level is over the Threshold value.

The maximum recording time is 2,730msec. If this is exceeded, the recorded data will start being erased from the top.

e: Response

This parameter enables you to set the speed of the response to the end of recording. Set a smaller value when you are recording a phrase or rhythm pattern, and set a higher value if you are recording only one note.

f: Direct Mix

With Always On, a dry sound is usually output. With Always Off, dry sounds are not output. With Cross Fade, a dry sound is usually output, and it is muted only when scratching.

Set FX Amount to 100 to use this parameter effectively.

a	Scratch Source	Off...Tempo	Selects the modulation source for simulation control	D-mod
b	Response	0...100	Sets the speed of the response to the Scratch Src	
c	Envelope Select	D-mod, Input	Selects whether the start and end of recording is controlled via the modulation source or the input signal level	
	Src	Off...Tempo	Selects the modulation source that controls recording when Envelope Select is set to D-mod	D-mod
d	Threshold	0...100	Sets the recording start level when Envelope Select is set to Input	
e	Response	0...100	Sets the speed of the response to the end of recording	
f	Direct Mix	Always On, Always Off, Cross Fade	Selects how a dry sound is mixed	
g	FX Amount	0...100	Amount of FX added to the direct signal	D-mod
	Src	Off...Tempo	Table, “Dynamic Modulation sources,” on page 26	
	Amt	-100...+100	Amount of modulation source	

043: Grain Shifter

This effect cuts extremely short samples (“grains”) from the input signal waveform and plays them repeatedly, giving a mechanical character to the sound.

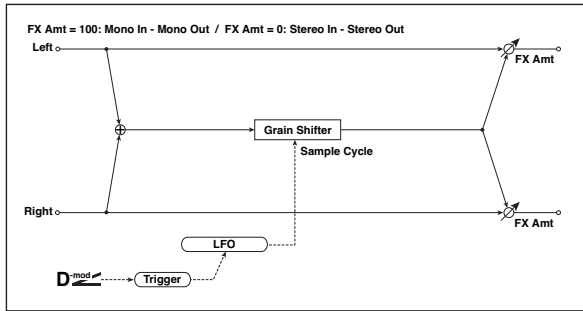

a	Duration	0...100	Sets the duration of the grain	
	Src	Off...Tempo	Selects the source that will modulate the duration of the grain	
	Amt	-100...+100	Sets the amount by which the grain duration will be modulated	
b	LFO Sync Src	Off...Tempo	Selects the modulation source that will reset the LFO	
c	LFO Sample Cycle [Hz]	0.02...20.00	Sets the frequency at which the grain will be switched	
	Src	Off...Tempo	Selects a modulation source for LFO speed	
	Amt	-20.00...+20.00	Sets the modulation amount of LFO speed	
d	MIDI Sync	Off, On	When this is on, the LFO speed is set by BPM, Base Note, and Times, instead of Frequency	
	BPM	MIDI, 40.00...300.00	MIDI syncs to the system tempo; 40-300 sets the tempo manually for this individual effect	
	Base Note		Selects the type of notes that specify the LFO speed	
	Times	x1...x32	Sets the number of notes that specify the LFO speed	
e	FX Amount	0...100	Amount of FX added to the direct signal	
	Src	Off...Tempo	Table, “Dynamic Modulation sources,” on page 26	
	Amt	-100...+100	Amount of modulation source	

a: Duration

c: LFO Sample Cycle [Hz]

Duration sets the length of the sampled grain, and the **LFO Sample Cycle** controls how often a new grain is sampled. In between Sample Cycles, the current grain is repeated continuously.

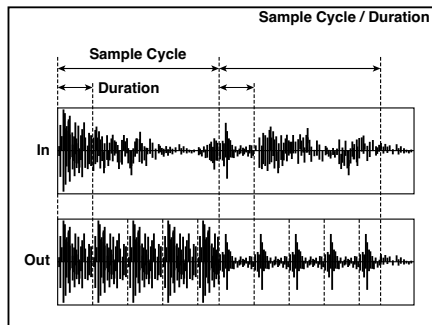

044: Stereo Tremolo

This effect modulates the volume level of the input signal. The effect is stereo, and offsetting the LFO of the left and right phases from each other produces a tremolo effect between left and right.

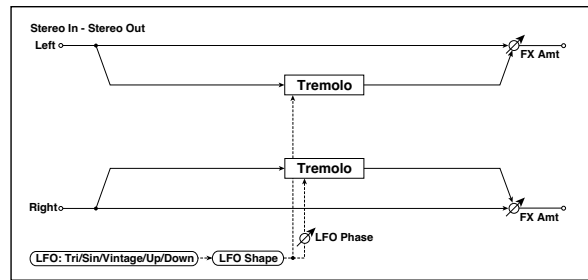

a	LFO Waveform	Triangle, Sine, Vintage, Up, Down	Selects the LFO Waveform	
	LFO Shape	-100...+100	Changes the curvature of the LFO Waveform	
b	LFO Phase [degree]	-180...+180	Sets the LFO phase difference between the left and right	
c	LFO Frequency [Hz]	0.02...20.00	Sets the speed of the LFO	
	Src	Off...Tempo	Selects a modulation source for LFO speed	
	Amt	-20.00...+20.00	Sets the modulation amount of LFO speed	
d	MIDI Sync	Off, On	When this is on, the LFO speed is set by BPM, Base Note, and Times, instead of Frequency	
	BPM	MIDI, 40.00...300.00	MIDI syncs to the system tempo; 40-300 sets the tempo manually for this individual effect	
	Base Note		Selects the type of notes that specify the LFO speed	
	Times	x1...x32	Sets the number of notes that specify the LFO speed	
e	Depth	0...100	Sets the depth of LFO modulation	
	Src	Off...Tempo	Selects the modulation source of the depth of modulation	
	Amt	-100...+100	Sets the modulation amount of the depth of modulation	
f	FX Amount	0...100	Amount of FX added to the direct signal	
	Src	Off...Tempo	Table, “Dynamic Modulation sources,” on page 26	
	Amt	-100...+100	Amount of modulation source	

a: LFO Waveform

This parameter sets the basic shape of the LFO. The **Vintage** waveform models classic guitar-amp tremolo.

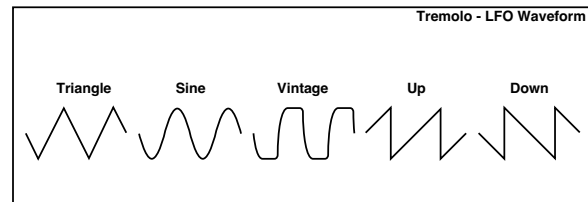

b: LFO Phase [degree]

This parameter determines the difference between the left and right LFO phases. A higher value will simulate the auto-pan effect in which the sound is panned between left and right.

045: St. Env. Tremolo (Stereo Envelope Tremolo)

This effect uses the input signal level to modulate a stereo tremolo (LFO volume modulation). For instance, you can create a tremolo effect that becomes deeper and faster as the input gets more quiet.

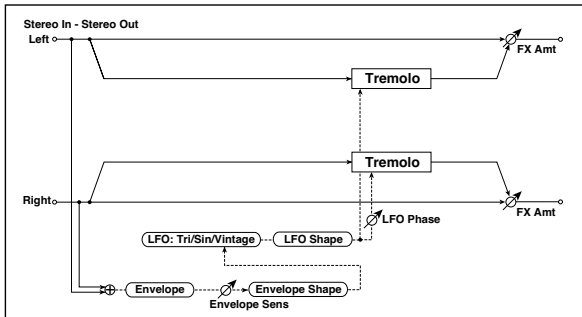

a	Envelope Sens	0...100	Sets the envelope's sensitivity to the input signal	
	Envelope Shape	-100...+100	Sets the envelope's curvature	
b	LFO Waveform	Triangle, Sine, Vintage	Selects the LFO Waveform	
	LFO Shape	-100...+100	Changes the curvature of the LFO Waveform	
c	LFO Phase [degree]	-180...+180	Sets the LFO phase difference between the left and right	
d	LFO Frequency [Hz]	0.02...20.00	Sets the speed of the LFO	
	Envelope Amount [Hz]	-20.00...+20.00	Sets the amount added to or subtracted from the Frequency when the envelope is at maximum	
e	Depth	0...100	Sets the initial amount of tremolo	
	Envelope Amount	-100...+100	Sets the amount added to or subtracted from the Depth when the envelope is at maximum	
f	FX Amount	0...100	Amount of FX added to the direct signal	
	Src	Off...Tempo	Table, "Dynamic Modulation sources," on page 26	
	Amt	-100...+100	Amount of modulation source	

- d: LFO Frequency [Hz]**
- d: Envelope Amount [Hz]**
- e: Depth**
- e: Envelope Amount**

The graphic below shows an example of tremolo modulation with negative modulation of both **Depth** and **Frequency**. At the start of the note, the input is at maximum volume. This slows down the LFO **Frequency** to **1.0Hz**, but also modulates the **Depth** to **0**—so the tremolo doesn't have any effect.

As the input volume dies down, the **Frequency** speeds up; the **Depth** also increases, making the tremolo effect increasingly audible. When the input volume approaches silence, the **Depth** is at its maximum (**100**) and **Frequency** is at **8Hz**.

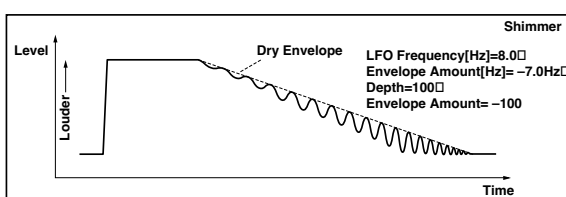

046: Stereo Auto Pan

This is a stereo-in, stereo-out auto-panner. The Phase and Shape parameters lets you create various panning effects, such as making the left and right inputs seem to chase each other around the stereo field.

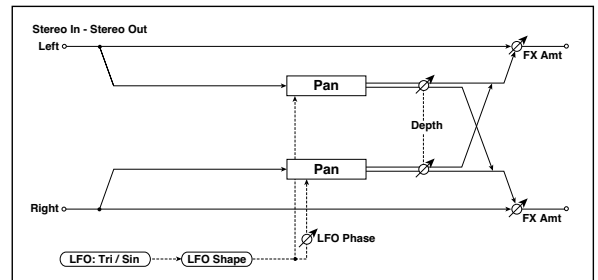

a	LFO Waveform	Triangle, Sine	Selects the LFO Waveform	
	LFO Shape	-100...+100	Changes the curvature of the LFO Waveform	
b	LFO Phase [degree]	-180...+180	Sets the LFO phase difference between the left and right	
c	LFO Frequency [Hz]	0.02...20.00	Sets the speed of the LFO	
	Src	Off...Tempo	Selects a modulation source for LFO speed	
	Amt	-20.00...+20.00	Sets the modulation amount of LFO speed	
d	MIDI Sync	Off, On	When this is on, the LFO speed is set by BPM, Base Note, and Times, instead of Frequency	
	BPM	MIDI, 40.00...300.00	MIDI syncs to the system tempo; 40-300 sets the tempo manually for this individual effect	
	Base Note		Selects the type of notes that specify the LFO speed	
	Times	x1...x32	Sets the number of notes that specify the LFO speed	
e	Depth	0...100	Sets the depth of LFO modulation	
	Src	Off...Tempo	Selects the modulation source of the depth of modulation	
	Amt	-100...+100	Sets the modulation amount of the depth of modulation	
f	FX Amount	0...100	Amount of FX added to the direct signal	
	Src	Off...Tempo	Table, "Dynamic Modulation sources," on page 26	
	Amt	-100...+100	Amount of modulation source	

a: LFO Shape

You can change the panning curve by modifying the LFO's **Shape**.

b: LFO Phase [degree]

This determines the phase difference between the left and right LFOs. When you gradually change the value away from 0, the sounds from the left and right channels will seem to chase each other around. If you set the parameter to +180 or -180, the sounds from each channel will cross over each other.

You'll only hear the effect of this parameter if the input is true stereo, with different signals in the left and right channels.

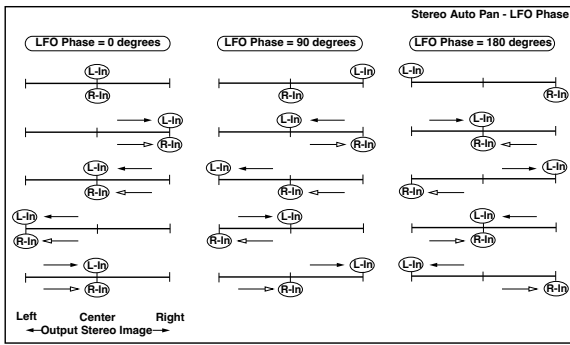

047: St. Phaser + Trml (Stereo Phaser + Tremolo)

This effect combines a stereo phaser and tremolo, with linked LFOs. Swelling phaser modulation and tremolo effects synchronize with each other, creating a soothing modulation effect particularly suitable for electric piano.

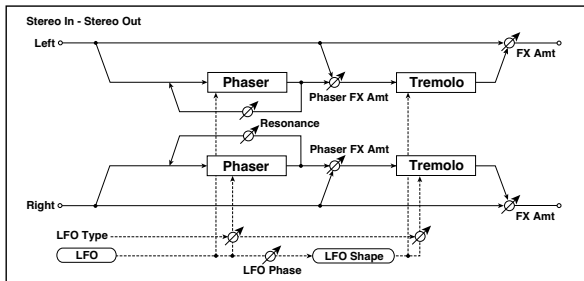

a	Type	Phs - Trml, ... Phs LR - Trml LR	Selects the type of the tremolo and phaser LFOs Phaser - Tremolo, Phaser - Tremolo Spin, Phaser - Tremolo LR, Phaser LR - Tremolo, Phaser LR - Tremolo Spin, Phaser LR - Tremolo LR	
	LFO Phase [degree]	-180...+180	Sets the phase difference between the tremolo and phaser LFOs	
b	LFO Frequency [Hz]	0.02...20.00	Sets the speed of the LFO	
	Src	Off...Tempo	Selects a modulation source for LFO speed	
c	Amt	-20.00...+20.00	Sets the LFO speed modulation amount	
	MIDI Sync	Off, On	When this is on, the LFO speed is set by BPM, Base Note, and Times, instead of Frequency	
	BPM	MIDI, 40.00...300.00	MIDI syncs to the system tempo; 40-300 sets the tempo manually for this individual effect	
d	Base Note		Selects the type of notes that specify the LFO speed	
	Times	x1...x32	Sets the number of notes that specify the LFO speed	
e	Phaser Manual	0...100	Sets the phaser frequency range	
	Resonance	-100...+100	Sets the phaser resonance amount	
f	Phaser Depth	0...100	Sets the phaser modulation depth	
	Src	Off...Tempo	Selects the modulation source for the phaser modulation depth	
	Amt	-100...+100	Sets the modulation amount for the phaser modulation depth	
g	Phaser Wet/Dry	-Wet, -2 : 98...Dry... 2 : 98, Wet	Sets the balance between the phaser effect and dry sounds	
	Tremolo Shape	-100...+100	Sets the degree of the tremolo LFO shaping	

h	Tremolo Depth	0...100	Sets the tremolo modulation depth	
	Src	Off...Tempo	Selects the modulation source for the tremolo modulation depth	
	Amt	-100...+100	Sets the modulation amount of the tremolo modulation depth	
i	FX Amount	0...100	Amount of FX added to the direct signal	
	Src	Off...Tempo	Table, "Dynamic Modulation sources," on page 26	
	Amt	-100...+100	Amount of modulation source	

a: Type

a: LFO Phase [degree]

Select the type of phaser LFO and tremolo LFO for the "Type" parameter. How the effect sound moves or rotates depends on the type of LFO. Selecting "LFO Phase" enables you to offset the timing of the phaser peak and control a subtle movement and rotation of the sound.

f: Phaser Wet/Dry

i: FX Amount

PHASER Wet/Dry sets the balance between the phaser output and the dry sound. OUTPUT FX Amount sets the balance between the final phaser and tremolo output level and the dry sound.

048: St. Ring Modulator (Stereo Ring Modulator)

This effect creates a metallic sound by applying the oscillators to the input signal. Use the LFO or Dynamic Modulation to modulate the oscillator to create a radical modulation. Matching the oscillator frequency with a note number will produce a ring modulation effect in specific key ranges.

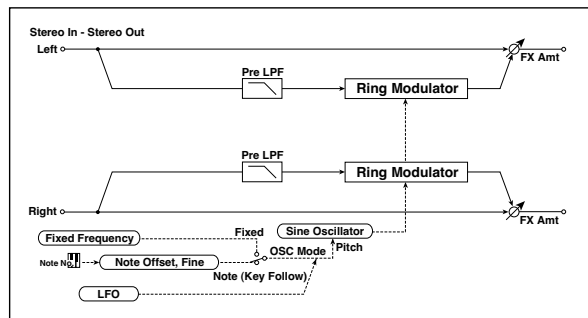

a	OSC Mode	Fixed, Note (Key Follow)	Switching between specifying the oscillator frequency and using a note number	
	Pre LPF	0...100	Sets the damping amount of the high range input to the ring modulator	
b	Fixed Frequency [Hz]	0...12.00k	Sets the oscillator frequency when OSC Mode is set to Fixed	
	Src	Off...Tempo	Selects the modulation source for the oscillator frequency when OSC Mode is set to Fixed	
c	Amt	-12.00k...+12.00k	Sets the modulation amount of the oscillator frequency when OSC Mode is set to Fixed	
	Note Offset	-48...+48	Sets the pitch difference from the original note when OSC Mode is set to Note (Key Follow)	
	Note Fine	-100...+100	Fine-adjusts the oscillator frequency	

d	LFO Frequency [Hz]	0.02...20.00	Sets the speed of the LFO	D ^{mod}
	Src	Off...Tempo	Selects a modulation source for LFO speed	
	Amt	-20.00...+20.00	Sets the modulation amount of LFO speed	
e	MIDI Sync	Off, On	When this is on, the LFO speed is set by BPM, Base Note, and Times, instead of Frequency	A ^{sync}
	BPM	MIDI, 40.00...300.00	MIDI syncs to the system tempo; 40-300 sets the tempo manually for this individual effect	
	Base Note		Selects the type of notes that specify the LFO speed	
	Times	x1...x32	Sets the number of notes that specify the LFO speed	
f	LFO Depth	0...100	Sets the depth of LFO modulation for the oscillator frequency	D ^{mod}
	Src	Off...Tempo	Selects the modulation source of the depth of modulation	
	Amt	-100...+100	Sets the modulation amount of the depth of modulation	
g	FX Amount	0...100	Amount of FX added to the direct signal	D ^{mod}
	Src	Off...Tempo	Table, "Dynamic Modulation sources," on page 26	
	Amt	-100...+100	Amount of modulation source	

a: OSC Mode

This parameter determines whether or not the oscillator frequency follows the note number.

a: Pre LPF

This parameter enables you to set the damping amount of the high range sound input to the ring modulator. If the input sound contains lots of harmonics, the effect may sound dirty. In this case, cut a certain amount of high range.

b: Fixed Frequency [Hz]

This parameter sets the oscillator frequency when "OSC Mode" is set to Fixed.

c: Note Offset

c: Note Fine

These parameters for the oscillator are used when "OSC Mode" is set to Note (Key Follow). The "Note Offset" sets the pitch difference from the original note in semitone steps. The "Note Fine" parameter fine-adjusts the pitch in cent steps. Matching the oscillator frequency with the note number produces a ring modulation effect in the correct key.

049: Detune

Using this effect, you can obtain a detune effect that offsets the pitch of the effect sound slightly from the pitch of the input signal. Compared to the chorus effect, a more natural sound thickness will be created.

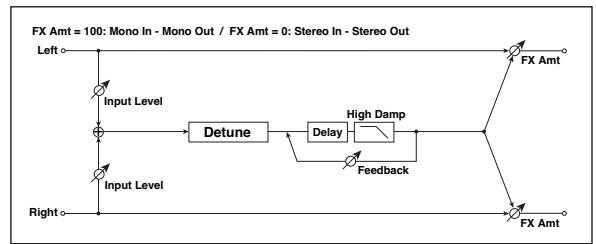

a	Pitch Shift [cents]	-100...+100	Sets the pitch difference from the input signal	D ^{mod}
	Src	Off...Tempo	Selects a modulation source for pitch shift	
	Amt	-100...+100	Sets the modulation amount for pitch shift	
b	Delay Time [msec]	0...1000	Sets the delay time	
c	Feedback	-100...+100	Sets the feedback amount	
	High Damp [%]	0...100	Sets the damping amount in the high range	
d	Input Level Dmod [%]	-100...+100	Sets the modulation amount of the input level	D ^{mod}
	Src	Off...Tempo	Selects the modulation source for the input level	
e	FX Amount	0...100	Amount of FX added to the direct signal	D ^{mod}
	Src	Off...Tempo	Table, "Dynamic Modulation sources," on page 26	
	Amt	-100...+100	Amount of modulation source	

d: Input Level Dmod [%]

d: Src

This parameter sets the dynamic modulation of the input level.

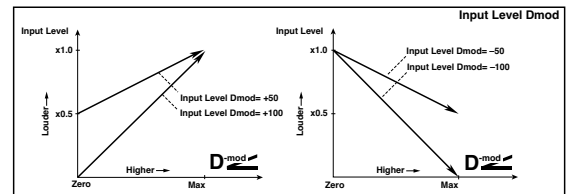

050: Pitch Shifter

This effect changes the pitch of the input signal. You can select from three types: Fast (quick response), Medium, and Slow (preserves tonal quality). You can also create an effect in which the pitch is gradually raised (or dropped) using the delay with feedback.

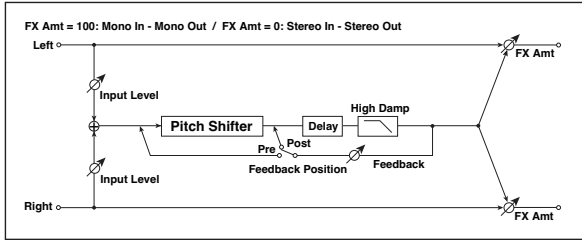

a	Mode	Slow, Medium, Fast	Switches Pitch Shifter mode	
b	Pitch Shift [1/2tone]	-24...+24	Sets the pitch shift amount by steps of a semitone	D ^{mod}
	Src	Off...Tempo	Selects the modulation source of pitch shift amount	
	Amt	-24...+24	Sets the modulation amount of pitch shift amount	
c	Fine [cents]	-100...+100	Sets the pitch shift amount by steps of a cent	D ^{mod}
	Amt	-100...+100	Sets the modulation amount of pitch shift amount	
d	Delay Time [msec]	0...2000	Sets the delay time	
e	Feedback Position	Pre, Post	Switches the feedback connection	
f	Feedback	-100...+100	Sets the feedback amount	
	High Damp [%]	0...100	Sets the damping amount in the high range	
g	Input Level Dmod [%]	-100...+100	Sets the modulation amount of the input level	D ^{mod}
	Src	Off...Tempo	Selects the modulation source for the input level	
h	FX Amount	0...100	Amount of FX added to the direct signal	D ^{mod}
	Src	Off...Tempo	Table, "Dynamic Modulation sources," on page 26	
	Amt	-100...+100	Amount of modulation source	

a: Mode

This parameter switches the pitch shifter operating mode. With Slow, tonal quality will not be changed too much. With Fast, the effect becomes a Pitch Shifter that has a quick response, but may change the tone. Medium is in-between these two. If you do not need to set too much pitch shift amount, set this parameter to Slow. If you wish to change the pitch significantly, use Fast.

b: Pitch Shift [1/2tone]

b: Src

b: Amt

c: Fine [cents]

c: Amt

The amount of pitch shift will use the value of the **Pitch Shift** plus the **Fine** value. The amount of modulation will use the b: Amt value plus the c: Amt.

The same Modulation Source is used for both **Pitch Shift** and **Fine**.

e: Feedback Position

f: Feedback

When **Feedback Position** is set to **Pre**, the pitch shifter output is again input to the pitch shifter. Therefore, if you specify a higher

value for the **Feedback** parameter, the pitch will be raised (or lowered) more and more each time feedback is repeated.

If **Feedback Position** is set to **Post**, the feedback signal will not pass through the pitch shifter again. Even if you specify a higher value for the **Feedback** parameter, the pitch-shifted sound will be repeated at the same pitch.

051: Pitch Shifter BPM

This pitch shifter enables you to set the delay time to match the song tempo.

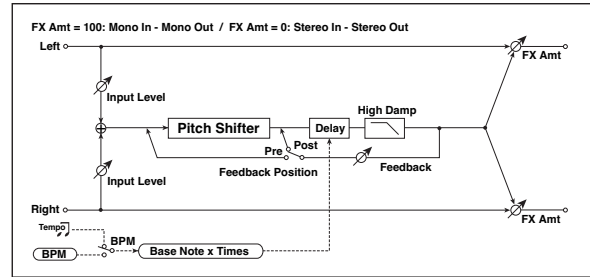

a	Mode	Slow, Medium, Fast	Switches Pitch Shifter mode	
b	Pitch Shift [1/2tone]	-24...+24	Sets the pitch shift amount in steps of a semitone	D ^{mod}
	Src	Off...Tempo	Selects the modulation source of pitch shift amount	
	Amt	-24...+24	Sets the modulation amount of pitch shift amount	
c	Fine [cents]	-100...+100	Sets the pitch shift amount in steps of one cent	D ^{mod}
	Amt	-100...+100	Sets the modulation amount of pitch shift amount	
d	BPM	MIDI, 40.00... 300.00	MIDI syncs to the system tempo; 40-300 sets the tempo manually for this individual effect	A ^{sync}
	Time Over?	---, OVER!	Displays an error message when the delay time exceeds the upper limit	
e	Delay Base Note		Selects the type of notes to specify the delay time	
	Times	x1...x32	Sets the number of notes to specify the delay time	
f	Feedback Position	Pre, Post	Switches the feedback connection	
g	Feedback	-100...+100	Sets the feedback amount	
	High Damp [%]	0...100	Sets the damping amount in the high range	
h	Input Level Dmod [%]	-100...+100	Sets the modulation amount of the input level	D ^{mod}
	Src	Off...Tempo	Selects the modulation source for the input level	
i	FX Amount	0...100	Amount of FX added to the direct signal	D ^{mod}
	Src	Off...Tempo	Table, "Dynamic Modulation sources," on page 26	
	Amt	-100...+100	Amount of modulation source	

d: BPM

e: Delay Base Note

e: Times

The delay time is the duration of "Times" number of "Delay Base Note" note values at the "BPM" tempo (or if "BPM" is set to MIDI, the tempo determined by MIDI Clock).

d: Time Over?

You can set the delay time up to 5,290msec. If the delay time exceeds this limit, the error message "OVER!" appears on the display. Set the delay time parameters so that this message will not appear. "Time Over?" is only a display parameter.

052: Pitch Shift Mod. (Pitch Shift Modulation)

This effect modulates the detuned pitch shift amount using an LFO, adding a clear spread and width to the sound by panning the effect sound and dry sound to the left and right. This is especially effective when the effect sound and dry sound output from stereo speakers are mixed.

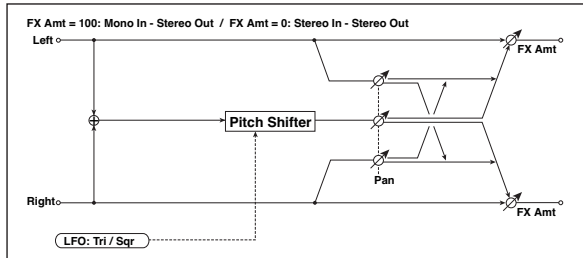

a	Pitch Shift [cents]	-100...+100	Sets the pitch difference from the input signal	
b	LFO Waveform	Triangle, Square	Selects the LFO Waveform	
c	LFO Frequency [Hz]	0.02...20.00	Sets the speed of the LFO	D ^{mod}
	Src	Off...Tempo	Selects a modulation source for LFO speed	
d	Amt	-20.00...+20.00	Sets the modulation amount of LFO speed	
	MIDI Sync	Off, On	When this is on, the LFO speed is set by BPM, Base Note, and Times, instead of Frequency	S ^{sync}
	BPM	MIDI, 40.00...300.00	MIDI syncs to the system tempo; 40-300 sets the tempo manually for this individual effect	
	Base Note	♩...	Selects the type of notes that specify the LFO speed	
e	Times	x1...x32	Sets the number of notes that specify the LFO speed	
	Depth	-100...+100	Sets the LFO modulation depth for pitch shift amount	D ^{mod}
	Src	Off...Tempo	Selects the modulation source of the depth of modulation	
f	Amt	-100...+100	Sets the modulation amount of the depth of modulation	
	Pan	L, 1 : 99...99 : 1, R	Sets the panning effect sound and dry sound separately	
g	FX Amount	0...100	Amount of FX added to the direct signal	D ^{mod}
	Src	Off...Tempo	Table, "Dynamic Modulation sources," on page 26	
	Amt	-100...+100	Amount of modulation source	

a: Pitch Shift [cents]

e: Depth

These parameters set the amount of pitch shift and amount of modulation by means of the LFO.

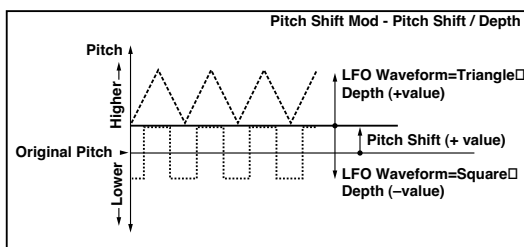

g: Pan

h: FX Amount

The Pan parameter pans the effect sound and dry sound to the left and right. With L, the effect sound is panned left, and the dry

sound is panned right. With a FX Amount = 100 setting, the effect and dry sound will be output in a proportion of 1:1.

053: Organ Vib/Chorus (Organ Vibrato/Chorus)

This effect simulates the chorus and vibrato circuitry of a vintage organ. The modulation speed and depth can be customized.

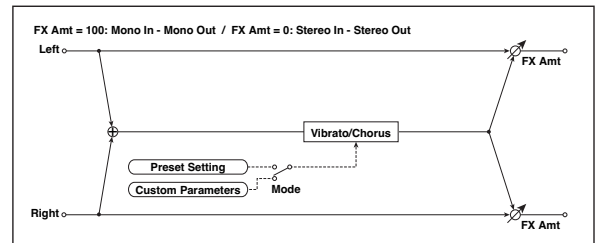

a	Input Trim	0...100	Sets the input level	
b	Control Mode	Preset, Custom	Selects either preset or custom settings	
c	Preset Type	V1, C1, V2, C2, V3, C3	Selects the effect type when Mode=Preset V1/V2/V3 are variations of vibrato, and C1/C2/C3 are variations of chorus	D ^{mod}
	Src	Off...Tempo	Selects the modulation source that will change the effect type	
	Amt	-5...+5	Sets the modulation amount for changing the effect type	
d	Custom Mix	Vibrato, 1:99...99:1, Chorus	Sets the mix level of the direct sound when Mode=Preset	D ^{mod}
	Src	Off...Tempo	Selects the modulation source that will control the mix level of the direct sound	
	Amt	-100...+100	Sets the modulation amount for controlling the mix level of the direct sound	
e	Custom Depth	0...100	Sets the vibrato depth	D ^{mod}
	Src	Off...Tempo	Selects the modulation source that will control vibrato depth	
	Amt	-100...+100	Sets the modulation amount for controlling the vibrato depth	
f	Custom Speed [Hz]	0.02...20.00	Sets the vibrato speed	D ^{mod}
	Src	Off...Tempo	Selects the modulation source for controlling the vibrato speed	
	Amt	-20.00...+20.00	Sets the modulation amount for controlling the vibrato speed	
g	FX Amount	0...100	Amount of FX added to the direct signal	D ^{mod}
	Src	Off...Tempo	Table, "Dynamic Modulation sources," on page 26	
	Amt	-100...+100	Amount of modulation source	

b: Control Mode

c: Preset Type

d: Custom Mix

e: Custom Depth

f: Custom Speed [Hz]

If Control Mode=Preset, you can use c: Preset Type to select the effect. In this case, the Custom Mix/Depth/Speed settings are ignored. If Control Mode=Custom, the Custom Mix/Depth/Speed settings are valid, and the c: Preset Type setting is ignored.

c: Amt

If Preset Type=V1 and Src=JS+Y, you can set this to +5 and move JS +Y to control the effect in the order of V1→C1→V2→C2→V3→C3.

054: Rotary Speaker

This effect simulates a rotary speaker, and obtains a more realistic sound by simulating the rotor in the low range and the horn in the high range separately. The effect also simulates the stereo microphone settings.

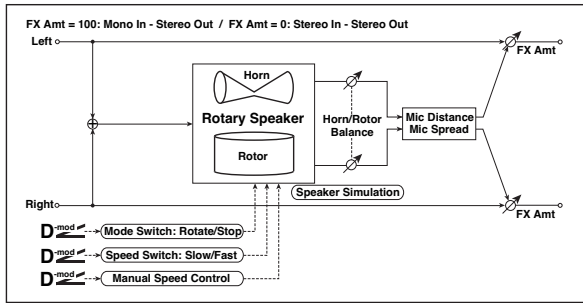

a	Mode Switch	Rotate, Stop	Switches between speaker rotation and stop	
	Src	Off...Tempo	Selects a modulation source for Rotate/Stop	
	Mode	Toggle, Moment	Sets the switch mode for Rotate/Stop modulation	
b	Speed Switch	Slow, Fast	Switches the speaker rotation speed between slow and fast	
	Src	Off...Tempo	Selects a modulation source for Slow/Fast	
	Mode	Toggle, Moment	Sets the switch mode for Slow/Fast modulation	
c	Manual Speed Ctrl	Off...Tempo	Sets a modulation source for direct control of rotation speed	
d	Horn Acceleration	0...100	How quickly the horn rotation speed in the high range is switched	
	Horn Ratio	Stop, 0.50...2.00	Adjusts the (high-range side) horn rotation speed. Standard value is 1.00. Selecting "Stop" will stop the rotation	
e	Rotor Acceleration	0...100	Determines how quickly the rotor rotation speed in the low range is switched	
	Rotor Ratio	Stop, 0.50...2.00	Adjusts the (low-frequency) rotor speed. Standard value is 1.00. Selecting "Stop" will stop the rotation	
f	Horn/Rotor Balance	Rotor, 1...99, Horn	Sets the level balance between the high-frequency horn and low-frequency rotor	
g	Mic Distance	0...100	Sets the distance between the microphone and rotary speaker	
	Mic Spread	0...100	Sets the angle of left and right microphones	
h	FX Amount	0...100	Amount of FX added to the direct signal	
	Src	Off...Tempo	Table, "Dynamic Modulation sources," on page 26	
	Amt	-100...+100	Amount of modulation source	

a: Mode

This parameter sets how the modulation source switches between rotation and stop.

When **Mode = Toggle**, the speaker rotates or stops alternately each time you press the pedal or move the joystick. Via MIDI, rotation will switch between start and stop each time the modulation amount exceeds 64.

When **Mode = Moment**, the speaker rotates by default, and stops only when you press the pedal or move the joystick. Via MIDI, modulation values above 64 make the speaker rotate, and values below 64 make it stop.

b: Speed Switch

This parameter controls how the rotation speed (slow and fast) is switched via the modulation source.

When **Mode = Toggle**, the speed will switch between slow and fast each time you press the pedal or move the joystick. Via MIDI, the speed will switch each time the modulation amount exceeds 64.

When **Mode = Moment**, the speed is usually slow. It becomes fast only when you press the pedal or move the joystick. Via MIDI, modulation values above 64 set the speed to **Fast**, and values below 64 set it to **Slow**.

c: Manual Speed Ctrl

If you wish to control the rotation speed manually, instead of switching between Slow and Fast, select a modulation source in the **Manual Speed Ctrl** parameter. If you don't want to use manual control, set this to **Off**.

d: Horn Acceleration

e: Rotor Acceleration

On a real rotary speaker, the rotation speed accelerates or decelerates gradually after you switch the speed. The **Horn Acceleration** parameters set the transition times between fast and slow speeds.

g: Mic Distance

g: Mic Spread

This is a simulation of stereo microphone settings.

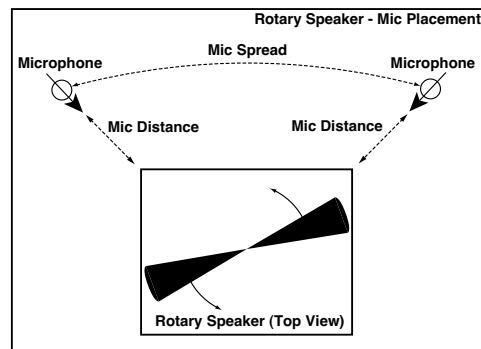

Delay

055: L/C/R Delay

This multitap delay outputs three Tap signals to the left, right, and center respectively. You can also adjust the left and right spread of the delay sound.

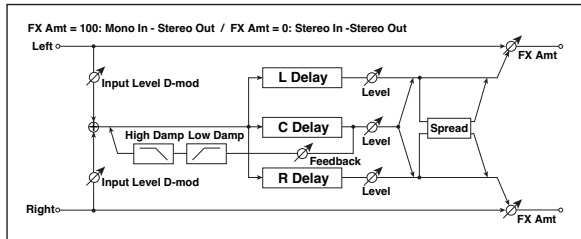

a	L Delay Time [msec]	0...2730	Sets the delay time of TapL	
	Level	0...50	Sets the output level of TapL	
b	C Delay Time [msec]	0...2730	Sets the delay time of TapC	
	Level	0...50	Sets the output level of TapC	
c	R Delay Time [msec]	0...2730	Sets the delay time of TapR	
	Level	0...50	Sets the output level of TapR	
d	Feedback (C Delay)	-100...+100	Sets the feedback amount of TapC	
	Src	Off...Tempo	Selects the modulation source of the TapC feedback amount	
	Amt	-100...+100	Sets the modulation amount of the TapC feedback amount	
e	High Damp [%]	0...100	Sets the damping amount in the high range	
	Low Damp [%]	0...100	Sets the damping amount in the low range	
f	Input Level Dmod [%]	-100...+100	Sets the modulation amount of the input level	
	Src	Off...Tempo	Selects the modulation source for the input level	
g	Spread	0...50	Sets the width of the stereo image of the effect sound	
h	FX Amount	0...100	Amount of FX added to the direct signal	
	Src	Off...Tempo	Table , "Dynamic Modulation sources," on page 26	
	Amt	-100...+100	Amount of modulation source	

e: High Damp [%]
e: Low Damp [%]

These parameters set the damping amount of high range and low range. The tone of the delayed sound becomes darker and lighter as it feeds back.

g: Spread

This parameter sets the pan width of the effect sound. The stereo image is widest with a value of 50, and the effect sound of both channels is output from the center with a value of 0.

056: Stereo/CrossDelay

This is a stereo delay, and can be used as a cross-feedback delay effect in which the delay sounds cross over between the left and right by changing the feedback routing.

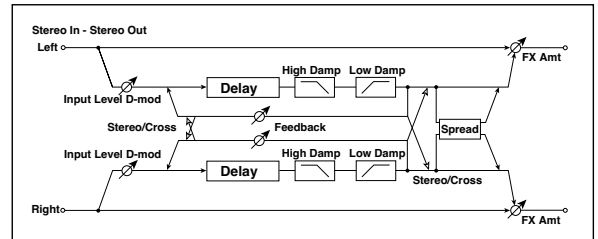

a	Stereo/Cross	Stereo, Cross	Switches between stereo delay and cross-feedback delay	
b	L Delay Time [msec]	0.0...1360.0	Sets the delay time for the left channel	
c	R Delay Time [msec]	0.0...1360.0	Sets the delay time for the right channel	
d	L Feedback	-100...+100	Sets the feedback amount for the left channel	
	Amt L	-100...+100	Sets the modulation amount of the left channel feedback	
e	R Feedback	-100...+100	Sets the feedback amount for the right channel	
	Amt R	-100...+100	Sets the modulation amount of the right channel feedback	
f	High Damp [%]	0...100	Sets the damping amount in the high range	
g	Low Damp [%]	0...100	Sets the damping amount in the low range	
h	Input Level Dmod [%]	-100...+100	Sets the modulation amount of the input level	
	Src	Off...Tempo	Selects the modulation source for the input level	
i	Spread	-50...+50	Sets the width of the stereo image of the effect sound	
j	FX Amount	0...100	Amount of FX added to the direct signal	
	Src	Off...Tempo	Table , "Dynamic Modulation sources," on page 26	
	Amt	-100...+100	Amount of modulation source	

057: St. Multitap Delay (Stereo Multitap Delay)

The left and right Multitap Delays have two taps respectively. Changing the routing of feedback and tap output allows you to create various patterns of complex effect sounds.

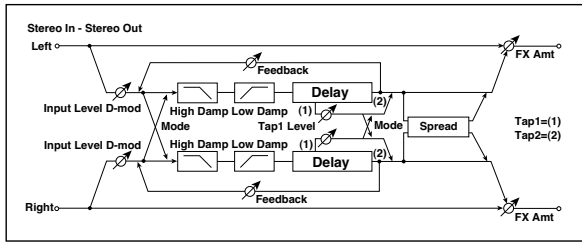

a	Mode	Normal, Cross Feedback, Cross Pan1, Cross Pan2	Switches the left and right delay routing	
b	Tap1 Time [msec]	0.0...1360.0	Sets the Tap1 delay time	
c	Tap2 Time [msec]	0.0...1360.0	Sets the Tap2 delay time	
d	Tap1 Level	0...100	Sets the Tap1 output level	
e	Feedback (Tap2)	-100...+100	Sets the Tap2 feedback amount	D-mod
	Src	Off...Tempo	Selects the modulation source of the Tap2 feedback amount	
e	Amt	-100...+100	Sets the modulation amount of the Tap2 feedback amount	
	High Damp [%]	0...100	Sets the damping amount in the high range	
g	Low Damp [%]	0...100	Sets the damping amount in the low range	
h	Input Level Dmod [%]	-100...+100	Sets the modulation amount of the input level	D-mod
	Src	Off...Tempo	Selects the modulation source for the input level	
i	Spread	-100...+100	Sets the width of the stereo image of the effect sound	D-mod
	Src	Off...Tempo	Selects the modulation source of the effect sound's stereo image width	
	Amt	-100...+100	Sets the modulation amount of the effect sound's stereo image width	
j	FX Amount	0...100	Amount of FX added to the direct signal	D-mod
	Src	Off...Tempo	Table, "Dynamic Modulation sources," on page 26	
	Amt	-100...+100	Amount of modulation source	

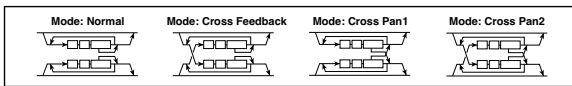

a: Mode

You can change how the left and right delay signals are panned by modifying the routing of the left and right delay as shown in the figure above. You need to input different sounds to each channel in order for this parameter to be effective.

d: Tap1 Level

This parameter sets the output level of Tap1. Setting a different level from Tap2 will add a unique touch to a monotonous delay and feedback.

058: St. Mod Delay (Stereo Modulation Delay)

This stereo delay uses an LFO to sweep the delay time. The pitch also varies, creating a delay sound which swells and shimmers. You can also control the delay time using a modulation source.

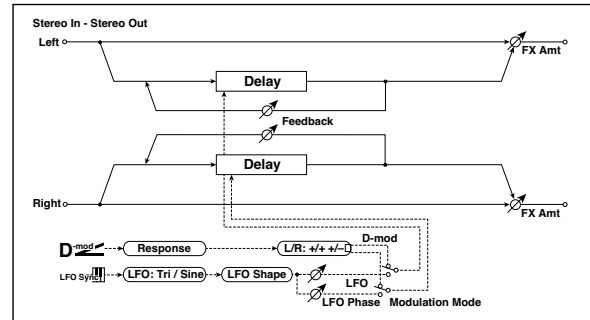

a	Modulation Mode	LFO, D-mod	Switches between LFO modulation control and modulation source control	
b	D-mod Modulation	L/R: +/+ , L/R: +/-	Reversed L/R control by modulation source	
	Src	Off...Tempo	Selects the modulation source that controls delay time	D-mod
b	Response	0...30	Sets the rate of response to the modulation source	
	LFO Waveform	Triangle, Sine	Selects the LFO Waveform	
c	LFO Shape	-100...+100	Changes the curvature of the LFO Waveform	
d	LFO Sync	Off, On	Switches LFO reset off/on	
	Src	Off...Tempo	Selects the modulation source that resets the LFO	D-mod
e	LFO Frequency [Hz]	0.02...20.00	Sets the speed of the LFO	
f	MIDI Sync	Off, On	When this is on, the LFO speed is set by BPM, Base Note, and Times, instead of Frequency	Ableton
	BPM	MIDI, 40.00...300.00	MIDI syncs to the system tempo; 40-300 sets the tempo manually for this individual effect	
	Base Note	♪...o	Selects the type of notes that specify the LFO speed	
	Times	x1...x32	Sets the number of notes that specify the LFO speed	
g	L LFO Phase [deg]	-180...+180	Sets the phase obtained when the left LFO is reset	
	L Depth	0...200	Sets the depth of the left LFO modulation	
h	R LFO Phase [deg]	-180...+180	Sets the phase obtained when the right LFO is reset	
	R Depth	0...200	Sets the depth of the right LFO modulation	
i	L Delay Time [msec]	0.0...1000.0	Sets the delay time for the left channel	
	L Feedback	-100...+100	Sets the feedback amount of left delay	
j	R Delay Time [msec]	0.0...1000.0	Sets the delay time for the right channel	
	R Feedback	-100...+100	Sets the feedback amount of right delay	
k	FX Amount	-100...0...100	Amount of FX added to the direct signal	D-mod
	Src	Off...Tempo	Table, "Dynamic Modulation sources," on page 26	
	Amt	-100...+100	Amount of modulation source	

b: D-mod Modulation

When the modulation source is used for control, this parameter reverses the left and right modulation direction.

- d: LFO Sync
- d: Src
- g: L LFO Phase [deg]
- h: R LFO Phase [deg]

If “LFO Sync” is On, the LFO will be reset by the modulation source that is received.

The “Src” parameter sets the modulation source that resets the LFO. For example, you can assign Gate as a modulation source so that the sweep always starts from the specified point.

“L LFO Phase” and “R LFO Phase” set the phase obtained when the left and right LFOs are reset. In this way, you can create changes in pitch sweep for the left and right channels individually.

MDI The effect is off when a value of the modulation source specified in the “Src” parameter is 63 or smaller, and the effect is on when the value is 64 or higher. The LFO is triggered and reset to the “L LFO Phase” and “R LFO Phase” settings when the value changes from 63 or smaller to 64 or higher.

059: St. Dynamic Delay (Stereo Dynamic Delay)

This stereo delay controls the level of delay according to the input signal level. You can use this as a ducking delay that applies delay to the sound only when you play keys at a high velocity or only when the volume level is low.

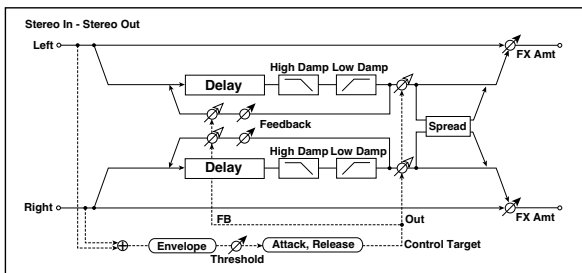

a	Control Target	None, Out, FB	Selects from no control, output, and feedback	
	Polarity	+, -	Reverses level control	
b	Threshold	0...100	Sets the level to which the effect is applied	
	Offset	0...100	Sets the offset of level control	
c	Attack	1...100	Sets the attack time of level control	
d	Release	1...100	Sets the release time of level control	
e	L Delay Time [msec]	0.0...1360.0	Sets the delay time for the left channel	
f	R Delay Time [msec]	0.0...1360.0	Sets the delay time for the right channel	
g	Feedback	-100...+100	Sets the feedback amount	
h	High Damp [%]	0...100	Sets the damping amount in the high range	
	Low Damp [%]	0...100	Sets the damping amount in the low range	
i	Spread	-100...+100	Sets the width of the stereo image of the effect sound	
j	FX Amount	0...100	Amount of FX added to the direct signal	
	Src	Off...Tempo	Table, “Dynamic Modulation sources,” on page 26	
	Amt	-100...+100	Amount of modulation source	

a: Control Target

This parameter selects no level control, delay output control (effect balance), or feedback amount control.

a: Polarity

b: Threshold

b: Offset

c: Attack

d: Release

The “Offset” parameter specifies the value for the “Control Target” parameter (that is set to None), expressed as the ratio relative to the parameter value (the “FX Amount” value with “Control Target”=Output level, or the “Feedback” value with “Control Target”=Feedback).

When “Polarity” is positive, the “Control Target” value is obtained by multiplying the parameter value by the “Offset” value (if the input level is below the threshold), or equals the parameter value if the input level exceeds the threshold.

When “Polarity” is negative, Control Target value equals the parameter value if the input level is below the threshold, or is obtained by multiplying the parameter value by the “Offset” value if the level exceeds the threshold.

The “Attack” and “Release” parameters specify attack time and release time of delay level control.

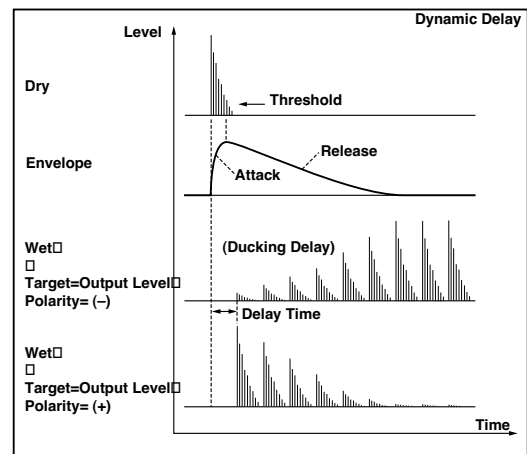

060: St. AutoPanningDly (Stereo Auto Panning Delay)

This stereo delay effect pans the delay sound left and right using the LFO.

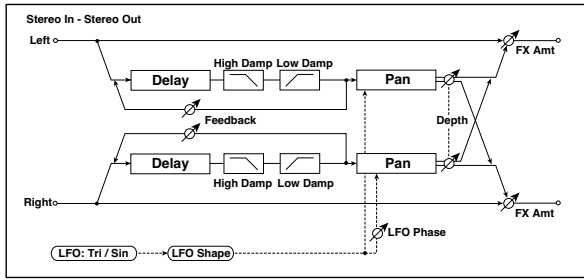

a	L Delay Time [msec]	0.0...1360.0	Sets the delay time for the left channel	
	L Feedback	-100...+100	Sets the feedback amount for the left channel	
b	R Delay Time [msec]	0.0...1360.0	Sets the delay time for the right channel	
	R Feedback	-100...+100	Sets the feedback amount for the right channel	
c	High Damp [%]	0...100	Sets the damping amount in the high range	
	Low Damp [%]	0...100	Sets the damping amount in the low range	
d	LFO Waveform	Triangle, Sine	Selects the LFO Waveform	
	LFO Shape	-100...+100	Changes the curvature of the LFO Waveform	
e	Phase [degree]	-180...+180	Sets the LFO phase difference between the left and right	
f	Panning Freq [Hz]	0.02...20.00	Sets the panning speed	
g	MIDI Sync	Off, On	Switches between using the frequency of the panning speed and using the tempo and notes	
	BPM	MIDI, 40.00...300.00	MIDI syncs to the system tempo; 40-300 sets the tempo manually for this individual effect	
	Base Note		Selects the type of notes to specify the delay time for the panning speed	
	Times	x1...x32	Sets the number of notes to specify the delay time for the panning speed	
h	Panning Depth	0...100	Sets the panning width	
	Src	Off...Tempo	Selects the modulation source for the panning width	
	Amt	-100...+100	Set the modulation amount of the panning width	
i	FX Amount	0...100	Amount of FX added to the direct signal	
	Src	Off...Tempo	Table , "Dynamic Modulation sources," on page 26	
	Amt	-100...+100	Amount of modulation source	

061: Tape Echo

This effect simulates a tape echo unit with three playback heads. The distortion and tonal change typical of magnetic tape are also reproduced.

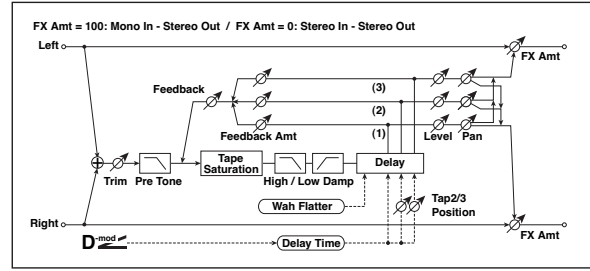

a	Delay (Tap1) [msec]	0...2700	Sets the delay time (tap1)	
	Src	Off...Tempo	Selects the modulation source of the delay time	
b	Amt	-2700...+2700	Sets the modulation amount of delay time	
	Tap2 Position [%]	0...100	Sets the position of Tap 2 relative to the Tap 1 delay time the depth of pitch variation	
c	Tap3 Position [%]	0...100	Sets the position of Tap 3 relative to the Tap 1 delay time the depth of pitch variation	
	Tap1 Level	0...100	Sets the Tap1 output level	
d	Pan	L, 1...99, R	Sets the stereo image of tap1	
	FB Amt	-100...+100	Sets the Tap1 feedback amount	
e	Tap2 Level	0...100	Sets the Tap2 output level	
	Pan	L, 1...99, R	Sets the stereo image of tap2	
f	FB Amt	-100...+100	Sets the Tap2 feedback amount	
	Tap3 Level	0...100	Sets the Tap3 output level	
g	Pan	L, 1...99, R	Sets the stereo image of tap3	
	FB Amt	-100...+100	Sets the Tap3 feedback amount	
h	Feedback	0...100	Sets the amount of feedback for Taps 1, 2, and 3	
	Src	Off...Tempo	Selects the modulation source of feedback amount	
i	Amt	-100...+100	Sets the feedback amount	
	High Damp [%]	0...100	Sets the damping amount in the high range	
j	Low Damp [%]	0...100	Sets the damping amount in the low range	
	Saturation	0...100	Sets the distortion amount	
k	Input Trim	0...100	Sets the input gain	
	Pre Tone	0...100	Sets the tone of the input	
l	Wow Flutter [Hz]	0.02...1.00	Sets the frequency at which pitch variation will occur	
	Wow Flutter depth	0...100	Sets the depth of pitch variation	
m	FX Amount	0...100	Amount of FX added to the direct signal	
	Src	Off...Tempo	Table , "Dynamic Modulation sources," on page 26	
	Amt	-100...+100	Amount of modulation source	

a: Delay (Tap1) [msec]

a: Src

a: Amt

b: Tap2 Position [%]

b: Tap3 Position [%]

The delay time for Tap 2 and 3 is specified as a proportion (%) relative to "Delay (Tap1)." Even if you use dynamic modulation to control "Delay (Tap1)," Tap 2 and 3 will change at the same proportion.

- d: FB Amt
- e: FB Amt
- f: FB Amt
- g: Feedback

The feedback output from Tap 1, 2, and 3 is mixed according to the “FB Amt,” and then the final amount of feedback is specified by “Feedback.”

062: Auto Reverse

This effect records the input signal and automatically plays it in reverse (the effect is similar to a tape reverse sound).

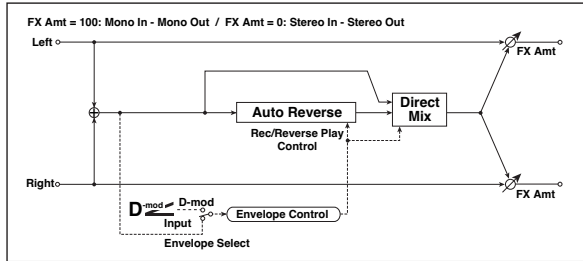

a	Rec Mode	Single, Multi	Sets the recording mode	
b	Reverse Time [msec]	20...2640	Sets the maximum duration of the reverse playback	
c	Envelope Select	D-mod, Input	Selects whether the start and end of recording is controlled via the modulation source or the input signal level	
	Src	Off...Tempo	Selects the modulation source that controls recording when Envelope Select is set to D-mod	D-mod
d	Threshold	0...100	Sets the recording start level when Envelope Select is set to Input	
e	Response	0...100	Sets the speed of the response to the end of recording	
f	Direct Mix	Always On, Always Off, Cross Fade	Selects how a dry sound is mixed	
g	FX Amount	0...100	Amount of FX added to the direct signal	D-mod
	Src	Off...Tempo	Table, “Dynamic Modulation sources,” on page 26	
	Amt	-100...+100	Amount of modulation source	

- a: Rec Mode
- b: Reverse Time [msec]

When “Rec Mode” is set to Single, you can set up to 2,640msec for “Reverse Time.” If recording starts during the reverse playback, the playback will be interrupted.

When “Rec Mode” is set to Multi, you can make another recording during the reverse playback. However, the maximum Reverse Time is limited to 1,320msec.

If you wish to record a phrase or rhythm pattern, set “Rec Mode” to Single. If you record only one note, set “Rec Mode” to Multi.

The “Reverse Time” parameter specifies the maximum duration of the reverse playback. The part in excess of this limit will not be played in reverse. If you wish to add short pieces of the reverse playback of single notes, make the “Reverse Time” shorter.

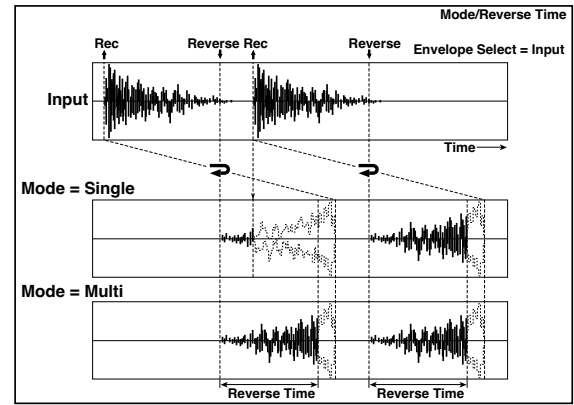

- c: Envelope Select
- c: Src
- d: Threshold

These parameters select the source to control the start and end of recording.

When “Envelope Select” is set to D-mod, the input signal will be recorded only when the value of the modulation source selected by the Src parameter is 64 or higher.

When “Envelope Select” is set to Input, the input signal will be recorded only when its level exceeds the Threshold level.

When recording is completed, reverse playback starts immediately.

063: Sequence BPM Dly (Sequence BPM Delay)

This four-tap delay enables you to select a tempo and rhythm pattern to set up each tap.

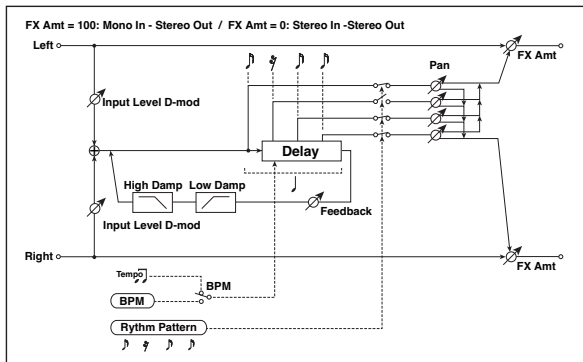

a	BPM	MIDI, 40.00... 300.00	MIDI syncs to the system tempo; 40–300 sets the tempo manually for this individual effect	
b	Rhythm Pattern		Selects a rhythm pattern	
c	Tap1 Pan	L, 1...99, R	Sets the panning of Tap1	
	Tap2 Pan	L, 1...99, R	Sets the panning of Tap2	
	Tap3 Pan	L, 1...99, R	Sets the panning of Tap3	
	Tap4 Pan	L, 1...99, R	Sets the panning of Tap4	
d	Feedback	-100...+100	Sets the feedback amount	
	Src	Off...Tempo	Selects the modulation source of feedback amount	
e	High Damp [%]	0...100	Sets the damping amount in the high range	
	Low Damp [%]	0...100	Sets the damping amount in the low range	
f	Input Level Dmod [%]	-100...+100	Sets the modulation amount of the input level	
	Src	Off...Tempo	Selects the modulation source for the input level	
g	FX Amount	0...100	Amount of FX added to the direct signal	
	Src	Off...Tempo	Table , "Dynamic Modulation sources," on page 26	
	Amt	-100...+100	Amount of modulation source	

a: BPM

b: Rhythm Pattern

With the tempo specified by the “BPM” parameter (or the MIDI Clock tempo if “BPM” is set to MIDI), the length of one beat equals the feedback delay time, and the interval between taps becomes equal. Selecting a rhythm pattern will automatically turn the tap outputs on and off. When “BPM” is set to MIDI, the lower limit of the “BPM” is 44.

064: L/C/R BPM Delay

The L/C/R delay enables you to match the delay time with the song tempo. You can also synchronize the delay time with the arpeggiator or sequencer. If you program the tempo before performance, you can achieve a delay effect that synchronizes with the song in real-time. Delay time is set by notes.

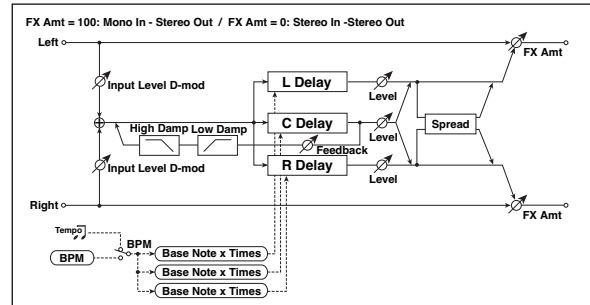

a	BPM	MIDI, 40.00... 300.00	MIDI syncs to the system tempo; 40–300 sets the tempo manually for this individual effect	
	Time Over?	---, OVER!	Displays an error message when the delay time exceeds the upper limit	
b	L Delay Base Note		Selects the type of notes to specify the delay time for TapL	
	Times	x1...x32	Sets the number of notes to specify the delay time for TapL	
	Level	0...50	Sets the output level of TapL	
c	C Delay Base Note		Selects the type of notes to specify the delay time for TapC	
	Times	x1...x32	Sets the number of notes to specify the delay time for TapC	
	Level	0...50	Sets the output level of TapC	
d	R Delay Base Note		Selects the type of notes to specify the delay time for TapR	
	Times	x1...x32	Sets the number of notes to specify the delay time for TapR	
	Level	0...50	Sets the output level of TapR	
e	Feedback (C Delay)	-100...+100	Sets the feedback amount of TapC	
	Src	Off...Tempo	Selects the modulation source for the TapC feedback	
f	High Damp [%]	0...100	Sets the damping amount in the high range	
	Low Damp [%]	0...100	Sets the damping amount in the low range	
g	Input Level Dmod [%]	-100...+100	Sets the modulation amount of the input level	
	Src	Off...Tempo	Selects the modulation source for the input level	
h	Spread	0...50	Sets the width of the stereo image of the effect sound	
i	FX Amount	0...100	Amount of FX added to the direct signal	
	Src	Off...Tempo	Table , "Dynamic Modulation sources," on page 26	
	Amt	-100...+100	Amount of modulation source	

a: Time Over?

You can set the delay time up to 5,460msec. If the delay time exceeds this limit, the error message “OVER!” appears in the display. Set the delay time parameters so that this message will not appear. “Time Over?” is only a display parameter.

065: Stereo BPM Delay

This stereo delay enables you to set the delay time to match the song tempo.

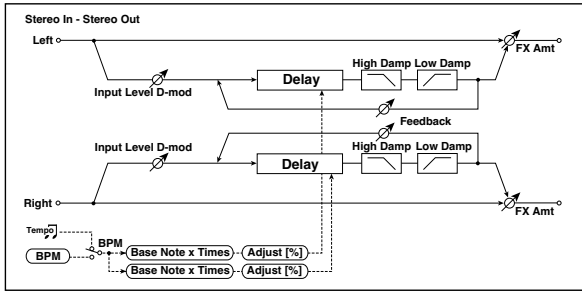

	BPM	MIDI, 40.00... 300.00	MIDI syncs to the system tempo; 40–300 sets the tempo manually for this individual effect	
a	Time Over? L	---, OVER!	Display the error message if the left channel delay time exceeds the upper limit	
	R	---, OVER!	Display the error message if the right channel delay time exceeds the upper limit	
b	L Delay Base Note		Selects the type of notes to specify the left channel delay time	
	Times	x1...x32	Sets the number of notes to specify the left channel delay time	
	Adjust [%]	-2.50...+2.50	Fine-adjust the left channel delay time	
c	R Delay Base Note		Selects the type of notes to specify the right channel delay time	
	Times	x1...x32	Sets the number of notes to specify the right channel delay time	
	Adjust [%]	-2.50...+2.50	Fine-adjust the right channel delay time	
d	L Feedback	-100...+100	Sets the feedback amount for the left channel	
	Src	Off...Tempo	Selects the modulation source of feedback amount	
	Amt L	-100...+100	Sets the modulation amount of the left channel feedback	
e	R Feedback	-100...+100	Sets the feedback amount for the right channel	
	Amt R	-100...+100	Sets the modulation amount of the right channel feedback	
f	High Damp [%]	0...100	Sets the damping amount in the high range	
g	Low Damp [%]	0...100	Sets the damping amount in the low range	
h	Input Level Dmod [%]	-100...+100	Sets the modulation amount of the input level	
	Src	Off...Tempo	Selects the modulation source for the input level	
i	FX Amount	0...100	Amount of FX added to the direct signal	
	Src	Off...Tempo	Table, "Dynamic Modulation sources," on page 26	
	Amt	-100...+100	Amount of modulation source	

a: Time Over? L, R

You can set the delay time up to 2,730msec. If the delay time exceeds this limit, the error message "OVER!" appears in the display. Set the delay time parameters so that this message will not appear. "Time Over?" is only a display parameter.

066: St.BPM Mtap Delay (Stereo BPM Multi tap Delay)

This four-tap delay enables you to select a tempo and rhythm pattern to set up each tap.

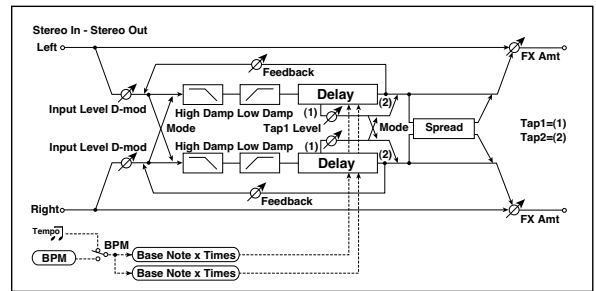

a	Mode	Normal, Cross Feedback, Cross Pan1, Cross Pan2	Switches the left and right delay routing	
b	BPM	MIDI, 40.00... 300.00	MIDI syncs to the system tempo; 40–300 sets the tempo manually for this individual effect	
	Time Over? 1	---, OVER!	Displays an error message when the delay time for Tap1 exceeds the upper limit	
c	Time Over? 2	---, OVER!	Displays an error message when the delay time for Tap2 exceeds the upper limit	
	Tap 1 Base Note		Selects the type of notes to specify the delay time for Tap1	
d	Times	x1...x32	Sets the number of notes to specify the delay time for Tap1	
	Tap 2 Base Note		Selects the type of notes to specify the delay time for Tap2	
e	Times	x1...x32	Sets the number of notes to specify the delay time for Tap2	
	Tap1 Level	0...100	Sets the Tap1 output level	
f	Feedback (Tap2)	-100...+100	Sets the Tap2 feedback amount	
	Src	Off...Tempo	Selects the modulation source of the Tap2 feedback amount	
	Amt	-100...+100	Sets the modulation amount of the Tap2 feedback amount	
g	High Damp [%]	0...100	Sets the damping amount in the high range	
	Low Damp [%]	0...100	Sets the damping amount in the low range	
h	Input Level Dmod [%]	-100...+100	Sets the modulation amount of the input level	
	Src	Off...Tempo	Selects the modulation source for the input level	
i	Spread	-100...+100	Sets the width of the stereo image of the effect sound	
	Src	Off...Tempo	Selects the modulation source of the effect sound's stereo image width	
	Amt	-100...+100	Sets the modulation amount of the effect sound's stereo image width	
j	FX Amount	0...100	Amount of FX added to the direct signal	
	Src	Off...Tempo	Table, "Dynamic Modulation sources," on page 26	
	Amt	-100...+100	Amount of modulation source	

067: St.BPM Mod. Delay (Stereo BPM Modulation Delay)

This is a stereo modulation delay that lets you synchronize the delay time to the tempo of the song.

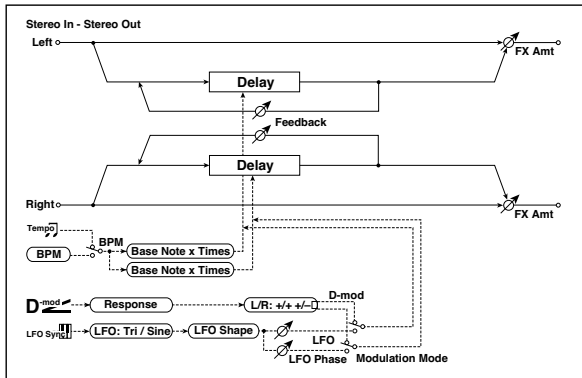

k	R Delay Base Note		Selects the type of notes to specify the right channel delay time	
	Times	x1...x32	Sets the number of notes to specify the right channel delay time	
	Feedback	-100...+100	Sets the feedback amount of right delay	
l	FX Amount	-100...0...100	Amount of FX added to the direct signal	
	Src	Off...Tempo	Table, "Dynamic Modulation sources," on page 26	
	Amt	-100...+100	Amount of modulation source	

i: Time Over? L, R

You can set the delay time up to 2,550msec. If the delay time exceeds this limit, the error message "OVER!" appears in the display. Set the delay time parameters so that this message will not appear. "Time Over?" is only a display parameter.

a	Modulation Mode	LFO, D-mod	Switches between LFO modulation control and modulation source control	
b	D-mod Modulation	L/R: +/+, L/R: +/-	Reversed L/R control by modulation source	
	Src	Off...Tempo	Selects the modulation source that controls delay time	
c	Response	0...30	Sets the rate of response to the modulation source	
	LFO Waveform	Triangle, Sine	Selects the LFO Waveform	
d	LFO Shape	-100...+100	Changes the curvature of the LFO Waveform	
	LFO Sync	Off, On	Switches LFO reset off/on	
e	Src	Off...Tempo	Selects the modulation source that resets the LFO	
	LFO Frequency [Hz]	0.02...20.00	Sets the speed of the LFO	
f	MIDI Sync	Off, On	When this is on, the LFO speed is set by BPM, Base Note, and Times, instead of Frequency	
	BPM	MIDI, 40.00...300.00	MIDI syncs to the system tempo; 40-300 sets the tempo manually for this individual effect	
	Base Note		Selects the type of notes that specify the LFO speed	
	Times	x1...x32	Sets the number of notes that specify the LFO speed	
g	L LFO Phase [deg]	-180...+180	Sets the phase obtained when the left LFO is reset	
	Depth	0...200	Sets the depth of the left LFO modulation	
h	R LFO Phase [deg]	-180...+180	Sets the phase obtained when the right LFO is reset	
	Depth	0...200	Sets the depth of the right LFO modulation	
i	BPM(Delay)	MIDI, 40.00...300.00	MIDI syncs to the system tempo; 40-300 sets the tempo manually for this individual effect	
	Time Over? L	---, OVER!	Display the error message if the left channel delay time exceeds the upper limit	
	R	---, OVER!	Display the error message if the right channel delay time exceeds the upper limit	
j	L Delay Base Note		Selects the type of notes to specify the left channel delay time	
	Times	x1...x32	Sets the number of notes to specify the left channel delay time	
	Feedback	-100...+100	Sets the feedback amount of left delay	

068: St.BPMAutoPanDly (Stereo BPM Auto Panning Delay)

This stereo auto panning delay enables you to set the delay time to match the song tempo.

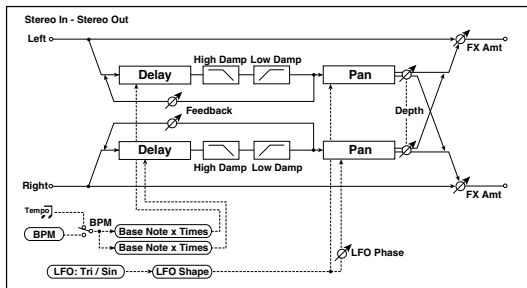

a	BPM	MIDI, 40.00... 300.00	MIDI syncs to the system tempo; 40–300 sets the tempo manually for this individual effect	
	Time Over? L	---, OVER!	Display the error message if the left channel delay time exceeds the upper limit	
	R	---, OVER!	Display the error message if the right channel delay time exceeds the upper limit	
b	L Delay Base Note		Selects the type of notes to specify the left channel delay time	
	Times	x1...x32	Sets the number of notes to specify the left channel delay time	
	Feedback	-100...+100	Sets the feedback amount for the left channel	
c	R Delay Base Note		Selects the type of notes to specify the right channel delay time	
	Times	x1...x32	Sets the number of notes to specify the right channel delay time	
	Feedback	-100...+100	Sets the feedback amount for the right channel	
d	High Damp [%]	0...100	Sets the damping amount in the high range	
	Low Damp [%]	0...100	Sets the damping amount in the low range	
e	LFO Waveform	Triangle, Sine	Selects the LFO Waveform	
	Shape	-100...+100	Changes the curvature of the LFO Waveform	
	LFO Phase	-180...+180	Sets the LFO phase difference between the left and right	
f	Panning Freq [Hz]	0.02...20.00	Sets the panning speed	
g	MIDI Sync	Off, On	When this is on, the pan LFO speed is set by BPM, Base Note, and Times, instead of Frequency	
	BPM	MIDI, 40.00... 300.00	MIDI syncs to the system tempo; 40–300 sets the tempo manually for this individual effect	
	Base Note		Selects the type of notes to specify the delay time for the panning speed	
	Times	x1...x32	Sets the number of notes to specify the delay time for the panning speed	
h	Panning Depth	0...100	Sets the panning width	
	Src	Off...Tempo	Selects the modulation source for the panning width	
	Amt	-100...+100	Set the modulation amount of the panning width	
i	FX Amount	0...100	Amount of FX added to the direct signal	
	Src	Off...Tempo	Table, "Dynamic Modulation sources," on page 26	
	Amt	-100...+100	Amount of modulation source	

069: Tape Echo BPM

This is a tape echo that lets you synchronize the delay time to the tempo of the song.

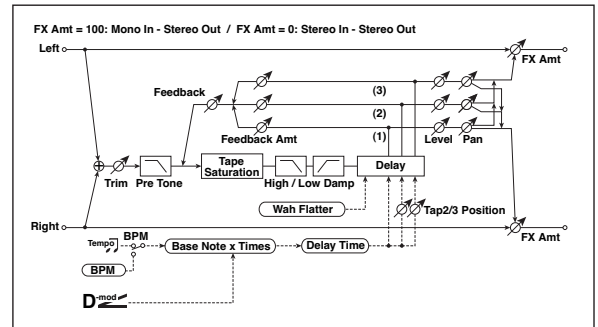

a	BPM (Delay)	MIDI, 40.00... 300.00	MIDI syncs to the system tempo; 40–300 sets the tempo manually for this individual effect	
	Tap1 Dmod Src	Off...Tempo	Selects the modulation source of the delay time	
b	Tap1 Delay Note		Selects the type of notes to specify the delay time (tap1)	
	Times	x1...x32	Sets the number of notes to specify the delay time (tap1)	
c	Time Over?	---, OVER!	Displays an error message when the delay time exceeds the upper limit	
	Tap1 Dmod Note		Selects the note value used to specify the delay time when the modulation is at maximum	
d	Times	x1...x32	Specifies the number of notes used to specify the delay time when the modulation is at maximum	
	Tap2 Position [%]	0...100	Sets the position of Tap 2 relative to the Tap 1 delay time the depth of pitch variation	
e	Tap3 Position [%]	0...100	Sets the position of Tap 3 relative to the Tap 1 delay time the depth of pitch variation	
	Tap1 Level	0...100	Sets the Tap1 output level	
	Pan	L, 1...99, R	Sets the stereo image of tap1	
f	FB Amt	-100...+100	Sets the Tap1 feedback amount	
	Tap2 Level	0...100	Sets the Tap2 output level	
	Pan	L, 1...99, R	Sets the stereo image of tap2	
g	FB Amt	-100...+100	Sets the Tap2 feedback amount	
	Tap3 Level	0...100	Sets the Tap3 output level	
	Pan	L, 1...99, R	Sets the stereo image of tap3	
h	FB Amt	-100...+100	Sets the Tap3 feedback amount	
	Feedback	0...100	Sets the amount of feedback for Taps 1, 2, and 3	
	Src	Off...Tempo	Selects the modulation source of feedback amount	
i	Amt	-100...+100	Sets the depth by which feedback amount will be modulated	
	High Damp [%]	0...100	Sets the damping amount in the high range	
j	Low Damp [%]	0...100	Sets the damping amount in the low range	
	Saturation	0...100	Sets the distortion amount	
k	Input Trim	0...100	Sets the input gain	
	Pre Tone	0...100	Sets the tone of the input	
l	Wow Flutter [Hz]	0.02...1.00	Sets the frequency at which pitch variation will occur	
	Wow Flutter depth	0...100	Sets the depth of pitch variation	
m	FX Amount	0...100	Amount of FX added to the direct signal	
	Src	Off...Tempo	Table, "Dynamic Modulation sources," on page 26	
	Amt	-100...+100	Amount of modulation source	

a: Tap1 Dmod Src

b: Tap1 Delay Note

b: Times

c: Tap1 Dmod Note

c: Times

If “Tap1 Dmod Src” is Off or the selected modulation is at 0, the delay time will be the length specified by “Tap1 Delay Note” and “Times.”

If “Tap1 Dmod Src” is other than Off, the delay time will change so that it will be as specified by “Tap1 Dmod Note” and “Times” when the maximum modulation is reached.

b: Time Over?

You can set the delay time up to 5,400msec. If the delay time exceeds this limit, the error message “OVER!” appears in the display. Set the delay time parameters so that this message will not appear. “Time Over?” is only a display parameter.

Reverb and Early Reflections (Reverb ER)

070: Reverb Hall

This hall-type reverb simulates the reverberation of mid-size concert halls or ensemble halls.

071: Reverb SmoothHall

This hall-type reverb simulates the reverberation of larger halls and stadiums, and creates a smooth release.

072: Reverb Wet Plate

This plate reverb simulates warm (dense) reverberation.

073: Reverb Dry Plate

This plate reverb simulates dry (light) reverberation.

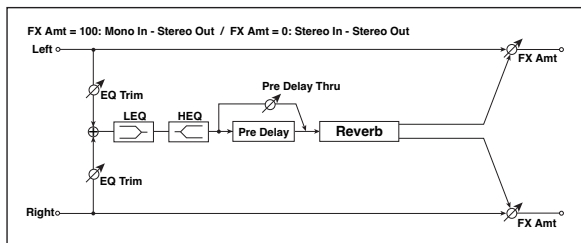

a	Reverb Time [sec]	0.1...10.0	Sets the reverberation time	
	High Damp [%]	0...100	Sets the damping amount in the high range	
b	Pre Delay [msec]	0...200	Sets the delay time from the dry sound	
	Pre Delay Thru [%]	0...100	Sets the mix ratio of non-delay sound	
c	EQ Trim	0...100	Sets the EQ input level	
d	Pre LEQ Fc	Low, Mid-Low	Selects the cutoff frequency (low or mid-low) of the low-range equalizer	
	Pre HEQ Fc	High, Mid-High	Selects the cutoff frequency (high or mid-high) of the high-range equalizer	
e	Pre LEQ Gain [dB]	-15.0...+15.0	Sets the gain of Low EQ	
	Pre HEQ Gain [dB]	-15.0...+15.0	Sets the gain of High EQ	
f	FX Amount	0...100	Amount of FX added to the direct signal	D ^{mod}
	Src	Off...Tempo	Table , "Dynamic Modulation sources," on page 26	
	Amt	-100...+100	Amount of modulation source	

b: Pre Delay [msec]

b: Pre Delay Thru [%]

The "Pre Delay" sets the delay time to the reverb input, allowing you to control spaciousness.

Using the "Pre Delay Thru" parameter, you can mix the dry sound without delay, emphasizing the attack of the sound.

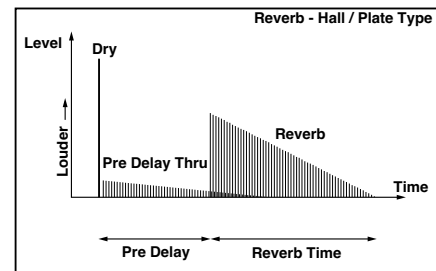

074: Reverb Room

This room-type reverb emphasizes the early reflections that make the sound tighter. Changing the balance between the early reflections and reverb sound allows you to simulate nuances, such as the type of walls of a room.

075: Reverb BrightRoom

This room-type reverb emphasizes the early reflections that make the sound brighter.

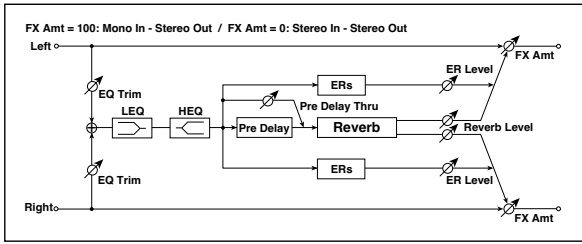

a	Reverb Time [sec]	0.1...3.0	Sets the reverberation time	
	High Damp [%]	0...100	Sets the damping amount in the high range	
b	Pre Delay [msec]	0...200	Sets the delay time from the dry sound	
	Pre Delay Thru [%]	0...100	Sets the mix ratio of non-delay sound	
c	ER Level	0...100	Sets the level of early reflections	
d	Reverb Level	0...100	Sets the reverberation level	
e	EQ Trim	0...100	Sets the EQ input level	
f	Pre LEQ Fc	Low, Mid-Low	Selects the cutoff frequency (low or mid-low) of the low-range equalizer	
	Pre HEQ Fc	High, Mid-High	Selects the cutoff frequency (high or mid-high) of the high-range equalizer	
g	Pre LEQ Gain [dB]	-15.0...+15.0	Sets the gain of Low EQ	
	Pre HEQ Gain [dB]	-15.0...+15.0	Sets the gain of High EQ	
h	FX Amount	0...100	Amount of FX added to the direct signal	D
	Src	Off...Tempo	Table , "Dynamic Modulation sources," on page 26	
	Amt	-100...+100	Amount of modulation source	

c: ER Level

d: Reverb Level

These parameters set the early reflection level and reverb level.

Changing these parameter values allows you to simulate the type of walls in the room. That is, a larger "ER Level" simulates a hard wall, and a larger "Reverb Level" simulates a soft wall.

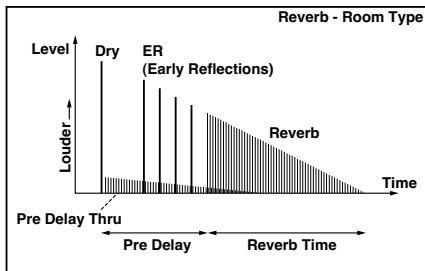

076: Early Reflections

This effect is only the early reflection part of a reverberation sound, and adds presence to the sound. You can select one of the four decay curves.

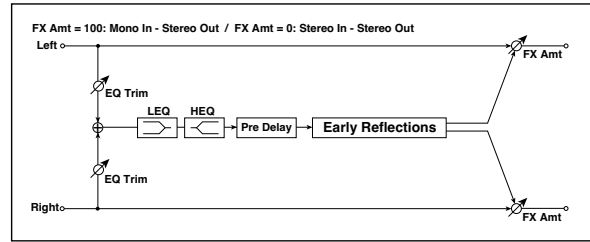

a	Type	Sharp, Loose, Modulated, Reverse	Selects the decay curve for the early reflection	
b	ER Time [msec]	10...800	Sets the time length of early reflection	
c	Pre Delay [msec]	0...200	Sets the time taken from the original sound to the first early reflection	
d	EQ Trim	0...100	Sets the input level of EQ applied to the effect sound	
e	Pre LEQ Fc	Low, Mid-Low	Selects the cutoff frequency (low or mid-low) of the low-range equalizer	
	Pre HEQ Fc	High, Mid-High	Selects the cutoff frequency (high or mid-high) of the high-range equalizer	
f	Pre LEQ Gain [dB]	-15.0...+15.0	Gain of the Low EQ	
	Pre HEQ Gain [dB]	-15.0...+15.0	Gain of the High EQ	
g	FX Amount	0...100	Amount of FX added to the direct signal	D
	Src	Off...Tempo	Table , "Dynamic Modulation sources," on page 26	
	Amt	-100...+100	Amount of modulation source	

a: Type

This parameter selects the decay curve for the early reflection.

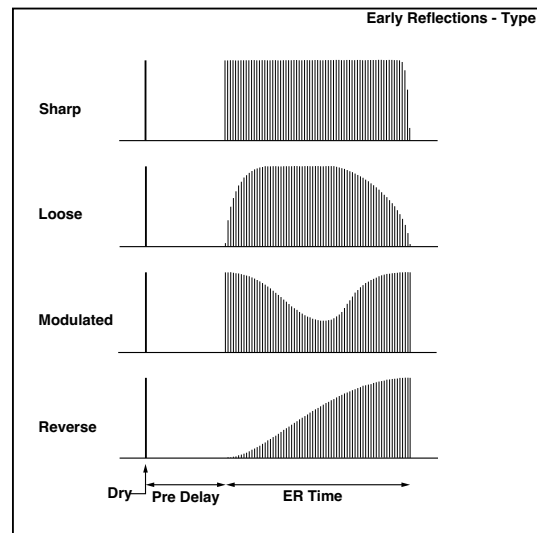

Mono-Mono Serial (Mono-Mono)

077: P4EQ - Exciter (Parametric 4-Band EQ - Exciter)

This effect combines a mono four-band parametric equalizer and an exciter.

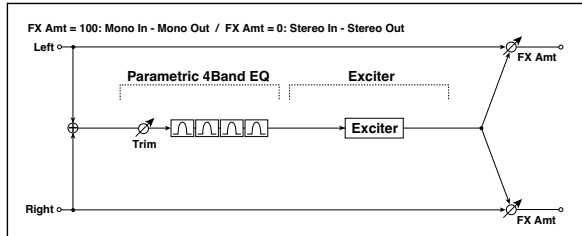

P4EQ			
a	[E]Trim	0...100	Sets the parametric EQ input level
b	[E]B1 Cutoff [Hz]	20...1.00k	Sets the center frequency of Band 1
	Q	0.5...10.0	Sets the bandwidth of Band 1
	Gain [dB]	-18...+18	Sets the gain of Band 1
c	[E]B2 Cutoff [Hz]	50...5.00k	Sets the center frequency of Band 2
	Q	0.5...10.0	Sets the bandwidth of Band 2
	Gain [dB]	-18...+18	Sets the gain of Band 2
d	[E]B3 Cutoff [Hz]	300...10.00k	Sets the center frequency of Band 3
	Q	0.5...10.0	Sets the bandwidth of Band 3
	Gain [dB]	-18...+18	Sets the gain of Band 3
e	[E]B4 Cutoff [Hz]	500...20.00k	Sets the center frequency of Band 4
	Q	0.5...10.0	Sets the bandwidth of Band 4
	Gain [dB]	-18...+18	Sets the gain of Band 4
EXCITER			
f	[X]Exciter Blend	-100...+100	Sets the intensity (depth) of the Exciter effect
g	[X]Emphasis Freq	0...70	Sets the frequency range to be emphasized
h	FX Amount	0...100	Amount of FX added to the direct signal
	Src	Off...Tempo	Table, "Dynamic Modulation sources," on page 26
	Amt	-100...+100	Amount of modulation source

078: P4EQ - Wah (Parametric 4-Band EQ - Wah/Auto Wah)

This effect combines a mono four-band parametric equalizer and a wah. You can change the order of the connection.

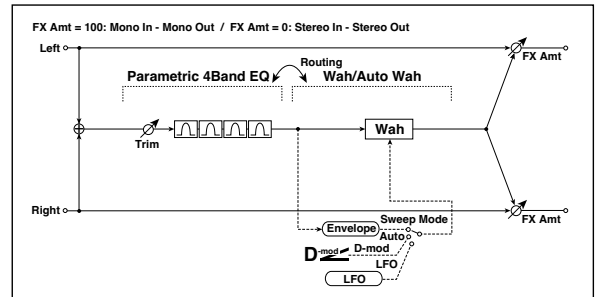

P4EQ			
a	[E]Trim	0...100	Sets the parametric EQ input level
	Routing	P4EQ → Wah, Wah → P4EQ	Changes the order of the parametric equalizer and wah connection
b	[E]B1 Cutoff [Hz]	20...1.00k	Sets the center frequency of Band 1
	Q	0.5...10.0	Sets the bandwidth of Band 1
	Gain [dB]	-18...+18	Sets the gain of Band 1
c	[E]B2 Cutoff [Hz]	50...5.00k	Sets the center frequency of Band 2
	Q	0.5...10.0	Sets the bandwidth of Band 2
	Gain [dB]	-18...+18	Sets the gain of Band 2
d	[E]B3 Cutoff [Hz]	300...10.00k	Sets the center frequency of Band 3
	Q	0.5...10.0	Sets the bandwidth of Band 3
	Gain [dB]	-18...+18	Sets the gain of Band 3
e	[E]B4 Cutoff [Hz]	500...20.00k	Sets the center frequency of Band 4
	Q	0.5...10.0	Sets the bandwidth of Band 4
	Gain [dB]	-18...+18	Sets the gain of Band 4
WAH			
f	[W]Frequency Bottom	0...100	Sets the lower limit of the wah center frequency
	Frequency Top	0...100	Sets the upper limit of the wah center frequency
g	[W]Sweep Mode	Auto, D-mod, LFO	Selects the control from auto-wah, modulation source, and LFO
	Src	Off...Tempo	Selects the modulation source for the wah when Sweep Mode=D-mod
h	[W]LFO Frequency [Hz]	0.02...20.00	Sets the speed of the LFO
	Resonance	0...100	Sets the resonance amount
	LPF	Off, On	Switches the wah low pass filter on and off
i	[W] Wet/Dry	Dry, 1 : 99... 99 : 1, Wet	Sets the wah effect balance
	Src	Off...Tempo	Selects the Wet/Dry modulation source for the wah
	Amt	-100...+100	Sets the Wet/Dry modulation amount for the wah
j	FX Amount	0...100	Amount of FX added to the direct signal
	Src	Off...Tempo	Table, "Dynamic Modulation sources," on page 26
	Amt	-100...+100	Amount of modulation source

079: P4EQ - Cho/Flng (Parametric 4-Band EQ - Chorus/Flanger)

This effect combines a mono four-band parametric equalizer and a chorus/flanger.

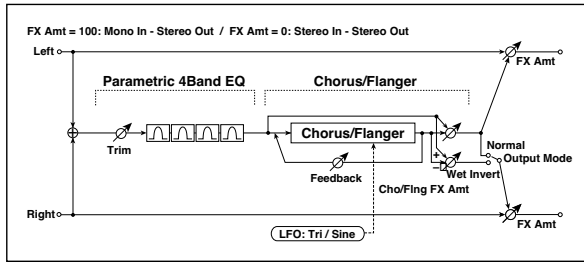

P4EQ			
a	[E]Trim	0...100	Sets the parametric EQ input level
b	[E]B1 Cutoff [Hz]	20...1.00k	Sets the center frequency of Band 1
	Q	0.5...10.0	Sets the bandwidth of Band 1
	Gain [dB]	-18...+18	Sets the gain of Band 1
c	[E]B2 Cutoff [Hz]	50...5.00k	Sets the center frequency of Band 2
	Q	0.5...10.0	Sets the bandwidth of Band 2
	Gain [dB]	-18...+18	Sets the gain of Band 2
d	[E]B3 Cutoff [Hz]	300...10.00k	Sets the center frequency of Band 3
	Q	0.5...10.0	Sets the bandwidth of Band 3
	Gain [dB]	-18...+18	Sets the gain of Band 3
e	[E]B4 Cutoff [Hz]	500...20.00k	Sets the center frequency of Band 4
	Q	0.5...10.0	Sets the bandwidth of Band 4
	Gain [dB]	-18...+18	Sets the gain of Band 4
CHORUS/FLANGER			
f	[F]LFO Frequency [Hz]	0.02...20.00	Sets the speed of the LFO
	LFO Waveform	Triangle, Sine	Selects the LFO Waveform
g	[F]Delay Time [msec]	0.0...1350.0	Sets the delay time
	Depth	0...100	Sets the depth of LFO modulation
	Feedback	-100...+100	Sets the feedback amount
h	[F]Cho/Flng Wet/Dry	-100...0...100	Sets the effect balance of the chorus/flanger
	Src	Off...Tempo	Selects the Wet/Dry modulation source for the chorus/flanger
	Amt	-100...+100	Sets the Wet/Dry modulation amount for the chorus/flanger
i	[F]Output Mode	Normal, Wet Invert	Selects the output mode for the chorus/flanger
j	FX Amount	0...100	Amount of FX added to the direct signal
	Src	Off...Tempo	Table, "Dynamic Modulation sources," on page 26
	Amt	-100...+100	Amount of modulation source

i: Output Mode

When Wet Invert is selected, the right channel phase of the chorus/flanger effect sound is inverted. This creates pseudo-stereo effects and adds spread.

However, if a mono-input type effect is connected after this effect, the left and right sounds may cancel each other, eliminating the chorus/flanger effects.

080: P4EQ - Phaser (Parametric 4-Band EQ - Phaser)

This effect combines a mono four-band parametric equalizer and a phaser.

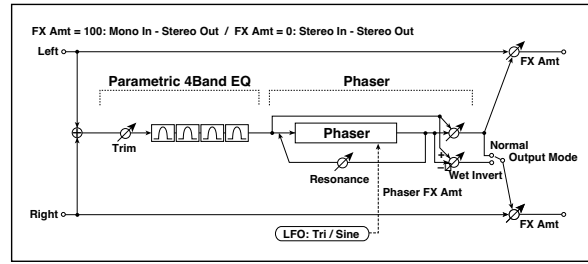

P4EQ			
a	[E]Trim	0...100	Sets the parametric EQ input level
b	[E]B1 Cutoff [Hz]	20...1.00k	Sets the center frequency of Band 1
	Q	0.5...10.0	Sets the bandwidth of Band 1
	Gain [dB]	-18...+18	Sets the gain of Band 1
c	[E]B2 Cutoff [Hz]	50...5.00k	Sets the center frequency of Band 2
	Q	0.5...10.0	Sets the bandwidth of Band 2
	Gain [dB]	-18...+18	Sets the gain of Band 2
d	[E]B3 Cutoff [Hz]	300...10.00k	Sets the center frequency of Band 3
	Q	0.5...10.0	Sets the bandwidth of Band 3
	Gain [dB]	-18...+18	Sets the gain of Band 3
e	[E]B4 Cutoff [Hz]	500...20.00k	Sets the center frequency of Band 4
	Q	0.5...10.0	Sets the bandwidth of Band 4
	Gain [dB]	-18...+18	Sets the gain of Band 4
PHASER			
f	[P]LFO Frequency [Hz]	0.02...20.00	Sets the speed of the LFO
	LFO Waveform	Triangle, Sine	Selects the LFO Waveform
g	[P]Manual	0...100	Sets the frequency to which the effect is applied
	Depth	0...100	Sets the depth of LFO modulation
	Resonance	-100...+100	Sets the resonance amount
h	[P]Phaser Wet/Dry	-100...0...100	Sets the phaser effect balance
	Src	Off...Tempo	Selects the Wet/Dry modulation source for the phaser
	Amt	-100...+100	Sets the Wet/Dry modulation amount for the phaser
i	[P]Output Mode	Normal, Wet Invert	Selects the phaser output mode
j	FX Amount	0...100	Amount of FX added to the direct signal
	Src	Off...Tempo	Table, "Dynamic Modulation sources," on page 26
	Amt	-100...+100	Amount of modulation source

081: P4EQ - Mt. Delay (Parametric 4-Band EQ - Multitap Delay)

This effect combines a mono four-band parametric equalizer and a multitap delay.

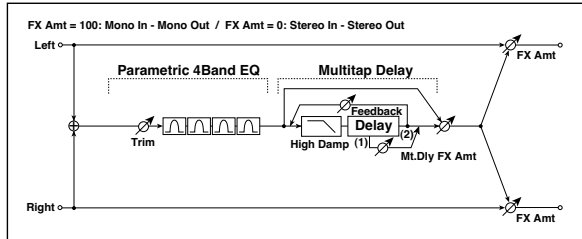

P4EQ			
a	[E]Trim	0...100	Sets the parametric EQ input level
b	[E]B1 Cutoff [Hz]	20...1.00k	Sets the center frequency of Band 1
	Q	0.5...10.0	Sets the bandwidth of Band 1
	Gain [dB]	-18...+18	Sets the gain of Band 1
c	[E]B2 Cutoff [Hz]	50...5.00k	Sets the center frequency of Band 2
	Q	0.5...10.0	Sets the bandwidth of Band 2
	Gain [dB]	-18...+18	Sets the gain of Band 2
d	[E]B3 Cutoff [Hz]	300...10.00 k	Sets the center frequency of Band 3
	Q	0.5...10.0	Sets the bandwidth of Band 3
	Gain [dB]	-18...+18	Sets the gain of Band 3
e	[E]B4 Cutoff [Hz]	500...20.00 k	Sets the center frequency of Band 4
	Q	0.5...10.0	Sets the bandwidth of Band 4
	Gain [dB]	-18...+18	Sets the gain of Band 4
MULTITAP DELAY			
f	[D]Tap1 Time [msec]	0.0...1360.0	Sets the Tap1 delay time
	Tap1 Level	0...100	Sets the Tap1 output level
g	[D]Tap2 Time [msec]	0.0...1360.0	Sets the Tap2 delay time
	Feedback (Tap2)	-100...+100	Sets the Tap2 feedback amount
h	[D]High Damp [%]	0...100	Sets the damping amount in the high range
	[D]Mt. Delay Wet/Dry	0...100	Sets the multitap delay effect balance
i	Src	Off...Tempo	Selects the Wet/Dry modulation source for the multitap delay
	Amt	-100...+100	Sets the Wet/Dry modulation amount for the multitap delay
	FX Amount	0...100	Amount of FX added to the direct signal
j	Src	Off...Tempo	Table, "Dynamic Modulation sources," on page 26
	Amt	-100...+100	Amount of modulation source

082: Comp - Wah (Compressor - Wah/Auto Wah)

This effect combines a mono compressor and a wah. You can change the order of the connection.

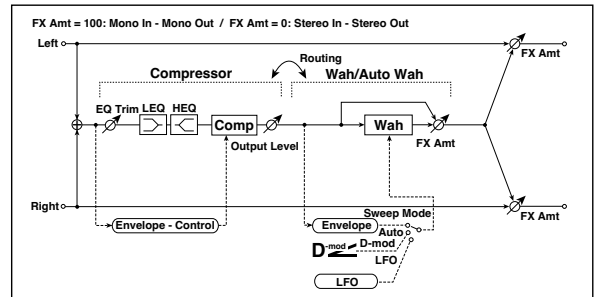

COMPRESSOR			
a	[C] Sensitivity	1...100	Sets the sensitivity
b	[C]Attack	1...100	Sets the attack level
	Output Level	0...100	Sets the compressor output level
c	[C]EQ Trim	0...100	Sets the EQ input level
d	[C]Pre LEQ Gain [dB]	-15...+15	Sets the gain of Low EQ
	Pre HEQ Gain [dB]	-15...+15	Sets the gain of High EQ
WAH			
e	[W]Frequency Bottom	0...100	Sets the lower limit of the wah center frequency
	Frequency Top	0...100	Sets the upper limit of the wah center frequency
f	[w]Sweep Mode	Auto, D-mod, LFO	Selects the control from auto-wah, modulation source, and LFO
	Src	Off...Tempo	Selects the modulation source for the wah when Sweep Mode=D-mod
g	[W]LFO Frequency [Hz]	0.02...20.00	Sets the speed of the LFO
	Resonance	0...100	Sets the resonance amount
	LPF	Off, On	Switches the wah low pass filter on and off
h	[W]Wet/Dry	Dry, 1 : 99...99 : 1, Wet	Sets the wah effect balance
	Src	Off...Tempo	Selects the Wet/Dry modulation source for the wah
	Amt	-100...+100	Sets the Wet/Dry modulation amount for the wah
i	Routing	Comp → Wah, Wah → Comp	Switches the order of the compressor and wah
j	FX Amount	0...100	Amount of FX added to the direct signal
	Src	Off...Tempo	Table, "Dynamic Modulation sources," on page 26
	Amt	-100...+100	Amount of modulation source

083: Comp - Amp Sim (Compressor - Amp Simulation)

This effect combines a mono compressor and an amp simulation. You can change the order of the effects.

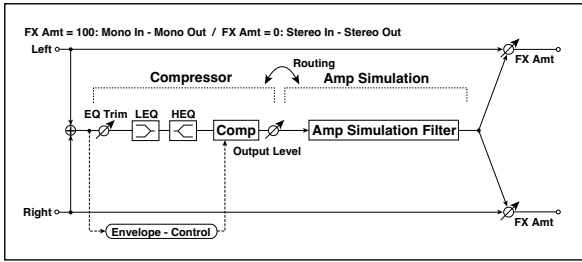

COMPRESSOR			
a	[C] Sensitivity	1...100	Sets the sensitivity
b	[C] Attack	1...100	Sets the attack level
	Output Level	0...100	Sets the compressor output level
c	[C] EQ Trim	0...100	Sets the EQ input level
d	[C] Pre LEQ Gain [dB]	-15...+15	Sets the gain of Low EQ
	Pre HEQ Gain [dB]	-15...+15	Sets the gain of High EQ
AMP SIM			
e	[A] Amplifier Type	SS, EL84, 6L6	Selects the type of guitar amplifier
f	Routing	Comp → Amp, Amp → Comp	Switches the order of the compressor and amp simulation
g	FX Amount	0...100	Amount of FX added to the direct signal
	Src	Off...Tempo	Table, "Dynamic Modulation sources," on page 26
	Amt	-100...+100	Amount of modulation source

084: Comp - OD/HiGain (Compressor - Overdrive/HiGain)

This effect combines a mono compressor and an overdrive/high-gain distortion. You can change the order of the effects.

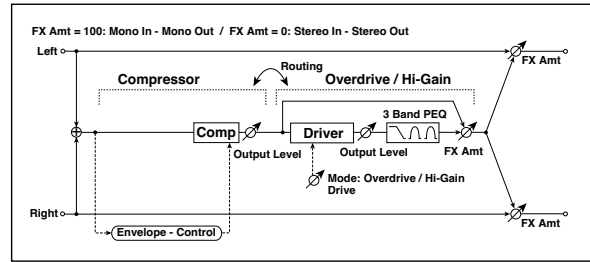

COMPRESSOR			
a	[C] Sensitivity	1...100	Sets the sensitivity
b	[C] Attack	1...100	Sets the attack level
	Output Level	0...100	Sets the compressor output level
OD/HI-GAIN			
c	[O] Drive Mode	Overdrive, Hi-Gain	Switches between overdrive and high-gain distortion
	Drive	1...100	Sets the degree of distortion
d	[O] Output Level	0...50	Sets the overdrive output level
	Src	Off...Tempo	Selects the modulation source for the overdrive output level
	Amt	-50...+50	Sets the modulation amount of the overdrive output level
e	[O] Low Cutoff [Hz]	20...1.00k	Sets the center frequency for Low EQ (shelving type)
	Gain [dB]	-18...+18	Sets the gain of Low EQ
f	[O] Mid1 Cutoff [Hz]	300...10.00k	Sets the center frequency for Mid/High EQ 1 (peaking type)
	Q	0.5...10.0	Sets the band width of Mid/High EQ 1
	Gain [dB]	-18...+18	Sets the gain of Mid/High EQ 1
g	[O] Mid2 Cutoff [Hz]	500...20.00k	Sets the center frequency for Mid/High EQ 2 (peaking type)
	Gain [dB]	-18...+18	Sets the gain of Mid/High EQ 2
h	[O] Wet/Dry	Dry, 1 : 99...99 : 1, Wet	Sets the overdrive effect balance
	Src	Off...Tempo	Selects the Wet/Dry modulation source for the overdrive
	Amt	-100...+100	Sets the Wet/Dry modulation amount for the overdrive
i	Routing	Comp → OD/HG, OD/HG → Comp	Switches the order of the compressor and overdrive
j	FX Amount	0...100	Amount of FX added to the direct signal
	Src	Off...Tempo	Table, "Dynamic Modulation sources," on page 26
	Amt	-100...+100	Amount of modulation source

085: Comp - P4EQ (Compressor - Parametric 4-Band EQ)

This effect combines a mono compressor and a four-band parametric equalizer. You can change the order of the effects.

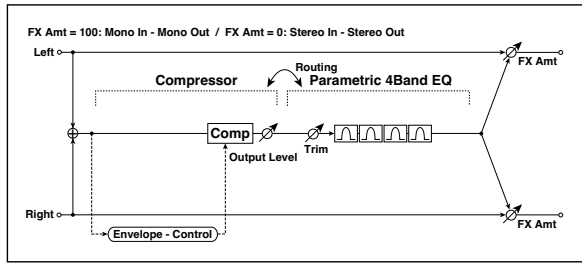

COMPRESSOR			
a	[C] Sensitivity	1...100	Sets the sensitivity
b	[C] Attack	1...100	Sets the attack level
	Output Level	0...100	Sets the compressor output level
P4EQ			
c	[E] Trim	0...100	Sets the parametric EQ input level
d	[E] B1 Cutoff [Hz]	20...1.00k	Sets the center frequency of Band 1
	Q	0.5...10.0	Sets the bandwidth of Band 1
	Gain [dB]	-18...+18	Sets the gain of Band 1
e	[E] B2 Cutoff [Hz]	50...5.00k	Sets the center frequency of Band 2
	Q	0.5...10.0	Sets the bandwidth of Band 2
	Gain [dB]	-18...+18	Sets the gain of Band 2
f	[E] B3 Cutoff [Hz]	300...10.00k	Sets the center frequency of Band 3
	Q	0.5...10.0	Sets the bandwidth of Band 3
	Gain [dB]	-18...+18	Sets the gain of Band 3
g	[E] B4 Cutoff [Hz]	500...20.00k	Sets the center frequency of Band 4
	Q	0.5...10.0	Sets the bandwidth of Band 4
	Gain [dB]	-18...+18	Sets the gain of Band 4
h	Routing	Comp → P4EQ, P4EQ → Comp	Switches the order of the compressor and parametric EQ
i	FX Amount	0...100	Amount of FX added to the direct signal
	Src	Off...Tempo	Table, "Dynamic Modulation sources," on page 26
	Amt	-100...+100	Amount of modulation source

086: Comp - Cho/Flng (Compressor - Chorus/Flanger)

This effect combines a mono compressor and a chorus/flanger. You can change the order of the effects.

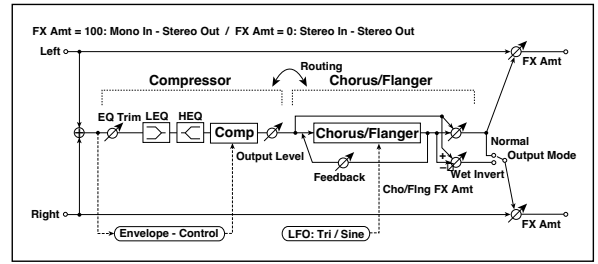

COMPRESSOR			
a	[C] Sensitivity	1...100	Sets the sensitivity
b	[C] Attack	1...100	Sets the attack level
	Output Level	0...100	Sets the compressor output level
c	[C] EQ Trim	0...100	Sets the EQ input level
d	[C] Pre LEQ Gain [dB]	-15...+15	Sets the gain of Low EQ
	Pre HEQ Gain [dB]	-15...+15	Sets the gain of High EQ
CHORUS/FLANGER			
e	[F] LFO Frequency [Hz]	0.02...20.00	Sets the speed of the LFO
	LFO Waveform	Triangle, Sine	Selects the LFO Waveform
f	[F] Delay Time [msec]	0.0...1350.0	Sets the delay time
	Depth	0...100	Sets the depth of LFO modulation
	Feedback	-100...+100	Sets the feedback amount
g	[F] Cho/Flng Wet/Dry	-100...0...100	Sets the effect balance of the chorus/flanger
	Src	Off...Tempo	Selects the Wet/Dry modulation source for the chorus/flanger
	Amt	-100...+100	Sets the Wet/Dry modulation amount for the chorus/flanger
h	[F] Output Mode	Normal, Wet Invert	Selects the output mode for the chorus/flanger
i	Routing	Comp → Flanger, Flanger → Comp	Switches the order of the compressor and chorus/flanger
j	FX Amount	0...100	Amount of FX added to the direct signal
	Src	Off...Tempo	Table, "Dynamic Modulation sources," on page 26
	Amt	-100...+100	Amount of modulation source

h: [F] Output Mode

i: Routing

When Wet Invert is selected, the right channel phase of the chorus/flanger effect sound is inverted. This creates pseudo-stereo effects and adds spread.

However, if a mono-input type effect is connected after this effect, the left and right sounds may cancel each other, eliminating the chorus/flanger effects.

When "Routing" is set to Flanger→Comp, "[F] Output Mode" will be set to Normal.

087: Comp - Phaser (Compressor - Phaser)

This effect combines a mono compressor and a phaser. You can change the order of the effects.

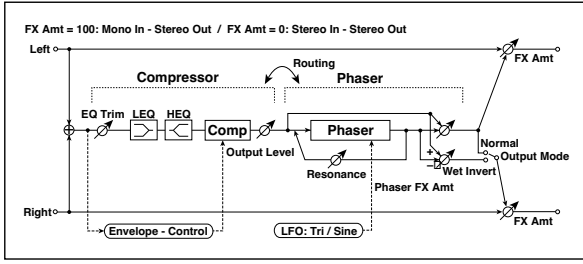

COMPRESSOR				
a	[C] Sensitivity	1...100	Sets the sensitivity	
b	[C] Attack	1...100	Sets the attack level	
	Output Level	0...100	Sets the compressor output level	
c	[C] EQ Trim	0...100	Sets the EQ input level	
d	[C] Pre LEQ Gain [dB]	-15...+15	Sets the gain of Low EQ	
	Pre HEQ Gain [dB]	-15...+15	Sets the gain of High EQ	
PHASER				
e	[P] LFO Frequency [Hz]	0.02...20.00	Sets the speed of the LFO	
	LFO Waveform	Triangle, Sine	Selects the LFO Waveform	
f	[P] Manual	0...100	Sets the frequency to which the effect is applied	
	Depth	0...100	Sets the depth of LFO modulation	
	Resonance	-100...+100	Sets the resonance amount	
g	[P] Phaser Wet/Dry	-100...0...100	Sets the phaser effect balance	
	Src	Off...Tempo	Selects the Wet/Dry modulation source for the phaser	
	Amt	-100...+100	Sets the Wet/Dry modulation amount for the phaser	
h	[F] Output Mode	Normal, Wet Invert	Selects the phaser output mode	
i	Routing	Comp → Phaser, Phaser → Comp	Switches the order of the compressor and phaser	
j	FX Amount	0...100	Amount of FX added to the direct signal	
	Src	Off...Tempo	Table, "Dynamic Modulation sources," on page 26	
	Amt	-100...+100	Amount of modulation source	

088: Comp - Mt. Delay (Compressor - Multitap Delay)

This effect combines a mono compressor and a multitap delay. You can change the order of the effects.

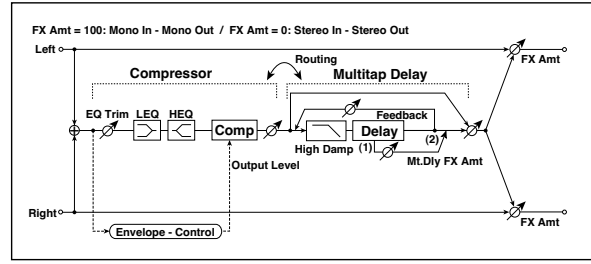

COMPRESSOR				
a	[C] Sensitivity	1...100	Sets the sensitivity	
b	[C] Attack	1...100	Sets the attack level	
	Output Level	0...100	Sets the compressor output level	
c	[C] EQ Trim	0...100	Sets the EQ input level	
d	[C] Pre LEQ Gain [dB]	-15...+15	Sets the gain of Low EQ	
	Pre HEQ Gain [dB]	-15...+15	Sets the gain of High EQ	
MULTITAP DELAY				
e	[D] Tap1 Time [msec]	0.0...1360.0	Sets the Tap1 delay time	
	Tap1 Level	0...100	Sets the Tap1 output level	
f	[D] Tap2 Time [msec]	0.0...1360.0	Sets the Tap2 delay time	
	Feedback (Tap2)	-100...+100	Sets the Tap2 feedback amount	
g	[D] High Damp [%]	0...100	Sets the damping amount in the high range	
h	[D] Mt. Delay Wet/Dry	Dry, 1 : 99...99 : 1, Wet	Sets the multitap delay effect balance	
	Src	Off...Tempo	Selects the Wet/Dry modulation source for the multitap delay	
	Amt	-100...+100	Sets the Wet/Dry modulation amount for the multitap delay	
i	Routing	Comp → Mt. Delay, Mt. Delay → Comp	Switches the order of the compressor and multitap delay	
j	FX Amount	0...100	Amount of FX added to the direct signal	
	Src	Off...Tempo	Table, "Dynamic Modulation sources," on page 26	
	Amt	-100...+100	Amount of modulation source	

089: Limiter - P4EQ (Limiter - Parametric 4-Band EQ)

This effect combines a mono limiter and a four-band parametric equalizer. You can change the order of the effects.

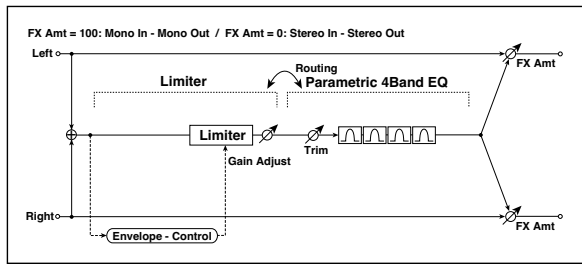

LIMITER				
a	[L]Ratio	1.0 : 1... 50.0 : 1, Inf : 1	Sets the signal compression ratio	
	Threshold [dB]	-40...0	Sets the level above which the compressor is applied	
b	[L]Attack	1...100	Sets the attack time	
	Release	1...100	Sets the release time	
c	[L]Gain Adjust [dB]	-Inf...+24	Sets the limiter output gain	
P4EQ				
d	[E]Trim	0...100	Sets the parametric EQ input level	
e	[E]B1 Cutoff [Hz]	20...1.00k	Sets the center frequency of Band 1	
	Q	0.5...10.0	Sets the bandwidth of Band 1	
	Gain [dB]	-18...+18	Sets the gain of Band 1	
f	[E]B2 Cutoff [Hz]	50...5.00k	Sets the center frequency of Band 2	
	Q	0.5...10.0	Sets the bandwidth of Band 2	
	Gain [dB]	-18...+18	Sets the gain of Band 2	
g	[E]B3 Cutoff [Hz]	300...10.00k	Sets the center frequency of Band 3	
	Q	0.5...10.0	Sets the bandwidth of Band 3	
	Gain [dB]	-18...+18	Sets the gain of Band 3	
h	[E]B4 Cutoff [Hz]	500...20.00k	Sets the center frequency of Band 4	
	Q	0.5...10.0	Sets the bandwidth of Band 4	
	Gain [dB]	-18...+18	Sets the gain of Band 4	
i	Routing	Limiter → P4EQ, P4EQ → Limiter	Switches the order of the limiter and parametric EQ	
j	FX Amount	0...100	Amount of FX added to the direct signal	D ^{mod}
	Src	Off...Tempo	Table, "Dynamic Modulation sources," on page 26	
	Amt	-100...+100	Amount of modulation source	

- a: [L]Ratio
- a: Threshold [dB]
- c: [L]Gain Adjust [dB]

This parameter sets the signal compression "[L]Ratio". Compression is applied only when the signal level exceeds the "Threshold" value.

Adjust the output level using the "Gain Adjust" parameter, since compression causes the entire level to be reduced.

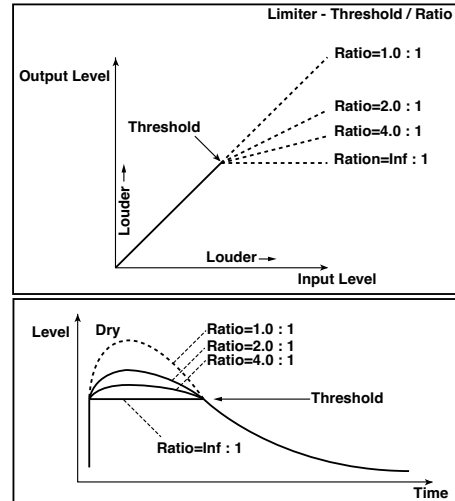

090: Limiter - Cho/Flng (Limiter - Chorus/Flanger)

This effect combines a mono limiter and a chorus/flanger. You can change the order of the effects.

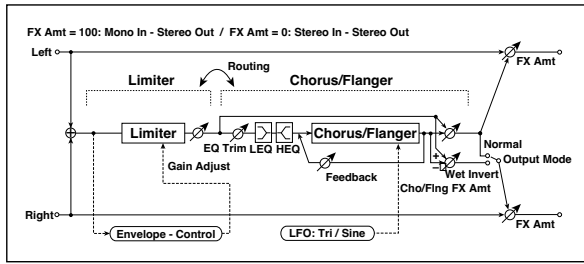

LIMITER			
a	[L]Ratio	1.0 : 1... 50.0 : 1, Inf : 1	Sets the signal compression ratio
	Threshold [dB]	-40...0	Sets the level above which the compressor is applied
b	[L]Attack	1...100	Sets the attack time
	Release	1...100	Sets the release time
c	[L]Gain Adjust [dB]	-Inf, -38...+24	Sets the limiter output gain
CHORUS/FLANGER			
d	[F]LFO Frequency [Hz]	0.02...20.00	Sets the speed of the LFO
	LFO Waveform	Triangle, Sine	Selects the LFO Waveform
e	[F]Delay Time [msec]	0.0...1350.0	Sets the delay time
	Depth	0...100	Sets the depth of LFO modulation
	Feedback	-100...+100	Sets the feedback amount
f	[F]EQ Trim	0...100	Sets the EQ input level
g	[F]Pre LEQ Gain [dB]	-15...+15	Sets the gain of Low EQ
	Pre HEQ Gain [dB]	-15...+15	Sets the gain of High EQ
h	[F]Cho/Flng Wet/Dry	-100...0...100	Sets the effect balance of the chorus/flanger
	Src	Off...Tempo	Selects the Wet/Dry modulation source for the chorus/flanger
	Amt	-100...+100	Sets the Wet/Dry modulation amount for the chorus/flanger
i	[F]Output Mode	Normal, Wet Invert	Selects the output mode for the chorus/flanger
	Routing	Limiter → Flanger, Flanger → Limiter	Switches the order of the limiter and chorus/flanger
j	FX Amount	0...100	Amount of FX added to the direct signal
	Src	Off...Tempo	Table , "Dynamic Modulation sources," on page 26
	Amt	-100...+100	Amount of modulation source

091: Limiter - Phaser

This effect combines a mono limiter and a phaser. You can change the order of the effects.

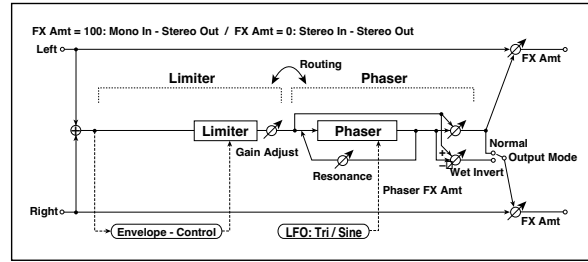

LIMITER			
a	[L]Ratio	1.0 : 1... 50.0 : 1, Inf : 1	Sets the signal compression ratio
	Threshold [dB]	-40...0	Sets the level above which the compressor is applied
b	[L]Attack	1...100	Sets the attack time
	Release	1...100	Sets the release time
c	[L]Gain Adjust [dB]	-Inf, -38...+24	Sets the limiter output gain
PHASER			
d	[P]LFO Frequency [Hz]	0.02...20.00	Sets the speed of the LFO
	LFO Waveform	Triangle, Sine	Selects the LFO Waveform
e	[P]Manual	0...100	Sets the frequency to which the effect is applied
	Depth	0...100	Sets the depth of LFO modulation
	Resonance	-100...+100	Sets the resonance amount
f	[P]Phaser Wet/Dry	-100...0...100	Sets the phaser effect balance
	Src	Off...Tempo	Selects the phaser's Wet/Dry modulation source
g	Amt	-100...+100	Sets the phaser's Wet/Dry modulation amount
	[P]Output Mode	Normal, Wet Invert	Selects the phaser output mode
h	Routing	Limiter → Phaser, Phaser → Limiter	Switches the order of the limiter and phaser
i	FX Amount	0...100	Amount of FX added to the direct signal
	Src	Off...Tempo	Table , "Dynamic Modulation sources," on page 26
	Amt	-100...+100	Amount of modulation source

092: Limiter - Mt.Delay (Limiter - Multitap Delay)

This effect combines a mono limiter and a multitap delay. You can change the order of the effects.

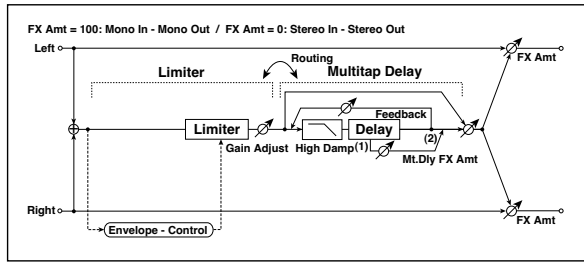

LIMITER			
a	[L]Ratio	1.0 : 1... 50.0 : 1, Inf : 1	Sets the signal compression ratio
	Threshold [dB]	-40...0	Sets the level above which the compressor is applied
b	[L]Attack	1...100	Sets the attack time
	Release	1...100	Sets the release time
c	[L]Gain Adjust [dB]	-Inf, -38...+24	Sets the limiter output gain
MULTITAP DELAY			
d	[D]Tap1 Time [msec]	0.0...1360.0	Sets the Tap1 delay time
	Tap1 Level	0...100	Sets the Tap1 output level
e	[D]Tap2 Time [msec]	0.0...1360.0	Sets the Tap2 delay time
	Feedback	-100...+100	Sets the Tap2 feedback amount
f	[D]High Damp [%]	0...100	Sets the damping amount in the high range
g	[D]Mt.Delay Wet/Dry	0...100	Sets the multitap delay effect balance
	Src	Off...Tempo	Selects the multitap delay's Wet/Dry modulation source
	Amt	-100...+100	Sets the multitap delay's Wet/Dry modulation amount
h	Routing	Limiter → Mt.Delay, Mt.Delay → Limiter	Switches the order of the limiter and multitap delay
i	FX Amount	0...100	Amount of FX added to the direct signal
	Src	Off...Tempo	Table , "Dynamic Modulation sources," on page 26
	Amt	-100...+100	Amount of modulation source

093: Exciter - Comp (Exciter -Compressor)

This effect combines a mono exciter and a compressor. You can change the order of the effects.

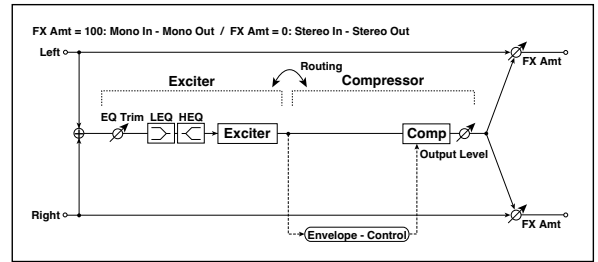

EXCITER			
a	[X]Exciter Blend	-100...+100	Sets the intensity (depth) of the Exciter effect
b	[X]Emphasis Frequency	0...70	Sets the frequency range to be emphasized
c	[X]EQ Trim	0...100	Sets the EQ input level
d	[X]Pre LEQ Gain [dB]	-15...+15	Sets the gain of Low EQ
	Pre HEQ Gain [dB]	-15...+15	Sets the gain of High EQ
COMPRESSOR			
e	[C]Sensitivity	1...100	Sets the sensitivity
f	[C]Attack	1...100	Sets the attack level
	Output Level	0...100	Sets the compressor output level
g	Routing	Exciter → Comp, Comp → Exciter	Switches the order of the exciter and compressor
h	FX Amount	0...100	Amount of FX added to the direct signal
	Src	Off...Tempo	Table , "Dynamic Modulation sources," on page 26
	Amt	-100...+100	Amount of modulation source

094: Exciter - Limiter

This effect combines a mono exciter and a limiter. You can change the order of the effects.

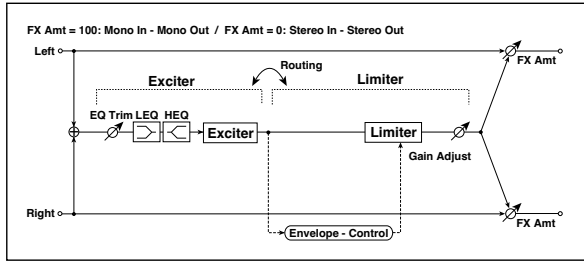

EXCITER			
a	[X]Exciter Blend	-100...+100	Sets the intensity (depth) of the Exciter effect
b	[X]Emphasis Frequency	0...70	Sets the frequency range to be emphasized
c	[X]Trim	0...100	Sets the EQ input level
d	[X]Pre LEQ Gain [dB]	-15...+15	Sets the gain of Low EQ
	Pre HEQ Gain [dB]	-15...+15	Sets the gain of High EQ
LIMITER			
e	[L]Ratio	1.0 : 1... 50.0 : 1, Inf : 1	Sets the signal compression ratio
f	[L]Threshold [dB]	-40...0	Sets the level above which the compressor is applied
g	[L]Attack	1...100	Sets the attack time
	Release	1...100	Sets the release time
h	[L]Gain Adjust [dB]	-Inf, -38...+24	Sets the limiter output gain
i	Routing	Exciter → Limiter, Limiter → Exciter	Switches the order of the exciter and limiter
j	FX Amount	0...100	Amount of FX added to the direct signal
	Src	Off...Tempo	Table, "Dynamic Modulation sources," on page 26
	Amt	-100...+100	Amount of modulation source

095: Exciter - Cho/Flng (Exciter - Chorus/Flanger)

This effect combines a mono limiter and a chorus/flanger.

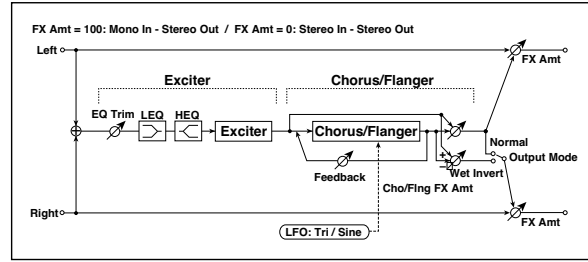

EXCITER			
a	[X]Exciter Blend	-100...+100	Sets the intensity (depth) of the Exciter effect
b	[X]Emphasis Frequency	0...70	Sets the frequency range to be emphasized
c	[X]Trim	0...100	Sets the EQ input level
d	[X]Pre LEQ Gain [dB]	-15...+15	Sets the gain of Low EQ
	Pre HEQ Gain [dB]	-15...+15	Sets the gain of High EQ
CHORUS/FLANGER			
e	[F]LFO Frequency [Hz]	0.02...20.00	Sets the speed of the LFO
	LFO Waveform	Triangle, Sine	Selects the LFO Waveform
f	[F]Delay Time [msec]	0.0...1350.0	Sets the delay time
	Depth	0...100	Sets the depth of LFO modulation
	Feedback	-100...+100	Sets the feedback amount
g	[F]Cho/Flng Wet/Dry	-100...0...100	Sets the effect balance of the chorus/flanger
	Src	Off...Tempo	Selects the Wet/Dry modulation source for the chorus/flanger
	Amt	-100...+100	Sets the Wet/Dry modulation amount for the chorus/flanger
h	[F]Output Mode	Normal, Wet Invert	Selects the output mode for the chorus/flanger
i	FX Amount	0...100	Amount of FX added to the direct signal
	Src	Off...Tempo	Table, "Dynamic Modulation sources," on page 26
	Amt	-100...+100	Amount of modulation source

096: Exciter - Phaser

This effect combines a mono limiter and a phaser.

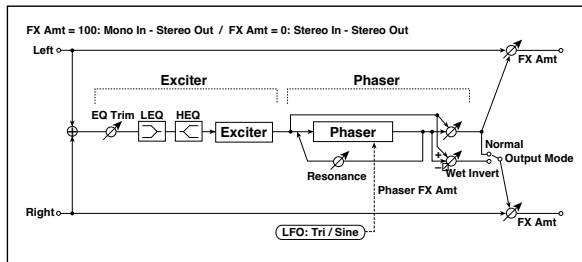

EXCITER			
a	[X]Exciter Blend	-100...+100	Sets the intensity (depth) of the Exciter effect
b	[X]Emphasis Frequency	0...70	Sets the frequency range to be emphasized
c	[X]Trim	0...100	Sets the EQ input level
d	[X]Pre LEQ Gain [dB]	-15...+15	Sets the gain of Low EQ
	Pre HEQ Gain [dB]	-15...+15	Sets the gain of High EQ
PHASER			
e	[P]LFO Frequency [Hz]	0.02...20.00	Sets the speed of the LFO
	LFO Waveform	Triangle, Sine	Selects the LFO Waveform
f	[P]Manual	0...100	Sets the frequency to which the effect is applied
	Depth	0...100	Sets the depth of LFO modulation
	Resonance	-100...+100	Sets the resonance amount
g	[P]Phaser Wet/Dry	-100...0...100	Sets the phaser effect balance
	Src	Off...Tempo	Selects the Wet/Dry modulation source for the phaser
	Amt	-100...+100	Sets the Wet/Dry modulation amount for the phaser
h	[P]Output Mode	Normal, Wet Invert	Selects the phaser output mode
i	FX Amount	0...100	Amount of FX added to the direct signal
	Src	Off...Tempo	Table , "Dynamic Modulation sources," on page 26
	Amt	-100...+100	Amount of modulation source

097: Exciter - Mt.Delay (Exciter - Multitap Delay)

This effect combines a mono exciter and a multitap delay.

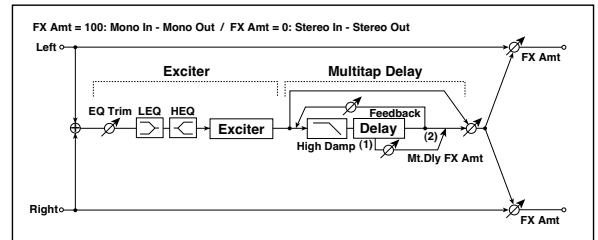

EXCITER			
a	[X]Exciter Blend	-100...+100	Sets the intensity (depth) of the Exciter effect
b	[X]Emphasis Frequency	0...70	Sets the frequency range to be emphasized
c	[X]Trim	0...100	Sets the EQ input level
d	[X]Pre LEQ Gain [dB]	-15...+15	Sets the gain of Low EQ
	Pre HEQ Gain [dB]	-15...+15	Sets the gain of High EQ
MULTITAP DELAY			
e	[D]Tap1 Time [msec]	0.0...1360.0	Sets the Tap1 delay time
	Tap1 Level	0...100	Sets the Tap1 output level
f	[D]Tap2 Time [msec]	0.0...1360.0	Sets the Tap2 delay time
	Feedback (Tap2)	-100...+100	Sets the Tap2 feedback amount
g	[D]High Damp [%]	0...100	Sets the damping amount in the high range
h	[D]Mt.Delay Wet/Dry	0...100	Sets the multitap delay effect balance
	Src	Off...Tempo	Selects the Wet/Dry modulation source for the multitap delay
	Amt	-100...+100	Sets the Wet/Dry modulation amount for the multitap delay
i	FX Amount	0...100	Amount of FX added to the direct signal
	Src	Off...Tempo	Table , "Dynamic Modulation sources," on page 26
	Amt	-100...+100	Amount of modulation source

098: OD/HG - Amp Sim (Overdrive/Hi.Gain - Amp Simulation)

This effect combines a mono overdrive/high-gain distortion and an amp simulation. You can change the order of the effects.

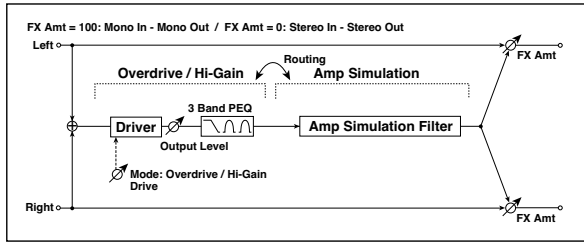

OD/HI-GAIN			
a	[O]Drive Mode	Overdrive, Hi-Gain	Switches between overdrive and high-gain distortion
	Drive	1...100	Sets the degree of distortion
b	[O]Output Level	0...50	Sets the overdrive output level
	Src	Off...Tempo	Selects the modulation source for the overdrive output level
	Amt	-50...+50	Sets the modulation amount of the overdrive output level
e	[O]Low Cutoff [Hz]	20...1.00k	Sets the center frequency for Low EQ (shelving type)
	Gain [dB]	-18...+18	Sets the gain of Low EQ
f	[O]Mid1 Cutoff [Hz]	300...10.00k	Sets the center frequency for Mid/High EQ 1 (peaking type)
	Q	0.5...10.0	Sets the band width of Mid/High EQ 1
	Gain [dB]	-18...+18	Sets the gain of Mid/High EQ 1
g	[O]Mid2 Cutoff [Hz]	500...20.00k	Sets the center frequency for Mid/High EQ 2 (peaking type)
	Q	0.5...10.0	Sets the band width of Mid/High EQ 2
	Gain [dB]	-18...+18	Sets the gain of Mid/High EQ 2
AMP SIM			
h	[A]Amplifier Type	SS, EL84, 6L6	Selects the type of guitar amplifie
i	Routing	OD/HG → Amp, Amp → OD/HG	Switches the order of the overdrive and amp
j	FX Amount	0...100	Amount of FX added to the direct signal
	Src	Off...Tempo	Table , "Dynamic Modulation sources," on page 26
	Amt	-100...+100	Amount of modulation source

099: OD/HG - Cho/Flng (Overdrive/Hi.Gain - Chorus/Flanger)

This effect combines a mono overdrive/high-gain distortion and a chorus/flanger. You can change the order of the effects.

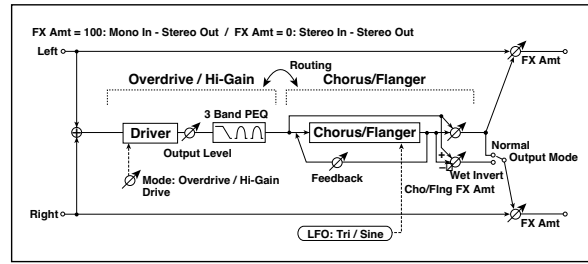

OD/HI-GAIN			
a	[O]Drive Mode	Overdrive, Hi-Gain	Switches between overdrive and high-gain distortion
	Drive	1...100	Sets the degree of distortion
b	[O]Output Level	0...50	Sets the overdrive output level
	Src	Off...Tempo	Selects the modulation source for the overdrive output level
	Amt	-50...+50	Sets the modulation amount of the overdrive output level
e	[O]Low Cutoff [Hz]	20...1.00k	Sets the center frequency for Low EQ (shelving type)
	Gain [dB]	-18...+18	Sets the gain of Low EQ
f	[O]Mid1 Cutoff [Hz]	300...10.00k	Sets the center frequency for Mid/High EQ 1 (peaking type)
	Q	0.5...10.0	Sets the band width of Mid/High EQ 1
	Gain [dB]	-18...+18	Sets the gain of Mid/High EQ 1
g	[O]Mid2 Cutoff [Hz]	500...20.00k	Sets the center frequency for Mid/High EQ 2 (peaking type)
	Q	0.5...10.0	Sets the band width of Mid/High EQ 2
	Gain [dB]	-18...+18	Sets the gain of Mid/High EQ 2
CHORUS/FLANGER			
h	[F]LFO Frequency [Hz]	0.02...20.00	Sets the speed of the LFO
	LFO Waveform	Triangle, Sine	Selects the LFO Waveform
i	[F]Delay Time [msec]	0.0...1350.0	Sets the delay time
	Depth	0...100	Sets the depth of LFO modulation
	Feedback	-100...+100	Sets the feedback amount
j	[F]Cho/Flng Wet/Dry	-100...0...100	Sets the effect balance of the chorus/flanger
	Src	Off...Tempo	Selects the Wet/Dry modulation source for the chorus/flanger
	Amt	-100...+100	Sets the Wet/Dry modulation amount for the chorus/flanger
k	[F]Output Mode	Normal, Wet Invert	Selects the output mode for the chorus/flanger
	Routing	OD/HG → Flanger, Flanger → OD/HG	Switches the order of the overdrive and chorus / flanger
l	FX Amount	0...100	Amount of FX added to the direct signal
	Src	Off...Tempo	Table , "Dynamic Modulation sources," on page 26
	Amt	-100...+100	Amount of modulation source

100: OD/HG - Phaser (Overdrive/Hi.Gain - Phaser)

This effect combines a mono overdrive/high-gain distortion and a phaser. You can change the order of the effects.

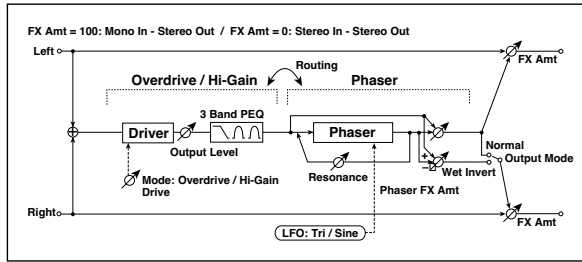

OD/HI-GAIN			
a	[O]Drive Mode	Overdrive, Hi-Gain	Switches between overdrive and high-gain distortion
	Drive	1...100	Sets the degree of distortion
b	[O]Output Level	0...50	Sets the overdrive output level D^{mod}
	Src	Off...Tempo	Selects the modulation source for the overdrive output level
	Amt	-50...+50	Sets the modulation amount of the overdrive output level
e	[O]Low Cutoff [Hz]	20...1.00k	Sets the center frequency for Low EQ (shelving type)
	Gain [dB]	-18...+18	Sets the gain of Low EQ
f	[O]Mid1 Cutoff [Hz]	300...10.00k	Sets the center frequency for Mid/High EQ 1 (peaking type)
	Q	0.5...10.0	Sets the band width of Mid/High EQ 1
	Gain [dB]	-18...+18	Sets the gain of Mid/High EQ 1
g	[O]Mid2 Cutoff [Hz]	500...20.00k	Sets the center frequency for Mid/High EQ 2 (peaking type)
	Q	0.5...10.0	Sets the band width of Mid/High EQ 2
	Gain [dB]	-18...+18	Sets the gain of Mid/High EQ 2
PHASER			
h	[P]LFO Frequency [Hz]	0.02...20.00	Sets the speed of the LFO
	LFO Waveform	Triangle, Sine	Selects the LFO Waveform
i	[P]Manual	0...100	Sets the frequency to which the effect is applied
	Depth	0...100	Sets the depth of LFO modulation
	Resonance	-100...+100	Sets the resonance amount
j	[P]Phaser Wet/Dry	-100...0...100	Sets the phaser effect balance D^{mod}
	Src	Off...Tempo	Selects the Wet/Dry modulation source for the phaser
	Amt	-100...+100	Sets the Wet/Dry modulation amount for the phaser
k	[P]Output Mode	Normal, Wet Invert	Selects the phaser output mode
	Routing	OD/HG → Phaser, Phaser → OD/HG	Switches the order of the overdrive and phaser
l	FX Amount	0...100	Amount of FX added to the direct signal D^{mod}
	Src	Off...Tempo	Table , "Dynamic Modulation sources," on page 26
	Amt	-100...+100	Amount of modulation source

101: OD/HG - Mt.Delay (Overdrive/Hi.Gain - Multitap Delay)

This effect combines a mono overdrive/high-gain distortion and a multitap delay.

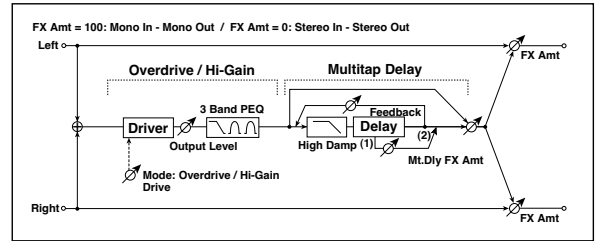

OD/HI-GAIN			
a	[O]Drive Mode	Overdrive, Hi-Gain	Switches between overdrive and high-gain distortion
	Drive	1...100	Sets the degree of distortion
b	[O]Output Level	0...50	Sets the overdrive output level D^{mod}
	Src	Off...Tempo	Selects the modulation source for the overdrive output level
	Amt	-50...+50	Sets the modulation amount of the overdrive output level
e	[O]Low Cutoff [Hz]	20...1.00k	Sets the center frequency for Low EQ (shelving type)
	Gain [dB]	-18...+18	Sets the gain of Low EQ
f	[O]Mid1 Cutoff [Hz]	300...10.00k	Sets the center frequency for Mid/High EQ 1 (peaking type)
	Q	0.5...10.0	Sets the band width of Mid/High EQ 1
	Gain [dB]	-18...+18	Sets the gain of Mid/High EQ 1
g	[O]Mid2 Cutoff [Hz]	500...20.00k	Sets the center frequency for Mid/High EQ 2 (peaking type)
	Q	0.5...10.0	Sets the band width of Mid/High EQ 2
	Gain [dB]	-18...+18	Sets the gain of Mid/High EQ 2
MULTITAP DELAY			
h	[D]Tap1 Time [msec]	0.0...1360.0	Sets the Tap1 delay time
	Tap1 Level	0...100	Sets the Tap1 output level
i	[D]Tap2 Time [msec]	0.0...1360.0	Sets the Tap2 delay time
	Feedback	-100...+100	Sets the Tap2 feedback amount
j	[D]High Damp [%]	0...100	Sets the damping amount in the high range
	[D]Mt.Delay Wet/Dry	0...100	Sets the multitap delay effect balance D^{mod}
k	Src	Off...Tempo	Selects the Wet/Dry modulation source for the multitap delay
	Amt	-100...+100	Sets the Wet/Dry modulation amount for the multitap delay
	FX Amount	0...100	Amount of FX added to the direct signal D^{mod}
l	Src	Off...Tempo	Table , "Dynamic Modulation sources," on page 26
	Amt	-100...+100	Amount of modulation source

102: Wah - Amp Sim (Wah - Amp Simulation)

This effect combines a mono wah and an amp simulation. You can change the order of the effects.

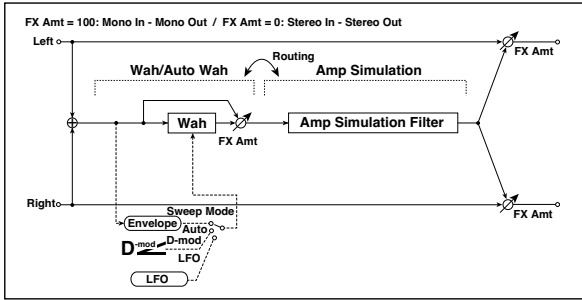

WAH				
a	[W] Frequency Bottom	0...100	Sets the lower limit of the wah center frequency	
	Frequency Top	0...100	Sets the upper limit of the wah center frequency	
b	[W] Sweep Mode	Auto, D-mod, LFO	Selects the control from auto-wah, modulation source, and LFO	
	Src	Off...Tempo	Selects the modulation source for the wah when Sweep Mode=D-mod	
c	[W] LFO Frequency [Hz]	0.02...20.00	Sets the speed of the LFO	
	Resonance	0...100	Sets the resonance amount	
	LPF	Off, On	Switches the wah low pass filter on and off	
d	[W] Wet/Dry	0...100	Sets the wah effect balance	
	Src	Off...Tempo	Selects the Wet/Dry modulation source for the wah	
	Amt	-100...+100	Sets the Wet/Dry modulation amount for the wah	
AMP SIM				
e	[A] Amplifier Type	SS, EL84, 6L6	Selects the type of guitar amplifier	
f	Routing	Wah → Amp, Amp → Wah	Switches the order of the wah and amp simulation	
g	FX Amount	0...100	Amount of FX added to the direct signal	
	Src	Off...Tempo	Table, "Dynamic Modulation sources," on page 26	
	Amt	-100...+100	Amount of modulation source	

103: Decimator - Amp (Decimator - Amp Simulation)

This effect combines a mono decimator and an amp simulation. You can change the order of the effects.

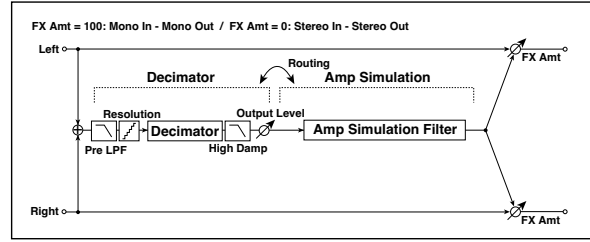

DECIMATOR				
a	[D] Pre LPF	Off, On	Turn the harmonic noise caused by lowered sampling on and off	
	High Damp [%]	0...100	Sets the ratio of high-range damping	
b	[D] Sampling Freq [Hz]	1.00k...48.00k	Sets the sampling frequency	
	Resolution	4...24	Sets the data bit length	
c	[D] Output Level	0...100	Sets the decimator output level	
AMP SIM				
d	[A] Amplifier Type	SS, EL84, 6L6	Selects the type of guitar amplifier	
e	Routing	Decimator → Amp, Amp → Decimator	Switches the order of the decimator and amp simulation	
f	FX Amount	0...100	Amount of FX added to the direct signal	
	Src	Off...Tempo	Table, "Dynamic Modulation sources," on page 26	
	Amt	-100...+100	Amount of modulation source	

104: Decimator - Comp (Decimator - Compressor)

This effect combines a mono decimator and a compressor. You can change the order of the effects.

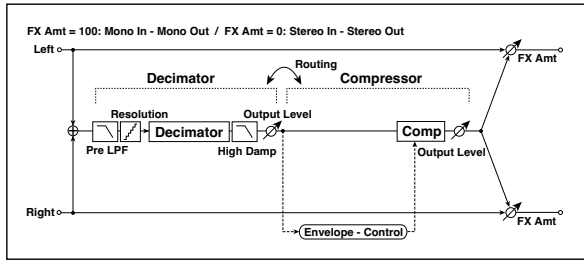

DECIMATOR			
a	[D]Pre LPF	Off, On	Turn the harmonic noise caused by lowered sampling on and off
	High Damp [%]	0...100	Sets the ratio of high-range damping
	[D]Sampling Freq [Hz]	1.00k...48.00k	Sets the sampling frequency
b	Resolution	4...24	Sets the data bit length
	[D]Output Level	0...100	Sets the decimator output level
COMPRESSOR			
d	[C]Sensitivity	1...100	Sets the sensitivity
e	[C]Attack	1...100	Sets the attack level
	Output Level	0...100	Sets the compressor output level
f	Routing	Decimator → Comp, Comp → Decimator	Switches the order of the decimator and compressor
g	FX Amount	0...100	Amount of FX added to the direct signal
	Src	Off...Tempo	Table, "Dynamic Modulation sources," on page 26
	Amt	-100...+100	Amount of modulation source

105: AmpSim - Tremolo (Amp Simulation- Tremolo)

This effect combines a mono amp simulation and a tremolo.

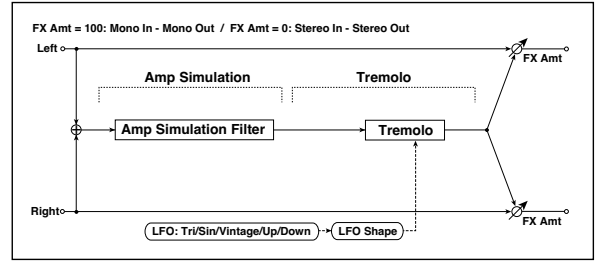

AMP SIM			
a	[A]Amplifier Type	SS, EL84, 6L6	Selects the type of guitar amplifier
TREMLO			
b	[T]LFO Waveform	Triangle, Sine, Vintage, Up, Down	Selects the LFO Waveform
	LFO Shape	-100...+100	Changes the curvature of the LFO Waveform
c	[T]LFO Frequency [Hz]	0.02...20.00	Sets the speed of the LFO
d	[T]Depth	0...100	Sets the depth of LFO modulation
e	FX Amount	0...100	Amount of FX added to the direct signal
	Src	Off...Tempo	Table, "Dynamic Modulation sources," on page 26
	Amt	-100...+100	Amount of modulation source

106: Cho/Flng - Mt.Dly (Chorus/Flanger - Multitap Delay)

This effect combines a mono chorus/flanger and a multitap delay.

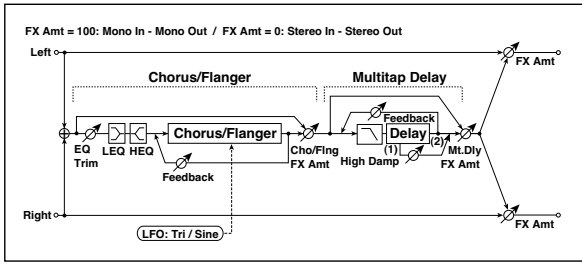

CHORUS/FLANGER				
a	[F]LFO Frequency [Hz]	0.02...20.00	Sets the speed of the LFO	
	LFO Waveform	Triangle, Sine	Selects the LFO Waveform	
b	[F]Delay Time [msec]	0.0...1350.0	Sets the delay time	
	Depth	0...100	Sets the depth of LFO modulation	
	Feedback	-100...+100	Sets the feedback amount	
c	[F]EQ Trim	0...100	Sets the EQ input level	
d	[F]PreLEQ Gain [dB]	-15...+15	Sets the gain of Low EQ	
	PreHEQ Gain [dB]	-15...+15	Sets the gain of High EQ	
e	[F]Cho/Flng Wet/Dry	-Wet...-1 : 99, Dry, 1 : 99...Wet	Sets the effect balance of the chorus/flanger	
MULTITAP DELAY				
a	[D]Tap1 Time [msec]	0.0...1360.0	Sets the Tap1 delay time	
	Tap1 Level	0...100	Sets the Tap1 output level	
b	[D]Tap2 Time [msec]	0.0...1360.0	Sets the Tap2 delay time	
	Feedback	-100...+100	Sets the Tap2 feedback amount	
c	[D]High Damp [%]	0...100	Sets the damping amount in the high range	
d	[D]Mt.Delay Wet/Dry	0...100	Sets the multitap delay effect balance	
	Src	Off...Tempo	Selects the Wet/Dry modulation source for the multitap delay	
	Amt	-100...+100	Sets the Wet/Dry modulation amount for the multitap delay	
e	FX Amount	0...100	Amount of FX added to the direct signal	
	Src	Off...Tempo	Table , "Dynamic Modulation sources," on page 26	
	Amt	-100...+100	Amount of modulation source	

107: Phaser - Cho/Flng (Phaser - Chorus/Flanger)

This effect combines a mono phaser and a chorus/flanger.

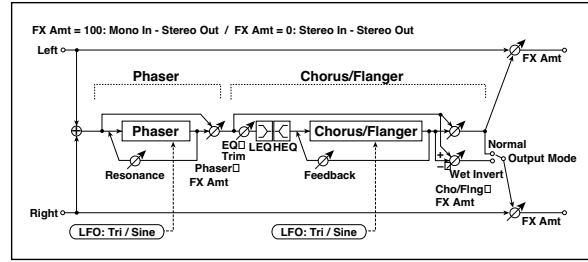

PHASER				
a	[P]LFO Frequency [Hz]	0.02...20.00	Sets the speed of the LFO	
	LFO Waveform	Triangle, Sine	Selects the LFO Waveform	
b	[P]Manual	0...100	Sets the frequency to which the effect is applied	
	Depth	0...100	Sets the depth of LFO modulation	
	Resonance	-100...+100	Sets the resonance amount	
c	[P]Phaser Wet/Dry	-100...0...100	Sets the phaser effect balance	
CHORUS/FLANGER				
d	[F]LFO Frequency [Hz]	0.02...20.00	Sets the speed of the LFO	
	LFO Waveform	Triangle, Sine	Selects the LFO Waveform	
e	[F]Delay Time [msec]	0.0...1350.0	Sets the delay time	
	Depth	0...100	Sets the depth of LFO modulation	
	Feedback	-100...+100	Sets the feedback amount	
f	[F]EQ Trim	0...100	Sets the EQ input level	
g	[F]PreLEQ Gain [dB]	-15...+15	Sets the gain of Low EQ	
	PreHEQ Gain [dB]	-15...+15	Sets the gain of High EQ	
h	[F]Cho/Flng Wet/Dry	-100...0...100	Sets the effect balance of the chorus/flanger	
	Src	Off...Tempo	Selects the Wet/Dry modulation source for the chorus/flanger	
	Amt	-100...+100	Sets the Wet/Dry modulation amount for the chorus/flanger	
i	[F]Output Mode	Normal, Wet Invert	Selects the output mode for the chorus/flanger	
j	FX Amount	0...100	Amount of FX added to the direct signal	
	Src	Off...Tempo	Table , "Dynamic Modulation sources," on page 26	
	Amt	-100...+100	Amount of modulation source	

108: Reverb - Gate

This effect combines a mono reverb and a gate.

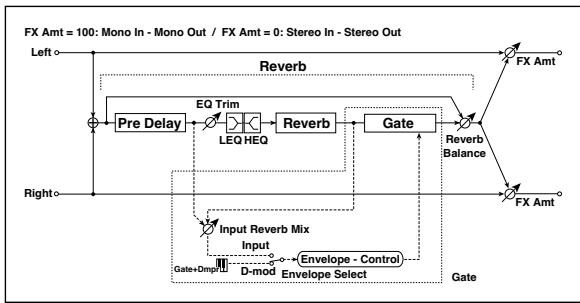

REVERB				
a	[R]Reverb Time [sec]	0.1...10.0	Sets the reverberation time	
	High Damp [%]	0...100	Sets the damping amount in the high range	
b	[R]Pre Delay [msec]	0...200	Sets the delay time of the reverb sound and gate control signal	
c	[R]EQ Trim	0...100	Sets the EQ input level	
	Reverb Balance	0...100	Sets the reverb effect balance	
d	[R]PreLEQ Fc	Low, Mid-Low	Selects the cutoff frequency (low or mid-low) of the low-range equalizer	
	Pre HEQ Fc	High, Mid-High	Selects the cutoff frequency (high or mid-high) of the high-range equalizer	
e	[R]PreLEQ Gain [dB]	-15.0...+15.0	Sets the gain of Low EQ	
	Pre HEQ Gain [dB]	-15.0...+15.0	Sets the gain of High EQ	
GATE				
f	[G]Envelope Select	D-mod, Input	Switches between modulation source control and input signal control	
	Src	Off...Tempo	Selects the modulation source that controls the gate when Envelope Select is set to D-mod	
g	[G]Input Reverb Mix	0...100	Sets the balance between the dry and reverb sounds of the gate control signal	
	Threshold	0...100	Sets the gate threshold level	
h	[G]Polarity	+, -	Switches between non-invert and invert of the gate on/off state	
i	[G]Attack	1...100	Sets the attack time	
	Release	1...100	Sets the release time	
j	FX Amount	0...100	Amount of FX added to the direct signal	
	Src	Off...Tempo	Table, "Dynamic Modulation sources," on page 26	
	Amt	-100...+100	Amount of modulation source	

f: [G]Envelope Select

f: Src

g: [G]Input Reverb Mix

g: Threshold

The “[G]Envelope Select” parameter enables you to select whether turning the gate on and off is triggered by the input signal level or controlled directly by the modulation source. You can select from Off to Tempo for the Src parameter to specify the modulation source.

When “[G]Envelope Select” is set to Input, the gate is controlled by the level of signals that are the combination of the dry sound and the reverb sound. When the signal level exceeds the threshold, the gate opens and the reverb sound is output.

Normally, set “[G]Input Reverb Mix” to Dry (the gate is controlled only by the dry sound). If you wish to extend the gate time, set the “[G]Input Reverb Mix” value higher and adjust the “Threshold” value.

Double Size

Double-size effects can be used only with FX processors B and D.

109: St. Mltband Limiter (Stereo Mltband Limiter)

This is a stereo multiband limiter.

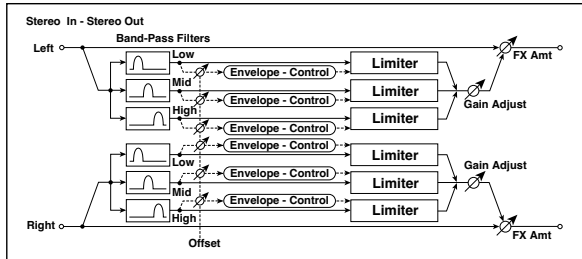

a	Ratio	1.0 : 1... 50.0 : 1, Inf : 1	Sets the signal compression ratio	
b	Threshold [dB]	-40...0	Sets the level above which the compressor is applied	
c	Attack	1...100	Sets the attack time	
d	Release	1...100	Sets the release time	
e	Low Offset [dB]	-40...0	Sets the low range gain of trigger signal	
f	Mid Offset [dB]	-40...0	Sets the mid range gain of trigger signal	
g	High Offset [dB]	-40...0	Sets the high range gain of trigger signal	
h	Gain Adjust [dB]	-Inf, -38...+24	Sets the output gain	
	Src	Off...Tempo	Selects the modulation source for the output gain	
	Amt	-63...+63	Sets the modulation amount of the output gain	
i	FX Amount	0...100	Amount of FX added to the direct signal	
	Src	Off...Tempo	Table, "Dynamic Modulation sources," on page 26	
	Amt	-100...+100	Amount of modulation source	

110: PianoBody/Damper (PianoBody/Damper Simulation)

This effect simulates the resonance of the piano sound board caused by the string vibration, and also simulates the resonance of other strings that are not being played when you press the damper pedal. It will create a very realistic sound when applied to acoustic piano sounds.

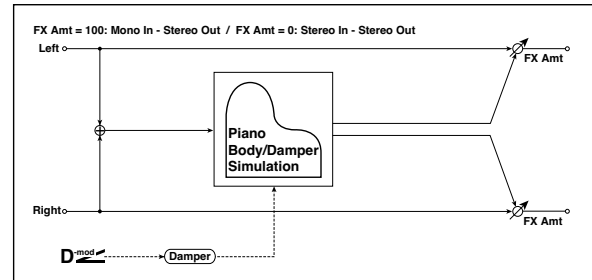

a	Sound Board Depth	0...100	Sets the intensity of resonance of the sound board	
b	Damper Depth	0...100	Sets the intensity of the string resonance created when the damper pedal is pressed	
	Src	Off...Tempo	Selects the modulation source of damper effect	
c	Tone	1...100	Sets tonal quality of effect sound	
d	Mid Shape	0...36	Sets the mid range of tonal quality	
e	Tune	-50...+50	Fine tuning	
f	FX Amount	0...100	Amount of FX added to the direct signal	
	Src	Off...Tempo	Table, "Dynamic Modulation sources," on page 26	
	Amt	-100...+100	Amount of modulation source	

a: Sound Board Depth

This parameter sets the intensity of resonance of the piano sound board.

b: Damper Depth

b: Src

This parameter sets the resonance intensity of the other strings created when the damper pedal is pressed. The "Src" parameter selects the modulation source from which the damper effect is applied. Usually, select Damper #64 Pdl (Damper pedal).

The effect is off when a value for the modulation source specified for the "Src" parameter is 63 or smaller, and the effect is on when the value is 64 or higher.

c: Tone

d: Mid Shape

These parameters control the tonal quality of the effect sound.

e: Tune

Since this effect simulates the resonance of the strings, the sound varies depending on the pitch. If you have changed tuning using the "Master Tuning" (Global > General Controls > Basic), adjust this parameter value.

111: OD/HyperGain Wah (Overdrive/Hyper Gain Wah)

This distortion effect has two modes: overdrive and hyper-gain that produces a strong distortion. A higher high-gain setting is required for this effect relative to a normal-size effect.

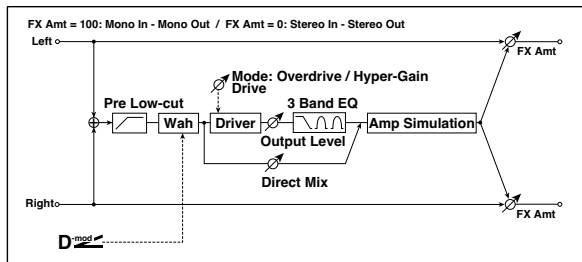

a	Wah	Off, On	Switches Wah on/off	D ^{mod}
	Src	Off...Tempo	Selects the modulation source that switches the Wah on and off	
	Sw	Toggle, Moment	Selects the switching mode for the modulation source that switches the Wah on and off	
b	Wah Sweep Range	-10...+10	Sets the range of Wah	D ^{mod}
	Wah Sweep Src	Off...Tempo	Selects the modulation source that controls the Wah	
c	Drive Mode	Overdrive, Hyper-Gain	Switches between overdrive and hi-gain distortion	D ^{mod}
	Drive	1...120	Sets the degree of distortion	
d	Pre Low-cut	0...10	Sets the low range cut amount of the distortion input	D ^{mod}
	Output Level	0...50	Sets the output level	
	Src	Off...Tempo	Selects the modulation source for the output level	
e	Amt	-50...+50	Sets the modulation amount of the output level	D ^{mod}
	Low Cutoff [Hz]	20...1.00k	Sets the center frequency for Low EQ (shelving type)	
f	Gain [dB]	-18...+18	Sets the gain of Low EQ	D ^{mod}
	Mid1 Cutoff [Hz]	300...10.00k	Sets the center frequency for Mid/High EQ 1 (peaking type)	
	Q	0.5...10.0	Sets the band width of Mid/High EQ 1	
g	Gain [dB]	-18...+18	Sets the gain of Mid/High EQ 1	D ^{mod}
	Mid2 Cutoff [Hz]	500...20.00k	Sets the center frequency for Mid/High EQ 2 (peaking type)	
	Q	0.5...10.0	Sets the band width of Mid/High EQ 2	
h	Gain [dB]	-18...+18	Sets the gain of Mid/High EQ 2	D ^{mod}
	Direct Mix	0...50	Sets the amount of the dry sound mixed to the distortion	
	Speaker Simulation	Off, On	Switches the speaker simulation on/off	
i	FX Amount	0...100	Amount of FX added to the direct signal	D ^{mod}
	Src	Off...Tempo	Table, "Dynamic Modulation sources," on page 26	
	Amt	-100...+100	Amount of modulation source	

112: GuitarAmp + P4EQ (Guitar Amp Model + Parametric 4-Band EQ)

This combines a guitar amp simulation (which even faithfully replicates the distortion and tone control circuitry) with a four-band equalizer.

By using this in conjunction with "019: St. Guitar Cabinet (Stereo Guitar Cabinet)" on page 40, you can obtain an even more realistic guitar sound that simulates a guitar amp + speaker cabinet.

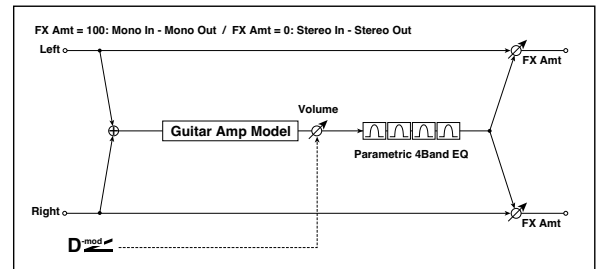

a	Amp Type	VOX AC15, VOX AC15TB, VOX AC30, VOX AC30TB, UK BLUES, UK 70'S, UK 80'S, UK 90'S, UK MODERN, US MODERN, US HIGAIN, BOUTIQUE OD, BOUTIQUE CL, BLACK 2x12, TWEED - 1x12, TWEED - 4x10	Selects the type of the amplifier	D ^{mod}
	Drive Gain	0...100	Sets the input gain	
b	Volume	0...100	Sets the output level	D ^{mod}
	Src	Off...Tempo	Selects the modulation source for the output level	
	Amt	-100...+100	Sets the modulation amount of the output level	
c	Bass	0...100	Sets the bass (low range) level	D ^{mod}
	Middle	0...100	Sets the middle (mid range) level	
d	Treble	0...100	Sets the treble (high range) level	D ^{mod}
	Presence	0...100	Sets the presence (high-frequency tone)	
e	Post P4EQ	Thru, On	Selects through or on for the equalizer	D ^{mod}
	Band1 Cutoff [Hz]	20...1.00k	Sets the center frequency of Band 1	
	Q	0.5...10.0	Sets Band 1's bandwidth	
f	Gain [dB]	-18...+18	Sets the gain of Band 1	D ^{mod}
	Band2 Cutoff [Hz]	50...5.00k	Sets the center frequency of Band 2	
	Q	0.5...10.0	Sets Band 2's bandwidth	
g	Gain [dB]	-18...+18	Sets the gain of Band 2	D ^{mod}
	Band3 Cutoff [Hz]	300...10.00k	Sets the center frequency of Band 3	
	Q	0.5...10.0	Sets Band 3's bandwidth	
h	Gain [dB]	-18...+18	Sets the gain of Band 3	D ^{mod}
	Band4 Cutoff [Hz]	500...20.00k	Sets the center frequency of Band 4	
	Q	0.5...10.0	Sets Band 4's bandwidth	
i	Gain [dB]	-18...+18	Sets the gain of Band 4	D ^{mod}
	FX Amount	0...100	Amount of FX added to the direct signal	
	Src	Off...Tempo	Table, "Dynamic Modulation sources," on page 26	
j	Amt	-100...+100	Amount of modulation source	D ^{mod}

a: Amp Type

d: Presence

If the Amp Type is VOX AC15...VOX AC30TB, this sets the attenuation of the high-frequency range. For other types, this sets the boost of the high-frequency range.

This corresponds to the Cut knob control of amps made by the VOX Corporation.

e: Post P4EQ

By chaining this with 19: St.Guitar Cabinet you can simulate the combination of a guitar amp and speaker cabinet. In this case, we recommend that you set Post P4EQ to “Thru,” but if necessary you can turn it “On” and adjust the tone.

Recommended Combinations of Guitar Amp Models and Cabinet Simulators:

Amp Type	Cabinet Type
VOX AC15	VOX AC15 - 1x12
VOX AC15TB	VOX AC15 - 1x12
VOX AC30	VOX AC30 - 2x12
VOX AC30TB	VOX AC30 - 2x12
UK BLUES	UK H30 - 4x12
UK 70'S	UK H30 - 4x12
UK 80'S	UK T75 - 4x12
UK 90'S	UK T75 - 4x12
UK MODERN	UK T75 - 4x12, US V30 - 4x12
US MODERN	US V30 - 4x12
US HIGAIN	US V30 - 4x12, UK T75 - 4x12
BOUTIQUE OD	UK H30 - 4x12
BOUTIQUE CL	UK H30 - 4x12
BLACK 2x12	BLACK - 2x12
TWEED - 1x12	TWEED - 1x12
TWEED - 4x10	TWEED - 4x10

113: BassTubeAmp+Cab.
(Bass Tube Amp Model + Cabinet)

This simulates a bass amp (with gain and drive) and speaker cabinet.

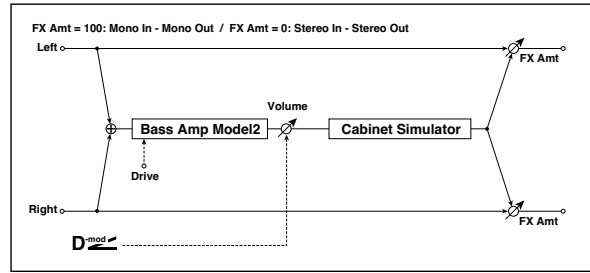

a	Amp Type	STUDIO COMBO VOX AC100 UK MAJOR	Selects the type of the amplifier A tube combo ideal for the Motown sound A 100W tube amp AC100 made by Vox A 200W tube amp made in the UK	
b	Drive Gain	0...100	Sets the input gain	
c	Volume	0...100	Sets the output level	D-mod
	Src	Off...Tempo	Selects the modulation source for the output level	
	Amt	-100...+100	Sets the modulation amount of the output level	
d	Bass	0...100	Sets the bass (low range) level	
e	Middle	0...100	Sets the middle (mid range) level	
f	Treble	0...100	Sets the treble (high range) level	
g	Presence	0...100	Sets the presence (high-frequency tone)	
h	Cabinet Simulator	Off, On	Switches the cabinet simulator on/off	
i	Cabinet Type	LA - 4x10, MODERN - 4x10, METAL - 4x10, CLASSIC - 8x10, UK - 4x12, STUDIO - 1x15, JAZZ - 1x15, VOX AC100 - 2x15, US - 2x15, UK - 4x15, LA - 1x18, COMBI - 1x12 & 1x18	Selects the cabinet type	
j	FX Amount	0...100	Amount of FX added to the direct signal	D-mod
	Src	Off...Tempo	Table , "Dynamic Modulation sources," on page 26	
	Amt	-100...+100	Amount of modulation source	

a: Amp Type

i: Cabinet Type

Recommended Combinations of Bass Amp Models and Cabinets:

Amp Type	Cabinet Type
STUDIO COMBO	STUDIO - 1x15
AC100	VOX AC100 - 2x15
UK MAJOR	UK - 4x15, UK - 4x12

114: St. Mic + PreAmp (Stereo Mic Modeling + PreAmp)

This is a stereo mic and preamp simulator (See “025: Mic Model+PreAmp (Mic Modeling + PreAmp)” on page 43.). For example you might use this to simulate micing of a stereo source such as a rotary speaker.

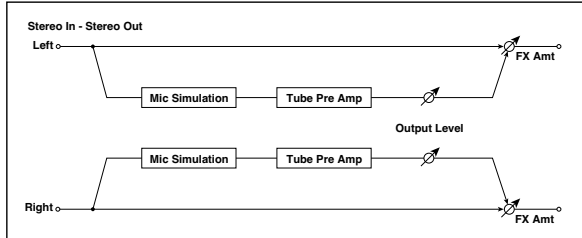

115: Multitap Cho/Delay (Multitap Chorus/Delay)

This effect has six chorus blocks with different LFO phases. You can produce a complex stereo image by setting a different delay time and depth for each block. You can control the delay output level via a modulation source.

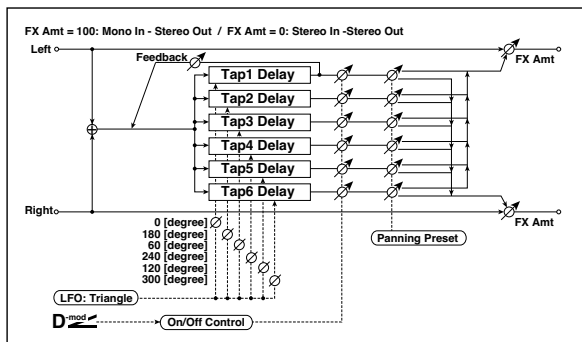

a	LFO Frequency [Hz]	0.02...13.00	Sets the speed of the LFO	
b	Tap1 (000) [msec]	0...2000	Sets the Tap1 (LFO phase=0 degrees) delay time	
	Depth	0...30	Sets the Tap1 chorus depth	
	Status	Always On, Always Off, On→Off (Dm), Off→On (Dm)	Selects on, off, or modulation source for the control of Tap1 output	
c	Tap2 (180) [msec]	0...2000	Sets the Tap2 (LFO phase=180 degrees) delay time	
	Depth	0...30	Sets the Tap2 chorus depth	
	Status	Always On, Always Off, On→Off (Dm), Off→On (Dm)	Selects on, off, or modulation source for the control of Tap2 output	
d	Tap3 (060) [msec]	0...2000	Sets the Tap3 (LFO phase=60 degrees) delay time	
	Depth	0...30	Sets the Tap3 chorus depth	
	Status	Always On, Always Off, On→Off (Dm), Off→On (Dm)	Selects on, off, or modulation source for the control of Tap3 output	
e	Tap4 (240) [msec]	0...2000	Sets the Tap4 (LFO phase=240 degrees) delay time	
	Depth	0...30	Sets the Tap4 chorus depth	
	Status	Always On, Always Off, On→Off (Dm), Off→On (Dm)	Selects on, off, or modulation source for the control of Tap4 output	

f	Tap5 (120) [msec]	0...2000	Sets the Tap5 (LFO phase=120 degrees) delay time	
	Depth	0...30	Sets the Tap5 chorus depth	
	Status	Always On, Always Off, On→Off (Dm), Off→On (Dm)	Selects on, off, or modulation source for the control of Tap5 output	
g	Tap6 (300) [msec]	0...2000	Sets the Tap6 (LFO phase=300 degrees) delay time	
	Depth	0...30	Sets the Tap6 chorus depth	
	Status	Always On, Always Off, On→Off (Dm), Off→On (Dm)	Selects on, off, or modulation source for the control of Tap6 output	
h	Panning Preset	1: L 1 2 3 4 5 6 R, 2: L 1 3 5 2 4 6 R, 3: L 1 3 5 2 4 6 R, 4: L 1 4 5 6 3 2 R	Selects the stereo panning pattern for each tap	
i	Tap1 Feedback	-100...+100	Sets the Tap1 feedback amount	D ^{mod}
	Src	Off...Tempo	Selects the modulation source for the Tap output level, feedback amount, and effect balance	
	Amt	-100...+100	Sets the modulation amount of Tap1 feedback amount	
j	FX Amount	0...100	Amount of FX added to the direct signal	D ^{mod}
	Src	Off...Tempo	Table, "Dynamic Modulation sources," on page 26	
	Amt	-100...+100	Amount of modulation source	

b, c, d, e, f, g: Status

These parameters set the output status of each Tap.

Always On: Output is always on. (No modulation)

Always Off: Output is always off. (No modulation)

On→Off (dm): Output level is switched from on to off depending on the modulation source.

Off→On (dm): Output level is switched from off to on depending on the modulation source.

Combining these parameters, you can change from 4-phase chorus to two-tap delay by crossfading them gradually via the modulation source during a performance.

h: Panning Preset

This parameter selects combinations of stereo images of the tap outputs.

116: St. Pitch Shifter (Stereo Pitch Shifter)

This is a stereo pitch shifter. The pitch shift amount for the left and right channels can be reversed from each other.

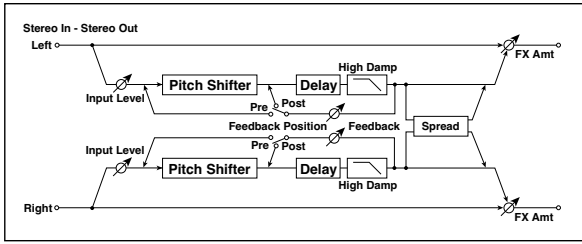

	Mode	Slow, Medium, Fast	Switches Pitch Shifter mode	
a	L/R Pitch	Normal, Up/Down	Determines whether or not the L/R pitch shift amount is inverted	
b	Pitch Shift [1/2tone]	-24...+24	Sets the pitch shift amount in steps of a semitone	
	Src	Off...Tempo	Selects the modulation source of pitch shift amount	
c	Amt	-24...+24	Sets the modulation amount of pitch shift amount	
	Fine [cents]	-100...+100	Sets the pitch shift amount in steps of one cent	
d	Amt	-100...+100	Sets the modulation amount of pitch shift amount	
	L Delay [msec]	0...2000	Sets the delay time for the left channel	
e	R Delay [msec]	0...2000	Sets the delay time for the right channel	
f	Feedback	-100...+100	Sets the feedback amount	
	High Damp [%]	0...100	Sets the damping amount in the high range	
g	Feedback Position	Pre, Post	Switches the feedback connection	
	Spread	-100...+100	Sets the width of the stereo image of the effect sound	
h	Input Level Dmod [%]	-100...+100	Sets the modulation amount of the input level	
	Src	Off...Tempo	Selects the modulation source for the input level	
i	FX Amount	0...100	Amount of FX added to the direct signal	
	Src	Off...Tempo	Table, "Dynamic Modulation sources," on page 26	
j	Amt	-100...+100	Amount of modulation source	

a: L/R Pitch

When you select Up/Down for this parameter, the pitch shift amount for the right channel will be reversed. If the pitch shift amount is positive, the pitch of the left channel is raised, and the pitch of the right channel is lowered.

117: St. PitchShift BPM (Stereo Pitch Shifter BPM)

This stereo pitch shifter enables you to set the delay time to match the song tempo.

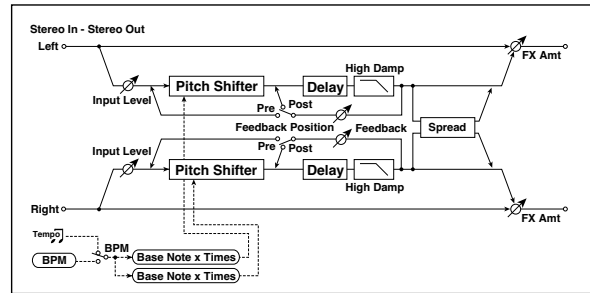

	Mode	Slow, Medium, Fast	Switches Pitch Shifter mode	
a	L/R Pitch	Normal, Up/Down	Determines whether or not the L/R pitch shift amount is inverted	
b	Pitch Shift [1/2tone]	-24...+24	Sets the pitch shift amount in steps of a semitone	
	Src	Off...Tempo	Selects the modulation source of pitch shift amount	
c	Amt	-24...+24	Sets the modulation amount of pitch shift amount	
	Fine [cents]	-100...+100	Sets the pitch shift amount in steps of one cent	
d	Amt	-100...+100	Sets the modulation amount of pitch shift amount	
	BPM	MIDI, 40.00... 300.00	MIDI syncs to the system tempo; 40-300 sets the tempo manually for this individual effect	
e	Time Over? L	---, OVER!	Display the error message if the left channel delay time exceeds the upper limit	
	R	---, OVER!	Display the error message if the right channel delay time exceeds the upper limit	
f	L Delay Base Note		Selects the type of notes to specify the left channel delay time	
	Times	x1...x32	Sets the number of notes to specify the left channel delay time	
g	R Delay Base Note		Selects the type of notes to specify the right channel delay time	
	Times	x1...x32	Sets the number of notes to specify the right channel delay time	
h	Feedback Position	Pre, Post	Switches the feedback connection	
	Spread	-100...+100	Sets the width of the stereo image of the effect sound	
i	Feedback	-100...+100	Sets the feedback amount	
	High Damp [%]	0...100	Sets the damping amount in the high range	
j	Input Level Dmod [%]	-100...+100	Sets the modulation amount of the input level	
	Src	Off...Tempo	Selects the modulation source for the input level	
k	FX Amount	0...100	Amount of FX added to the direct signal	
	Src	Off...Tempo	Table, "Dynamic Modulation sources," on page 26	
l	Amt	-100...+100	Amount of modulation source	

118: Rotary SpeakerOD (Rotary Speaker Overdrive)

This is a stereo rotary speaker effect. It has an internal speaker simulator that simulates overdrive (recreating the amp distortion) and characteristics of the rotary speaker, producing a very realistic rotary speaker sound.

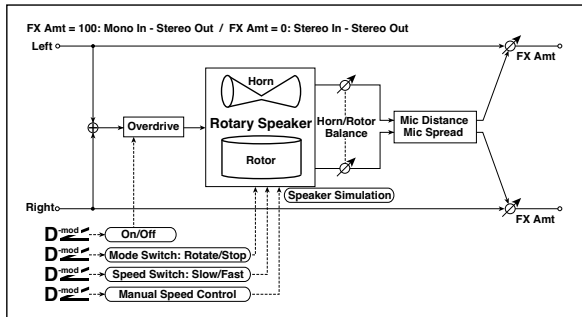

a	Overdrive	Off, On	Switches overdrive on/off	
	Src	Off...Tempo	Selects a modulation source to switch overdrive on/off	
	Sw	Toggle, Moment	Sets the switch mode for overdrive on/off modulation	
b	Overdrive Gain	0...100	Determines the degree of distortion	
	Overdrive Level	0...100	Sets the overdrive output level	
c	Overdrive Tone	0...15	Sets the tonal quality of the overdrive	
	Speaker Simulator	Off, On	Switches the speaker simulation on/off	
d	Mode Switch	Rotate, Stop	Switches between speaker rotation and stop	D ^{mod}
	Src	Off...Tempo	Selects a modulation source for Rotate/Stop	
	Sw	Toggle, Moment	Sets the switch mode for Rotate/Stop modulation	
e	Speed Switch	Slow, Fast	Switches the speaker rotation speed between slow and fast	D ^{mod}
	Src	Off...Tempo	Selects a modulation source for Slow/Fast	
	Sw	Toggle, Moment	Sets the switch mode for Slow/Fast modulation	
f	Horn/Rotor Balance	Rotor, 1...99, Horn	Sets the volume balance between the high-range horn and low-range rotor	
	Manual SpeedCtrl	Off...Tempo	Sets a modulation source for direct control of rotation speed	D ^{mod}
g	Horn Acceleration	0...100	Sets how quickly the horn rotation speed changes	
	Horn Ratio	Stop, 0.50...2.00	Adjusts the (high-frequency) horn rotation speed. Standard value is 1.00. "Stop" stops the rotation	
h	Rotor Acceleration	0...100	Sets how quickly the rotor speed changes	
	Rotor Ratio	Stop, 0.50...2.00	Adjusts the (low-frequency) rotor rotation speed. Standard value is 1.0. "Stop" stops the rotation	
i	Mic Distance	0...100	Distance between the microphone and rotary speaker	
	Mic Spread	0...100	Angle of left and right microphones	
j	FX Amount	0...100	Amount of FX added to the direct signal	D ^{mod}
	Src	Off...Tempo	Table, "Dynamic Modulation sources," on page 26	
	Amt	-100...+100	Amount of modulation source	

a: Sw

This parameter determines how to switch on/off the overdrive via a modulation source.

When "Sw" = Toggle, overdrive is turned on/off each time the pedal or joystick is operated.

MIDI Overdrive will be switched on/off each time the value of the modulation source exceeds 64.

When "Sw" = Moment, overdrive is applied only when you press the pedal or operate the joystick.

MIDI Only when the value for the modulation source is 64 or higher, the overdrive effect is applied.

119: L/C/R Long Delay

This multitap delay outputs three Tap signals to left, right and center respectively. You can set a maximum of 5,460msec for the delay time.

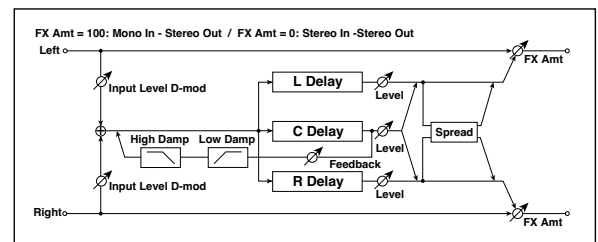

a	L Delay Time [msec]	0...5460	Sets the delay time of TapL	
	Level	0...50	Sets the output level of TapL	
b	C Delay Time [msec]	0...5460	Sets the delay time of TapC	
	Level	0...50	Sets the output level of TapC	
c	R Delay Time [msec]	0...5460	Sets the delay time of TapR	
	Level	0...50	Sets the output level of TapR	
d	Feedback (C Delay)	-100...+100	Sets the feedback amount of TapC	D ^{mod}
	Src	Off...Tempo	Selects the modulation source for the TapC feedback	
	Amt	-100...+100	Sets the modulation amount of the TapC feedback	
e	High Damp	0...100	Sets the damping amount in the high range	
	Low Damp	0...100	Sets the damping amount in the low range	
f	Input Level Dmod [%]	-100...+100	Sets the modulation amount of the input level	D ^{mod}
	Src	Off...Tempo	Selects the modulation source for the input level	
g	Spread	0...50	Sets the width of the stereo image of the effect sound	
h	FX Amount	0...100	Amount of FX added to the direct signal	D ^{mod}
	Src	Off...Tempo	Table, "Dynamic Modulation sources," on page 26	
	Amt	-100...+100	Amount of modulation source	

120: St/Cross Long Delay (Stereo/Cross Long Delay)

This is a stereo delay, and can be used as a cross-feedback delay effect in which the delay sounds cross over between left and right by changing the feedback routing. You can set a maximum of 2,730msec for the delay time.

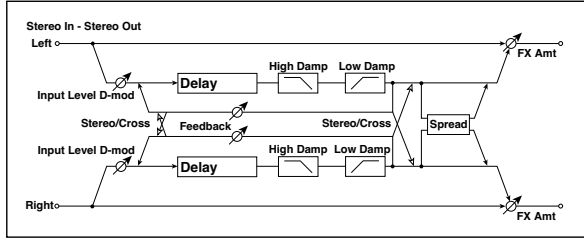

a	Stereo/Cross	Stereo, Cross	Switches between stereo delay and cross-feedback delay	
b	L Delay Time [msec]	0.0...2730.0	Sets the delay time for the left channel	
c	R Delay Time [msec]	0.0...2730.0	Sets the delay time for the right channel	
d	L Feedback	-100...+100	Sets the feedback amount for the left channel	D ^{mod}
	Src	Off...Tempo	Selects the modulation source of feedback amount	
	Amt	-100...+100	Sets the modulation amount of the left channel feedback	
e	R Feedback	-100...+100	Sets the feedback amount for the right channel	D ^{mod}
	Amt	-100...+100	Sets the modulation amount of the right channel feedback	
f	High Damp [%]	0...100	Sets the damping amount in the high range	
g	Low Damp [%]	0...100	Sets the damping amount in the low range	
h	Input Level Dmod [%]	-100...+100	Sets the modulation amount of the input level	D ^{mod}
	Src	Off...Tempo	Selects the modulation source for the input level	
i	Spread	-50...+50	Sets the width of the stereo image of the effect sound	
j	FX Amount	0...100	Amount of FX added to the direct signal	D ^{mod}
	Src	Off...Tempo	Table, "Dynamic Modulation sources," on page 26	
	Amt	-100...+100	Amount of modulation source	

121: Hold Delay

This effect records the input signal and plays it back repeatedly. You can control the start of recording and reset via a modulation source. Easy to use for real-time performances.

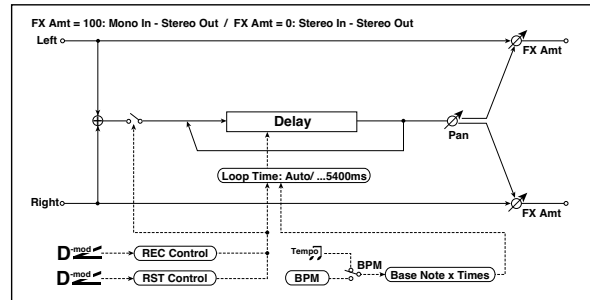

a	Loop Time [msec]	Auto, 1...10800	Sets Automatic loop time setup mode or specifies loop time	
b	Loop BPM Sync	Off, On	Specifies whether delay time is set in milliseconds, or as a note value relative to tempo	A ^{sync}
c	BPM	MIDI, 40.00...300.00	MIDI syncs to the system tempo; 40-300 sets the tempo manually for this individual effect	
	Time Over?	---, OVER!	An error indication that appears if delay time exceeds the upper limit when MIDI/Tempo Sync=On	
d	Loop Base Note		Selects the type of notes to specify the delay time	
	Times	x1...x32	Sets the number of notes to specify the delay time	
e	REC Control Src	Off...Tempo	Selects control source for recording	D ^{mod}
f	RST Control Src	Off...Tempo	Selects control source for reset	D ^{mod}
g	Manual REC Control	REC Off, REC On	Sets the recording switch	
h	Manual RST Control	Off, RESET	Sets the reset switch	
i	Pan	L100...L1, C, R1...R100	Sets the stereo image of the effect	D ^{mod}
	Src	Off...Tempo	Selects the modulation source of stereo image of the effect	
	Amt	-100...+100	Sets the modulation amount of stereo image of the effect	
j	FX Amount	0...100	Amount of FX added to the direct signal	D ^{mod}
	Src	Off...Tempo	Table, "Dynamic Modulation sources," on page 26	
	Amt	-100...+100	Amount of modulation source	

a: Loop Time [msec]

With Auto, the loop time is automatically set. Otherwise, you can specify the loop time.

When Auto is selected, the Loop Time is automatically set to the time it takes for a performance recorded while the Modulation Source or "Manual REC Control" is on. However, if the time length exceeds 10,800msec, the loop time will be automatically set to 10,800msec.

c: Time Over?

You can set the delay time up to 10,800msec. If the delay time exceeds this limit, the error message "OVER!" appears in the display. Set the delay time parameters so that this message will not appear. "Time Over?" is only a display parameter.

- b: Loop BPM Sync**
- c: BPM**
- d: Loop Base Note**
- d: Times**

If “Loop BPM Sync” is on, the “Times” setting is ignored; the loop time is determined by “BPM,” “Loop Base Note,” and “Times.” Even in this case, the delay time cannot exceed 10,800 msec.

“Hold” procedure (when Loop Time = Auto)

1. “Rec Src”JS +Y: #01
 “Reset Src”JS -Y: #02
 “Manual REC Control”REC Off
 “Manual RST Control”RESET
 “Loop Time [msec]”Auto
 “MIDI/Tempo Sync”Off
 It should be noted that all recordings will be deleted while Reset is On.
2. “Manual RST Control”Off
 Reset is cancelled and the unit enters Rec ready mode.
3. Push the joystick in the +Y direction (forward) and play a phrase you wish to hold. When you pull the joystick to its original position, the recording will be finished and the phrase you just played will be held.
 Loop Time is automatically set only for the first recording after resetting. If the time length exceeds 10,800msec, Loop Time will be automatically set to 10,800msec. (If you have set “Times” to 1–10,800msec, the specified loop time will be used regardless of the time taken from pushing the joystick forward until it is pulled back. However, the recording method remains the same. The phrase being played while the joystick is pushed forward will be held.)
4. If you made a mistake during recording, pull the joystick in the -Y direction (back) to reset. In this way, the recording will be erased. Repeat step 4. again.
5. The recorded phrase will be repeated again and again. You can use this to create an accompaniment.
6. By pushing the joystick in the +Y direction (forward), you can also overdub performances over the phrase that is being held.

- e: REC Control Src**
- g: Manual REC Control**

“REC Control Src” selects the modulation source that controls recording.

If this modulation is on, or if “Manual REC Control” is set to On, you can record the input signal. If a recording has already been carried out, additional signals will be overdubbed.

MIDI The effect is off when a value for the modulation source specified for the “REC Control Src” parameter is 63 or smaller, and the effect is on when the value is 64 or higher.

- f: RST Control Src**
- h: Manual RST Control**

The “RST Control Src” parameter specifies the modulation source that controls the reset operation.

When you set this modulation source to On, or “Manual RST Control” to RESET, you can erase what you recorded. If the Loop Time parameter has been set to Auto, the loop time is also reset.

MIDI The effect is off when a value for the modulation source specified for the “RST Control Src” parameter is 63 or smaller, and the effect is on when the value is 64 or higher.

122: LCR BPM Long Dly

The L/C/R delay enables you to match the delay time with the song tempo.

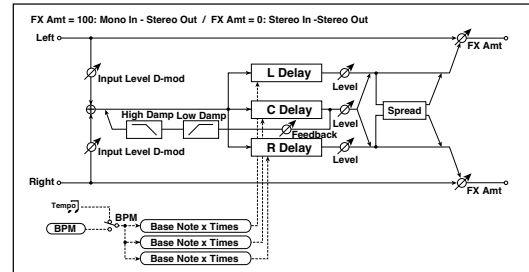

a	BPM	MIDI, 40.00... 300.00	MIDI syncs to the system tempo; 40–300 sets the tempo manually for this individual effect	
	Time Over?	---, OVER!	Displays an error message when the delay time exceeds the upper limit	
b	L Delay Base Note		Selects the type of notes to specify the delay time for TapL	
	Times	x1...x32	Sets the number of notes to specify the delay time for TapL	
	Level	0...50	Sets the output level of TapL	
c	C Delay Base Note		Selects the type of notes to specify the delay time for TapC	
	Times	x1...x32	Sets the number of notes to specify the delay time for TapC	
	Level	0...50	Sets the output level of TapC	
d	R Delay Base Note		Selects the type of notes to specify the delay time for TapR	
	Times	x1...x32	Sets the number of notes to specify the delay time for TapR	
	Level	0...50	Sets the output level of TapR	
e	Feedback (C Delay)	-100...+100	Sets the feedback amount of TapC	
	Amt	-100...+100	Sets the modulation amount of the TapC feedback	
f	High Damp [%]	0...100	Sets the damping amount in the high range	
	Low Damp [%]	0...100	Sets the damping amount in the low range	
g	Input Level Dmod [%]	-100...+100	Sets the modulation amount of the input level	
	Src	Off...Tempo	Selects the modulation source for the input level	
h	Spread	0...50	Sets the width of the stereo image of the effect sound	
i	FX Amount	0...100	Amount of FX added to the direct signal	
	Src	Off...Tempo	Table, “Dynamic Modulation sources,” on page 26	
	Amt	-100...+100	Amount of modulation source	

a: Time Over?

You can set the delay time up to 10,920msec. If the delay time exceeds this limit, the error message “OVER!” appears in the display. Set the delay time parameters so that this message will not appear. “Time Over?” is only a display parameter.

123: St. BPM Long Dly (Stereo BPM Long Delay)

The stereo delay enables you to match the delay time with the song tempo.

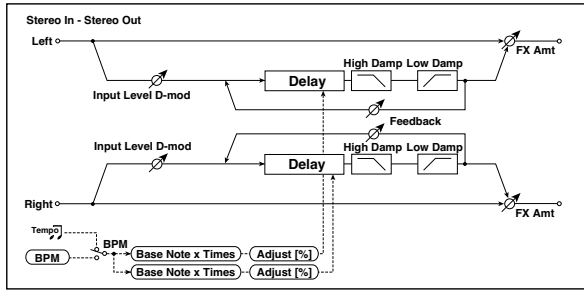

a	BPM	MIDI, 40.00...300.00	MIDI syncs to the system tempo; 40–300 sets the tempo manually for this individual effect	
	Time Over? L	---, OVER!	Display the error message if the left channel delay time exceeds the upper limit	
	R	---, OVER!	Display the error message if the right channel delay time exceeds the upper limit	
b	L Delay Base Note		Selects the type of notes to specify the left channel delay time	
	Times	x1...x32	Sets the number of notes to specify the left channel delay time	
	Adjust [%]	-2.50...+2.50	Fine-adjust the left channel delay time	
c	R Delay Base Note		Selects the type of notes to specify the right channel delay time	
	Times	x1...x32	Sets the number of notes to specify the right channel delay time	
	Adjust [%]	-2.50...+2.50	Fine-adjust the right channel delay time	
d	L Feedback	-100...+100	Sets the feedback amount for the left channel	
	Src	Off...Tempo	Selects the modulation source of feedback amount	
	L Amt	-100...+100	Sets the modulation amount of the left channel feedback	
e	R Feedback	-100...+100	Sets the feedback amount for the right channel	
	R Amt	-100...+100	Sets the modulation amount of the right channel feedback	
f	High Damp [%]	0...100	Sets the damping amount in the high range	
g	Low Damp [%]	0...100	Sets the damping amount in the low range	
h	Input Level Dmod [%]	-100...+100	Sets the modulation amount of the input level	
	Src	Off...Tempo	Selects the modulation source for the input level	
i	FX Amount	0...100	Amount of FX added to the direct signal	
	Src	Off...Tempo	Table, "Dynamic Modulation sources," on page 26	
	Amt	-100...+100	Amount of modulation source	

a: Time Over? L, R

You can set the delay time up to 5,460msec. If the delay time exceeds this limit, the error message "OVER!" appears in the display. Set the delay time parameters so that this message will not appear. "Time Over?" is only a display parameter.

124: Early Reflections

This early reflection effect has more precise early reflections with twice the maximum length of a normal-size effect (See "076: Early Reflections" on page 72.). You can create a very smooth and dense sound.

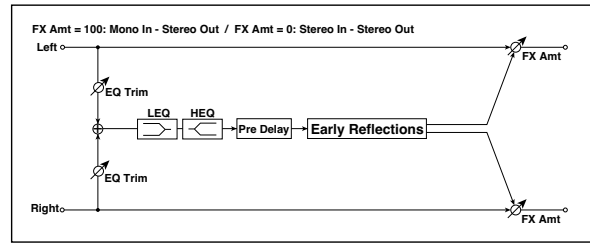

a	Type	Sharp, Loose, Modulated, Reverse	Selects the decay curve for the early reflection	
b	ER Time [msec]	10...1600	Sets the time length of early reflection	
c	Pre Delay [msec]	0...200	Sets the time taken from the original sound to the first early reflection	
d	EQ Trim	0...100	Sets the input level of EQ applied to the effect sound	
e	Pre LEQ Fc	Low, Mid-Low	Selects the cutoff frequency (low or mid-low) of the low-range equalizer	
	Pre HEQ Fc	High, Mid-High	Selects the cutoff frequency (high or mid-high) of the high-range equalizer	
f	Pre LEQ Gain [dB]	-15.0...+15.0	Sets the gain of Low EQ	
	Pre HEQ Gain [dB]	-15.0...+15.0	Sets the gain of High EQ	
g	FX Amount	0...100	Amount of FX added to the direct signal	
	Src	Off...Tempo	Table, "Dynamic Modulation sources," on page 26	
	Amt	-100...+100	Amount of modulation source	

KORG

Address

KORG ITALY SpA
Via Cagiata, 85
I-60027 Osimo (An)
Italy

Web

www.korgpa.com
www.korg.co.jp
www.korg.com
www.korg.co.uk



© KORG Italy 2008. All rights reserved

KORG