

DSP Synthesizer Board

EXB-MOSS

Owner's Manual

For the procedure of installing this product,
refer to the owner's manual of the device
into which the product is being installed.

SONDIUS-XG



Multi Oscillator Synthesis System

KORG

Warning

When installing, servicing, or replacing parts for this product, do not perform any action that is not prescribed in the owner's manual.

Do not apply excessive force to the electronic components or connectors on the circuit board, and do not disassemble it. Electrical shock, fire, or malfunction may result.

Before installing this product, disconnect the power supply cable of the device in which it is being installed, and disconnect any cables that connect peripheral devices. Failure to do so may cause electrical shock or malfunctions.

Caution

Do not allow this product to become wet, and do not place objects on top of it. Doing so will cause malfunctions.

Before touching this product, touch a metal part of the device into which it will be installed, so that any static electricity in your body will be discharged. Failure to do so will risk damaging the electronic components by static electricity.

When handling this product, be careful not to touch the leads (wires protruding from the electronic components) on the rear side of the circuit board. Injury may result.

When installing this product, do not touch any unrelated parts or circuit boards. Electric shock or malfunction may result.

When installing this product, be careful not to cut yourself on any sharp edges or parts of this product or of the device into which this product is being installed.

When installing this product, be careful not to drop screws etc. into the device into which this product is being installed.

The manufacturer makes no warranty regarding possible malfunctions or damage that may result from improper use or modification. The manufacturer also will take no responsibility for any damages that may result from loss or disappearance of data.

Installing this product

For the procedure of installing this product, refer to the owner's manual of the device into which the product is being installed. If you have any questions, please contact your local Korg distributor.

Cautions when installing an option board

In order to install the board correctly, please pay attention to the following points.

Be careful of static electricity, which may damage components inside the product or on the board. Before beginning the installation, touch an unpainted metal part of the chassis or the grounding terminal of a grounded device to discharge any static electricity that may be present in your body.

Perform the installation according to the steps given in the directions, making sure that the board is installed correctly and in the correct orientation.

Verify that the option board has been installed correctly. If installation is incorrect, faulty connections or a shorted power supply can cause malfunctions.

All the screws that are removed will be used, so be careful not to lose any.

Using screws of the incorrect shape or length can cause malfunctions or damage to the product. Use only the screws that were included with the option board or the screws that were fastened in the instrument.

When installing or removing the board, be careful not to drop parts or the option board into the instrument.

Make sure that the attaching screws are tightened firmly, and are not loose.

Handle the board with care. Subjecting it to physical shock (by dropping or pressing it) may cause damage or malfunctions.

Be careful not to touch any exposed metal portions of the circuit board, or any parts that are not essential to the installation process.

Installing this product	2
Cautions when installing an option board	2
1. Introduction	4
Features of the EXB-MOSS	4
2.The structure of bank F programs	5
Program structure	5
Features of the oscillator	6
3. Bank F operations	7
Loading the preset programs	7
Selecting a program/combination	7
Editing a program	7
Editing a combination	8
Sequencer and Song Play modes	9
Control change transmission/reception for the EXB-MOSS	10
4. Parameters	11
Program mode	11
Program P0: Play	11
Program P1: Edit-Basic	12
Program P2: Edit-Pitch	36
Program P3: Edit-Filter	38
Program P4: Edit-Amp	40
Program P5: Edit-Common LFO	43
Program P6: Edit-Common EG	45
Program P7: Edit-Arpeggiator	46
Program P8: Edit-Insert Effect	46
Program P9: Edit-Master Effect	46
Combination mode	47
Combination P4: MOSS Setup	47
Appendices	48
Cautions when using bank F	48
Affix the Sondius-XG label	48
Modulation Source List	48
Voice Name List	49

1. Introduction

Thank you for purchasing the Korg EXB-MOSS DSP synthesizer board. In order to enjoy long and trouble-free use, please read this manual carefully and use the EXB-MOSS correctly.



Before you use this product, you must read the “Safety Precautions” listed in the beginning of the Parameter Guide.



This manual explains the Bank F parameters that are added when the EXB-MOSS is installed. For details on the parameters other than Bank F, refer to the TRITON’s Parameter Guide and Basic Guide etc.

Features of the EXB-MOSS

The EXB-MOSS is an option board containing a **MOSS (Multi-Oscillator Synthesis System)** tone generator with **six-voice** polyphony.

The MOSS tone generator is a physical modeling tone generator that uses Sondius-XG* technology.

When the **EXB-MOSS** is installed into the TRITON, you will be able to use the 128 MOSS tone generator programs in program bank F.

Bank F is dedicated to **MOSS tone generator programs**. Bank F programs can be selected for a timbre/track in Combination, Song, and Song Play modes. You can also create combinations or songs that combine bank F programs with other programs from banks A–E or G.

Broadly speaking, a MOSS tone generator program consists of **voice, EG, LFO, effect, and control sections**.

The voice section contains an **oscillator** and a **filter**.

— **The oscillator** provides two oscillators (1 and 2), which can use thirteen different oscillator algorithms, including Standard, Ring Modulation, VPM, Resonance, Organ Model, and Electric Piano Model. The oscillator also provides a sub oscillator and a noise generator.

— **The filter** provides five types of filters (two filter systems), including a Human Voice Filter that lets you simultaneously set two center frequencies, and a Dual Band Pass Filter that lets you simulate the body resonances of a violin or guitar.

Five EG units and **four LFO units** can be used to modulate this voice section in order to create time-varying movement of pitch, tone, and volume.

* This product was developed under license of physical modeling tone generator patents (<http://www.sondius-xg.com>) owned by Stanford University USA and Yamaha Corporation.

- Specifications and appearance are subject to change without notice for product improvement.
- Other product names and company names are registered trademarks and trademarks of their respective owners.

2. The structure of bank F programs

Program structure

The programs of bank F have the following structure.

Oscillator

This section produces the waveform that is the basis of the sound.

Settings are made by the “Program P1: Edit-Basic” and “Program P2: Edit-Pitch” parameters.

— OSC 1, 2

Thirteen oscillator types (methods of sound generation) are provided. Of these, you can select two oscillator types for use together, and make basic settings for the pitch and waveform. However for some oscillator types, only one type can be used. Settings are made by the parameters of “1-1: Prog Basic,” “1-2: OSC Basic,” “1-3: OSC1,” and “1-4: OSC2.”

— Sub oscillator

One of four basic waveforms can be selected. Its pitch can be set in the same way as OSC1 and 2.

These settings are made by the parameters of “1-2: OSC Basic” and “2-3: SubOSC P.Mod.”

— Noise generator

This produces white noise, which can be passed through a multi-mode filter (low pass filter, high pass filter, band pass filter).

Settings are made by the “1-5: Noise Generator” parameters.

Mixer

This section mixes the signals from oscillators 1 and 2, the sub oscillator, the noise generator, and the feedback from the amp, and outputs the result to multi-mode filters 1 and 2 (filter section).

Settings are made by the “1-6: Mixer” parameters.

Filter

This section processes the waveform by attenuating or boosting specific frequency ranges. Two multi-mode filters are provided. As filter types, you can select from low pass, high pass, band pass, band reject, or dual band pass filters. These filters can be used to modify the brightness of the sound. You can also select the connection routing between the two filters and the mixer and amp.

Settings are made by the “Program P3: Edit-Filter” parameters.

Amp

This section modifies the volume of the sound that is output from the filter. There are two independent amps. The signal that is input to each will depend on the filter connections. The amp section also provides a special envelope generator for controlling the amp (Amp EG).

These settings are made by the “Program P4: Edit-Amp” parameters.

Effect

This section applies effects to the signal that is output from the amp. It has the same parameter structure as the programs of other banks.

Settings are made by the “Program P7: Edit-Arpeggiator” and “Program P8: Edit-Insert Effect” parameters.

LFO

This section provides four LFO units. Each LFO can be used as a modulation source for various parameters, to apply cyclic change to the sound.

Settings are made by the “Program P5: Edit-Common LFO” parameters.

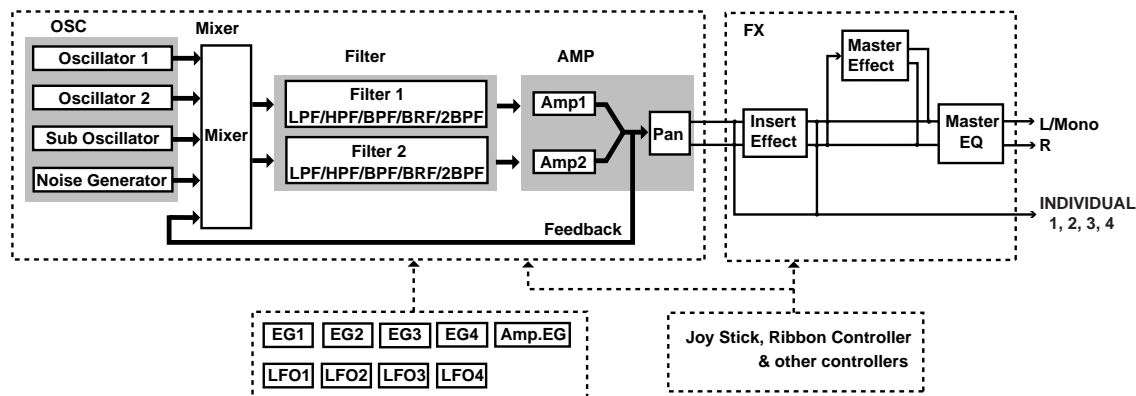

EG

This section provides four general-purpose EG units. Each EG can be used as a modulation source for various parameters, to apply time-variant change to the sound.

Settings are made by the “Program P6: Edit-Common EG” parameters.

Arpeggiator

The arpeggiator can be used in the same way as for the programs of other banks. Settings are made by the “Program P7: Edit-Arpeggiator” parameters.

Program Basic

Here you can make settings for functions such as Scale, Key Assign, and Controllers (joystick, ribbon controller etc.). Settings are made by the “1-1: Prog Basic” and “1-7: Controller Setup” parameters.

Features of the oscillator

In a bank F program, you can choose from 13 oscillator types for OSC1 and 9 oscillator types for OSC2.

In Program P1 “1-1: Program Basic” or “1-2: OSC Basic” you can select the oscillator type for OSC1 and OSC2, and use them together.

If a **Single Size oscillator** (Standard-E. Piano Model) is selected for OSC1, you can select a Standard-E. Piano Model for OSC2 as well. If a **Double Size oscillator** (Brass Model-Bowed String Model) is selected for OSC1, OSC2 will be unavailable.

Standard

This simulates the oscillator of an analog synthesizer. You can use PWM (pulse width modulation) etc. to produce the same results as on an analog synthesizer. (☞p.14 of this manual)

Comb Filter

This oscillator creates pitched components from noise or an impulse. In addition to producing noisy sounds, it can also produce a wide variety of sound ranging from synth basses to string-like sound. (☞p.17 of this manual)

VPM (Variable Phase Modulation)

This oscillator uses phase modulation to generate harmonics. A rich harmonic structure can be created by using phase modulation between two oscillators and the wave shaping table. (☞p.18 of this manual)

Resonance

This oscillator uses filter resonance, and is an especially effective way to produce mallet sounds and pad sounds. (☞p.20 of this manual)

Ring Modulation

Cross Modulation

Sync Modulation

These are special oscillators for generating the sounds which could be produced on an analog synthesizer by modulating one oscillator with another. These allow you to produce sounds with complex overtone structures such as bells, metallic sounds, and gongs. (☞p.21-23 of this manual)

Organ Model

This simulates a drawbar organ with three drawbars (when one oscillator is used) or six drawbars (when two oscillators are used) (☞page 23 of this manual). Since each drawbar can use one of four types of waveform, a wide range of tones can be produced.

E. Piano Model (electric piano model)

This is a physical model that simulates a warm vintage electric piano. (☞p.24 of this manual)

Brass Model

This is a physical model that simulates a brass instrument such as a trumpet or trombone. (☞p.25 of this manual)

Reed Model

This is a physical model that simulates a woodwind instrument such as a sax or flute. (☞p.27 of this manual)

Plucked String Model

This is a physical model that simulates plucked string instrument such as guitar or bass. (☞p.29 of this manual)

Bowed String Model

This is a physical model that simulates a bowed string. (☞p.31 of this manual)

3. Bank F operations

Loading the preset programs

Please load the “EXBMOSS-00FD” data from the floppy disk included with the EXB-MOSS. For details on the procedure, refer to “Disk mode” of the TRITON Basic Guide. The floppy disk contains the following data.

MOSS.PCG

Program	Bank A*, B*, F
Combination	Bank A*, B
Drum Kits	00–15(A/B)*
Arpeggio Pattern	000–199(A/B)*
Global setting*	

MOSS.SNG

Cue List
Demo Song "Feet Hurt MOSS" by Scott Frankfurt
©1999 Bleach Bros. Music
(bleachbros@earthlink.net) - all rights reserved.

Program bank F contains programs that use the EXB-MOSS.

Combination bank B contain combinations that use bank F programs together with the TRITON's preloaded programs of banks A and B.

* Same as the preloaded data of the TRITON.

When you load MOSS.PCG

Programs, combinations, drum kits, arpeggio patterns, and global settings will be written into the TRITON's internal memory.



When you load MOSS.PCG, all the current contents of internal memory will be erased and overwritten.

When you load MOSS.SNG

Demo songs that use the bank F programs etc. of MOSS.PCG will be loaded. These songs can be played in Sequencer mode.



When you select and load MOSS.SNG, all the current contents of sequencer memory will be erased and overwritten.

Selecting a program/combination

In “Program P0: Play,” you can select a bank F program 000–127 in the same way as for banks A–E. You can also select programs from the “Category/Program Select” menu or the “Bank/Program Select” menu.

Combinations can be selected in “Combination P0: Play,” and also from the “Category/Combination Select” menu or the “Bank/Combination Select” menu.

For a list of the programs/combinations in the included floppy disk, refer to “Voice Name List” on p.49 of this manual.

Editing a program

If a bank F MOSS tone generator program is selected in “Program P0: Play,” you can use P1–P9 to edit the program parameters. For details on the program parameters, refer to the “Parameters” section that begins on p.11 of this manual.





The performance editor parameter “Pitch Stretch” of “Program P0: Play” cannot be used for bank F programs.



Damper pedal (CC#64) cannot be used to apply a half-damper effect to the programs of bank F. The damper will function in an on/off mode (vv=00–63:off, 64–127: on). Nor can the sostenuto pedal (CC#66) or soft pedal (CC#67) effects be applied to these programs. Refer to TRITON Basic Guide p.118.

Editing a combination

You can select a bank F program for a timbre in a combination, and use it in the combination together with programs of banks A–E and G. Different MOSS tone generator programs from bank F can be selected for two or more timbres, and used multi-timbrally. In this case, **the total polyphony** of the MOSS tone generator programs **will be six voices**.

-  Insertion/master effect settings and the routing to the individual audio outputs cannot be made independently for multiple timbres.
-  If you change programs while a bank F program is sounding, the bank F program will stop sounding.
-  When playing multi-timbrally and a bank F program is being sounded, selecting a bank F program for the timbre number prior to that timbre number will cause noise to be heard in the currently-sounding bank F program.

Editing a combination

Here's how to select programs and set the parameters that determine how each program will sound.

(1) Select Combination P0: Play.

For details on how to enter each page, refer to p.52 “Combination mode” in the TRITON Basic Guide.

(2) Select the combination number that you wish to edit.

(3) Select the Combination P4: MOSS Setup tab.

Before you select a bank F program, make settings here to specify how the MOSS tone generator will sound.

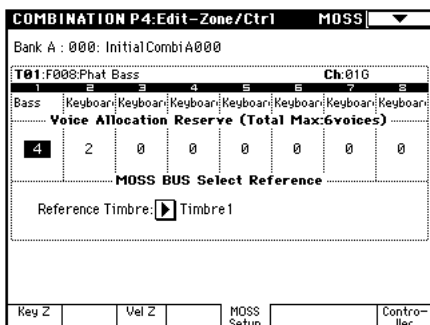

(4) Set the Voice Allocation Reserve parameter to specify the polyphony for each timbre.

For each timbre, specify the number of voices that will be allocated when a MOSS tone generator program is selected. A total of six voices can be allocated.

For example, you might allocate two voices to timbre 1 for a bass-type MOSS program, and up to four voices to timbre 2 for an electric piano MOSS program.

-  These settings have no effect on the programs of banks A–E and G. When the timbre bank/program is changed to switch a timbre from a bank F program to a bank A–E or G program, the bank A–E or G program will sound as usual.

-  When the timbre bank/program is changed to switch a timbre from a bank A–E or G program to a bank F program, it will sound according to the setting you make here. Timbres for which a value of 0 is set will not sound if a bank F program is selected.

(5) Set the MOSS BUS Select Reference.

The bank F programs will be routed to the insertion/master effects or individual audio output according to the settings of the timbre you select here.

- note** The timbre 1–8 you select here does not have to be using a bank F program.

Bank F programs can be used for two or more timbres according to the “Voice Allocation Reserve” setting. However, settings for insertion/master effects and routing to individual audio outputs can not be made independently for two or more timbres.

Timbre settings for insertion/master effects and routing to individual audio outputs are made in the Program P8: Routing tab. Use the following procedure to make settings.

Example)

1. Set “MOSS BUS Select Reference” to Timbre 1.
2. In the Program P8: Routing tab, set the timbre 1 “IFX/Indiv.Out BUS Select” to L/R. All bank F programs that you selected will be sent to L/R (without using the insertion effects).
3. Set the timbre 1 parameters “Send 1” and “Send 2” to 064 and 127 respectively. The signal will be sent to MFX1 and MFX2 at the specified levels.
4. If you wish to use an insertion effect, set “IFX/Indiv.Out BUS Select” to IFX1–IFX5. If you wish to output to the [AUDIO OUT INDIVIDUAL] 1–4 jacks, select 1–4, 1/2, or 3/4.

note The actual levels of send 1 and 2 for a timbre using a bank A–E or G program is determined by multiplying the timbre setting by the send level of the program, but for timbres that use a bank F program, the send level setting of the timbre will be the actual level.

 This setting has no effect for bank A–E or G programs.

(6) Select Combination P1: Edit-Program/Mixer.

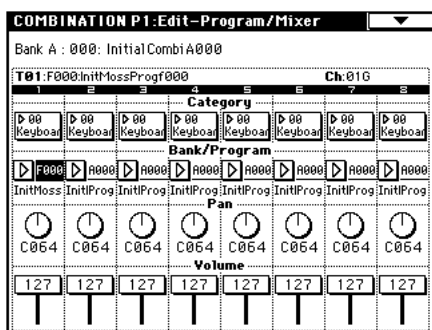

(7) In “Bank/Program,” select a bank F program.

Programs can also be selected from the “Category/Program Select” menu or the “Bank/Program Select” menu.

(8) Use “Pan” to adjust the panpot of the timbre.

When a bank F program is selected, the Random setting will not be available. If Random is selected, the sound will be placed in the center, as with C064.

(9) Use “Volume” to adjust the volume of the timbre.

(10) Make settings for other parameters.

In the same way as for programs of other banks, set the parameters of each timbre, and make arpeggiator settings and insertion/master effect settings.

However when a bank F program is selected for a timbre, the following parameters will function as explained below.

— “OSC Select” will have no effect. (Combination P2: OSC tab)

— The “Detune” range will be ± 100 . Even if the absolute value of the parameter setting is greater than 100, the actual detune value will be ± 100 cents. (Program P2: OSC tab)

— The Key Zone / Vel Zone “Top Slope” and “Bottom Slope” settings will have no effect. (Program P4: Key Z, Vel Z tabs)

Sequencer and Song Play modes

Bank F programs can be selected for playback of a song or Standard MIDI File, or for performance from the keyboard. In the same way as in a combination, bank F programs can be selected for two or more tracks and used multi-timbrally. In this case, **the total polyphony of the bank F programs will be six voices.**

 Insertion/master effect settings and individual audio output routing cannot be specified independently for each track.

Details of the settings, the operation of each parameter, and cautions are the same as for combinations. Refer to “Editing a combination” on p.8 of this manual.

☞ Sequencer P4: MOSS T01–08, MOSS T09–16 tabs

☞ Song Play P1: MOSS T01–08, MOSS T09–16 tabs

Control change transmission/ reception for the EXB-MOSS

In the same way as bank A–E or G programs, bank F programs can receive MIDI control changes CC#70–79, and can be operated by the front panel realtime control knobs 1–4 in A-mode. In B-mode, CC#70–79 can be assigned as knob functions, and used to control the program sound. These settings can be saved by writing them in Program mode.

☞ Refer to p.223 of the TRITON Parameter Guide.

CC#70: Sustain Level

“Sustain Level” (Program P4: AmpEG tab, Program P6)

note This controls the EG that is selected by Filter EG (Program P3: Filter 1/2 tab) and Amp Level EG (Program P4: Amp 1/2 Level tab).

CC#71: Filter Resonance Level

“Filter A Resonance” (Program P3: Filter 1/2 tab)

“Filter B Resonance” (Program P3: Filter 1/2 tab)

CC#72: Release Time

“Release Time” (Program P4: AmpEG tab, Program P6)

note This controls the EG that is selected by Filter EG (Program P3: Filter 1/2 tab) and Amp Level EG (Program P4: Amp 1/2 Level tab).

CC#73: Attack Time

“Attack Time” (Program P4: AmpEG tab, Program P6)

“Time Modulation At” (Program P4: AmpEG tab, Program P6)

note This controls the EG that is selected by Filter EG (Program P3: Filter 1/2 tab) and Amp Level EG (Program P4: Amp 1/2 Level tab).

CC#74: Low Pass Filter Cutoff Frequency

“Filter A Frequency” (Program P3: Filter 1/2 tab)

“Filter B Frequency” (Program P3: Filter 1/2 tab)

CC#75: Decay Time

“Decay Time” (Program P4: AmpEG tab, Program P6: EG1–4 tabs)

“Slope Time” (Program P4: AmpEG tab, Program P6: EG1–4 tabs)

note This controls the EG that is selected by Filter EG (Program P3: Filter 1/2 tab) and Amp Level EG (Program P4: Amp 1/2 Level tab).

CC#76: Pitch LFO Speed

“LFO1–4 Frequency” (Program P5: LFO1–4 tabs)

note If LFO 1–4 is selected for Pitch Modulation AMS1, AMS2 (Program P2: OSC1/2 Pitch Mod. tab) or Common Pitch Modulation AMS (Program P2: Common Pitch Mod. tab), this control change message will control that LFO.

CC#77: Pitch LFO Intensity

“Pitch Modulation AMS1 Intensity” (Program P2: OSC1/2 Pitch Mod. tab)

“Pitch Modulation AMS2 Intensity” (Program P2: OSC1/2 Pitch Mod. tab)

“Common Pitch Modulation AMS Intensity” (Program P2: Common Pitch Mod. tab)

note If LFO 1–4 is selected for the corresponding AMS, this control change message will control that LFO.

CC#78: Pitch LFO Delay

“LFO1, 2, 3, 4 Fade” (Program P5)

note If LFO 1–4 is selected for Pitch Modulation AMS1, AMS2 (Program P2: OSC1/2 Pitch Mod. tab) or Common Pitch Modulation AMS (Program P2: Common Pitch Mod. tab), this control change message will control that LFO.

CC#79: Filter EG Intensity

“Filter A EG Intensity” (Program P3: Filter 1/2 tab)

“Filter B EG Intensity” (Program P3: Filter 1/2 tab)

4. Parameters

This document explains the parameters that appear the screen pages that are added when the EXB-MOSS is installed. For details on the other screen pages, refer to the Parameter Guide and Basic Guide etc. of the TRITON.

In Program mode, you can use the Write Program page menu command to write an edited program into the specified program number.

note When you press the front panel [REC/WRITE] key, the “Update Program” dialog box will appear. Here too, you can write to the currently selected program.

 Be sure to write important programs that you edit. If you turn off the power or select another program before you write, your edits cannot be recovered. Refer to “Saving data” on p.37 of the TRITON Basic Guide.

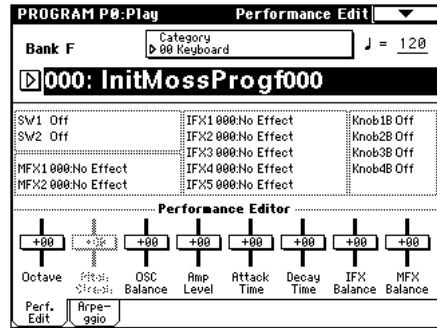

 Depending on the oscillator types or effect types used by the programs, a certain interval of time may be required after a program is selected until it actually changes.

Program mode

Program P0: Play

0-1: Perf.Edit (Performance Edit)

Here you can select a program and perform simple editing.

For details on the parameters, refer to p.1 “1. Program mode” of the TRITON Parameter Guide.

Parameters that can be controlled from the Performance Editor

Octave	Octave of OSC1, OSC2, and Sub OSC
Pitch	Cannot be used for bank F.
OSC Balance	OSC 1 and 2 levels of OSC Mixer 1 and 2
Amp Level	Output level
Attack Time	Amp EG, EG1,2,3,4 Attack Time, Time Modulation At (controls the EG selected by Filter 1, 2, Filter EG, Amp 1, 2, and Amp Level EG)
Decay Time	Amp EG, EG 1, 2, 3, 4 Decay Time, Slope Filter (controls the EG selected by Filter 1, 2, FilterEG, Amp1, 2, and Amp Level EG)
IFX Balance	Wet/dry balance of each effect IFX1-5
MFX Balance	Master effect return 1, 2

0-2: Arpeggio

Here you can perform simple editing of the arpeggiator.

For details on the parameters, refer to p.3 “0-2: Arpeggio” of the TRITON’s Parameter Guide.

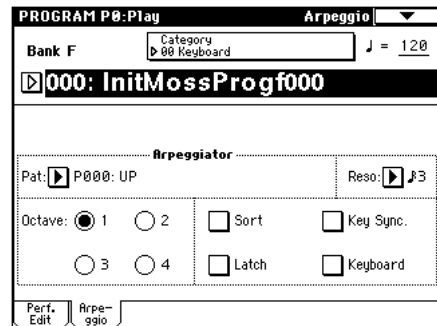

Program P1: Edit-Basic

Here, you can select programs and perform simple editing.

1-1: Program Basic

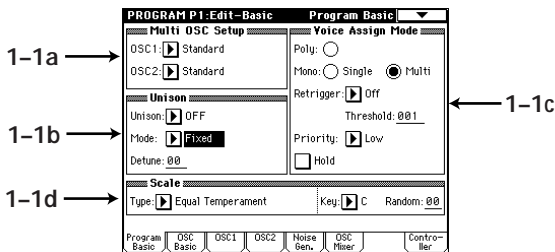

1-1a: Multi OSC Setup

Here, you can make settings for the oscillator. The parameters that are set in “1-3: OSC 1” and “1-4: OSC 2” will differ depending on the oscillator type that is selected here. (Link: 1-2a, 1-2b)

OSC 1 (Oscillator 1 Type)

[Standard...Bowed String Model]

Selects the oscillator type for oscillator 1. For details on the oscillator types, refer to “Features of the oscillator” on p. 6 of this manual.

Single Size

- Standard
- Comb Filter
- VPM (Variable Phase Modulation)
- Resonance
- Ring Modulation
- Cross Modulation
- Sync Modulation
- Organ Model
- E. Piano Model

Double Size

- Brass Model
- Reed Model
- Plucked String Model
- Bowed String Model



When **Double Size** (Brass Model, Reed Model, Plucked String Model, or Bowed String Model) are selected, OSC 2 cannot be used.

OSC 2 (Oscillator 2 Type)

[Standard...E. Piano Model]

Selects the oscillator type for oscillator 2. Refer to OSC 1.

1-1b: Unison

Here, you can make settings for unison mode.

Unison

[OFF, 2voices, 3voices, 6voices]

Specifies the number of notes which will be sounded in unison. With a setting of **OFF**, unison will not be used.

The maximum polyphony will be three notes with a setting of **2voices**, two notes for a setting of **3voices**, and one note for a setting of **6voices**.

Mode

[Fixed, Dynamic]

Specifies how the number of voices specified by the “Unison” setting will be allocated.

With a setting of **Fixed**, the number of voices specified by the “Unison” setting will always sound. With a setting of **Dynamic**, the number of voices will be determined by the current note-playing situation.

Detune

[0...99]

Detunes the notes that are sounded simultaneously by the Unison function.

1-1c: Voice Assign Mode

Here, you can specify how notes will sound when keys are pressed.

Poly, Mono (Single, Multi)

Selects whether the sound will be played monophonically or polyphonically.

Poly: Polyphonic playing

Mono (Single): Single-triggered monophonic playing

Mono (Multi): Multi-triggered monophonic playing.



When **Poly** is selected, the Retrigger Control and Threshold parameters will be unavailable.

Retrigger (Retrigger Control) [Off...MIDI:CC#83]

“Retrigger” refers to the action of resetting the EG and LFO at the time of note-on (the EG will return to its start level, and the LFO will return to the beginning of the cycle of its waveform). Here you can select the controller which will specify whether or not the sound will be retriggered when a note-on occurs.

Threshold (Retrigger Control Threshold) [1...127]

Specifies the value at which **EG** and **LFO** will be retriggered by a note-on.

The state of the controller selected by Retrigger Control (i.e., whether the controller value is above or below the specified Threshold value) will determine whether or not the sound will be retriggered when a note-on occurs.

The operation of this function will differ depending on the “Voice Assign Mode” setting.

With a setting of **Mono (Single)**, retriggering will occur if the controller is above the threshold value. If Retrigger Control is **OFF**, retriggering will not occur. With a setting of **Mono (Multi)**, retriggering will occur if the controller is below the threshold value. If Retrigger Control is **OFF**, retriggering will always occur.



If a note-on occurs when all notes are off, retriggering will always occur. LFO's whose Key Sync is turned **OFF** will not be reset even if retriggering occurs.

Priority [Low, High, Last]
Specifies the priority order that will be used when the number of keys pressed exceeds the maximum polyphony.

Low: The lowest note will take priority

High: The highest note will take priority

Last: The last-pressed note will take priority

Hold

When this is **checked**, the note will continue to sound after the key is released. However, if the EG selected by “4-1: Amp1,” “Amp2” (normally the Amp EG is used) has a sustain level of zero, the note will decay naturally.

1-1d: Scale

Specifies the scale type

Type (Scale Type)

[Equal Temperament...User Octave Scale 15]

Selects the basic scale for the internal tone generator. The user scales can be specified in Global mode “3-1: User Scale” (☞page 127 in Parameter Guide).

Equal Temperament

The most widely used scale, consisting of equally-spaced semitone steps.

Pure Major

The major chords of the selected key will be perfectly in tune.

Pure Minor

The minor chords of the selected key will be perfectly in tune.

Arabic

This reproduces a quarter-tone scale of Arabic music.

Pythagorean

A scale based on ancient Greek musical theory, suitable for playing melodies.

Werckmeister (Werckmeister III)

An equal-tempered scale used in the later Baroque period.

Kirnberger (Kirnberger III)

A scale created in the 18th century, and used mainly for tuning harpsichords.

Slendro

An Indonesian gamelan scale in which the octave consists of 5 notes.

If the Key parameter is set to C, use the **C, D, F, G,** and **A** keys. (Other keys will produce the same pitches as equal temperament.)

Pelug

An Indonesian gamelan scale in which the octave consists of 7 notes.

If the Key parameter is set to C, use only the white keys. (The black keys will produce the same pitches as equal temperament.)

Stretch

This is a tuning used on acoustic pianos.

User All Notes Scale

This is the full-range scale (C-1=G9) that you create in Global mode “3-1b: User All Notes scale” (☞page 121 in TRITON Parameter Guide).

User Octave Scale 00-15

This is the one-octave scale that you create in Global mode “3-1a: User Octave Scale” (☞page 121 in TRITON Parameter Guide).

Key (Scale Key) [C...B]

Specify the tonic note of the selected scale. This setting has no effect for **Equal Temperament, Stretch, or Scale**.



If a scale other than equal temperament is selected, certain combinations of this parameter and the “Key” parameter may cause the tuning of the base key (for example A=440 Hz) to become incorrect. If this occurs, you can adjust the “Master Tune” (Global P0: Basic tab).

Random [0...99]

As this value is increased, the pitch of the note will become increasingly unpredictable. Normally you will leave this set at **zero**.

Adjust this parameter when you wish to simulate instruments whose pitch is naturally unstable, such as tape-mechanism organs or acoustic instruments.

1-2: OSC Basic (Oscillator Basic)

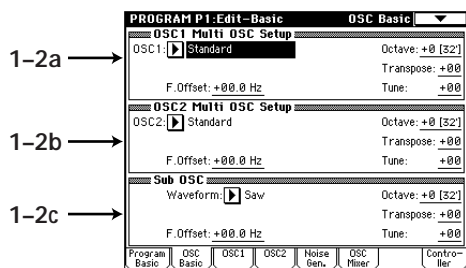

1-2a: OSC 1 Multi OSC Setup

Specifies the basic pitch of oscillator 1

OSC 1 (Oscillator 1 Type)

[Standard...Bowed String Model]

This shows the oscillator type that was selected in “1-1a: Multi OSC Setup.” This is linked with the identically-named parameter in “1-1a: Multi OSC Setup.”

Octave [-2[32']...+1[4']]

Specifies the basic pitch of oscillator 1 in steps of an octave.

32' is two octaves below, 16' is one octave below, 8' is standard pitch, and 4' is one octave above.

Transpose [-12...+12]

Adjusts the basic pitch specified by “Octave” in semitone steps.

Tune [-50...+50]

Makes fine adjustments to the pitch in one-cent steps.

F. Offset (Frequency Offset) [-10.0...+10.0]

Makes fine adjustments to the pitch in 0.1 Hz steps.

1-2b: OSC 2 Multi OSC Setup

Selects the oscillator type for oscillator 2.

1-2c: Sub OSC

Make basic settings for the sub oscillator.

Parameters other than Waveform are the same as for oscillator 1.

Waveform [Saw...Sine]

Select the waveform of the sub oscillator.

1-3: OSC1 (Oscillator 1)

Make settings for each oscillator type. The oscillator type is selected in “1-1a: Mult OSC Setup” or “1-2: OSC Basic.”

The parameters that are displayed will depend on the selected oscillator type.

Standard

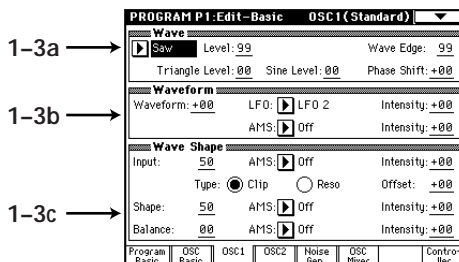

This oscillator produces the waveforms used by an analog synthesizer (sawtooth wave, pulse wave, triangle wave) and sine wave. Sawtooth wave, pulse wave and triangle wave waveforms can be modified using waveform modulation. You can specify either sawtooth wave or pulse wave as the main waveform, and mix triangle wave or sine wave with this for output. The level of these three waveforms can be adjusted independently.

In addition, wave shaping can be applied to the output of this oscillator.

Waveform modulation

Pulse width modulation (PWM) on an analog synthesizer produces time-varying change in the pulse width of a pulse wave. The waveform modulation provided by the **EXB-MOSS option** is an extension of this, which varies not only the pulse width but also the waveform of a sawtooth wave or triangle wave.

Waveform modulation will affect the various waveforms as follows.

Sawtooth wave

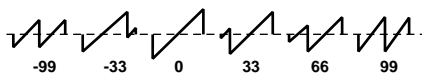

Waveform modulation will modify a sawtooth waveform as shown below, creating time-variant change in the sound.

When modulation is **0**, the basic sawtooth waveform will be produced, and when it is **99**, a sawtooth wave of double the frequency will be produced. If the modulation value is a negative number, a different effect will result than with positive settings.

Pulse wave

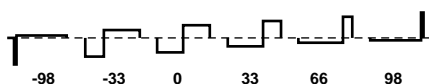

Waveform (pulse width) modulation will modify a pulse waveform as shown below, creating time-variant change in the sound. When modulation is **0**, a square wave will be produced, and when it is **99**, the pulse width will be 0, meaning that there will be no sound. If the modulation value is a negative number, the results will be inverted.

Triangle wave

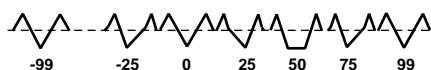

Waveform modulation will modify a ramp wave as shown below, creating time-variant change in the sound. When modulation is **0**, a triangle wave will result, and as the modulation value increases, the waveform will become a ramp wave (a waveform in which the slope is broken in two). At a modulation value of **50**, a trapezoidal wave will result, and at a value of **99** the waveform will once again be a triangle wave. If the modulation value is a negative number, the results will be inverted. Compared to sawtooth or pulse waves, this waveform produces a strong fundamental with fewer overtones, making it particularly suitable for bass sounds etc.

1-3a: Wave

Main Wave [Saw, Pulse]

Selects the main waveform. Select either **Saw** (sawtooth wave) or **Pulse** (pulse wave).

Level [0...99]

Specifies the output level of the main waveform.

Wave Edge [0...99]

Adjusts the amount of high-range overtones for the main waveform. As the pitch rises, this effect will become stronger, and in the low range there will be little effect. Lower settings of this parameter will produce a more mellow sound, and in the vicinity of **0** the volume will also decrease.

Triangle Level [0...99]

Specifies the output level of the triangle waveform. It will be output mixed with the main waveform.

Sine Level [0...99]

Specifies the output level of the sine waveform. It will be output mixed with the main waveform.

Phase Shift (Triangle & Sine Phase Shift) [-99...+99]

Specifies the phase difference between the main waveform and the triangle and sine waveforms. (The triangle and sine waveforms will always be in phase with each other.)

1-3b: Waveform (Waveform Modulation)

Waveform [-99...+99]

Specifies the waveform. For the way in which this value will affect the waveform, refer to the diagrams shown on the previous page for sawtooth wave, pulse wave, and triangle wave.

LFO [LFO1...LFO4]

Selects the source LFO for waveform modulation. LFO settings are made in the "Program P5."

Intensity (Waveform Modulation LFO Intensity) [-99...+99]

Specifies the depth and direction of the waveform modulation that will be controlled by the LFO specified in "LFO."

AMS (Alternate Modulation Source) [Off...MIDI:CC#83]

Selects a modulation source (☞ p.48 of this manual) that will control "Waveform."

Intensity (Waveform AMS Intensity) [-99...+99]

Specifies the depth and direction of the waveform modulation controlled by the "AMS." For negative settings, the polarity of the modulation source will be inverted.

1-3c: Wave Shape

Input (Input Level) [0...99]

Specifies the level of the signal that is input from the standard oscillator to the wave shaping table.

Example of when Input Level is modified (Table Type : Reso)

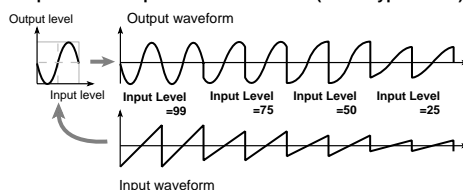

AMS (Alternate Modulation Source) [Off...MIDI:CC#83]

Selects a modulation source (☞ p.48 of this manual) that will control "Input."

Intensity (Input Level AMS Intensity) [-99...+99]
 Specifies the depth and direction of the waveform modulation controlled by the “AMS.”

Type (Wave Shape Table Type) [Clip/Reso]
 Use the **radio buttons** to select the wave shaping table which will modify the input waveform.
Clip (clip type) and **Reso** (resonant type) tables will modify the waveform as shown by the diagrams in Shape, below.

Offset (Wave Shape Offset) [-99...+99]
 Specifies an offset amount that will be added to the signal specified by “Input.”

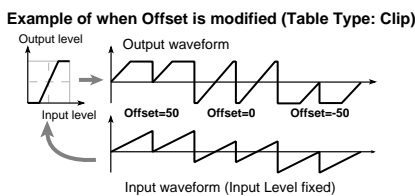

Shape [0...99]
 Specifies the characteristics of the table which will modify the input waveform. The characteristics of the table will change as follows.

Shape of the wave shaping table and the Shape parameter
CLIP type

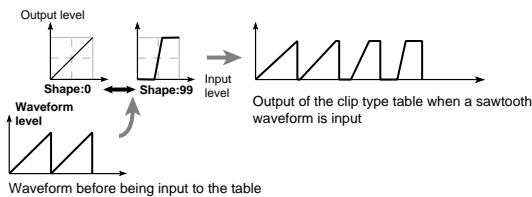

Resonant type

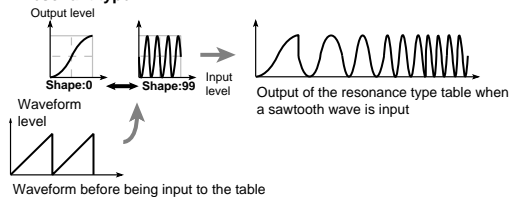

AMS (Alternate Modulation Source) [Off...MIDI:CC#83]
 Selects a modulation source (p.48 of this manual) that will control “Shape.”

Selects a modulation source (p.48 of this manual) that will control “Shape.”

Intensity (Shape AMS Intensity) [-99...+99]
 Specifies the depth and direction of the waveform modulation controlled by the “AMS.”

Balance [0...99]
 Specifies the balance between the signal that has passed through the wave shaping table and the output signal from the standard oscillator. With a setting of

99, it will be only the output of the wave shaping table.

AMS (Alternate Modulation Source) [Off...MIDI:CC#83]

Selects a modulation source (p.48 of this manual) that will control “Balance.”

Intensity (Balance AMS Intensity) [-99...+99]
 Specifies the depth and direction of the waveform modulation controlled by the “AMS.”

Comb Filter

In this oscillator, the signal from the other oscillator waveform or the noise generator is sent through a comb filter, and the feedback level of the comb filter is varied in order to produce tonal change.

When noise is input, raising the feedback of the comb filter will gradually change the sound into a pitched tone.

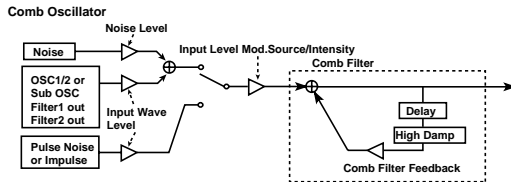

Example of when noise is input

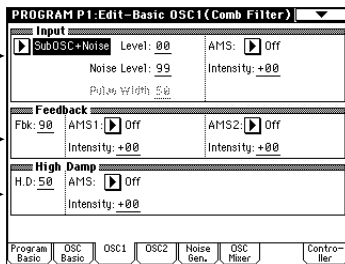
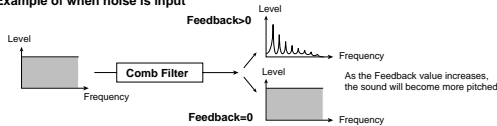

1-3a →

1-3b →

1-3c →

1-3a: Input

Input

[OSC2(1)+Noise, SubOSC+Noise, Filter1+Noise, Filter2+Noise, Pulse Noise, Impulse]

Selects the signal that will be input to the comb filter.

Example of when an impulse is input

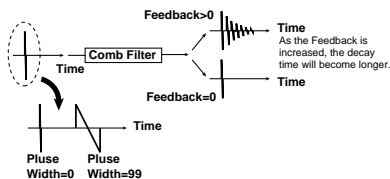

Level (Input Wave Level)

[0...99]

Specifies the volume level of the signal that will be input to the comb filter.

Noise Level

[0...99]

This parameter will be available only if "Input" has been set to **OSC2(1)+Noise**, **SubOSC+Noise**, **Filter1+Noise** or **Filter2+Noise**. It specifies the volume level of the noise generator output which will be input to the comb filter.

Pulse Width

[0...99]

This parameter will be available only if "Input" has been set to **Pulse Noise** or **Impulse**.

It specifies the length of time that the **Pulse Noise** or **Impulse** will last after being triggered.

AMS (Alternate Modulation Source)

[Off...MIDI:CC#83]

Selects a modulation source (⇒p.48 of this manual) that will control the volume level of the signal being input to the comb filter.

The volume level is set by the "Level" or the "Noise Level."

Intensity (Input Wave Level AMS Intensity)

[-99...+99]

Specifies the depth and direction of the effect of "AMS."

1-3b: Feedback

Fbk (Feedback)

[0...99]

Specifies the amount of feedback for the comb filter. If this value is **high**, the resonance of the comb filter will be high, and the tone will have a clear sense of pitch. Conversely, if this value is **low**, the input signal will be output without change, and if the input signal is only noise, the output signal will have no sense of pitch.

AMS1 (Alternate Modulation Source 1)

[Off...MIDI:CC#83]

Selects a modulation source 1 (⇒p.48 of this manual) that will control "Fbk."

Intensity (Feedback AMS1 Intensity)

[-99...+99]

Specifies the depth and direction of the effect of "AMS1."

AMS2 (Alternate Modulation Source 2)

[Off...MIDI:CC#83]

Selects a modulation source 2 (⇒p.48 of this manual) that will control "Fbk."

Intensity (Feedback AMS2 Intensity)

[-99...+99]

Specifies the depth and direction of the effect of "AMS2."

1-3c: High Damp

H. D (High Damp) [0...99]

Specifies the amount of attenuation that will be applied to the high-frequency component of the feedback signal within the comb filter.

As this **value is increased**, the tone will become more mellow. Conversely, **decreasing this value** will produce a brighter tone.

AMS (Alternate Modulation Source) [Off...MIDI:CC#83]

Selects a modulation source (☞p.48 of this manual) that will control “H. D.”

Intensity (High Damp AMS Intensity) [-99...+99]

Specify the depth and direction in which “AMS” will affect high damp.

VPM

The output of a carrier is phase-modulated by a modulator, and output through wave shape processing. By controlling the wave shaping parameters and the feedback gain, tonal changes that are different than simple phase modulation can be produced.

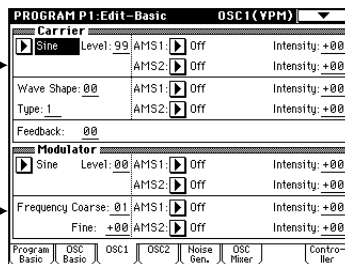
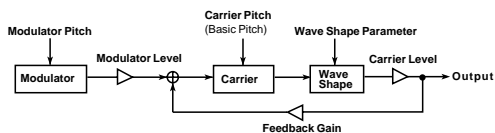

1-3a →

1-3b →

1-3a: Carrier

Wave [Saw, Square, Triangle, Sine]

Selects the carrier waveform.

Level [0...99]

Specifies the output level of the carrier. This will determine the output level of the VPM oscillator.

AMS1 (Alternate Modulation 1 Source) [Off...MIDI:CC#83]

Selects a modulation source 1 (☞p.48 of this manual) that will control “Level.”

Intensity (Level AMS1 Intensity) [-99...+99]

Specifies the depth and direction of the effect of “AMS1.”

AMS2 (Alternate Modulation 2 Source) [Off...MIDI:CC#83]

Selects a modulation source 2 (☞p.48 of this manual) that will control “Level.”

Intensity (Level AMS2 Intensity) [-99...+99]

Specifies the depth and direction of the effect of “AMS2.”

Wave Shape [0...99]

Specifies the number of cycle of wave shaping.

As this **value is increased**, the number of cycles will increase, causing more overtones to be added to the high-frequency range of the sound.

Table variation

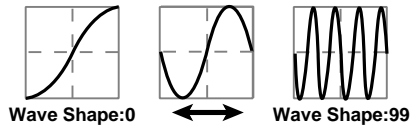

Type (Wave Shap Type) [1, 2]

- 1: The signal after wave shaping will be output without further change. If “Shape” is set to the minimum value, the phase modulated signal will be output essentially without change.
- 2: A rounded waveform will be obtained regardless of the “Shape” value.

AMS1 (Alternate Modulation Source 1) [Off...MIDI:CC#83]

Selects a modulation source 1 (⇒p.48 of this manual) that will control “Wave Shape” value.

Intensity (Shape AMS1 Intensity) [-99...+99]

Specifies the depth and direction of the effect of “AMS1.”

AMS2 (Alternate Modulation Source 2) [Off...MIDI:CC#83]

Selects a modulation source 2 (⇒p.48 of this manual) that will control “Wave Shape” value.

Intensity (Shape AMS2 Intensity) [-99...+99]

Specifies the depth and direction of the effect of “AMS2.”

Feedback [0...99]

Specifies the amount of the output after wave shaping that will be fed back to the carrier.

1-3b: Modulator

Wave

[Saw, Square, Triangle, Sine, OSC2(1), Sub OSC, Filter1, Filter2]

Select the waveform of the modulator.

This selects the other oscillator or sub oscillator etc.

If you set this to **OSC2(1)**, **SubOSC**, **Filter1**, or **Filter2**, the **FrequencyCoarse** and following settings will not be available.

Level [0...99]

Specifies the output level of the modulator.

This value will determine the amount of modulation that is applied to the “1-3a: Carrier” setting.

AMS1 (Alternate Modulation Source 1) [Off...MIDI:CC#83]

Selects a modulation source 1 (⇒p.48 of this manual) that will control “Level.”

Intensity (Level AMS1 Intensity) [-99...+99]
Specifies the depth and direction of the effect of “AMS1.”

AMS2 (Alternate Modulation Source 2) [Off...MIDI:CC#83]

Selects a modulation source 2 (⇒p.48 of this manual) that will control “Level.”

Intensity (Level AMS2 Intensity) [-99...+99]

Specifies the depth and direction of the effect of “AMS2.”

Frequency Coarse [0.5, 1...16]

Specifies a multiplication factor which will be applied to the pitch of the modulator, relative to the “1-3a: Carrier” setting.

Fine [-50...+50]

Makes fine adjustments to the pitch of the modulator.

AMS1 (Alternate Modulation Source 1) [Off...MIDI:CC#83]

Selects a modulation source 1 (⇒p.48 of this manual) that will control the pitch of the modulator.

Intensity (Frequency AMS1 Intensity) [-99...+99]

Specifies the depth and direction of the effect of “AMS1.”

AMS2 (Alternate Modulation Source 2) [Off...MIDI:CC#83]

Selects a modulation source 2 (⇒p.48 of this manual) that will control the pitch of the modulator.

Intensity (Frequency AMS2 Intensity) [-99...+99]

Specifies the depth and direction of the effect of “AMS2.”

Resonance

This oscillator produces a wide range of tonal change by allowing you to specify the cutoff frequency and resonance of four band pass filters (**BPF**).

You can select one of the following sources to be the input for the filters: the output of the other oscillator, the sub-oscillator, the output of the noise generator, or the output of filter 1 or filter 2.

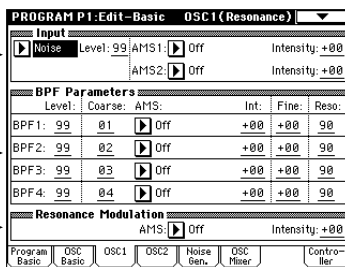
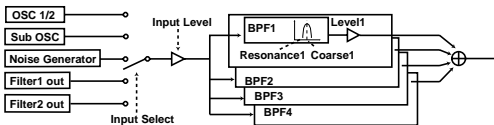

1-3a: Input

Input [OSC 2(1), Sub OSC, Noise, Filter1, Filter2]
Selects the signal that will be input to the four band pass filters.



If you select **Resonance** for OSC 1 and 2 in “1-2a: Multi Oscillator Synthesis Setup,” and select the other oscillator as the input for each, the result will be unstable — the sound may be non-reproduceable, or you may hear no sound at all.

Level [0...99]
Specifies the level of the signal that is input to the four band pass filters.

AMS1 (Alternate Modulation Source 1) [Off...MIDI:CC#83]

Selects a modulation source 1 (p.48 of this manual) that will control “Level.”

Intensity (Level AMS1 Intensity) [-99...+99]
Specifies the depth and direction of the effect of “AMS1.”

AMS2 (Alternate Modulation Source 2) [Off...MIDI:CC#83]

Selects a modulation source 2 (p.48 of this manual) that will control “Level.”

Intensity (Level AMS2 Intensity) [-99...+99]
Specifies the depth and direction of the effect of “AMS2.”

1-3b: BPF Parameters

Here, you can make settings for each band pass filter 1-4.

Level [0...99]
Specifies the output level.

Coarse [1...16]
Specifies the harmonic (overtone) of the oscillator pitch at which the center frequency of the filter will be located. You can specify from the first to the 16th harmonic.

AMS (Alternate Modulation Source) [Off...MIDI:CC#83]
Selects a modulation source (p.48 of this manual) that will control “Coarse.”

Int (BPF Frequency AMS Intensity) [-15...+15]
Specifies the depth and direction of the effect of AMS. **Positive** (+) settings will allow the Coarse value to be increased, and **negative** (-) settings will allow the Coarse value to be decreased. At this time, the center frequency of band pass filter 1 will change in steps of harmonics, creating the impression that the pitch is changing step-wise.

Fine [-99...+99]
Makes fine adjustments to the center frequency of band pass filter 1 specified by the Coarse parameter.

Reso (Resonance) [0...99]
Specifies the resonance. Increasing this value will produce a stronger effect.

1-3c: Resonance Modulation

AMS (Alternate Modulation Source) [Off...MIDI:CC#83]

Selects a modulation source (p.48 of this manual) that will control the resonance that was specified for each band pass filter.

Intensity (Resonance AMS Intensity) [-99...+99]
Specifies the depth and direction of the effect of “AMS.”

Ring Modulation

This multiplies the modulator and carrier and outputs the signal produced. One of four types of waveform can be selected as the carrier.

Since the result will be a metallic sound with little sense of pitch, this is suitable for producing sound effects. The Ring Modulation oscillator contains an internal carrier oscillator. The output of the other oscillator etc. can be selected as the modulator. By modifying the pitch of the oscillator, you can produce characteristic ring modulation effects.

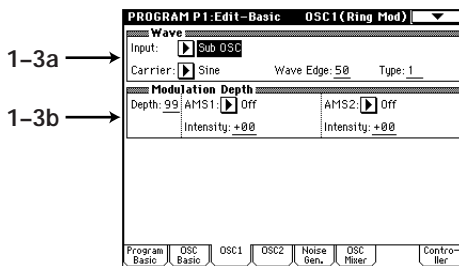

1-3a: Wave

Input [OSC 2(1), Sub OSC, Noise, Filter1, Filter2]
Specifies the modulator.

 If Ring Modulation is selected for both OSC 1 and 2, and the input of the other is selected for each, some parameter settings may produce no sound.

Carrier [Saw, Square, Triangle, Sine]
Specifies the carrier waveform.

Wave Edge [0...99]
Specifies the amount of high frequency harmonics for the carrier waveform. As this **value is decreased**, the sound will have less high-frequency harmonics, and as it approaches 0 the volume will also decrease.

Type [1, 2]
Selects the modulation type. The two types differ in the tone of the high range. Type 2 will produce a brighter sound than type 1.

1-3b: Modulation Depth

Depth [0...99]
Specifies the depth of modulation. At a setting of 0, the carrier waveform will be output without change.

AMS1 (Alternate Modulation Source 1) [Off...MIDI:CC#83]
Selects a modulation source 1 (⇒p.48 of this manual) that will control “Depth.”

Intensity (Modulation Depth AMS1 Intensity) [-99...+99]
Specifies the depth and direction of the effect of “AMS1.”

AMS2 (Alternate Modulation Source 2) [Off...MIDI:CC#83]
Selects a modulation source 2 (⇒p.48 of this manual) that will control “Depth.”

Intensity (Modulation Depth AMS2 Intensity) [-99...+99]
Specifies the depth and direction of the effect of “AMS2.”

Cross Modulation

This uses a modulator to frequency-modulate a carrier. You can select one of four waveforms as the carrier. In general, a pitch envelope is applied to the modulator. A carrier oscillator is built-in to the Cross Modulation OSC. You can select the output of the other oscillator etc. as the modulator. By modifying the pitch of the modulator oscillator, you can produce characteristic cross-modulation effects.

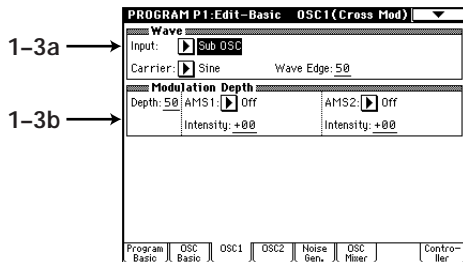

1-3a: Wave

Input [OSC2(1), Sub OSC, Noise, Filter1, Filter2]
Specifies the modulator.

Carrier [Saw, Square, Triangle, Sine]
Specifies the carrier waveform.

Wave Edge [0...99]
Specifies the amount of high frequency harmonics for the carrier waveform. As this **value is decreased**, the sound will have less high-frequency harmonics, and as it approaches 0 the volume will also decrease.

1-3b: Modulation Depth

Depth [0...99]
Specifies the depth of modulation. At a setting of 0, the carrier waveform will be output without change.

AMS1 (Alternate Modulation Source 1) [Off...MIDI:CC#83]
Selects a modulation source 1 (⌘p.48 of this manual) that will control “Depth.”

Intensity (Modulation Depth AMS1 Intensity) [-99...+99]
Specifies the depth and direction of the effect of “AMS1.”

AMS2 (Alternate Modulation Source 2) [Off...MIDI:CC#83]
Selects a modulation source 2 (⌘p.48 of this manual) that will control “Depth.”

Intensity (Modulation Depth AMS2 Intensity) [-99...+99]
Specifies the depth and direction of the effect of “AMS2.”

Sync Modulation

This uses the modulator as the master waveform and the carrier as the slave waveform (which will be synchronized to the master).

When the master waveform begins a new cycle (i.e., the instant that it passes the zero point going from negative to positive), the phase of the slave waveform is reset to 0, causing it to begin a new cycle.

Sync Modulation

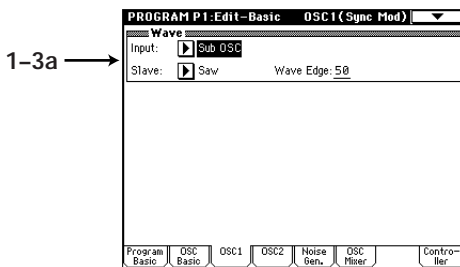
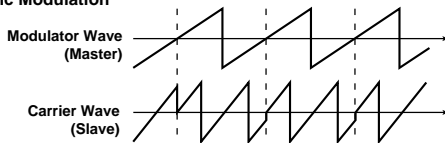

1-3a: Wave

Input [OSC2(1), Sub OSC, Noise, Filter1, Filter2]
Specifies the master waveform (modulator).

Slave [Saw, Square, Triangle, Sine]
Specifies the slave waveform.

Wave Edge [0...99]
Specifies the amount of high frequency harmonics for the slave waveform. As this **value is decreased**, the sound will have less high-frequency harmonics, and as it approaches 0 the volume will also decrease.

Organ Model

This is an oscillator used to produce organ-type sounds. The oscillator simulates three drawbars similar to electric organs of the past.

You can specify the footage [Harmo] and waveform setting for each drawbar, allowing a wide range of sounds to be created.

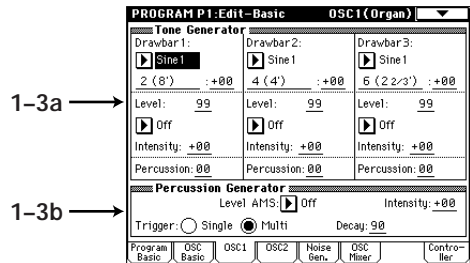
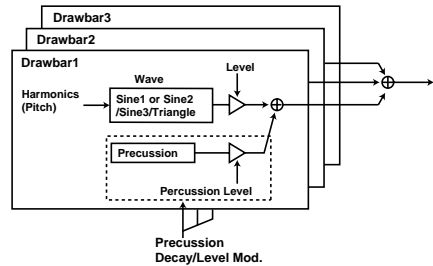

1-3a: Tone Generator

Drawbar1:

Wave [Sine 1, Sine 2, Sine 3, Triangle]
Specifies the waveform for drawbar 1. **Sine 1** contains only the fundamental (i.e., a pure sine wave). **Sine 2** and **Sine 3** are waveforms which contain the first two and the first three harmonics respectively.

Coarse (Harmonics Coarse) [1(16')...16(1')]
Specifies the pitch of drawbar 1, relative to one octave below the oscillator pitch.

Fine (Harmonics Coarse Fine) [-99...+99]
Makes fine adjustments to the pitch of drawbar 1.

Level [0...99]
Specifies the volume level of drawbar 1.

AMS (Alternate Modulation Source) [Off...MIDI:CC#83]
Selects a modulation source (see p.48 of this manual) that will control the "Level" of drawbar 1.

Intensity (Level AMS Intensity) [-99...+99]
 Specifies the depth and direction of the effect of “AMS1.”

Percussion [0...99]
 Specifies the volume level of the percussion effect for drawbar 1.

Drawbar 2:

Drawbar 3:

The parameters are structured identically to those of “1–3a: Drawbar 1.”

Level AMS (Level Alternate Modulation Source) [Off...MIDI:CC#83]

Selects a modulation source (p.48 of this manual) that will control the percussion level of each drawbar.

Intensity (Level AMS Intensity) [-99...+99]
 Specifies the depth and direction of the effect of “Level AMS” on the percussion level.

Trigger [Single/Multi]

Use **the radio buttons** to specify how the percussion effect will be triggered.

With a setting of **Single**, the percussion effect will apply to the first-played note from a condition of no sound.

With a setting of **Multi**, the percussion effect will apply to each note that is played.

Decay [0...99]
 Specifies the decay length of the percussion. As this value is increased the decay time will become longer.

E. Piano Model

This oscillator simulates an electric piano.

There are four groups of parameters: Hammer (which specifies how the shape and motion of the hammer will affect tonal change and attack noise), Tone Generator (which vibrates in response to being struck by the hammer), Pickup (which specifies the tonal change that occurs when the vibration of the tone generator is converted into an electrical signal), and Low EQ (which is a shelving-type low EQ to adjust the low range).

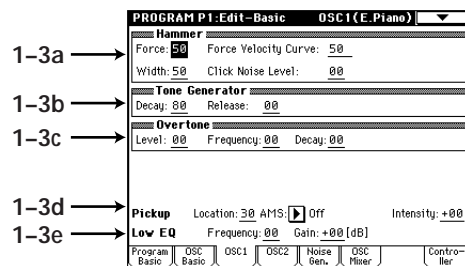
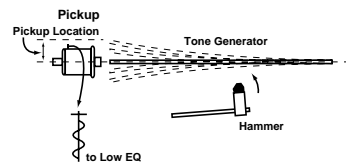

1–3a: Hammer

Force [0...99]

Specifies the “Strength” with which the hammer strikes the tone generator. **Higher settings** will produce a brighter sound.

Force Velocity Curve [OFF, 0...99]

Specifies how changes in velocity will affect “Force.” As this **value is increased**, velocity will have a greater effect on “Force,” allowing more dynamic tonal change to be produced. With a setting of **OFF**, the “Force” will be constant.

Width (Hammer Width) [0...99]

Simulates the shape of the hammer. As this **value is increased**, the width of the hammer will become narrower, and the sound of the tone generator and hammer noise will become sharper.

Click Noise Level [0...99]

Specifies the volume of the hammer noise that occurs at the attack.

1-3b: Tone Generator

The Decay and Release that you specify here will control the output level of the oscillator. In order for these settings to have an effect, they must be set longer than the decay and release of the EG which you are using for the Amp.

Decay [0...99]
Specifies the decay time of the tone generator.

Release [0...99]
Specifies the release time of the tone generator.

1-3c: Overtone

Level [0...99]
Specifies the volume of the higher overtones that are produced when the tone generator vibrates.

Frequency [0...99]
Specifies the frequency of the overtones.

Decay [0...99]
Specifies the decay time of the overtone volume.

1-3d: Pickup

Location [0...99]
Specifies the location of the pickup in relation to the tone generator. With low settings, the pickup will be placed in the center of the vertical vibration of the tone generator, causing the second partial to be emphasized and the fundamental to be less audible.

AMS (Alternate Modulation Source) [Off...MIDI:CC#83]
Selects a modulation source (see p.48 of this manual) that will control "Location."

Intensity (Pickup Location AMS Intensity) [-99...+99]
Specifies the depth and direction of the effect of "AMS."

1-3e: Low EQ

Makes settings for a Low EQ (shelving type) that will adjust the output signal.

Frequency [0...49]
Specifies the cutoff frequency of the Low EQ (shelving type) that will be applied to the output signal.

Gain [-18...+18]
Specifies the gain of the Low EQ.

Brass Model

This oscillator is a physical model which simulates lip-reed instruments such as a trumpet or trombone. By using key velocity or modulation wheel to modulate the Pressure (the force of breath blown into the mouth-piece) you can produce performance expressions that are very similar to those of an actual lip-reed instrument. The parameters are as follows: Inst Type determines the model which simulates the bore length and shape of the instrument, Breath Pressure indicates the force of breath that is blown into the mouthpiece, Lip Character produces the tonal changes that result from lip position or tension, Bell Character produces the tonal changes that result from the shape of the end of the bore, and Peaking EQ performs a final tonal adjustment.

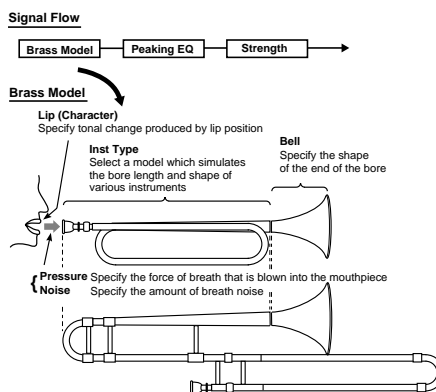

This oscillator allows you to choose from two types of pitch bending: jump bending using a mode jump as on a trumpet (by varying the bore length), and smooth bending produced by sliding the length of the bore as on a trombone.



For some parameter settings, the pitch may not change according to the notes that are played on the keyboard. In some cases, high-pitched notes may have a lower volume, or may not sound at all.

The screenshot shows the 'PROGRAM P1:Edit-Basic' interface for the Brass Model. The 'Inst Type' is set to 'Brass 1'. The 'Jump Bend' checkbox is checked, and the 'JS(-X)' checkbox is also checked. The 'Breath Pressure' section includes 'EG: EG 1' with 'Intensity: +80', 'AMS1: Off' with 'Intensity: +80', 'AMS2: Off' with 'Intensity: +80', and 'Strength: 80'. The 'Breath Noise' is set to '00'. The 'Lip Character' section includes 'Lip: 80', 'AMS: Off', and 'Intensity: +80'. The 'Bell Character' section includes 'Tone: 50' and 'Resonance: 10'. The 'Peaking EQ' section includes 'Frequency: 00', 'Q: 00', and 'Gain: +00[dB]'. At the bottom, there are buttons for 'Program Basic', 'OSC Basic', 'OSC1', 'OSC2', 'Noise Gen.', 'OSC Mixer', and 'Controller'.

1-3a: Inst Type

Inst Type
[Brass 1, Brass 2, Brass 3, Horn 1, Horn 2, Reed Brass]
Selects the instrument type which will determine the bore length and shape of the simulated instrument.

Jump Bend:

JS(+X) (Joystick +X)

Specifies how the pitch will change when the joystick is moved in the +X direction (toward the right).

If this is **checked**, the pitch will rise by in steps by changing the resonance of the bore, as on a trumpet. If this is **unchecked**, the pitch will rise smoothly, as on most synthesizers.

JS(-X) (Joystick -X)

Specifies how the pitch will change when the joystick is moved in the -X direction (toward the left).



If Jump Bend (+X) and Jump Bend (-X) are **checked**, notes may not sound depending on the position of the joystick and the pitch range setting. For details on setting the pitch range of the joystick, refer to “2-4a: Pitch Bend.”

1-3b: Breath Pressure

EG [EG 1...EG 4, Amp EG]

Selects the EG which will control pressure.

For details on the settings for each EG, refer to “Program P6” for EG 1-4, and “4-3: Amp EG” for Amp EG.

Intensity (Pressure EG Intensity) [-99...+99]

Specifies the depth and direction of the effect that the “EG” will have on the pressure.

AMS1 (Alternate Modulation Source 1) [Off...MIDI:CC#83]

Selects a modulation source 1 (☞p.48 of this manual) that will control pressure. If you select **After Touch**, pressing down on the keyboard will produce the effect of the instrument being blown strongly. If you select **Joy Stick(X)**, rotating the Joy Stick in the + direction will produce this effect. In this case, setting “Intensity (Pressure EG Intensity)” to 0 will allow you to completely control the breath pressure by operating the specified controller.

Intensity (Pressure AMS1 Intensity) [-99...+99]

Specifies the depth and direction of the change in pressure controlled by “AMS1.”

AMS2 (Alternate Modulation Source 2) [Off...MIDI:CC#83]

Selects a modulation source 2 (☞p.48 of this manual) that will control pressure.

Intensity (Pressure AMS2 Intensity) [-99...+99]

Specifies the depth and direction of the change in pressure controlled by “AMS2.”

Breath Noise [0...99]

Specifies the volume level of the breath noise. Since

this uses the signal from the noise generator, the filter of the noise generator can be used to modify the tone of the noise.

Strength [0...99]

Adjusts the tone. **Higher settings** of this value will produce a overdriven sound.

1-3c: Lip Character

Lip [0...99]

Specifies the tonal change that is produced by lip position and tension. **Higher settings** of this value will produce a harder (more firmly blown) sound. **Lower settings** will produce a softer tone.

AMS (Alternate Modulation Source) [Off...MIDI:CC#83]

Selects a modulation source (☞p.48 of this manual) that will control “Lip.”

Intensity (Lip Character AMS Intensity) [-99...+99]

Specifies the depth and direction of the effect of “AMS.”

1-3d: Bell Character

Tone [0...99]

Specifies the tone of the bell. As this **value is increased**, the low frequency portion will disappear, producing a less solid tone.

Resonance [0...99]

Specifies the level at which the frequency region in the area of the “Tone” will be boosted. As this **value is increased**, the resonance effect will become stronger.

1-3e: Peaking EQ

Frequency [0...49]

Specifies the center frequency of the frequency range that will be boosted or attenuated by the Peaking EQ. **Increasing this value** will raise the center frequency.

Q [0...29]

Specifies the width of the Peaking EQ frequency band. **Increasing this value** will narrow the frequency band that is boosted or attenuated.

Gain [-18...+18]

Specifies the amount by which the area specified by “Frequency” and “Q” will be boosted or attenuated.

Reed Model

This oscillator is a physical model which simulates woodwind reed instruments such as a saxophone or oboe. By using key velocity or the modulation wheel to control Pressure (the strength with which the reed is blown), you can use performance expressions that are very close to those of an actual woodwind instrument. Also, by modulating the characteristics of the reed, you can produce tonal changes that correspond with the way in which a reed is blown.

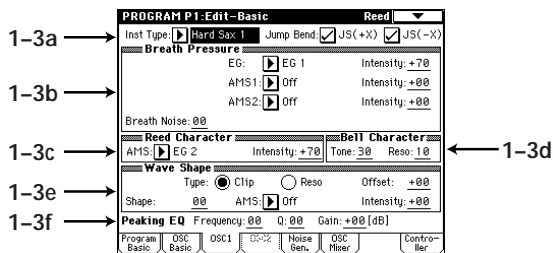
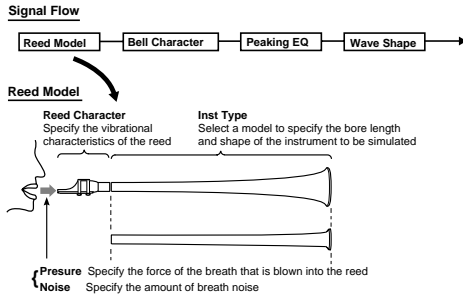

1-3a: Inst Type

Inst Type [Hard Sax 1...Reed Synth]
Selects the type of instrument whose bore shape and reed characteristics will be simulated.

Hard Sax 1, Hard Sax 2, Hard Sax 3, Soft Sax 1, Soft Sax 2, Double Reed 1, Double Reed 2, Bassoon, Clarinet, Flute 1, Flute 2, Pan Flute, Ocarina, Shakuhachi, Harmonica 1, Harmonica 2, Reed Synth

Jump Bend:
JS(+X) (Joystick +X)

Specifies how the pitch will change when the joystick is moved in the +X direction (toward the right). If this is **checked**, the pitch will rise in steps by changing the resonance of the bore, as on a flute. If this is **unchecked**, the pitch will rise smoothly, as on most synthesizers.

JS(-X) (Joystick -X)

Specifies how the pitch will change when the joystick is moved in the -X direction (toward the left).



If Jump Bend (+X) and Jump Bend (-X) are checked, notes may not sound depending on the position of the joystick and the pitch range setting.

For details on setting the pitch range of the joystick, refer to “1-2c: Pitch Bend.”

1-3b: Breath Pressure

EG [EG 1...EG 4, AmpEG]

Selects the EG which will control pressure.

For details on the settings for each EG, refer to “Program P6” for EG 1-4, and “4-3: Amp EG” for Amp EG.

Intensity (Pressure EG Intensity) [-99...+99]

Specifies the depth and direction of the effect that the EG will have on the pressure.

AMS1 (Alternate Modulation Source 1)

[Off...MIDI:CC#83]

Selects a modulation source 1 (p.48 of this manual) that will control pressure. If you select **After Touch**, pressing down on the keyboard will produce the effect of the instrument being blown strongly. If you select **Joy Stick (X)**, moving the joy stick toward the right will produce this effect.

Intensity (Pressure AMS1 Intensity) [-99...+99]

Specifies the depth and direction of the change in pressure controlled by AMS1.

AMS2 (Alternate Modulation Source 2)

[Off...MIDI:CC#83]

Selects a modulation source 2 (p.48 of this manual) that will control pressure.

Intensity (Pressure AMS2 Intensity) [-99...+99]

Specifies the depth and direction of the change in pressure controlled by AMS2.

Breath Noise

[0...99]

Specifies the volume level of the breath noise. Since this uses the signal from the noise generator, the filter of the noise generator can be used to modify the tone of the noise.

1-3c: Reed Character

AMS (Alternate Modulation Source) [Off...MIDI:CC#83]

Selects a modulation source (⇒p.48 of this manual) that will modulate the characteristics of the reed.

Intensity (Reed AMS Intensity) [-99...+99]
Specifies the depth of the modulation effect that “AMS” will have on the reed.

1-3d: Bell Character

Tone [0...99]
Specifies the tone of the bell. As this **value is increased**, the low frequency portion will disappear, producing a less solid tone.

Reso [0...99]
Specifies the level at which the frequency region in the area of the “Tone” will be boosted. As this **value is increased**, the resonance effect will become stronger.

1-3e: Wave Shape

Type (Wave Shape Table Type) [Clip/Reso]
Use **the radio buttons** to select the wave shaping table which will modify the input waveform. For the way in which the table will modify the waveform, refer to the Wave Shape diagram shown in **Standard** (⇒page 16 of this manual).

Offset [-99...+99]
Specifies the offset value that will be added to the Reed OSC signal that is input to wave shaping.

Shape [0...99]
Specifies the character of the table that will shape the input waveform. For details on how the waveform will change, refer to the “Shape” diagram (⇒page 16 of this manual) for the **Standard OSC**.

AMS (Alternate Modulation Source) [Off...MIDI:CC#83]

Selects a modulation source (⇒p.48 of this manual) that will control “Shape.”

Intensity (Shape AMS Intensity) [-99...+99]
Specifies the depth and direction of the effect of “AMS.”

1-3f: Peaking EQ

Frequency [0...49]
Specifies the center frequency of the range that will be boosted or attenuated by the Peaking EQ. **Increasing this value** will raise the center frequency.

Q [0...29]
Specifies the width of the Peaking EQ frequency band. **Increasing this value** will narrow the frequency band that is boosted or attenuated.

Gain [-18...+18]
Specifies the amount by which the range specified by “Frequency” and “Q” will be boosted or attenuated.

Plucked String Model

This oscillator is a physical model which simulates plucked string instruments such as a guitar or bass guitar. You can specify aspects of the model such as the attack waveform that is produced when the string is plucked by a pick or finger, the characteristics of the string, the location of the pickup, etc.

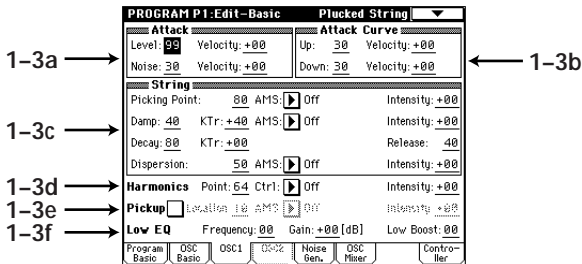
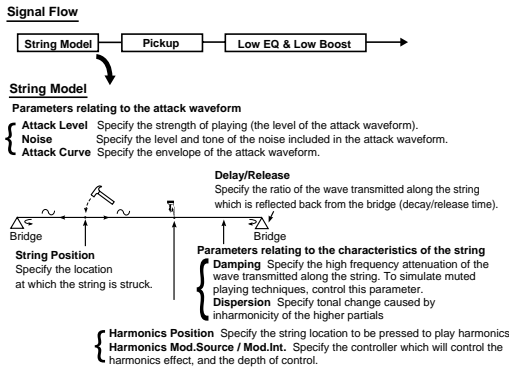

1-3a: Attack

Attack Level [0...99]
Specifies the force with which the string is plucked.

Velocity (Attack Level Velocity Control) [-99...+99]
Specifies the depth and direction of the effect that velocity will have on "Attack Level." The effect will be as shown in the following diagram.

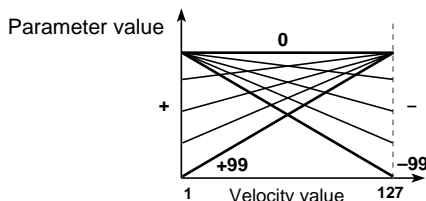

Noise Level [0...99]

Specifies the level of the noise component that is included in the attack waveform. As this **value is increased**, a greater portion of noise will be included in the attack, and the sound will be brighter with more overtones. The noise signal used here is taken from the output of the noise generator.

Velocity (Noise Level Velocity Control) [-99...+99]

Specifies the depth and direction of the effect that velocity will have on Noise Level. For the way in which the effect occurs, refer to "Velocity (Attack Level Velocity Control)."

1-3b: Attack Curve

Up (Curve Up) [0...99]

Specifies the steepness of the rising edge of the attack waveform. When the rising or falling edge is steep, the tone will be harder.

Envelope of the attack waveform

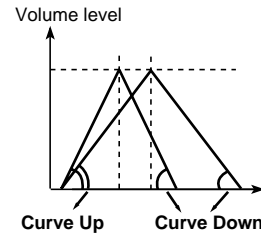

Velocity (Curve Up Velocity Control) [-99...+99]

Specifies the depth and direction of the effect that velocity will have on "Up." For the way in which the effect occurs, refer to "Velocity (Attack Level Velocity Control)."

Down (Curve Down) [0...99]

Specifies the steepness of the falling edge of the attack waveform.

Velocity (Curve Down Velocity Control) [-99...+99]

Specifies the depth and direction of the effect that velocity will have on "Curve Down." For the way in which the effect occurs, refer to "Velocity (Attack Level Velocity Control)."

1-3c: String

Picking Point [0...99]

Specifies the location at which the string will be plucked. A setting of **0** is the end of the string, **50** is the middle of the string, and **99** is the other end of the string.

AMS (Alternate Modulation Source) [Off...MIDI:CC#83]

Selects a modulation source (☞p.48 of this manual) that will control “Picking Point.”

Intensity (Picking Point AMS Intensity) [-99...+99]

Specifies the depth and direction of the effect of “AMS.”

Damp [0...99]

Specifies the amount of high-frequency attenuation that will be produced by the characteristics of the string and by how the string is pressed. As this **value is increased**, the high-frequency components of the vibration in the string will be attenuated (dampened) more strongly, producing a darker sound. In general, this parameter should be set to a higher value to simulate instruments which use soft strings or which have no frets, and to a lower value to simulate instruments which use hard strings or which have frets.

KTr (Damp Keyboard Track) [-99...+99]

Specifies how the Damp amount will be affected by the keyboard location.

With **positive (+)** settings, the Damp value will increase as you play notes above C4.

With **negative (-)** settings, the Damp will decrease as you play notes above C4.

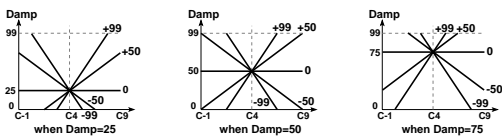

AMS (Alternate Modulation Source) [Off...MIDI:CC#83]

Selects a modulation source (☞p.48 of this manual) that will control “Damp.”

Intensity (Damp AMS Intensity) [-99...+99]

Specifies the depth and direction of the effect that “AMS” will have.

Decay [0...99]

Specifies the decay time over which the sound will decay if you continue pressing a note. **Higher settings of this value** will produce a longer decay time.

 Depending on the settings of “4-3: Amp EG”, the setting you make here may not have audible results. If you raise the EG break level and sustain level, it will be easier to hear the result of this setting.

KTr (Decay Keyboard Track) [-99...+99]

Specifies how the “Decay” amount will be affected by the keyboard location.

With **positive (+)** settings, the decay will become faster as you play notes above C4. With **negative (-)** settings, it will become slower.

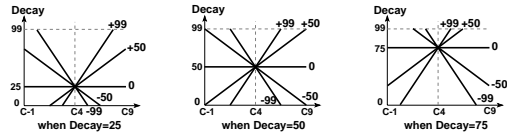

Release [0...99]

Specifies the length of time over which the sound will decay after you release the note. Higher settings of this value will produce a longer release time.

 Depending on the settings of “4-3: Amp EG”, the setting you make here may not have audible results. You may need to raise the EG release level, it will be easier to hear the result of this setting.

Dispersion [0...99]

Specifies the inharmonicity of the higher partials relative to the fundamental. With a value of **0**, the partials will be located at integer (whole number) multiples of the fundamental. As this **value is increased**, the partials will move further away from integer multiple locations. In general, thin and flexible strings can be simulated by a low “Dispersion” value, and thick and stiff strings can be simulated by a high “Dispersion” value.

 If this value is raised excessively, the pitch may become unstable.

AMS (Alternate Modulation Source) [Off...MIDI:CC#83]

Selects a modulation source (☞p.48 of this manual) that will control “Dispersion.”

Intensity (Dispersion AMS Intensity) [-99...+99]

Specifies the depth and direction of the effect of “AMS.”

1-3d: Harmonics

Point [0...99]

Specifies the location at which the string will be pressed to play harmonics.

Ctrl (Control) [Off...MIDI:CC#83]

Selects a modulation source (⇒p.48 of this manual) that will control the harmonics effect.

Intensity (Harmonics Control Intensity) [-99...+99]

Specifies the depth and direction of the control that “Ctrl” will have on the harmonics effect.



When making the Position setting, you must assign Control to a controller other than OFF, and raise the Intensity value. The decay time of the harmonics effect will differ depending on the keyboard location that you play.

1-3e: Pickup

Pickup

If this is **checked**, the sound will be passed through a simulated pickup. If this is **not checked**, the sound will remain unchanged.



Location, AMS, and Intensity can be set when Pickup has been **checked**.

Location [0...99]

Adjusts the change in tone that results from differences in pickup location.

AMS (Alternate Modulation Source) [Off...MIDI:CC#83]

Selects a modulation source (⇒p.48 of this manual) that will control “Pickup.”

Intensity (Pickup Location AMS Intensity) [-99...+99]

Specifies the depth and direction of the effect of “AMS.”

1-3f: Low EQ

Frequency [0...49]

Specifies the cutoff frequency of the Low EQ.

Gain [-18...+18]

Specifies the gain of the Low EQ.

Low Boost [0...99]

Specifies how the low frequency range will be emphasized. **Raising this value** will cause the low frequency range to be emphasized more strongly.

Bowed String Model

This oscillator is a physical model which simulates the sound of a bowed string instrument such as a violin or cello. By controlling the bowing speed and the bowing pressure, you can create performance expressions that are very close to those of an actual bowed string instrument.

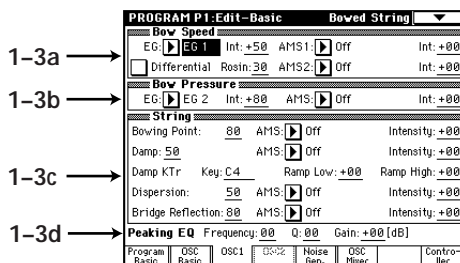
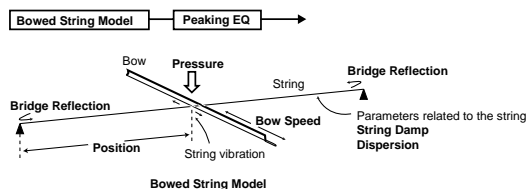

1-3a: Bow Speed

EG [EG 1...EG 4, AmpEG]

Selects the EG which will control bowing speed (the speed at which the bow moves across the string).

Int (Speed Modulation EG Intensity) [-99...+99]

Specifies the depth and direction of the effect of “EG” With negative (-) settings, the direction of the bow speed will be inverted.

AMS1 (Alternate Modulation Source 1) [Off...MIDI:CC#83]

Selects a modulation source 1 (⇒p.48 of this manual) that will control bowing speed.

Instead of using an EG to modify the bowing speed, you can use the Ribbon Controller or Joy Stick to simulate bowing without using an EG.

Int (Speed AMS1 Intensity) [-99...+99]

Specifies the depth and direction of the effect of “AMS1.”

AMS2 (Alternate Modulation Source 2) [Off...MIDI:CC#83]

Selects a modulation source 2 (⇒p.48 of this manual) that will control bowing speed.

Int (Speed AMS2 Intensity) [-99...+99]

Specifies the depth and direction of the effect of “AMS2.”

Differential

If this is **not checked**, the value produced by EG, AMS1 and AMS2 will be used as the bowing speed. If you wish to use EG to control the bowing speed, leave this item **un-checked**.

If this is checked, the rate of change of EG, AMS1 and AMS2 will be used as the bowing speed.

• Using the ribbon controller to control bowing speed

As an example, we will assume that you have set AMS1 to **Ribbon (X)**. In order to control bowing speed using the ribbon controller alone, raise the Int. (Speed AMS1 Intensity) value, and set Int. (Speed Modulation EG Intensity) to **0**. Check Differential. When you are pressing the ribbon controller, the bowing speed will be zero, so there will be no sound. As you slide your finger toward the right over the ribbon controller, the speed at which your finger moves will be the bowing speed, and sound will be produced. As you slide your finger to left and right, the bowing speed will change from positive → zero → negative → zero → positive, allowing you to produce performance expressions that are very similar to those of actually moving a bow back and forth.

Rosin [0...99]

Specifies the coefficient of static friction between the bow and the string. (This corresponds to the amount of rosin on the bow.)

Higher values will increase the friction between the bow and string. When this value is in the region of **0**, it will be difficult for playing strength to be transmitted to the string.

1-3b: Bow Pressure**EG** [EG 1...EG 4, AmpEG]

Selects the **EG** which will control the pressure of the bow on the string (bow pressure).

Int (Pressure EG Intensity) [-99...+99]

Specifies the depth and direction of the effect that the “EG” will have on bow pressure.

If **this value is low**, the bow will rest lightly on the string.

AMS (Alternate Modulation Source) [Off...MIDI:CC#83]

Selects a modulation source (⇒p.48 of this manual) that will control bow pressure.

Int (Pressure AMS Intensity) [-99...+99]

Specifies the depth of the effect produced by “AMS.”

1-3c: String**Bowing Point** [0...99]

Specifies the location at which the bow contacts the string. A setting of **0** is the end of the string, **50** is near the middle, and **99** is at the other end.

AMS (Alternate Modulation Source) [Off...MIDI:CC#83]

Selects a modulation source (⇒p.48 of this manual) that will control “Bowing Point.”

Changing the location at which the string is bowed will also change the overtone structure.

Intensity (Bowing Point AMS Intensity) [-99...+99]

Specifies the depth and direction of the effect of “AMS.”

Damp [0...99]

Specifies how the high frequency components will be attenuated by the characteristics of the string and by the way in which the string is pressed onto the fingerboard of the violin or cello.

As this **value is increased**, the high frequency components of the wave transmitted along the string will be attenuated more greatly, producing a darker sound. In general, you should use higher values to simulate instruments which have flexible strings or unfretted instruments, and lower values to simulate instruments with stiff strings or fretted instruments.

AMS (Alternate Modulation Source) [Off...MIDI:CC#83]

Selects a modulation source (⇒p.48 of this manual) that will control “Damp.”

Intensity (Damp AMS Intensity) [-99...+99]

Specifies the depth and direction of the effect of “AMS.”

Damp KTr Key (Damp Keyboard Track Key) [C-1...G9]

Specifies the key above and below which keyboard tracking will begin to apply to the “Damp” effect.

note You can also input a value by playing a note on the keyboard while you hold down the [ENTER] key.

Ramp Low [-99...+99]

Specifies the depth and direction in which the “Damp” amount will change for notes below the “Damp KTr Key.” **Positive (+)** settings will cause “Damp” to increase for notes below the “Damp KTr Key.” **Negative (-)** settings will cause “Damp” to decrease for notes below the “Damp KTr Key.”

Ramp High [-99...+99]

Specifies the depth and direction in which the “Damp” amount will change for notes above the “Damp KTr Key.” **Positive (+)** settings will cause “Damp” to increase for notes above the “Damp KTr Key.” **Negative (-)** settings will cause “Damping” to decrease for notes above the “Damping KTr Key.”

Dispersion [0...99]

Specifies the inharmonicity of the higher partials relative to the fundamental. With a value of **0**, the partials will be located at integer (whole number)x multiples of the fundamental. As this value is increased, the partials will move further away from integer multiple locations. In general, thin and flexible strings can be simulated by a low “Dispersion” value, and thick and stiff strings can be simulated by a high “Dispersion” value.



If this value is raised excessively, the pitch may become unstable.

AMS (Alternate Modulation Source) [Off...MIDI:CC#83]

Selects a modulation source (see p.48 of this manual) that will control “Dispersion.”

Intensity (Dispersion AMS Intensity) [-99...+99]

Specifies the depth and direction of the effect of “AMS.”

Bridge Reflection [0...99]

Specifies the amount of the wave that will be reflected at the end of the string. **Higher values** will make the notes sound more easily. With a setting of **0** there will be no reflection at all.

AMS (Alternate Modulation Source) [Off...MIDI:CC#83]

Selects a modulation source (see p.48 of this manual) that will control “Bridge Reflection.”

Intensity (Bridge Reflection AMS Intensity) [-99...+99]

Specifies the depth and direction of the effect of “AMS.”

1-3d: Peaking EQ

Frequency [0...49]

Specifies the center frequency at which the peaking EQ will boost (attenuate) the sound.

Q [0...29]

Specifies the width of the region that will be boosted (attenuated) by the peaking EQ. With a setting of **0**, a wide region will be affected. With a setting of **29**, only a narrow region close to the center frequency will be boosted (attenuated).

Gain [-18...+18]

Specifies the gain by which the peaking EQ will boost or attenuate.

1-4: OSC2 (Oscillator 2)

OSC2 parameters have the same structure as OSC1 parameters. Refer to “1-3: OSC 1.”

1-5: Noise Generator

Make settings for the noise generator.

The noise generator produces white noise. The noise signal is passed through a dedicated filter, and is then mixed with the oscillator 1, 2, and sub oscillator signals by the mixer section. (Refer to 1-6: OSC Mixer.)

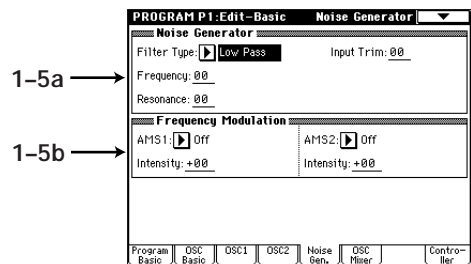
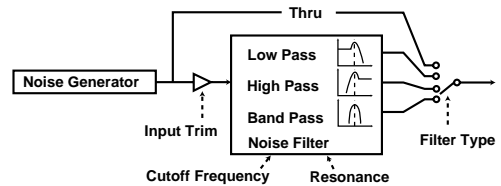

1-5a: Noise Generator

Filter Type [Thru, Low Pass, High Pass, Band Pass]

Selects the type of filter that will be applied to the output of the noise generator.

If **Thru** is selected, the parameter settings described below will not be available.

Input Trim [0...99]

Specifies the input level to the dedicated noise filter.

Frequency (Cutoff Frequency) [0...99]

Specifies the cutoff frequency of the noise signal filter. For the characteristics of each filter type, refer to “3-1:Filter1” (see page 38 of this manual).

Resonance [0...99]

This boosts the frequency region specified by the “Cutoff Frequency” to add character to the sound.

Since the filter characteristics differ from the filter type of the “3-1: Filter 1,” “3-3: Filter 2” the resulting effect will be different even if “Filter Type,” “Frequency” and “Resonance” settings are identical.

1-5b: Frequency Modulation

AMS1 (Alternate Modulation Source 1)

[Off...MIDI:CC#83]

Selects a modulation source 1 (☞ p.48 of this manual) that will control the “Frequency.”

Intensity (Cutoff Frequency AMS1 Intensity)

[-99...+99]

Specifies the depth and direction of the effect of “AMS1.”

AMS2 (Alternate Modulation Source 2)

[Off...MIDI:CC#83]

Selects a modulation source 2 (☞ p.48 of this manual) that will control the “Frequency.”

Intensity (Cutoff Frequency AMS2 Intensity)

[-99...+99]

Specifies the depth and direction of the effect of “AMS2.”

1-6: OSC Mixer

The mixer allows you to set the levels at which the five signals (OSC 1, OSC 2, Sub OSC, Noise Generator, Feedback) will be combined into the two mixer outputs. You can also select a modulation source to control each level, and specify its intensity.

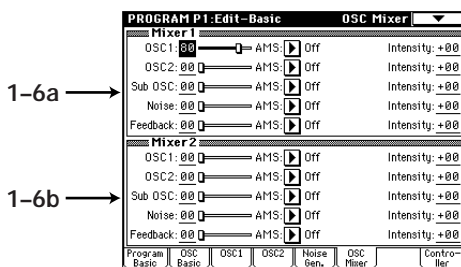

1-6a: Mixer1

These parameters adjust the level at which the oscillator 1 signal is output from mixer output 1, and specify a modulation source that will control this level.

OSC1 (OSC1 Output Level)

[00...99]

Specifies the signal level that will be output to mixer output 1.

AMS (Alternate Modulation Source)

[Off...MIDI:CC#83]

Selects a modulation source (☞ p.48 of this manual) that will control “output level.”

Intensity (Level AMS Intensity)

[-99...+99]

Specifies the depth and direction of the effect of “AMS.”

With **positive (+) settings**, higher values of the modulation source will increase the “output level.”

With **negative (-) settings**, lower values of the modulation source will increase the “output level.” If **EG** or **LFO** has been selected as the “AMS”, **positive (+) settings** will cause the original phase of the EG or LFO to be used, and **negative (-) settings** will invert the phase.

OSC2 (OSC2 Output Level)

These parameters adjust the level at which the oscillator 2 signal is output from mixer output 1, and specify a modulation source that will control this level.

Sub OSC

These parameters adjust the level at which the sub oscillator signal output is output from mixer output 1, and specify a modulation source that will control this level.

Noise

These parameters adjust the level at which the output of the noise generator is output from mixer output 1, and specify a modulation source that will control this level.

Feedback

These parameters adjust the level at which the feedback from the amp section is output from mixer output 1, and specify a modulation source that will control this level.



Raising the Feedback level excessively may cause the sound to distort.

1-6b: Mixer2

These parameters adjust the level at which the oscillator 1 signal is output from mixer output 2, and specify a modulation source that will control this level.

Refer to the above explanation of “1-6a: Mixer 1.”

1-7: Controller Setup

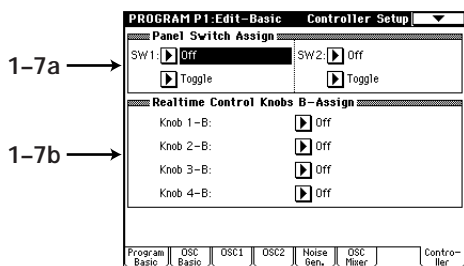

1-7a: Panel Switch Assign

Assign the function of the front panel [SW1] and [SW2] keys.

☞ Refer to TRITON Parameter Guide p.217 “SW1, SW2 Assign List.”

Since the [SW1] and [SW2] settings of the program assigned to each timbre are not used by a combination, they must be set here again.

☞ Refer to TRITON Parameter Guide p.8 “Panel Switch Assign” (Program P1: 1-4a).

SW1 (SW1 Assign) **AMSource** [Off, ..., After Touch Lock]

SW1 Mode [Toggle, Momentary]

SW2 (SW2 Assign) **AMSource** [Off, ..., After Touch Lock]

SW2 Mode [Toggle, Momentary]

1-7b: Realtime Control Knobs B-Assign

Here you can assign the B-mode functions (mainly various types of control change) for the front panel REALTIME CONTROLS [1]–[4] knobs. The functions you select here will operate when you move the corresponding knob of the REALTIME CONTROLS [1]–[4] knobs when B-mode is selected.

☞ Refer to TRITON Parameter Guide p.218 “Realtime Control Knobs B-Assign List.”

Knob 1-B [Off, ..., MIDI CC #00...CC #95]

Knob 2-B [Off, ..., MIDI CC #00...CC #95]

Knob 3-B [Off, ..., MIDI CC #00...CC #95]

Knob 4-B [Off, ..., MIDI CC #00...CC #95]

Program P2: Edit-Pitch

2-1: OSC1 P. Mod (Oscillator 1 Pitch Modulation)

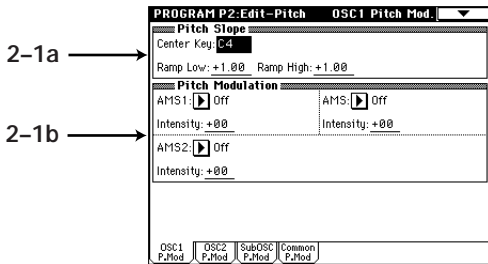

2-1a: Pitch Slope

Specifies how pitch will change in relation to the keyboard (key.)

Center Key [C-1...G9]

Specifies the key at which Lower/Higher keyboard tracking will begin to apply.

note You can also input a value by playing a note on the keyboard while you hold down the [ENTER] key.

Ramp Low [-1.00...+2.00]

Specifies the depth and direction of the pitch change that will occur for notes below the "Center Key."

Ramp High [-1.00...+2.00]

Specifies the depth and direction of the pitch change that will occur for notes above the Center Key.

When Low Slope and High Slope are set to +2.0, playing one octave upward from the Center Key will cause the pitch to rise two octaves.

With a setting of -1.0, playing one octave upward will cause the pitch to fall one octave. With a setting of 0.0, the notes in the respective areas will produce the same pitch as the Center Key. To play pitches normally, set this parameter to +1.0.

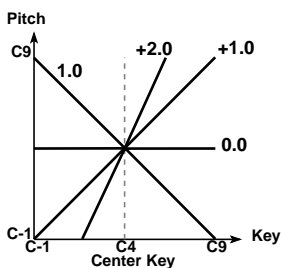

2-1b: Pitch Modulation

Specifies the pitch Modulation.

AMS1 (Alternate Modulation Source 1) [Off...MIDI:CC#83]

Selects a modulation source 1 (p.48 of this manual) which will modify the pitch (e.g., apply vibrato).

Intensity (Pitch AMS1 Intensity) [-99...+99]

Specifies the depth and direction of the pitch change that will be controlled by "AMS1."

AMS(AMS1 Intensity Alternate Modulation Source) [Off...MIDI:CC#83]

Specifies the controller (p.48 of this manual) that will control the "Intensity (Pitch AMS1 Intensity)."

Intensity (AMS1 Int AMS Intensity) [-99...+99]

Specifies the depth of the pitch modulation effect controlled by "AMS1."

AMS2 (Alternate Modulation Source 2) [Off...MIDI:CC#83]

Selects a modulation source 2 (p.48 of this manual) which will modify the pitch (e.g., apply vibrato).

Intensity (Pitch AMS2 Intensity) [-99...+99]

Specifies the depth of the pitch modulation effect controlled by "AMS2."

2-2: OSC2 P.Mod (Oscillator 2 Pitch Modulation)

2-3: SubOSC P.Mod (Sub Oscillator Pitch Modulation)

OSC2 P.Mod and SubOSC P.Mod, have the same parameter as OSC 1. Refer to "2-1: OSC1 P.Mod"

2-4: Common P.Mod

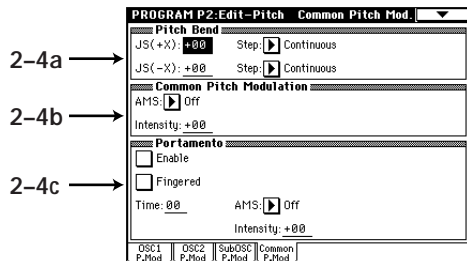

2-4a: Pitch Bend

Specifies the width of pitch change that will occur when the joystick is moved to left and right.

JS(+X) (Joystick Intensity +X) [-60...+24]

Specifies the amount and direction of pitch change (in semitone units) that will occur when the joystick is moved to the right.

With **positive (+)** settings the pitch will rise, and with **negative (-)** settings the pitch will fall. A setting of 12 will produce one octave of change.

Step (Joystick Step +X)

[Continuous, 1/8, 1/4, 1/2, 1...12] **Time** [0...99]

Specifies how the pitch will change when the joystick is moved to the right.

Continuous: Smooth change.

1/8: Change in 1/8 semitone steps.

1/4: Change in 1/4 semitone steps.

1/2: Change in 1/2 semitone steps.

1...12: Change in steps of the specified number of semitones (up to 1 octave).

JS(-X) (Joystick Intensity -X) [-60...+24]

Specifies the amount and direction of pitch change (in semitone units) that will occur when the joystick is moved to the left.

Step (Joystick Step -X)

[Continuous, 1/8, 1/4, 1/2, 1...12]

Specifies how the pitch will change when the joystick is moved to the left.

Refer to Step (Joystick Step +X).



If the Step (Joystick Step +X) or Step (Joystick Step -X) settings are greater than the settings for JS (+X) and JS (-X), the pitch will not change.

2-4b: Common Pitch Modulation

Creates time-varying changes in the pitch of all oscillators (oscillators 1 and 2, and the sub oscillator).

AMS (Alternate Modulation Source)

[Off...MIDI:CC#83]

Selects the modulation source (see p.48 of this manual) that will control the pitch of all oscillators (oscillators 1 and 2, and the sub oscillator).

Intensity (Common Pitch AMS Intensity)

[-99...+99]

Specifies the depth and direction of the effect produced by AMS.

2-4c: Portamento

These settings specify how portamento will be applied. (Portamento creates a smooth change in pitch from one note to the next.)

Enable

Check this when you wish to use portamento.

Fingered

Check this when you want to apply portamento only when a note is pressed while continuing to hold the previous note.

Time [0...99]

Specifies the portamento time. Higher values will cause the pitch to change more slowly.

AMS (Alternate Modulation Source)

[Off...MIDI:CC#83]

Selects a modulation source (see p.48 of this manual) that will control "Time."

Intensity (Portamento Time AMS Intensity)

[-99...+99]

Specifies the depth and direction in which the portamento time will be controlled by the "AMS."

Program P3: Edit-Filter

Here, you can make settings for one of the two multi-mode filters.

3-1: Filter 1

Each multi-mode filter can be set to one of five filter types.

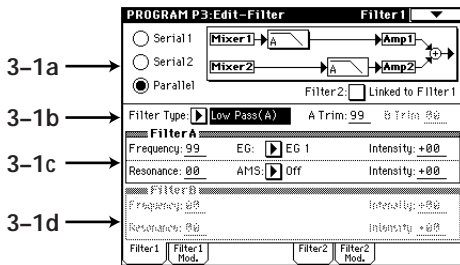
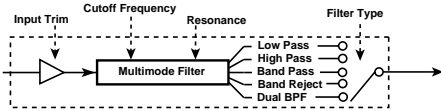

3-1a

3-1b

3-1c

3-1d

3-1a: Routing (Filter Routing)

Routing [Serial 1/Serial 2/Parallel]

Use the **radio buttons** to select the way in which filters 1 and 2 will be combined.

Filter2:

Link to Filter 1

If this is **checked**, Filter 2 will be linked to Filter 1, and the following settings will be the same as the settings of Filter 1.

If this is **not checked**, the following parameters can be set for Filter 2.

3-1b: Filter Type

Filter Type

[Low Pass(A), High Pass(A), Band Pass(A), Band Reject(A), Dual BPF(A/B)]

Selects the filter type.

When **Dual BPF(A/B)** is selected, the “3-1d: Filter B” parameters can also be set.

Filter Types and Cutoff Frequency

Low Pass Filter (Low Pass)

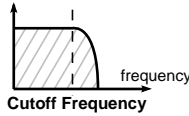

A low pass filter is the most commonly-used type of filter, and passes the range of frequencies that lie below the cutoff frequency, and cuts the high range. Cutting the higher partials will cause a bright sound to become darker (more mellow).

High Pass Filter (High Pass)

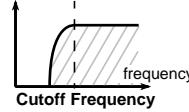

A high pass filter passes the range of frequencies that lie above the cutoff frequency, and cuts the low range. This type of filter is used when you wish to make the sound thinner. However, raising the cutoff frequency excessively will drastically reduce the volume.

Band Pass Filter (Band Pass)

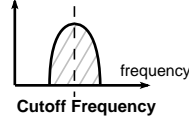

A band pass filter passes the range of frequencies in the vicinity of the cutoff frequency, and cuts the ranges above and below. This type of filter is used when you wish to emphasize a particular portion of the sound.

Band Reject Filter (Band Reject)

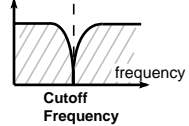

A band reject filter cuts only the range in the vicinity of the cutoff frequency, and passes the rest of the sound. This type of filter gives a unique character to the sound.

Dual Band Pass Filter (Dual BPF)

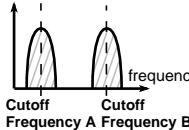

The dual band pass filter places two band pass filters in parallel. It allows you to simulate sounds such as human voice and the body resonances of a violin or guitar.

A Trim

[0...99]

Specifies the level of the input to filter A.



If this value is raised, the sound may become distorted if the resonance setting is high, etc.

B Trim

[0...99]

Specifies the level of the input to filter B.



If this value is raised, the sound may become distorted if the resonance setting is high, etc.

3-1c: Filter A

Frequency (Cutoff Frequency)

[0...99]

Specifies the cutoff frequency of filter 1.

As this **value is increased**, the cutoff frequency will rise. Since the **Band Pass(A)** and **Dual BPF(A/B)** filter types use filters with differing characteristics, their actual cutoff frequency may differ even if their settings are identical.

EG (Cutoff Frequency Modulation EG)

[EG1...EG4, AmpEG]

Selects the EG that will create time-varying change in the cutoff frequency of filter 1.

Intensity (Cutoff Frequency Mod. EG Intensity) [-99...+99]

Specifies the depth and direction of the control that “EG (Cutoff Frequency Modulation EG)” will have on the cutoff frequency. With **positive (+) settings** of this parameter, the tone will become brighter when the various EG levels rise into the + area (the setting of the “Frequency” will be reached when the EG levels are at 0), and darker when the EG levels fall into the – area. With **negative (–) settings** of this parameter, the tonal change will take place in the opposite direction.

Resonance [0...99]

This setting emphasizes the overtones in the region of the “Frequency” to add character to the sound. **Higher values** will produce a stronger effect. With high settings of resonance, the output signal of the filter may distort. If this occurs, reduce the “A Trim” setting.

With the **Dual BPF(A/B)** filter type, the overtones in the vicinity of each cutoff frequency will be affected in the same way as by a **Band Pass(A)**.

The effect of resonance

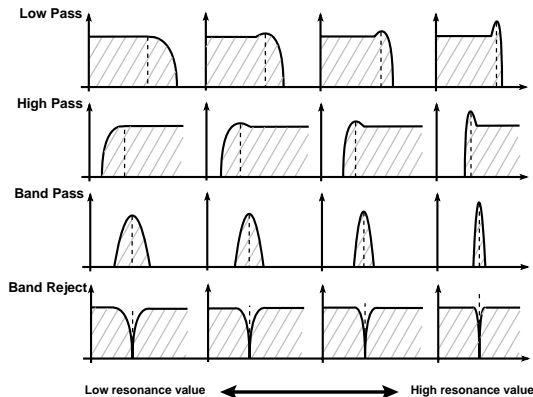

AMS (Alternate Modulation Source) [Off...MIDI:CC#83]

Selects a modulation source (p.48 of this manual) that will control the amount of resonance.

Intensity (Resonance AMS Intensity) [-99...+99]

Specifies the depth and direction of the effect that “AMS” will have on the amount of resonance.

3-1d: Filter B

These parameters will be available if **Dual BPF (A/B)** was selected as the Type in “3-1b: Filter Type.” For details on each parameter, refer to “3-1c: Filter A.” The EG and AMS are set in “3-1c: Filter A.”

3-2: Filter1 Mod. (Filter 1 Modulation)

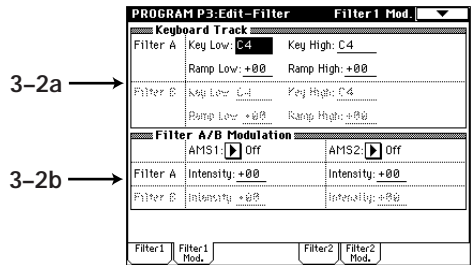

3-2a: FilterA/B Keyboard Track

Keyboard tracking settings specify how the cutoff frequency of filter 1 will be varied according to keyboard position.

Filter A:

Key Low [C-1...G9]

Specifies the key at which Lower keyboard tracking will begin.

Key High [C-1...G9]

Specifies the key at which Higher keyboard tracking will begin.

note

You can also input a value by playing a note on the keyboard while you hold down the [ENTER] key.

Ramp Low [-99...+99]

Specifies the depth and direction of cutoff frequency change that will occur below the “Key Low.”

With a setting of **-50**, the change will match the change in pitch.

Ramp High [-99...+99]

Specifies the depth and direction of cutoff frequency change that will occur above the “Key High.”

With a setting of **+50**, the change will match the change in pitch.

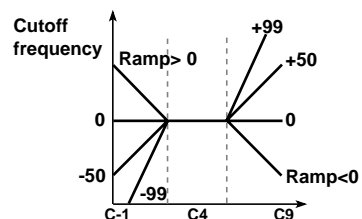

Filter B:

Here you can adjust the settings for Filter B. These parameters have the same structure as the “Filter A” parameters.

3-2b: Filter A/B Modulation

Filter A:

AMS1 (Alternate Modulation Source 1)
[Off...MIDI:CC#83]

Selects a modulation source 1 (p.48 of this manual) that will control “Frequency.”

Intensity (Cutoff Frequency AMS1 Intensity)
[-99...+99]

Specifies the depth and direction of the effect that “AMS1” will have on the cutoff frequency.

AMS2 (Alternate Modulation Source 2)
[Off...MIDI:CC#83]

Selects a modulation source 2 (p.48 of this manual) that will control “Frequency.”

Intensity (Cutoff Frequency AMS2 Intensity)
[-99...+99]

Specifies the depth and direction of the effect that “AMS2” will have on the cutoff frequency.

Filter B:

Adjust the “Intensity” of “AMS1” and “AMS2” specified for “Filter A.”

3-3: Filter2

For details on the parameters, refer to “3-1: Filter.”

3-4: Filter2 Mod. (Filter 2 Modulation)

For details on the parameters, refer to “3-2: Filter 1 Mod.”

Program P4: Edit-Amp

Here, you can make volume-related settings. There are two independent amps, and the signals which are input to each amp are determined by the setting of “3-1a: Routing” (p.47 of this manual).

4-1: Amp1 Level (Amplifier 1 Level)

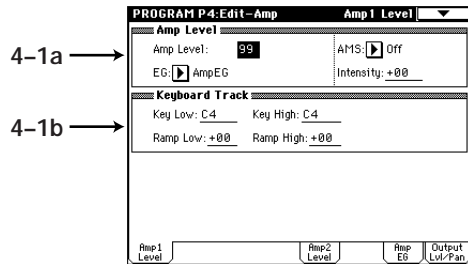

4-1a →

4-1b →

4-1a: Amp Level

Amp Level [0...99]

Specifies the volume level of amp 1. The input signal to amp 1 is determined by the “3-1a:Routing” setting

EG (Amplitude Modulation EG)
[EG1...EG4, AmpEG]

Selects the EG that will create time-variant change in the volume level of amp 1. For the settings of each EG, refer to “4-3: Amp EG”, “Program P6.”

AMS (Alternate Modulation Source)
[Off...MIDI:CC#83]

Selects a modulation source (p.48 of this manual) that will control the volume level of amp 1.

Intensity (Amplitude AMS Intensity) [-99...+99]
Specifies the depth and direction of the effect of “AMS” on the volume level.

4-1b: Keyboard Track

Key Low [C-1...G9]

Specifies the key at which Lower keyboard tracking will begin.

Key High [C-1...G9]

Specifies the key at which Higher keyboard tracking will begin.

note You can also input a value by playing a note on the keyboard while you hold down the [ENTER] key.

Ramp Low [-99...+99]
Specifies the way in which keyboard tracking will affect the volume of notes below the “Key Low.”

Ramp High [-99...+99]
Specifies the way in which keyboard tracking will affect the volume of notes below the “Key High.”

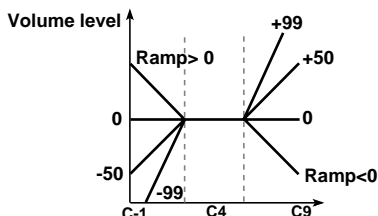

If Ramp Low or Ramp High are set to positive (+) settings, you will need to lower the “4-1a: Amp Level” Amplitude value.

4-2: Amp2 Level (Amplifier 2 Level)

Here you can adjust the settings for Amp 2. These parameters have the same structure as the “4-1a: Amp 1” parameters.

4-3: Amp EG (Amplifier Envelope Generator) AMSSource

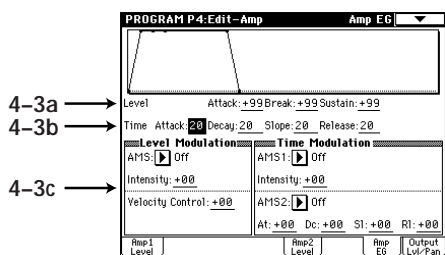

Here, you can make settings for the **Amp EG**. The **Amp EG** lets you specify how the sound will change over time. Since the **Amp EG** can also be used as a general-purpose controller, it can create time-variant change in parameters other than volume.

Time-variant change in volume created by the amp EG

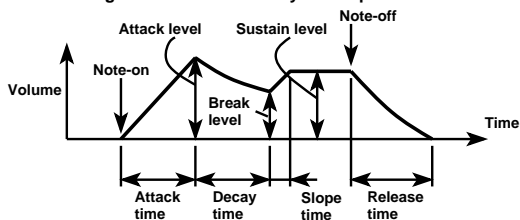

4-3a: Level (Amp EG Level)

Attack (Attack Level) [0...99]
Specifies the volume that will be reached after the Attack Time has elapsed.

Break (Break Level) [0...99]
Specifies the volume level that will be reached after the Decay Time has elapsed.

Sustain (Sustain Level) [0...99]
Specifies the volume level that will be reached after the Slope Time has elapsed.

4-3b: Time (Amp EG Time)

Attack (Attack Time) [0...99]
Specifies the time from note-on (when a note is played) until the volume reaches the attack level. With a value of 0, the volume will change instantly. With a value of 99, the volume will change slowly.

Decay (Decay Time) [0...99]
Specifies the time from when the attack time ends until the break level is reached.

Slope (Slope Time) [0...99]
Specifies the time from when the decay time ends until the sustain level is reached.

Release (Release Time) [0...99]
Specifies the time from note-off (when a note is released) until the volume falls to zero.

4-3c: Level Modulation

AMS (Alternate Modulation Source) [Off...MIDI:CC#83]

Selects a modulation source (see p.48 of this manual) that will control the level of the Amp EG.

Intensity (EG Level AMS Intensity) [-99...+99]
Specifies the depth and direction of the effect that “AMS” will have on the level of the Amp EG.

Velocity Control

[−99...+99]

Specifies the depth and direction of the effect that velocity will have on the level of the amp EG.

4-4: Output Level / Pan

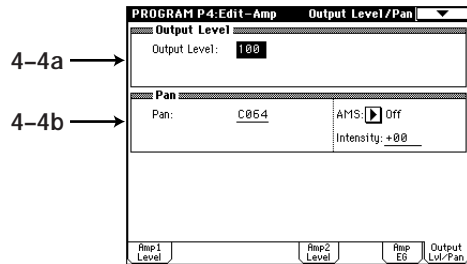

4-3d: Time Modulation

AMS1 (Alternate Modulation Source 1)

[Off...MIDI:CC#83]

Selects a modulation source 1 (p.48 of this manual) that will control the Amp EG times.

Intensity (EG Time AMS1 Intensity)

[−99...+99]

Specifies the depth and direction of the effect that “AMS1” will have on the Amp EG times.

AMS2 (Alternate Modulation Source 2)

[Off...MIDI:CC#83]

Selects a modulation source 2 (p.48 of this manual) that will control the Amp EG times.

At (Attack Time AMS2 Intensity)

[−99...+99]

Dc (Decay Time AMS2 Intensity)

[−99...+99]

Sl (Slope Time AMS2 Intensity)

[−99...+99]

RI (Release Time AMS2 Intensity)

[−99...+99]

Specifies the depth and direction of the effect that “AMS2” will have on each EG time.

4-4a: Output Level

Output Level

[0...127]

Specifies the output level following the amp.

4-4b: Pan

Pan

[L000...C064...R127]

Set the pan (stereo location) of oscillator 1.

L001 is far left, C064 is center, and R127 is far right.

AMS (Alternate Modulation Source)

[Off...MIDI:CC#83]

Selects the modulation source (p.36 of this manual) that will move the panning of amp 1 relative to the Pan setting.

Intensity (Panpot AMS Intensity)

[−99...+99]

Specifies the depth and direction of the effect of “AMS” on the panning.

Amp EG changes (time) (AMS=Velocity, Intensity=+value)

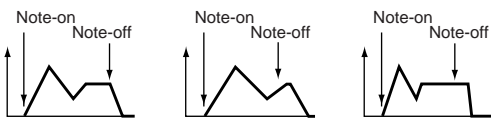

When keyboard is played softly with At, Dc, Sl, and RI set to “+” The settings of 4-3d: AMS2

When keyboard is played strongly with At, Dc, Sl, and RI set to “+”

When keyboard is played strongly with At, Dc, Sl, and RI set to “-”

Program P5: Edit-Common LFO

This section provides four **LFOs** (Low Frequency Oscillators). These LFOs can be used as modulation sources for parameters of other sections, to create cyclic changes in the sound.

5-1: LFO 1 **AMSource**

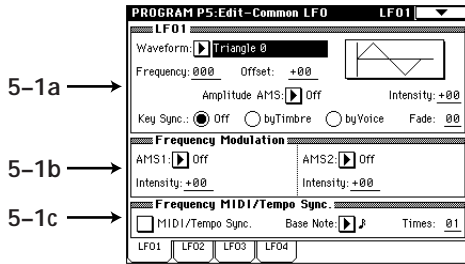

5-1a: LFO1

Waveform [Triangle 0...Exponential Saw Down]
Settings for the general-purpose LFOs

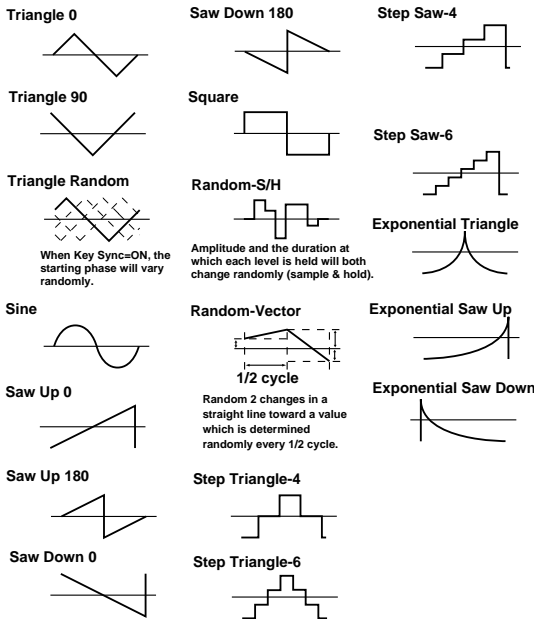

Frequency [0...199]
Specifies the frequency of the LFO.

Offset [-50...+50]
Specifies the center value of the LFO waveform.

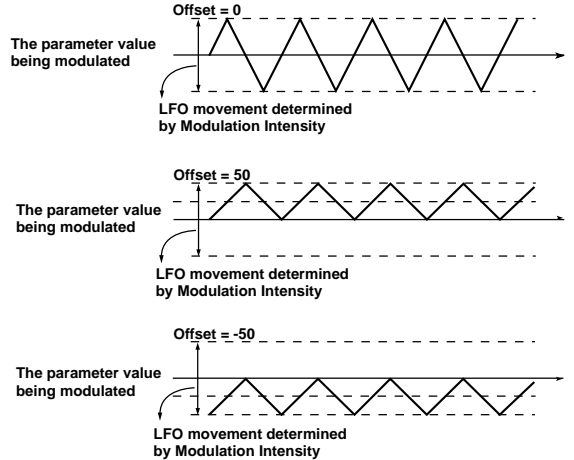

Amplitude AMS (Alternate Modulation Source 1) [Off...MIDI:CC#83]
Selects a modulation source (p.48 of this manual) that will control the amplitude of the LFO waveform.

Intensity (Amplitude AMS Intensity) [-99...+99]
Specifies the depth and direction of the effect that "AMS" will have on the amplitude of the LFO waveform.

Key Sync [Off/by Timbre/by Voice]
Use the **radio buttons** to select the key sync setting (i.e., whether or not the phase of the LFO waveform will be returned to its initial state when a note-on occurs).

Off: The LFO will operate regardless of note-on.

by Timbre: Key sync will occur for the LFOs of all voices at the time of the first note-on that occurs in a state when no keys are on.

by Voice: Key sync will occur independently for the individual LFO of the voice for which note-on occurred.

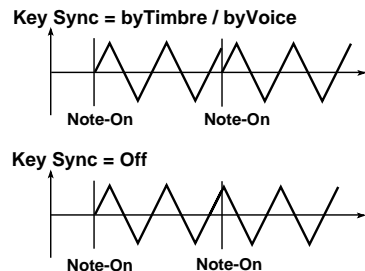

Fade [0...99]
Specifies the time over which the amplitude of the LFO will increase from 0 until it reaches the maximum value.

5-2: LFO 2 

5-3: LFO 3 

5-4: LFO 4 

LFO 2, LFO 3, and LFO 4 have the same parameter as LFO 1. Refer to “5-1: LFO 1”

5-1b: Frequency Modulation

You can use two alternate modulation sources to control the frequency of the LFO.

AMS1 (Alternate Modulation Source 1)
[Off...MIDI:CC#83]

Select a modulation source 1 (see p.48 of this manual) that will control the LFO frequency.

Intensity (Frequency AMS1 Intensity) [-99...+99]

Specifies the depth and direction of the effect that “AMS1” will have on the “Frequency” value.

AMS2 (Alternate Modulation Source 2)
[Off...MIDI:CC#83]

Selects a modulation source 2 (see p.48 of this manual) that will control the LFO frequency.

Intensity (Frequency AMS2 Intensity) [-99...+99]

Specifies the depth and direction of the effect that “AMS2” will have on the “Frequency” value.

5-1c: Frequency MIDI/Tempo Sync.

MIDI/Tempo Sync.

Checked: The LFO frequency will synchronize to the tempo (MIDI Clock). In this case, the settings of “5-1a: Frequency” and “5-1b: Frequency Modulation” will have no effect.

Base Note [♩, ♪, ♩, ♪, ♩, ♪, ♩, ♪, ♩, ♪, ♩, ♪, ♩, ♪, ♩, ♪, ♩, ♪]
Times [01...16]

If “MIDI/Tempo Sync.” is checked, these parameters specify the “Base Note” note value and a multiple “Times” relative to the “♩(tempo).” These parameters will determine the frequency of the OSC1 LFO1. For example if “Base Note” is ♩ (quarter note) and “Times” is 04, the LFO will cycle once every four beats.

Even if you change the “♩(Tempo)” of the arpeggiator or sequencer, the LFO will always cycle once every four beats.

 If the Global mode parameter “1-1a: MIDI Clock” (see Parameter Guide p.118) is set to **Internal**, the LFO will synchronize to the tempo specified by the program. If it is set to **External MIDI** or **External PC I/F**, the LFO will synchronize to the MIDI Clock messages received from an external MIDI device.

Program P6: Edit-Common EG

This section provides four general purpose EGs (envelope generators). The four EGs can be used as modulation sources for the parameters of other sections to create time-variant change in the sound.

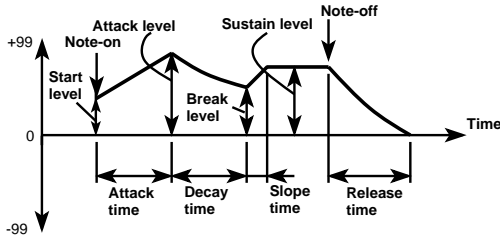

6-1: EG 1 **AMS**Source

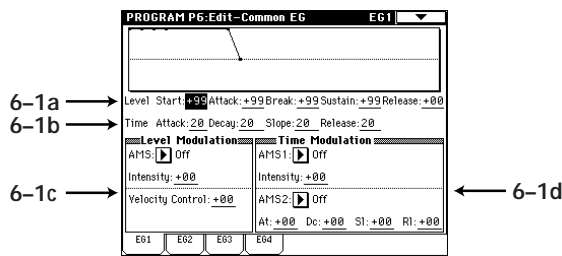

6-1a: Level (EG Level)

Start (Start Level) [-99...+99]
Specifies the value at the time of note-on.

Attack (Attack Level) [-99...+99]
Specifies the value that will be reached after the Attack Time has elapsed.

Break (Break Level) [-99...+99]
Specifies the value that will be reached after the Decay Time has elapsed.

Sustain (Sustain Level) [-99...+99]
Specifies the value that will be reached after the Slope Time has elapsed.

Release (Release Level) [-99...+99]
Specifies the value that will be reached after the Release Time has elapsed.

6-1b: Time (EG Time)

Attack (Attack Time) [0...99]
Specifies the time from note-on (when a note is played) until the value reaches the attack level. With a value of 0, the value will change instantly. With a value of 99, the value will change slowly.

Decay (Decay Time) [0...99]
Specifies the time from when the attack time ends until the Break Level is reached.

Slope (Slope Time) [0...99]
Specifies the time from when the decay time ends until the Sustain Level is reached.

Release (Slope Time) [0...99]
Specifies the time from note-off (when a note is released) until the Release Level is reached.

6-1c: Level Modulation

AMS (Alternate Modulation Source) [Off...MIDI:CC#83]
Selects a modulation source (p.48 of this manual) that will control the level of EG1.

Intensity (EG Level AMS Intensity) [-99...+99]
Specifies the depth and direction of the effect that "AMS" will have on the EG levels.

Velocity Control [-99...+99]
Specifies the depth and direction of the effect that velocity will have on the EG levels.

EG changes (level) (AMS=Velocity, Intensity=+value)

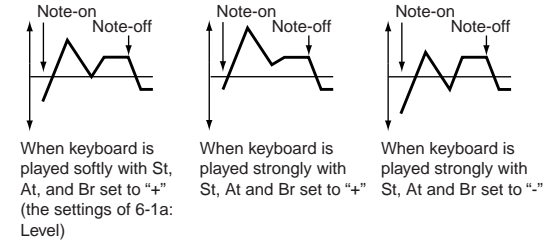

6-1d: Time Modulation

AMS1 (Alternate Modulation Source 1) [Off...MIDI:CC#83]
Selects a modulation source 1 (p.48 of this manual) that will control the EG1 times.

Intensity (EG Time AMS1 Intensity) [-99...+99]
Specifies the depth and direction of the effect that "AMS1" will have on the EG times.

AMS2 (Alternate Modulation Source 2)

[Off...MIDI:CC#83]

Selects a modulation source 2 (see p.48 of this manual) that will control the EG1 times.

At (Attack Time AMS2 Intensity) [-99...+99]

Dc (Decay Time AMS2 Intensity) [-99...+99]

Sl (Slope Time AMS2 Intensity) [-99...+99]

Rl (Release Time AMS2 Intensity) [-99...+99]

Specifies the depth and direction of the effect that "AMS2" will have on each EG time.

EG changes (time) (AMS2=Velocity, Intensity=+value)

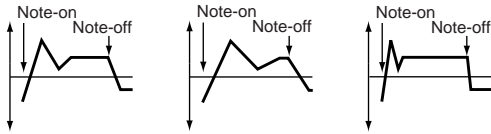

When keyboard is played softly with At, Dc, Sl, and Rl set to "+" (The settings of 6-1d: AMS2)

When keyboard is played strongly with At, Dc, Sl, and Rl set to "+"

When keyboard is played strongly with At, Dc, Sl, and Rl set to "-"

6-2: EG 2 **AMSource**

6-3: EG 3 **AMSource**

6-4: EG 4 **AMSource**

EG 2, EG 3 and EG 4 have the same parameters as EG 1. Refer to "6-1: EG 1."

Program P7: Edit-Arpeggiator

Here you can make arpeggiator-related settings.

For details on the parameters etc., refer to TRITON Parameter Guide p.22, "Program P7."

Program P8: Edit-Insert Effect

Here, you can make settings for the insertion effects.

For details on the parameters etc., refer to TRITON Parameter Guide p.24, "Program P8."

Program P9: Edit-Master Effect

Here, you can make settings for the master effects.

For details on the parameters etc., refer to TRITON Parameter Guide p.27 "Program P9."

Combination mode

Combination P4: MOSS Setup

Here you can specify how bank F programs will be sounded.

 These settings have no effect on bank A–E or G programs.

4–3: MOSS Setup

Specify the number of voices that will be used by bank F programs, and how they will be routed through effects and the individual audio outputs.

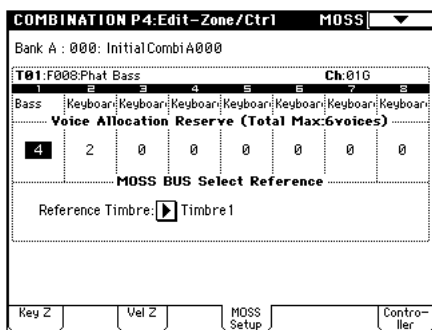

Voice Allocation Reserve (Total Max:6voices) [0 ... 6]

For each timbre, specify the number of voices for when a bank F program is selected. Make settings so that the total for all timbres does not exceed six voices.

If this is set to 0, a bank F program selected for that timbre will not sound. When using the EXB-MOSS multi-timbrally, refer to “Multi-timbral settings.”

 When you change the bank/program of a timbre to change from a bank A–E or G program to a bank F program, it will sound according to these settings. Timbres that are set to 0 will not sound if they are switched to a bank F program. Before you select a bank F program, set this parameter appropriately.

MOSS BUS Select Reference [Timbre1 ... Timbre8]

Specify the insertion/master effect routing and individual audio output routing for all timbres that use bank F programs. The settings of the timbre you select here will determine the insertion/master effect and individual audio output routing of these timbres. (They cannot be set independently.)

Insertion/master effect routing and individual audio output routing for a timbre is set in the Program P8: Routing tab. Refer to “Multi-timbral settings” in this manual.

note The Timbre 1–8 you select here does not have to be using a bank F program.

note The actual levels of send 1 and 2 for a timbre using a bank A–E or G program is determined by multiplying the timbre setting by the send level of the program, but for timbres that use a bank F program, the send level setting of the timbre will be the actual level.

Appendices

Cautions when using bank F

Sound production when changing programs

If you change bank F programs while sound is being produced, the bank F program will stop sounding. The newly selected program will sound at the next note-on.

MIDI Program Change reception

Depending on the oscillator type that is used by a program, a certain interval of time may be required from when a program change is received until the bank F program actually changes. When changing programs, please allow a sufficient time interval between the program change and the note-on.

About noise

The inter-relation between effect settings etc. and the oscillator parameters of the program may cause noise to appear in the sound under some conditions. Also, playing the program immediately after selecting it (within one second) may cause noise to be mixed with the output sound.

If you are using bank F programs in multiple timbres

When playing multi-timbrally and a bank F program is being sounded, selecting a bank F program for the timbre number prior to that timbre number will cause noise to be heard in the currently-sounding bank F program.

Data dump compatibility

Bank F programs are not compatible with the programs of the Prophecy, Z1, TRINITY V3, or TRINITY MOSS-TRI.

Affix the Sondius-XG label

Affix the included label to the right side of the front panel. ☞ Refer to the following diagram

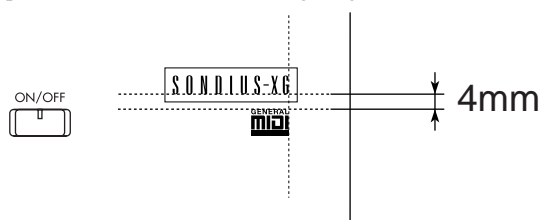

Modulation Source List

Off
EG 1
EG 2
EG 3
EG 4
Amp EG
LFO 1
LFO 2
LFO 3
LFO 4
Portamento
Note No. Linear
Note No. Exp.
Note Split High
Note Split Low
Velocity Soft
Velocity Med.
Velocity Hard
After Touch
JS X
JS +Y: CC#01
JS -Y: CC#02
JS +Y & AT/2*
JS -Y & AT/2*
Pedal: CC#04
Ribbon: CC#16
Ribbon +X
Ribbon -X
Slider: CC#18
KnobMod1: #17
KnobMod2: #19
KnobMod3: #20
KnobMod4: #21
KnobMod1 [+]
KnobMod2 [+]
KnobMod3 [+]
KnobMod4 [+]
Damper: #64
SW 1: CC#80
SW 2: CC#81
Foot SW: #82
MIDI: CC#83

* AT/2 is an aftertouch effect that is one half of After Touch.

Voice Name List

Combination (MOSS.PCG)

#	Name Category	Arp.SW Pattern A Pattern B	Run Run	Mod.SW1 Mod.SW2	Knob1 Knob2	Knob3 Knob4
B000	Forest Piano Keyboard	Off P001: DOWN P000: UP	On On	Octave Down Lock JS(-Y) & Ribbon	F/A Attack (CC#73) F/A Decay (CC#75)	Knob Mod.3 (CC#20) Knob Mod.4 (CC#21)
B001	!! MOSSPOWER !! Rhythmic Pattern	On U153: Drum'n'Bass 1 U043: Trance Bass Riff	On On	Mod.SW1 (CC#80) Portamento SW (CC#65)	F/A Attack (CC#73) F/A Decay (CC#75)	Knob Mod.3 (CC#20) Knob Mod.4 (CC#21)
B002	Eternal Partners Guitar/Plucked	Off U013: BalladPicking GT P000: UP	On Off	Mod.SW1 (CC#80) Lock JS(-Y) & Ribbon	Volume (CC#07) Expression (CC#11)	Knob Mod.3 (CC#20) Knob Mod.4 (CC#21)
B003	Dirty Moss Sax LeadSplits	Off U165: Smooth Hop P000: UP	On Off	Mod.SW1 (CC#80) Lock Ribbon	Knob Mod.1 (CC#17) Knob Mod.2 (CC#19)	Knob Mod.3 (CC#20) Knob Mod.4 (CC#21)
B004	Water Pad MotionSynth	Off P000: UP P000: UP	On Off	Mod.SW1 (CC#80) Lock JS(-Y) & Ribbon	Volume (CC#07) Knob Mod.2 (CC#19)	Knob Mod.3 (CC#20) Knob Mod.4 (CC#21)
B005	Intimate Orch Orchestral	Off U029: Arco Arpeggio P001: DOWN	On On	Mod.SW1 (CC#80) Lock JS(-Y)	F/A Attack (CC#73) F/A Decay (CC#75)	Knob Mod.3 (CC#20) Knob Mod.4 (CC#21)
B006	RETRO Rocket Spl LeadSplits	On P004: RANDOM U095: Retro Pattern	On On	Portamento SW (CC#65) Lock JS(-Y) & Ribbon	F/A Decay (CC#75) Knob Mod.2 (CC#19)	Knob Mod.3 (CC#20) Knob Mod.4 (CC#21)
B007	MossTrumpets Cut BrassReed	Off U068: 7-tone Ostinato P000: UP	On Off	Mod.SW1 (CC#80) Octave Down	F/A Attack (CC#73) F/A Release (CC#72)	Knob Mod.3 (CC#20) Knob Mod.4 (CC#21)
B008	4'5' Splitmoss BassSplits	Off U145: 8 Beat U151: Latin-drums	On On	Mod.SW1 (CC#80) Mod.SW2 (CC#81)	Knob Mod.1 (CC#17) F/A Attack (CC#73)	Knob Mod.3 (CC#20) F/A Decay (CC#75)
B009	Telegraph Unison Rhythmic Pattern	On U147: Shuffle 2 U162: House 2	On On	Mod.SW1 (CC#80) Octave Down	Knob Mod.1 (CC#17) Knob Mod.2 (CC#19)	Knob Mod.3 (CC#20) Knob Mod.4 (CC#21)
B010	Pure Ac.Guitar Guitar/Plucked	Off U102: ONCE! P000: UP	On Off	Mod.SW1 (CC#80) Lock JS(-Y) & Ribbon	F/A Attack (CC#73) Volume (CC#07)	Knob Mod.3 (CC#20) Knob Mod.4 (CC#21)
B011	Cyber Sly Heart Complex & SE	On U150: Bossa Nova U155: Drum'n'Bass 3	On On	Mod.SW1 (CC#80) Lock JS(-Y) & Ribbon	Filter Resonance (CC#71) Knob Mod.2 (CC#19)	Knob Mod.3 (CC#20) Knob Mod.4 (CC#21)
B012	Winter Bells Bell/Mallet/Perc	Off P001: DOWN P000: UP	On On	Mod.SW1 (CC#80) Lock JS(-Y)	F/A Attack (CC#73) F/A Decay (CC#75)	Knob Mod.3 (CC#20) Knob Mod.4 (CC#21)
B013	Trance Leader Synth	Off U118: Techno Riff 7 P000: UP	On Off	Mod.SW1 (CC#80) Portamento SW (CC#65)	F/A Attack (CC#73) F/A Sustain (CC#70)	Knob Mod.3 (CC#20) Knob Mod.4 (CC#21)
B014	Sweep & Cool Keyboard	Off U150: Bossa Nova U164: New Disco 2	On On	Mod.SW1 (CC#80) Mod.SW2 (CC#81)	Knob Mod.1 (CC#17) Knob Mod.2 (CC#19)	Knob Mod.3 (CC#20) Knob Mod.4 (CC#21)
B015	Moss Stencil Pads	Off U109: Up uP UP Up uP U107: 8th Chunk	On On	Mod.SW1 (CC#80) Lock JS(-Y) & Ribbon	Knob Mod.1 (CC#17) Knob Mod.2 (CC#19)	Knob Mod.3 (CC#20) Knob Mod.4 (CC#21)
B016	Gaterhythm Rhythmic Pattern	On U158: Drum'n'Bass 6 U043: Trance Bass Riff	On On	Mod.SW1 (CC#80) Mod.SW2 (CC#81)	F/A Decay (CC#75) Knob Mod.2 (CC#19)	Filter EG Int. (CC#79) Knob Mod.4 (CC#21)
B017	UnisonMoss SYNC Synth	Off U148: Jazz 1 U060: Crazy Bee	On On	Mod.SW1 (CC#80) Octave Down	Knob Mod.1 (CC#17) Knob Mod.2 (CC#19)	Knob Mod.3 (CC#20) Knob Mod.4 (CC#21)
B018	Metallic Clavi Keyboard	Off U125: Trance Riff 1 P000: UP	On Off	Mod.SW1 (CC#80) Lock JS(-Y) & Ribbon	F/A Attack (CC#73) F/A Decay (CC#75)	F/A Sustain (CC#70) Knob Mod.4 (CC#21)
B019	Moss Soprano SP LeadSplits	Off U164: New Disco 2 U107: 8th Chunk	On On	Mod.SW1 (CC#80) Lock Ribbon	Knob Mod.1 (CC#17) Knob Mod.2 (CC#19)	Knob Mod.3 (CC#20) Knob Mod.4 (CC#21)
B020	Topper Split BassSplits	Off U051: Old Dance Bass 2 P000: UP	On Off	Mod.SW1 (CC#80) Lock JS(-Y)	F/A Attack (CC#73) F/A Decay (CC#75)	Knob Mod.3 (CC#20) Knob Mod.4 (CC#21)
B021	Talkabout Complex & SE	On U145: 8 Beat U151: Latin-drums	On On	Mod.SW1 (CC#80) Mod.SW2 (CC#81)	Knob Mod.1 (CC#17) Knob Mod.2 (CC#19)	Knob Mod.3 (CC#20) Knob Mod.4 (CC#21)
B022	Flute Moss Split LeadSplits	Off U165: Smooth Hop U034: TechnoBass Riff2	On On	Mod.SW1 (CC#80) Lock JS(-Y) & Ribbon	Knob Mod.1 (CC#17) Knob Mod.2 (CC#19)	Knob Mod.3 (CC#20) Knob Mod.4 (CC#21)
B023	DigiStrat Guitar Guitar/Plucked	Off U016: Soul Strum GT P000: UP	On Off	Mod.SW1 (CC#80) Lock JS(-Y) & Ribbon	Knob Mod.1 (CC#17) F/A Decay (CC#75)	Knob Mod.3 (CC#20) Knob Mod.4 (CC#21)
B024	120 To Sync Rhythmic Pattern	On U145: 8 Beat P000: UP	On Off	Mod.SW1 (CC#80) Mod.SW2 (CC#81)	F/A Attack (CC#73) Filter Resonance (CC#71)	Knob Mod.3 (CC#20) Knob Mod.4 (CC#21)
B025	BIG Synth Saws Synth	Off U125: Trance Riff 1 P000: UP	On Off	Mod.SW1 (CC#80) Lock JS(-Y) & Ribbon	F/A Attack (CC#73) F/A Decay (CC#75)	F/A Sustain (CC#70) Knob Mod.4 (CC#21)
B026	Sleepy Bells Bell/Mallet/Perc	Off U143: Penta-Fall P000: UP	On Off	Mod.SW1 (CC#80) Lock JS(-Y) & Ribbon	F/A Attack (CC#73) F/A Decay (CC#75)	Knob Mod.3 (CC#20) Knob Mod.4 (CC#21)
B027	Wurlysizer ArpSW Keyboard	On P000: UP P000: UP	On Off	Mod.SW1 (CC#80) Mod.SW2 (CC#81)	Knob Mod.1 (CC#17) Knob Mod.2 (CC#19)	Knob Mod.3 (CC#20) Knob Mod.4 (CC#21)
B028	Moss Brass Split BrassReed	Off U175: BD/HH/SD 16ths U054: Walkin' Bass	On On	Mod.SW1 (CC#80) Mod.SW2 (CC#81)	F/A Attack (CC#73) F/A Release (CC#72)	Knob Mod.3 (CC#20) Knob Mod.4 (CC#21)

#	Name Category	Arp.SW Pattern A Pattern B	Run Run	Mod.SW1 Mod.SW2	Knob1 Knob2	Knob3 Knob4
B029	Soul-DrumOnKnob1 LeadSplits	Off U144: 1Note Repeat-Lo U166: HipHop 1	On On	Mod.SW1 (CC#80) Lock JS(-Y) & Ribbon	Knob Mod.1 (CC#17) Knob Mod.2 (CC#19)	Knob Mod.3 (CC#20) Knob Mod.4 (CC#21)
B030	Geronimoss Rhythmic Pattern	On U145: 8 Beat P000: UP	On Off	Lock JS(-Y) & Ribbon Mod.SW2 (CC#81)	Mod.SW1 (CC#80) Knob Mod.2 (CC#19)	Knob Mod.3 (CC#20) Knob Mod.4 (CC#21)
B031	Moss Power Split BassSplits	Off U030: DanceBass Riff 1 P000: UP	On Off	Mod.SW1 (CC#80) Mod.SW2 (CC#81)	F/A Attack (CC#73) F/A Release (CC#72)	Knob Mod.3 (CC#20) Knob Mod.4 (CC#21)
B032	Bright Moss Keyboard	Off U155: Drum'n'Bass 3 U035: TechnoBass Riff3	On On	Mod.SW1 (CC#80) Lock JS(-Y) & Ribbon	Mod.SW2 (CC#81) Knob Mod.2 (CC#19)	Knob Mod.3 (CC#20) Knob Mod.4 (CC#21)
B033	Tell me Thelma Rhythmic Pattern	On U146: Shuffle 1 U165: Smooth Hop	On On	Lock JS(-Y) & Ribbon Mod.SW2 (CC#81)	Knob Mod.1 (CC#17) Knob Mod.2 (CC#19)	Mod.SW2 (CC#81) Knob Mod.4 (CC#21)
B034	SquareTubeSea Pads	Off U109: Up uP UP Up uP P002: ALTERNATE1	On On	Mod.SW1 (CC#80) Mod.SW2 (CC#81)	F/A Attack (CC#73) Knob Mod.2 (CC#19)	Knob Mod.3 (CC#20) Knob Mod.4 (CC#21)
B035	Moss Sax Split LeadSplits	On P000: UP U144: 1Note Repeat-Lo	On On	Mod.SW1 (CC#80) Lock JS(-Y) & Ribbon	Filter Cutoff (CC#74) Knob Mod.2 (CC#19)	Knob Mod.3 (CC#20) Knob Mod.4 (CC#21)
B036	System Start-Up MotionSynth	Off P000: UP P000: UP	Off Off	Mod.SW1 (CC#80) Lock JS(-Y) & Ribbon	F/A Attack (CC#73) F/A Decay (CC#75)	F/A Sustain (CC#70) Knob Mod.4 (CC#21)
B037	AwesomeStringPad Strings	Off U029: Arco Arpeggio U022: Piano Arpeggio 1	On Off	Mod.SW1 (CC#80) Lock JS(-Y) & Ribbon	F/A Attack (CC#73) F/A Decay (CC#75)	Knob Mod.3 (CC#20) Knob Mod.4 (CC#21)
B038	CyberSynthBass Synth	Off U123: Echo Riff P000: UP	On Off	Mod.SW1 (CC#80) Portamento SW (CC#65)	Knob Mod.1 (CC#17) Knob Mod.2 (CC#19)	Knob Mod.3 (CC#20) Knob Mod.4 (CC#21)
B039	Moss BRASS Sect BrassReed	Off U149: Jazz 2 U152: Heavy Rock	On On	Mod.SW1 (CC#80) Mod.SW2 (CC#81)	Filter Cutoff (CC#74) F/A Release (CC#72)	Knob Mod.3 (CC#20) Knob Mod.4 (CC#21)
B040	Z-Lead Moss Synth	Off U147: Shuffle 2 U162: House 2	On On	Octave Down Mod.SW2 (CC#81)	Knob Mod.1 (CC#17) Knob Mod.2 (CC#19)	Knob Mod.3 (CC#20) Knob Mod.4 (CC#21)
B041	Moss Srave Rhythmic Pattern	On U112: Techno Riff 1 U175: BD/HH/SD 16ths	On On	Mod.SW1 (CC#80) Lock JS(-Y) & Ribbon	Knob Mod.1 (CC#17) Knob Mod.2 (CC#19)	Knob Mod.3 (CC#20) Knob Mod.4 (CC#21)
B042	NewTouchGuitar Guitar/Plucked	Off U093: Bossa Arpeggio U004: Guitar Strum 5	On On	Mod.SW1 (CC#80) Lock JS(-Y)	Knob Mod.1 (CC#17) Knob Mod.2 (CC#19)	Knob Mod.3 (CC#20) Knob Mod.4 (CC#21)
B043	*Water Exchange* MotionSynth	On U109: Up uP UP Up uP U109: Up uP UP Up uP	On Off	Mod.SW1 (CC#80) Lock JS(-Y)	Filter Cutoff (CC#74) F/A Attack (CC#73)	Filter Resonance(CC#71) Knob Mod.4 (CC#21)
B044	Crystal Bells Bell/Mallet/Perc	Off P000: UP P001: DOWN	On On	Mod.SW1 (CC#80) Mod.SW2 (CC#81)	F/A Attack (CC#73) F/A Decay (CC#75)	Knob Mod.3 (CC#20) Knob Mod.4 (CC#21)
B045	1+3 Splitmoss BassSplits	Off U145: 8 Beat U151: Latin-drums	On On	Mod.SW1 (CC#80) Mod.SW2 (CC#81)	Knob Mod.1 (CC#17) F/A Attack (CC#73)	Knob Mod.3 (CC#20) F/A Decay (CC#75)
B046	Cutt Da Clav Keyboard	Off U046: Euro Bass P000: UP	On Off	Mod.SW1 (CC#80) Lock JS(-Y) & Ribbon	Knob Mod.1 (CC#17) Knob Mod.2 (CC#19)	Knob Mod.3 (CC#20) Knob Mod.4 (CC#21)
B047	Calm Move MotionSynth	On P000: UP P002: ALTERNATE1	On On	Mod.SW1 (CC#80) Lock JS(-Y) & Ribbon	Mod.SW2 (CC#81) Knob Mod.2 (CC#19)	Knob Mod.3 (CC#20) Knob Mod.4 (CC#21)
B048	Moss Stamina Rhythmic Pattern	Off U175: BD/HH/SD 16ths P000: UP	On Off	Mod.SW1 (CC#80) Mod.SW2 (CC#81)	Knob Mod.1 (CC#17) Knob Mod.2 (CC#19)	Knob Mod.3 (CC#20) Knob Mod.4 (CC#21)
B049	Palawaters MotionSynth	On U144: 1Note Repeat-Lo P000: UP	On Off	Mod.SW1 (CC#80) Mod.SW2 (CC#81)	Knob Mod.1 (CC#17) Knob Mod.2 (CC#19)	Knob Mod.3 (CC#20) Knob Mod.4 (CC#21)
B050	Nu Gtr Pad ArpSw Guitar/Plucked	Off P000: UP P000: UP	On Off	Mod.SW1 (CC#80) Mod.SW2 (CC#81)	Knob Mod.1 (CC#17) Knob Mod.2 (CC#19)	Knob Mod.3 (CC#20) Knob Mod.4 (CC#21)
B051	UnisonMoss ST Synth	On U071: 5-tone Trance 1 U062: Stepping Note	On On	Mod.SW1 (CC#80) Octave Down	Knob Mod.1 (CC#17) Knob Mod.2 (CC#19)	Knob Mod.3 (CC#20) Knob Mod.4 (CC#21)
B052	Session Split BassSplits	Off U146: Shuffle 1 U150: Bossa Nova	On On	Mod.SW1 (CC#80) Lock JS(-Y)	Mod.SW1 (CC#80) Knob Mod.2 (CC#19)	Knob Mod.3 (CC#20) Knob Mod.4 (CC#21)
B053	MosStrings ArpSW Strings	On U144: 1Note Repeat-Lo P000: UP	On Off	Lock Ribbon Lock JS(-Y)	Filter Cutoff (CC#74) Knob Mod.2 (CC#19)	Knob Mod.3 (CC#20) Knob Mod.4 (CC#21)
B054	FluteInAmbySauce LeadSplits	On U144: 1Note Repeat-Lo P000: UP	On Off	Mod.SW1 (CC#80) Mod.SW2 (CC#81)	Knob Mod.1 (CC#17) Knob Mod.2 (CC#19)	Knob Mod.3 (CC#20) Knob Mod.4 (CC#21)
B055	Windy Guitar Guitar/Plucked	On P004: RANDOM U102: ONCE!	On On	Mod.SW1 (CC#80) Lock JS(-Y) & Ribbon	Knob Mod.1 (CC#17) Knob Mod.2 (CC#19)	Knob Mod.3 (CC#20) Knob Mod.4 (CC#21)
B056	3FingerGateGame Rhythmic Pattern	On U150: Bossa Nova U033: TechnoBass Riff1	On On	Mod.SW1 (CC#80) Mod.SW2 (CC#81)	F/A Attack (CC#73) Knob Mod.2 (CC#19)	F/A Decay (CC#75) Knob Mod.4 (CC#21)
B057	NakedClav->ArpOn Synth	Off P000: UP P000: UP	On Off	Mod.SW1 (CC#80) Lock JS(-Y) & Ribbon	Knob Mod.1 (CC#17) Knob Mod.2 (CC#19)	Knob Mod.3 (CC#20) Knob Mod.4 (CC#21)

#	Name Category	Arp.SW Pattern A Pattern B	Run Run	Mod.SW1 Mod.SW2	Knob1 Knob2	Knob3 Knob4
B058	Little Angels Bell/Mallet/Perc	Off P004: RANDOM P000: UP	On Off	Mod.SW1 (CC#80) Lock JS(-Y) & Ribbon	Knob Mod.1 (CC#17) F/A Attack (CC#73)	Knob Mod.3 (CC#20) Knob Mod.4 (CC#21)
B059	Moss of the Tyne Keyboard	Off U150: Bossa Nova P000: UP	On Off	Octave Down Lock JS(-Y) & Ribbon	Knob Mod.1 (CC#17) Knob Mod.2 (CC#19)	Knob Mod.3 (CC#20) Knob Mod.4 (CC#21)
B060	Violins & Reeds Orchestral	Off P002: ALTERNATE1 U028: String Melody	On On	Mod.SW1 (CC#80) Lock Ribbon	F/A Attack (CC#73) F/A Decay (CC#75)	Knob Mod.3 (CC#20) Knob Mod.4 (CC#21)
B061	SynMoss 01 LeadSplits	Off U155: Drum'n'Bass 3 U170: Acid Drum	On On	Mod.SW1 (CC#80) Lock JS(-Y) & Ribbon	Knob Mod.1 (CC#17) Knob Mod.2 (CC#19)	Knob Mod.3 (CC#20) Knob Mod.4 (CC#21)
B062	Moss Split Synth Synth	Off U169: Bigbeats 2 P000: UP	On Off	Mod.SW1 (CC#80) Lock JS(-Y) & Ribbon	Knob Mod.1 (CC#17) F/A Attack (CC#73)	Knob Mod.3 (CC#20) Knob Mod.4 (CC#21)
B063	Superunison Rhythmic Pattern	On U145: 8 Beat U151: Latin-drums	On On	Mod.SW1 (CC#80) Mod.SW2 (CC#81)	Knob Mod.1 (CC#17) Knob Mod.2 (CC#19)	Knob Mod.3 (CC#20) Knob Mod.4 (CC#21)

* Combination Bank A and B064–B127 is same as the preloaded data of the TRITON.

Programs (MOSS.PCG)

Bank F

#	Name	Category	Arp.SW Arpeggio Pattern	OSC1 Type	OSC2 Type
F000	War Birds	FastSynth	Off U048: TEKNO stutter	Standard OSC	Standard OSC
F001	Palawan	MotionSynth	Off U083: Echo Chords 3	Resonance OSC	Organ Model
F002	Whirly E.P.	Keyboard	Off U035: TechnoBass Riff3	Electric Piano Model	Electric Piano Model
F003	Death Lead	LeadSynth	Off U048: TEKNO stutter	Standard OSC	Standard OSC
F004	Zoop 1	Drums	On U045: Funky Tekno Bass	Standard OSC	VPM OSC
F005	Neo Clav	Keyboard	Off U021: Funk Bass/Guitar	Plucked String Model	
F006	Rich Strings	Strings	Off U130: Mallet Roller	Comb Filter OSC	Standard OSC
F007	Speed Comp	MotionSynth	On U032: DanceBass Riff 3	Standard OSC	Standard OSC
F008	Phat Bass	Bass/Synth Bass	Off U042: Dance Bass+Comp	Standard OSC	Standard OSC
F009	Square Hollow	SlowSynth	Off U039: Open Funk Bass 1	Standard OSC	Standard OSC
F010	Frequency Lead	LeadSynth	Off U124: Random Techno	Standard OSC	Standard OSC
F011	Techno Sequence	MotionSynth	Off U014: BalladPicking2GT	Sync OSC	Standard OSC
F012	Blue Guitar	Guitar/Plucked	Off U008: Guitar Picking	Plucked String Model	
F013	Garage Choir	Vocal/Airy	Off U113: Techno Riff 2	Standard OSC	Standard OSC
F014	Bold Trumpet	Brass	Off U060: Crazy bee	Brass Model	
F015	Forest	SE	Off U109: Up uP UP Up uP	Reed Model	
F016	Sweepy Sawz	FastSynth	Off U134: CrazyComputer 3	Standard OSC	Standard OSC
F017	Night Lights	MotionSynth	On U048: TEKNO stutter	Organ Model	VPM OSC
F018	Tine Piano	Keyboard	Off U081: Echo Chords 1	VPM OSC	VPM OSC
F019	Sync Comp	LeadSynth	Off U078: 5-tone Vel Trip	Sync OSC	Standard OSC
F020	Dream Bell	Bell/Mallet	Off P001: DOWN	VPM OSC	Organ Model
F021	SinglePerc Organ	Organ	Off U051: Old Dance Bass 2	Organ Model	Organ Model
F022	Blue Sax	Woodwind/Reed	Off U079: 5-tone Vel Trip	Reed Model	
F023	Vowel Phase Mod	FastSynth	Off U031: DanceBass Riff 2	VPM OSC	Comb Filter OSC
F024	Dyna Slap Bass	Bass/Synth Bass	Off U055: Funk Bass	Plucked String Model	
F025	Wave Drum	Drums	On U177: Percussion	Plucked String Model	
F026	Sub Lead	LeadSynth	Off U124: Random Techno	Standard OSC	Standard OSC
F027	Ocean Calm	SlowSynth	Off U073: 5-tone Trance 3	Organ Model	Organ Model
F028	Metallic Bell	Bell/Mallet	Off U132: CrazyComputer 1	VPM OSC	VPM OSC
F029	Male Ahhs	Vocal/Airy	Off U041: Gated Dance Bass	Standard OSC	Standard OSC
F030	Hard Flute	Woodwind/Reed	Off U081: Echo Chords 1	Reed Model	
F031	Dimension	SE	Off U076: 2-tone Vel Trip	VPM OSC	Resonance OSC
F032	Arena Monster	FastSynth	Off U071: 5-tone Trance 1	Standard OSC	Standard OSC
F033	Butterfly Pad	MotionSynth	On U079: 5-tone Vel Trip	Sync OSC	Standard OSC
F034	Tremolo Synth	FastSynth	Off U085: Dance Comp 1	Standard OSC	Standard OSC
F035	Analog Lead	LeadSynth	Off U126: Trance Riff 2	Standard OSC	Standard OSC
F036	Zoop 2	Drums	Off U033: TechnoBass Riff1	VPM OSC	VPM OSC
F037	Comb Clav	Keyboard	Off U071: 5-tone Trance 1	Comb Filter OSC	Standard OSC
F038	Dream Strings	Strings	Off U141: Cresc/Decresc	Standard OSC	Standard OSC
F039	Zipperling	LeadSynth	Off U036: Tribal Bass	VPM OSC	Standard OSC
F040	Dirty Old Man	MotionSynth	On U065: Gated Pattern 1	Standard OSC	Standard OSC
F041	BPF Sweep	MotionSynth	Off P004: RANDOM	Standard OSC	Standard OSC
F042	Digi Morphious	MotionSynth	On U123: Echo Riff	Standard OSC	Standard OSC
F043	Techno S&H Pad	MotionSynth	On U112: Techno Riff 1	Standard OSC	Standard OSC
F044	Psychedelic Gtr.	Guitar/Plucked	Off U012: CountryPickng2GT	Plucked String Model	
F045	Stream Pad	SlowSynth	Off U140: Trickle	Standard OSC	Organ Model
F046	Zee Solo Violin	Strings	Off U014: BalladPicking2GT	Bowed String Model	
F047	Aliens Chitchat	SE	Off U042: Dance Bass+Comp	Bowed String Model	
F048	Giant REZ Sweep	MotionSynth	Off U075: 2-tone Vel Trip	Standard OSC	Standard OSC
F049	** ACID Rain **	MotionSynth	On U035: TechnoBass Riff3	Comb Filter OSC	Standard OSC
F050	Percussive Ring	FastSynth	Off U097: Staccato Tech	Ring Modulation OSC	VPM OSC
F051	Light Brass Lead	FastSynth	Off U077: 4-tone Vel Trip	Standard OSC	Standard OSC
F052	Bali Bells	Bell/Mallet	Off U130: Mallet Roller	Plucked String Model	
F053	Digital Dulcimer	Guitar/Plucked	On P004: RANDOM	Plucked String Model	
F054	Soprano Sax	Woodwind/Reed	Off U123: Echo Riff	Reed Model	
F055	Moving Picture	MotionSynth	Off U052: Stagger Bass	Standard OSC	Standard OSC

#	Name	Category	Arp.SW Arpeggio Pattern	OSC1 Type	OSC2 Type
F056	Touch FingerBass	Bass/Synth Bass	Off U050: Old Dance Bass 1	Plucked String Model	
F057	Rhythmic Seq	MotionSynth	On U042: Dance Bass+Comp	Standard OSC	Resonance OSC
F058	mini Lead	LeadSynth	Off U062: Stepping Note	Standard OSC	Standard OSC
F059	Osiris	FastSynth	Off U112: Techno Riff 1	Standard OSC	Standard OSC
F060	Reso Bell	Bell/Mallet	On U094: Kalimba groove	Comb Filter OSC	Resonance OSC
F061	Portamento Pad	MotionSynth	Off U140: Trickle	Standard OSC	Standard OSC
F062	Analog Brass	FastSynth	Off U096: Stab Rhythm	Standard OSC	Standard OSC
F063	LFO gating	MotionSynth	Off U058: Syncopation	Standard OSC	Standard OSC
F064	Full Synth	FastSynth	Off U073: 5-tone Trance 3	Standard OSC	Standard OSC
F065	Motion Comb	MotionSynth	Off U131: Comb & Pipe	Ring Modulation OSC	Comb Filter OSC
F066	Direct E.P.	Keyboard	Off U062: Stepping Note	VPM OSC	Electric Piano Model
F067	Morph 3003 Dist	Bass/Synth Bass	On U125: Trance Riff 1	Standard OSC	Standard OSC
F068	Zoop 3	Drums	Off P004: RANDOM	VPM OSC	Ring Modulation OSC
F069	Prophetic Pulse	FastSynth	Off U072: 5-tone Trance 2	Standard OSC	Standard OSC
F070	Huge Strings	Strings	Off P004: RANDOM	Comb Filter OSC	Standard OSC
F071	Rubbery Comp	FastSynth	Off U066: Gated Pattern 2	Standard OSC	Standard OSC
F072	Dark Pop Bass	Bass/Synth Bass	Off U031: DanceBass Riff 2	VPM OSC	VPM OSC
F073	Soft Pad	SlowSynth	Off U130: Mallet Roller	Standard OSC	Standard OSC
F074	Emmer's Sun Syn	FastSynth	Off U037: Acid Bass Riff	Standard OSC	Standard OSC
F075	Victory Pad	MotionSynth	Off U111: Random Up	Standard OSC	Cross Modulation OSC
F076	Nylon Acoustic	Guitar/Plucked	Off U008: Guitar Picking	Plucked String Model	
F077	AEIOU Choir	Vocal/Airy	Off U078: 5-tone Vel Trip	Standard OSC	Organ Model
F078	Bold Trombone	Brass	Off U091: House Organ	Brass Model	
F079	TREXvsHELICOPTER	SE	Off U100: Exressive Triad	Reed Model	
F080	Golden Synth	FastSynth	Off U030: DanceBass Riff 1	Standard OSC	Standard OSC
F081	Vision Makers	MotionSynth	Off U062: Stepping Note	Standard OSC	Sync OSC
F082	Dyna Expressive	Keyboard	Off U025: Piano Comp 2	Electric Piano Model	Electric Piano Model
F083	Deep Sync Lead	LeadSynth	Off P000: UP	Sync OSC	Standard OSC
F084	U.K. Synth Bell	FastSynth	Off U128: Quarks	Standard OSC	Standard OSC
F085	Pipe Organ Full	Organ	Off U137: Step Saw Down	Organ Model	Organ Model
F086	Dirty Sax	Woodwind/Reed	Off U042: Dance Bass+Comp	Reed Model	
F087	Flute Moss	SlowSynth	Off P004: RANDOM	Reed Model	
F088	Freaky Rez Bass	Bass/Synth Bass	Off U037: Acid Bass Riff	Plucked String Model	
F089	Noise Virus	SE	On U059: Happy Dog	Standard OSC	Comb Filter OSC
F090	Phunk Rez Lead	LeadSynth	Off U028: String Melody	Standard OSC	Standard OSC
F091	Comb Flute Pad	FastSynth	Off U073: 5-tone Trance 3	Comb Filter OSC	Standard OSC
F092	Water Bell	Bell/Mallet	Off P004: RANDOM	Resonance OSC	Resonance OSC
F093	'n'Bass	Bass/Synth Bass	Off U034: TechnoBass Riff2	Standard OSC	VPM OSC
F094	Cave Flute	Woodwind/Reed	Off U044: TB Bass Drone	Reed Model	
F095	Cyber Zone	SE	Off U102: ONCE!	VPM OSC	Resonance OSC
F096	HiPass Stuff	FastSynth	Off P003: ALTERNATE2	Standard OSC	Standard OSC
F097	Sunflower	MotionSynth	Off P001: DOWN	Resonance OSC	Comb Filter OSC
F098	Brass Ensemble	FastSynth	Off U101: Vice Squad	VPM OSC	VPM OSC
F099	Unison PWM	LeadSynth	Off P001: DOWN	Standard OSC	Standard OSC
F100	This is Zee One!	MotionSynth	On U087: Flashin' Arp	Resonance OSC	Standard OSC
F101	Analog Comb	FastSynth	Off U063: Trance Comp	Comb Filter OSC	Comb Filter OSC
F102	Antique Strings	Strings	Off U137: Step Saw Down	Standard OSC	Standard OSC
F103	1000 Knives	LeadSynth	Off U031: DanceBass Riff 2	Standard OSC	Ring Modulation OSC
F104	Deep Top Bass	Bass/Synth Bass	Off U134: CrazyComputer 3	Standard OSC	Standard OSC
F105	Pad Rize	MotionSynth	Off U141: Cresc/Decresc	Comb Filter OSC	Standard OSC
F106	Light Res Synth	FastSynth	On U097: Staccato Tech	Standard OSC	Standard OSC
F107	Resomotor	MotionSynth	Off P004: RANDOM	Resonance OSC	Comb Filter OSC
F108	Dirty Strato Gtr	Guitar/Plucked	Off U013: BalladPicking GT	Plucked String Model	
F109	Female Voice	Vocal/Airy	Off U059: Happy Dog	Standard OSC	Organ Model
F110	Saw Horn	FastSynth	Off P003: ALTERNATE2	Standard OSC	Standard OSC
F111	Mad Scientist	SE	Off P000: UP	VPM OSC	Standard OSC

#	Name	Category	Arp.SW Arpeggio Pattern	OSC1 Type	OSC2 Type
F112	Rezzit Oiid	FastSynth	Off U112: Techno Riff 1	Standard OSC	Standard OSC
F113	Harbinger	MotionSynth	Off U134: CrazyComputer 3	Resonance OSC	Comb Filter OSC
F114	Misty Synth	FastSynth	Off U091: House Organ	Organ Model	Organ Model
F115	Soft Syn Brass	FastSynth	Off U126: Trance Riff 2	Standard OSC	Standard OSC
F116	Science Laws	MotionSynth	On P004: RANDOM	Ring Modulation OSC	Sync OSC
F117	Rockin Bee!	Organ	Off U031: DanceBass Riff 2	Organ Model	Organ Model
F118	Hybrid Hardsyn	FastSynth	Off U129: Speed Sequence	VPM OSC	Standard OSC
F119	Inner Space	MotionSynth	On U044: TB Bass Drone	Standard OSC	Organ Model
F120	E.&Syn Bass	Bass/Synth Bass	Off U043: Trance Bass Riff	Plucked String Model	
F121	Noise Burst	Drums	Off U164: New Disco 2	Standard OSC	Standard OSC
F122	Rezo Bass	Bass/Synth Bass	Off U038: Hip Hop Bass1	Standard OSC	Standard OSC
F123	Ground Synth	FastSynth	Off P004: RANDOM	Standard OSC	Standard OSC
F124	Grand image Pad	FastSynth	Off U036: Tribal Bass	Standard OSC	Standard OSC
F125	Big Bass	Bass/Synth Bass	Off U041: Gated Dance Bass	Standard OSC	Standard OSC
F126	Laughter	SE	Off U125: Trance Riff 1	Reed Model	
F127	ANALOG INIT	FastSynth	Off U064: Trance Comp-Maj	Standard OSC	Standard OSC

This device complies with Part 15 of the FCC Rules. Operation is subject to the following two conditions: (1) This device may not cause harmful interference, and (2) this device must accept any interference received, including interference that may cause undesired operation.
Complies with Canadian ICES-003 Class B.
Conforme au Règlement Canadian NMB-003 classe B.

THE FCC REGULATION WARNING (for U.S.A.)

This equipment has been tested and found to comply with the limits for a Class B digital device, pursuant to Part 15 of the FCC Rules. These limits are designed to provide reasonable protection against harmful interference in a residential installation. This equipment generates, uses, and can radiate radio frequency energy and, if not installed and used in accordance with the instructions, may cause harmful interference to radio communications. However, there is no guarantee that interference will not occur in a particular installation. If this equipment does cause harmful interference to radio or television reception, which can be determined by turning the equipment off and on, the user is encouraged to try to correct the interference by one or more of the following measures:

- Reorient or relocate the receiving antenna.
- Increase the separation between the equipment and receiver.
- Connect the equipment into an outlet on a circuit different from that to which the receiver is connected.
- Consult the dealer or an experienced radio/TV technician for help.

Unauthorized changes or modification to this system can void the user's authority to operate this equipment.

Marque CE de conformité aux normes de sécurité européennes

La marque CE attachée à nos produits alimentés par secteur indique que ces produits sont conformes à la directive EMC (89/336/CEE) ainsi qu'à la directive relative à la marque CE (93/68/CEE). Cette marque est valable jusqu'au 31 décembre 1996.

La marque CE attachée après le 1 janvier 1997 indique que ces produits sont conformes à la directive EMC (89/336/CEE), à la directive relative à la marque CE (93/68/CEE) ainsi qu'à la directive relative au courant de basse tension (73/23/CEE).

Enfin, la marque CE attachée à nos produits alimentés par batterie indique que ces produits sont conformes à la directive EMC (89/336/CEE) ainsi qu'à la directive relative à la marque CE (93/68/EEC).

CE-Marke der EG-Norm

Die CE-Marke auf unseren netzgespeisten Geräten deutet auf deren Übereinstimmung mit den EMC- und CE-Richtlinien der EG (respektive 89/336/EWG und 93/68/EWG) hin. Diese Abzeichen ist bis zum 3. Dezember 1996 gültig.

Die CE-Marke ab 1. Januar 1997 deutet auf Übereinstimmung mit den EMC-, CE- und Niederspannungsstrom-Richtlinien der EG (respektive 89/336/EWG, 93/68/EWG und 93/68/EWG) hin.

Die CE-Marke auf unseren batteriegespeisten Geräten deutet auf deren Übereinstimmung mit den EMC- und CE-Richtlinien der EG (respektive 89/336/EWG und 93/68/EWG) hin.

IMPORTANT NOTICE TO CONSUMERS

This product has been manufactured according to strict specifications and voltage requirements that are applicable in the country in which it is intended that this product should be used. If you have purchased this product via the internet, through mail order, and/or via a telephone sale, you must verify that this product is intended to be used in the country in which you reside.

WARNING: Use of this product in any country other than that for which it is intended could be dangerous and could invalidate the manufacturer's or distributor's warranty.

Please also retain your receipt as proof of purchase otherwise your product may be disqualified from the manufacturer's or distributor's warranty.

KORG**KORG INC.**

15 - 12, Shimotakaido 1 - chome, Suginami-ku, Tokyo, Japan.