

DDD-1 DYNAMIC DIGITAL DRUMS

Erroneous entry was made in the Owner's Manual of DDD-1. Please kindly correct the part of diagrams of page 95.

Relationship between Sampling Clock and Sampling Time

Wrong

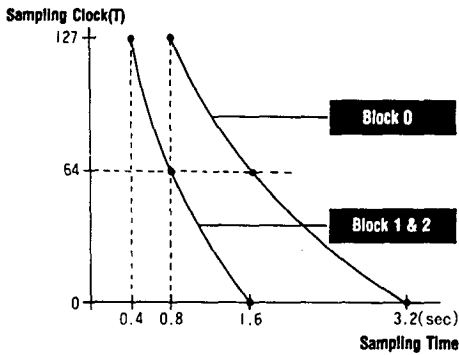

Right

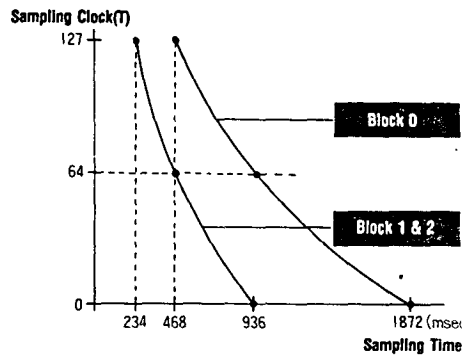

Tuning Range of Sampled Sound

Wrong

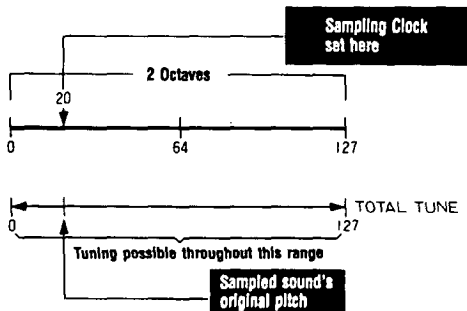

Right

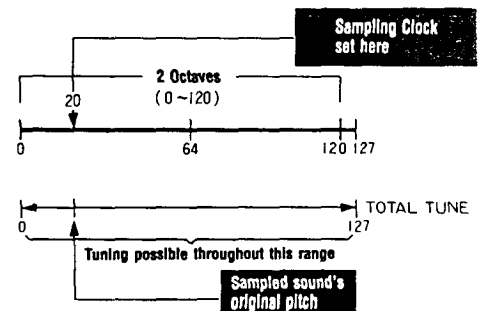

DDD-1 PATTERN CHART

■このパターンチャートは付属のカセットの“Basic Pattern”側に記録されているデータを記譜したものです。パターンをレコーディングする際のヒントなどにご使用ください。
(なお取扱説明書中の空パターン、ソングについては“Basic Pattern”側の内容に添って書かれています。)

■This PATTERN CHART shows data recorded in the accessory “BASIC PATTERN” cassette, Use settings as when doing PATTERN RECORDING.

(NOTE: Black PATTERN, and songs listed in the Owner’s Manual follow the “BASIC PATTERN” form.)

★譜面は以下の表記に統一してあります。

Normally, the display appears as below.

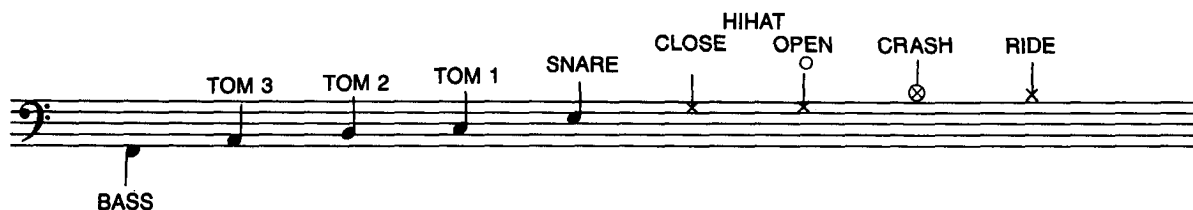

★指示のないものは全て4拍子です。

If there is no specific definition, these scores are of four-quarter measure.

KORG

Ptn 01 8Beat 01



Ptn 02 8Beat 02

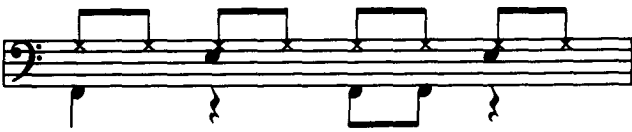

Ptn 03 8Beat 03



Ptn 04 8Beat 04



Ptn 05 8Beat 05

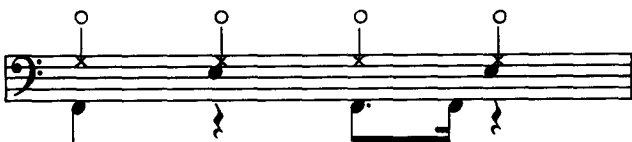

Ptn 11 16 Beat 01

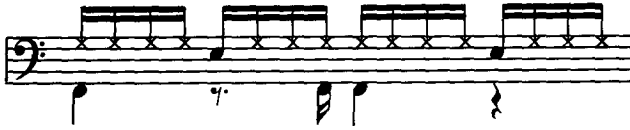

Ptn 12 16 Beat 02



Ptn 13 16 Beat 03



Ptn 14 16 Beat 04



Ptn 15 16 Beat 05



Ptn 16 16 Beat 06

Musical notation for Ptn 16, 16 Beat 06. The notation is on a single bass clef staff. It consists of two measures of music. The first measure contains four groups of eighth notes, each group consisting of a quarter note followed by two eighth notes. The second measure contains four groups of eighth notes, each group consisting of a quarter note followed by two eighth notes. There are circled 'o' symbols above the first and third groups of eighth notes in the second measure. The rhythm is indicated by '7' symbols below the notes.

Ptn 17 Bossa

Musical notation for Ptn 17 Bossa. The notation is on a single bass clef staff. It consists of two measures of music. The first measure contains four groups of eighth notes, each group consisting of a quarter note followed by two eighth notes. The second measure contains four groups of eighth notes, each group consisting of a quarter note followed by two eighth notes. There are circled 'o' symbols above the first and third groups of eighth notes in the second measure. The rhythm is indicated by '7' symbols below the notes. The notation ends with an 'x' symbol and the text '= RIM'.

Ptn 18 Samba 01

Musical notation for Ptn 18 Samba 01. The notation is on a single bass clef staff. It consists of two measures of music. The first measure contains four groups of eighth notes, each group consisting of a quarter note followed by two eighth notes. The second measure contains four groups of eighth notes, each group consisting of a quarter note followed by two eighth notes. The rhythm is indicated by '7' symbols below the notes.

Ptn 19 Samba 02

Musical notation for Ptn 19 Samba 02. The notation is on a single bass clef staff. It consists of two measures of music. The first measure contains four groups of eighth notes, each group consisting of a quarter note followed by two eighth notes. The second measure contains four groups of eighth notes, each group consisting of a quarter note followed by two eighth notes. The rhythm is indicated by '7' symbols below the notes.

Ptn 20 Samba 03

Musical notation for Ptn 20 Samba 03. The notation is on three bass clef staves. The top staff contains four groups of eighth notes, each group consisting of a quarter note followed by two eighth notes. The second staff contains four groups of eighth notes, each group consisting of a quarter note followed by two eighth notes. The third staff contains four groups of eighth notes, each group consisting of a quarter note followed by two eighth notes. The rhythm is indicated by '7' symbols below the notes. The notation ends with an 'x' symbol and the text '= COWBELL'. The text 'TAMBOURINE' is written below the second staff, and 'CABASA' is written below the third staff.

Ptn 26 Fill 03



Ptn 27 Fill 04



Ptn 28 Fill 05



Ptn 29 16 Beat 02a (Ptn 12 with accent)



Ptn 30 16 Beat 02R (Ptn 12 Ride)

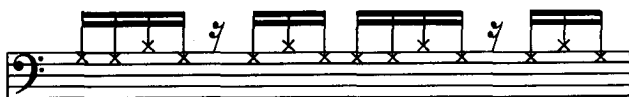

Ptn 31 16 Beat 02A (Ptn 30 with accent)

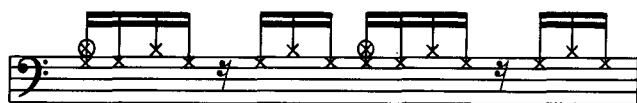

Ptn 32 Fill 06



Ptn 33 Fill 07



Ptn 34 Fill 08



Ptn 35 Fill 09



Ptn 36 Fill 10



Ptn 37 Fill 11



Ptn 38 Fill 12



Ptn 39 Fill 13



Ptn 40 Fill 14



Ptn 41 Fill 15



Ptn 42 Fill 16



Ptn 43 Fill 17

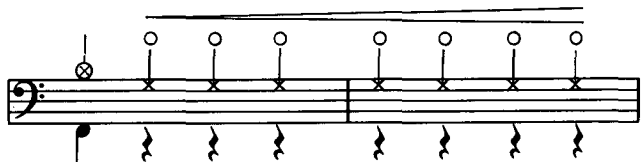

Ptn 44 Fill 18

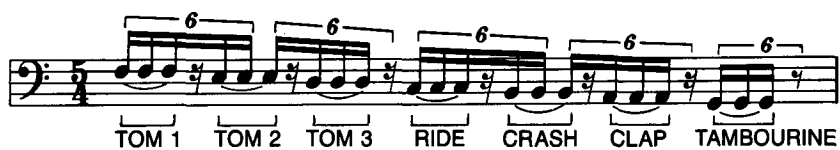

Ptn 45 Fill 19



Ptn 46 Fill 20



Ptn 47 Fill 21



■ソング1~3には以下のようにパターンが書き込まれています。

The following PATTERNS are written in SONGs 1~3.

Song 1 (8 Beat)

(Pattern Number) 21 — 24 — 02 — 25 —
21 — 26 — 02 — 27 —
21 — 28 — 02 — 45 —
23 — 22 — 22 — 39 —
23 — 22 — 22 — 42

Song 2 (16 Beat)

(Pattern Number) 37 — 29 — 34 — 12 — 32 —
29 — 36 — 12 — 35 —
31 — 30 — 30 — 38 —
31 — 30 — 30 — 39 —
31 — 40 — 43

Song 3 (Latin)

(Pattern Number) 46 — 17 — 47 — 17 — 43 —
18 — 49 — 18 — 40 —
20 — 20 — 20 — 20 — 50

DYNAMIC DIGITAL DRUMS DDD-1 MIDI IMPLEMENTATION CHART

Function		Transmitted	Recognized	Remarks
Basic Channel	Default	1~16	1~16	Memorized
	Changed	1~16 *1	1~16	
Mode	Default	3	1	Memorized (Mono/Poly ignored)
	Messages	×	OMNI ON/OMNI OFF	
	Altered	*****	×	
Note Number	: True voice	25~71	25~71	Common to receive/transmit
		*****	9~24 (SEQ DECAY) 72~96 (SEQ TUNE)	
Velocity	Note ON	○ 9n. v=1~127	○ 9n. v=1~127	
	Note OFF	× 9n. v= *2	○ 9n.v= or 8n.v=~127 *3	
After Touch	Key's	×	×	
	Ch's	×	×	
Pitch Bender		×	×	
Control Change		×	×	
Prog Change	: True #	×	○ (0~5)	Only received when set to INST Setting Function

System Exclusive		○	○	INST Setting, SONG and PATTERN data transmitted/received
System Common	: Song Pos	○	○	Only transmitted/received when operation is stopped in the SONG SELECT Function.
	: Song Sel	○ (0~9) *4	○ (0~9)	
	: Tune	×	×	
System Real Time	: Clock	○ *5	○ *6	
	: Commands	○: Start, Continue, Stop	○: Start, Continue, Stop	
Aux Messages	: Local ON/OFF	×	×	
	: All Notes OFF	×	×	
	: Active Sense	×	×	
	: Reset	×	×	
Notes		*1 Can be set for each INST key. *2 Sent immediately after NOTE ON signal. *3 Note Numbers 25~71 are ignored. *4 Transmitted only when operation is stopped in the SONG SELECT Function. *5 Transmitted when Clock is set to INTERNAL or TAPE. *6 Received when Clock is set to MIDI.		

Mode 1: OMNI ON, POLY Mode 2: OMNI ON, MONO
 Mode 3: OMNI OFF, POLY Mode 4: OMNI OFF, MONO

○: Yes
 ×: No

DYNAMIC DIGITAL DRUMS DDD-5 MIDI IMPLEMENTATION CHART

Function		Transmitted	Recognized	Remarks
Basic Channel	Default	1~16	1~16	Memorized
	Changed	1~16	1~16	
Mode	Default	3	1	Memorized (Mono/Poly ignored)
	Messages	×	OMNI ON/OMNI OFF	
	Altered	*****	×	
Note Number	: True voice	25~71	25~71	Common to receive/transmit
		*****	9~24 (SEQ DECAY) 72~96 (SEQ TUNE)	
Velocity	Note ON	○ 9n. v=1~127	○ 9n. v=1~127	
	Note OFF	× 9n. v=0	×	
After Touch	Key's	×	×	
	Ch's	×	×	
Pitch Bender		×	×	
Control Change		×	×	
Prog Change : True #		×	○ (0~5)	Only received when set to INST Setting Function
System Exclusive		○	○	INST Setting, SONG and PATTERN data transmitted/received
System Common	: Song Pos	○	○	Song Pos is only transmitted/received when operation is stopped in the SONG SELECT Function.
	: Song Sel	○(0~23)	○(0~23)	
: Tune	×	×		
System Real Time	: Clock	○	○	
	: Commands	○	○	
Aux Messages	: Local ON/OFF	×	×	
	: All Notes OFF	×	×	
	: Active Sense	×	×	
	: Reset	×	×	
Notes				

Mode 1: OMNI ON, POLY Mode 2: OMNI ON, MONO
 Mode 3: OMNI OFF, POLY Mode 4: OMNI OFF, MONO

○: Yes
 ×: No

DDD-1

**DYNAMIC DIGITAL DRUMS
OWNER'S MANUAL**

DDD-1

Congratulations and thank you for purchasing the Korg DDD-1. To assure optimum performance and long term reliability please read this manual carefully.

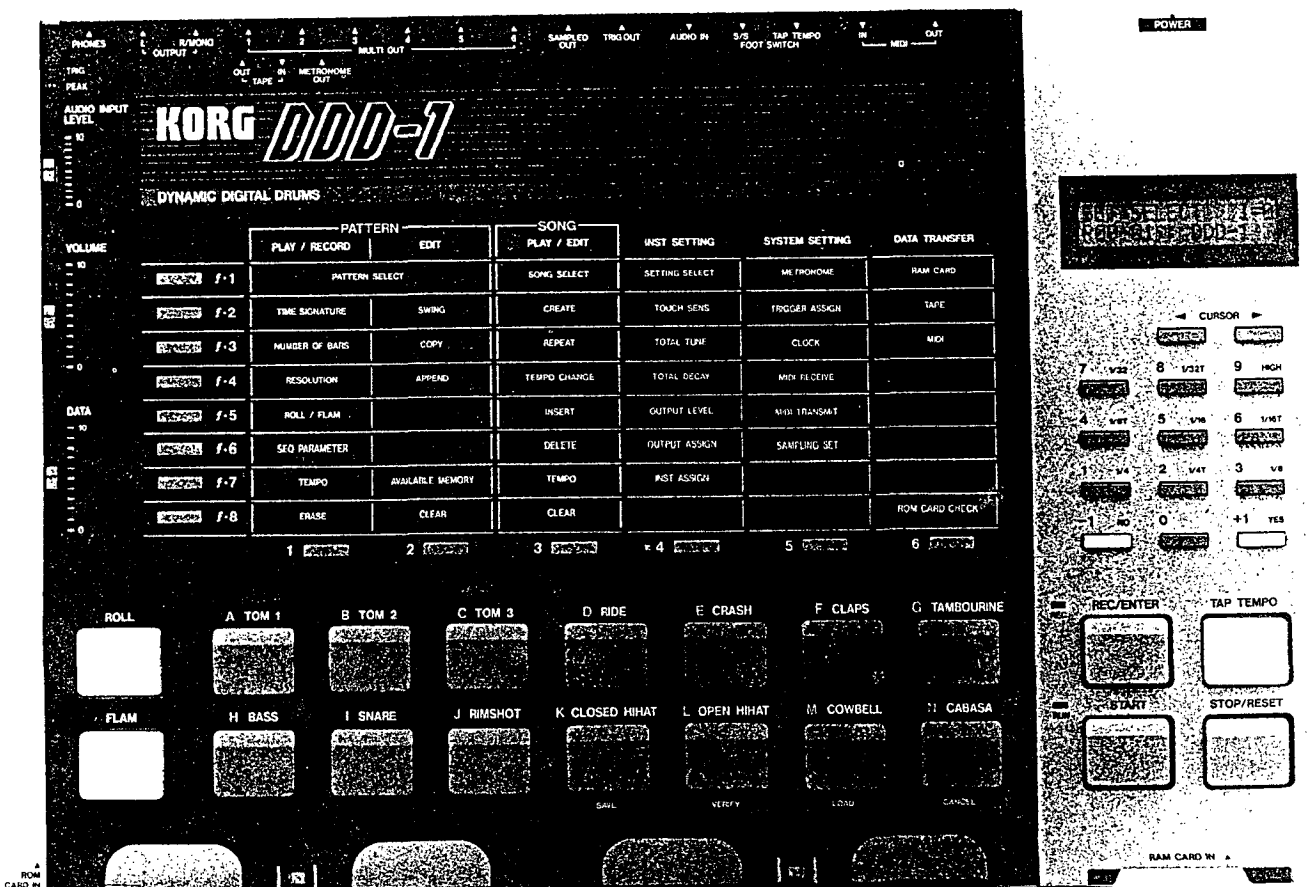

MAIN FEATURES OF THE DDD-1

1 The DDD-1 offers a full lineup of features which help provide realistic drum and percussion sounds. For example, the dynamics function lets you control output volume for each instrument sound according to the strength of instrument key touch. Each sound can be Tuned individually, as can Decay and Output Level. Instrument sounds can be freely assigned to individual keys via Instrument Assign, and each sound can be panned through one of 7 outputs via Output Assign. And a POLY mode is featured which lets you "layer" up to 12 notes from the same instrument.

2 The DDD-1 has a built-in PCM sound generator, for authentic instrument sounds. Up to 4 ROM cards can be used simultaneously, for a wide range of rhythm variation when used with the 18 built-in instrument sounds. Also, utilization of the optional Sampling Board gives you unlimited access to any external sounds, so you can create your own original sound sources.

3 Up to 100 PATTERNS, and 10 complete SONGS featuring 255 parts can be kept in the DDD-1 memory, via either Real Time or Step Recording. These two recording methods can be used together to create complex rhythms that aren't possible using one individually.

4 A 2-line, 16-character LCD display provides user-friendly operational instructions, so even complex operations are made easy.

5 DDD-1 Memory Data can be preserved via Tape Interface or on RAM Card, for unlimited rhythm data creation possibilities.

6 The DDD-1 features a MIDI terminal, so it can be used to control, or be controlled by other MIDI sequencers or drum machines. Not only that, but MIDI keyboards can be used to control the DDD-1, and even be used to write patterns on the DDD-1. DDD-1 data can be output as System Exclusive Messages, and Instrument Settings can be altered via Program Change messages for total convenience in MIDI communications.

IMPORTANT PRECAUTIONS

■ LOCATION

Do not use this unit for extended periods of time where it is exposed to:

- direct sunlight
- extreme of temperature or humidity
- sand or dust

■ POWER SUPPLY

- Use only with rated AC voltage. If you will be using this unit in an area having a different voltage, be sure to use a proper voltage converter.
- To help prevent noise and degraded sound quality, avoid using the same outlet as other equipment or branching off extension cords shared by other equipment.

■ INTERFERENCE

This unit uses microcomputer circuitry. Like all such devices, it is subject to interference from nearby electrical devices like fluorescent lamps, appliances with motors, and so on. If operation becomes erratic or unpredictable, or if there is no response when you press a button on the unit, then interference may be the cause. If this occurs, try turning off the power, then turning it back on again. This resets (initializes) the microcomputer.

■ HANDLE GENTLY!

Don't drop this unit or use more force than necessary to operate switches and keys.

■ CLEANING EXTERIOR SURFACES

Wipe the exterior lightly with a clean, dry soft cloth to remove dust and dirt. Never use strong solvents like benzine, paint thinner, rubbing compound flammable polishing agents.

■ KEEP THIS MANUAL

Keep this manual in a safe place for future reference.

■ MEMORY BACKUP BATTERY

This unit is equipped with a backup battery so that programmed data is retained in memory even when the unit's power is turned off. This battery should last over 5 years, however it is suggested that you change it after 5 years of service. Contact your service or sales representative for information on replacement.

CONTENTS

FEATURES & FUNCTION	6	SONG CREATION	76
1. Front Panel	6	1. Song Creation/Editing	76
2. Rear panel/Connections	8	2. Song Creation/Editing Actual Operations	80
BASIC OPERATION	10	•CREATE	80
1. DDD-1 Background knowledge	10	•REPEAT	83
2. Pattern Selection & Playback	13	•TEMPO CHANGE	84
•PATTERN SELECT	13	•INSERT	85
3. Song Selection/Playback	16	•DELETE	88
•SONG SELECT	16	•CREAR	89
4. Manual Play	19	3. Song Names	90
5. Tempo Setting/Change	20	SYSTEM SETTING	91
•TEMPO	20	1. System Setting	91
INSTRUMENT SETTING	22	2. System Setting Actual Operation	96
1. Instrument Setting	22	•METRONOME	96
2. Instrument Setting Actual Operation	28	•TRIGGER	98
•SETTING SELECT	28	•CLOCK	99
•TOUCH SENS	29	•MIDI RECEIVE	100
•TOTAL TUNE	30	•MIDI TRANSMIT	103
•TOTAL DECAY	31	•SAMPLING SET	105
•OUTPUT LEVEL	32	DATA TRANSFER	109
•OUTPUT ASSIGN	33	1. Data Transfer	109
•INST ASSIGN	34	2. Data Transfer Actual Operation	110
HOW TO RECORD PATTERNS	36	•RAM CARD	110
1. Recording Patterns	36	•TAPE	117
2. Pattern Recording Operations	45	•MIDI	127
•TIME SIGNATURE	45	•ROM CARD CHECK	130
•NUMBER OF BARS	47	CONNECTION WITH OTHER DEVICES	131
•RESOLUTION	49	1. Synchronization with other Drum Machines, Synthesizers, etc.	131
•ROLL/FLAM	50	2. About Connecting the DDD-1 to Drum Pads, Synthesizers, etc.	136
3. Real Time Recording	51	MIDI IMPLEMENTATION	138
4. Step Recording	53	1. Transmitted Data	138
5. Recording Sequence Parameters	59	2. Recognized Receive Data	140
•SEQ PARAMETTER	59	3. Using System Exclusive Messages	144
6. Erase	63	SYSTEM RESET	148
•ERASE	63	MAIN ERROR MESSAGE	148
7. Editing of Patterns	65	SPECIFICATIONS & OPTIONS	149
8. Pattern Editing Actual Operations	68		
•SWING	68		
•COPY	69		
•APPEND	71		
•AVAILABLE MEMORY	72		
•CLEAR	73		
9. Pattern Names	74		

FEATURES & FUNCTIONS

1. Front Panel

■ TRIG LED

■ PEAK LED

■ AUDIO INPUT SLIDER LEVEL

■ VOLUME SLIDER

■ FUNCTION SELECT KEY

■ DATA SLIDER

■ MODE SELECT KEY

■ ROLL KEY

■ INSTRUMENT KEYS (A-N)

■ FLAM KEY

■ ROM CARD SLOTS

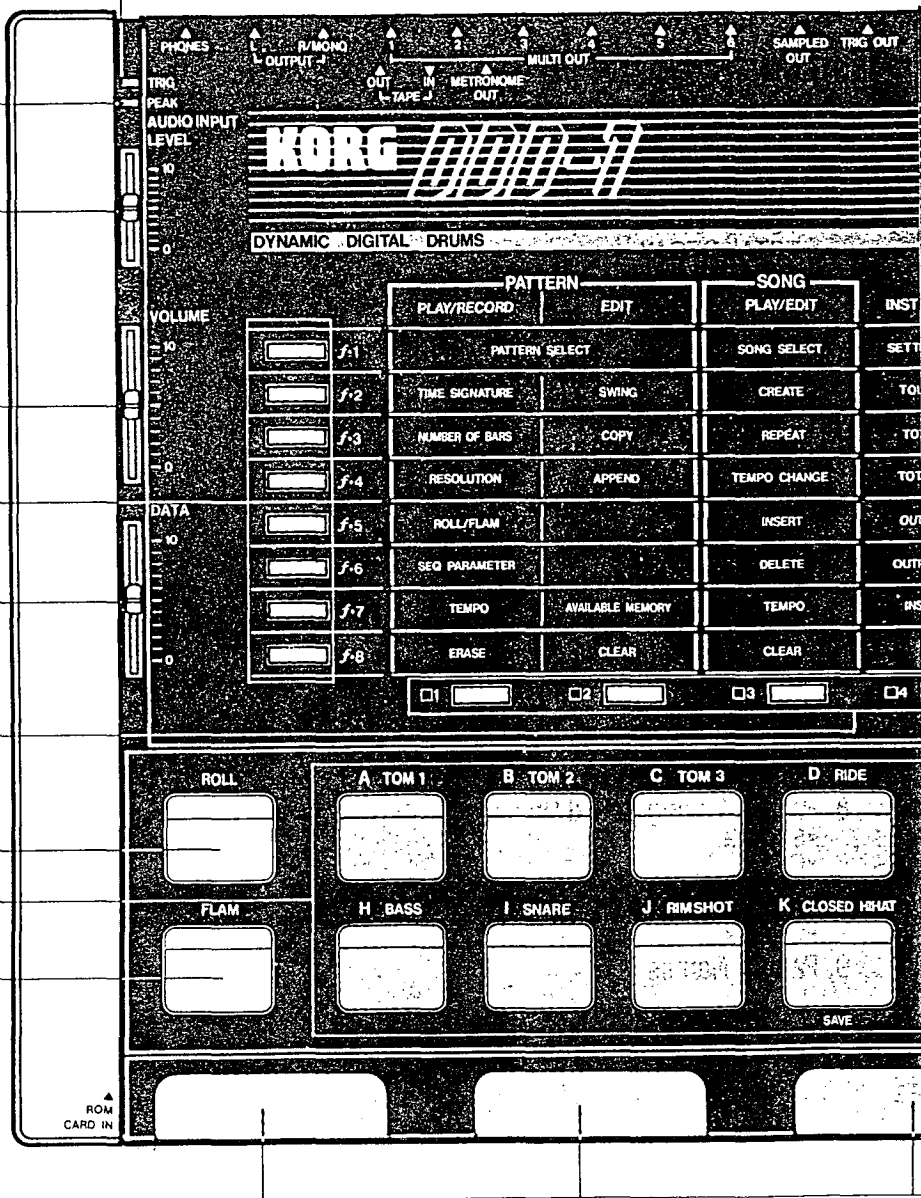

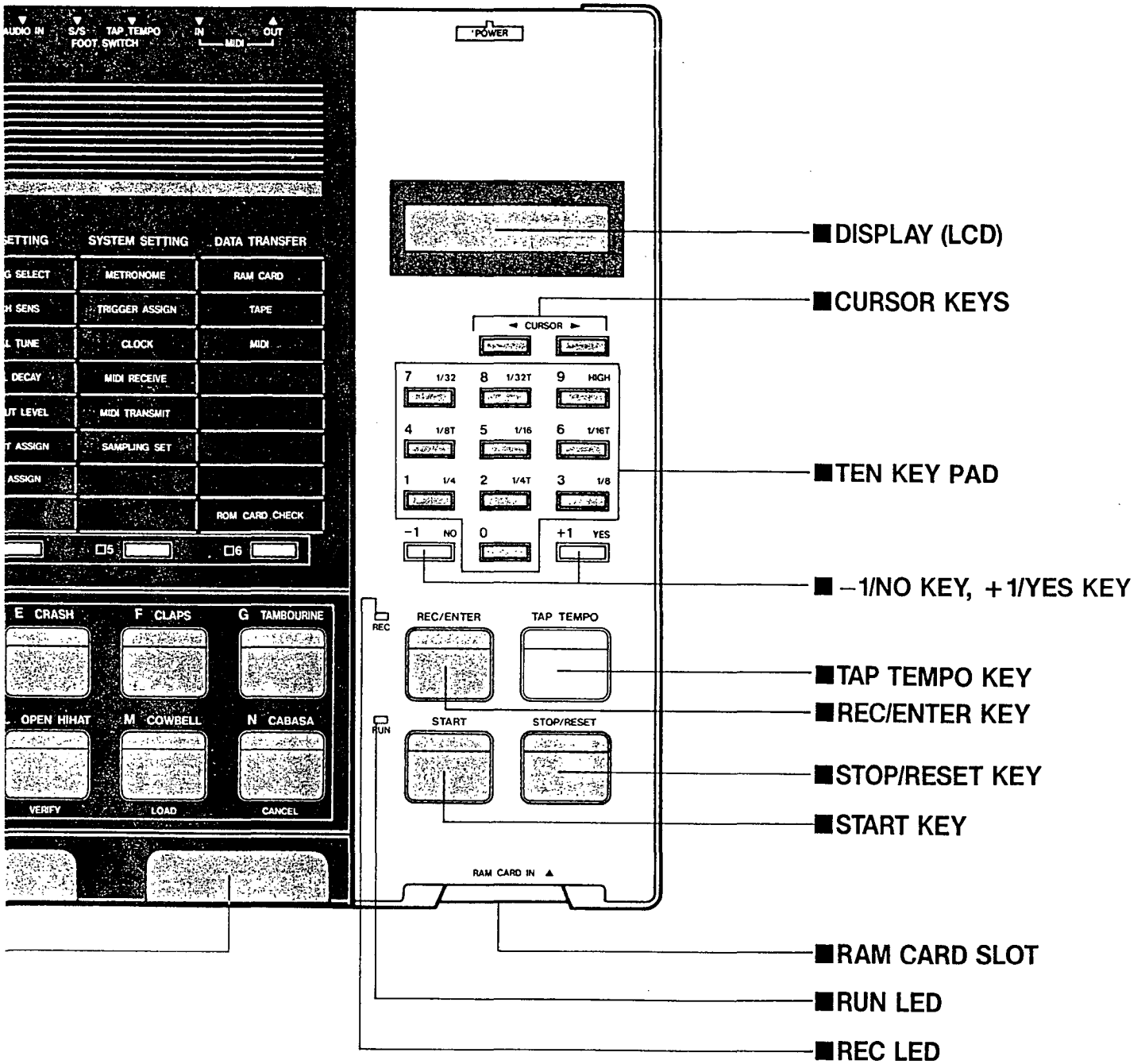

2. Rear Panel/Connections

■ **AUDIO IN JACK**

For trigger input and Sampling sound sources.

■ **SAMPLING BOARD SLOT**

■ **POWER SWITCH**

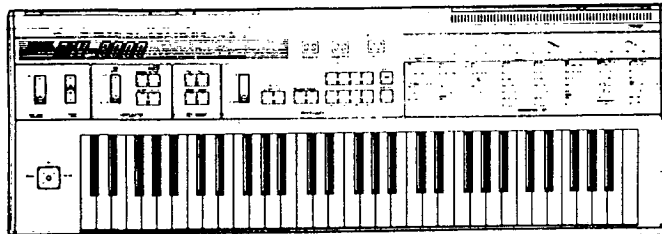
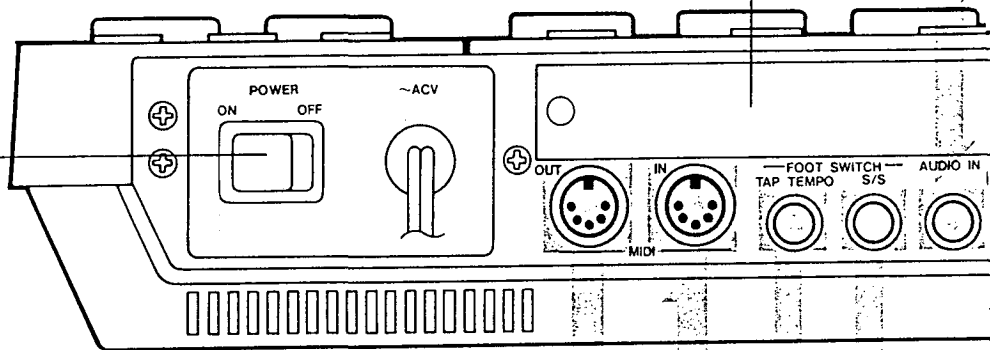

DW-8000

■ **FOOT SWITCH JACKS**

For connecting the optional Foot Switch. And Footswitches can be used to control START/STOP and TAP TEMPO.

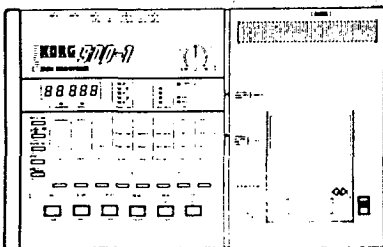
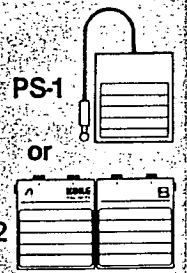

SQD-1

MIDI DRUM PAD

■ **MIDI TERMINALS**

For connecting MIDI Synthesizers, MIDI Sequencers, MIDI Drum Pads, etc. Refer to page 131 for details.

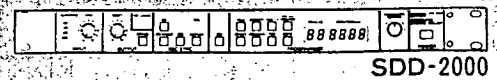

SDD-2000

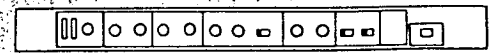

SDD-1200

■ **TRIG OUT JACK**

Connect to Delay units, Sampler or Synthesizer etc. featuring Trigger In jacks to control units according to DDD-1 preset rhythm. Useful in setting timing in trigger overdubs. Polarity can be changed by DIP Switch setting.

METRONOME OUT JACK

Outputs metronome sound only. When a plug is inserted into this jack, metronome sound can not be output via the OUTPUT JACK.

TAPE JACK

Used for connecting MTR for multi-track recording synchronization, or for connecting DATA RECORDER to preserve data on tape.

Display Contrast

(Preset)

DIP SWITCH

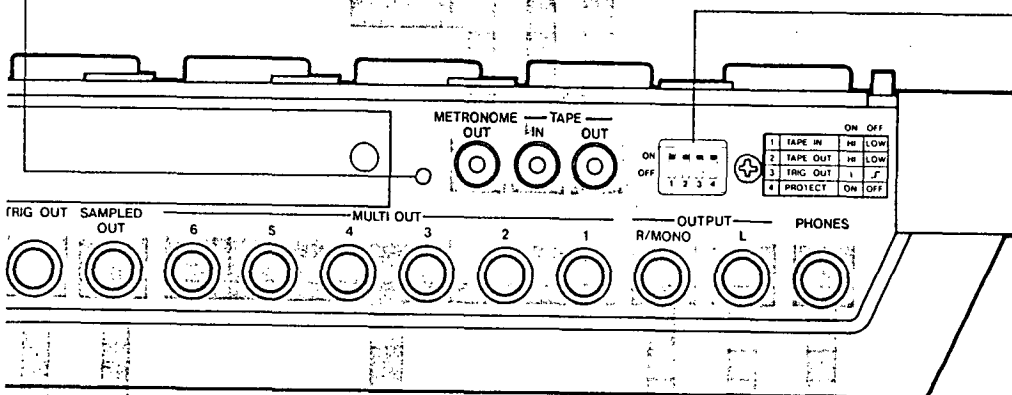

PHONE JACK



Used to connect headphones.

KH-1000 Headphones

EQUALIZER

KME-56

DELAY

SDD-2000

Phase Shifter, Flanger, Noise Gate, Compressor, Reverb or other Effect Units

KES Series

MULTI OUT JACK

Used for outputting various sound sources produced by the DDD-1 individually, and processing via effect units. Assignment of jacks to instrument sounds can be set freely.

SAMPLING OUT JACK

For outputting sampling sound only when using optional Sampling Board.

KMX-62

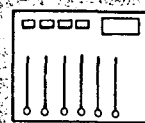

Mixer, Amp, MTR etc.

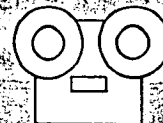

IPM-30

OUTPUT JACKS

Output jacks for instrument sounds not output via MULTI OUT jacks. For stereo output, connect to both L and R/MONO output jacks. In this configuration, the fixed position of instrument sound may be distributed throughout 3 points: R3, R2, R1, CENTER, L1, L2, L3. The R/MONO jack is used for monaural output.

BASIC OPERATION

1. DDD-1 Background Knowledge

FUNCTION OF EACH MODE

The DDD-1 features six different modes, which are used for the functions listed below;

FUNCTIONS SELECT KEY	PATTERN		SONG
	PLAY/RECORD	EDIT	PLAY/EDIT
<input type="checkbox"/> f.1	PATTERN SELECT		SONG SELECT
<input type="checkbox"/> f.2	TIME SIGNATURE	SWING	CREATE
<input type="checkbox"/> f.3	NUMBER OF BARS	COPY	REPEAT
<input type="checkbox"/> f.4	RESOLUTION	APPEND	TEMPO CHANGE
<input type="checkbox"/> f.5	ROLL/FLAM		INSERT
<input type="checkbox"/> f.6	SEQ PARAMETER		DELETE
<input type="checkbox"/> f.7	TEMPO	AVAILABLE MEMORY	TEMPO
<input type="checkbox"/> f.8	ERASE	CLEAR	CLEAR

MODE SELECT KEY	1	2	3
<input type="checkbox"/>	<input type="checkbox"/>	<input type="checkbox"/>	<input type="checkbox"/>

PATTERN PLAY/RECORD MODE
 This mode is used for playback and recording PATTERNS. It is selected by pressing MODE SELECT KEY 1.
 → P.36

PATTERN EDIT MODE
 This mode is used in editing PATTERNS. It is selected by pressing MODE SELECT KEY 2.
 → P.65

SONG PLAY/EDIT MODE
 This mode is used in creating, editing and playing back songs. It is selected by pressing MODE SELECT KEY 3.
 → P.76

- ★ The FUNCTION SELECT KEYS and MODE SELECT KEYS are used in combination to select the various functions displayed on the FUNCTION MATRIX at the center of the operating panel. For example, to set the beat via the TIME SIGNATURE function, first press MODE KEY "1" specifying the PLAY/RECORD MODE, and then press the "f.2" FUNCTION SELECT KEY.
- ★ When a MODE SELECT KEY is pressed, the LED immediately to the left of the key lights, and the FUNCTION SELECT KEY is set at "f.1".

(EX.)

	PATTERN		SONG
	PLAY/RECORD	EDIT	PLAY/EDIT
<input type="checkbox"/> f.1	PATTERN SELECT		SONG SELECT
<input checked="" type="checkbox"/> f.2	TIME SIGNATURE	SWING	CREATE
<input type="checkbox"/> f.3	NUMBER OF BARS	COPY	REPEAT
<input type="checkbox"/> f.4	RESOLUTION	APPEND	TEMPO CHANGE
<input type="checkbox"/> f.5	ROLL/FLAM		INSERT
<input type="checkbox"/> f.6	SEQ PARAMETER		DELETE
<input type="checkbox"/> f.7	TEMPO	AVAILABLE MEMORY	TEMPO
<input type="checkbox"/> f.8	ERASE	CLEAR	CLEAR

MODE SELECT KEY	1	2	3
<input checked="" type="checkbox"/>	<input type="checkbox"/>	<input type="checkbox"/>	<input type="checkbox"/>

INST SETTING	SYSTEM SETTING	DATA TRANSFER
SETTING SELECT	METRONOME	RAM CARD
TOUCH SENS	TRIGGER ASSIGN	TAPE
TOTAL TUNE	CLOCK	MIDI
TOTAL DECAY	MIDI RECEIVE	
OUTPUT LEVEL	MIDI TRANSMIT	
OUTPUT ASSIGN	SAMPLING SET	
INST ASSIGN		
		ROM CARD CHECK

INSTRUMENT SETTING MODE

This mode is used in setting the DDD-1's INST KEY and instrument sounds. It is selected by pressing MODE SELECT KEY 4.

→ P.22

SYSTEM SETTING MODE

This mode is used in relation to DDD-1 MIDI settings, Clock, Sampling, etc. It is selected by pressing MODE SELECT KEY 5.

→ P.91

DATA TRANSFER MODE

This mode relates to data transmission and reception. It is selected by pressing MODE SELECT KEY 6.

→ P.109

BASIC OPERATION

■ ABOUT PATTERNS & SONGS

Normally, drum performances in songs consist of combinations of basic rhythm patterns such as 8- or 16-beat patterns, fill-ins and breaks. Because of this, it's not necessary to program entire songs—simply the basic patterns, fills and breaks that they are composed of.

The DDD-1 refers to these patterns, fill-ins and breaks as **PATTERNS**. **PATTERNS** are created via **PATTERN PLAY/RECORD MODE** and **PATTERN EDIT MODE**. These patterns are tied together and made into a song via the **SONG PLAY/EDIT MODE**.

The maximum number of **PATTERNS** and **SONGS** which the DDD-1 holds are listed below;

PATTERNS:

Holds up to 100 patterns in memory, No.00 to 99.
The length of each pattern can be set from 1 to 99 measures. The maximum no. of notes which can be written in a pattern is 249, for a total of 4400 notes in the memory.

Patten No.	No. of notes/Bar	No. of notes/2 Bars	(up to 99 bars)
00	10	15 10
01	20	18 0
02	18	0 0
03	14	0 0
.....
99	32	15 0
Total		Up to 4400 notes	

SONGS:

Holds up to 10 SONGs in memory, No.0 to 9.
Up to 255 PARTS* can be connected within each SONG.

★As shown in the diagram, various SONGs as well as PATTERNS can be stored and played back within a single SONG. For example, drum solos or fills can be mixed with various songs to create a single medley. Each PATTERN and SONG used to create a complete SONG is called a PART.

(For example), PATTERNs and SONGs such as those shown below can be put into memory:

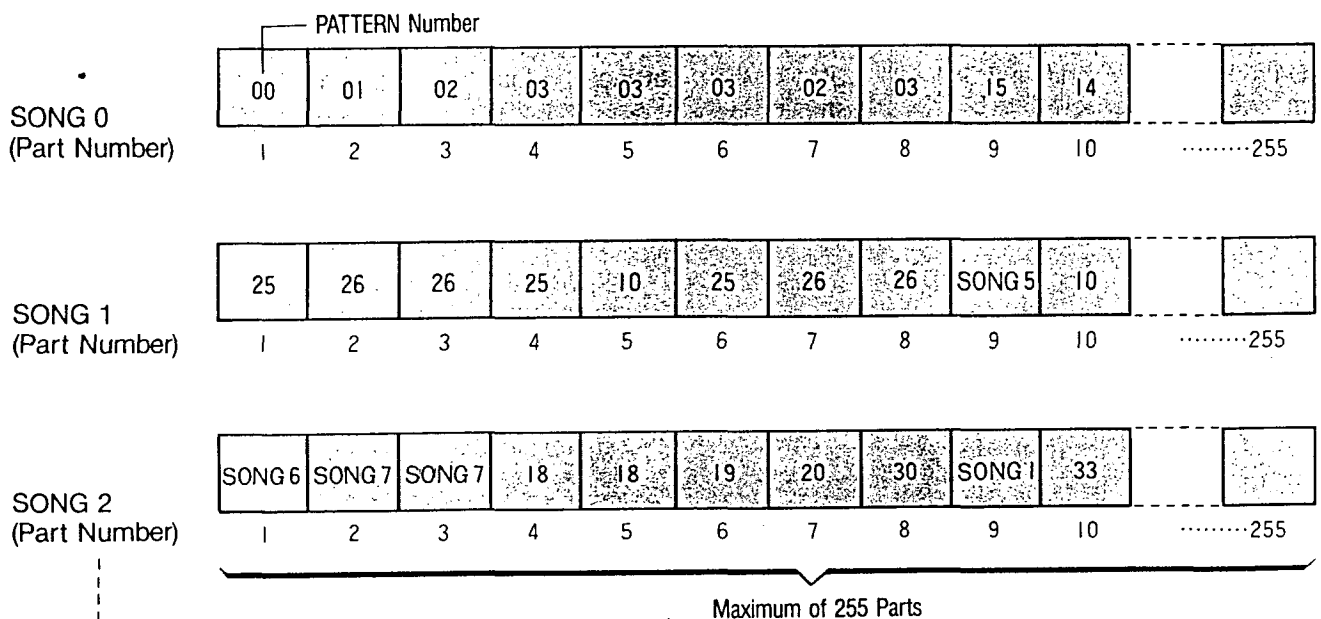

2. Pattern Selection & Playback

Follow the directions listed below to playback various patterns one at a time.
 (Demonstration Patterns 01~50 are set in the Pattern Numbers.)

OPERATION	LCD & LED DISPLAY
<p>Turn DDD-1 power switch ON. A ROM card check is performed automatically, and playback is possible after approximately 6 seconds.</p>	<p style="text-align: center;">↓</p> <p>When the power switch is turned ON, the ROM card check described on p.130 is performed automatically.</p> <p style="text-align: center;">↓</p>
<p>① To play back a pattern, press MODE SELECT KEY "1" specifying the PATTERN PLAY/RECORD MODE.</p> <p>Press <input type="checkbox"/> 1 </p> <p>At this time, the FUNCTION SELECT KEY is set to "f.1" — PATTERN SELECT.</p>	<p style="text-align: center;">↓</p> <p style="text-align: right;">INST SETTING NUMBER</p>

- ② Specify the Pattern Number which you desire to play back by pressing the ten key pad or +1/YES and -1/NO keys.

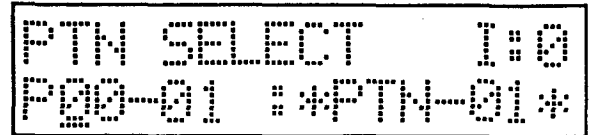
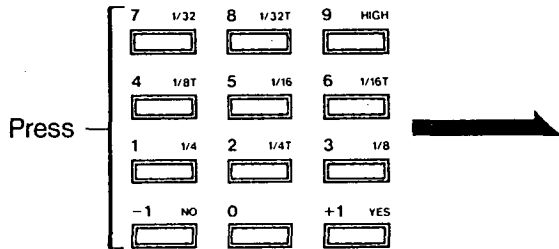

Song Number and Song Name Change

- Any measure can be selected as the starting point for PATTERNS made up of multiple measures. (When selection is not necessary, proceed to step ③.)

- ②-1 Move the CURSOR to measure display position on the LCD display, via the CURSOR KEY.

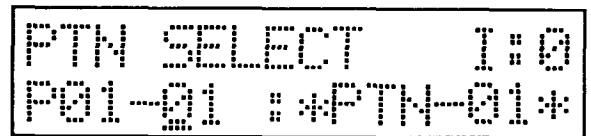

Cursor Moves

- ②-2 Specify the desired measure via the ten key pad or +1/YES and -1/NO keys.

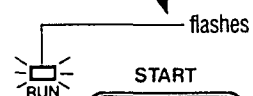
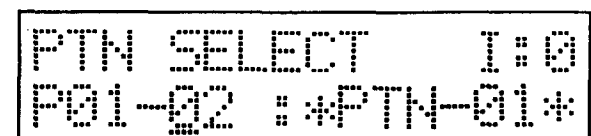
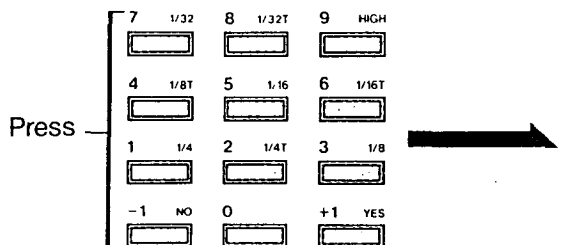

(Indicates Start position is not at beginning.)

③ Press the START KEY.

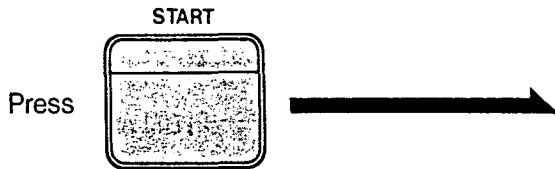

- Selected PATTERN plays back repeatedly. Other PATTERNs may be selected during playback by following step ② procedures. Immediately after the PATTERN is changed, the selected Pattern Number is displayed. When the present PATTERN cycle is completed, the newly selected Pattern Name is displayed, and playback begins.

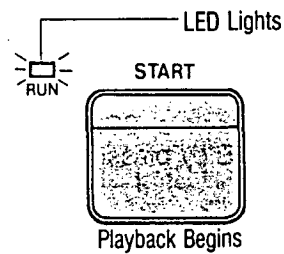

```
PTN PLAY      I:0
P01-02  :*PTN-01*
```

Measure being played back displayed.

④ Pressing the STOP/RESET KEY temporarily stops playback.



- Playback can be continued by pressing the START KEY. This is called Continue Start, and playback begins from the point where it was stopped with the STOP/RESET KEY. Pressing the STOP/RESET KEY instead of the START KEY will RESET the unit (stop playback).

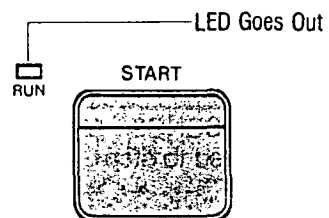
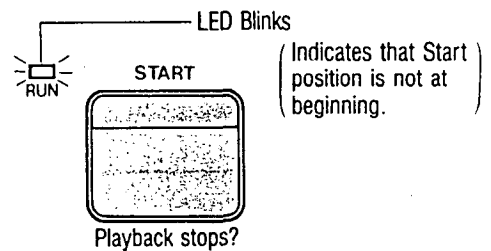
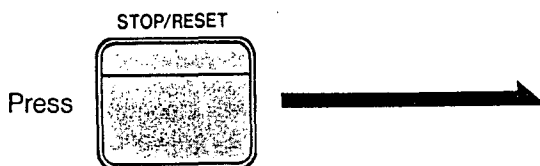











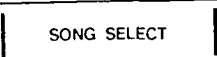

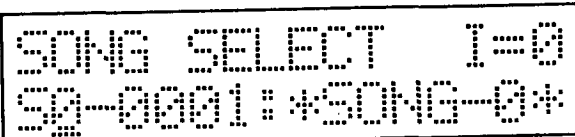







```
PTN SELECT    I:0
P01-01  :*PTN-01*
```

Measure returns to 01

3. Song Selection/Playback

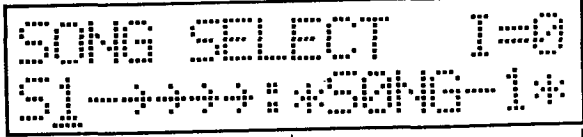
Follow the procedures listed below to play back an entire SONG. (The Song Number is preset at number 1~3.)

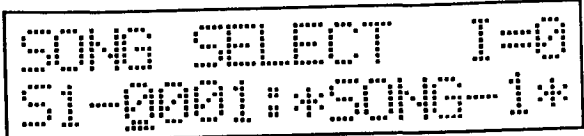
OPERATION	LCD & LED DISPLAY
<p>① When playing back a SONG, specify the SONG PLAY/EDIT MODE by pressing MODE SELECT KEY "3"</p> <p>Press  </p> <p>At this time, FUNCTION SELECT is set to "f.1" SONG SELECT.</p> <p> f.1 </p>	<p>LED Lights</p> <p> </p> <p>INST SETTING No.</p> <p></p> <p>SONG No. BAR No. PATTERN NAME</p>
<p>② Specify the Song Number which you desire to playback by pressing the ten key pad or +1/YES and -1/NO keys.</p> <p>Press            </p> <p></p>	<p></p> <p>Song Number and Song Name Change</p>
<p>• Any measure can be selected as the playback starting point for SONGS. (When selection is not necessary, proceed to step ③.)</p> <p>②.1 Move the CURSOR to measure display position on the LCD display, via the CURSOR KEY.</p> <p>Press  </p>	<p></p> <p>Cursor Moves</p>

②-2 Specify the desired measure via the ten key pad or +1/YES and -1/NO keys.

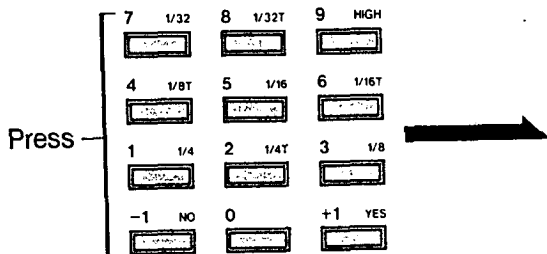

SONG SELECT I=0
S1-→→→→: *SONG-1*

(Indicates that specified Bar is being searched)

SONG SELECT I=0
S1-0020: *SONG-1*

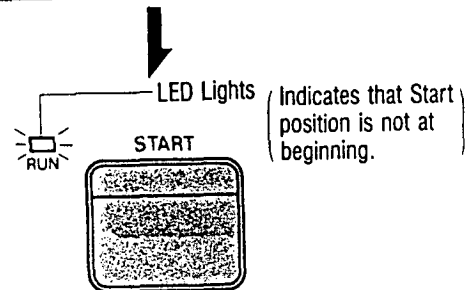

③ Press the START KEY.

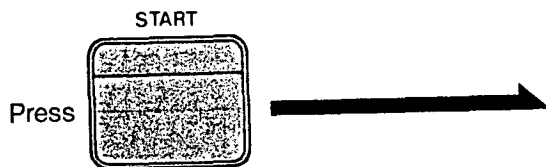

★ It is impossible to start SONGs wherein Song datas have not been written.

- Other Song Numbers may be selected during playback by following step ② procedures. Immediately after the measure being played back is completed, playback of the newly selected SONG begins. If no PATTERNS have been written in the selected SONG, unit operation returns to step ②.

- When SONG playback is completed, unit operation returns to step ②.

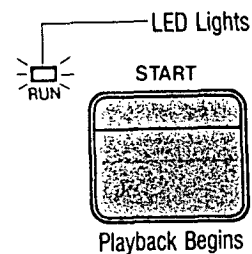

SONG PLAY I=0
S1-0002: *SONG-1*

Measure being played back displayed.

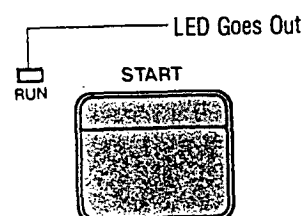

- ④ Pressing the STOP/RESET KEY temporarily stops playback.

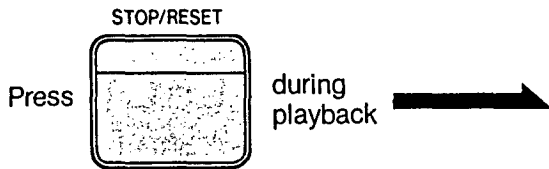

- Playback can be continued by pressing the START KEY. This is called Continue Start, and playback begins from the point where it was stopped with the STOP/RESET KEY. Pressing the STOP/RESET KEY instead of the START KEY will RESET the unit (stop playback).

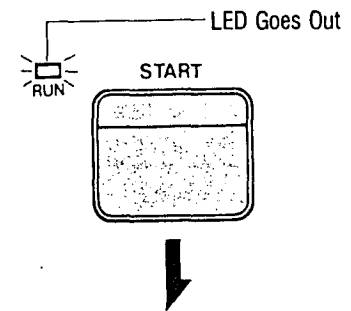
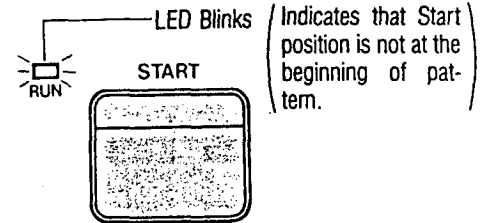

```
SONG SELECT I=0
SI-0001: *SONG-1*
```

Measure returns to 0001

4. Manual Play

When any of the 14 INST. KEYS on the front panel are tapped, sound sources are output according to INST. SETTINGS, (as described on page 22.) MANUAL PLAY may be performed at any time — whether the unit is stopped or engaged in playback, except when in the DATA TRANSFER MODE.

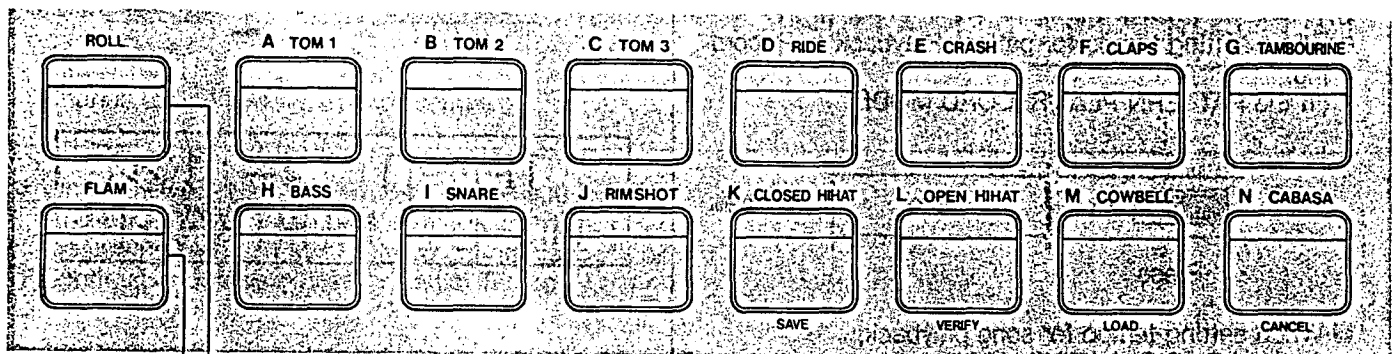

(Sound sources output according to INST SETTINGS
when INST KEYS are tapped.)

(If an INST KEY is pressed while holding down the
ROLL KEY during playback or recording, a roll effect
is obtained for as long as the keys are held down,
according to the timing set via ROLL RESOLUTION.)

(If an INST KEY is pressed while holding down the
FLAM KEY, a flam effect is obtained, according to
timing set via FLAM TIME.)

5. Tempo Setting/Change

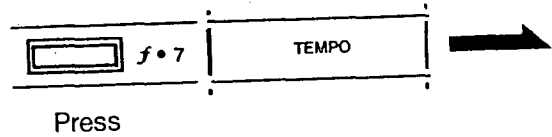
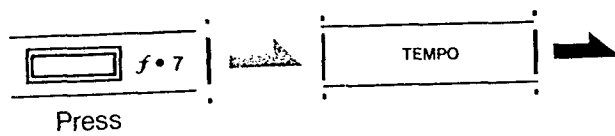
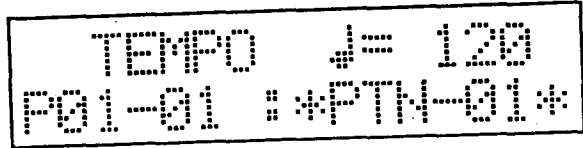
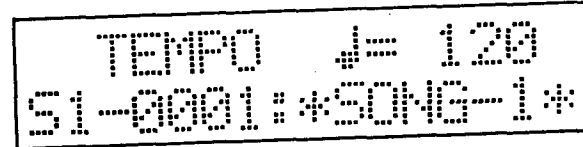
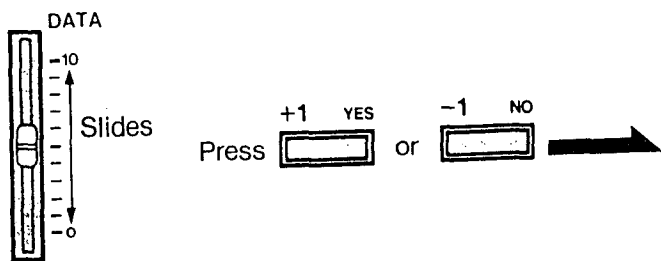
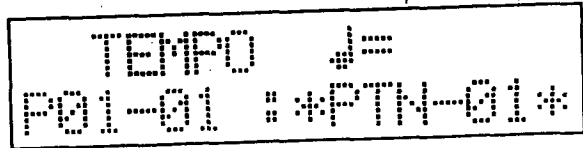
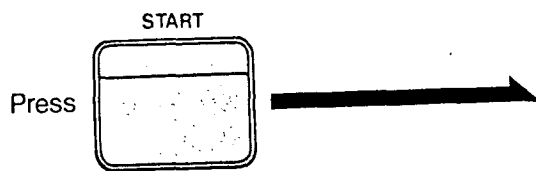
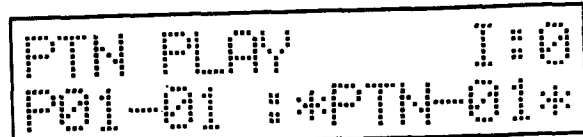
OPERATION	LCD & LED DISPLAY
<p>① If the "f.7" FUNCTION SLECT KEY is pressed in either the PATTERN PLAY/RECORD MODE or the SONG PLAY/EDIT MODE, Tempo can be set for the various modes.</p> <ul style="list-style-type: none"> ● When setting tempo for pattern Playback or Recording; (in the PATTERN PLAY/RECORD MODE)  <p>Press</p> <ul style="list-style-type: none"> ■ When setting tempo for song playback; (in the SONG PLAY/EDIT MODE)  <p>Press</p>	 
<p>② Specify desired tempo via the DATA SLIDER, ten key pad, or +1/YES and -1/NO keys. Setting Range: ♩ = 40 ~ 250</p>  <p>DATA -10 Slides -0</p> <p>Press <input type="button" value="+1 YES"/> or <input type="button" value="-1 NO"/> →</p>	<p>Tempo Changes</p> 
<p>③ This completes tempo setting procedures. When the START KEY is pressed, patterns or songs are played back at the set tempo.</p>  <p>Press <input type="button" value="START"/> →</p>	 <p>Returns to PATTERN SELECT or SONG SELECT display</p>

④ When the FUNCTION Key is pressed during playback, Tempo may be changed during playback by pressing the "f.7" FUNCTION KEY.

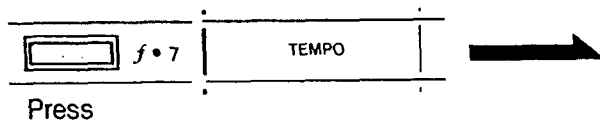

Change tempo by following procedure ②.

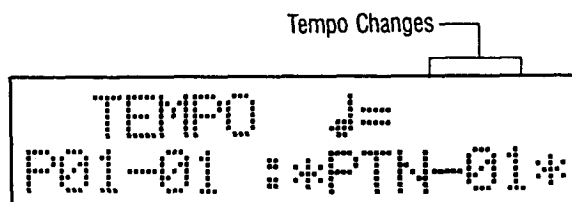

- When the DDD-1 is stopped (RUN LED is out) TEMPO set in the SONG PLAY/EDIT mode is memorized as the Initial Tempo. TEMPO altered during playback or Continue is not memorized as Initial Tempo.

- The initial SONG tempo takes precedence over tempos set for patterns within the song. Tempos set or changed during Pattern Playback are cancelled when the unit is set to the SONG MODE.

■ TAP TEMPO FUNCTION

When the TAP TEMPO KEY is tapped twice, the DDD-1 recognizes this as the speed of one quarter-note beat, and changes the tempo accordingly. Setting via TAP TEMPO can be performed at any time — whether the unit is stopped for engaged in playback.

★ Tempo is reset at $\text{♩} = 40$ or $\text{♩} = 250$ if it is "tapped" out of the $\text{♩} = 40 \sim 250$ range.

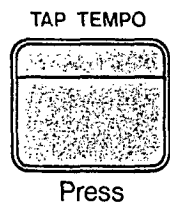

(measure time)

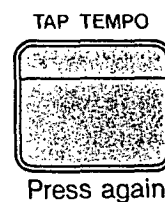

INSTRUMENT SETTING

1. Instrument Setting

Parameters for the 14 INST. KEYS on the front panel of DDD-1, such as Tuning and Assignment, can be freely set according to the needs of each song, making PATTERN Recording speedy and convenient. Also, 6 different settings can be kept in memory.

■ SETTING SELECT

This function is used to select the 6 inst Settings. Only one set of settings is put into memory for each SONG, so it's necessary to choose settings which will be used for the entire SONG when writing its PATTERNS.

■ TOUCH SENS

The DDD-1 features TOUCH SENSITIVITY, whereby sound volume is determined via the strength at which keys are tapped. TOUCH SENSITIVITY can be set individually for each INST KEY, and any of 10 different levels of volume change are possible — from 0 to 9.

DYNAMIC

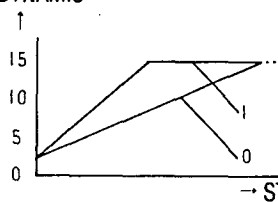

Sound source sounds when keys are topped even lightly, when TOUCH SENS is set to "0" or "1".

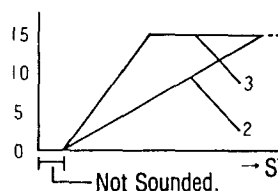

Sound source does not sound when keys are tapped lightly, when TOUCH SENS is set to "2" or "3".

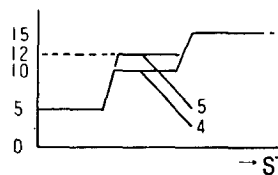

3-level sound variation is achieved with TOUCH SENS set to "4" or "5".

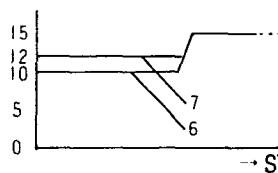

2-level sound variation is achieved with TOUCH SENS set to "6" or "7".

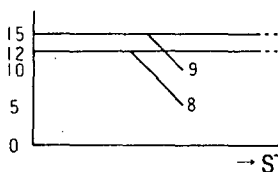

Fixed sound level is achieved with TOUCH SENS set to "8" or "9".

■ TOTAL TUNE

Tuning of each sound source is possible throughout a 128-step, 1-octave range (step 000 — 127). (1 step is equal to a change of approximately 9.45 cents.) Values set via TOTAL TUNE are related to SEQ TUNE used in PATTERN RECORDING.

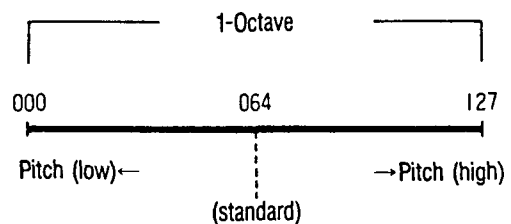

- ★ Of the built-in sound sources, CRASH, RIDE, OPEN HI-HAT, CLOSE HI-HAT, TAMBOURINE and CABASA have a standard pitch of "000". The qualities of these sounds are changed easily by alterations in pitch, so care should be taken when making settings.

■ TOTAL DECAY

The length of each sound can be set throughout a 16-step (00 ~ 15) range. Values set via TOTAL DECAY are related to SEQ DECAY used in PATTERN RECORDING.

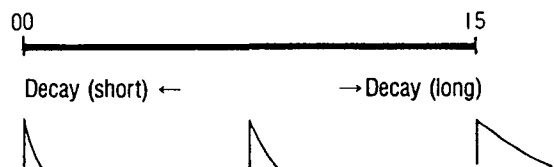

■ OUTPUT LEVEL

While each INST. KEY features TOUCH SENSITIVITY, the OUTPUT level sets the maximum volume which each instrument produces when its INST. KEY is tapped at "full" strength. This can be set through a 16-step (00 ~ 15) range. If the OUTPUT LEVEL is set at "00" then no sound is produced. Values set via OUTPUT LEVEL are related to SEQ DYNAMICS used in PATTERN RECORDING.

(EX.)

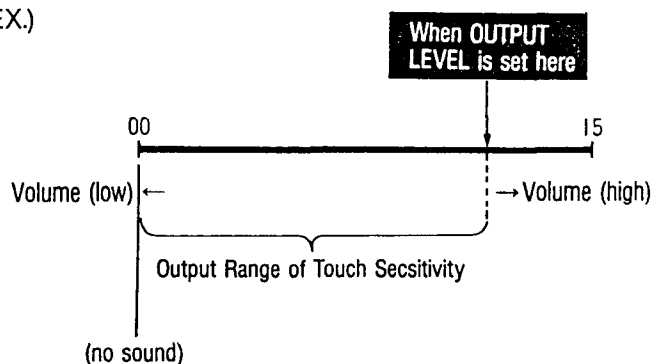

INSTRUMENT SETTING

■ OUTPUT ASSIGN

As shown on the diagram, 7-point panning of sound sources is possible when using the L and R/MONO output jacks. Also, the OUTPUT ASSIGN function allows you to assign any of the 6 Multi-Output jacks to any sound source. Multiple instruments can be output through a single jack, so instruments requiring the same effect processing can be run together.

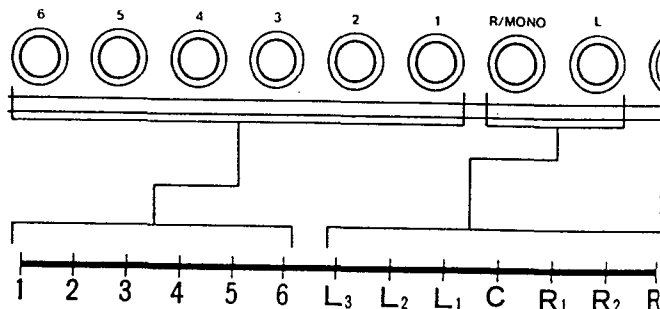

■ INST ASSIGN

Both Key Assign and Assign Modes are set via the INST ASSIGN function.

● Key Assign

In this mode, built-in sound sources, ROM card sound sources and sounds sources created via sampling can be freely assigned to the 14 inst. keys on the front panel.

For example you may specify the same sound source for a number of INST keys and slightly change the TUNING, DECAY, OUTPUT ASSIGN, etc. This allows the creation of Melody Torns or a full drum set effect.

(EX.) Setting to use TOMs as melody TOMs

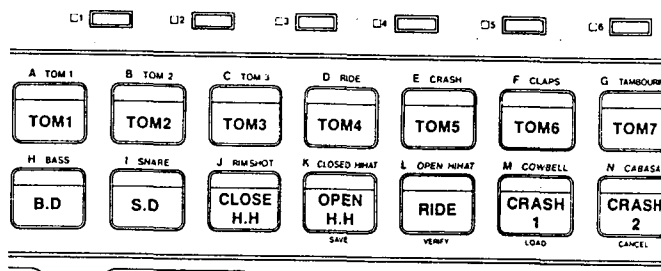

(EX.) Setting for actual drum set sound

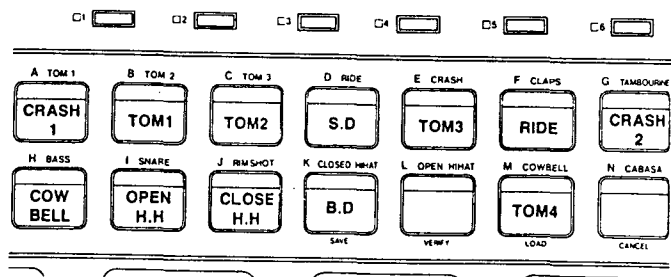

● ASSIGN MODE

The DDD-1, is capable of outputting up to 12 sounds simultaneously. The ASSIGN MODE is used to determine how these 12 sounds are used. It contains 3 sub-modes — POLY, MONO and EXCLUSIVE.

POLY:

In the POLY MODE, inst. sound source are "layered". In other words, no matter how many times inst. keys are tapped, each sound is sounded until complete decay, without being cut off. 1

For example, when programming relatively "long" sounds such as cymbals, it is necessary to allow the sounds to build up, to avoid an unnatural sound. The POLY function is perfect for these "layering" effects. Also, when using this mode with other sound source, flanger or chorus effects can be obtained by the same sound source twice in a very quick time interval.

(POLY MODE)

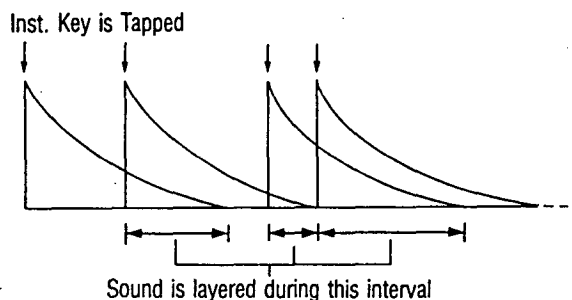

MONO:

When inst. keys are tapped in the MONO MODE, the previous sound is cut-off at that point, before full decay. This mode is used when the layered effect as in the POLY MODE is not necessary.

(MONO MODE)

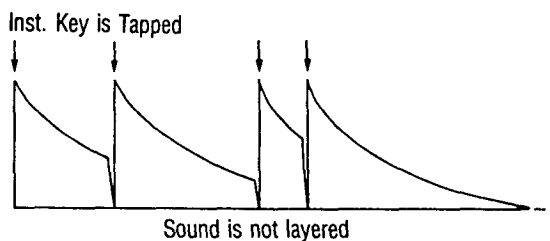

EXCLUSIVE:

Instruments which should not be sounded at the same time, such as OPEN HI-HAT and CLOSED HI-HAT, should be set to this mode. It also responds to CONGA sounds (mute, slap) etc. when using a ROM card.

(EXCLUSIVE MODE)

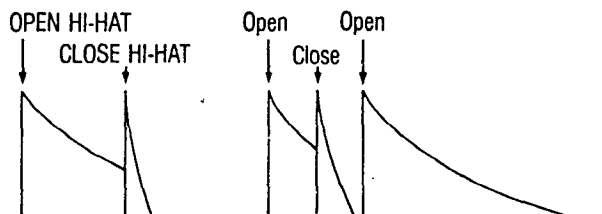

INSTRUMENT SETTING

(ABOUT VOICE NUMBER & ASSIGN MODE DISPLAYS)

The DDD-1 allows total freedom in choosing sound sources — such as the built-in sound sources, ROM card sound sources, or sound sources created via sampling. Each sound source has a VOICE NUMBER, which is displayed when changing sound source via Instrument Assign. The first letter in the VOICE NUMBER identifies the sound source, either the Internal sound sources, ROM card, or Sampling.

INTERNAL

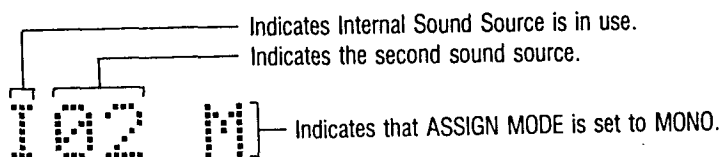

ROM CARD

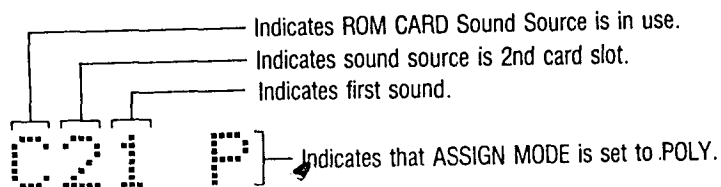

SAMPLING

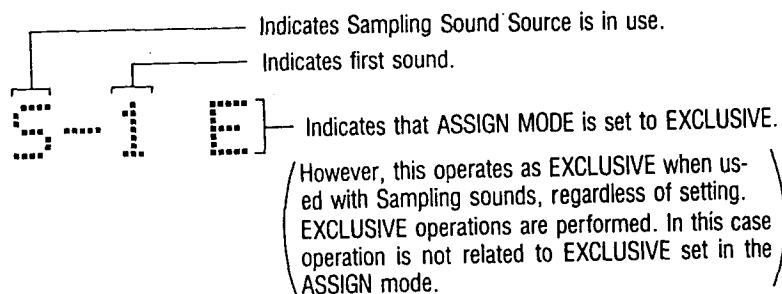

DD-1 INTERNAL VOICES



Voice Number	Sound Source	
I 01	TOM 1	HI TOM
I 02	TOM 2	MIDDLE TOM
I 03	TOM 3	LOW TOM
I 04	RIDE	RIDE CYMBAL
I 05	CRASH	CRASH CYMBAL
I 06	CLAPS	HAND CLAPS
I 07	TAMBOURINE	TAMBOURINE
I 08	BASS 1	BASS DRUM (HARD)
I 09	BASS 2	BASS DRUM (SOFT)
I 10	SNARE 1	SNARE DRUM
I 11	SNARE 2	SNARE DRUM (GATE SNARE)
I 12	RIM SHOT	RIM SHOT
I 13	CLOSED HIHAT 1	CLOSED HI-HAT
I 14	CLOSED HIHAT 2	CLOSED HI-HAT (HEAVY)
I 15	OPEN HIHAT 1	OPEN HI-HAT
I 16	OPEN HIHAT 2	OPEN HI-HAT (HEAVY)
I 17	COWBELL	COWBELL
I 18	CABASA	CABASA

2. Instrument Setting (Actual Operation)



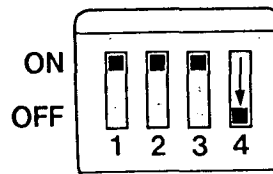

NOTE:

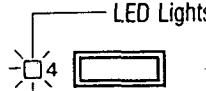
For the following operations, DIP Switch number 4 "PROTECT" on the rear panel should be set to OFF.

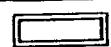

OPERATION	LCD & LED DISPLAY
<p>Specify INSTRUMENT SETTING, by pressing MODE SELECT KEY "4"</p> <p>Press <input type="checkbox"/> 4  </p>	 <p>LED Lights</p>

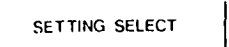
1 SETTING SELECT

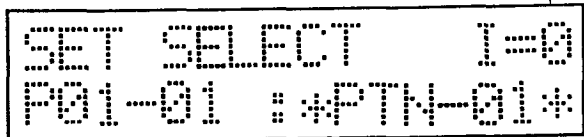
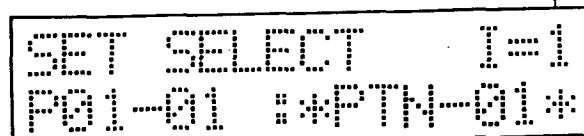
<p>① Specify SETTING SELECT, by pressing FUNCTION SELECT KEY "f.1".</p> <p> f.1   SETTING SELECT </p> <p>Press</p> <p>(Set to "SETTING SELECT" as soon as the INST SETTING mode is specified.)</p>	<p>Present Inst Setting</p>  <p>Pattern Number which may be played back</p>
<p>② When a SETTING NUMBER is specified via the ten key pad or + 1/YES and - NO keys, the specified inst setting is called out, and alterations can be made.</p>	<p>Setting Number Changes</p> 

● The START KEY is pressed at this point, the PATTERN is played back at the selected inst Setting.

SETTING TOUCH SENSITIVITY

① Specify TOUCH SENS, by pressing FUNCTION SELEC KEY "f.2".

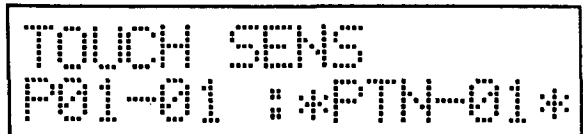

② Press the INST. KEY for which TOUCH SENS is to be set.
(In this case, for Inst. Key "A").

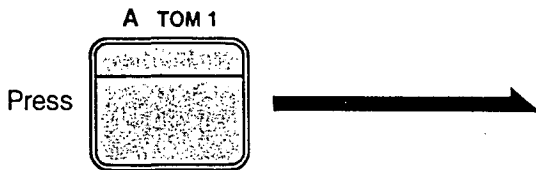

Present TOUCH SENS is displayed

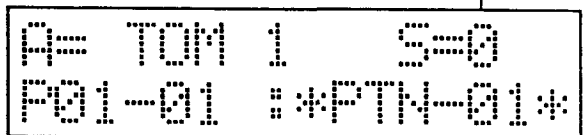

③ Raise or lower Touch Sensitivity via the +1/YES and -1/NO keys.

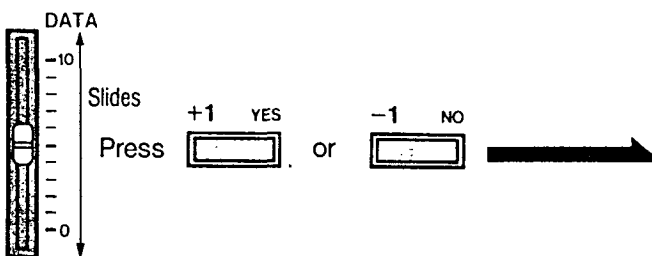

TOUCH SENS Changes

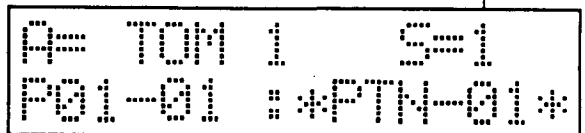

Repeat steps ② and ③ to set TOTAL DECAY for other Inst. Keys.

INSTRUMENT SETTING

③ SETTING TOTAL TUNE

- ① Specify TOTAL TUNE, by pressing FUNCTION SELECT KEY "f.3".

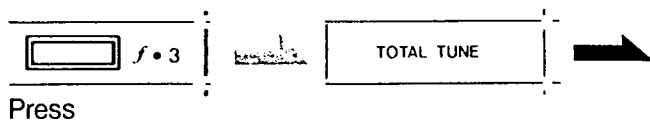

```
TOTAL TUNE
P01-01 : *PTN-01*
```

- ② Press the INST. KEY for which TOTAL TUNE is to be set.
(In thi case, for Inst. Key "B")

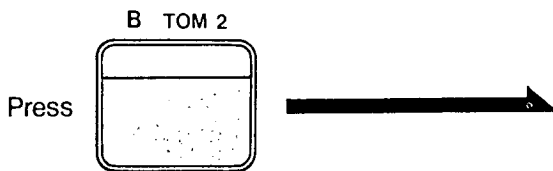

```
B= TOM 2   T=064
P01-01 : *PTN-01*
```

- ③ Adjust TOTAL TUNE via the DATA SLIDER or the +1/YES and -1/NO keys.

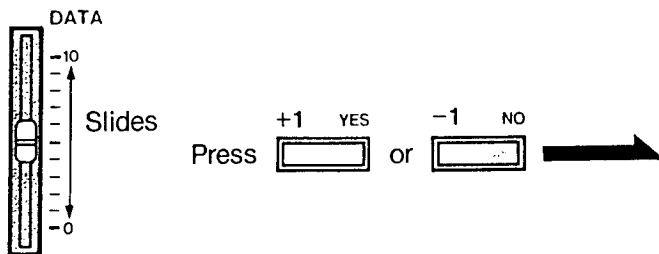

Tuning Value Changes

```
B= TOM 2   T=
P01-01 : *PTN-01*
```

Repeat steps ② and ③ to set TOTAL TUNE for other Inst. Keys.

4 SETTING TOTAL DECAY

① Specify TOTAL DECAY, by pressing FUNCTION SELECT "f.4".

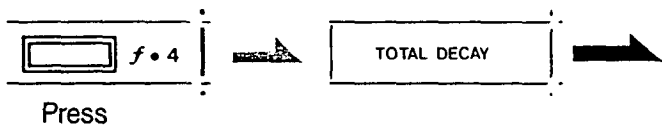

TOTAL DECAY
P01-01 : *PTN-01*

② Press the INST. KEY for which TOTAL DECAY is to be set.
(In this case, for Inst. Key "C")

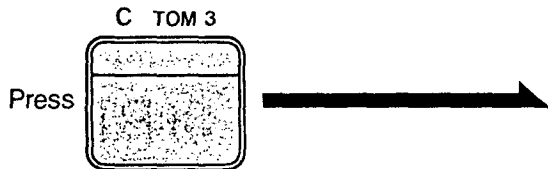

C= TOM 3 D=15
P01-01 : *PTN-01*

③ Adjust TOTAL DECAY via the DATA SLIDER or the +1/YES and -1/NO keys.

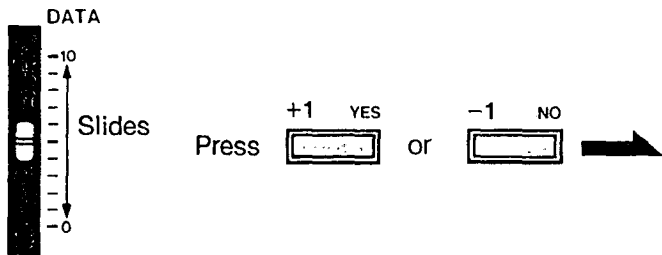

Decay Value Changes

C= TOM 3 D=
P01-01 : *PTN-01*

Repeat steps ② and ③ to set TOUCH SENS for other Inst. Keys.

INSTRUMENT SETTING

5 SETTING OUTPUT LEVEL

- ① Specify OUTPUT LEVEL, by pressing FUNCTION SELECT KEY "f.5".

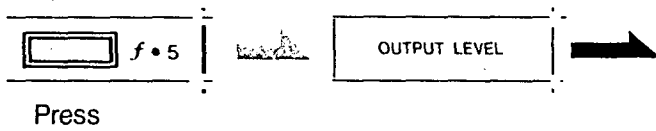

```

OUTPUT LEVEL
P01-01  : *PTN-01*
    
```

- ② Press the INST. KEY for which OUTPUT LEVEL is to be set.
(In this case, for Inst. Key "D").

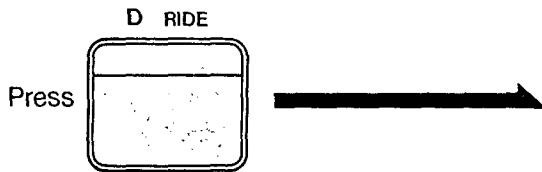

```

D= RIDE    L=15
P01-01  : *PTN-01*
    
```

- ③ Adjust OUTPUT LEVEL via the DATA SLIDER or the +1/YES and -1/NO keys.

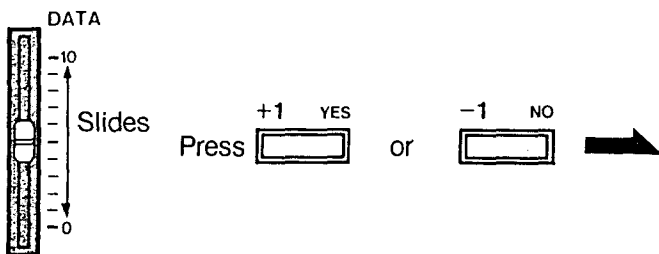

OUTPUT LEVEL Changes

```

D= RIDE    L=
P01-01  : *PTN-01*
    
```

Repeat procedures ②&③ to set OUTPUT LEVEL for each Inst. key.

⑥ SETTING OUTPUT ASSIGN

① Specify OUTPUT ASSIGN, by pressing FUNCTION SELECT KEY "f.6".

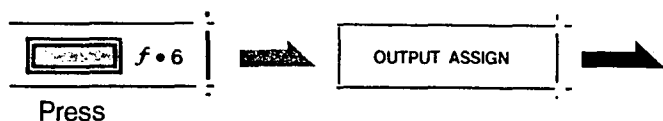

OUTPUT ASSIGN
P01-01 : *PTN-01*

② Press the INST. KEY for which OUTPUT ASSIGN is to be set.
(In this case, for Inst. Key "E")

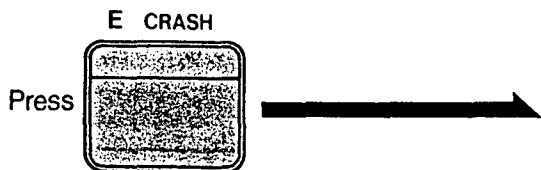

E= CRASH O=R3
P01-01 : *PTN-01*

③ Select the desired Output Jack via the DATA SLIDER or the +1/YES and -1/NO keys.

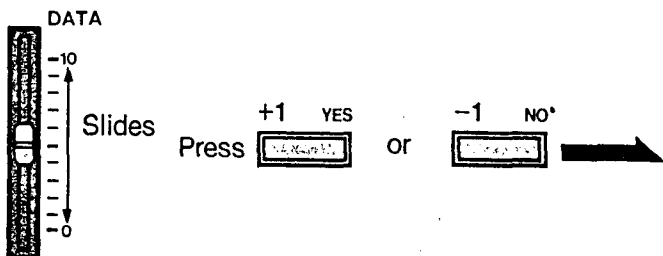

Output Changes

E= CRASH O=R3
P01-01 : *PTN-01*

(L.R/MONO) R₃ ↔ R₂ ↔ R₁ ↔ C ↔ L₁ ↔ L₂ ↔ L₃
(Multi-Output) 1 ↔ 2 ↔ 3 ↔ 4 ↔ 5 ↔ 6

Changes in this pattern:

Repeat steps ② and ③ to set OUTPUT JACK for each Inst. Keys.

INSTRUMENT SETTING

7 SETTING INST ASSIGN

① Specify INST ASSIGN, by pressing FUNCTION SELECT KEY "f.7".



```

INST ASSIGN
P01-01 : *PTN-01*
    
```

② Press the INST. KEY for which Inst. Sound is to be assigned.
(In this case, for Inst. Key "F")

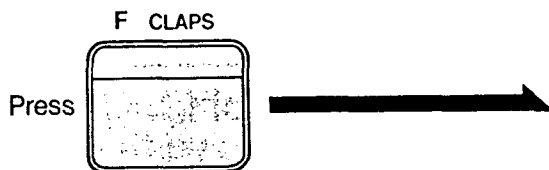

Instrument Key Instrument Name	Voice Number Assign Mode
F= CLAPS	106 M
P01-01 : *PTN-01*	

③ Select the desired Instrument Sound via the DATA SLIDER or the +1/YES and -1/NO keys.

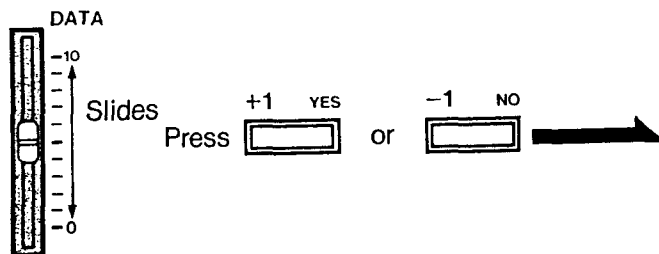

Sound Source, Voice Number and ASSIGN MODE change

```

F=
P01-01 : *PTN-01*
    
```

When the keys are pressed, Instrument Sounds change in the pattern shown below:



- When inserting or removing ROM cards after power is turned ON, perform the ROM card check described on page 130. ROM card contents are displayed in the ROM Card Area when the DDD-1 recognizes a ROM card.

④ Move the CURSOR to the ASSIGN MODE display position on the LCD.



```
F= CLAPS  106 N
P01-01  :*PTN-01*
```

⑤ Pressing the +1/YES or -1/NO keys changes the mode to POLY, MONO or EXCLUSIVE.

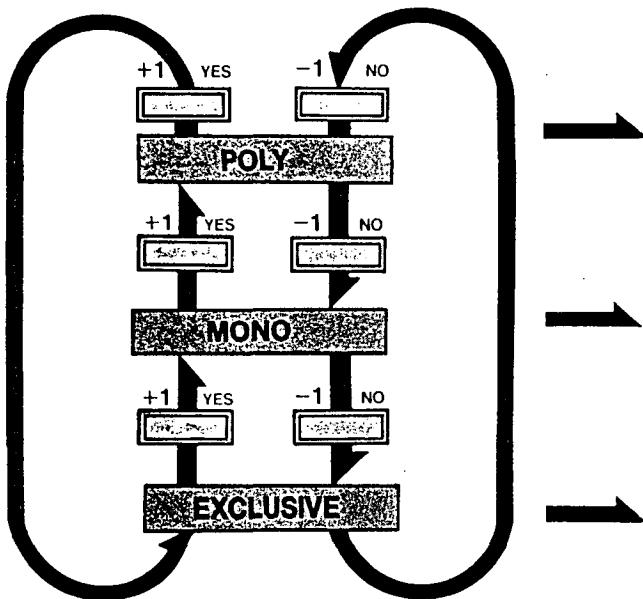

```
F= CLAPS  106 E
P01-01  :*PTN-01*
```

```
F= CLAPS  106 N
P01-01  :*PTN-01*
```

```
F= CLAPS  106 E
P01-01  :*PTN-01*
```

Repeat steps ② through ⑤ to set Sound Sources for other Inst. Keys.

NOTE:

TOUCH SENS, TUNING, DECAY, OUTPUT LEVEL and OUTPUT ASSIGN are set for each Inst. Key. Therefore, these settings affect sound source chosen for individual keys via INST ASSIGN.

HOW TO RECORD PATTERNS

1. Recording Patterns

The following procedures describe how to create PATTERNS — the basic elements which make up SONGS. There are two different recording methods — Real Time Recording and Step Recording. Patterns are made using either one, or both of these recording methods.

- **Real Time Recording**

When recording with Real Time Recording, you listen to the DDD-1 metronome sound, and record patterns, tapping the Instrument Keys as you would play a drum kit.

- **Step Recording**

When recording via Step Recording, you program patterns one step at a time through key operation. The DDD-1 features the following functions which relate to PATTERNS.

- **TIME SIGNATURE**

This parameter sets the meter. One meter setting is possible for each PATTERN, so multiple rhythms can be written in SONGS. The chart shown at the right illustrates the range wherein meter may be set.

$\frac{1}{4}$	~	$\frac{8}{4}$
$\frac{1}{8}$	~	$\frac{16}{8}$
$\frac{1}{16}$	~	$\frac{32}{16}$
$\frac{1}{32}$	~	$\frac{64}{32}$

■ NUMBER OF BARS

This is set according to the number of measures contained in a single PATTERN. As shown below, when a phrase cannot be written as a single measure in the selected Time Signature, the NUMBER OF BARS can be set higher between 1 and 99. Measures can be altered, even though PATTERNS have already been written. Measures are added or deleted as shown at the right.

(EX.) 2 Measure Pattern extended to 4

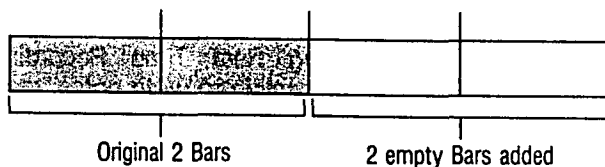

2 Measure Pattern shortened to 1

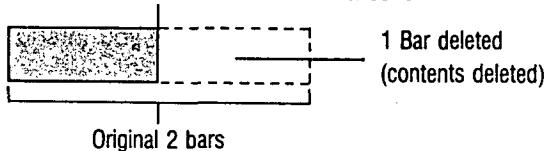

(EX.) Examples of a 1-measure Pattern and a 2-measure Pattern.

Snare

Bass Drum

$\frac{4}{4}$ 1-measure Pattern

Snare

Bass Drum

$\frac{4}{4}$ 2-measure Pattern
or
 $\frac{8}{4}$ 1-measure Pattern

HOW TO RECORD PATTERNS

RESOLUTION

When writing rhythms with the DDD-1, it is necessary to set resolution. This is the value of the smallest note in a PATTERN. Setting the resolution low cuts down on operations when doing Step Recording, allows correction during Real Time Recording, however it becomes impossible to write notes, rests or ties of a higher degree of fineness (resolution). For example, when writing basic 8-beat rhythm, $\frac{1}{8}$ is selected. The finest note which can be written is — an eight note.

On the DDD-1, you have a choice of 9 resolution settings, from $\frac{1}{4}$ (low) to $\frac{1}{32}$ (high). Your choice will depend on the complexity of the rhythm you intend to write.

The relationship between resolution and the finest note in a beat is illustrated in the chart below:

★ A "T" mark indicates resolution including a triplet —
EX: $\frac{1}{4}$ T

(RESOLUTION)

1 Beat 2 Beat 3 Beat 4 Beat 5 Beat 6 Beat 7 Beat 8 Beat

$\frac{1}{4}$

$\frac{1}{4}$ T

$\frac{1}{8}$

$\frac{1}{8}$ T

$\frac{1}{16}$

$\frac{1}{16}$ T

$\frac{1}{32}$

$\frac{1}{32}$ T

HIGH ($\frac{1}{32}$)

► About Real Time Recording Resolution (Correction Function)

When recording in Real Time with a fine resolution setting, it sometimes becomes difficult to play in exact sequence with the metronome, causing time lags. In such cases, setting resolution to a coarser level in advance causes automatic correction of this timing.

(EX.) Resolution set to $\frac{1}{8}$

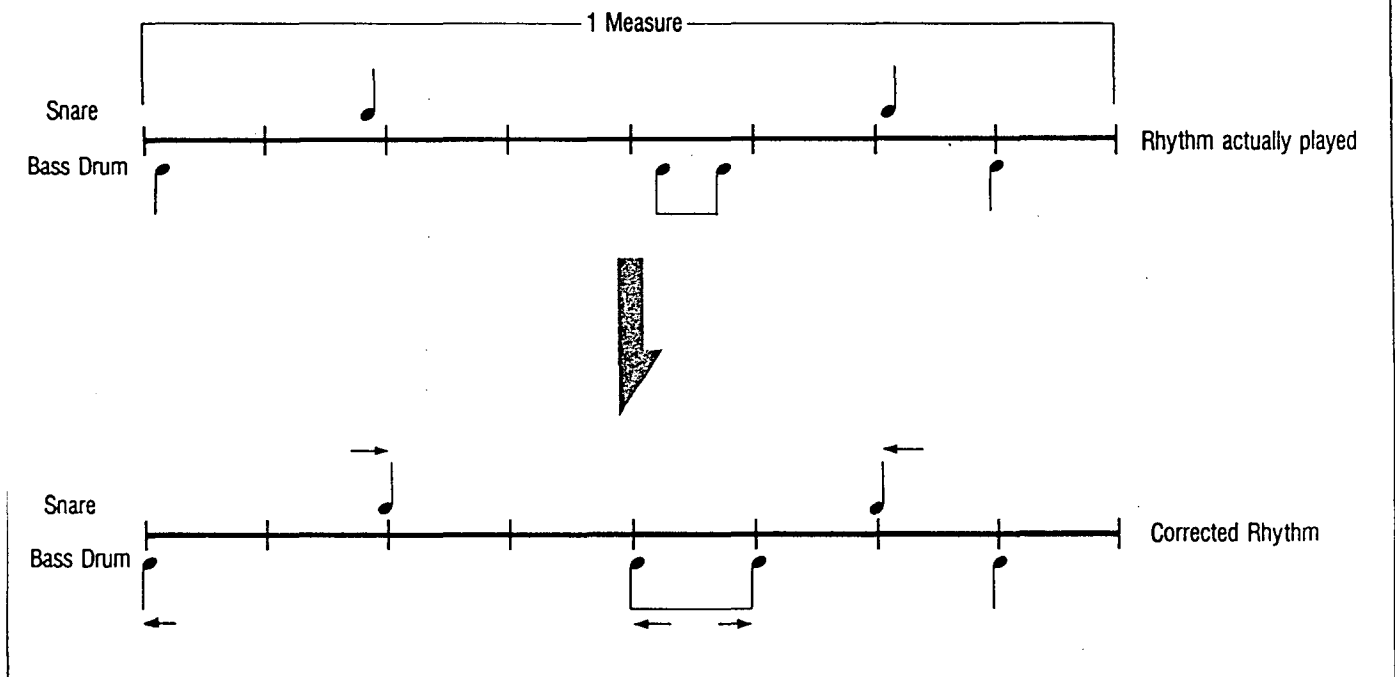

★ Resolution may be changed when the DDD-1 is stopped, so various resolutions may be utilized in a single PATTERN.

HOW TO RECORD PATTERNS

■ ROLL/FLAM

● ROLL

This function sets the ROLL effect obtained when the ROLL KEY on the front panel is pressed. This sets ROLL RESOLUTION, or in other words the number of Roll strokes per beat.

This resolution may be set at any of the 8 setting levels; $\frac{1}{4}$, $\frac{1}{4}T$, $\frac{1}{8}$, $\frac{1}{8}T$, $\frac{1}{16}$, $\frac{1}{16}T$, $\frac{1}{32}$, $\frac{1}{32}T$.

Depressed Instrument Keys are rolled as long as the ROLL KEY is held down according to the preset ROLL RESOLUTION.

● FLAM

This function sets the FLAM effect obtained when the FLAM KEY on the front panel is pressed. This sets the timing between sounding of the first and second sound in a FLAM. Timing is set between 0 and 9, in increments of 10msec. Separate values may be set for each pattern.

NOTE:

ROLL RESOLUTION cannot be set finer than RESOLUTION, for any given phrase. FLAM RESOLUTION is not related to RESOLUTION, and may be set at any point within the 0 — 9 range.

Flam writing is possible.

(EX.) ROLL Resolution set at $\frac{1}{16}$

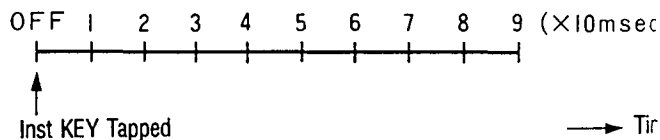
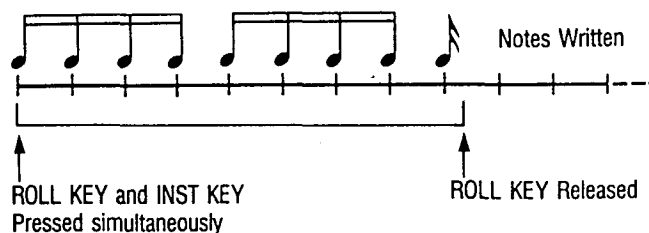

SEQ PARAMETERS

These three parameters allow playback while changing TOTAL TUNE, TOTAL DECAY and OUTPUT LEVEL set at INST SETTING.

SEQ TUNE

This parameter allows alteration of the TOTAL TUNE setting (p.30).

This can be made at the playback stage, after songs are written. In other words, even though a certain instrument sound has been assigned to an Instrument Key, this sound can be altered by changing its pitch.

The degree of change available via SEQ TUNE depends on the value which TOTAL TUNE is set at initially. This can be set in 100-cent, 1-step increments, within a range of ± 12 steps. However, pitches which exceed the TOTAL TUNE range are not sounded. The relationship between TOTAL TUNE and SEQ TUNE is shown below:

(EX.)

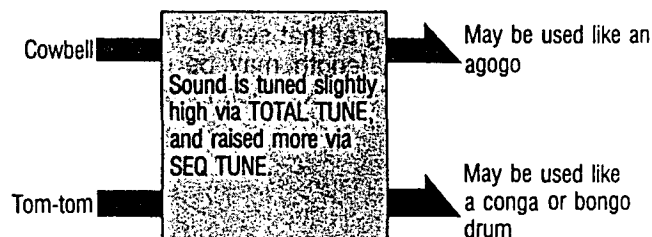

(EX.) SEQ TUNE

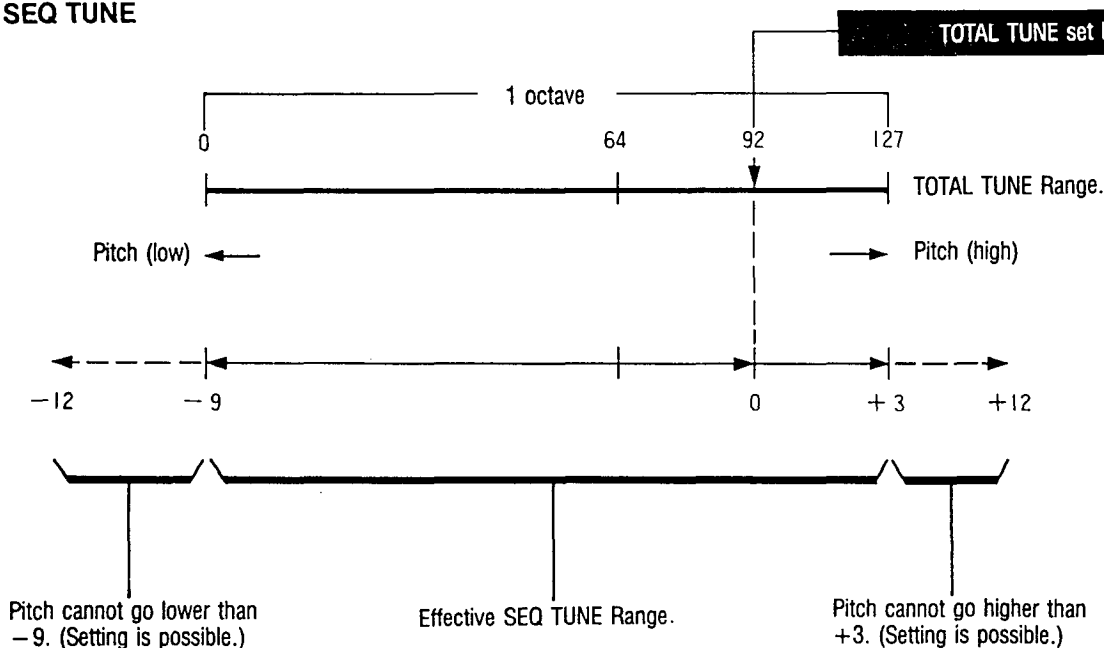

★ When the optional Sampling Board is used, Sampled sounds may be set throughout a 2-octave, 128-step range.

HOW TO RECORD PATTERNS

● SEQ DECAY

This parameter allows alteration the length of each sound set via TOTAL DECAY (p. 31), with the maximum value remaining at that set via TOTAL DECAY. In other words, this length may be changed even though it is already "set", for each Instrument key.

(EX)

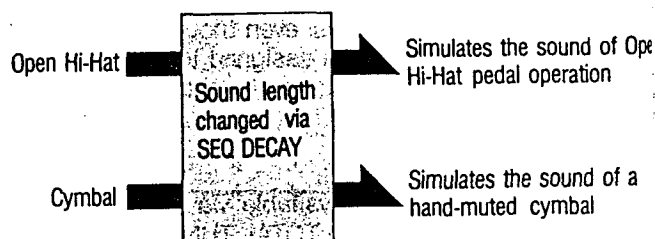

Both TOTAL DECAY and SEQ DECAY have 16-step setting ranges (0~15), which are interrelated as shown below:

(EX.) SEQ DECAY

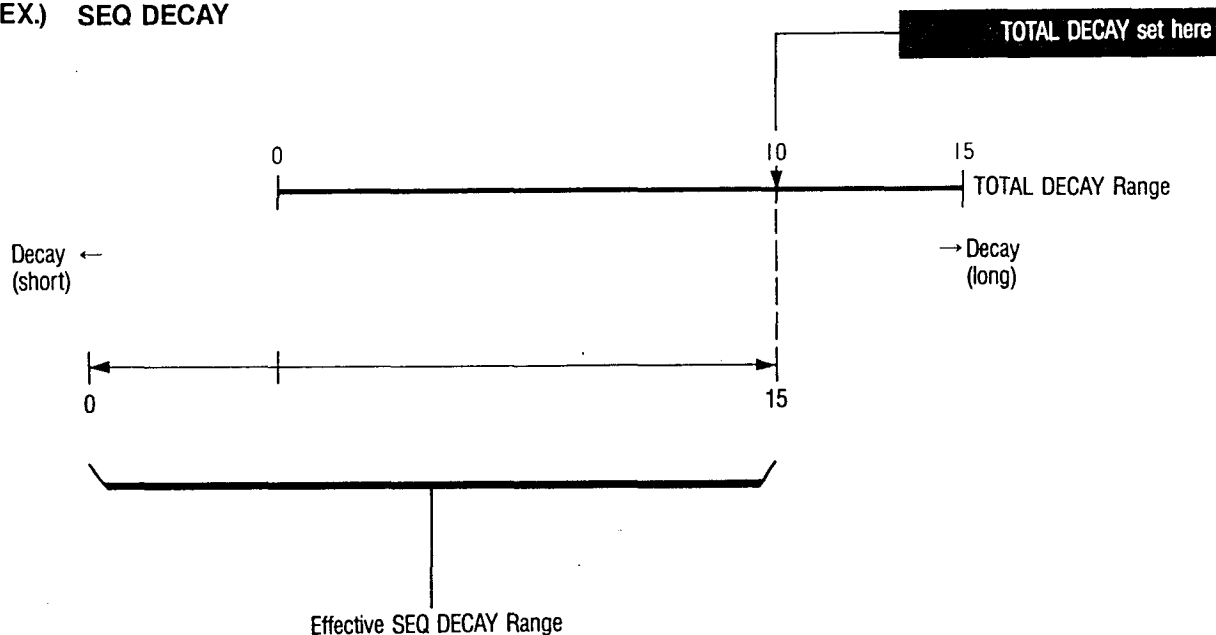

NOTE:

"Short sounds such as rim shots or closed hi-hat sounds cannot be shortened by SEQ DECAY over a certain point.

SEQ DYNAMICS

This parameter allows alteration of the maximum volume which each Instrument Key produces when tapped at "full" strength, with the value set at OUTPUT LEVEL (p. 32) remaining the maximum value. Dynamics are registered in the DDD-1 memory when patterns are written however this parameter always editing of thing dynamics.

Both OUTPUT LEVEL and SEQ DYNAMICS have 16-step setting ranges (0~15), which are interrelated as shown below:

(EX.) SEQ DYNAMICS

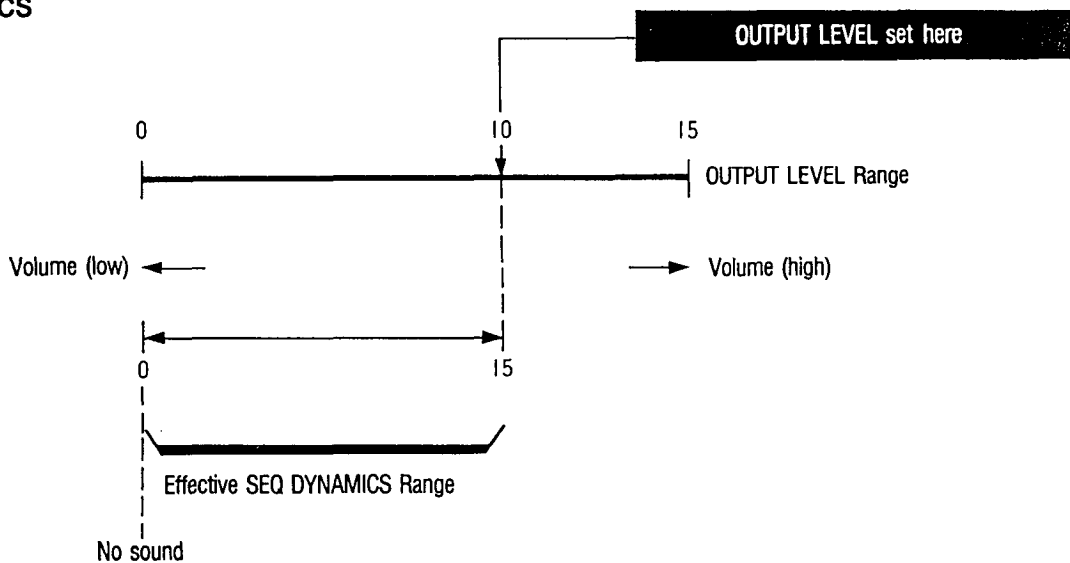

Mute Function:

Sound source sound can be stopped when Sequence Dynamics are set to "0", This allows "MUTED" playback of corfoin serinds during recending. This can be used to cut off sound cleanly, when langer sounds such as cymbals care written in program.

HOW TO RECORD PATTERNS

■ TEMPO

Refer to page 20.— SETTING/CHANGING TEMPING

■ ERASE

This function allows you to erase incorrect or unnecessary instrument sounds. There are three different ways to erase; a) Erasure of a specified instrument for the entire song, b) Erasure of a specified section of an instrument's program, or c) Erasure of a single beat for a specified instrument.

(Examples of ERASE)

Erasure of the entire Bass Drum track (playback stopped)

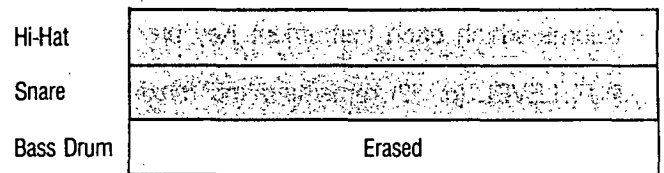

Erasure of an unnecessary section of the Bass Drum track (Erased during Real Time recording)

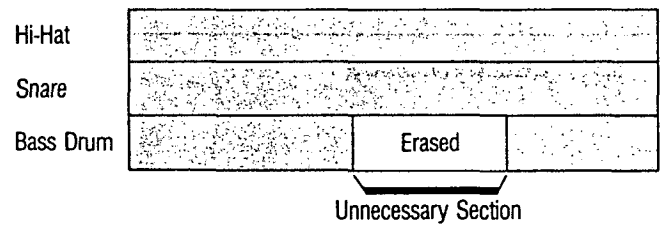

Erasure of an unnecessary beat in the Bass Drum track (Erased during Step recording)

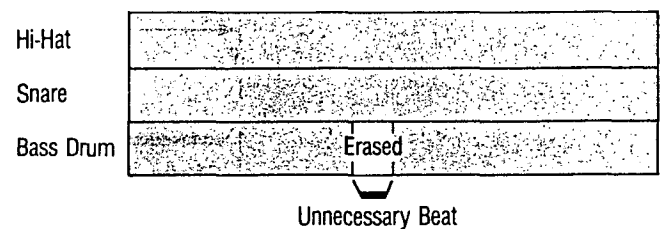

2. Pattern Recording Operations

The following describes actual operations used in recording PATTERNS.

NOTE:

DIP Switch number 4 on the rear panel should be set to OFF when performing actual Pattern Recording, Sequence Parameter Recording, Erase, and Pattern Editing.

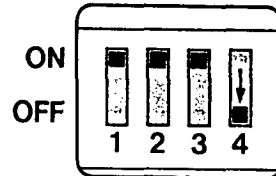

OPERATION	LCD & LED DISPLAY
<p>① Specify PATTERN RECORDING, by pressing MODE SELECT KEY "1" PATTERN PLAY/RECORD MODE.</p> <p>Press →</p>	<p>LED Lights </p>
<p>② Specify PATTERN SELECT, by pressing FUNCTION SELECT KEY "f.1".</p> <p> f.1 PATTERN SELECT →</p> <p>Press</p> <p>(Set at PATTERN SELECT when PATTERN PLAY/RECORD MODE is specified.)</p>	<p>Inst Setting</p> <p></p> <p>Pattern Number Bar Number Pattern Name</p>
<p>③ Select the PATTERN Number which you are going to use; via the ten key pad or the +1/YES and -1/NO keys.</p> <p>(There are no demonstration patterns contained in PATTERN Numbers -00,51 through 99. Use any of these numbers. When you wish to use a Pattern Number which already contains data, perform PATTERN CLEAR operations, described on page 73, after preserving data on a RAM card or via tape interface.)</p>	

HOW TO RECORD PATTERNS

1 SETTING TIME SIGNATURE

① Specify TIME SIGNATURE, by pressing FUNCTION SELECT KEY "f.2".

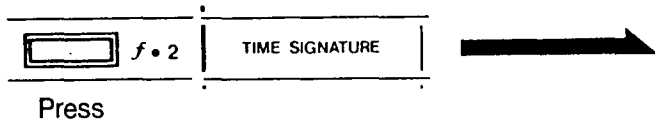

NOTE:
If a PATTERN has already been written, the CURSOR is not displayed, so changing meter is impossible.
Meter is displayed in this way;



Meter Displayed

For 3/4 Meter — 03/4
For 12/8 Meter — 12/8

② Specify the numerator (beats per measure) via ten key pad or +1/YES and -1/no keys.

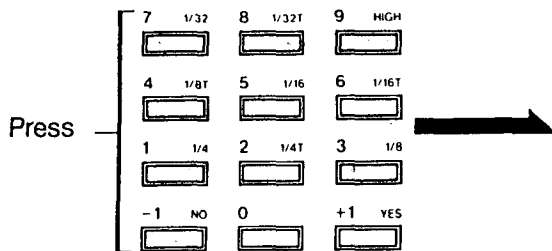

(Input of numerator is possible when unit is set to TIME SIGNATURE.)

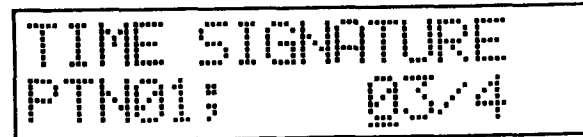

Numerator Changes



- ③ Move the CURSOR to the denominator side by pressing the CURSOR KEY.

Press  

TIME SIGNATURE
PTN01: 03/4

Cursor Moves

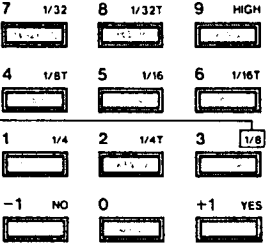
- ④ Specify the denominator via the ten key pad or +1/YES and -1/NO keys.

Press  

(Select according to marks at upper right of keys)



7	1/32	8	1/32T	9	HIGH
4	1/8T	5	1/16	6	1/16T
1	1/4	2	1/4T	3	1/8
-1	NO	0		+1	YES

TIME SIGNATURE
PTN01: 03/8

Denominator Changes

② SETTING NUMBER OF BARS

- ① Specify NUMBER OF BARS, by pressing FUNCTION SELECT KEY "f.3".

 f.3 NUMBER OF BARS 

Press

NUMBER OF BARS
PTN01: BAR02

NUMBER OF BARS
already written is
displayed

- ★ It is possible to change the number of bars which have already been written.

HOW TO RECORD PATTERNS

② Specify the NUMBER OF BARS via the ten key pad or +1/YES and -1/NO keys.

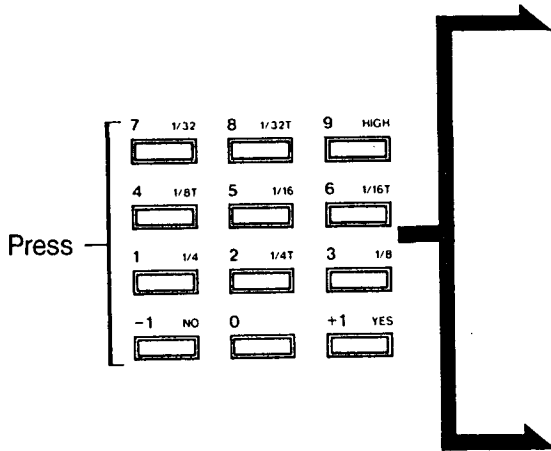

Increasing Number of Bars.

```

NUMBER OF BARS
PTN01:  BAR04
    
```

Bars are added and display appears as shown above.

Decreasing Number of Bars.

```

          Sure(Y/N)?
PTN01:  BAR01
    
```

Display is as shown - complete procedure ③.

③ Replay to the "Sure?" inquiry by pressing the YES (+1/YES) key or NO (-1/NO) key.



```

NUMBER OF BARS
PTN01:  BAR01
    
```

Deletion of Bars carried out.

```

NUMBER OF BARS
PTN01:  BAR04
    
```

Deletion command cancelled, display returns to ①.

③ SETTING RESOLUTION

① Specify RESOLUTION, by pressing FUNCTION SELECT KEY "f.4".

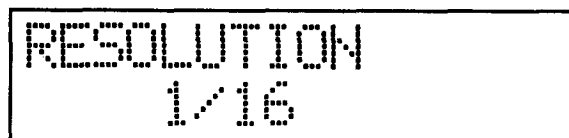
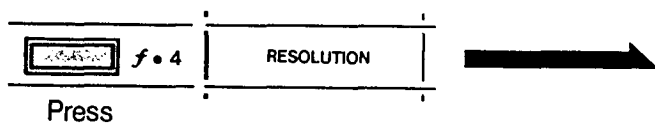

Present Resolution displayed

② Set RESOLUTION via the ten key pad or +1/YES and -1/NO keys.

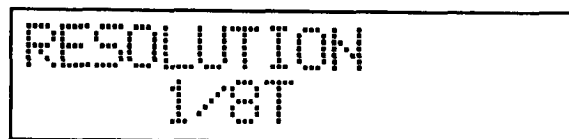
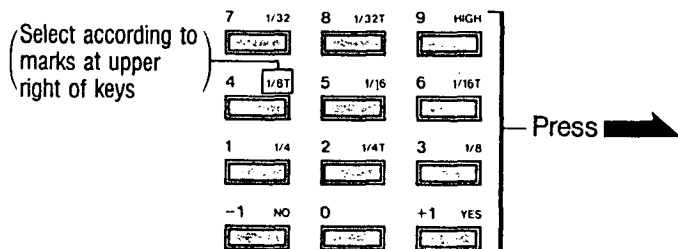

Resolution Changes

HOW TO RECORD PATTERNS

4 SETTING ROLL/FLAM

① Specify ROLL/FLAM, by pressing FUNCTION SELECT KEY "f.5".

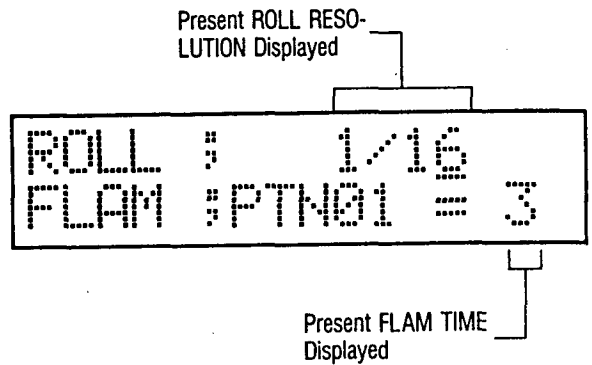
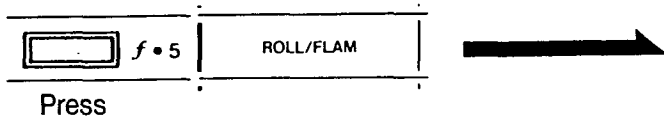

② Set ROLL RESOLUTION via the ten key pad or +1/YES and -1/NO keys.

(Setting of ROLL RESOLUTION is possible when unit is set to ROLL/FLAM.)

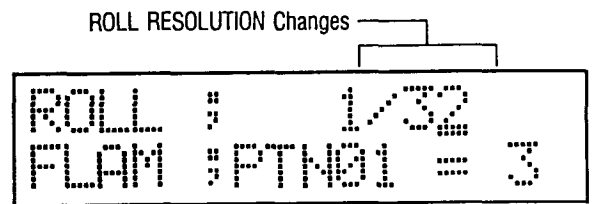

③ Next, set the FLAM time. Move the CURSOR by pressing the CURSOR KEY.

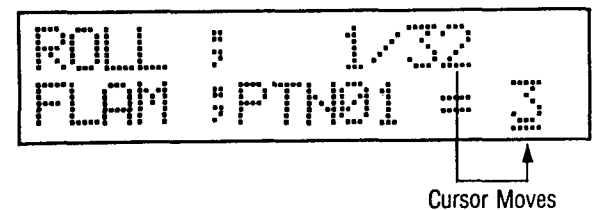

④ Set FLAM TIME via the ten key pad or +1/YES and -1/NO keys.

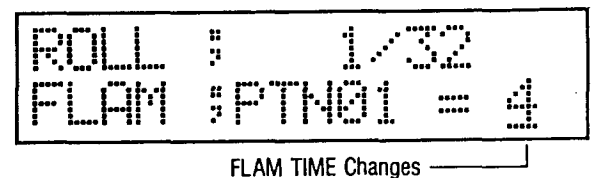
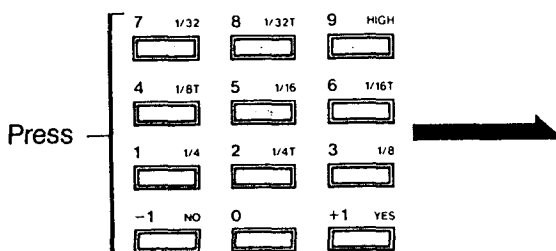

3. Real Time Recording

This recording method allows you to tap out patterns in time with the DDD-1 metronome sound, much like you would play a drum kit.

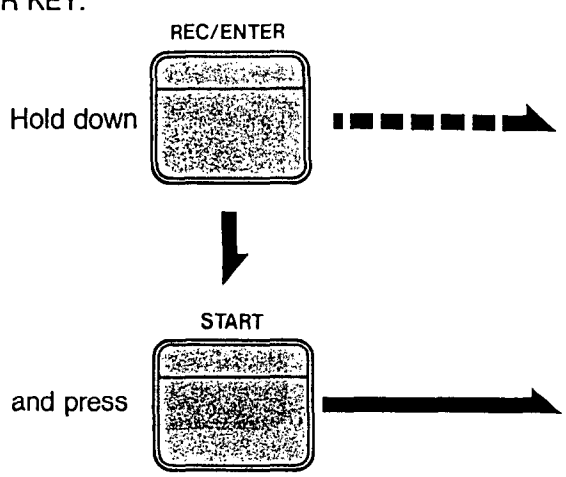
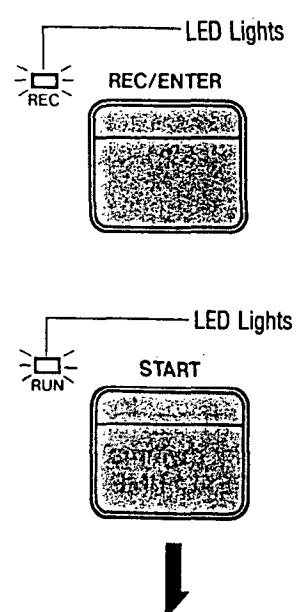
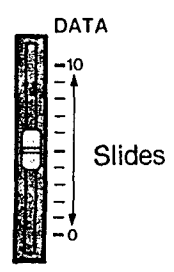
OPERATION	LCD & LED DISPLAY
<p>① After completing Section 2 — PATTERN RECORDING — procedures, set METRONOME BEAT (p. 96) and INSTRUMENT SETTINGS (p. 22).</p> <p>(REAL TIME RECORDING depends on METRONOME BEAT, so it is important to confirm setting before beginning recording procedures.)</p>	
<p>② Press the START KEY while holding down the REC ENTER KEY.</p> <div style="text-align: center;">  </div> <p>• With this operation, the Metronome Sound starts, and REAL TIME RECORDING becomes possible.</p>	<div style="text-align: center;">  </div> <div style="border: 1px solid black; padding: 5px; text-align: center; margin-top: 20px;"> <p>REAL RECORD I:0 P01-01 :*PTN-01*</p> </div>
<p>③ Adjust Metronome volume via the DATA SLIDER.</p> <div style="text-align: center;">  </div>	

HOW TO RECORD PATTERNS

④ PATTERNS may now be written by tapping the INST. KEYS along with the Metronome Sound.

- Rhythm patterns featuring ROLL and FLAM effects can be written by tapping INST. KEYS while holding down the ROLL or FLAM keys.

If a mistake is made in writing, refer to the ERASE procedures, described on page 63. When recording Sequence Parameters, refer to page 59.

⑤ REAL TIME RECORDING can be stopped by pressing the STOP/RESET KEY.

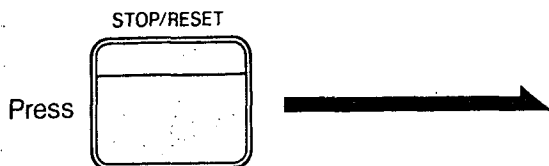

- To write a PATTERN for another instrument, repeat procedures from step ②.

(In this case, the previous STOP command is cancelled, and REAL TIME RECORDING starts.)

- STEP RECORDING can also be specified at this point. For complex rhythms, basic pattern parts can be written via REAL TIME RECORDING, and then STEP RECORDING may be utilized to write the more complex, detailed parts of the rhythm.
- If the STOP/RESET key is pressed once again, CONTINUE is cancelled, and the start position is reset at the beginning of the PATTERN.

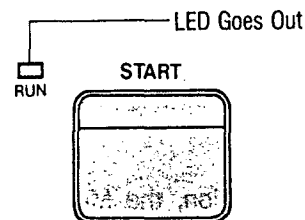
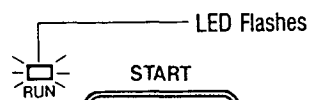
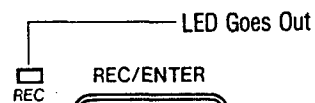
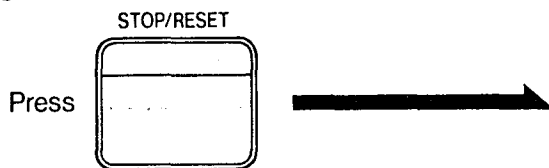

- If the Pattern Memory becomes full during Pattern Recording, the display appears as shown at the right, and further recording becomes impossible. In this case, secure more memory by clearing unnecessary patterns according to procedures described on page 73.

```
MEMORY FULL !!
P01-01 : *PTN-01*
```

- What the input of 249 or more notes in any is attempted, the display appears as at the right and recording stops. Further recording is impossible.

```
BAR MEMORY FULL!
P01-01 : *PTN-01*
```

4. Step Recording

This method is used to write PATTERNS one step at a time.
 Try writing the following PATTERN, following the procedures listed below.

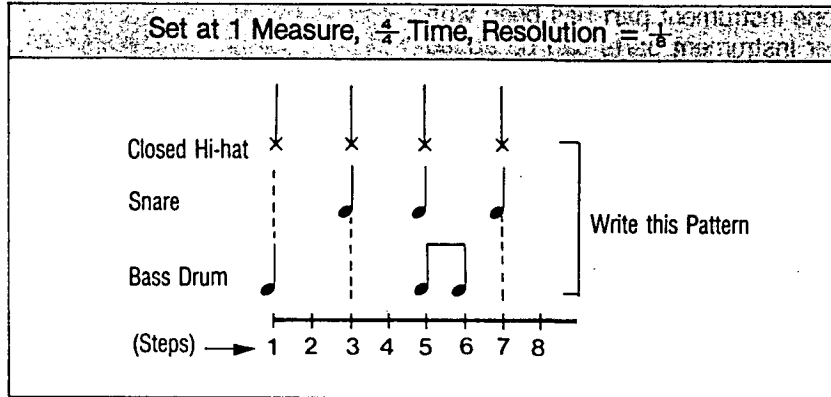

★ As the length of percussion instrument sounds is rather short, the difference between length of notes—such as $\frac{1}{4}$ and $\frac{1}{8}$ is specified via the Timing which is written (step).

OPERATION	LCD & LED DISPLAY
<p>① After performing operations related to PATTERN RECORDING (section 2), set INSTRUMENT SETTINGS, according to the rhythm pattern you want to write.</p>	
<p>② Press the STOP KEY while holding down the REC/ENTER KEY.</p> <div style="text-align: center;"> <p>Hold down</p> <p>and press</p> </div> <p>● With this operation, the unit is set for STEP RECORDING.</p>	<div style="text-align: center;"> <p>LED Lights</p> <p>LED Lights</p> <p>Present INST SETTING</p> <div style="border: 1px solid black; padding: 5px; width: fit-content; margin: 0 auto;"> <p>STEP RECORD I:0 P01-01 :5001/008</p> </div> <p>Present STEP No. of STEPs which can be written</p> </div>

HOW TO RECORD PATTERNS

③ Begin STEP RECORDING procedures. First, write the Bass Drum and closed Hi-hat parts for STEP 1. After one instrument part has been written on a step, other instrument parts can be added on that step by pressing the various while holding the original instrument keys.

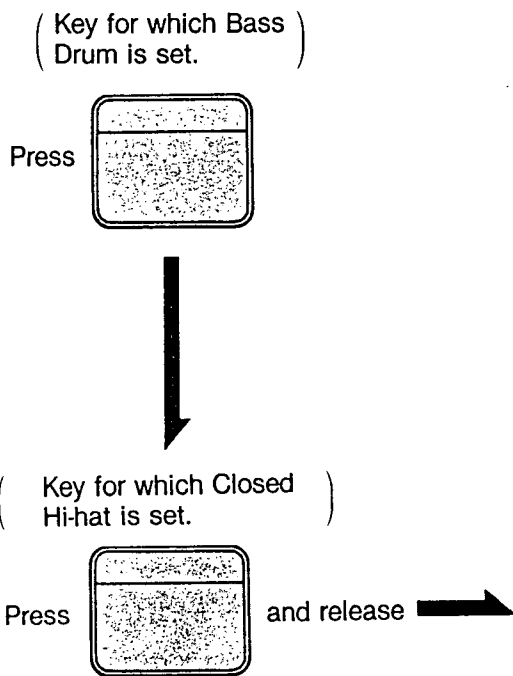

- ★ When this keys is pressed writing is possible even if order is reversed.
- Dynamics are determined by the strength at which keys are tapped.

```
STEP RECORD 1:0
P01-01 : 5002/008
```

Step increments one. 

④ As there are no notes in STEP 2, proceed to STEP 3 by pressing the +1/YES Key.



```
STEP RECORD 1:0
P01-01 : 5003/008
```

⑤ Write the Snare and Closed Hi-hat sounds for STEP 3.

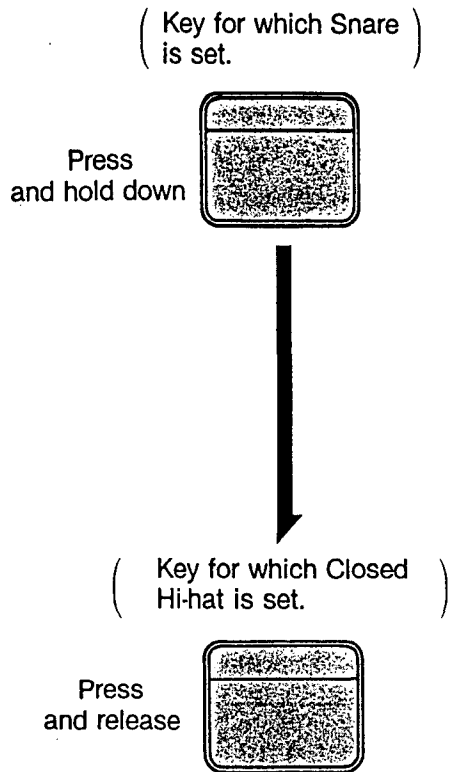

```
STEP RECORD I:0
P01-01 :5004/008
```

⑥ As there are no notes in STEP 4, proceed to STEP 5 by pressing the +1/YES Key.



```
STEP RECORD I:0
P01-01 :5005/008
```

HOW TO RECORD PATTERNS

⑦ Write the Bass Drum, Snare and Closed Hi-hat sounds for STEP 5.

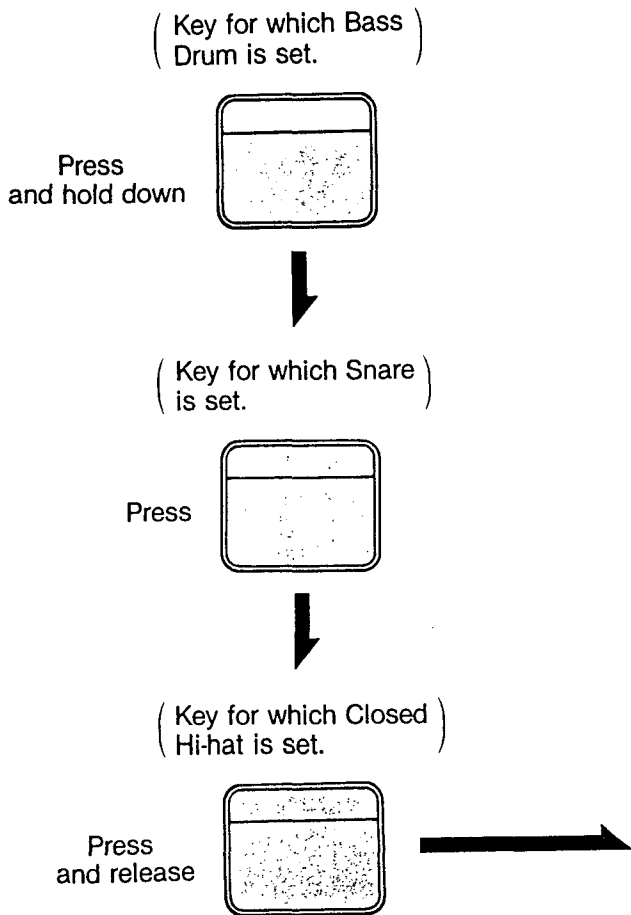

```
STEP RECORD  I:0  
P01-01 : 5006/008
```

8 Write the Bass Drum sound for STEP 6.

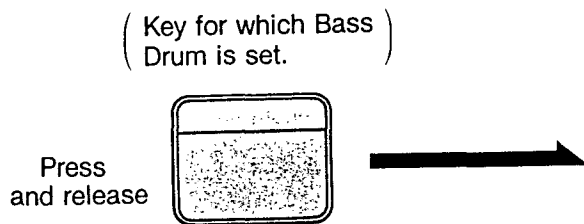

```
STEP RECORD  I:0  
P01-01 : 5007/008
```

⑨ Write the Snare and Closed Hi-hat sounds for STEP 7.

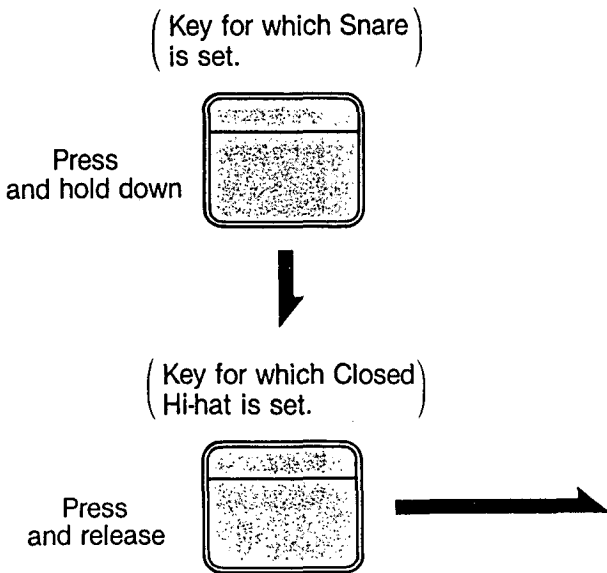

```
STEP RECORD 1:0
P01-01 : 5008/008
```

⑩ There are no notes in STEP 8, so the step can be advanced via the +1/YES key. However, in this case, the RESOLUTION is set to $\frac{1}{8}$, so the STEP count returns to STEP 1.

- This concludes the writing of this PATTERN, however if Step writing is continued at this point, newly written parts are added to those previously written, so it's possible to write patterns one instrument at a time, layering other instruments on top.
- Step display can be moved forward or backward in succession by holding down the +1/YES or -1/NO key, respectively. Notes written in the selected step are sounded. In this way, written patterns can be checked for accuracy. (Sound are not produced when steps are backed up via the -1/NO key.)

If mistake is made in writing, refer to the ERASE procedures, described on page 63. When recording Sequence Parameters, refer to page 59.

HOW TO RECORD PATTERNS

① STEP RECORDING can be stopped by pressing the STOP/RESET KEY.

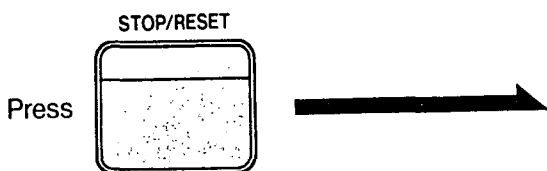

- REAL TIME RECORDING can also be specified at this point. Basic rhythm can be written via STEP RECORDING, and then ad-lib parts or fills can be written via REAL TIME RECORDING.
- If the STOP/RESET key is pressed once again, CONTINUE is cancelled, and the start position is reset at the beginning of the PATTERN.

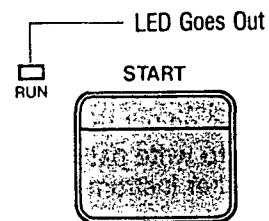
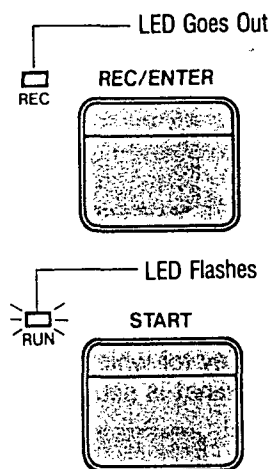
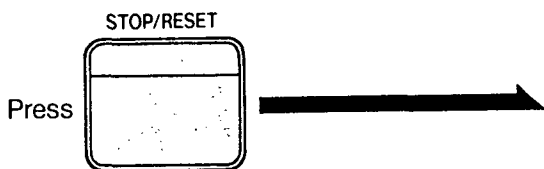

- If the Pattern Memory becomes full during Pattern Recording, the display appears as shown at the right, and further recording becomes impossible. In this case, secure more memory by clearing unnecessary patterns according to procedures described on page 73.

```
MEMORY FULL !!
P01-01 : 5000/000
```

- When the memory becomes full during Recording, the display appears as at the right and recording stops. In this case, CLEAR unnecessary patterns from memory. (see page 73.)

```
BAR MEMORY FULL!
P01-01 : 5000/000
```

5. Recording Sequence Parameters

SEQUENCE PARAMETERS are recorded for Instrument Sounds recorded via REAL TIME RECORDING and STEP RECORDINGS, described in sections 3 & 4.

■ Recording SEQUENCE PARAMETERS in REAL TIME

- ① Specify SEQ PARAMETER, by pressing FUNCTION SELECT KEY "f.6".

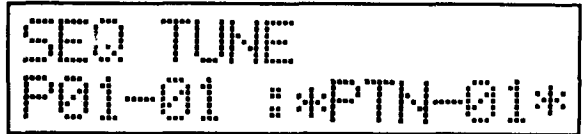
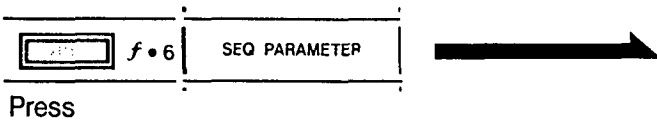

- ② Press the START KEY, while holding down the REC/ENTER KEY.

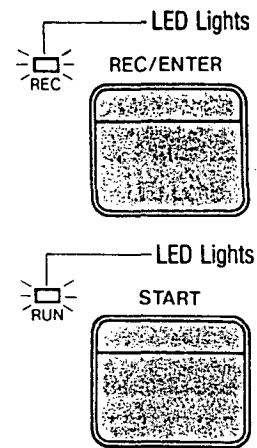
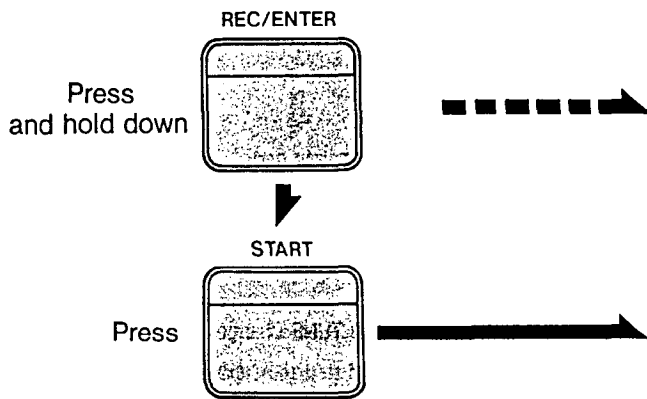

★ If only the START KEY is pressed, Sequence Parameter Play is possible (without recording). This allows you to practice before actually recording.

- ③ Subsequently pressing the "f.6" key causes the display to change as shown below - allowing selection of TUNE, DECAY and DYNAMICS.

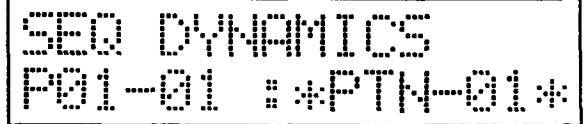
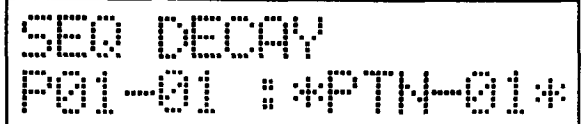
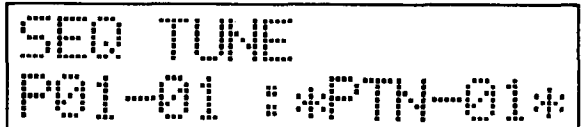
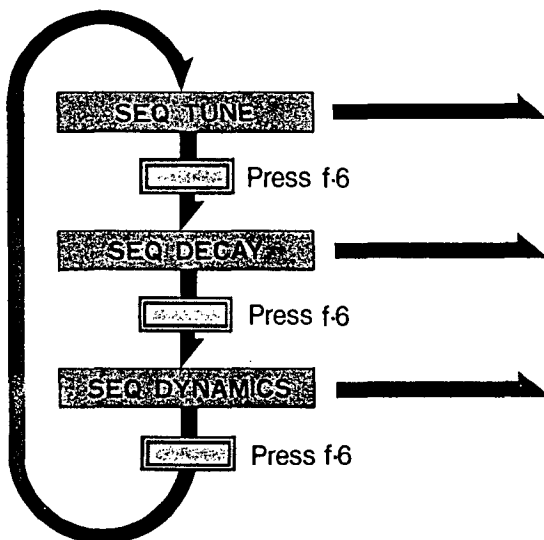

HOW TO RECORD PATTERNS

④ Press the Instrument Key for which you will set Sequence Parameters. The display shows the present Sequence Parameter value, as long as the key is held down. This value can be changed by sliding the DATA SLIDER, while still holding down the Instrument Key.

(When Recording into INST key "H");

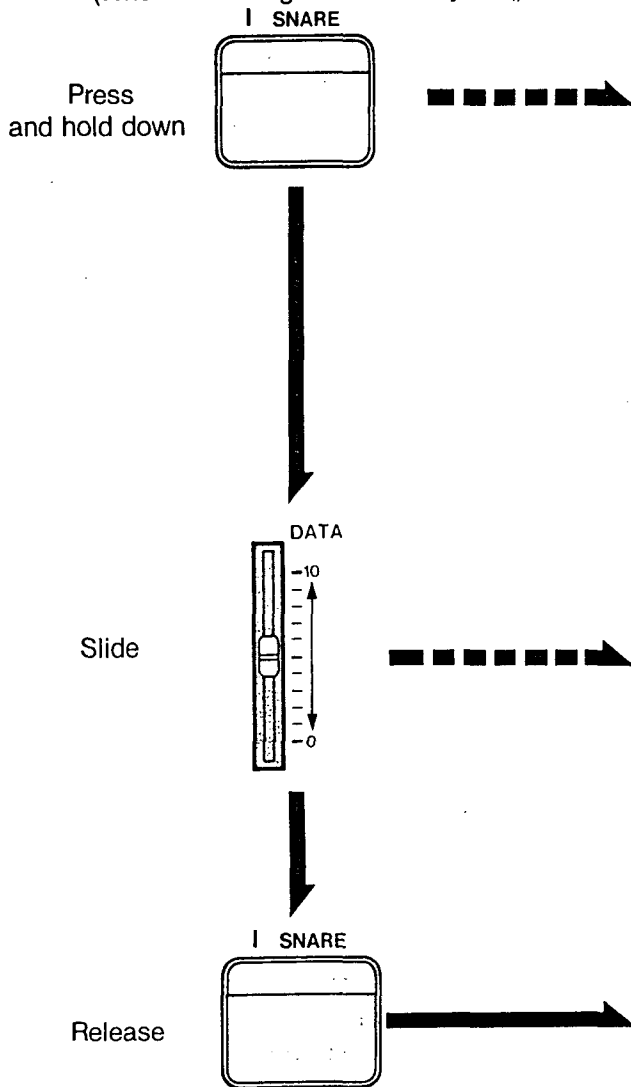

Present SEQ TUNE value displayed
(No display if Recording has not been performed)

```
I=SNARE 1      +00
P01-01 : *PTN-01*
```

SEQ TUNE Changes

```
I=SNARE 1
P01-01 : *PTN-01*
```

```
SEQ TUNE
P01-01 : *PTN-01*
```

Repeat procedures ③ and ④ to set all three SEQ PARAMETERS.

★ In this state, the mode changes to REAL TIME Recording if the TEMPO function is specified.

■ Recording SEQUENCE PARAMETERS for STEP RECORDING.

- ① Specify SEQ PARAMETER, by pressing FUNCTION SELECT KEY "f.6".



```

SEQ TUNE
P01-01 : 5001/000
    
```

- ② Press the STOP KEY, while holding down the REC/ENTER KEY.

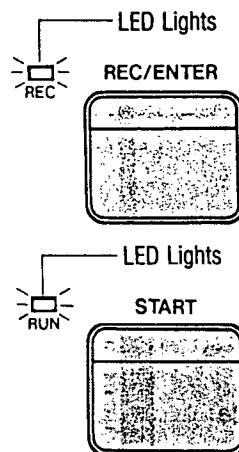
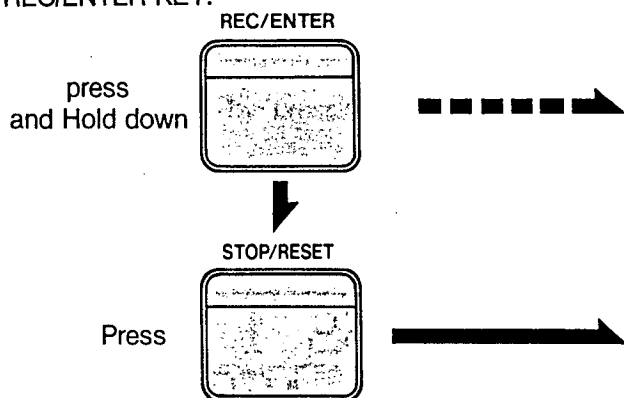

- ③ Select the STEP containing the SEQ PARAMETER to be changed via the +1/YES or -1/NO key.
(Sounds are not produced when steps are backed up via the -1/NO key.)

- ④ Subsequently pressing the "f.6" key causes the display to change as shown below - allowing selection of TUNE, DECAY and DYNAMICS.

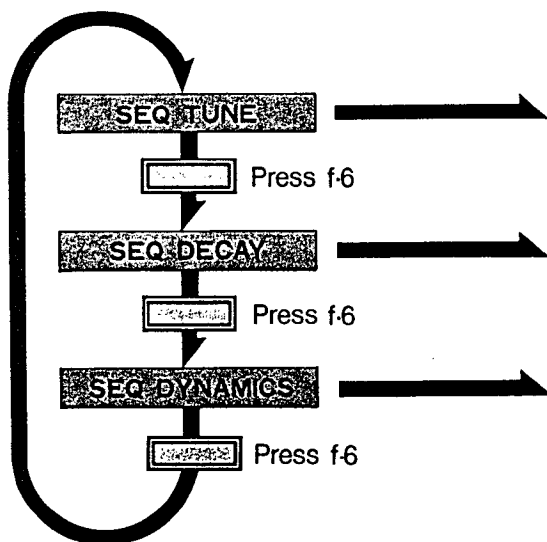

```

SEQ TUNE
P01-01 : 5001/000
    
```

```

SEQ DECAY
P01-01 : 5001/000
    
```

```

SEQ DYNAMICS
P01-01 : 5001/000
    
```

HOW TO RECORD PATTERNS

⑤ Press the Inst. Key for which you will set Sequence Parameters. The display shows the present Sequence Parameter value as long as the key is held down. This value can be changed by sliding the DATA SLIDER, while still holding down the Inst. Key.

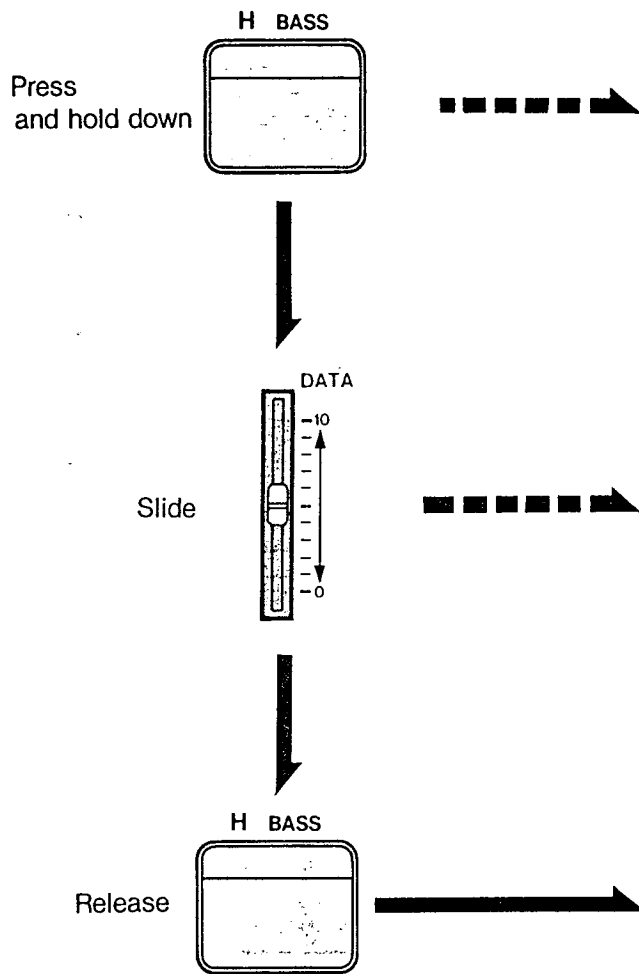

Present SEQ TUNE value displayed
(No display if Recording has not been performed)

```
H= BASS 1 +00
P01-01 :5001/008
```

SEQ TUNE Changes

```
H= BASS 1
P01-01 :5001/008
```





```
SEQ TUNE
P01-01 :5001/008
```

Repeat procedures ③ through ⑤ to record SEQ PARAMETERS, one step at a time.

6. Erase

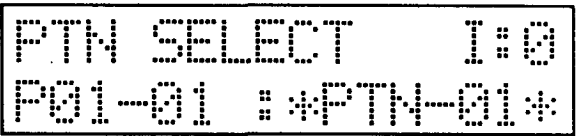
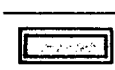
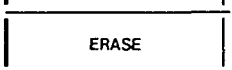
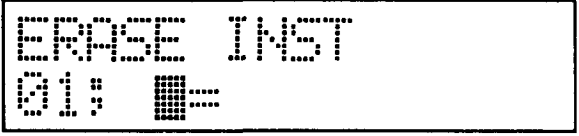
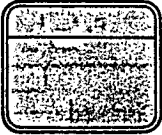
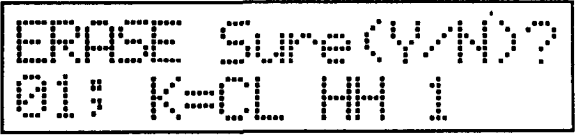
There are three different ways to ERASE programmed data.

■ How to ERASE an entire Instrument track

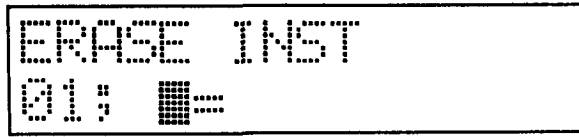
<p>① Stop the unit by pressing the STOP/RESET KEY.</p> <p>Press  →</p>	
<p>② Specify ERASE, by pressing FUNCTION SELECT KEY "f.8".</p> <p>  →</p> <p>Press</p>	
<p>③ Specify the sound to be erased by pressing the appropriate Inst. Key. (Inst. Key "K" in this case)</p> <p>Press  →</p> <p>SAVE</p>	
<p>④ Respond to the "Sure (Y/N)?" inquiry via the YES (+1/YES) or NO (-1/NO) key.</p> <p>Press  →</p> <p>Press  →</p>	 <p>All notes written in the specified instrument's track are erased, operation returns to step ②</p>  <p>ERASE command cancelled, operation returns to step ②</p>

Repeat steps ② through ④ to ERASE any other unnecessary instrument tracks.

HOW TO RECORD PATTERNS

■ How to ERASE an unnecessary part of an Instrument track.

- ① With the unit set for REAL TIME RECORDING, hold down FUNCTION SELECT KEY "f-8", and press the Instrument Key to which you have assigned the sound you want to ERASE.

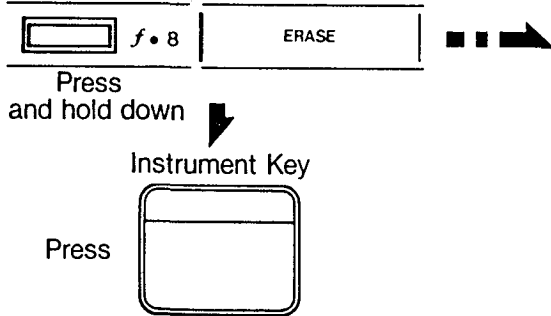

- The Instrument Sound will be erased from the PATTERN for as long as the Inst. Key is held down.

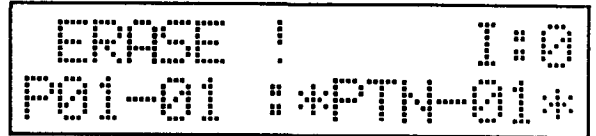

■ How to ERASE unnecessary parts, one STEP at a time.

- ① With the unit set for STEP RECORDING, raise or lower the STEP NUMBER via the +1/YES or -1/NO key to the STEP which you want to ERASE.

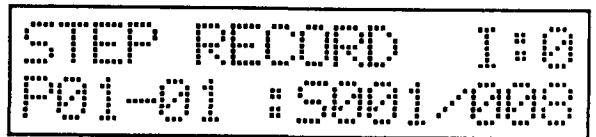
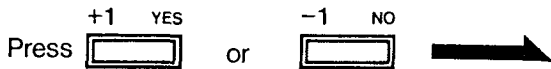

- ② While holding down FUNCTION SELECT KEY "f-8", press the Inst. Key set to the sound which you want to ERASE. (One or more Sound Source can be erased simultaneously.)

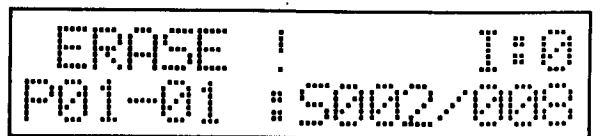
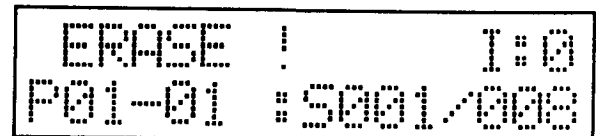
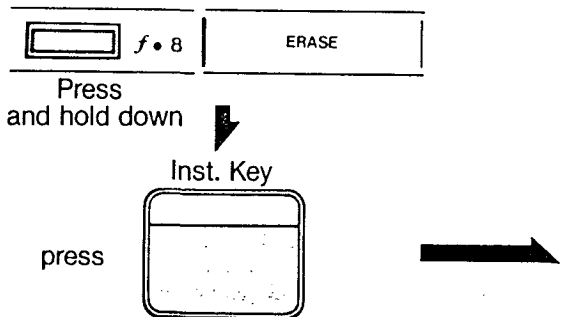

Repeat steps ① through ② to ERASE.

7. Editing of Patterns

■ SWING

A "swing" feel can be created by using this function, as it sounds the second half of beats on the back side - as in swing rhythm. This can only be set via Pattern Recording. SWING is set in 10 steps from 0 to 9 (50 ~ 88%), and put into memory with each different PATTERN.

★ The SWING effect is only produced during playback, and thus cannot be obtained during recording.

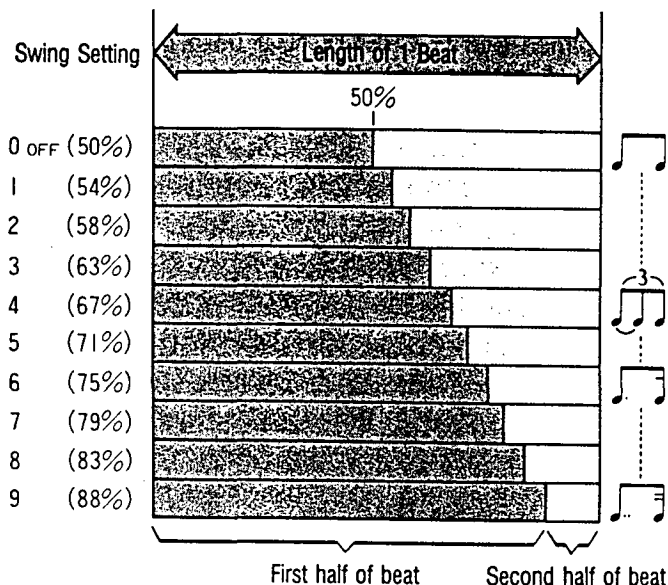

■ COPY

This function lets you copy finished patterns into other Pattern Numbers, as needed. This makes slight alteration to similar sounding phrases easy to record, as the basic pattern can be copied and then alteration to similar sounding phrases easy to Numbers.

Example of COPY

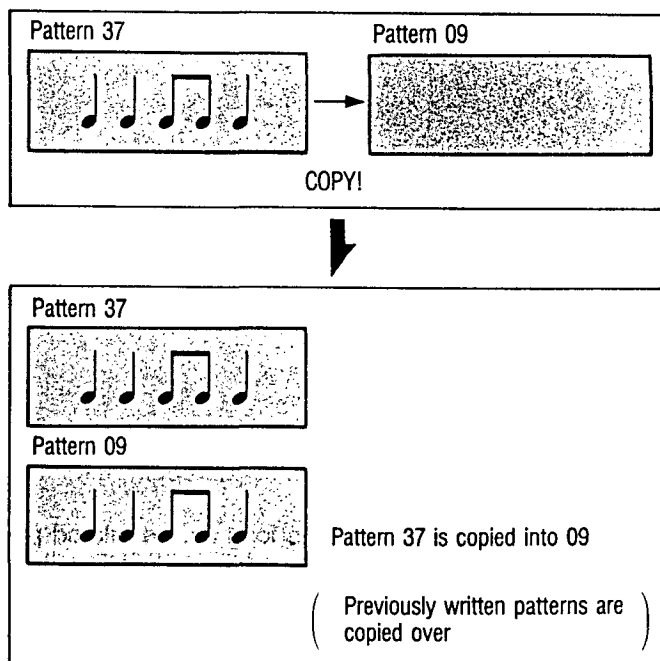

HOW TO RECORD PATTERNS

■ APPEND

This function is used to tie patterns together. This simplifies SONG CREATION, if used in the writing stage. A pattern may also be appended to itself.

Example of APPEND

Appending to a different pattern

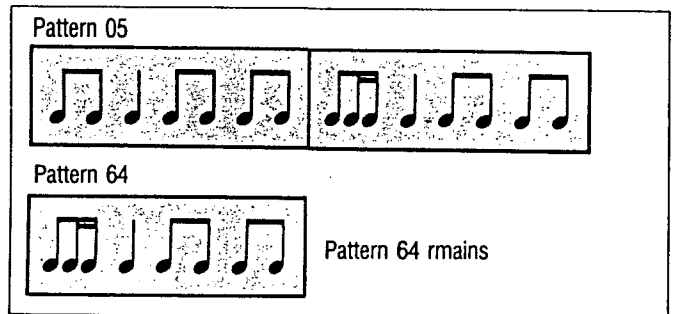
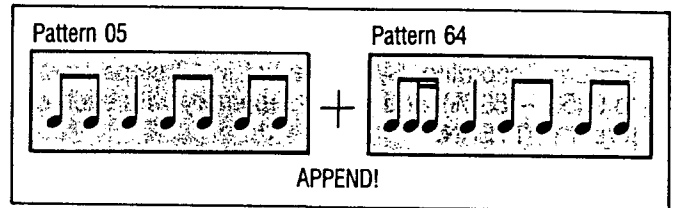

Appending a pattern to itself

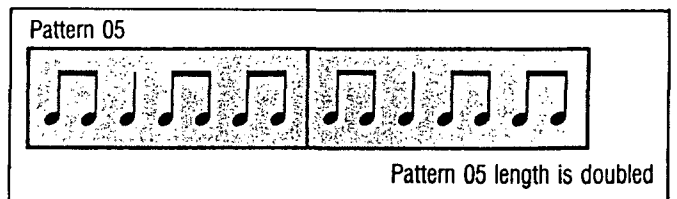
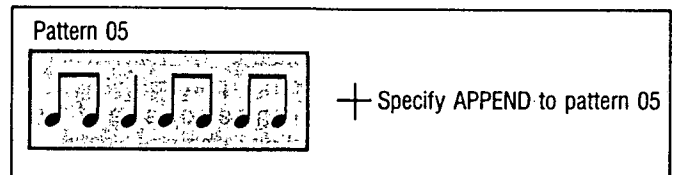

NOTE:

APPEND can be performed as long as the related patterns are set to the same beat, and the APPEND will not exceed 99 bars. Also, the illustrations to the right show caution to be taken when appending patterns which have been set to "SWING" rhythm.

If a pattern not set to SWING is appended to a pattern which has been set to swing, the entire pattern will have the SWING effect when played back.



If a pattern set to SWING is appended to a pattern which is not set to swing, only the part initially set to SWING will have the SWING effect when played back.

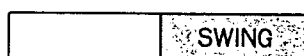

■ AVAILABLE MEMORY

When PATTERNS are written on the DDD-1, they are kept in the Pattern Memory. This function indicates the % of Pattern Memory which is still available.

Pattern Memory is erased when the No. of Bars is increased, and when Flams or sequence Patterns are recorded.

■ CLEAR

This function erases entire patterns from memory. After a CLEAR has been performed, values for the various parameters are as shown below;

- TIME SIGNATURE 4/4
- NUMBER OF BARS 01
- FLAM TIME 3
- SWING OFF (50%)
- NAME *PTN-*nn**

8. Pattern Editing Actual Operations

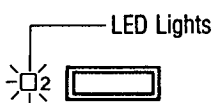
OPERATION	LCD & LED DISPLAY
<p>Specify PATTERN EDIT, by pressing MODE SELECT KEY "2".</p> <div style="text-align: center;">  </div> <p>Press <input type="checkbox"/> 2 <input type="checkbox"/></p>	<div style="text-align: center;">  </div>

1 SWING Setting

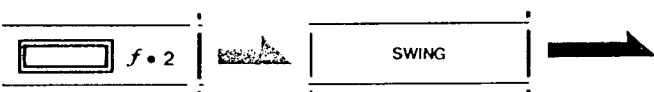
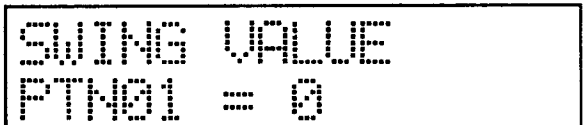
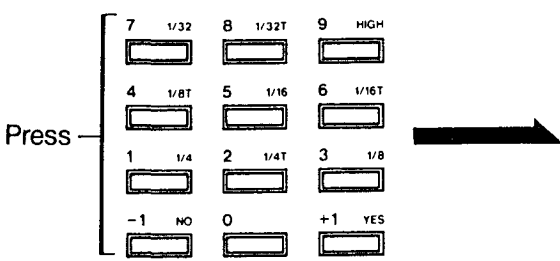
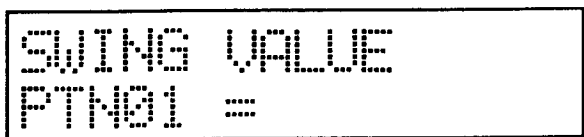
<p>① Specify SWING, by pressing FUNCTION SELECT KEY "f.2".</p> <div style="text-align: center;">  </div> <p>Press <input type="checkbox"/> f.2 <input type="checkbox"/> SWING</p>	<div style="text-align: center;">  </div>
<p>② Set the SWING value via the ten-keys or the +1/YES and -1/NO keys.</p> <div style="text-align: center;">  </div> <p>Press <input type="checkbox"/> 7 <input type="checkbox"/> 8 <input type="checkbox"/> 9 <input type="checkbox"/> 4 <input type="checkbox"/> 5 <input type="checkbox"/> 6 <input type="checkbox"/> 1 <input type="checkbox"/> 2 <input type="checkbox"/> 3 <input type="checkbox"/> -1 <input type="checkbox"/> 0 <input type="checkbox"/> +1</p>	<div style="text-align: center;">  </div> <p style="text-align: center;">SWING Value Changes <input type="checkbox"/></p>

2 COPY Procedure

- ① To perform a COPY, you must specify the PATTERN to be copied, and the PATTERN into which it is to be copied. First, select the PATTERN to be copied.

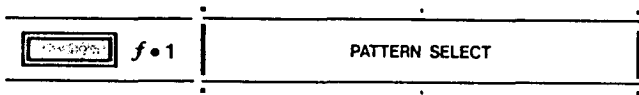

Press

- ② Specify the PATTERN Number via the ten-keys or the +1/YES and -1/NO keys.

- ③ Specify, by pressing COPY KEY "f.3".

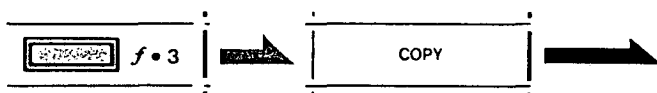

Press

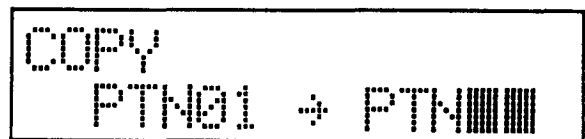

- ④ Next, specify the PATTERN Number into which it is to be copied, via the ten key pad.

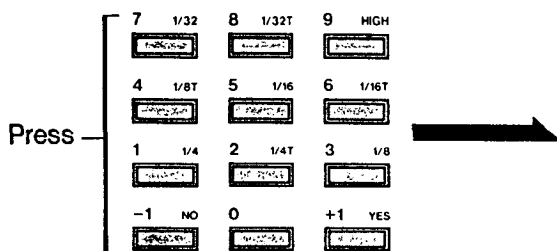

Press

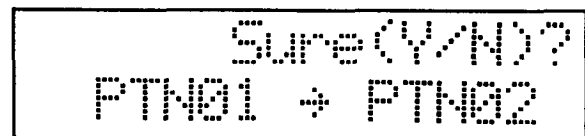

(PATTERN 01 is copied into 02)

HOW TO RECORD PATTERNS

⑤ Respond to the "Sure?" inquiry via the YES (+1/ YES or NO (-1/NO) key.

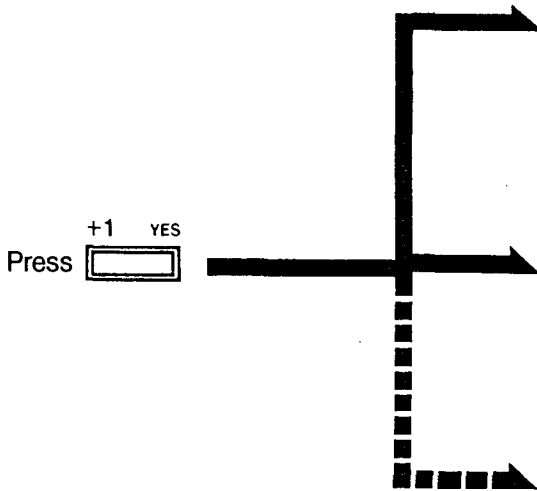

⑥ Respond to the "Rewrite?" inquiry via the YES (+1/YES) or NO (-1/NO) key.



When the PATTERN Number being copied into is blank.

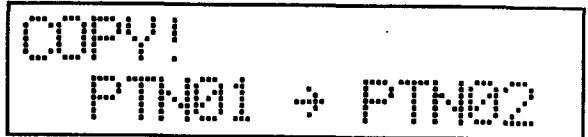

Operation returns to ① when COPY is complete.

When the PATTERN Number being copied into contains notes.

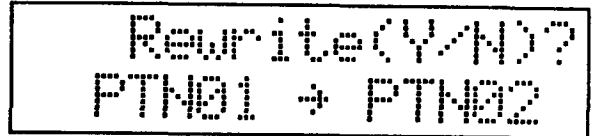

Display appears as above. Proceed to step ⑥.

Copy is carried out, without enough memory.

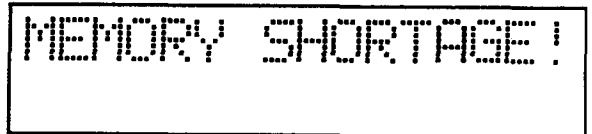

COPY command is cancelled, operation returns to step ①.

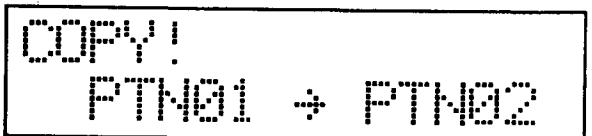

COPY is carried out, operation returns to ① after completion. (PTN02 now contains PTN01 Pattern).

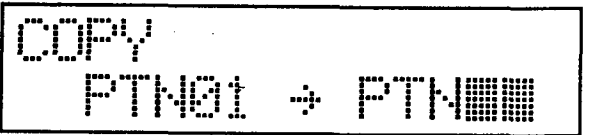

COPY command is cancelled, operation returns to ①.

3 APPEND Procedures

- ① To perform an APPEND, you must specify into which PATTERN Number the presently selected PATTERN is to be appended. First, select the PATTERN to be appended.

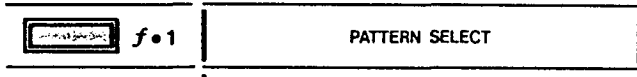

Press

- ② Specify the PATTERN Number via the ten key pad +1/YES and -1/NO keys.

- ③ Specify APPEND, by pressing FUNCTION SELECT KEY "f.4".



Press

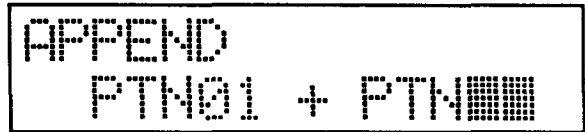

- ④ Next, specify the PATTERN to be appended via the ten key pad.

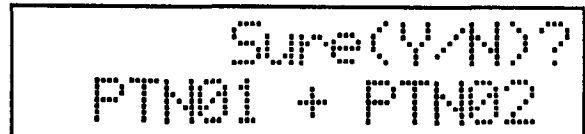
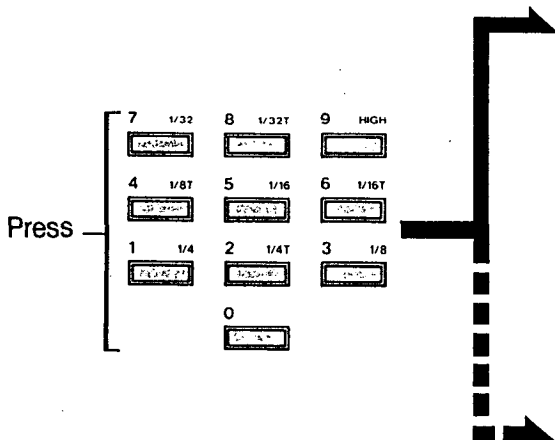

When APPEND is possible, display appears as above. Proceed to step ⑤.

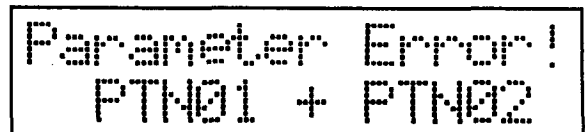

When APPEND is not possible, display appears as above and operation returns to ③.

HOW TO RECORD PATTERNS

⑤ Respond to the "Sure?" inquiry via the YES (+1/YES) or NO (-1/NO) key.

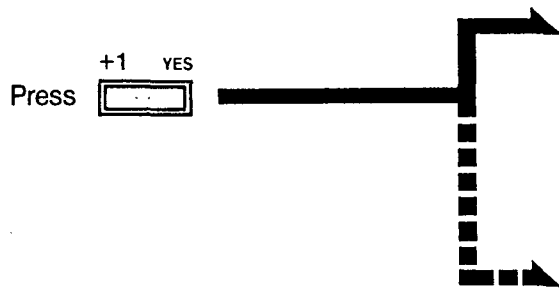

```
APPEND!
PTN01 + PTN02
```

APPEND is carried out, operation returns to ① when complete.

```
MEMORY SHORTAGE!
```

APPEND is carried out, without enough memory.

```
APPEND
PTN01 + PTN
```

APPEND command is cancelled, operation returns to ①.

4 AVAILABLE MEMORY

① When AVAILABLE MEMORY is specified by pressing FUNCTION SELECT KEY "f.7", the % of DDD-1 memory available displayed.

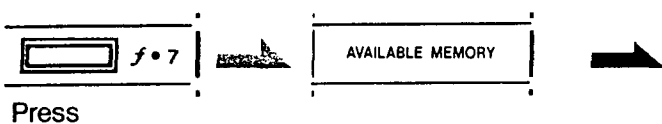

```
AVAILABLE MEMORY
099 %
```

5 CLEAR Procedures

- ① Specify CLEAR, by pressing FUNCTION SELECT KEY "f.8".



Press

```
CLEAR Sure(Y/N)?
P01-01 : *PTN-01*
```

- ② Respond to the "Sure?" inquiry via the YES (+1/YES) or NO (-1/NO) key.



```
CLEAR !!
P01-01 : *PTN-01*
```

CLEAR is carried out, PATTERN SELECT returns to "f.1".





```
PTN SELECT I:0
P01-01 : *PTN-01*
```

CLEAR command is cancelled, PATTERN SELECT returns to "f.1".

9. Pattern Name

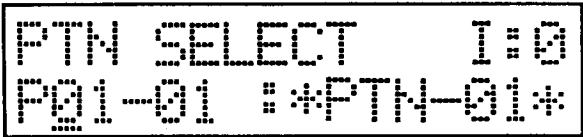
Can be recorded for all patterns written on the DDD-1, each up to 8 letters long.

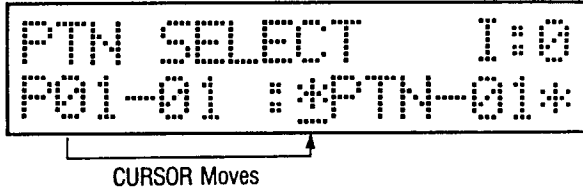
<p>① Specify PATTERN NAME, by pressing FUNCTION SELECT KEY "f.1".</p>  <p>Press</p>	
<p>② Move the CURSOR to the NAME position on the display, by pressing the CURSOR KEY.</p> <p>Press  </p>	
<p>③ Set desired character via the DATA SLIDER. Choose characters from the chart shown on the next page.</p>	
<p>Repeat procedures ② and ③ to record other characters up to a total of 8. Return cursor to original position.</p>	

SONG CREATION

1. Song Creation/Editing

With these functions, PATTERNS made via PATTERN RECORDING (p.36) are put together to create full SONGS. As the SONG is made, PART DATA (data on the order of patterns or songs), REPEAT, and TEMPO CHANGE are written in succession. PATTERNS are changed in order, according to this data. Also, entire SONGS can be used as single PARTS so you can play or SONGS back SONGS and PATTERNS in combination.

■ CREATE

PART DATA is created via this function, by specifying PATTERN NUMBERS in the desired order. Also, individual Instrument Settings can be set and put into memory for a single SONG.

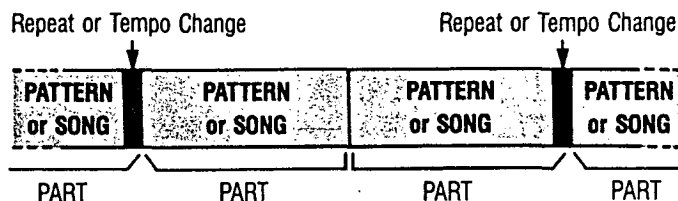

As shown above, REPEATS Tempo CHANGES are included in PARTS, when specified.

■ REPEAT

This function is used when you want to REPEAT the same phrase over and over for a specific number of measures.

There are three basic ways of using REPEAT, as shown in the examples to the right. (In each case, the REPEAT number is set to "1")

REPEATs are set by specifying the start point of the repeat and the number of times the phrase is repeated. It is impossible to perform REPEAT playback between the point where the REPEAT is inserted and subsequent PARTS.

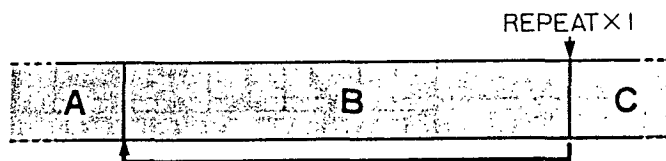

Actual playback data (A-B-B-C)

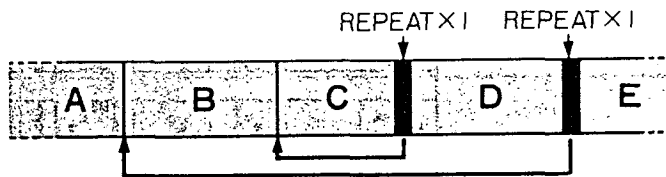

Actual playback data (A-B-C-C-D-B-C-C-D-E)

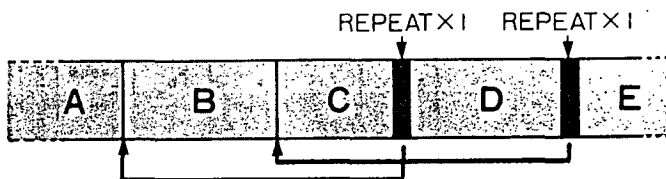

Actual playback data (A-B-C-B-C-D-C-B-C-D-E)

■ TEMPO CHANGE

TEMPO can be changed during playback by adding or subtracting values to or from the Tempo Value. It is impossible, however, to raise or lower the Tempo Value so it exceeds the ♩ = 40-250 range.

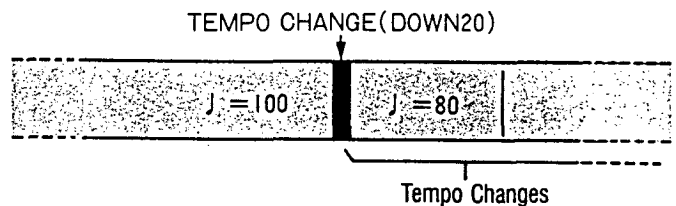

★ When tempo is changed during a repeat, tempo changes with every repeat cycle.

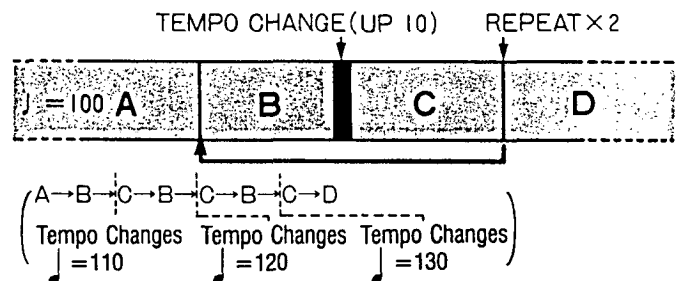

Example of SONG CREATION

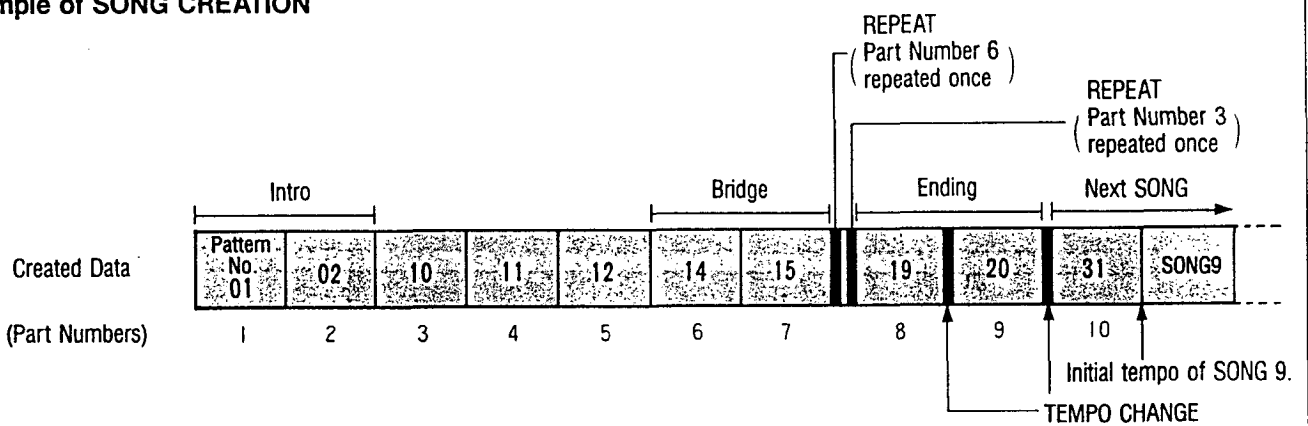

★ REPEATs and TEMPO CHANGEs use twice the usual amount of memory, so the maximum PART numbers available is less than 255 when either are utilized.

SONG CREATION

■ INSERT

This function is used to INSERT Part Data, Repeats, or Tempo Changes in the middle of SONGS.

Inserting Pattern Data

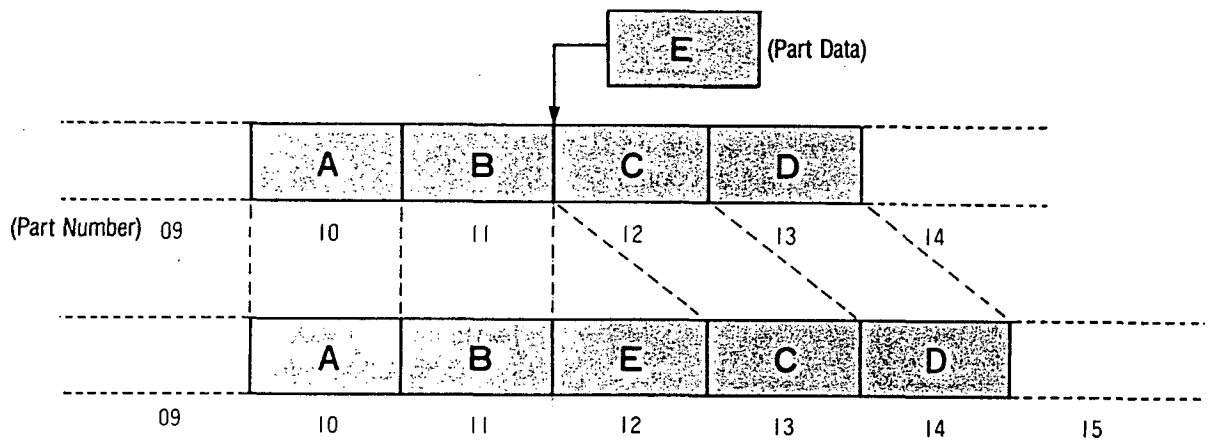

(When an INSERT is performed with Pattern Number 12 displayed, PARTS from Part "C" are shifted forward, and the inserted Part Data — "E" in this case — becomes Part Number 12. In this way, new data is inserted before presently displayed data.)

Inserting Repeats or Tempo Changes

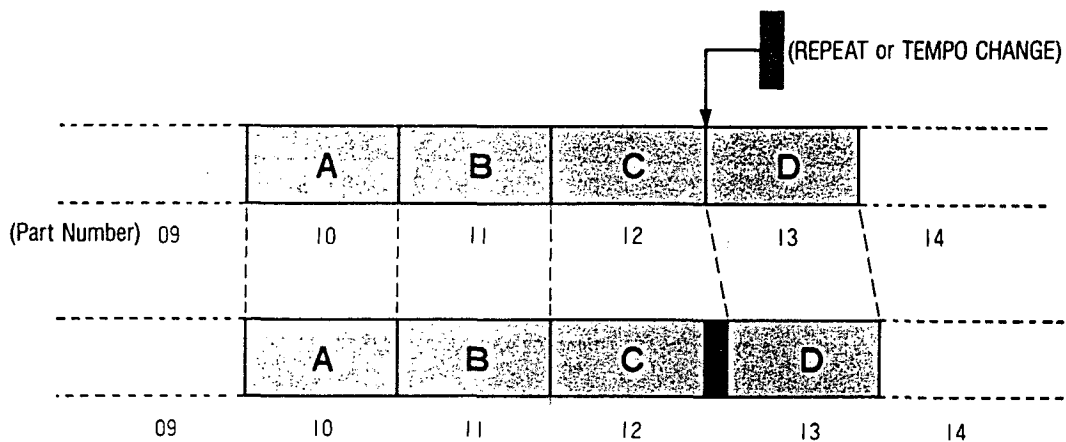

(When an INSERT is performed with Pattern Number 12 displayed, REPEAT or TEMPO CHANGE is inserted immediately after pattern Number 12. In this way, new data is inserted after presently displayed data.)

■ **DELETE**

This function is used to DELETE unnecessary Part Data, Repeats or Tempo Changes.

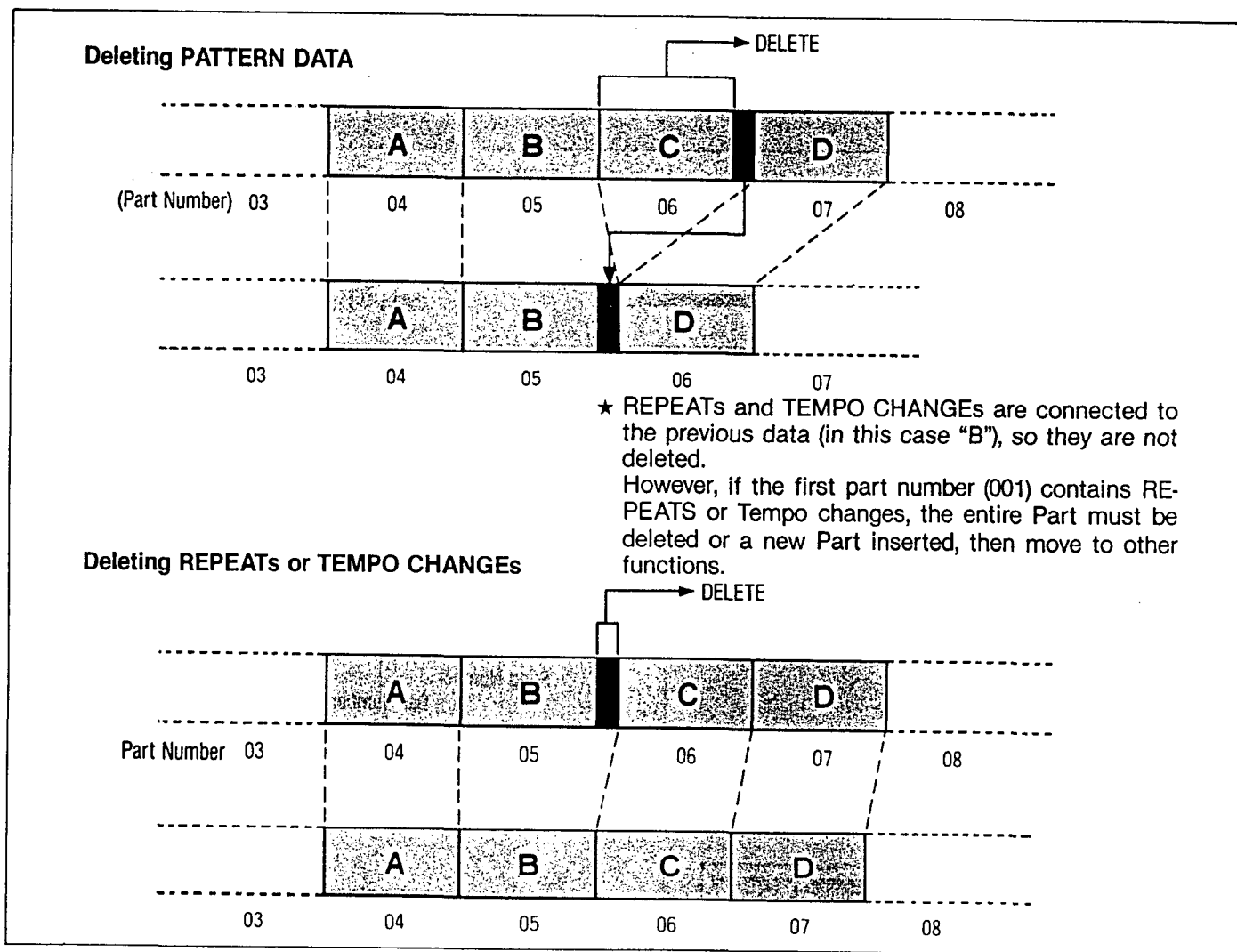

■ **TEMPO**

Refer to "SETTING AND CHANGING TEMPO" on page 20.

■ **CLEAR**

When a new SONG is written, previous SONG DATA is erased. Instrument Setting Numbers remain as previously set, and Tempo is reset to ♩ = 120.



2. Song Creation/Editing Actual Operations

Follow the procedures listed below for actual SONG CREATION and EDITING.



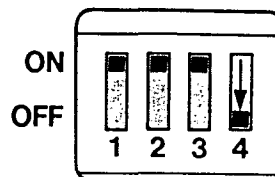

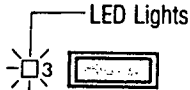

NOTE:

DIP Switch number 4 on the rear panel should be set to OFF when performing Song Creation or Editing.

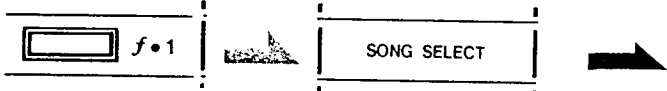

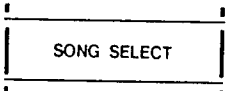
OPERATION	LCD & LED DISPLAY
Specify the SONG PLAY/EDIT MODE, by pressing MODE SELECT KEY "3". Press <input type="checkbox"/> 3  	

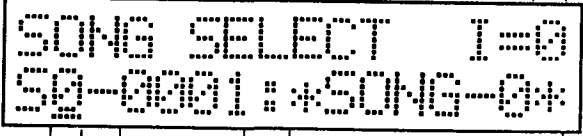
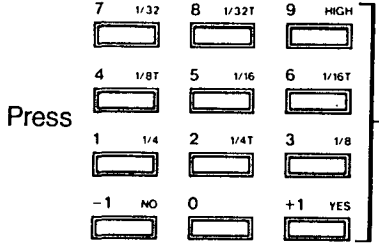
1 CREATE PROCEDURES

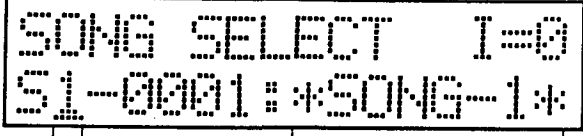
<p>① Specify SONG SELECT, by pressing FUNCTION SELECT KEY "f.1".</p>  <p>Press <input type="checkbox"/> f.1   <input type="checkbox"/> SONG SELECT  </p>	<p style="text-align: right;">Inst Setting Number</p>  <p style="text-align: center;">Song Number Bar Number Song Name</p>
<p>② Select the SONG NUMBER via the ten key pad or +1/YES and -1/NO keys.</p>  <p>Press <input type="checkbox"/> 7 1/32 <input type="checkbox"/> 8 1/32T <input type="checkbox"/> 9 HIGH <input type="checkbox"/> 4 1/8T <input type="checkbox"/> 5 1/16 <input type="checkbox"/> 6 1/16T <input type="checkbox"/> 1 1/4 <input type="checkbox"/> 2 1/4T <input type="checkbox"/> 3 1/8 <input type="checkbox"/> -1 NO <input type="checkbox"/> 0 <input type="checkbox"/> +1 YES</p> <p></p> <p>There are no demonstration patterns contained in PATTERN Numbers 0, 4 through 9. Use any of these numbers. when you wish to use a Pattern Number which already contains data, perform PATTERN CLEAR operations, described on page 89, after preserving data on a RAM card or via tape interface.</p>	 <p style="text-align: center;">Song Number and Name Change</p>

③ Next, specify the Inst Setting. Move the CURSOR to the Inst Setting position on the display by pressing the CURSOR KEY.

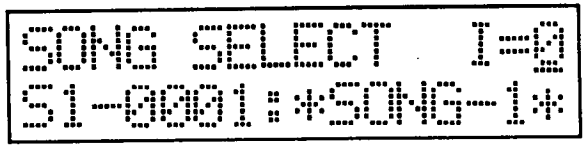

④ Specify the Inst Setting Number via the ten key pad or the +1/YES and -1/NO keys.

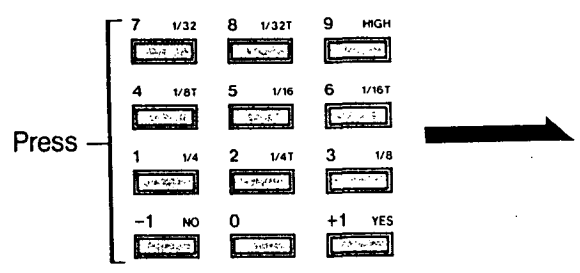

Inst Setting Changes

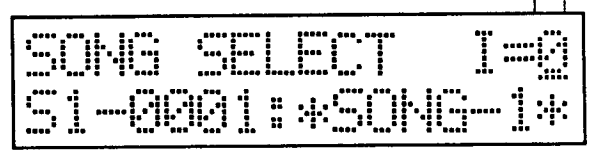

⑤ Next, "CREATE" a song. Specify CREATE, by pressing FUNCTION SELECT KEY "f.2".

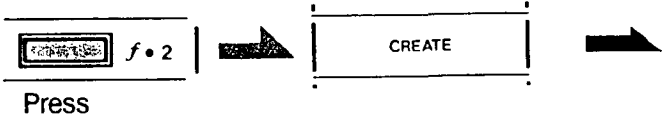

● The Part Number is displayed, and Part Data input becomes possible.

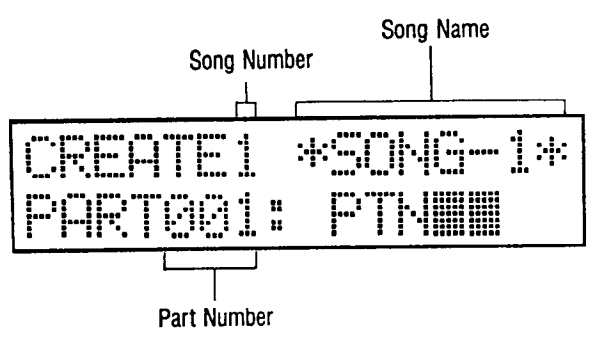











⑥ Select either PATTERN or SONG, by pressing the CURSOR KEYS.

Press (PATTERN)  →

Press (SONG)  →

Press

7	1/32	8	1/32T	9	HIGH
					
4	1/8T	5	1/16	6	1/16T
					
1	1/4	2	1/4T	3	1/8
					
		0			
					

 →

```
CREATE1 *SONG-1*
PART001: PTN
```

```
CREATE1 *SONG-1*
PART001: SONG
```

```
CREATE1 *SONG-1*
PART001= PTN01
```

- Pattern Number and Song Number can be changed freely until step ⑦ is performed, however it is impossible to change from, for example, PATTERN to SONG via the CURSOR KEY. To make changes in this case, use the DELETE or INSERT functions.
- The PATTERN or SONG presently set or previous PATTERNS or SONGS, can be played back by pressing the START KEY, so songs can be reviewed as they are created.

To Set REPEATs or TEMPO CHANGES, refer to page 83.

⑦ Pressing the +1/YES key increments the Part Number by 1, allowing the setting of the next PATTERN or SONG Number via step ⑥ procedures.

Press

+1	YES
	

 →

- Pressing the -1/NO key decrements the Part Number by 1, allowing the correction of data input at step ⑥.

```
CREATE1 *SONG-1*
PART002: PTN
```

Indicates no data is in memory.

Continue to write the SONG by repeating steps ⑥ and ⑦.

2 SETTING REPEAT

REPEATs are put into memory immediately after pieces of Part Data, Tempo Changes or Repeats written in SONG CREATION. Therefore, it is impossible to insert REPEATs until the Part Data to be repeated is written entirely. To set REPEAT for Part Numbers already written use the INSERT function.

- ① While set to SONG CREATE, specify "REPEAT" by pressing FUNCTION SELECT KEY "f.3".

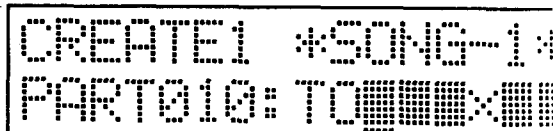
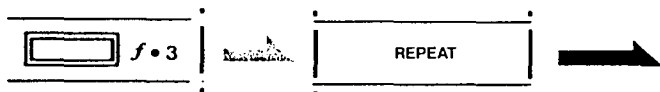

- ② Specify the Pattern Number where the REPEAT is to begin via the ten key pad.

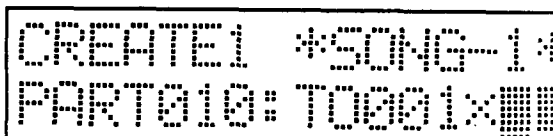
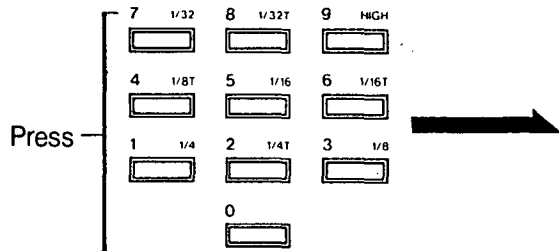

Indicates REPEAT is to begin with Pattern Number

- ③ Specify the number of times the selected pattern is to REPEAT via the ten key pad.

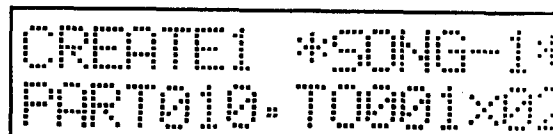
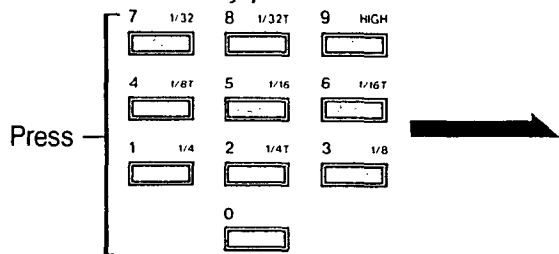

Indicates set for two c

- Pattern Number which is to the beginning of the REPEAT, and the number of REPEAT cycles can be freely changed by moving the CURSOR, until step ④ is carried out.

- ④ Pressing the +1/YES key sets the REPEAT, and the Part Number is incremented 1 number.

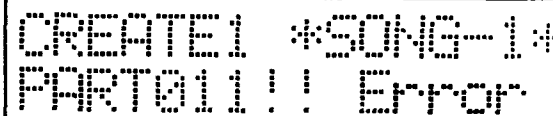
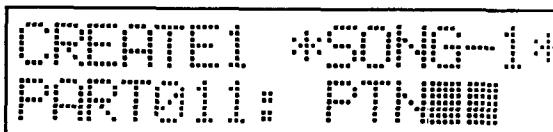
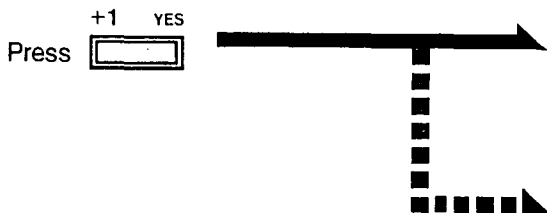

If the part Number at which REPEAT is to begin is input incorrectly, an ERROR message is displayed, and operation returns to ①.

③ SETTING TEMPO CHANGE

TEMPO CHANGES are put into memory immediately after pieces of Part Data Repeats written during SONG CREATION, just as Repeats are. Therefore, it is impossible to insert TEMPO CHANGES until the related Part Data has been specified. To set TEMPO CHANGE for Part Numbers already written, use the INSERT function.

- ① While set to SONG CREATE, specify "TEMPO CHANGE" by pressing FUNCTION SELECT KEY "f.4".

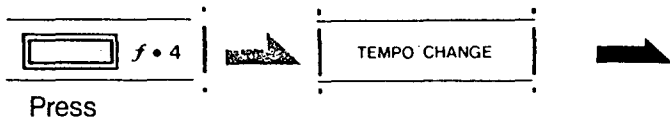

```
CREATE1 *SONG-1*
PART020: UP
```

- ② Select UP or DOWN by pressing the CURSOR key, and then specify the value by which you want to raise or lower the tempo via the ten key pad.



```
CREATE1 *SONG-1*
PART020: UP
```



```
CREATE1 *SONG-1*
PART020: DOWN
```

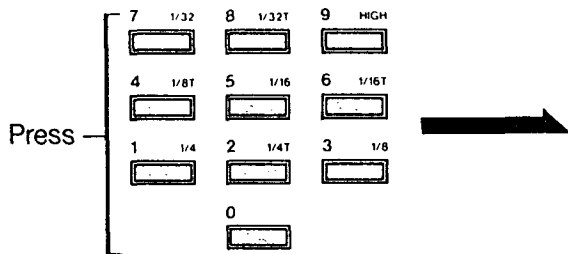

```
CREATE1 *SONG-1*
PART020K UP 10
```

Indicates Tempo raised by a value of 10.

- Tempo can be changed freely until step ③ procedures are carried out with the UP or DOWN keys.

- ③ Pressing the +1/YES sets the TEMPO CHANGE, and the Part Number is incremented 1 number.



```
CREATE1 *SONG-1*
PART021: PTN
```

Part Number increments.

4 INSERT OPERATION

INSERTING PATTERNS & SONG

① Specify CREATE, by pressing FUNCTION SELECT KEY "f.2".



Press

② Move to the Part to be inserted into by pressing the +1/YES or -1/NO keys.

★ When Part Data is inserted, it is inserted into the Part Number presently displayed. Subsequent Part Number, including that formerly occupying the displayed part is shifted forward.

③ Specify INSERT, by pressing FUNCTION SELECT KEY "f.5".

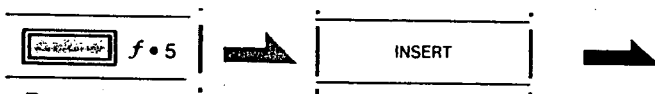

Press

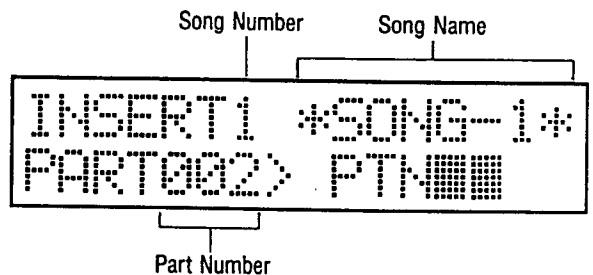

SONG CREATION

④ Select either PATTERN or SONG, by pressing the CURSOR KEY. Then specify the Pattern Number and Song Number via the ten key pad.











Press  →

```
INSERT1 *SONG-1*
PART002> PTN
```

Press  ← →

```
INSERT1 *SONG-1*
PART002> SONG
```

Press

7	1/32	8	1/32T	9	HIGH
					
4	1/8T	5	1/16	6	1/16T
					
1	1/4	2	1/4T	3	1/8
					
		0			
					

→

```
INSERT1 *SONG-1*
PART002= PTN01
```

- Pattern Number and Song Number can be changed freely until step ⑤ is performed, however it is impossible to change from, for example, PATTERN to SONG via the CURSOR KEY.

⑤ INSERT is carried out when the +1/YES is pressed. Succeeding Pattern Data may now be input.











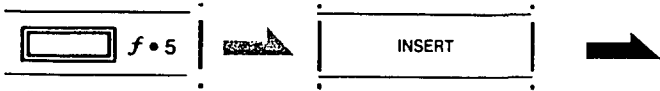

Press  →

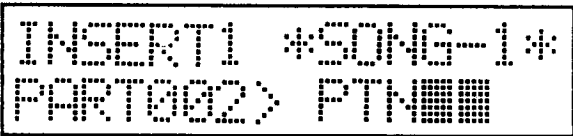
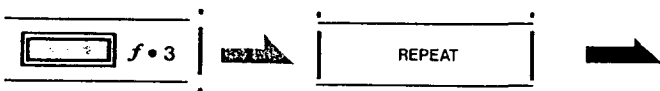
```
INSERT1 *SONG-1*
PART003> PTN
```

Part No. increments

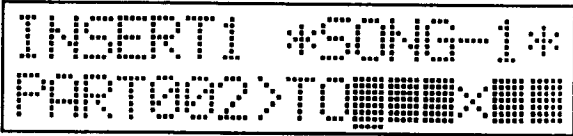
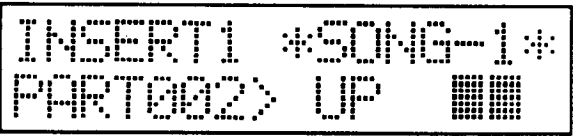
Subsequent INSERTs may be made by repeating steps ④ and ⑤. Pressing FUNCTION SELECT KEY "f-2" cancels the INSERT command.

INSERTING REPEAT & TEMPO CHANGES

<p>① Specify CREATE, by pressing FUNCTION SELECT KEY "f.2".</p>  <p>Press  f.2 → CREATE</p>	
<p>② Move to the Part to be inserted into by pressing the +1/YES or -1/NO keys.</p> <p>★ REPEAT or TEMPO CHANGE is inserted immediately after the displayed Part.</p>	
<p>③ Specify INSERT, by pressing FUNCTION SELECT KEY "f.5".</p>  <p>Press  f.5 → INSERT</p>	
<p>④ If FUNCTION SELECT KEY "f.3" is pressed while in the insert mode, a REPEAT is inserted. If "f.4" is pressed, a TEMPO CHANGE is inserted.</p>  <p>Press  f.3 → REPEAT</p>  <p>Press  f.4 → TEMPO CHANGE</p> <p>● Refer to REPEAT & TEMPO CHANGE setting procedures, from page 83. Changes can be made freely until step ⑤ is carried out.</p>	 
<p>⑤ Pressing the +1/YES key allows subsequent insertion of REPEATS or TEMPO CHANGES.</p>  <p>Press  +1 YES</p>	
<p>Further INSERTs can be made by repeating steps ④ and ⑤. Pressing FUNCTION SELECT KEY "f.2" cancels the INSERT command.</p>	

SONG CREATION

5 DELETE PROCEDURES

- ① Specify CREATE, by pressing FUNCTION SELECT KEY "f.2".



Press

- ② Move to the Part to be deleted by pressing the +1/YES or -1/NO keys.

★ When Pattern Data is deleted, the Part presently displayed is deleted and subsequent Data shifts 1 part backward. REPEATs and TEMPO CHANGES are displayed, and can be deleted in the same way as SONGs and PATTERNs.

- ③ Specify DELETE, by pressing FUNCTION SELECT KEY "f.5".



Press

```
DELETED1 *SONG-1*
PART002? PTN10
```

- ④ Press the REC/ENTER KEY.

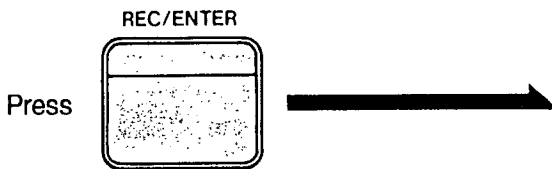

```
DELETED1 *SONG-1*
PART002!!DELETE
```

```
DELETED1 *SONG-1*
PART002? PTN15
```

Next Data is displayed,
replacing deleted data.

Further DELETES can be made by repeating step ④. Pressing FUNCTION SELECT KEY "f.2" cancels the DELETE command.

⑥ CLEAR PROCEDURES

① Specify CLEAR, by pressing FUNCTION SELECT KEY "f.8".

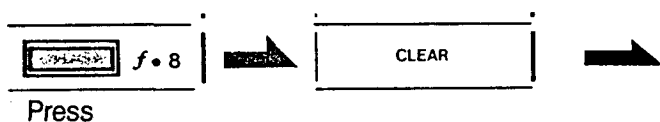

```
CLEAR Sure(Y/N)?
SONG1 : *SONG-1*
```

② Respond to the "Sure?" inquiry via the YES (+1/YES) or NO (-1/NO) key.



```
CLEAR!
SONG1 : *SONG-1*
```

CLEAR is carried out, operation returns to "f.1" SONG SELECT.





```
SONG SELECT I=0
S1-0001 : *SONG-1*
```

CLEAR command is cancelled, operation returns to "f.1", SONG SELECT.

3. Song Names

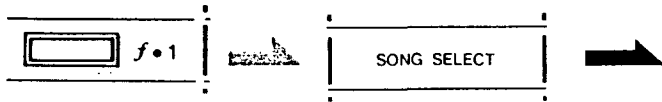
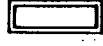
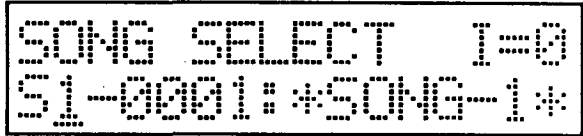
SONG NAMES can be recorded for all songs written on the DDD-1, each up to 8 letters long. This facilitates easy confirmation of the SONG being played.

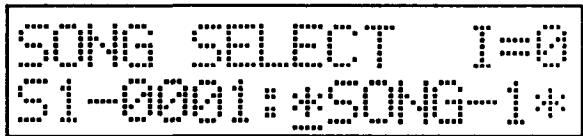
<p>① Specify SONG SELECT, by pressing FUNCTION SELECT KEY "f.1".</p>  <p>Press </p>	
<p>② Move the CURSOR to the NAME position on the display, by pressing the CURSOR key.</p> <p>Press </p>	 <p style="text-align: center;">Cursor Moves</p>
<p>③ Set desired character via the DATA SLIDER or +1/YES and -1/NO keys. choose characters from the Pattern Name characters from the Pattern Name chart, on page 75.</p>	
<p>Repeat procedures ② and ③ to record other characters - up to a total of 8. Move CURSOR back to its original position when all characters have been recorded.</p>	

SYSTEM SETTING

1. System Setting

These Functions are used to make DDD-1 basic system settings, beginning with MIDI functions.

■ METRONOME

This function is used to set metronome sound ON/OFF, and the beat during playback. However, the metronome sounds even if it is turned OFF during recording. Sound is output via the center L and R/MONO jacks. If a plug is inserted in the METRONOME OUT jack, then output via the L or R/MONO jacks is cancelled.

■ TRIGGER ASSIGN

This key is used to specify keys used for TRIGGER IN and TRIGGER OUT functions. The same key may be selected for both TRIGGER IN and TRIGGER OUT, or separate keys may be selected.

■ TRIGGER IN

Inst Keys can be controlled by external devices such as drum pads, etc., by connecting them to the AUDIO IN jack on the rear panel. Not limited to only trigger-type signals, even voice signals may be used, with input levels controlling DDD-1 dynamics.

■ TRIGGER OUT

Connecting this terminal with synthesizers, delay units etc. featuring TRIGGER IN jacks allows the DDD-1 to be used as an external trigger for other devices, or to be used in trigger overdub timing, etc. A trigger signal is output when each Inst Key operates according to specified song or pattern settings.

Output trigger polarity can be changed by changing the position of DIP Switch "3" on the rear panel.

When set to ON, a "┌" type trigger is output, and a "└" type is output.

Select Metronome Beat from the Chart Below.
(accent)

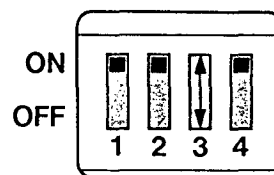
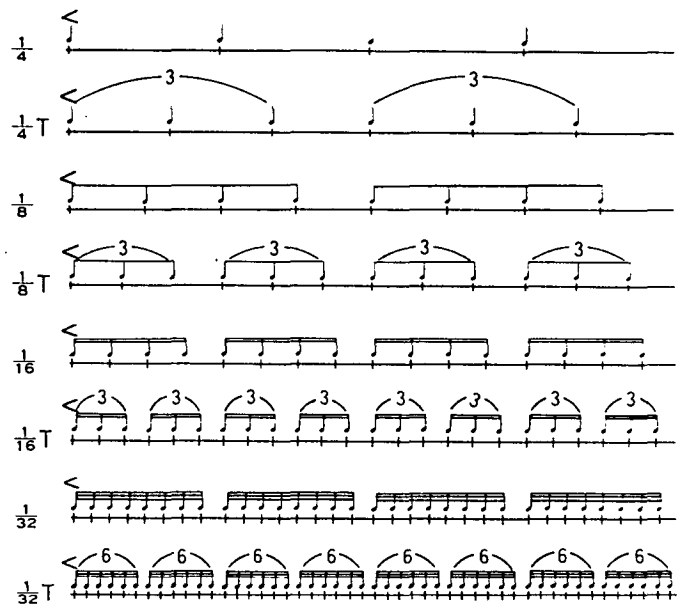

SYSTEM SETTING

■ CLOCK

Three different CLOCK Functions can be selected for the DDD-1.

INTERNAL:

The INTERNAL clock is used for the DDD-1 itself, and when the DDD-1 is used as a master clock for other units. (MIDI CLOCK and TAPE SYNC signals are both output.)

Set to INTERNAL

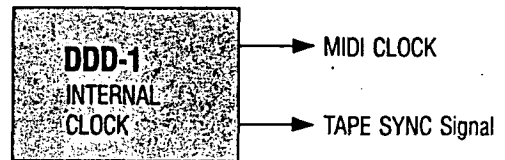

MIDI:

In this mode, an external MIDI clock operates. Set to this mode when another MIDI device, such as a synthesizer is used as master, and the DDD-1 is used as a slave. (TAPE SYNC signal is output.)

Set to MIDI

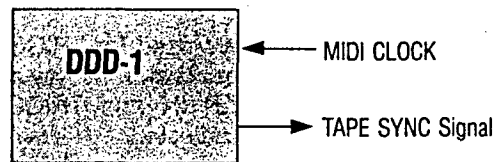

TAPE:

In this mode, the DDD-1 is operated via an external TAPE SYNC signal. Use this mode when utilizing a tape recorder as the master, and the DDD-1 as a slave. (MIDI CLOCK is output.)

Set to TAPE

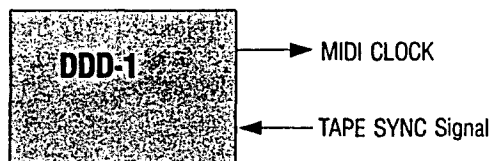

- TAPE SYNC Signals are set at $\text{♪} = 24$. Also, by changing the relative positions of the DIP Switch bits on the rear panel, the TAPE jack input level can be changed from HIGH to LOW.
- TEMPO is not displayed when the Clock is set to either MIDI or TAPE as external.

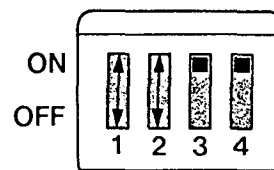

■ MIDI RECEIVE

The DDD-1 can be used as a sound source for performance slaves of the same class, such as drum pads, by receiving data programmed via MIDI keyboards, etc. This MIDI RECEIVE function has 4 parameters which relate to the reception of MIDI Data (Channel Messages).

● NOTE DATA RECEIVE ON/OFF

This determines whether the DDD-1 will receive or ignore input data from external sources.

● OMNI MODE ON/OFF

This determines whether some or all of the 16 MIDI Channels are received.

● RECEIVE CHANNEL SPECIFY

This determines the MIDI Channels which are received when the OMNI Mode is OFF.

● NOTE NUMBER SETTING

This setting determines which Inst Keys sound according to the key number of received key notes. This number can also be transmitted. Available setting range of Note Number is 25~71.

■ MIDI TRANSMIT

The DDD-1 can be used as a master to drive slaves of the same class, or as the sound source for a multiple of MIDI devices. This MIDI TRANSMIT function has 2 parameters which relate to the transmission of MIDI Data (Channel Messages).

● NOTE DATA TRANSMIT ON/OFF

This determines whether the DDD-1 will output NOTE DATA.

● INST KEY TRANSMIT CHANNEL SETTING

This determines which of the 16 MIDI Channels that transmitted MIDI Data will be output from, for each Instrument Key.

(Note Number is the same as for RECEIVED NOTE NUMBER.)

■ SAMPLING SET

★ This function cannot be selected if a Sampling Board is not connected to the rear panel jack.

Sampling can be performed with the DDD-1, by utilizing the optional Sampling Board (DSB-1).

2 types of sounds can be sampled in the 2-sound mode, 1 type in the 1-sound mode. These sampled sounds are used to create rhythms with the DDD-1, in the same ways as other sound sources. The entire memory (called BLOCK 0) is used when sampling in the 1-sound mode. In the 2-sound mode, the memory is split into 2 parts (BLOCK 1 and BLOCK 2). Different sounds can be sampled for each part of the memory in this case.

There are different Sampling Modes, Auto-Sampling and Manual Sampling. When using Auto-Sampling, sounds are sampled automatically as soon as they are input. This is useful for sampling sounds which have a strong attack. With Manual Sampling, sounds are only sampled when an instrument key is pressed. This is useful when sampling sounds with a weaker attack.

The Sampling Clock can be adjusted within a range of 0~127. Its relationship to Sampling Time is shown in the upper diagram.

★ Sampled sounds can be tuned within a 2 octave range. The relationship between tuning and the Sampling Clock setting is shown in the example to the right.

Relationship between Sampling Clock and Sampling Time

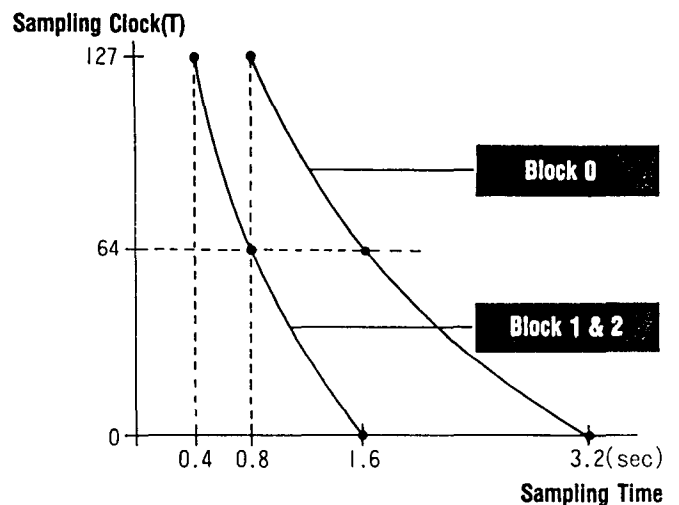

Tuning Range of Sampled Sounds (EX)

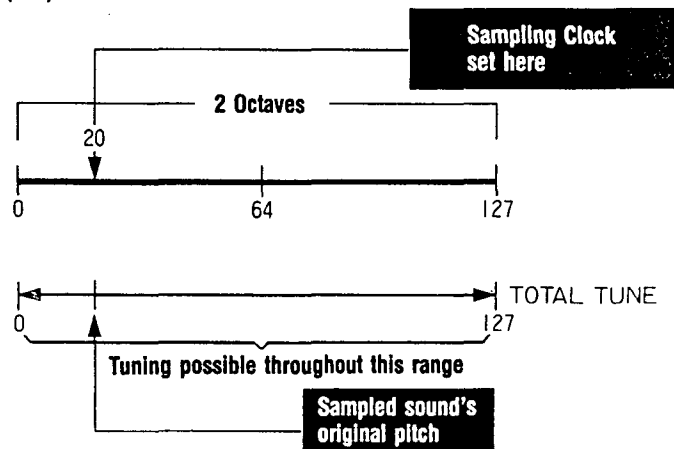



2. System Setting Actual Operation



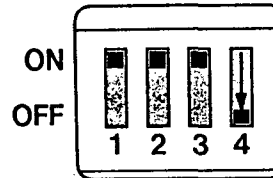



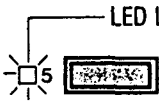











NOTE:

Set the rear panel DIP Switch bit 4 ("PROTECT") to OFF before performing the following procedures.

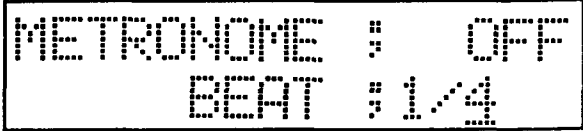

OPERATION	LCD & LED DISPLAY
<p>Specify SYSTEM SETTING, by pressing MODO SELECT KEY "f.5".</p> <p>Press <input type="checkbox"/>5  </p>	 LED Lights

1 METRONOME SETTING

<p>① Specify METRONOME, by pressing FUNCTION SELECT KEY "f.1".</p> <p> f.1  <input type="checkbox"/> METRONOME </p> <p>Press</p>	
<p>② Specify the METRONOME BEAT via the ten key pad or -1/NO and +1/YES keys.</p> <p>Press  (Set according to mark at upper right of key)            </p> <p>(METRONOME BEAT may be set as soon as unit is set to METRONOME.)</p>	 <p>Metronome Beat Changes </p>

③ Move the CURSOR by pressing the CURSOR KEY.

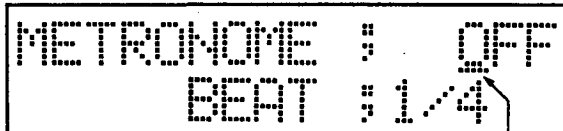

Cursor Moves

④ Specify ON or OFF via the +1/YES or -1/NO key.

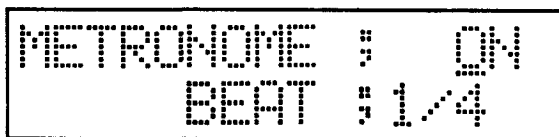

- This operation turns the Metronome Sound ON and OFF during playback. It is always set to ON during recording.

2 SETTING TRIGGER ASSIGN

- ① Specify TRIGGER ASSIGN, by pressing FUNCTION SELECT KEY "f.2".

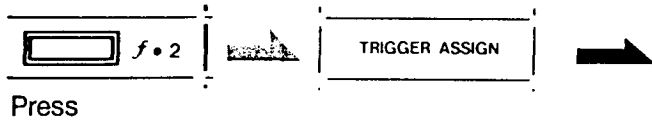

TRIGGER ASSIGN
IN←E: / OUT←E:

Present value displayed.

- ② Specify the INST KEY to be controlled (triggered) by the signal input via the AUDIO IN jack on the rear panel.
(INST KEY "D", in this case)

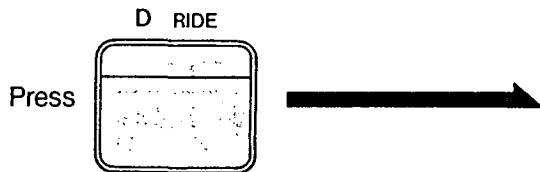

(INST KEY to be controlled by Trigger. In can be specified as soon as TRIGGER ASSIGN is selected.)

TRIGGER ASSIGN
IN←D: / OUT←E:

INST KEY newly set.

- ③ Move the CURSOR by pressing the CURSOR KEY.



TRIGGER ASSIGN
IN←D: / OUT←E:

CURSOR Moves.

- ④ Specify the key which will control trigger output via the rear panel TRIG OUT jack.
(INST KEY "C", in this case).

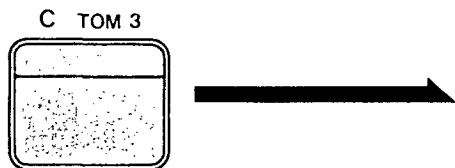

TRIGGER ASSIGN
IN←D: / OUT←C

INST KEY newly set.

3 CLOCK SETTING

① Specify CLOCK, by pressing FUNCTION SELECT KEY "f.3".

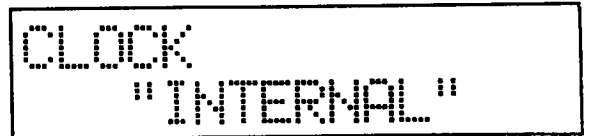
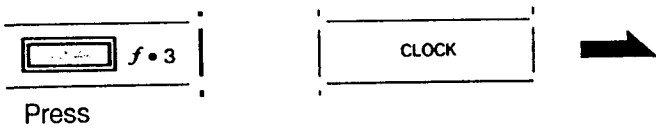

② Pressing the +1/YES and -1/NO keys changes the CLOCK MODEs shown below.

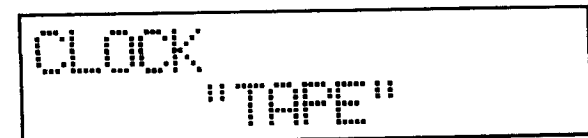
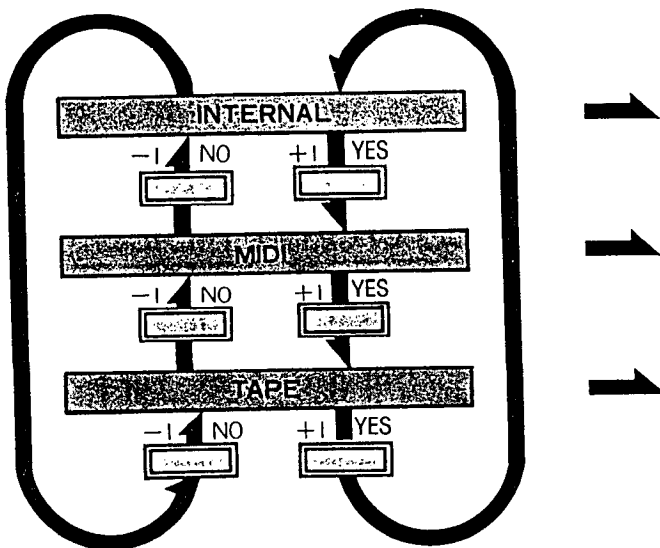

The display appears as shown at the right when the clock is set "MIDI" or "TAPE ."



SYSTEM SETTING

4 SETTING MIDI RECEIVE

- ① Specify MIDI RECEIVE, by pressing FUNCTION SELECT KEY "f-4".

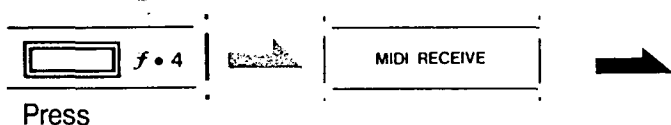

MIDI RECEIVE
NOTE: AVAILABLE

- ② Subsequently pressing the f-4 key causes the display to change as shown below, enabling selection of MIDI RECEIVE parameters.

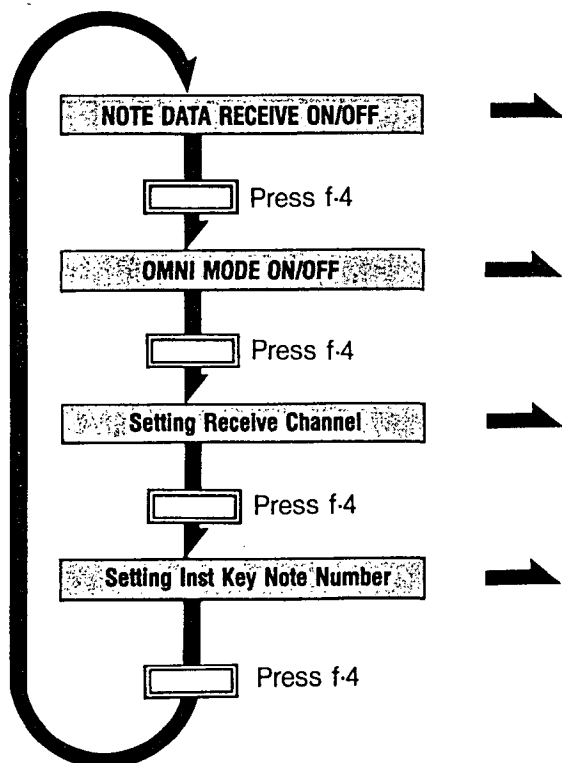

MIDI RECEIVE
NOTE: AVAILABLE

MIDI RECEIVE
OMNI MODE: ON

MIDI RECEIVE
CHANNEL: 01

MIDI RECEIVE
INST NOTE:

(NOTE DATA RECEIVE ON/OFF can be set as soon as unit is set to MIDI RECEIVE.)

③ NOTE DATA RECEIVE ON/OFF (available/unavailable) can be set by pressing the +1/YES for ON, or the -1/NO key for OFF.

Press →

MIDI RECEIVE
NOTE: AVAILABLE

Press →

MIDI RECEIVE
NOTE: UNAVAILABLE

④ Select OMNI MODE ON/OFF by repeating step ②. Specify ON or OFF via the +1/YES or -1/NO key.

Press →

MIDI RECEIVE
OMNI MODE: ON

Press →

MIDI RECEIVE
OMNI MODE: OFF

⑤ Select RECEIVE CHANNEL SPECIFY by repeating step ②. Specify the desired channel via the ten key pad or +1/YES and -1/NO keys.

Press

7	1/32	8	1/32T	9	HIGH
<input type="button"/>	<input type="button"/>	<input type="button"/>	<input type="button"/>	<input type="button"/>	<input type="button"/>
4	1/8T	5	1/16	6	1/16T
<input type="button"/>	<input type="button"/>	<input type="button"/>	<input type="button"/>	<input type="button"/>	<input type="button"/>
1	1/4	2	1/4T	3	1/8
<input type="button"/>	<input type="button"/>	<input type="button"/>	<input type="button"/>	<input type="button"/>	<input type="button"/>
-1	NO	0		+1	YES
<input type="button"/>	<input type="button"/>	<input type="button"/>	<input type="button"/>	<input type="button"/>	<input type="button"/>

 →

MIDI RECEIVE
CHANNEL: 02

MIDI RECEIVE CHANNEL Changes

SYSTEM SETTING

- ⑥ Select RECEIVED NOTE NUMBER SETTING by repeating step ②. Specify by pressing the selected Inst Key (For Inst key "J").

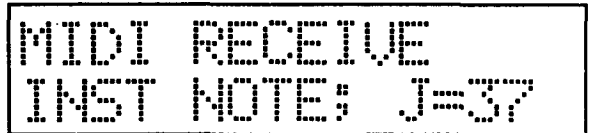
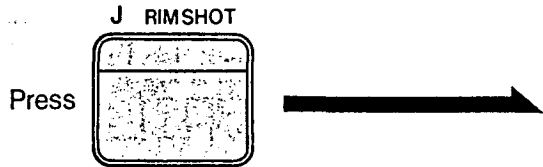

Specified INST KEY ———
Present NOTE NUMBER ———

- ⑦ Set the NOTE NUMBER by pressing the ten key pad or +1/YES and -1/NO keys.

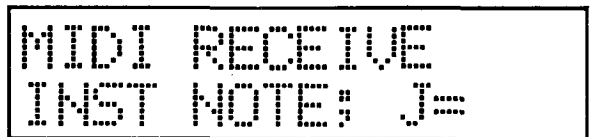
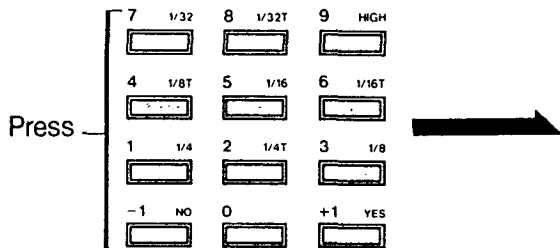

Note Number Changes ———

5 SETTING MIDI TRANSMIT

① Specify MIDI TRANSMIT, by pressing FUNCTION SELECT KEY "f-5".



MIDI TRANSMIT
NOTE; UNAVAILABLE

② Subsequently pressing the f-5 key causes the display to change as shown below, enabling selection of MIDI TRANSMIT parameters.

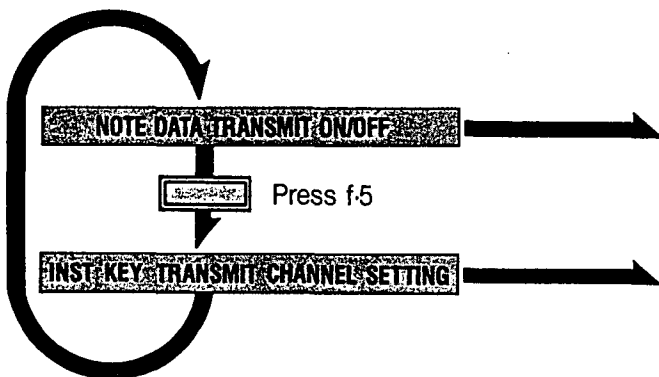

MIDI TRANSMIT
NOTE; AVAILABLE

MIDI TRANSMIT
INST CH; [grid icon]

(NOTE DATA TRANSMIT ON/OFF can be set as soon as unit is set to MIDI TRANSMIT.)

③ Specify ON (available) or OFF (unavailable) by pressing the +1/YES or -1/NO keys.



MIDI TRANSMIT
NOTE; AVAILABLE



MIDI TRANSMIT
NOTE; UNAVAILABLE

- ④ Select INST KEY TRANSMIT CHANNEL SETTING by repeating step ② Then press the selected INST KEY.
(INST KEY "K", in this case)

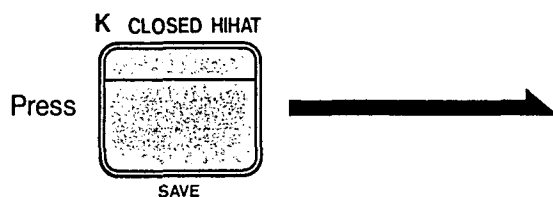

MIDI TRANSMIT
INST CH: K= 01

- ⑤ Set the TRANSMIT CHANNEL via the ten key pad or +1/YES and -1/NO keys.

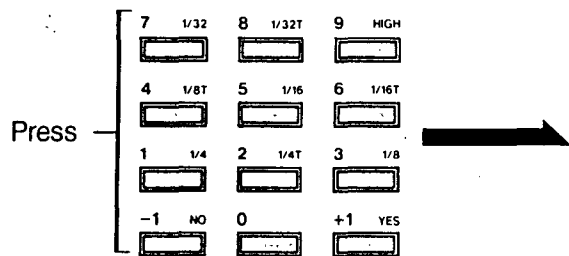

MIDI TRANSMIT
INST CH: K=

MIDI Channel Changes

⑥ SAMPLING SET PROCEDURES

- ① Connect the rear panel AUDIO IN jack to the output jack of a selected instrument or audio unit.

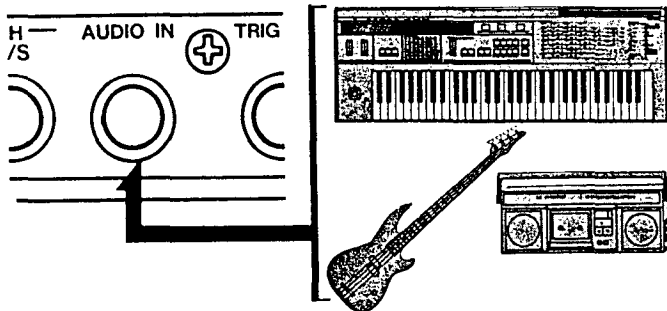

Sampling Sound Sources can now be assigned to INST Keys, via INST ASSIGN (p.34).

- ② Specify SAMPLING SELECT, by pressing FUNCTION SELECT KEY "f.6".

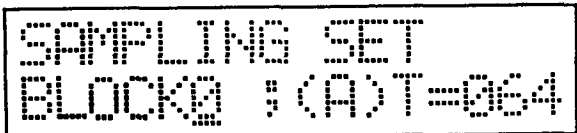
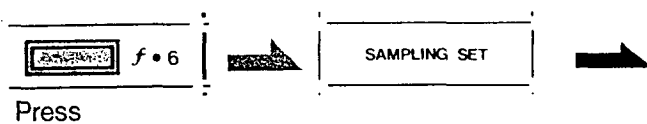

- ③ Select either the 1-sound or 2-sound Sampling Mode. With the CURSOR in the BLOCK position, select BLOCK 0 for 1-sound sampling, or BLOCKS 1 or 2 for 2-sound sampling, via the +1/YES and -1/NO keys.

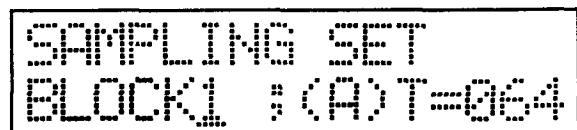

Set to BLOCK 1

SYSTEM SETTING

- ④ Move the CURSOR to the SAMPLING START position on the display by pressing the CURSOR KEY.

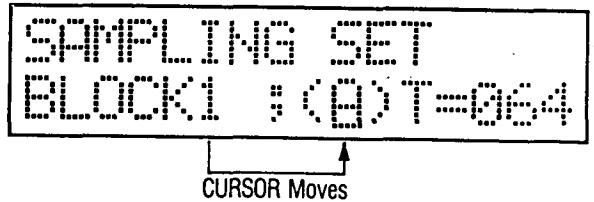

- ⑤ Choose Auto Sampling Start or Manual Sampling Start by pressing the +1/YES or -1/NO keys. "A" represents Auto Start, while "M" stands for Manual.

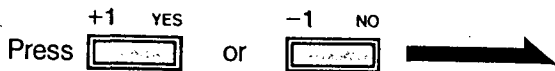

- ⑥ Move the CURSOR to the Sampling Clock position by pressing the CURSOR Key.

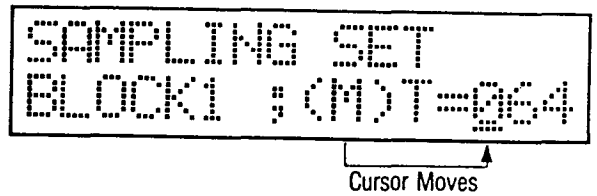

- ⑦ Set the Sampling Clock via the DATA SLIDER or the +1/YES and -1/NO keys.

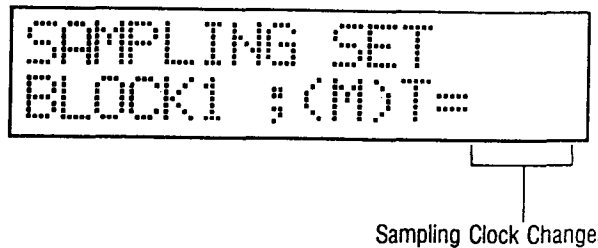
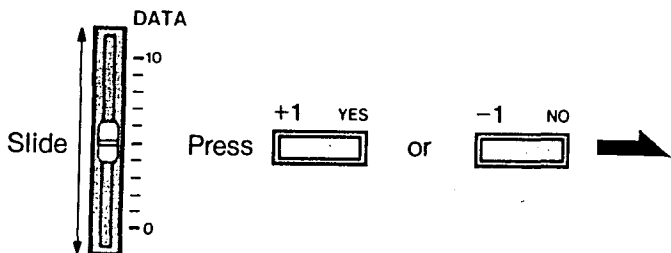

⑧ Pressing FUNCTION SELECT KEY "f-6" puts Sampling on STANDBY.

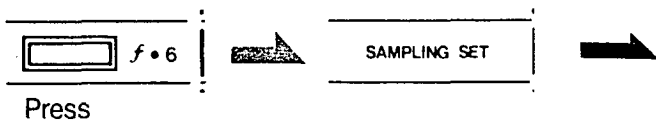

Press

If power is turned OFF in the STANDBY state, Sampled Sounds are all erased, even if Sampling has been completed for a single BLOCK.

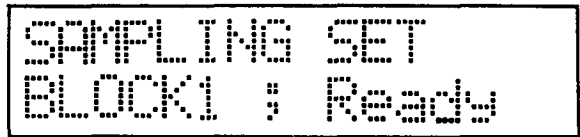

Sampling on Standby

- Pressing FUNCTION SELECT KEY "f-6" once more cancels Standby, and operation returns to step ②.
- Sampling is started automatically when a sound is input, if set to Auto Sampling Start. AUTO/MANUAL Sampling Start remains in effect even if another function is selected while in the Standby state.
- Proceed to step ⑦ when performing Manual Sampling Start.
- ★ In this state, TRIG IN (p.91) cannot be utilized.

⑨ When the INST KEY to which the Sampling Sound Source is assigned is pressed, sampling begins.

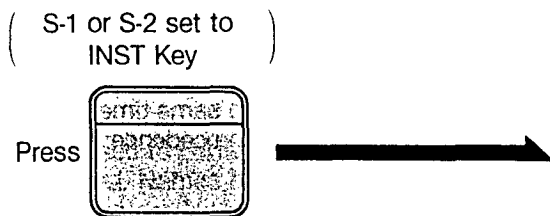

Press

- Sampling begins when the INST KEY to which "S-1" is assigned is pressed, when BLOCK 1 has been selected in step ③.
- Sampling begins when the INST KEY to which "S-2" is assigned is pressed, when BLOCK 2 has been selected in step ③.
- Sampling begins when the INST KEY to which "S-1" and "S-2" assigned is pressed, when BLOCK 0 has been selected in step ③.

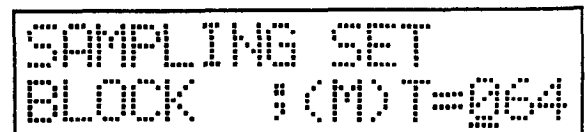
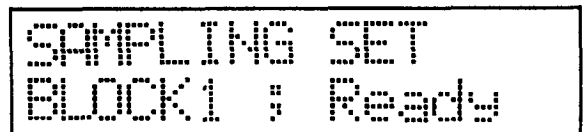

Operation returns to ⑦ when sampling is completed.

- After completing procedures for one BLOCK, Sampling can be performed for the second block by repeating procedures from step ③, when Sampling in the 2-sound Sampling Mode. For example, when you have completed sampling BLOCK 1, you may return to step ③ to complete sampling for BLOCK 2.
- Sound sampled in BLOCK 0 is erased when sampling is performed in either BLOCK 1 or BLOCK 2.

SYSTEM SETTING

- Sampling sounds can now be produced by tapping INST KEYS to which S-1 or S-2 have been set.

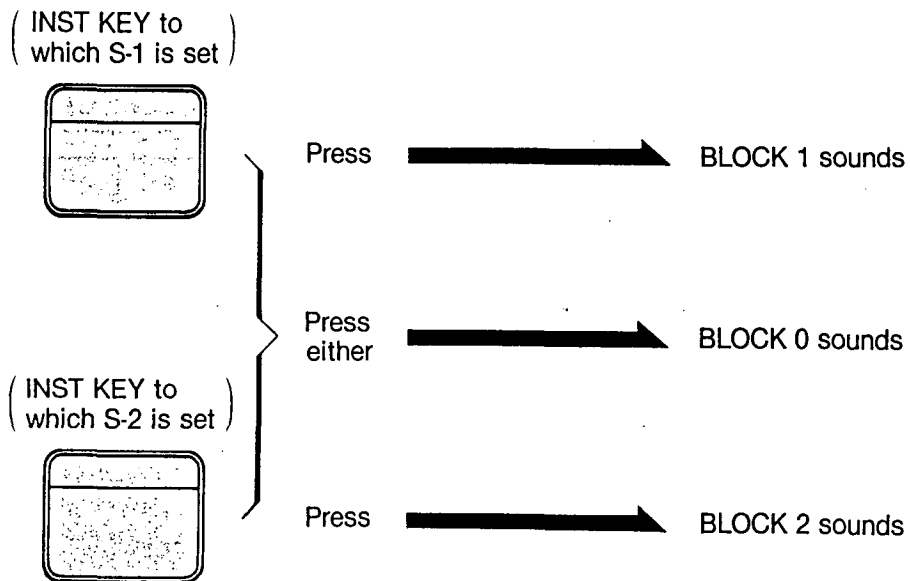

NOTE:

BLOCKS 1 & 2 are divisions of BLOCK 0, so it is impossible to sound them all at the same time. It is also impossible to sound BLOCK 1 and BLOCK 2 simultaneously. The last key pressed has precedence.

DATA TRANSFER

1. Data Transfer

DDD-1 memory can be preserved on RAM cards or tape recorders. This mode controls the input and output of the DDD-1's memory data. This memory data can be treated as MIDI System Exclusive Messages, so transfer between another DDD-1, SQD-1 or other device is also possible. This entire process is known as DATA TRANSFER. The four keys illustrated below are used to carry out the 3 DATA TRANSFER OPERATION - SAVE, VERIFY, and LOAD.

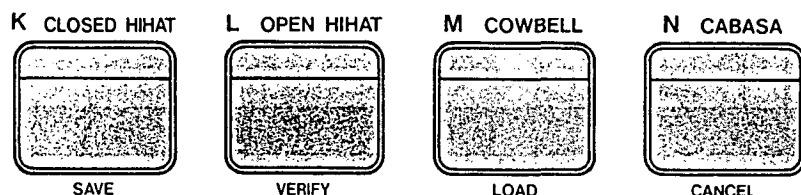

SAVE:

SAVE operations are utilized to preserve memorized data on RAM card, tape or disk.

VERIFY:

VERIFY operations are carried out to confirm that data SAVE (or LOAD) operations were completed correctly.

LOAD:

LOAD operations are used to load data which is contained on RAM card, tape or disk into the DDD-1 memory.

CANCEL:

This cancels SAVE, VERIFY or LOAD operations.

■ RAM CARD

This function is used to perform DATA TRANSFER utilizing a RAM card. Names can be given to individual data, up to 8 letters long, for easy identification. Also, a Protect Switch is featured on RAM cards, to prevent accidentally erasure of information.

■ TAPE

This function is used to perform DATA TRANSFER utilizing cassette tapes. Names can be given to data, up to 8 letters long.

■ MIDI

Utilizing System Exclusive Messages, DATA TRANSFER between the DDD-1 and computers or other MIDI devices is carried out via this function.

DDD-1 data can be preserved in the SQD-1's Quick Disk, when connected to an SQD-1.



■ ROM CARD CHECK

The number of sound sources can be increased when using the optional ROM Card with the DDD-1. When using the ROM Card, it is necessary to perform the ROM CARD CHECK procedure, to inform the DDD-1 that the card is in use, after inserting the card in the ROM CARD SLOT. (This procedure is carried out automatically when power is turned ON.)

2. Data Transfer Actual Operations

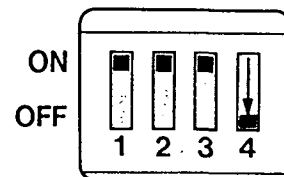
NOTE:
When performing a LOAD via DATA TRANSFER, set DIP Switch number 4 "PROTECT" to the OFF position.

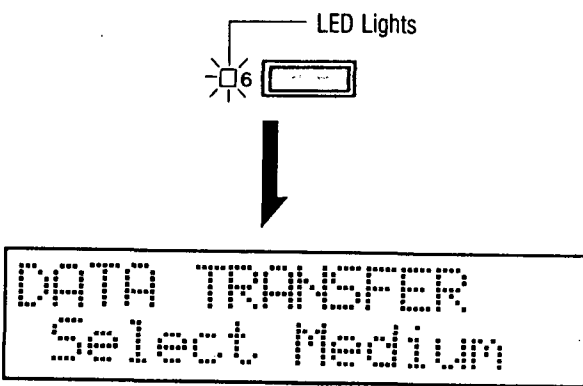

OPERATION	LCD & LED DISPLAY
<p>Specify the DATA TRANSFER MODE by pressing MODE SELECT KEY "6".</p> <p>Press <input type="checkbox"/> 6  </p> <p>"Select Medium" is displayed, enabling selection of RAM Card, tape or MIDI.</p>	

1 DATA TRANSFER Using a RAM CARD

① Insert a RAM Card in the RAM CARD SLOT.

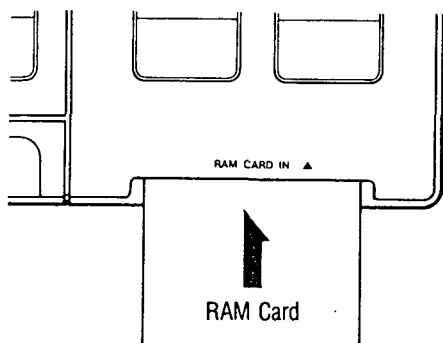

② Specify RAM CARD, by pressing FUNCTION SELECT KEY "f.1".



Press

```
DATA TRANSFER
*RAM*: DATA-001
```

Name of Data on RAM Card.

```
DATA TRANSFER
*RAM*: No Card.
```

● Display before RAM Card is inserted (Insert RAM Card).

```
DATA TRANSFER
*RAM*: OTHER CARD
```

● Display when a RAM Card other than the DDD-1 RAM Card is inserted.

```
DATA TRANSFER
*RAM*: ****
```

● Unused RAM Card is inserted.

● RAM Card other than KORG RAM Card is inserted.

SAVE OPERATIONS

① Press the SAVE Key (INST Key: K)

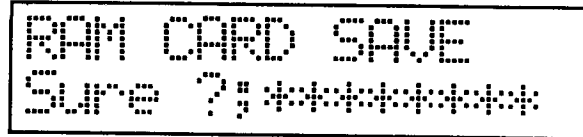
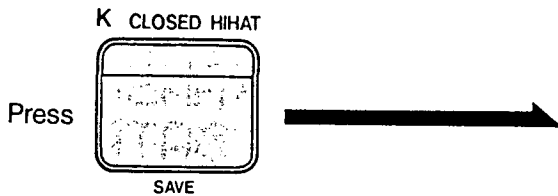

② Next, assign a name to the data you intend to save. Move the CURSOR by pressing the CURSOR key.

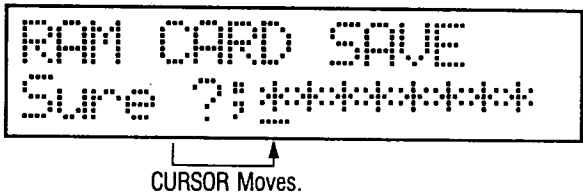

③ Select desired characters via the DATA SLIDER or +1/YES and -1/NO keys.

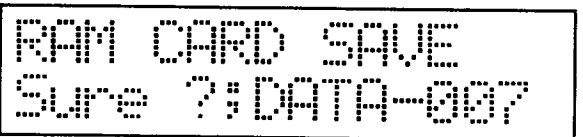
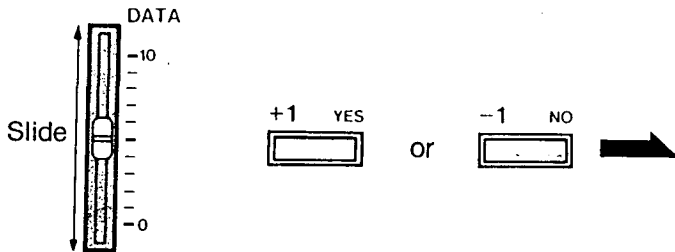

● Characters which may be selected are as listed on "Pattern Name" page 74.

Repeat steps ② and ③ to complete the desired Name, up to 8 characters per name.

④ Return the CURSOR to its original position by pressing the CURSOR KEY.

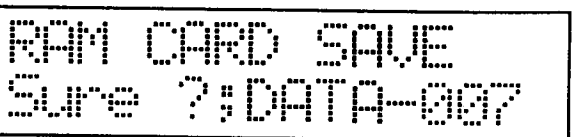

⑤ SAVE is carried out by pressing the +1/YES key, and cancelled by pressing the -1/NO key.

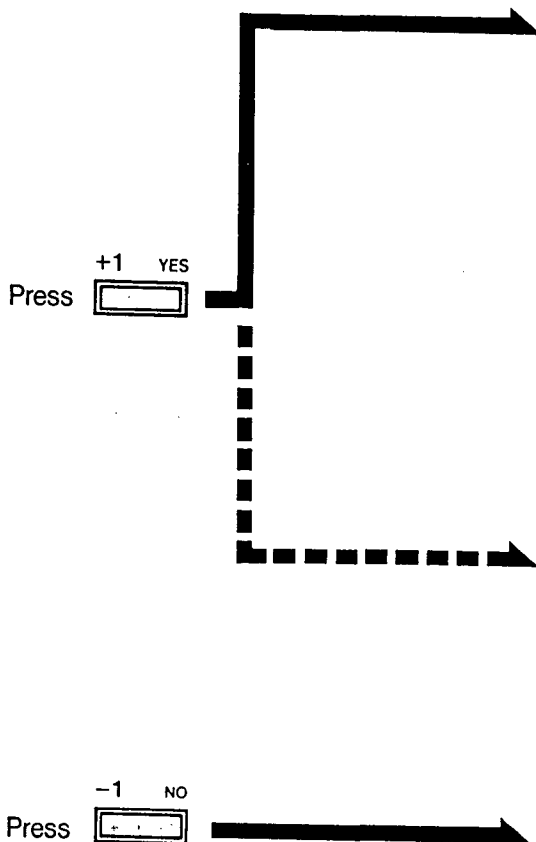

RAM CARD SAVE
Execute!



RAM CARD SAVE
Finish.

"Finish" displayed after approx. 1 second.

RAM CARD SAVE
Error End.

If RAM Card PROTECT is set to ON, or the wrong card is inserted, the display appears as above.

DATA TRANSFER
RAM;

● Pressing the CANCEL KEY (INST KEY: N) cancels SAVE operation.

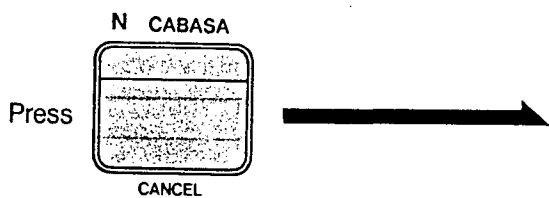

RAM CARD SAVE
Cancel End.

VERIFY OPERATION

① Press the VERIFY KEY (INST KEY: L).

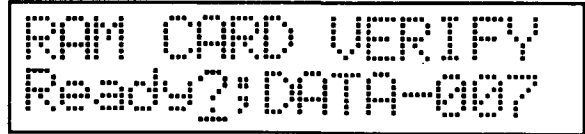
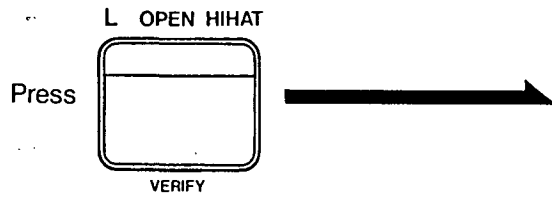

Name of data to be verified displayed.

② Respond to the "Ready ?" inquiry via the +1/YES key to carry out VERIFY.
Pressing the -1/NO key cancels the VERIFY procedure.

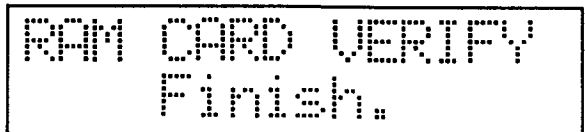
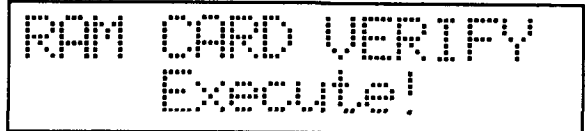
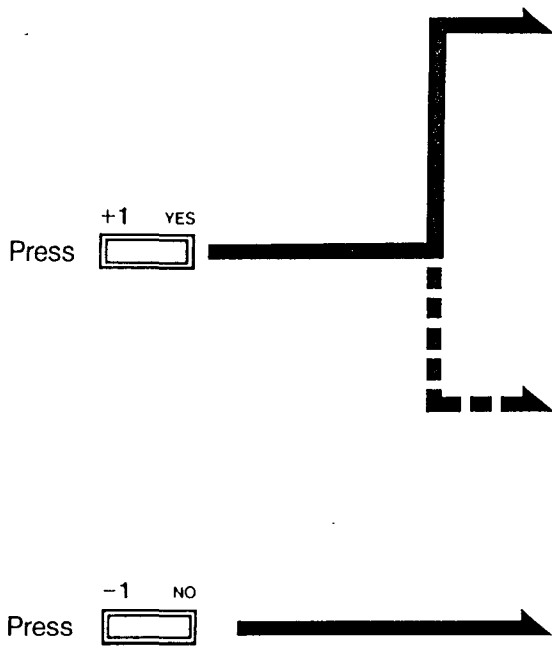

"Finish" displayed after approx. 1 second.

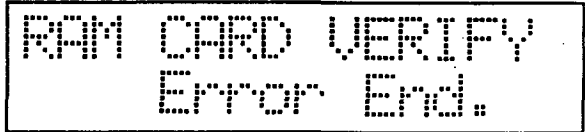

If data was transferred incorrectly or a data error is found then the display appears as above.



• VERIFY can be cancelled by pressing the CANCEL KEY (INST KEY: N).

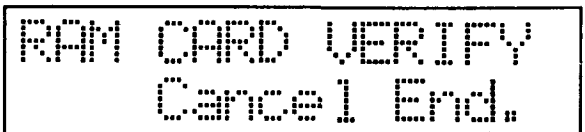
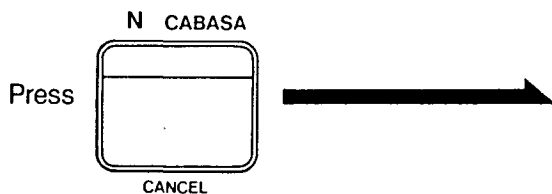

LOAD OPERATION

① Press the LOAD KEY (INST KEY: M).

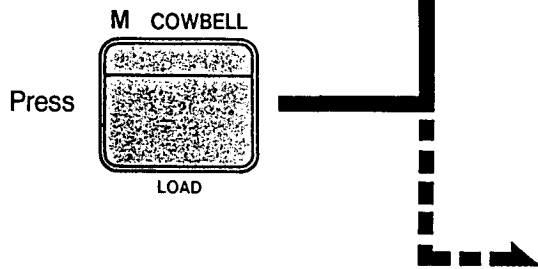

RAM CARD LOAD
Sure ?; DATA-007

Name of data to be loaded is displayed.

RAM CARD LOAD
PROTECT ON!

The above display indicates the rear panel "PROTECT" DIP switch is ON. Operation returns to ②. (Turn OFF DIP Switch repeat operation.)

② Respond to the "Sure ?" inquiry via the +1/YES key to carry out the LOAD operation.
LOAD is cancelled by pressing the -1/NO key.

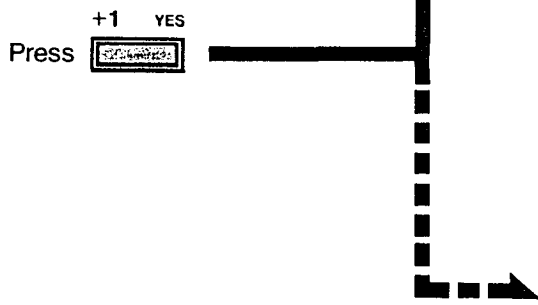

RAM CARD LOAD
Execute!

RAM CARD LOAD
Finish.

"Finish" displayed after approx. 1 second.

RAM CARD LOAD
Error End.

The above display indicates a problem during LOAD. Check the RAM Card and repeat from step ①.

DATA TRANSFER

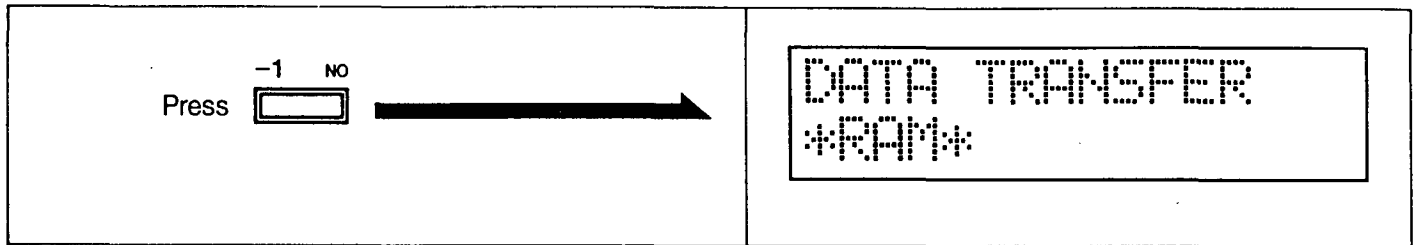

- LOAD can be cancelled by pressing the CANCEL KEY (INST KEY: N).

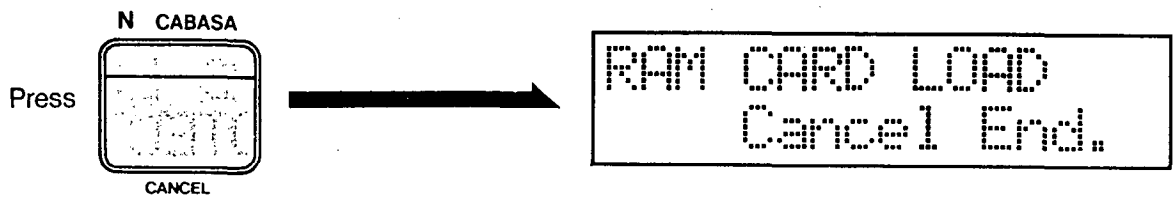

② DATA TRANSFER Utilizing CASSETTE TAPE

① Connect a tape recorder to the rear panel TAPE Jack.

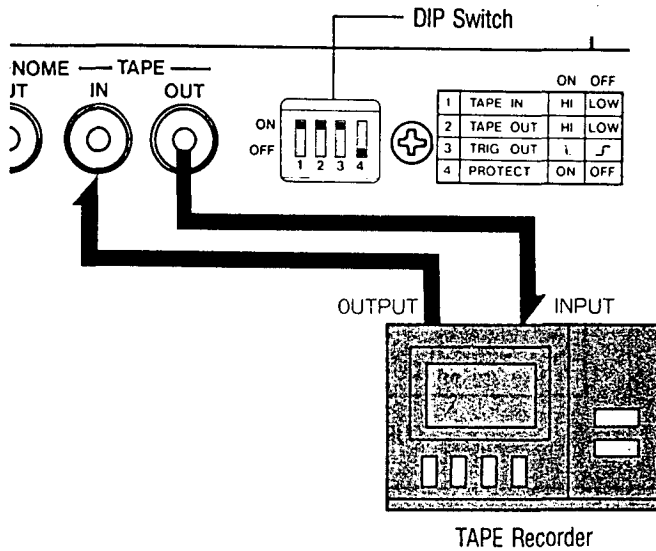

Set DIP Switches 1 & 2, according to the tape recorder used.

Tape Recorder Jack		DIP Switch Position	
INPUT	MIC	LOW	DIP Switch 2
	AUX LINE IN	HI	
OUTPUT	LINE OUT	LOW	DIP Switch 1
	PHONE	HI	

② Specify TAPE, by pressing FUNCTION SELECT KEY "f.2".

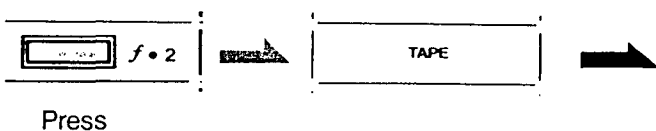

DATA TRANSFER
TAPE

SAVE OPERATION

① Press the SAVE KEY (INST KEY: K).

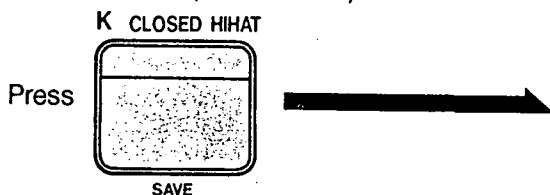

```
TAPE SAVE
Ready?
```

② Next, assign a name to the data you intend to save. Move the CURSOR by pressing the CURSOR KEY.



```
TAPE SAVE
Ready?;
```

CURSOR Moves

③ Select desired characters via the DATA SLIDER or +1/YES and -1/NO keys.

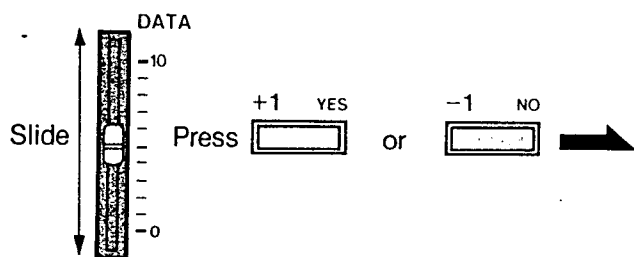

● Characters which may be selected are as listed on page.

```
TAPE SAVE
Ready?;DATA-50?
```

Name of data to be LOAD

Repeat steps ② and ③ to complete the desired Name, up to 8 characters per name.

④ Return the CURSOR to the Ready? position by pressing the CURSOR KEY.



```
TAPE SAVE
Ready?;DATA-50?
```

Cursor Moves

⑤ Press the +1/YES key.



```
TAPE SAVE
Sure ?;DATA-50?
```

⑥ Set the tape recorder to RECORD, and press the pause button. At this time, a signal is output via the TAPE OUT jack for recording level adjustment at the tape recorder. Adjust as necessary.

⑦ Release the tape recorder PAUSE button and press the +1/YES key. (Be sure the tape's leader section has passed the tape heads before starting the DDD-1 transmission.) Pressing the -1/NO Key cancels SAVE.



● Perform DATA TRANSFER onto tape at least two or three times to guarantee safe preservation of data. Then carry out VERIFY procedures, as described on page 120.

TAPE SAVE
Execute!



TAPE SAVE
Finish.

Indicates SAVE is completed.

DATA TRANSFER
TAPE

● SAVE can be cancelled by pressing the CANCEL KEY (INST KEY: N).

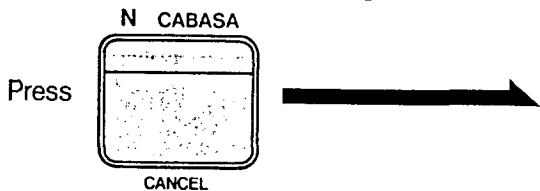

TAPE SAVE
Cancel End.

■ If you listen to a tape of recorded data, you will hear the following tones:

LEVEL SET TONE (lower pitched "oooh...")



LEADER TONE (high-pitched "eee...")



DATA TONE (medium-pitched "noise")



END TONE (high-pitched "eee...")

LEADER TONE : Indicates the start of VERIFY and LOAD operations.

DATA TONE : Actual digitalized data from the DDD-1, such as PATTERN data, SONG data, INST Settings, etc.

END TONE : Indicates the end of the operation.

VERIFY OPERATION

① Press the VERIFY KEY (INST KEY: L).

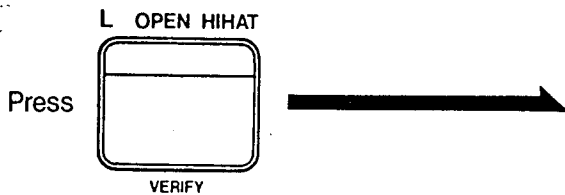

When more than one piece of DATA is stored on the same tape, you can specify which piece is to be Verified, by name. When performing VERIFY without specifying the data name, proceed to step ⑤. The first data encountered is verified in this case.

② Specify the name of the data to be verified. Move the CURSOR by pressing the CURSOR KEY.

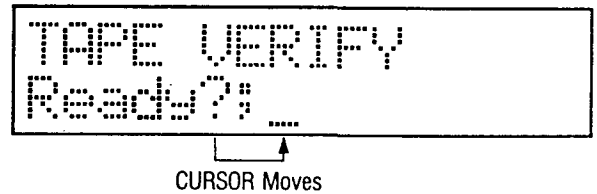

③ Input the name of the data to be verified via the DATA SLIDER or +1/YES and -1/NO keys.

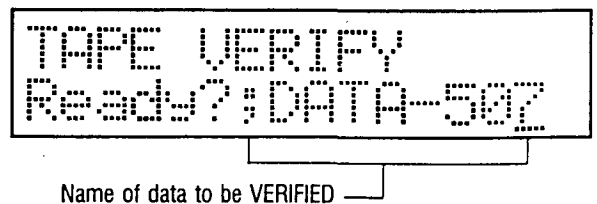
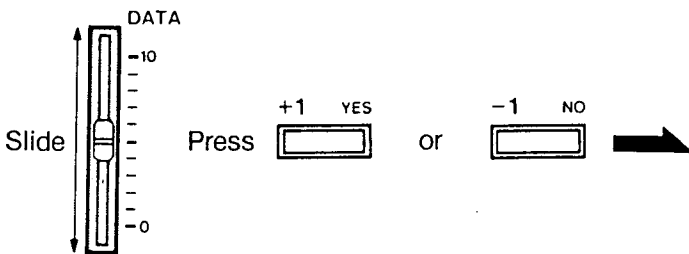

Repeat steps ② and ③ to specify the names of all data to be verified.

④ Return the CURSOR to the "Ready?" position by pressing the CURSOR KEY.



```
TAPE VERIFY
Ready?;DATA-507
```

 CURSOR Moves

⑤ Set the tape recorder to PLAY, and press the +1/YES key. Pressing the -1/NO key cancels VERIFY.



```
TAPE VERIFY
Search;DATA-507
```

When name is specified

When name is not specified

```
TAPE VERIFY
Pass ;DATA-325
```

Data encountered is not specified

```
TAPE VERIFY
Find ;DATA-507
```

Specified data found, VERIFY executed.

```
TAPE VERIFY
Finish.
```

DATA TRANSFER

- If a FIND or PASS message is not displayed within 10 seconds after starting the tape recorder it may indicate that the volume is set to low. Raise the volume and try VERIFY procedures again.
- If an ERROR END message is displayed, as shown at the right, it may also indicate a volume problem. Raise or lower volume and try VERIFY procedures again.

Press -1 NO

TAPE VERIFY
Error End.

DATA TRANSFER
TAPE

VERIFY Cancelled.

- VERIFY can be cancelled by pressing the CANCEL KEY (INST KEY: N).

Press  CANCEL

TAPE VERIFY
Cancel End.

NOTE:

VERIFY is used to confirm that the data which is SAVED is the same as that in the DDD-1 memory. If DDD-1 memory contents are altered after SAVE then an ERROR END message will result when VERIFY is subsequently performed. Also, if VERIFY does not reach the FINISH stage even after being performed a number of times, it may indicate a problem with volume level. Raise or lower the volume and try VERIFY procedures until the FINISH message is achieved.

LOAD OPERATION

① Press the LOAD KEY (INST KEY: M).

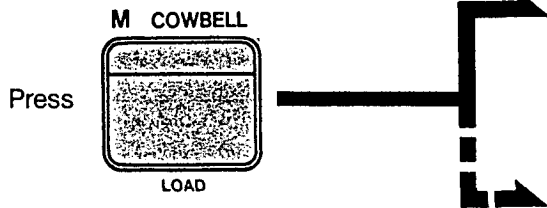

TAPE LOAD
Ready?

TAPE LOAD
PROTECT ON!

Indicates DIP SW 4 " PROTECT is set to ON. Turn it OFF.

When more than one piece of DATA is stored on the same tape, you can specify which piece is to be LOADED, by name. When LOADING without specifying data name, proceed to step ⑤.

② Specify the name of the data to be loaded. Move the CURSOR by pressing the CURSOR KEY.



TAPE LOAD
Ready? █

CURSOR Moves

③ Input the name of the data to be loaded via the DATA SLIDER or +1/YES and -1/NO keys.

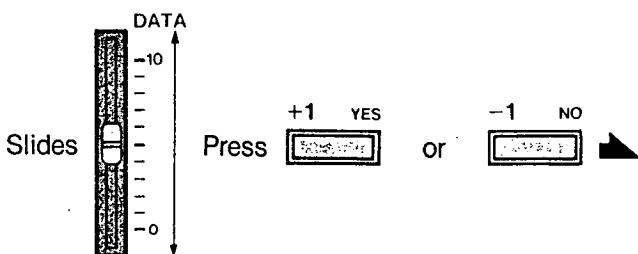

TAPE LOAD
Ready? DATA-502

Name of data to be LOAD

● Characters which may be selected are as listed on "Pattern Name" page 74.

Repeat steps ② and ③ to specify the names of all data to be loaded.

DATA TRANSFER

- ④ Return the CURSOR to the "Ready?" position by pressing the CURSOR KEY.

Press  

```
TAPE LOAD
Ready?; DATA-507
```

CURSOR Moves

- ⑤ Press the +1/YES key.

Press  

```
TAPE LOAD
Sure ?; DATA-507
```

- ⑥ Set the tape recorder to PLAY, and press the +1/YES key.
Pressing the -1/NO key cancels LOAD.

Press  

```
TAPE LOAD
Search; DATA-507
```

When name is specified

When name is not specified

```
TAPE LOAD
Pass ; DATA-325
```

Data encountered is not specified

```
TAPE LOAD
Find ; DATA-507
```

Specified data found

```
TAPE LOAD
Finish.
```

- If a FIND or PASS message is not displayed within 10 seconds after starting the tape recorder, it may indicate that the volume is set too low. Raise the volume and try LOAD procedures again.

- If an ERROR END message is displayed, as shown at the right, it may also indicate a volume problem. Raise or lower volume and try VERIFY procedures again.



TAPE LOAD
Error End.

DATA TRANSFER
TAPE

LOAD Cancelled

- LOAD can be cancelled by pressing the CANCEL KEY (INST KEY: N).

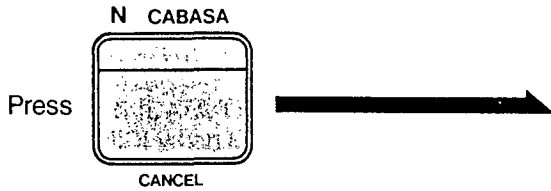

TAPE LOAD
Cancel End.

■ Points to Remember About Tape Interface

- 1 When using a stereophonic tape recorder, use the left channel only for the SAVE operation. If the right is used, VERIFY and LOAD operations cannot be performed with headphones connected.
- 2 Set tape recorder level as high as possible without distortion. If the level is too high or too low during SAVE, VERIFY and LOAD may become impossible.
- 3 If the tape recorder head is dirty, wow and flutter are excessive, or there are fluctuations in output (due to weak batteries etc.) SAVE, LOAD and VERIFY operation may not be correctly completed.
- 4 Do not vibrate the tape recorder by moving it, or change the output level settings during SAVE, LOAD or VERIFY.
- 5 Some cords and plug adaptors on the market contain resistors. Use of these during SAVE, LOAD or VERIFY may result in less than satisfactory operation.
- 6 Be sure to record data on a new tape, free from scratches or warping. Also, avoid storing the tape where it may be effected by magnetism, as data may become scrambled.
- 7 The volume range wherein VERIFY and LOAD can be performed is shown in the diagram below:

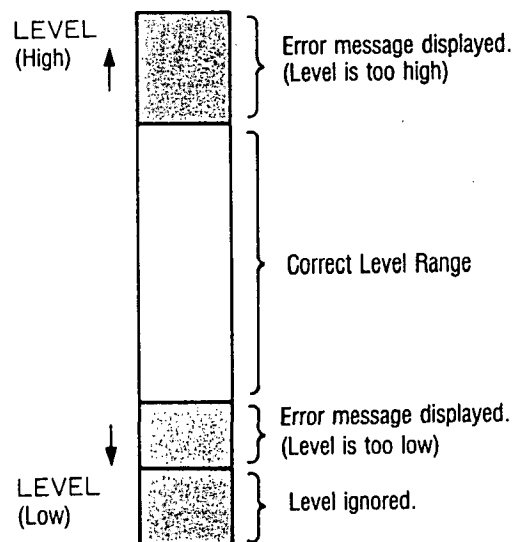

3 DATA TRANSFER VIA MIDI EXCLUSIVE MESSAGES

① Connect MIDI terminal (IN/OUT) with MIDI terminal of an SQD-1 or a computer MIDI interface.

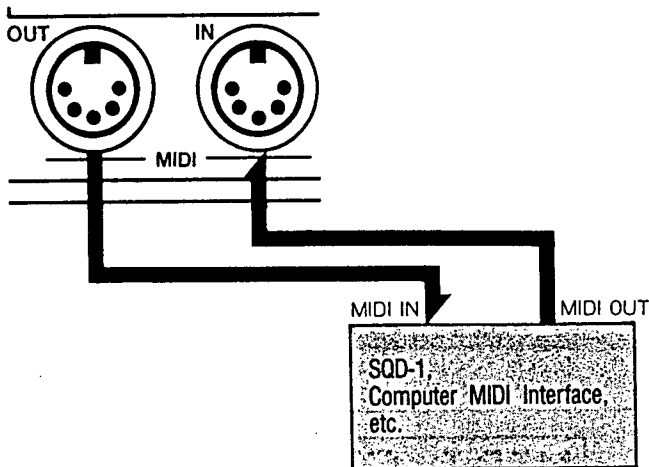

★ Software which is capable of handling MIDI Exclusive Messages must be used when connecting with a computer.

(Set DIP Switch 5 "DATA TRANSFER", on the SQD-1 rear panel, to MIDI when connecting the DDD-1)

② Specify MIDI, by pressing FUNCTION SELECT KEY "f.3".

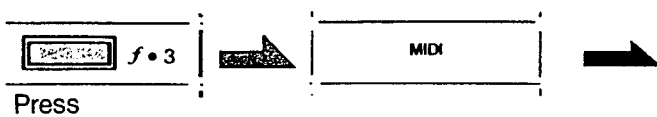

DATA TRANSFER
MIDI

● Refer to the SQD-1 Owner's Manual for information of SQD-1 operation P.114 ~ 115.

SAVE OPERATION

① Set the receiving device to LOAD STANDBY.

(When the SQD-1 is used as the receiving device, press the LOAD KEY while in the DATA TRANSFER mode.)

LoAd.

SQD-1 Display

② Press the SAVE KEY (INST KEY: K).

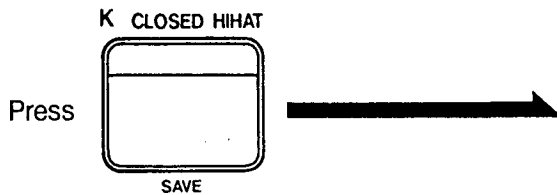

MIDI SAVE
Ready?

③ Respond to the "Ready?" inquiry via the YES or NO key.



MIDI SAVE
Execute!

MIDI SAVE
Finish.

SAVE Completed

FINISH.

SQD-1 also shows "FINISH"

- If the Receiving device is still in the LOAD status even though the DDD-1 display indicates FINISH, check MIDI cables for any irregularities, and try LOAD once again.



DATA TRANSFER
MIDI

SAVE Cancelled

- SAVE can be cancelled by pressing the CANCEL KEY (INST KEY: N).

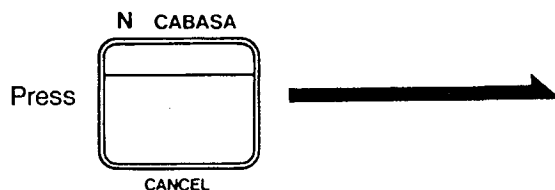

MIDI SAVE
Cancel End.

LOAD OPERATION

① Press the LOAD KEY (INST KEY: M).

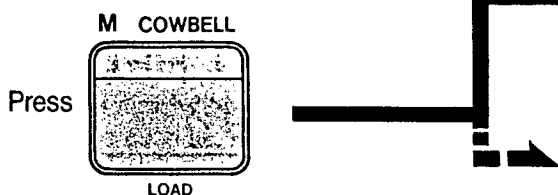

MIDI LOAD
Ready?

TAPE LOAD
PROTECT ON!

② Respond to the "Ready?" inquiry via the YES or NO key.

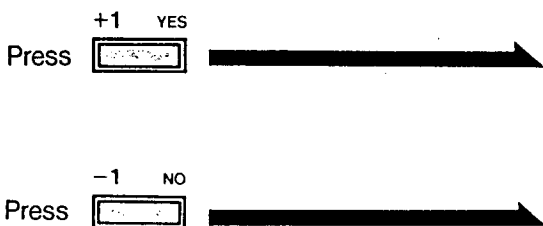

MIDI LOAD
Execute!

LOAD Standby

DATA TRANSFER
MIDI

LOAD Cancelled

③ SAVE data from the transmitting device.

(Data transmission begins when the SAVE key is pressed in the DATA TRANSFER mode.)

● If the DDD-1 does not display FINISH message, even though the transmitting device shows that the SAVE is completed, check MIDI cables for irregularities and try procedures again.

SAVE

SQD-1 display

FINISH

SAVE completed

MIDI LOAD
Finish.

"Finish" displayed on DDD-1 display when SAVE is completed.

● LOAD can be cancelled by pressing the CANCEL KEY (INST KEY: N).

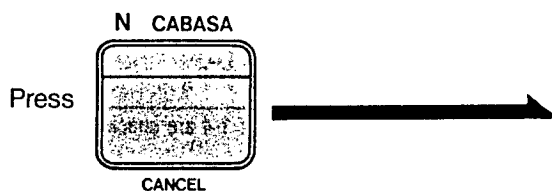

MIDI LOAD
Cancel End.

■ ROM CARD CHECK OPERATION

- ① Specify ROM CARD CHECK, by pressing FUNCTION SELECT KEY "f-8".



ROM CARD CHECK
Ready?

- ② Respond to the "Ready?" inquiry.
Press YES if the ROM CARD is in the ROM CARD SLOT, and NO if it is not.



ROM CARD CHECK
Card1; Check Now

CARD Being Check.

ROM CARD CHECK
Card1; OK!

CARD is in SLOT.

ROM CARD CHECK
Card1; No Card

CARD is not in SLOT.

ROM CARD CHECK
Card1; Error.

An incorrect CARD has been inserted.

ROM CARD CHECK
Finish.

Returns to top display after CARDS 1-4 are checked.

CONNECTION WITH OTHER DEVICES

1. Synchronization with other Drum Machines, Synthesizers, etc.

1 Synchronization with MIDI Drum Machines and MIDI Synthesizers.

The DDD-1 can be synchronized with other MIDI devices via messages such as TIMING CLOCK, START, STOP, CONTINUE, etc.

■ Using the DDD-1 to control another MIDI device (DDD-1 as Master, other device as Slave)

When the DDD-1 is started, a START message is transmitted to the Slave device, starting it at the same time. If DDD-1 tempo is changed, Slave tempo is also changed.

When the DDD-1 is stopped, a STOP message is transmitted to the Slave device, stopping it at the same time. To restart playback, Continue Start is used, however there are some cases wherein the Slave unit will not start simultaneously in this case, due to mutual processing difficulties. In these cases, it's necessary to transmit a Song Position Pointer when playback is interrupted.

★When certain measure is specified as the starting point for playback in the SONG PLAY/EDIT MODE, a Song Position Pointer is transmitted.

■ Using other MIDI Devices to control the DDD-1 (DDD-1 as Slave, other device as Master)

The DDD-1 will start simultaneously with the Master, when the Master start button is pressed.

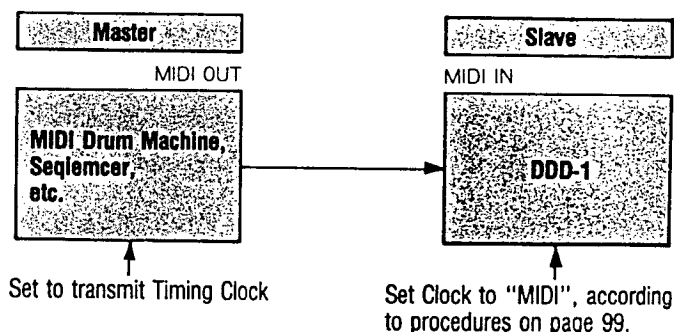
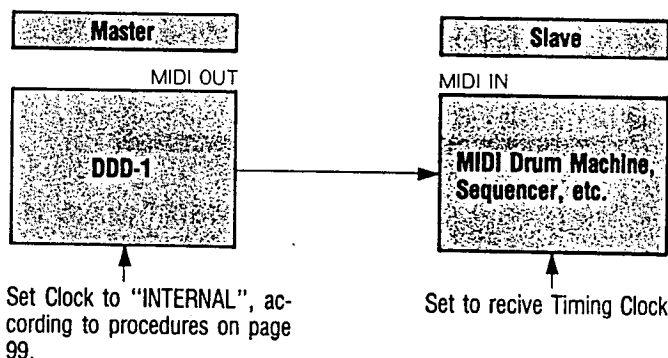

CONNECTION WITH OTHER DEVICES

2 Synchronization with Drum Machines Featuring SYNC Jack.

(MIDI Synchronizer KMS-30 must be used when synchronizing with Drum machines such as the DDM-110 and DDM-220.)

■ Using the DDD-1 to Control another Drum Machine via SYNC Jack (DDD-1 as Master)

The Slave unit reacts in sync, when the DDD-1 is Started, Stopped, or changes are made in Tempo. (Slave is not capable of Continue Start function.)

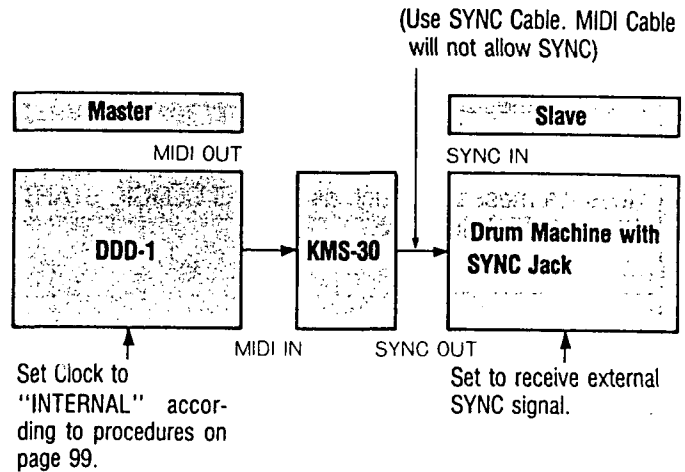

■ Using other Device with SYNC Jack to control the DDD-1 (DDD-1 as Slave)

When the DDD-1 START KEY is pressed, the unit is set to Start Standby. The DDD-1 will start simultaneously with the Master, when the master start button is pressed.

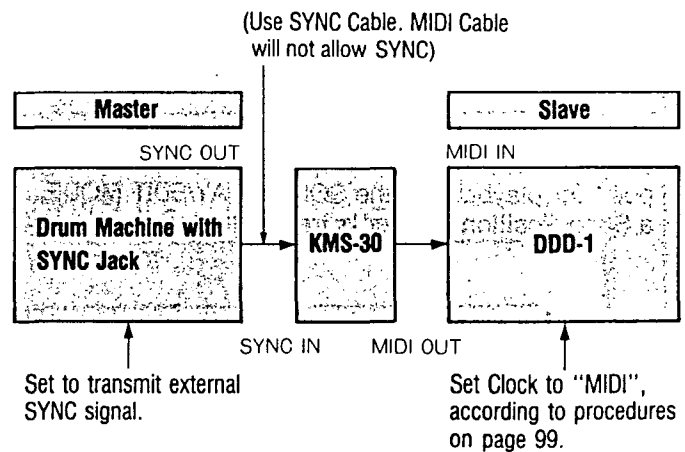

③ TAPE SYNC PROCEDURES

Tape Sync allows you to record a TAPE SYNC Signal from the DDD-1 on a tape recorder, and then use the taped signal to operate the DDD-1 in SYNC with the tape recorder. This function is extremely useful when recording tracks on a MTR. It allows efficient & effective use of a limited number of tracks.

■ TAPING A TAPE SYNC SIGNAL

- ① Connect the DDD-1 TAPE OUT jack to the input jack of a tape recorder. Set the DDD-1 clock to "INTERNAL".

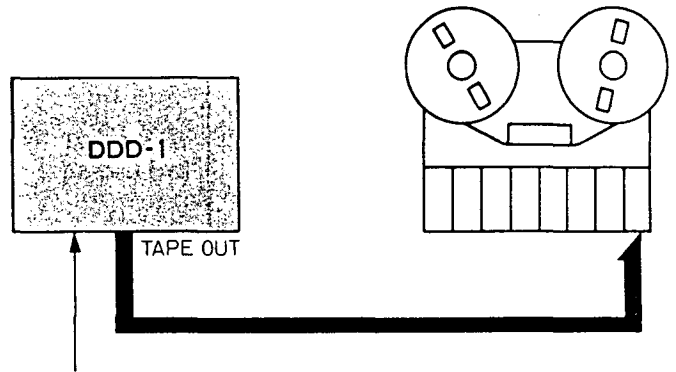

Set clock to "INTERNAL" according to instructions on page 99.

- ② Set the tape recorder to RECORD, and press the pause button. The DDD-1 outputs a Lead Tone, so set tape recording volume according to this tone. DIP Switch 2 "TAPE OUT" can be set to HIGH or LOW to match the tape recorder you are using. Adjust the recording level so that is as high as possible without distorting (about 0dB on the level meter).
- ③ Start the DDD-1 and adjust tempo if necessary. (TEMPO will be set at the value as recorded, so take care to make sure that it is correct before recording.)
- ④ Start the tape recorder, wait two or three seconds, then start the DDD-1. When you start DDD-1, it will switch from leader tone to clock signal output (an "aaa" sound).
- ⑤ Stop DDD-1 after recording the clock signal for a sufficient length of time. (The DDD-1 will then switch back to leader tone output.) Continue recording for another two or three seconds, then stop the tape recorder.

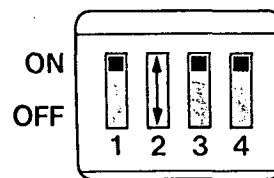

CONNECTION WITH OTHER DEVICES

■ Using tape SYNC (recorded clock signal) to control the DDD-1.

- ① Connect the DDD-1 TAPE IN jack to the tape recorder's appropriate output jack. Set the DDD-1 clock switch to TAPE.

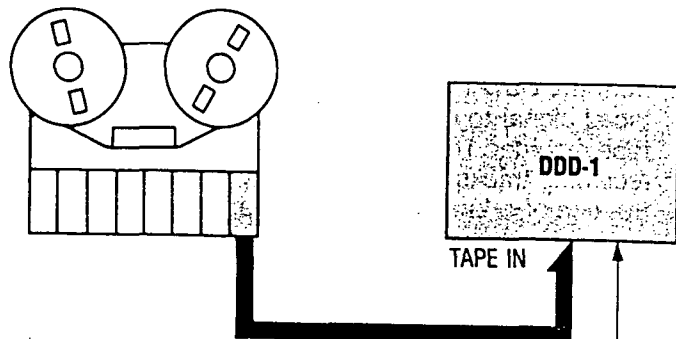

When using with multi-track tape recorder, connect to the sync recorded output jack that will provide the sync signal during playback.

Set Clock to "TAPE" according to procedures on page 99.

- ② Begin playback of the tape deck's sync track. As soon as you hear the leader tone, press the START key on the DDD-1.

When the clock signal ("aaa" sound) starts, the DDD-1 will start from the first beat of the first bar.

③ The DDD-1 will stop when the clock signal ends and the leader ton ("eee" sound) resumes.

★ If the DDD-1 fails to start at the sync signal or if the tempo is unsteady, then the recording level was probably too low or too high when the sync signal was recorded. Try recording again after changing DIP switch 1 - "TAPE IN" on the rear panel.

★ Continue Start is not possible when the Clock is set to "TAPE".

■ In this way, the DDD-1 and SQD-1, etc. can be utilized in making multi-track recordings, being recorded onto empty tracks simultaneously.

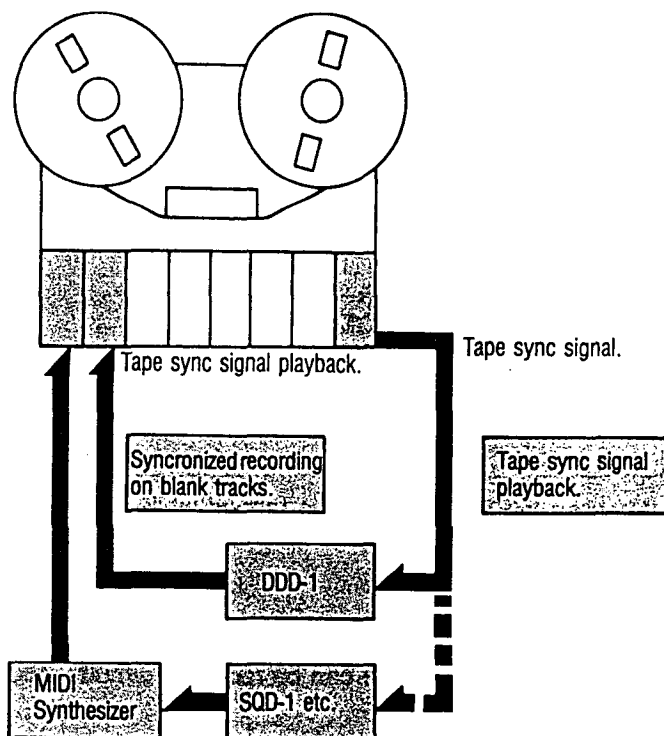
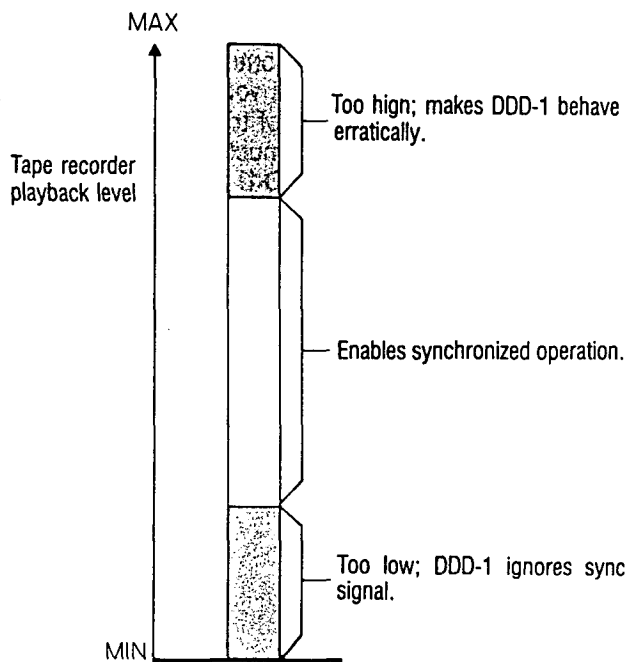
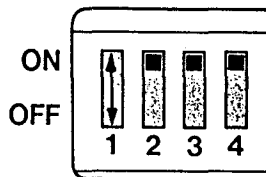

2. About Connecting The DDD-1 to _____ Drum Pads, Synthesizers, etc.

1 Using the DDD-1 as a Sound Source for MIDI Synthesizers and MIDI Drum Pads. (See page 93.)

DDD-1 Instrument Sounds are produced when the DDD-1 receives Note Date from MIDI keyboards, sequencers, etc. If the controlling device feature TOUCH SENS, then DDD-1 volume is also controlled according to the strength of touch on either the keys or drum pads, etc. This is much like playing an actual Instrument key on the DDD-1.

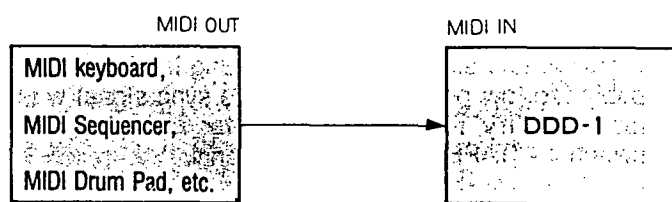

Set MIDI RECEIVE parameters according to procedures listed on page 100 ~ 102.

- Also, TUNE and DECAY can be controlled when connected to a MIDI keyboard.

NOTE:
Note Numbers and other data received via MIDI IN cannot be output via MIDI OUT. Recording into MIDI Sequencers or other devices after routing through the DDD-1 is also impossible.

DECAY, TUNE, INST KEY and NOTE NUMBER Control Ranges

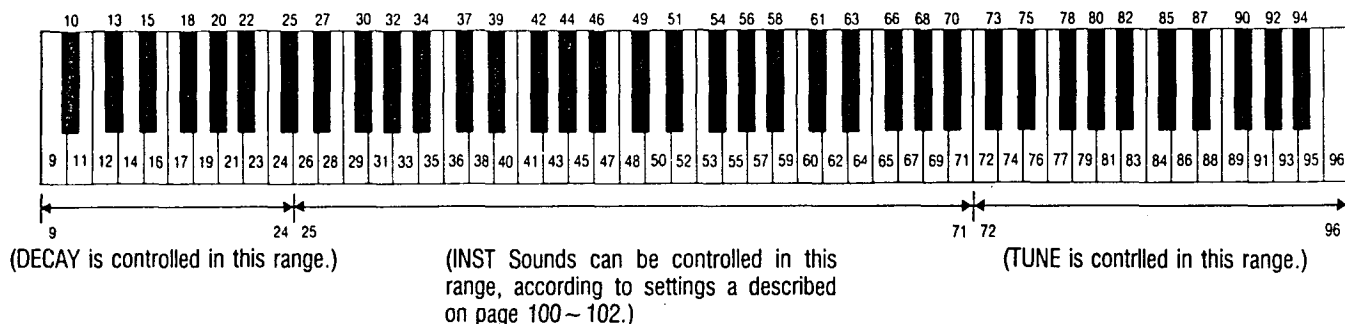

When an INST Control Key is tapped while holding down a DECAY Control Key or TUNE Control Key, Instrument Sounds set to the various INST Control keys are sounded according to the SEQ DECAY or SEQ TUNE setting.

★ Patterns played via the MIDI keyboard or MIDI drum pad can be recorded via the PATTERN RECORDING Mode on the DDD-1. These can be recorded simultaneously when TUNE DECAY is controlled via MIDI Keyboards or other devices.

② Using Other MIDI Drum Machines or Synth Modules as Sound Sources. (See page 94.)

Percussion sounds can be created by using MIDI Drum machines, synth modules etc. as sound sources. Note numbers can be assigned to any of the MIDI Channel when transmitting data via the DDD-1, so a variety of sound sources can be sounded at the desired timing.

(Example of Connection)

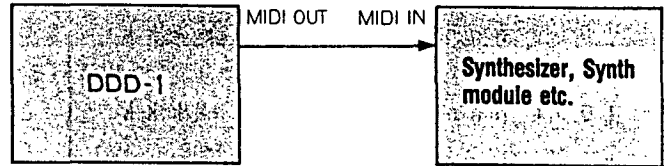

NOTE:

The DDD-1 transmits a NOTE OFF message immediately after transmitting a NOTE ON signal, so some synth modules may not respond.

③ Connection of other Drum Pads, Synthesizers, etc. (See page 91.)

The DDD-1 can be triggered by external sources such as synthesizers or microphones featuring TRIG OUT jacks. Also, the DDD-1 can control other units, acting as trigger by utilizing the DDD-1 TRIG OUT signal.

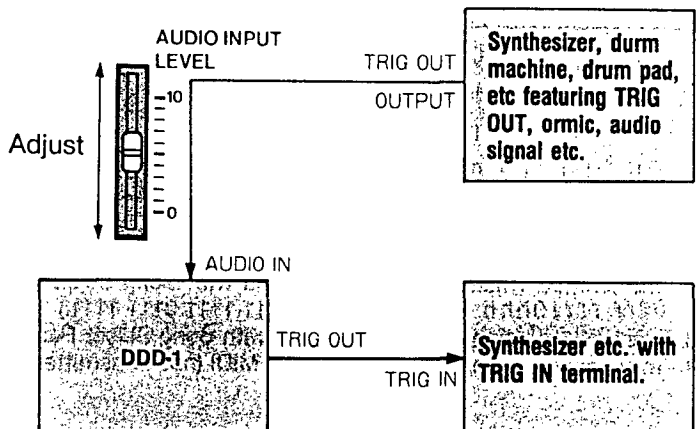

MIDI IMPLEMENTATION

1. TRANSMITTED DATA

1 CHANNEL MESSAGES

STATUS	SECOND	THIRD	DESCRIPTION
1 0 0 0 n n n n	0 k k k k k k k k	0 0 0 0 0 0 0 0	Note Off (NOTE 1) k k k k k k k = 25~71
1 0 0 1 n n n n	0 k k k k k k k k	0 v v v v v v v v	Note On (NOTE 1) k k k k k k k = 25~71 v v v v v v v v = 1~127

★ nnnn = 0 ~ 15: Channel Numbers set to individual keys via MIDI Transmit Function.

NOTE

1. Note OFF transmitted immediately after Note transmission.

2 SYSTEM MESSAGES

STATUS	SECOND	THIRD	DESCRIPTION
1 1 1 1 0 0 0 0	0 1 0 0 0 0 1 0	0 x x x x x x x	Exclusive Messages (NOTE 1)
1 1 1 1 0 1 1 1	_____	_____	EOX (NOTE 1)
1 1 1 1 0 0 1 0	0 l l l l l l l l	0 h h h h h h h h	Song Position Pointer (NOTE 2)
1 1 1 1 0 0 1 1	0 s s s s s s s s	_____	Song Select (NOTE 3)
1 1 1 1 1 0 0 0	_____	_____	Timing Clock (NOTE 4)
1 1 1 1 1 0 1 0	_____	_____	Start
1 1 1 1 1 0 1 1	_____	_____	Continue
1 1 1 1 1 1 0 0	_____	_____	Stop

NOTES

1. Transmitted when set to MIDI in Data Transfer Mode.
2. Transmitted when measure is selected with Song Select Function set to STOP (However, transmission is impossible when 0 l l l l l l l l 0 h h h h h h h h exceeds 0 1 1 1 1 1 1 1 1 1 1 1.)
3. Transmitted when SONG is selected with Song Select Function set to STOP.
4. Transmitted when Clock is not set to MIDI (not transmitted when set to STOP).

3 SYSTEM EXCLUSIVE MESSAGES

1 SEQUENCE DATA

BYTE	DESCRIPTION
1 1 1 1 0 0 0 0	EXCLUSIVE STATUS
0 1 0 0 0 0 1 0	KORG ID 42H
0 0 1 1 0 0 0 0	FORMAT ID 30H
{ 0 0 0 1 0 0 1 0	DDD-1 ID 12H
{ 0 0 0 0 0 1 1 1	SQD-1 ID 07H
0 1 0 0 1 0 0 0	SEQUENCE DATA 48H
0 d d d d d d d	DATA
⋮	Data up to 56 bytes *57 bytes for the first block only
0 d d d d d d d	
1 1 1 1 0 1 1 1	DATA EOX

NOTE

1. DDD-1 is transmitted when SQD-1 receives DATA DUMP REQUEST during SAVE operation while set to the MIDI Function in the Data Transfer Mode.

2 DATA END BLOCK

BYTE	DESCRIPTION
1 1 1 1 0 0 0 0	EXCLUSIVE STATUS
0 1 0 0 0 0 1 0	KORG ID 42 H
0 0 1 1 0 0 0 0	FORMAT ID 30 H
{ 0 0 0 1 0 0 1 0	DDD-1 ID 12 H
{ 0 0 0 0 0 1 0 0	SQD-1 ID 07 H
0 1 0 0 1 1 1 1	DATA END BLOCK 4FH
1 1 1 1 0 1 1 1	EOX

NOTE

1. DDD-1 is transmitted when SQD-1 receives DATA DUMP REQUEST during SAVE operation while set to the MIDI Function in the Data Transfer Mode.

3 DEVICE ID

BYTE	DESCRIPTION
1 1 1 1 0 0 0 0	EXCLUSIVE STATUS
0 1 0 0 0 0 1 0	KORG ID 42H
0 0 1 1 0 0 0 0	FORMAT ID 30H
0 0 0 1 0 0 1 0	DDD-1 ID 12H
1 1 1 1 0 1 1 1	EOX

2. RECOGNIZED RECEIVE DATA

1 CHANNEL MESSAGES

STATUS	SECOND	THIRD	DESCRIPTION
1 0 0 0 n n n n	0 k k k k k k k k	0 x x x x x x x	Note Off (NOTE 1)
1 0 0 1 n n n n	0 k k k k k k k k	0 0 0 0 0 0 0 0	Note Off (NOTE 1)
1 0 0 1 n n n n	0 k k k k k k k k	0 v v v v v v v v	Note On (NOTE 2)
			v v v v v v v v = 1 ~ 127
1 1 0 0 n n n n	0 p p p p p p p p	-----	Program Change (NOTE 3)
1 0 1 1 n n n n	0 1 1 1 1 1 0 0	0 x x x x x x x	Omni Mode Off
1 0 1 1 n n n n	0 1 1 1 1 1 0 1	0 x x x x x x x	Omni Mode On

★ nnnn = 0 ~ 15: Channel Numbers set via the MIDI Receive Function at OMNI MODE ON, all messages received regardless of setting. At OMNI MODE OFF, only set Channel Message is received. However, Channel Mode Messages receive set Channel Messages regardless of OMNI ON/OFF status.

NOTES

1. Recognized Note OFF Note Numbers

k k k k k k k k = 9 ~ 24 (SEQ DECAY)

k k k k k k k k = 72 ~ 96 (SEQ TUNE)

★ kkk kkkk = 25 ~ 71 is ignored.

2. Recognized Note ON Note Numbers

k k k k k k k k = 9 ~ 24 (SEQ DECAY)

k k k k k k k k = 25 ~ 71 (INST KEY)

k k k k k k k k = 72 ~ 96 (SEQ TUNE)

3. When a Program Change Message is received in the INST SETTING mode, Instrument settings may be altered.

★ Program change Numbers outside of the range are ignored. Program change Numbers outside of the p p p p p p p p = 0 ~ 5 range are ignored.

2 SYSTEM MESSAGES

STATUS	SECOND	THIRD	DESCRIPTION
1 1 1 1 0 0 0 0	0 1 0 0 0 0 1 0	0 x x x x x x x	Exclusive Messages (NOTE 1)
1 1 1 1 0 1 1 1	_____	_____	EOX (NOTE 1)
1 1 1 1 0 0 1 0	0 l l l l l l l l	0 h h h h h h h h	Song Position Pointer (NOTE 2)
1 1 1 1 0 0 1 1	0 s s s s s s s s	_____	Song Select (NOTE 2)
1 1 1 1 1 0 0 0	_____	_____	Timing Clock (NOTE 3)
1 1 1 1 1 0 1 0	_____	_____	Start
1 1 1 1 1 0 1 1	_____	_____	Continue
1 1 1 1 1 1 0 0	_____	_____	Stop

NOTES

1. Recognized when Data Transfer Mode is set to MIDI.
2. Recognized only when Song Select Function is set to STOP. Song Numbers outside the sss ssss = 0 ~ 9 range are ignored.
3. Recognized when Clock is set to MIDI.

3 SYSTEM EXCLUSIVE MESSAGES

1 DATA DUMP REQUEST

BYTE	DESCRIPTION	HEX
1 1 1 1 0 0 0 0	EXCLUSIVE STATUS	
0 1 0 0 0 0 1 0	KORG ID	42H
0 0 1 1 0 0 0 0	FORMAT ID	30H
0 0 0 1 0 0 1 0	DDD-1 ID	12H
0 0 0 1 0 0 0 0	DATA DUMP REQUEST	10H
1 1 1 1 0 1 1 1	EOX	

MIDI IMPLEMENTATION

2 SEQUENCE DATA

BYTE	DESCRIPTION
1 1 1 1 0 0 0 0	EXCLUSIVE STATUS
0 1 0 0 0 0 1 0	KORG ID 42H
0 0 1 1 0 0 0 0	FORMAT ID 30H
{ 0 0 0 1 0 0 1 0	DDD-1 ID 12H
{ 0 0 0 0 0 1 0 0	SQD-1 ID 07H
0 1 0 0 1 0 0 0	SEQUENCE DATA 48H
0 d d d d d d d	DATA } Data up to 56 bytes
0 d d d d d d d	
1 1 1 1 0 1 1 1	EOX

NOTE

1. SQD-1 ID transmitted when SAVE operation of "MIDI" function in the data transfer mode and DDD-1 ID transmitted when receive DATA DUMP REQUEST.

3 DATA END BLOCK

BYTE	DESCRIPTION
1 1 1 1 0 0 0 0	EXCLUSIVE STATUS
0 1 0 0 0 0 1 0	KORG ID 42H
0 0 1 1 0 0 0 0	FORMAT ID 30H
{ 0 0 0 1 0 0 1 0	DDD-1 ID 12H
{ 0 0 0 0 0 1 0 0	SQD-1 ID 07H
0 1 0 0 1 1 1 1	DATA END BLOCK 4FH
1 1 1 1 0 1 1 1	EOX

NOTES

1. SQD-1 ID transmitted when SAVE operation of "MIDI" function in the data transfer mode and DDD-1 ID transmitted when receive DATA DUMP REQUEST.

4 DATA DUMP ERROR

BYTE	DESCRIPTION
1111 0000	EXCLUSIVE STATUS
0100 0010	KORG ID 42H
0011 0000	FORMAT ID 30H
0001 0010	DDD-I ID 12H
0010 0000	DATA DUMP ERROR 20H
1111 0111	EOX

5 DEVICE ID REQUEST

BYTE	DESCRIPTION
1111 0000	EXCLUSIVE STATUS
0100 0010	KORG ID 42H
0100 0000	FORMAT ID 40H
1111 0111	EOX

3. Using System Exclusive Messages

■ The DDD-1 can transmit and receive the following types of information via System Exclusive Messages.

Transmitting

- SEQUENCE DATA** : Refers to the Pattern, Song and Instrument Setting data stored in internal memory. This is sent as a series of 64-byte blocks, the number of which depends on the amount of data recorded in internal memory. When a SAVE is performed in the MIDI function of the DATA TRANSFER MODE, data including SQD-1 is sent. And, when a DATA DUMP REQUEST is received, data including DDD-1 ID is sent.
- DATA END BLOCK** : Marks the end of SEQUENCE DATA transmission. This is sent after the last SEQUENCE DATA block is sent, or when the CANCEL key is pressed.
- DEVICE ID** : Identifies equipment. Sent when a DEVICE ID REQUEST is received in the MIDI Function of the DATA TRANSFER MODE.

Receiving

- DATA DUMP REQUEST** : A request to send SEQUENCE DATA. SEQUENCE DATA including DDD-1 ID is sent when a DATA DUMP REQUEST is received.
- SEQUENCE DATA** : Pattern, Song and Instrument Setting data.
- DATA END BLOCK** : Marks the end of SEQUENCE DATA transmission. Reception is terminated when this is received.
- DATA DUMP ERROR** : Indicates that something has gone wrong on the receiving side during transmission of sequence DATA. If a DATA DUMP ERROR is received, then a "Error End" message will be displayed upon completion of data transmission.
- DEVICE ID REQUEST** : A request to send the DEVICE ID. The DEVICE ID is sent when a DEVICE ID REQUEST is received.

■ These messages can be used for data transmission between the SQD-1 and a computer equipped with a MIDI interface and software that handles these system exclusive messages. Setup examples are shown below:



1 Transmitting data to a SQD-1 (SAVE)

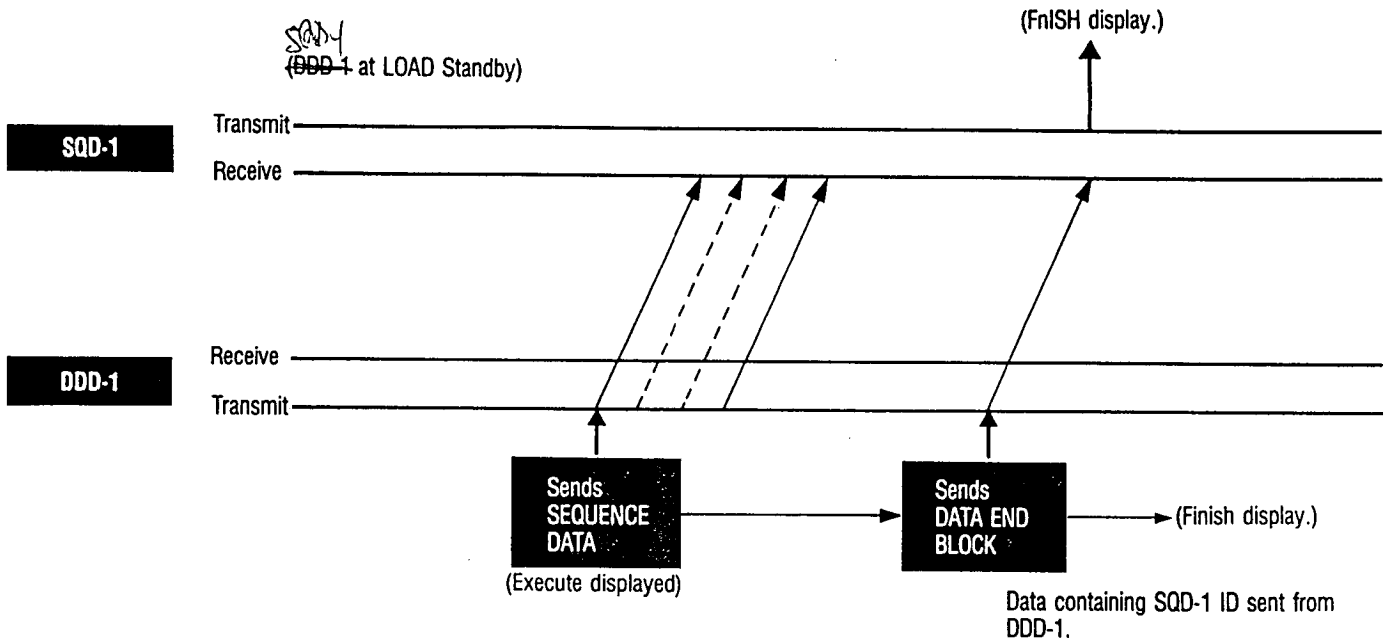

2 Receiving data from a SQD-1 (LOAD)

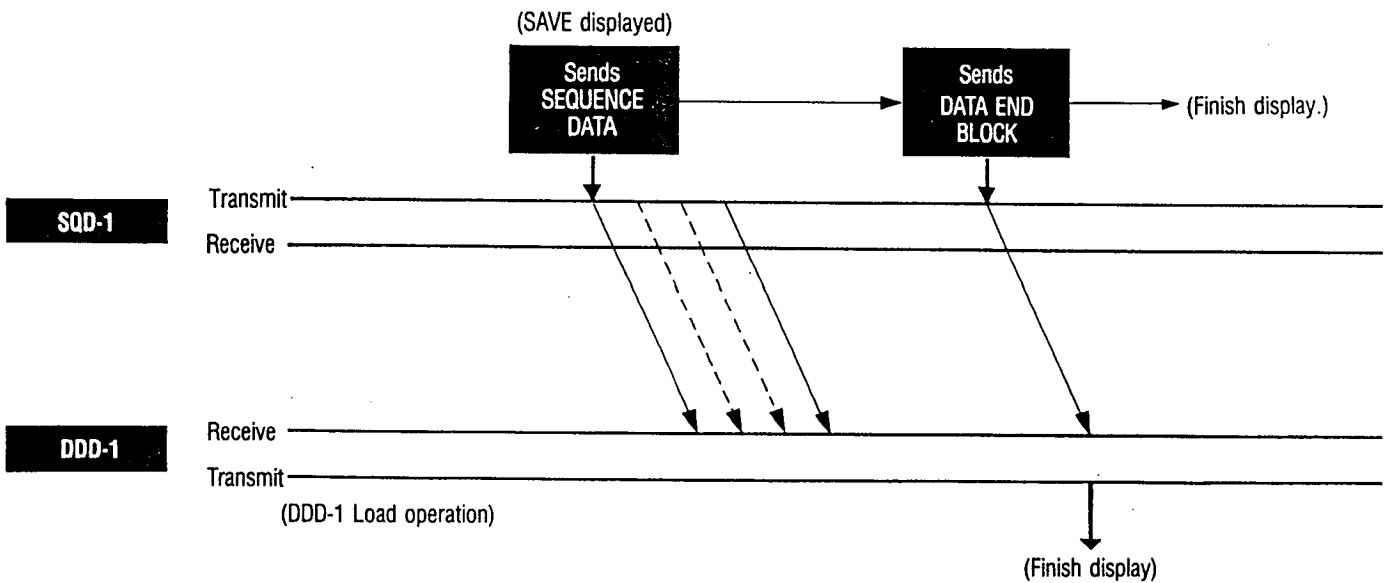

MIDI IMPLEMENTATION

③ Transmitting data to a Computer (SAVE)

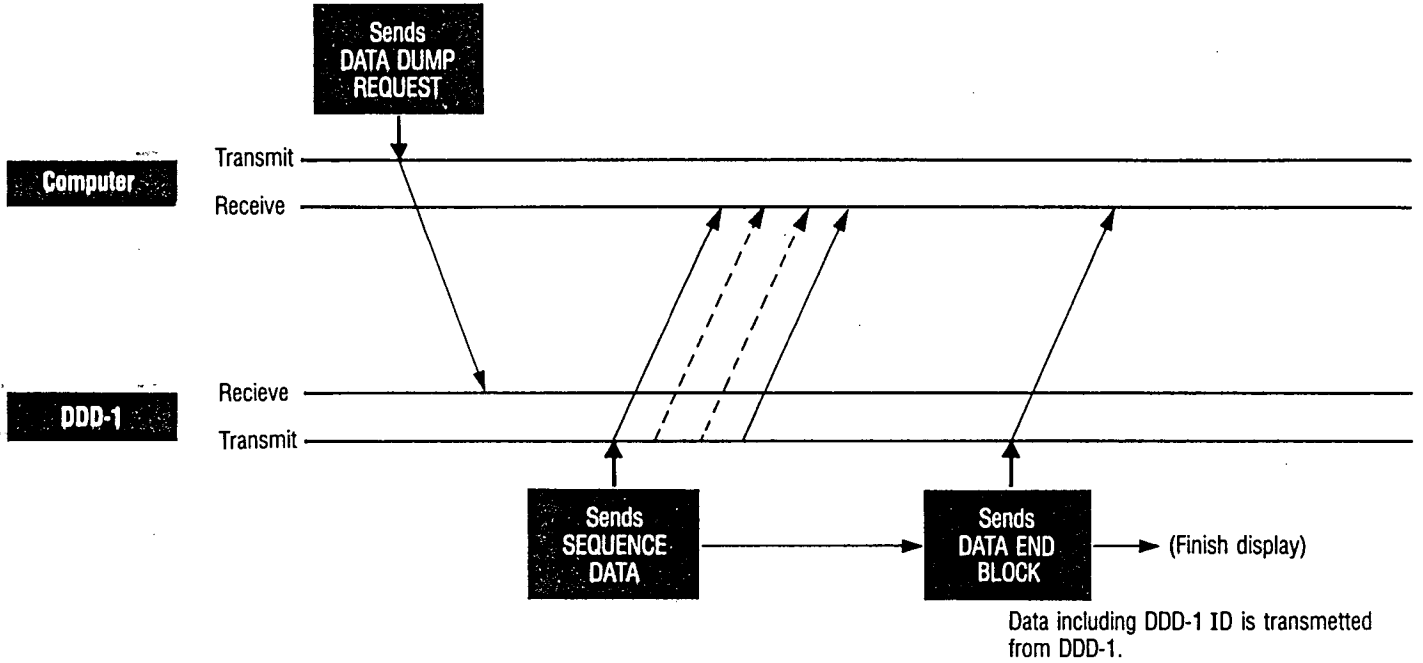

④ Receiving data from a Computer (LOAD)

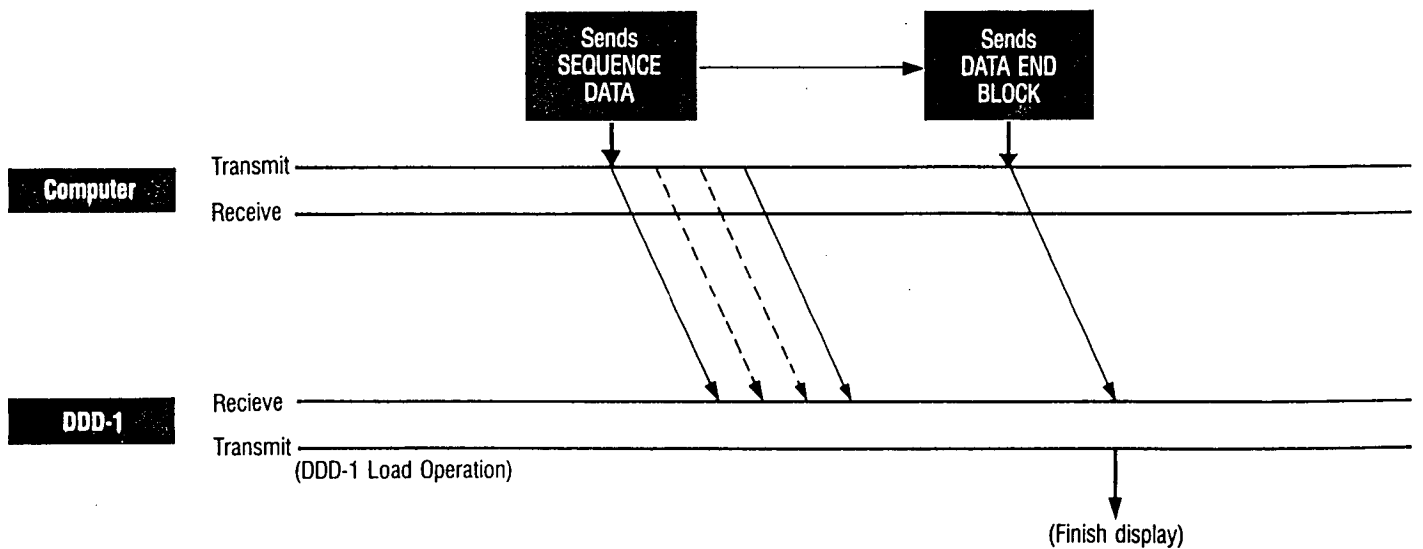

5 To find out what equipment is connected to a computer.

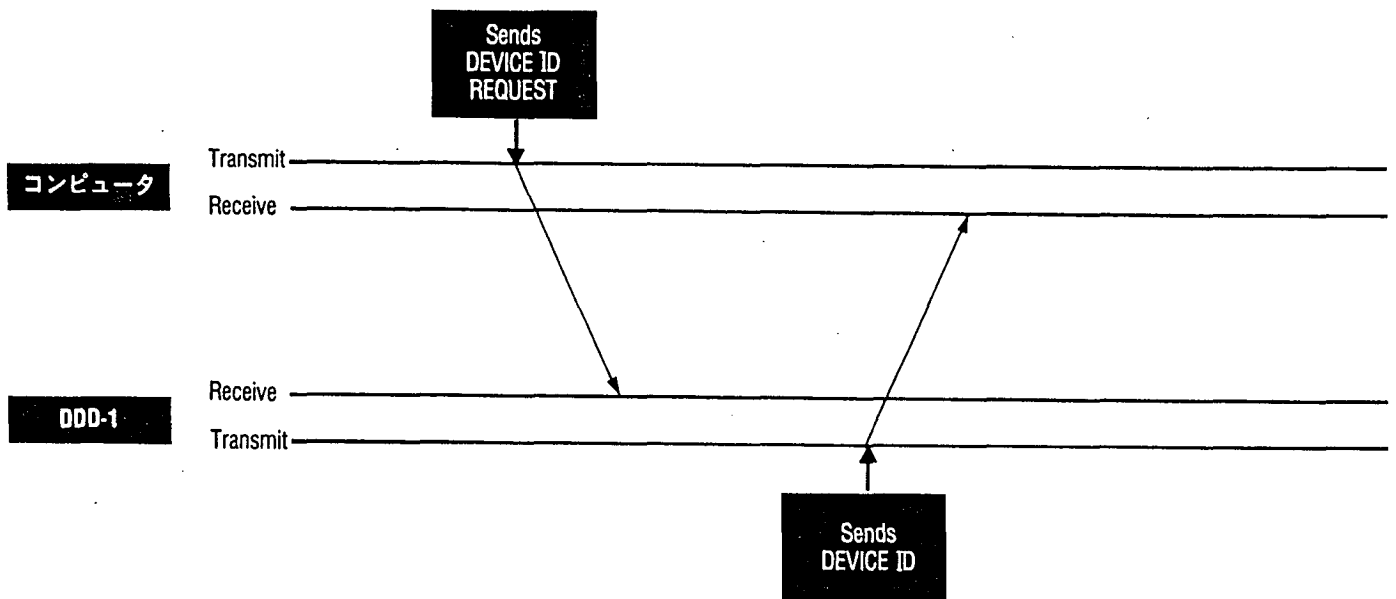

6 If a DATA DUMP ERROR is received during data transmission.

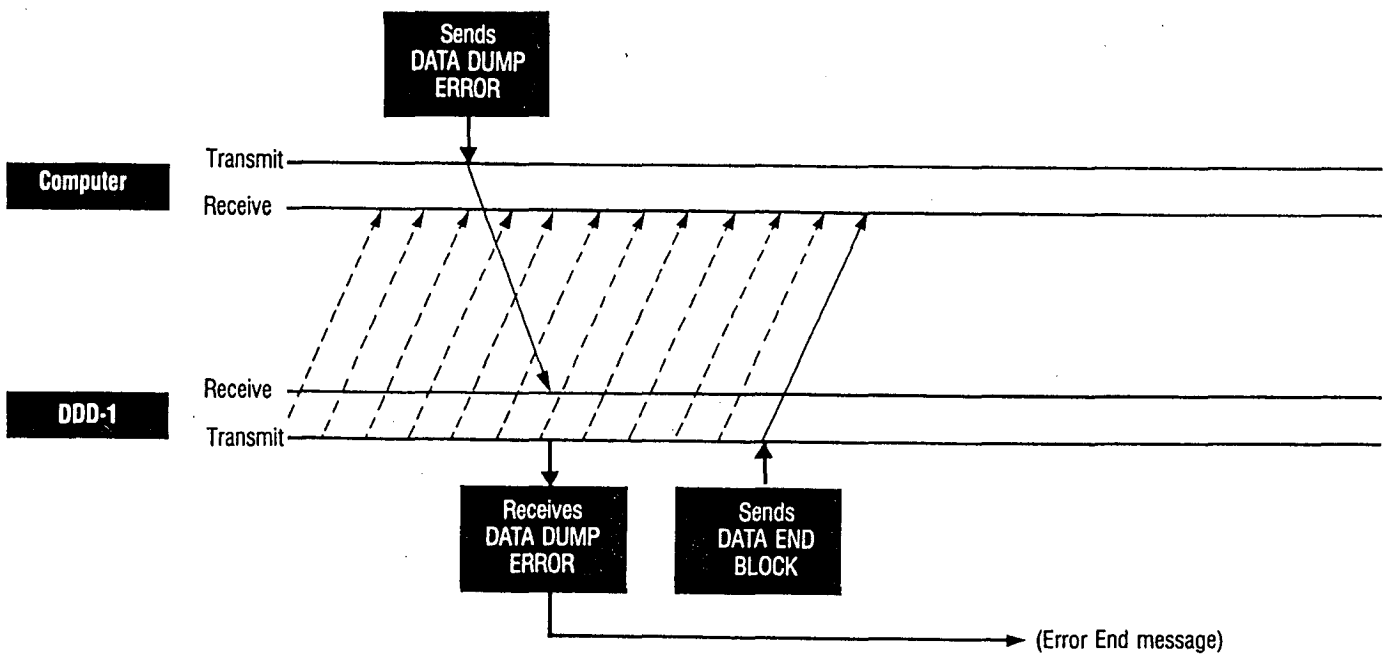

SYSTEM RESET

The system reset function is used to erase all PAT-
TERN, SONG and INST SETTING data from the DDD-1
memory.

All parameters are reset to DEFAULT (initialized) values.

Hold down ^{+1 YES} and ^{-1 NO} and turn the
power switch ON 

```
KORG DDD-1
SYSTEM RESET !!
```

MAIN ERROR MESSAGES

```
MEMORY FULL !!
P01-01 : *PTN-01*
```

Pattern Memory becomes FULL during
Real Time Recording (See pg. 52)

```
BAR MEMORY FULL!
P01-01 : *PTN-01*
```

249 notes are already in one Bar in Real
Time recording (See pg. 52)

```
MEMORY FULL !!
P01-01 : 5000/000
```

Pattern Memory becomes FULL during
Step Recording (See pg. 58)

```
BAR MEMORY FULL!
P01-01 : 5000/000
```

249 notes already in one Bar in Step
Recording (See pg. 58)

```
Parameter Error!
PTN01+PTN02
```

Conditions not met to perform APPEND
(See pg. 66)

```
MEMORY SHORTAGE!
```

COPY or APPEND impossible due to
memory shortage (See pg. 70)

```
CREATE1 *SONG-1*
PART01!!! Error
```

Position set for REPEAT is incorrect (See
pg. 76)

```
RAM CARD SAVE
Error End.
```

SAVE not performed correctly with RAM
Card (See pg. 113)

```
RAM CARD VERIFY
Error End.
```

VERIFY not performed correctly with RAM
(See pg. 114)

```
RAM CARD LOAD
Error End.
```

LOAD not performed correctly with RAM
Card (See pg. 115)

```
TAPE VERIFY
Error End.
```

VERIFY not performed correctly with
Cassette Tape (See pg. 122)

```
TAPE LOAD
Error End.
```

LOAD not performed correctly with
Cassette Tape (See pg. 125)

```
ROM CARD CHECK
Card1: Error.
```

An inappropriate ROM Card is set in unit
(See pg. 130)

SPECIFICATION & OPTIONS

- **Sound Sources** : 18 internal sound sources including:
BASS DRUM × 2/SNARE DRUM × 2/TOM 1/TOM 2/TOM 3/RIMSHOT/CLOSED
HIHAT × 2/OPEN HIHAT × 2/RIDE/CRASH/CLAPS/COWBELL/TAM-
BOURINE/CABASA
Up to 4 ROM Cards, Sampling Board (options)
- **Memory** : 100 PATTERNS (00~99) Max. Note Number 4400. 10 SONGS (0~9) Max. Part
Number 255.
- **Inst Settings** : Setting Select (0~5)/TOUCH SENS (0~9)/TOTAL TUNE (0~127)/TOTAL DECAY
(0~15)/OUTPUT LEVEL (0~15)/OUTPUT ASSIGN/INST ASSIGN
- **Pattern Modes** : PATTERN SELECT/TIME SIGNATURE ($\frac{1}{4}$ ~ $\frac{8}{4}$, $\frac{1}{8}$ ~ $\frac{16}{8}$, $\frac{1}{16}$ ~ $\frac{32}{16}$,
 $\frac{1}{32}$ ~ $\frac{64}{32}$) /NUMBER OF BARS (1~99)/RESOLUTION ($\frac{1}{4}$, $\frac{1}{4}$ T, $\frac{1}{8}$, $\frac{1}{8}$ T, $\frac{1}{16}$,
 $\frac{1}{16}$ T, $\frac{1}{32}$, $\frac{1}{32}$ T, HIGH)/ROLL ($\frac{1}{4}$, $\frac{1}{4}$ T, $\frac{1}{8}$, $\frac{1}{8}$ T, $\frac{1}{16}$, $\frac{1}{16}$ T, $\frac{1}{32}$, $\frac{1}{32}$ T)/FLAM
(0, 10, 20, 30, 40, 50, 60, 70, 80, 90msec)/SEQUENCE PARAMETER (TUNE, DECAY,
DYNAMICS)/TEMPO (♩ = 40~250)/ERASE/SWING/COPY/APPEND/AVAILABLE
MEMORY/CLEAR
- **Song Modes** : SONG SELECT/CRATE/REPEAT (MAX 99)/TEMPO CHANGE (UP,
DOWN)/INSERT/DELETE/TEMPO (♩ = 40~250)/CLEAR
- **System Setting Mode** : METRONOME ($\frac{1}{4}$, $\frac{1}{4}$ T, $\frac{1}{8}$, $\frac{1}{8}$ T, $\frac{1}{16}$, $\frac{1}{16}$ T, $\frac{1}{32}$, $\frac{1}{32}$ T)/TRIGGER
ASSIGN/CLOCK (INT, MIDI, TAPE)/MIDI RECEIVE (1~16)/MIDI TRANSMIT
(1~16)/SAMPLING SET
- **Data Transfer Mode** : RAM Card/TAPE/MIDI/ROM Card check
- **Controls** : INST KEY × 14/START KEY/STOP, RESET KEY/REC, ENTER KEY/TAP TEMPO KEY/
ROLL KEY/FLAM KEY/TEN-KEYS/+ 1/YES KEY/- 1/NO KEY/CUSOR
KEY ◀▶/FUNCTION SELECT KEYS (f.1~f.8)/MODE SELECT KEYS (1~6)/DATA
SLIDER/VOLUME SLIDER/INPUT LEVEL SLIDER
- **Indicators** : 2-line, 16-character LCD/REC LED/RUN LED/TRIG LED/PEAK LED/MODE LEDs
- **Rear Panel** : OUT PUT (L/R/MONO)/MULTI OUTPUT (1~6)/SAMPLED OUT/TRIG OUT/AUDIO
IN/PHONES/METRONOME OUT/TAPE (IN, OUT)/FOOT SWITCH JACK (TAP TEM-
PO, S/S)/MIDI TERMINAL (IN, OUT)/SAMPLING BOARD SLOT/POWER SWITCH/DIP
SWITCH
- **Power Consumption** : 7W
- **Dimensions** : 411(W) × 263(D) × 65(H) mm
- **Weight** : 3.2 kg
- **Accessories** : DEMONSTRATION PATTERN DATA, CASSETTE TAPE × 1. DDD-1 INST LEVEL
- **Options** : SAMPLING BOARD (DSB-1)/RAM CARD/MEMORY CARD ROM/HEADPHONE
(KH-1000)/PEDAL SWITCH (PS-1, PS-2)/TWIN CABLE (TWC-030)/
SINC MIDI CABLE/MINI PLUG CORD/MINI CONNECTION PLUG/
HARD CASE (HC-DDD)

N O T I C E

Korg products are manufactured under strict specifications and voltages required by each country. These products are warranted by the Korg distributor only in each country. Any Korg product not sold with a warranty card or carrying a serial number disqualifies the product sold from the manufacturer's/distributor's warranty and liability. This requirement is for your own protection and safety.

DDD-1 PATTERN CHART

- このパターンチャートは付属のカセットの“Basic Pattern”側に記録されているデータを記譜したものです。パターンをレコーディングする際のヒントなどにご使用ください。
(なお取扱説明書中の空パターン、ソングについては“Basic Pattern”側の内容に添って書かれています。)

- This PATTERN CHART shows data recorded in the accessory “BASIC PATTERN” cassette, Use settings as when doing PATTERN RECORDING.

(NOTE: Black PATTERN, and songs listed in the Owner's Manual follow the “BASIC PATTERN” form.)

- ★譜面は以下の表記に統一してあります。

Normally, the display appears as below.

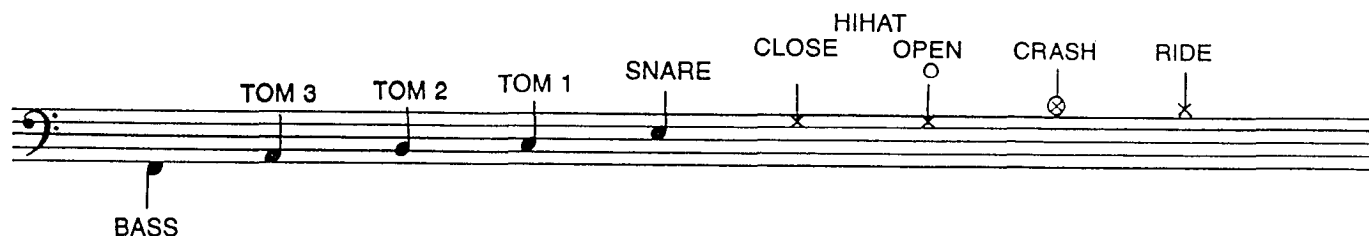

- ★指示のないものは全て4拍子です。

If there is no specific definition, these scores are of four-quarter measure.

KORG

Ptn 01 8Beat 01

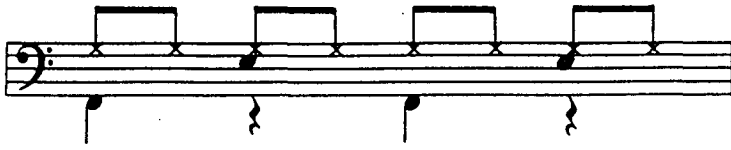

Ptn 02 8Beat 02

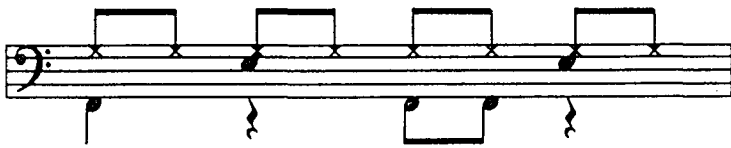

Ptn 03 8Beat 03

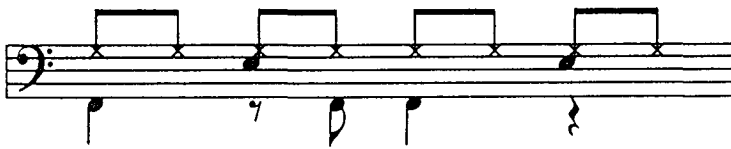

Ptn 04 8Beat 04

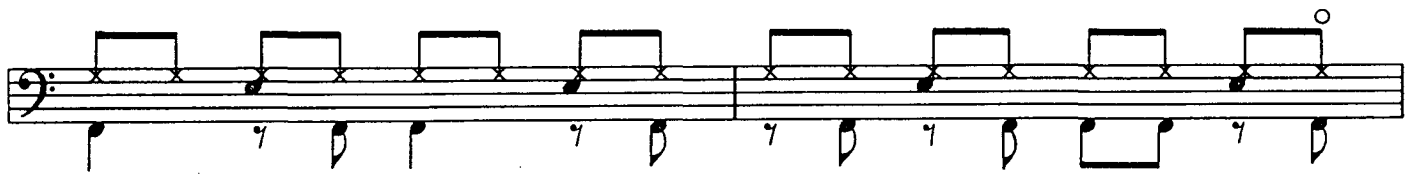

Ptn 05 8Beat 05

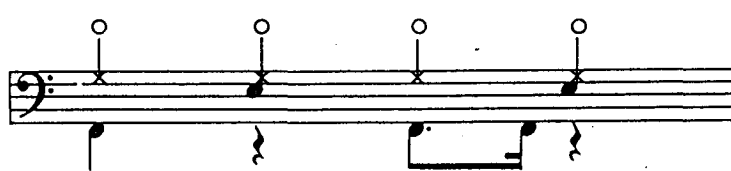

Ptn 06 8Beat 06

Musical notation for Ptn 06 8Beat 06. The staff shows a sequence of notes with fingerings (7) and accents. The notes are: G2 (circled), F2, E2, D2, C2, B1, A1, G1. The bass line consists of quarter notes with fingerings: G2 (7), F2 (7), E2 (7), D2 (7), C2 (7), B1 (7), A1 (7), G1 (7).

Ptn 07 Shuffle 01

Musical notation for Ptn 07 Shuffle 01. The staff shows a sequence of notes with triplets and fingerings (7). The notes are: G2, F2, E2, D2, C2, B1, A1, G1. The bass line consists of quarter notes with fingerings: G2 (7), F2 (7), E2 (7), D2 (7), C2 (7), B1 (7), A1 (7), G1 (7).

Ptn 08 Shuffle 02

Musical notation for Ptn 08 Shuffle 02. The staff shows a sequence of notes with triplets and fingerings (7). The notes are: G2, F2, E2, D2, C2, B1, A1, G1. The bass line consists of quarter notes with fingerings: G2 (7), F2 (7), E2 (7), D2 (7), C2 (7), B1 (7), A1 (7), G1 (7).

Ptn 09 Shuffle 03

Musical notation for Ptn 09 Shuffle 03. The staff shows a sequence of notes with triplets and fingerings (7). The notes are: G2, F2, E2, D2, C2, B1, A1, G1. The bass line consists of quarter notes with fingerings: G2 (7), F2 (7), E2 (7), D2 (7), C2 (7), B1 (7), A1 (7), G1 (7).

Ptn 10 Shuffle 04

Musical notation for Ptn 10 Shuffle 04. The staff shows a sequence of notes with triplets and fingerings (7). The notes are: G2, F2, E2, D2, C2, B1, A1, G1. The bass line consists of quarter notes with fingerings: G2 (7), F2 (7), E2 (7), D2 (7), C2 (7), B1 (7), A1 (7), G1 (7).

Ptn 11 16 Beat 01

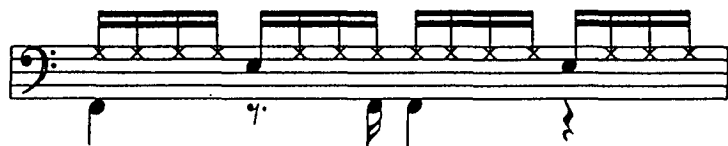

Ptn 12 16 Beat 02

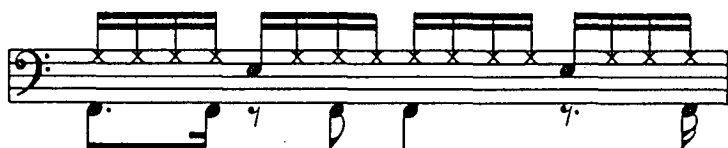

Ptn 13 16 Beat 03



Ptn 14 16 Beat 04

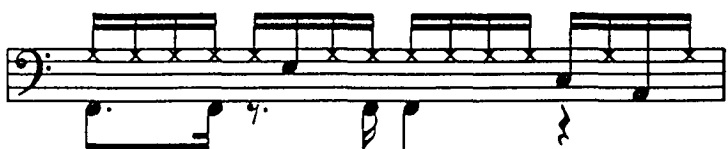

Ptn 15 16 Beat 05

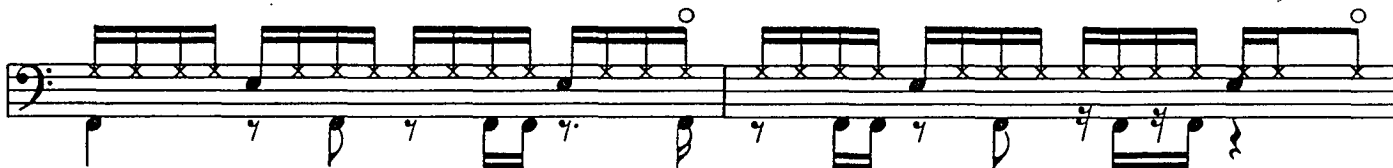

Ptn 16 16 Beat 06

Musical notation for Ptn 16, 16 Beat 06. The notation is on a single staff with a bass clef. It consists of two measures. The first measure contains a series of eighth notes with stems pointing up, followed by a quarter note with a stem pointing down. The second measure contains a series of eighth notes with stems pointing up, followed by a quarter note with a stem pointing down. There are small circles above the final notes in both measures.

Ptn 17 Bossa

Musical notation for Ptn 17, Bossa. The notation is on a single staff with a bass clef. It consists of two measures. The first measure contains a series of eighth notes with stems pointing up, followed by a quarter note with a stem pointing down. The second measure contains a series of eighth notes with stems pointing up, followed by a quarter note with a stem pointing down. There are small circles above the final notes in both measures. The text "= RIM" is written to the right of the second measure.

Ptn 18 Samba 01

Musical notation for Ptn 18, Samba 01. The notation is on a single staff with a bass clef. It consists of two measures. The first measure contains a series of eighth notes with stems pointing up, followed by a quarter note with a stem pointing down. The second measure contains a series of eighth notes with stems pointing up, followed by a quarter note with a stem pointing down.

Ptn 19 Samba 02

Musical notation for Ptn 19, Samba 02. The notation is on a single staff with a bass clef. It consists of two measures. The first measure contains a series of eighth notes with stems pointing up, followed by a quarter note with a stem pointing down. The second measure contains a series of eighth notes with stems pointing up, followed by a quarter note with a stem pointing down.

Ptn 20 Samba 03

Musical notation for Ptn 20, Samba 03. The notation is on three staves with a bass clef. The top staff contains a series of eighth notes with stems pointing up, followed by a quarter note with a stem pointing down. The middle staff contains a series of eighth notes with stems pointing up, followed by a quarter note with a stem pointing down. The bottom staff contains a series of eighth notes with stems pointing up, followed by a quarter note with a stem pointing down. The text "= COWBELL" is written to the right of the top staff, "TAMBOURINE" is written to the right of the middle staff, and "CABASA" is written to the right of the bottom staff.

Ptn 21 8Beat 02a (Ptn 02 with accent)

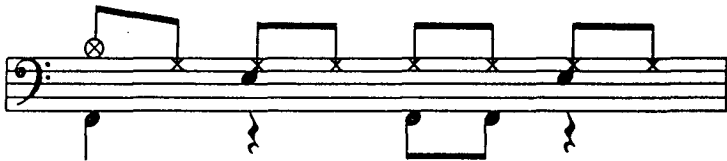

Ptn 22 8Beat 02R (Ptn 02 Ride)

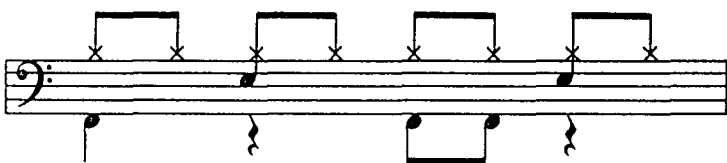

Ptn 23 8Beat 02A (Ptn 02 with accent)

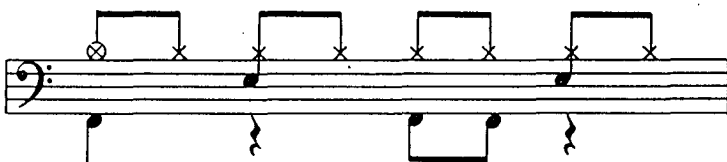

Ptn 24 Fill 01



Ptn 25 Fill 02



Ptn 26 Fill 03



Ptn 27 Fill 04



Ptn 28 Fill 05



Ptn 29 16 Beat 02a (Ptn 12 with accent)

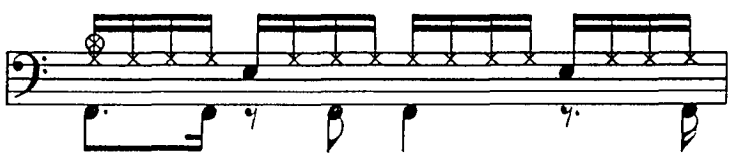

Ptn 30 16 Beat 02R (Ptn 12 Ride)

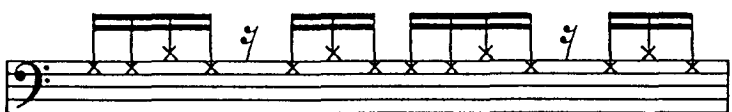

Ptn 31 16 Beat 02A (Ptn 30 with accent)

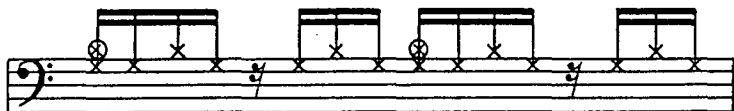

Ptn 32 Fill 06

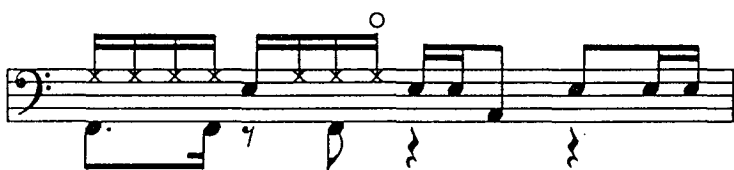

Ptn 33 Fill 07



Ptn 34 Fill 08

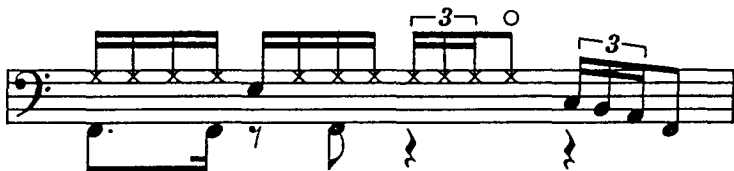

Ptn 35 Fill 09

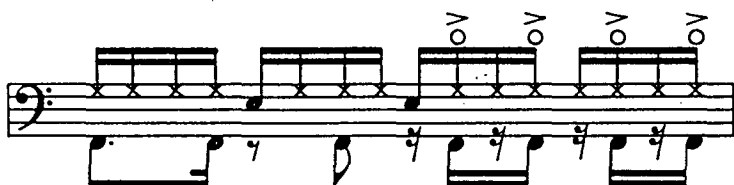

Ptn 36 Fill 10

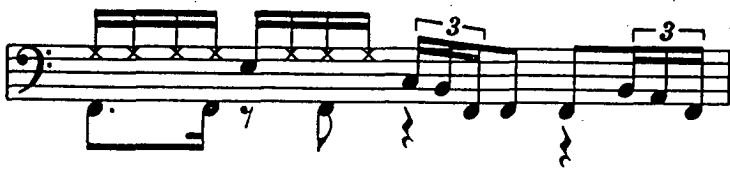

Ptn 37 Fill 11



Ptn 38 Fill 12



Ptn 39 Fill 13



Ptn 40 Fill 14



Ptn 41 Fill 15



Ptn 42 Fill 16



Ptn 43 Fill 17

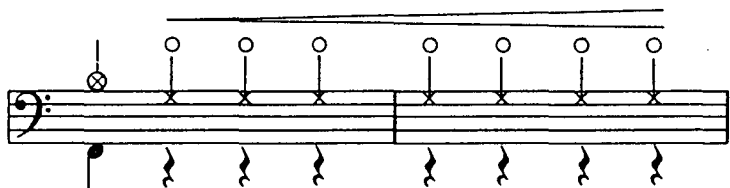

Ptn 44 Fill 18

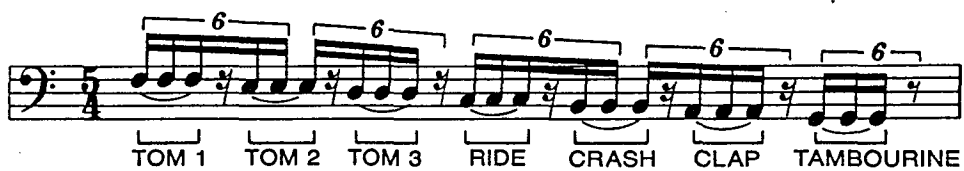

Ptn 45 Fill 19



Ptn 46 Fill 20

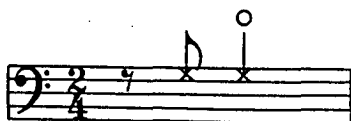

Ptn 47 Fill 21



Ptn 48 Fill 22



Ptn 49 Fill 23

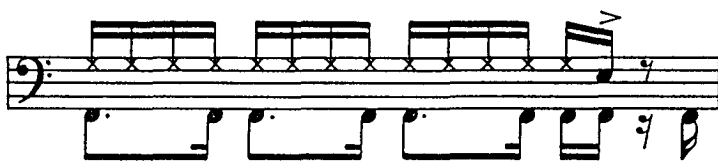

Ptn 50 Ending

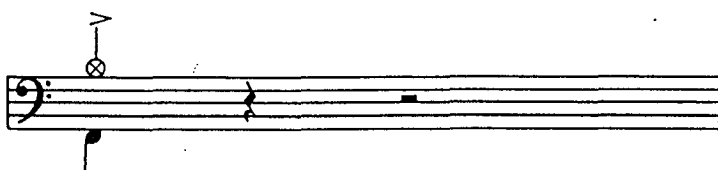

■ソング1~3には以下のようにパターンが書き込まれています。

The following PATTERNS are written in SONGs 1~3.

Song 1 (8 Beat)

(Pattern Number) 21 — 24 — 02 — 25 —
21 — 26 — 02 — 27 —
21 — 28 — 02 — 45 —
23 — 22 — 22 — 39 —
23 — 22 — 22 — 42

Song 2 (16 Beat)

(Pattern Number) 37 — 29 — 34 — 12 — 32 —
29 — 36 — 12 — 35 —
31 — 30 — 30 — 38 —
31 — 30 — 30 — 39 —
31 — 40 — 43

Song 3 (Latin)

(Pattern Number) 46 — 17 — 47 — 17 — 43 —
18 — 49 — 18 — 40 —
20 — 20 — 20 — 20 — 50