

DVP-1

DIGITAL VOICE
PROCESSOR
OWNER'S MANUAL



KORG

DVP-1

Thank you and congratulations on your purchase of the KORG DVP-1. To obtain optimum performance and assure long service life, please read this manual carefully before using this product.

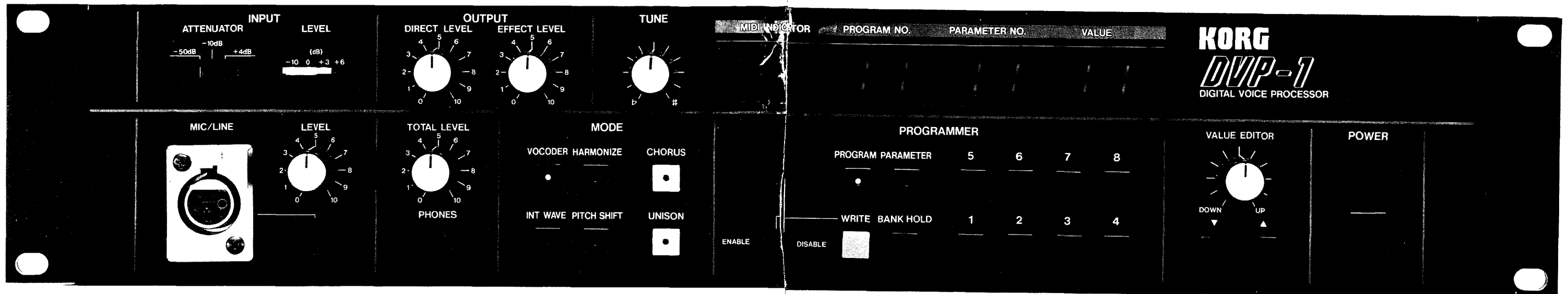

MAJOR FEATURES

1 A completely new kind of MIDI voice processor using a new high speed voice processor LSI chip. Enables vocoder, polyphonic harmonize, and other highly useful effects.

2 In the vocoder mode, this takes the tonal elements of the audio input signal that are vital to voice recognition, these are the consonants and vowel formants, and reproduces these speech characteristics at the pitch produced by playing a MIDI keyboard.

Unlike the analog vocoders of the past, the DVP-1 delivers clear, lucid sound quality, thanks to its digital processing technique.

A number of timbre parameter controls enable adjustment of the sound to obtain a variety of effects such as female chorus, male chorus, electronic voice, and so on.

The internal wave mode produces vocoder-like effects based on internally stored waveforms, without any external input.

Both the vocoder and internal wave modes allow polyphonic production of up to five notes at a time.

3 In the harmonize mode, playing a connected MIDI keyboard controls the amount of pitch shift of the harmonize module. Pitch can be shifted up to one octave above and below the pitch of the input signal. Polyphonic production of up to five notes at once is possible. This "polyphonic harmonized" sound is completely new and different, offering an exciting new sonic palette to the musician.

There is even a "chord memory" function that lets you produce harmonies without connecting a MIDI keyboard.

4 Pitch Shift mode lets you use this like a conventional harmonize effect. Input signal pitch can be shifted over a range of $-1200 \sim +1299$ cents. Chorus, detuning, octaves, and other harmonize effects are easily executed.

5 Digital chorus effects are built in. This clear chorus effect can be added in any mode.

6 Has a "unison function" with detune control. Effective for giving extra body to the sound in the vocoder mode, internal wave mode, and harmonizer mode. (The detune control can be used in the pitch shift mode as well.)

7 Programmer section holds 64 different settings in memory. Stored mode, parameters used for that mode, chorus and unison on/off status.

8 New "Key Window" MIDI function. Can provide split keyboard effects with keyboards that have no split feature (using the EX-8000 for example). Key window lets you use the DVP-1 to set the range of received note data.

9 Has portamento and hold functions controllable by foot switch or MIDI. Usable in vocoder and internal wave modes.

10 The "Freeze" function cuts off part of the external input signal waveform and loops it for use as the virtual input signal, MIDI or a foot switch can be used to turn on the freeze function during external input. Thereafter, no external signal input is needed — the "frozen" signal is used instead. (Effective in the vocoder, harmonizer, and pitch shift modes.)

11 Built-in noise gate cuts out unwanted noise from the input signal. Helps avoid feedback and provides cleaner results in vocoder, harmonizer, and pitch shift modes.

IMPORTANT PRECAUTIONS

■ PLACE OF USE

Do not use this unit for long periods of time where it is exposed to:

- direct sunlight.
- high temperature or humidity.
- sand or dust.

■ POWER SUPPLY

- Use only with rated AC voltage. If you will be using this unit in an area having a different voltage, be sure to use a proper voltage converter.
- To assure highest sound quality, avoid connecting many units to the same outlet via extension cords, etc.

■ INTERFERENCE

This unit uses microcomputer circuitry. Like all such devices it is subject to interference from nearby electrical devices like fluorescent lamps, appliances with motors, and so on. If operation becomes erratic or unpredictable, or if there is no response when you press a button on the unit, then interference may be the cause. If this occurs, try turning off the power, then turning it back on again. This resets (or initializes) the microcomputer chip.

■ HANDLE WITH CARE

All controls are designed to provide positive operation with a gentle touch. Do not use force.

■ CLEANING

If necessary, wipe the exterior of this unit with a soft dry cloth. Never use volatile cleaning agents such as benzine, alcohol, or flammable polishes.

■ KEEP THIS MANUAL

For future reference, please store this manual in a safe place.

■ BACKUP BATTERY

The DVP-1 has an internal backup battery that protects memory contents when the power is turned off. This battery lasts for about five years. After five years please consult your Korg service center or dealer to have the battery replaced.

CONTENTS

FEATURES AND BASIC SETUP	6
1 Front Panel/Rear Panel	6
2 Basic Setup	8
BASIC OPERATION	11
1 Program Selection	11
2 Value Editing	13
DVP-1 MIDI OPERATION	17
1 Messages Recognized	17
2 MIDI Parameters	19
3 Key Window	21
4 MIDI Indicator and MIDI Reset Function	23
VOCODER MODE AND INTERNAL WAVE MODE	24
1 Operation of Vocoder Mode and Internal Wave Mode	24
2 Parameters for Vocoder Mode and Internal Wave Mode	25
HARMONIZE MODE	35
1 Harmonize Mode Operation	35
2 Parameters for Harmonize Mode	37
PITCH SHIFT MODE	41
1 Pitch Shift Mode Operation	41
2 Parameters for Pitch Shift Mode	42
OTHER FUNCTIONS	43
1 Chorus	43
2 Unison	44
3 Gate	46
4 Freeze	48
PROGRAM WRITE (Writing Programs to Memory)	50
1 What Can Be Stored	50
2 Program Write Operation	51
3 Program Transfer and Editing	52
MIDI IMPLEMENTATION	53
1 Transmitted Data	53
2 Recognized Receive Data	55
3 Using the System Exclusive Messages	59
SPECIFICATIONS & OPTIONS	65

1. Front Panel/Rear Panel

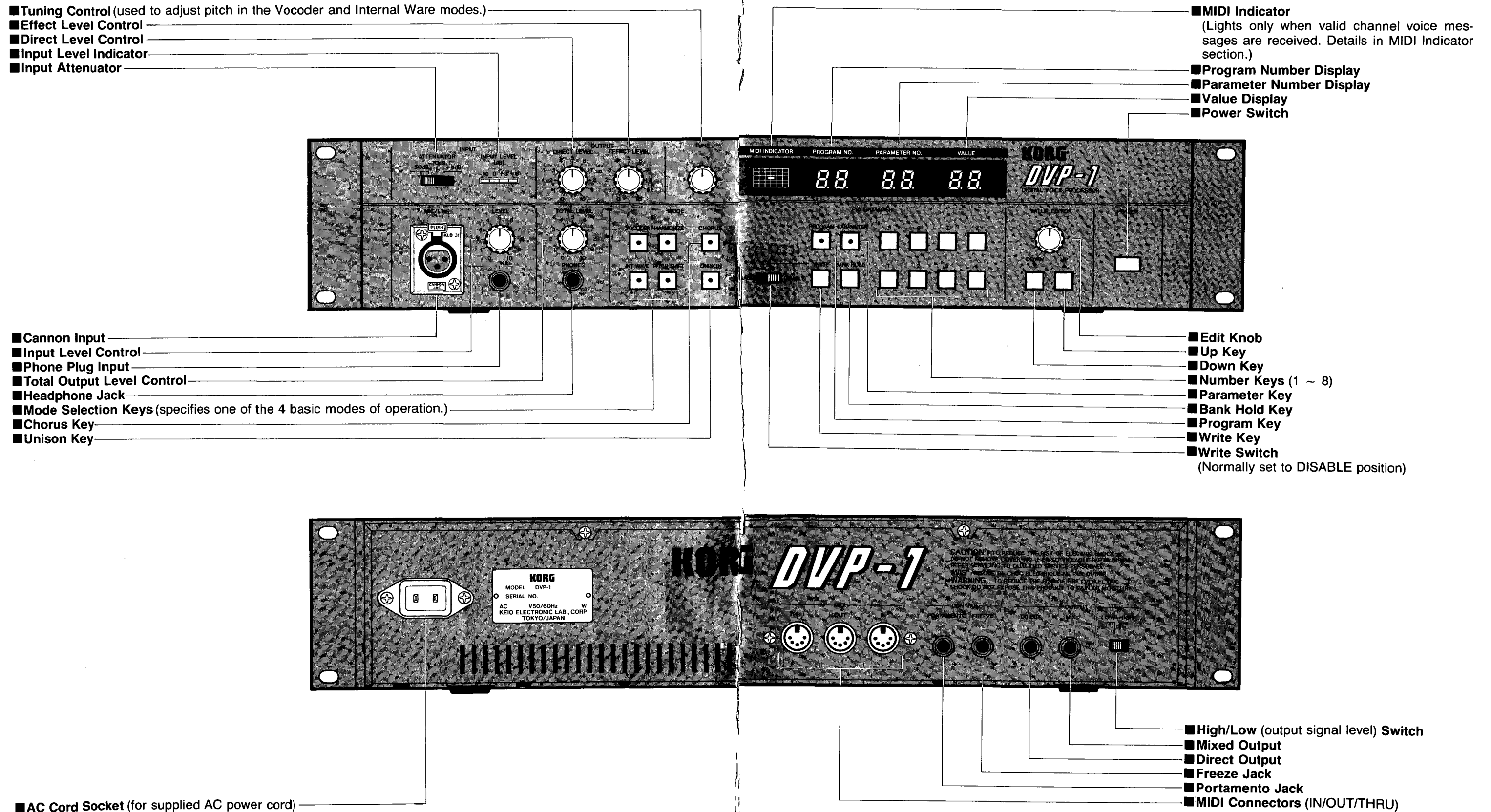

2. Basic Setup

1 Input Section

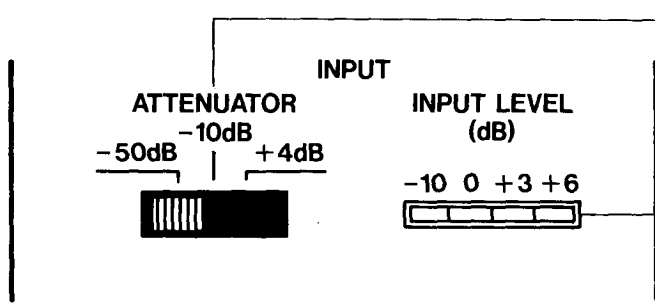

■ Set input attenuator to match input signal source.

Source	Attenuator Position
Microphone	-50dB
Line	-10dB
PA mixer output, etc.	+4dB

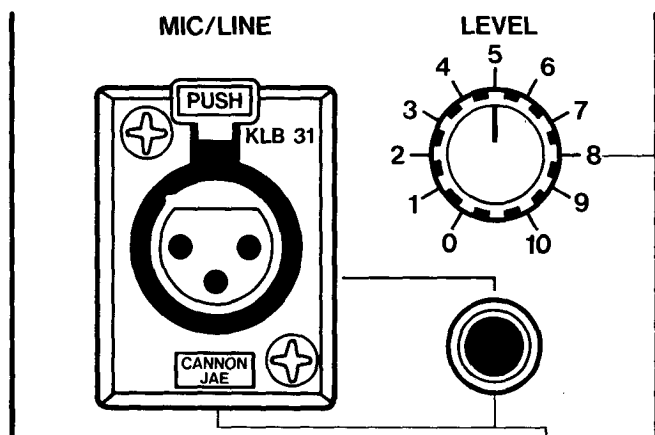

■ To assure positive operation, adjust the input level control so that the +6dB LED illuminates occasionally.

■ Connect input signal source to one of these two jacks. A plug inserted in the phono plug input (regular guitar cord type jack) cancels input to the Cannon connector.

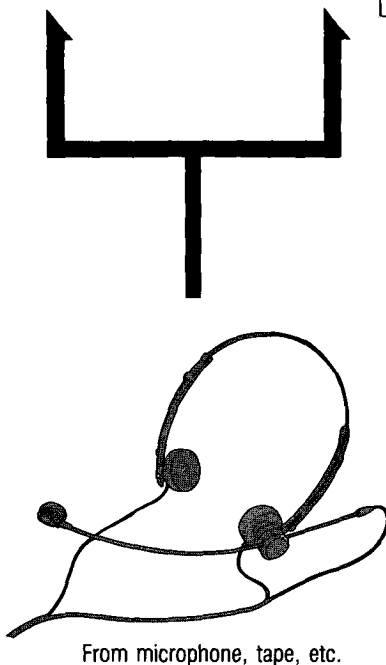

2 Output Section

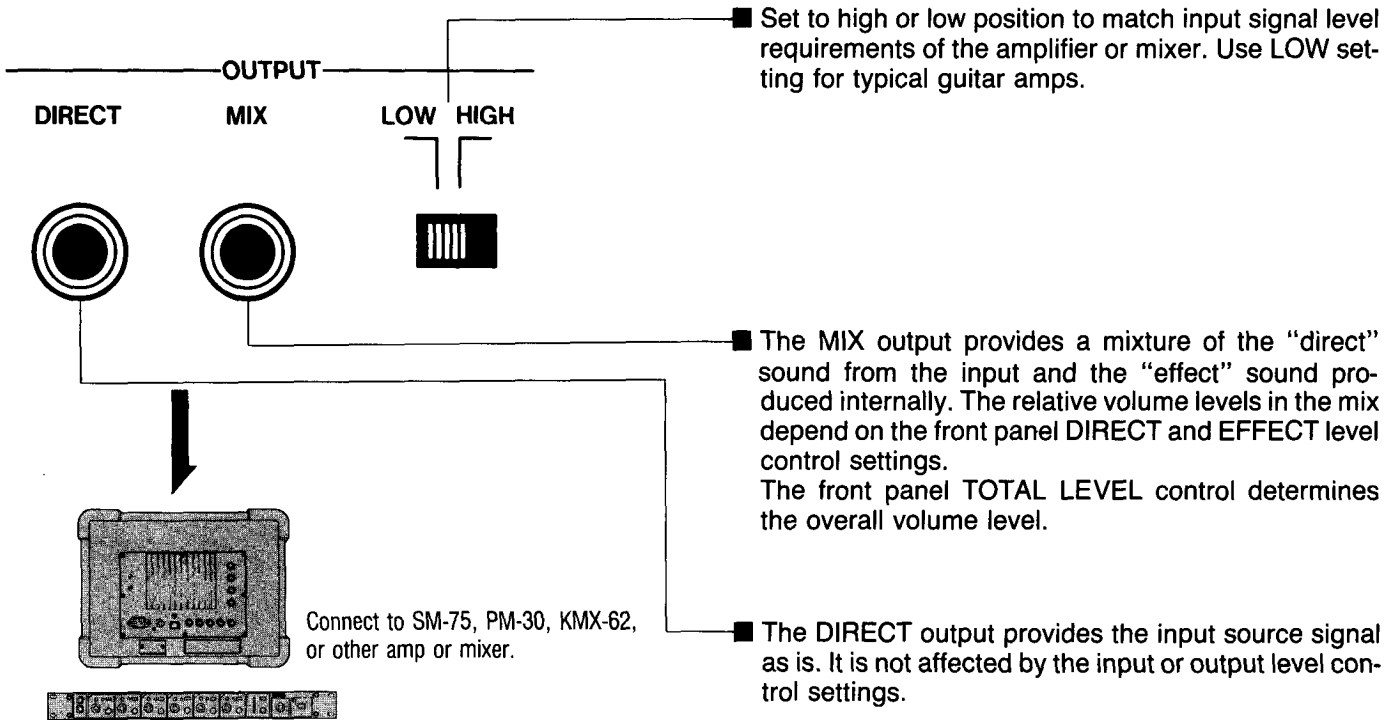

3 MIDI Section

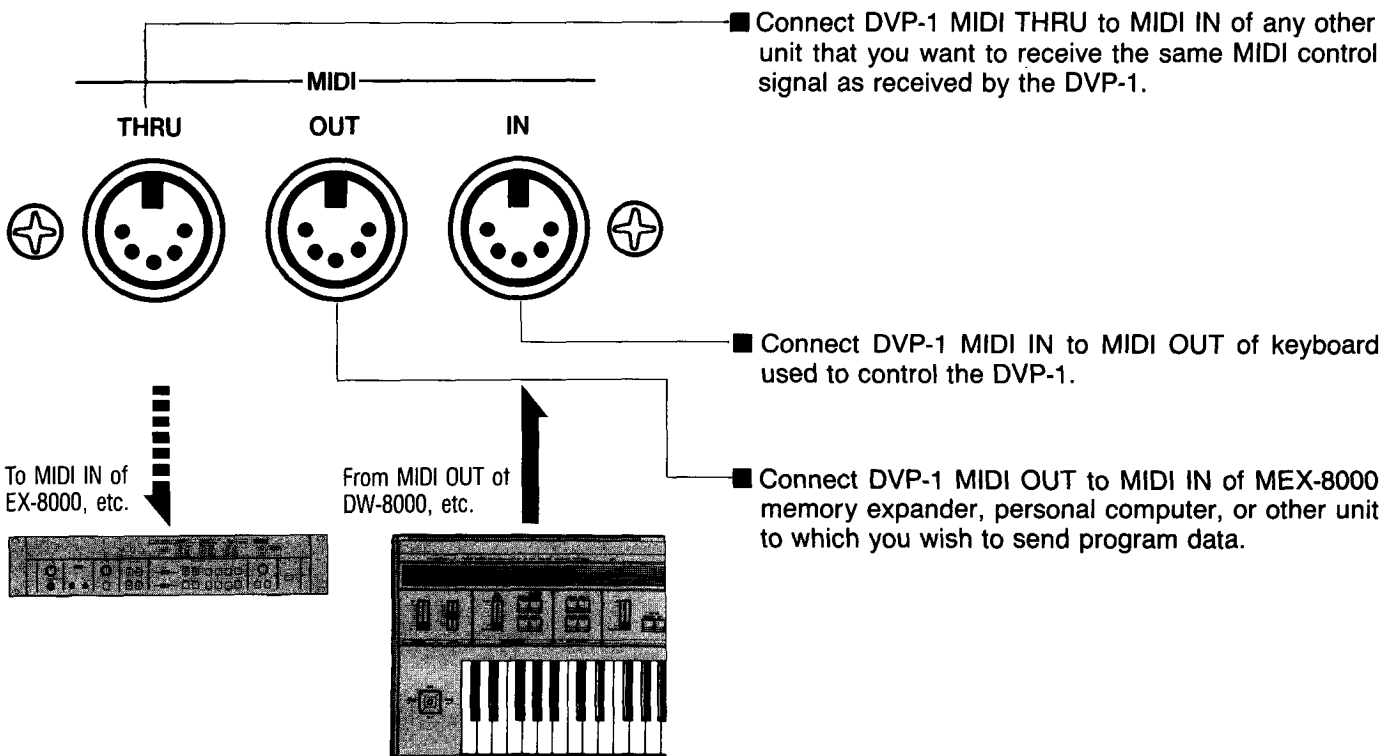

FEATURES AND BASIC SETUP

4 Rack Mounting Procedure

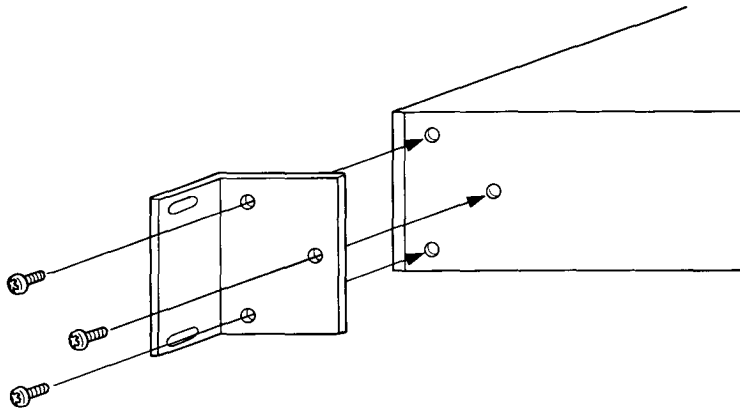

Use supplied small screws to fasten supplied rack mount adaptors to left and right sides of DVP-1.

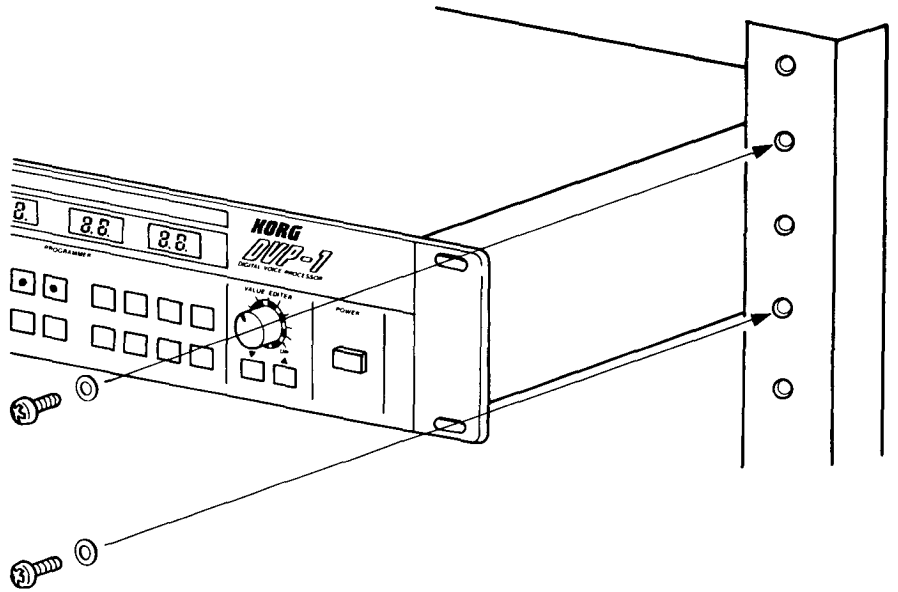

Use supplied large screws to fasten to frame.

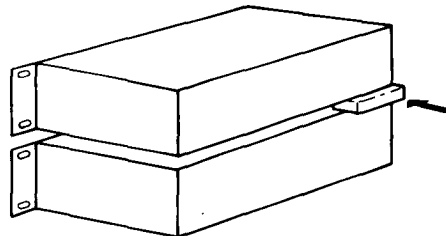
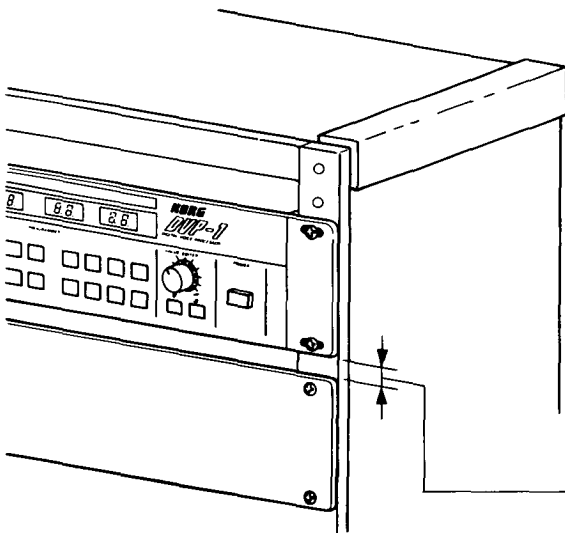

If there is more than a 3mm gap between units then insert something in the back to hold them apart.

BASIC OPERATION

1. Program Selection

1 Using the programmer to select settings.

- The DVP-1 can store up to 64 different settings in its programmer memory for instant recall. Each setting includes the mode, parameter values, etc.

Each setting or "program" has a 2-digit number between 11 and 88 ("9" and "0" are not used). This is called its "program number."

You retrieve an effect by selecting its program number. Likewise, you must select a number to assign to a program when you to store it. This process is called "program selection."

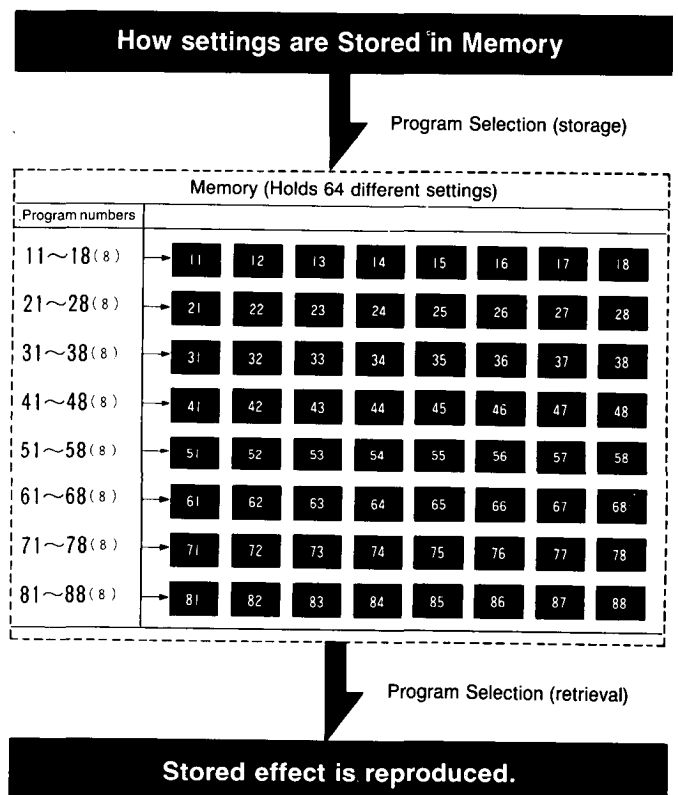

BASIC OPERATION

2 Program Selection

- Follow this procedure to select programs by using the controls on the DVP-1 itself. (Selection is also possible via MIDI.)

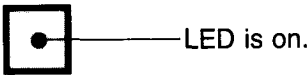
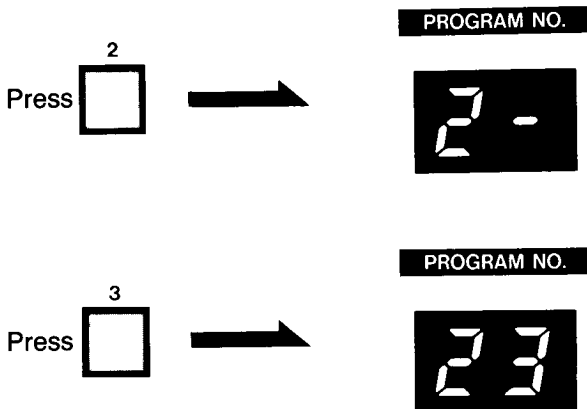
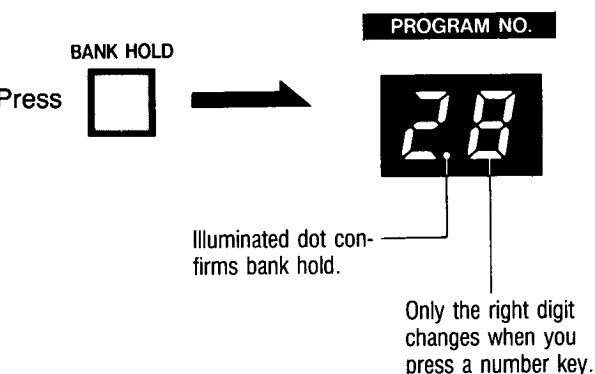
Procedure	Display and controls
<p>① Press the program key so that its LED illuminates. (This key lights automatically after power is turned on.)</p>	<p>PROGRAM</p> 
<p>② Press the number keys to select a 2-digit number between 11 and 88.</p> <p>★ If you press the BANK HOLD key then the left digit will not change. Pressing the number keys will affect only the right digit. This can simplify selection if you want to use or check several numbers that use the same left digit. Press BANK HOLD again to return to normal.</p>	<p>Example: To select program number 23.</p>  <p>Example: To select other numbers that start with "2".</p> 

- The DVP-1 responds to MIDI program change messages. This means that you can use the connected controlling MIDI keyboard to change program numbers. (Details in MIDI Parameter section.)

2. Value Editing

1 Parameters and Values

■ Parameters are the factors that affect aspects of the sound such as pitch and timbre. Parameters also determine reception of MIDI messages.

Each parameter has several possible values. The combination of parameter values creates particular effects.

■ The available parameters and range of values are shown on the parameter list on the top of the DVP-1. For example, to change chorus intensity, you select parameter 72 then specify a value between 1 and 4.

Chorus parameters

CHORUS		
71	SPEED	1 ◀ ▶ 4
72	INTENSITY	1 ◀ ▶ 4
73	EFFECT	1 ◀ ▶ 3

Parameter number 72 is chorus intensity.

The permissible values are 1~4.

BASIC OPERATION

2 Modes and Parameters

- The parameters that you use depend on the DVP-1 mode, as shown here.

PARAMETER LIST

VOCODER. INT WAVE		INTERNAL		PITCH EG		MG		HARMONIZE		PITCH SHIFT		CHORUS		GATE	
11	FORMANT SHFT -15 ~ + 15	21	WAVEFORM 1 ~ 8	31	ATTACK 0 ~ 15	41	FREQUENCY 0 ~ + 15	51	KEY NOTE C1 ~ C6	61	SHIFT LEVEL COARSE -12 ~ + 12	71	SPEED 1 ~ + 4	81	THRESHOLD 0 ~ + 7
12	KBD TRACK 0 1 2			32	DECAY 0 ~ + 15	42	DELAY 0 ~ + 15	52	KEY CHANGE DISABLE 0 ENABLE 1	62	FINE 0 ~ + 99	72	INTENSITY 1 ~ + 4	82	DECAY 0 ~ + 7
13	WINDOW LENGTH 1 ~ 8			33	POLARITY 1 2	43	PITCH 0 ~ + 15	53	CHORD MEMORY DISABLE 0 ENABLE 1			73	EFFECT 1 ~ + 3	83	CHANNEL 1 ~ 16
14	BREATH BYPASS LEVEL 0 ~ + 7			34	INTENSITY 0 ~ + 15	44	DCA 0 ~ + 15	54	CHORD NOTE 1 -12 ~ + 12			74	DETUNE 0 ~ + 3	84	ENABLE MIDI DATA 1 2
15	LEVEL THRESHOLD 1 2			35	DCA EG ATTACK 0 ~ + 15	45	BEND PITCH 0 ~ + 12	55	NOTE 2 -12 ~ + 12					85	OMN ON 0
16	PITCH THRESHOLD 1 2			36	RELEASE 0 ~ + 15	46	FORMANT 0 1	56	NOTE 3 -12 ~ + 12					86	KEY W BOTTOM C1 ~ C6
	☐ VOCODER MODE ONLY					47	PORTAMENTO TIME 0 ~ + 15	57	NOTE 4 -12 ~ + 12					87	KEY W TOP C1 ~ C6
						48	HOLD OFF 0 ON 1	58	NOTE 5 -12 ~ + 12 --:OFF					88	FOOT SWITCH DISABLE MODE 1 MODE 2 0 1 2

★ Parameters used with vocoder mode and internal wave mode.

★ Harmonize mode parameters.

★ Pitch shift mode parameters.







★ Parameters used regardless of mode.

(Parameters 14, 15, 16 have no effect on the internal wave mode.
Parameter 21 cannot be used with the vocoder mode.)

- Parameters not used with a particular mode can not be selected or edited in that mode.
Example: If the vocoder mode has been selected then you cannot select or edit the "51 KEY NOTE" parameter of harmonize mode.
However, parameters 71~74 and 81~84 (the chorus, unison, gate, and MIDI parameters) are always accessible for editing regardless of the current mode.

3 Value Editing

■ Follow this procedure for changing (editing) parameter values.

Procedure	Display and Controls
<p>① Press the PARAMETER key to turn it on.</p>	<p>PARAMETER</p>  LED is on.
<p>② Refer to the top panel parameter list to find the number of the parameter that you want to change. Select that number by pressing the number keys (1 ~ 8). (Most of the parameters are specific to particular modes and can only be selected in those modes. If you want to adjust a particular parameter you may have to change to a mode that uses that parameter.)</p> <p>★ Bank hold can be used to speed selection of parameters that share the same left digit. Press once to hold the left digit then use the number keys to change the right digit. Press bank hold again to release the left digit.</p>	<p>Example: To change the MIDI receive channel you use parameter number 83.</p> <p>Press  →  PARAMETER NO.</p> <p>The horizontal bar stays until you input the second digit. (This indicates that the unit is waiting for input.)</p> <p>Press  →  PARAMETER NO.</p> <p>Example: To edit several parameters that start with "8".</p> <p>Press  →  PARAMETER NO.</p> <p>Illuminated dot confirms bank hold.</p> <p>Only the right digit changes when number keys are pressed.</p>

BASIC OPERATION

- ③ Once a parameter number is selected, its current value appears in the VALUE display. Now you can use the value editor control knob or Up/Down keys to adjust the value.

★ The dot in the lower right corner of the display illuminates if you change the value. This reminds you that a change has been made. (But it does not illuminate for MIDI and GATE parameter numbers 81 ~ 88.)

★ Edited values (with dot illuminated) can be returned to their previous values by pressing the Up key and Down key at the same time.

VALUE EDITOR

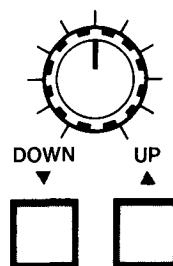

VALUE



Dot illuminates to confirm edit condition.

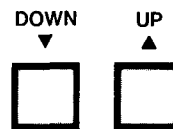

Press Up key and Down keys to cancel edit.

DVP-1 MIDI OPERATION

1. Messages Recognized

■ The DVP-1 responds to MIDI messages according to the mode that it is in. This chart shows the relationships between messages and modes.

Message \ Mode		Vocoder	Internal Wave	Harmonize	Pitch Shift
Note Off (velocity ignored)		○	○	○	
Note On (velocity ignored)		○	○	○	
Control change	No.1 Pitch modulation	○	○		
	No.2 DCA Modulation	○	○		
	No.7 Volume control	○	○	○	○
	No.64 or 69 Freeze switch	○		○	○
	No.65 Portamento (hold) switch	○	○		
Program Change		○	○	○	○
Pitch Bender Change		○	○		
All Notes Off		○	○	○	
Omni Mode Off		○	○	○	○
Omni Mode On		○	○	○	○
Active Sensing		○	○	○	○
System Exclusive		○	○	○	○

★ Only System Exclusive Messages can be transmitted as well as received. For details, refer to the MIDI Implementation section.

■ When a MIDI note on message is received then sound is produced at the pitch determined by the message's note number which may be within the range of 24 ~ 84 (C1 ~ C6).

★ Valid note number range.

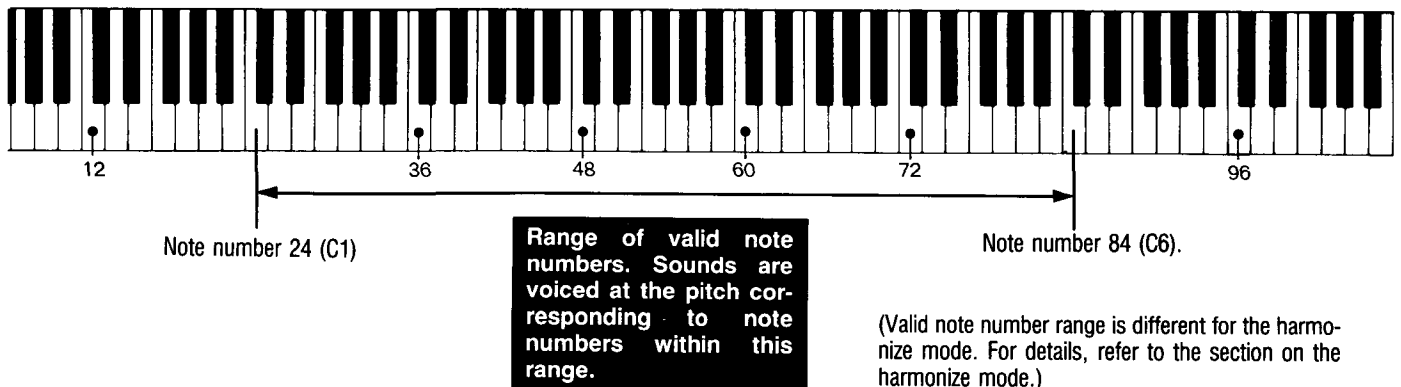

DVP-1 MIDI OPERATION

■ If a note number beyond this range is received then it will be sounded as the same note name but the pitch will be "folded back" to the nearest octave.

★ Out of range note number "foldback."

Example 1: If received notes are 0 (C-1), 7 (G-1), 12 (C0), 19 (G0), then the pitch is transposed as shown here. (Note: C-1 is an octave below C0.)

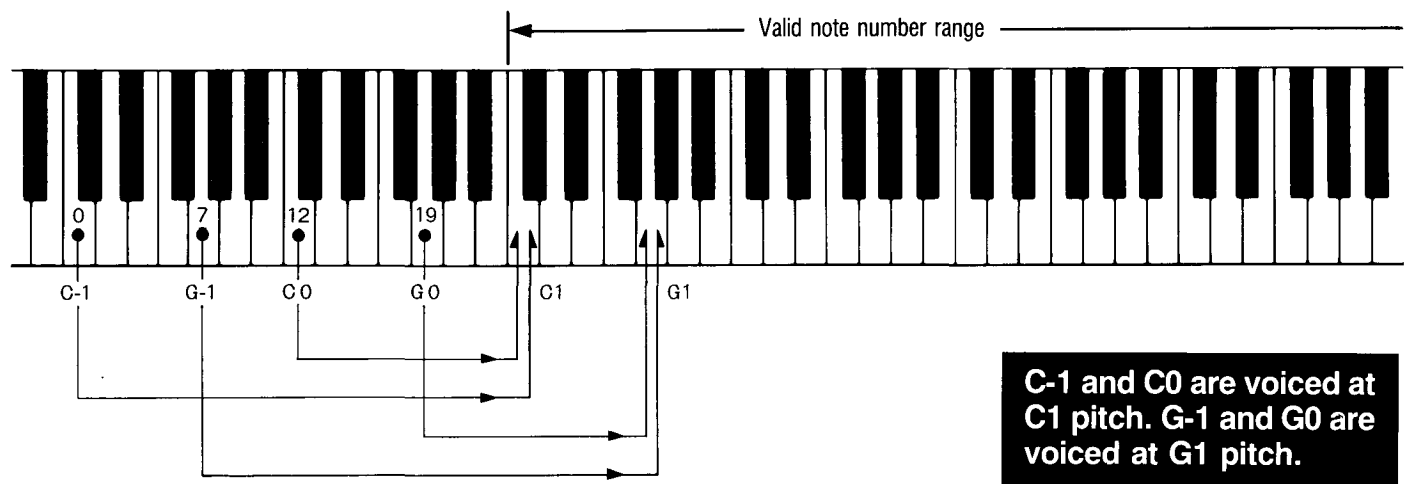

Example 2: If received notes are 91 (G6), 96 (C7), 103 (G7), 108 (C8), then the pitch is transposed as shown here.

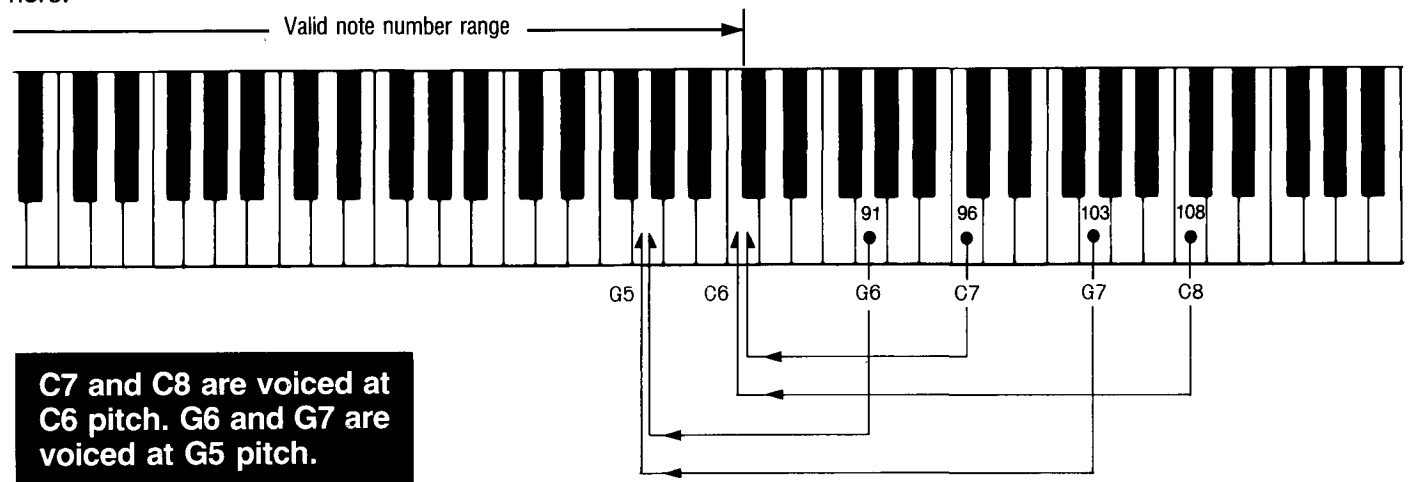

2. MIDI Parameters

MIDI			
83	CHANNEL	1	▶ 16
84	ENABLE	NOTE DATA	ALL
		1	2
85	OMNI	OFF	ON
		0	1
86	KEY W. BOTTOM	C1	▶ C6
87	KEY W. TOP	C1	▶ C6
88	FOOT SWITCH	DISABLE	MODE 1
		0	1 2

These parameters need to be set if you want to turn OMNI off and match the DVP-1 receive channel to the controlling synthesizer's send channel, if you want to use several MIDI sound source units, etc. The current values of these parameters are stored when the unit is turned off and come up again when the unit is turned on. (But they cannot be stored in the programmer section together with other settings.)

83

CHANNEL

Sets the MIDI receive channel number.

Value	Receive Channel
1	ch1
↑ ↓	↑ ↓
16	ch16

84

ENABLE

This sets what type of MIDI data the DVP-1 receives. Set value to 1 if you want the DVP-1 to ignore messages like program change, pitch bend, control change, etc. (Only Active Sensing message is recognized regardless of this value.)

Value	Data Recognized
1	NOTE DATA Responds only to Note ON and Note OFF data.
2	ALL Recognizes all messages (within DVP-1 reception range.)

85

OMNI

Switches the Omni mode on and off. At value 1, all messages are received regardless of their channel number. Omni mode on/off status is changed by receiving an "Omni mode on" or "Omni mode off" message. Omni mode turns off if parameter 83 is selected.

Value	OMNI Mode
0	OFF
1	ON

DVP-1 MIDI OPERATION

86

KEY W. BOTTOM (Key window bottom)

Sets the lowest note that the DVP-1 will produce. Effectively changes the bottom end of the valid note range. Received notes below this limit will not be sounded.

Note that setting this to $\text{C}1$ eliminates the bottom of the key window, and reactivates "foldback" so that the DVP-1 will respond to notes below C1.

Any note value can be selected, from C1 to C6, in semitone steps. The dot in the value display indicates a sharp (#).

Example: $\text{C}.2 = \text{C}2\#$

★ For details, see P.21 the key window section.

Value	Lowest note sounded
$\text{C}1$	Key window bottom limit is deactivated. C#1 ↓ (Adjustable in semitone steps) C6
$\text{C}.1$	
↓	
$\text{C}6$	

87

KEY W. TOP (Key window top)

Sets the highest note that the DVP-1 will produce. Effectively changes the top end of the valid note range. Received notes above this limit will not be sounded. Note that setting this to $\text{C}6$ eliminates the top of the key window, and reactivates "foldback" so that the DVP-1 will respond to notes above C6.

Any note value can be selected, from C1 to C6, in semitone steps. The dot in the value display indicates a sharp (#).

Example: $\text{C}.5 = \text{C}\#5$

★ For details, see the key window section.

Value	Highest note sounded
$\text{C}1$	C1 ↓ (Adjustable in semitone steps) B5 Key window top limit is deactivated.
↓	
$\text{B}5$	
$\text{C}6$	

88

FOOT SWITCH

Freeze and portamento functions can be turned on and off by foot switch or by MIDI "Control Change" messages.

This parameter's value determines which, if any, control numbers will be used to switch which functions. At value 0, MIDI messages will not affect these functions. At value 1, control No. 64 switches the freeze function and control No. 65 switches the portamento function.

At value 2, control No. 65 switches the portamento function and control No. 69 switches the freeze function.

★ For details, refer to the sections on MIDI control of portamento and hold, and MIDI control of freeze.

Value	MIDI CONTROL
0	OFF
1	No.64 is freeze switch No.65 is portamento switch
2	No.65 is portamento switch No.69 is freeze switch

3. Key Window

1 Key window concept

- The DVP-1 ordinarily voices sounds within the range shown here according to the pitch of note numbers included in received MIDI note data.

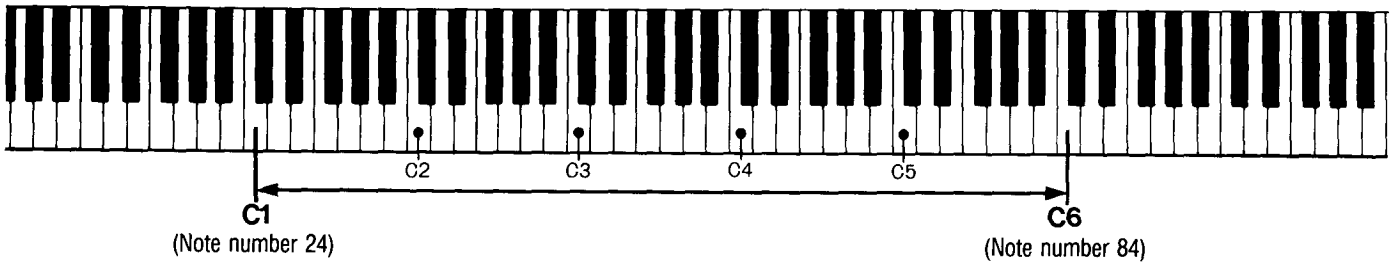

- The key window function lets you prevent the DVP-1 from voicing notes within a particular pitch range. It also lets you limit the pitch of notes to a particular range.

Therefore you can obtain a split keyboard effect by using the DVP-1 with another unit, such as the EX-8000 synthe module (or a second DVP-1), that has key window capability.

Example: DW-8000 controlling DVP-1 and EX-8000.

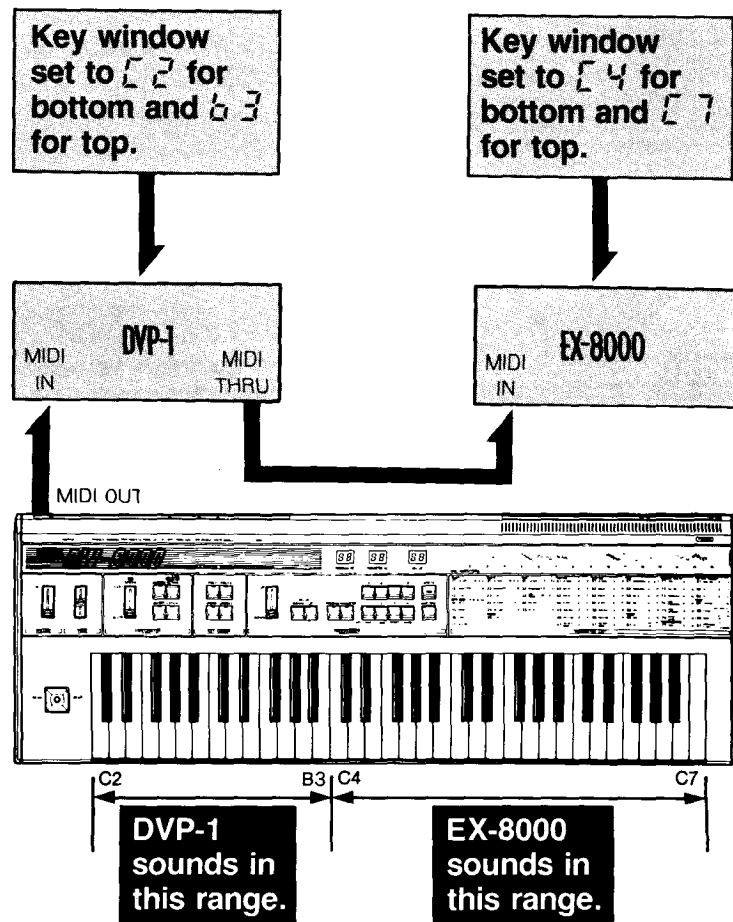

DVP-1 MIDI OPERATION

2 Relationship between Key Bottom and Key Top

■ There are two basic ways to use the key window bottom and top parameter settings.

① Bottom set lower than top.

Example: Key window bottom is set at C2 while top is set at B4.

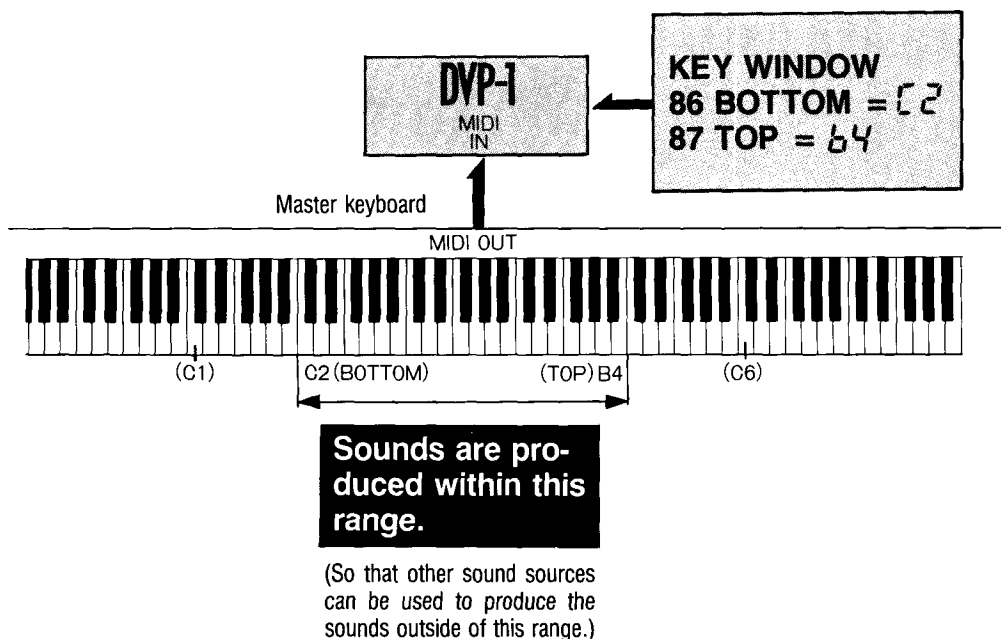

② Bottom set higher than top.

Example: Key window bottom is set at C5 while top is set at B1.

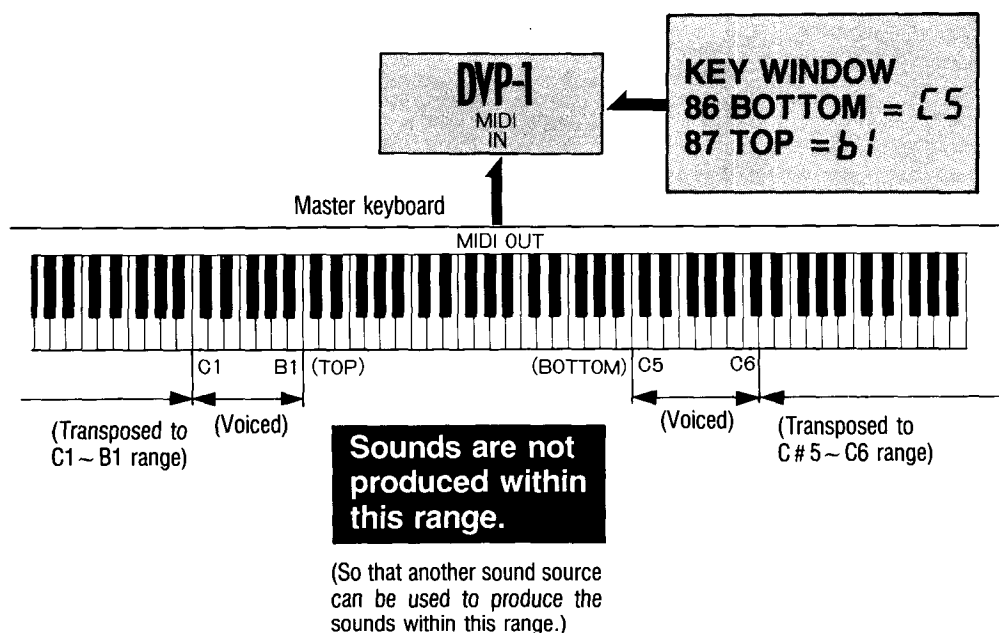

- If the key window bottom is set to $\zeta 1$ then received note numbers lower than C1 will also be produced (by transposing them up to the bottom octave).
If the key window top is set to $\zeta 5$ then received note numbers higher than C6 will also be produced (by transposing them down to the top octave.)
(Using the highest and lowest values effectively turns off the key window function so higher or lower note numbers are “folded back” and sounded by the DVP-1. For more details, refer to the previous section on MIDI parameters. See page 18.)

4. MIDI Indicator and MIDI Reset Function

1 MIDI Indicator

- The front panel MIDI indicator illuminates when a valid channel voice message is received. This lets you check whether a connected MIDI keyboard is controlling the DVP-1 or not.
If you play the keyboard and the MIDI indicator does not illuminate then you may suspect that there is something wrong with the MIDI connection or the sending and receiving channels do not match (if OMNI is off) or the key window bottom and top parameter values are not appropriate.
Check the connection and parameter settings if the MIDI indicator does not light up when it should.

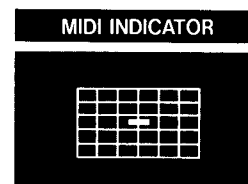

2 MIDI Reset Function

- Sometimes interference may cause erratic MIDI operation. You may get no sound when you should get a sound: the sound may not stop when it should, or pitch bends and modulation may not be released when they should.
In cases like these, press the WRITE key to reset the MIDI circuitry.

The WRITE switch should be set to the DISABLE position when using the WRITE key to reset MIDI. Otherwise you will enter the write mode.

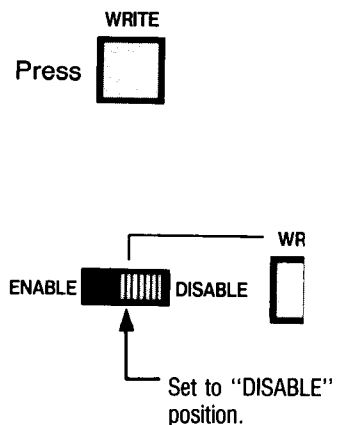

VOCODER MODE AND INTERNAL WAVE MODE

1. Operation of Vocoder Mode and _____ Internal Wave Mode

■ Like the sound of a musical instrument, human speech has elements of pitch and timbre. It is mainly through the fluctuations in timbre over time that we understand the contents of speech.

■ In the vocoder mode it is these elements of timbre that are extracted from the input signal and used to control the quality of the sound, while the pitch is determined by notes played on a MIDI keyboard.

Operation of DVP-1 in vocoder mode.

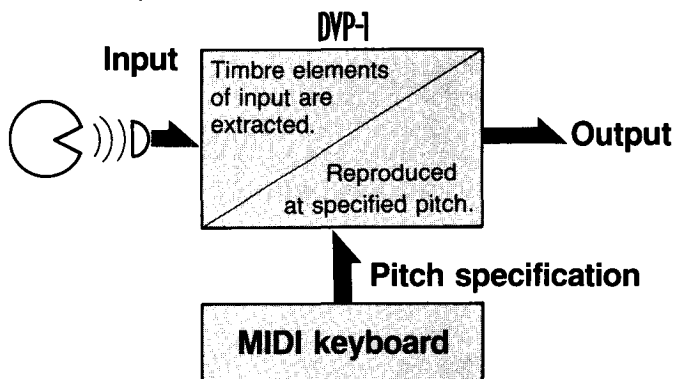

■ In the internal wave mode the DVP-1 uses internally stored waveforms instead of an external input. Otherwise operation is the same in the vocoder mode.

Operation of DVP-1 in internal wave mode.

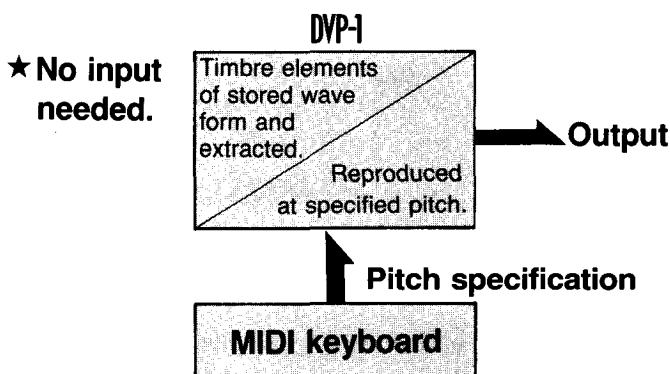

■ Use the mode keys to select the desired mode.

To select the vocoder mode:

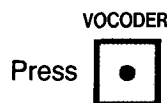

To select the internal wave mode:

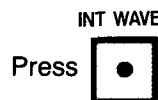

■ Up to five notes can be sounded at once in the vocoder and internal wave modes. (Four notes at once if chorus is on.) Notes can be sounded over a five octave pitch range of C1 through C6. (For details, refer to the section on valid note number range.)

Notes:

- ★ To assure positive vocoder operation it is good practice to speak clearly at steady volume.
- ★ The DVP-1 vocoder mode is designed to work with the human voice as its input. Results may be unpredictable if other kinds of inputs such as guitar or keyboard signals are used.
- ★ Glitches may occur with some input signals.

2. Parameters for Vocoder Mode and Internal Wave Mode

■ The following parameters are used to control vocoder and internal wave mode effects.

VOCODER, INT WAVE

FORMANT		INTERNAL		PITCH EG		MG	
11	SHIFT -15 ◀ ▶ 15	21	WAVEFORM 1 ◀ ▶ 8	31	ATTACK 0 ◀ ▶ 15	41	FREQUENCY 0 ◀ ▶ 15
12	KBD TRACK OFF HALF FULL 0 1 2			32	DECAY 0 ◀ ▶ 15	42	DELAY 0 ◀ ▶ 15
13	WINDOW LENGTH 1 ◀ ▶ 8			33	POLARITY <input checked="" type="checkbox"/> 1 <input checked="" type="checkbox"/> 2	43	PITCH 0 ◀ ▶ 15
BREATH BYPASS				34	INTENSITY 0 ◀ ▶ 15	44	DCA 0 ◀ ▶ 15
14	LEVEL 0 ◀ ▶ 7			DCA EG		BEND	
15	LEVEL THRESHOLD 1 2			35	ATTACK 0 ◀ ▶ 15	45	PITCH 0 ◀ ▶ 12
16	PITCH THRESHOLD 1 2			36	RELEASE 0 ◀ ▶ 15	46	FORMANT OFF ON 0 1
◼: VOCODER MODE ONLY						PORTAMENTO	
						47	TIME 0 ◀ ▶ 15
						48	HOLD OFF ON 0 1

1 FORMANT

FORMANT	
11	SHIFT -15 ◀ ▶ 15
12	KBD TRACK OFF HALF FULL 0 1 2
13	WINDOW LENGTH 1 ◀ ▶ 8

Consonants and vowels characterize the sounds of speech. The vowels are controlled by the shape of the vocal passage. The timbre of vowel sounds is determined by their emphasized frequency zones called "formants."

Parameters 11, 12, and 13 let you adjust the formants, and hence the variations in timbre, to suit your needs.

11 SHIFT

Shifts the formant frequency (vocal passage resonance frequency), thereby changing the timbre of the vowel.

Value	Vowel Tone Color
-15	Expand (slow, old, or male voice)
↓	↓
0	Ordinary voice
↓	↓
15	Reduce (shrill, child's or female voice)

VOCODER MODE AND INTERNAL WAVE MODE

12

KBD TRACK

Determines how the formant frequency follows the keyboard pitch. (That is, to what degree the formant shift parameter moves in the "reduce" direction as higher notes are played). Refer to SHIFT parameter.

Value	Keyboard Tracking
0	OFF (no tracking)
1	HALF
2	FULL (maximum tracking)

13

WINDOW LENGTH

Cuts off part of the input signal waveform to control clarity of vowel sounds.

If parameter 12 KBD TRACK is OFF then this parameter will have little effect on the sound when you play notes in the high range.

Value	Vowel clarity
1	Mumbled
↑	↑
8	Distinct

2 BREATH BYPASS

BREATH BYPASS		
14	LEVEL	0 ◀ ▶ 7
15	LEVEL THRESHOLD	1 2
16	PITCH THRESHOLD	1 2

▶ : VOCODER MODE ONLY

This lets the consonants bypass the vocoder and go directly to the output, thereby enhancing the clarity of vocal expression. For example, if you say the word "she" then the "sh" sound would be passed through directly to the output. Normally, consonants are quieter than vowels and have a larger high frequency component. Therefore a frequency threshold and volume threshold can be used to distinguish vowels from consonants. These parameters are not used in the internal wave mode. (Editing them will have no effect.)

14

LEVEL

This controls the level at which sounds recognized as consonants are sent via the bypass to the output. If feedback is a problem, use a lower value.

Value	Level of bypass consonants
0	No consonant bypass.
↑	↑
7	Maximum level of consonants in output.

15 LEVEL THRESHOLD

Sets the threshold level for discrimination of consonants from vowels. Typically, adjustment of this parameter is helpful when "h" sounds are not intelligible. Consonants are easier to pick up at the 1 than the 2 value.
(At value 1, a low input signal level may result in vowels being sent via the bypass along with consonants.)

Value	Level threshold
1 ↓ 2	Low ("h" sounds are clearer) ↑ High (Keeps vowels from leaking into the output at low input signal levels.)

16 PITCH THRESHOLD

Sets the threshold frequency for vowel/consonant discrimination. Typically, adjustment of this parameter is helpful when "s" sounds are not intelligible. Consonants are easier to pick up at the 1 value than at the 2 value.
(At value 1, a high pitched input signal may result in vowels leaking into the output along with the consonants.)

Value	Pitch threshold
1 ↓ 2	Low ("s" sounds are clearer) ↑ High (Keeps vowels from leaking into the output with high pitched inputs.)

3 INTERNAL

INTERNAL

21
WAVEFORM
1
←
→
8

Offers a choice of internal waveforms to create vocoder effects without using an external input.
Not used in the vocoder mode. (Cannot even be called up in the vocoder mode.)

21 WAVEFORM

Internal wave mode waveform depends on value selected here.

Value	Kind of waveform
1	Female "a" 1
2	Female "a" 2
3	Male "a" 1
4	Male "a" 2
5	Male "a" 3
6	Female "la"
7	Female "lu"
8	Male "wo"

VOCODER MODE AND INTERNAL WAVE MODE

4 PITCH EG

PITCH EG		
31	ATTACK	0 ◀ ▶ 15
32	DECAY	0 ◀ ▶ 15
33	POLARITY	√ ^ 1 2
34	INTENSITY	0 ◀ ▶ 15

This lets you add a pitch variation at the beginning of a note.

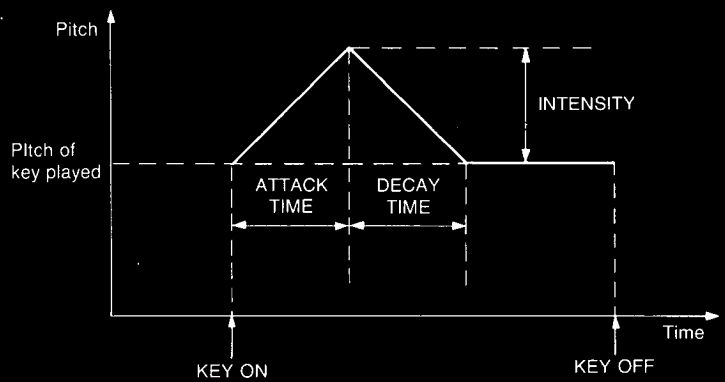

This is used to recreate the kind of slight pitch change that occurs in human speech at the beginning of words. This is effective for producing a more natural effect.

31

ATTACK (Attack time)

Controls the time it takes to attain the maximum change in pitch after a key is played.

Value	Time to maximum pitch change
0	Short
↑	↑
15	Long

32



DECAY (Decay time)

Control the time it takes for pitch to return to normal after it reaches its maximum change (that is, after the attack time).

Value	Time to return to normal
0	Short
↑	↑
15	Long

33 POLARITY

Determines the direction of the change in pitch. A value of 1 causes the pitch to drop below the pitch of the note played and then rise to normal. A value of 2 causes the pitch to rise above the pitch of the note played and then fall to normal.

Value	Polarity
1	 (Drop in pitch)
2	 (Rise in pitch)

34 INTENSITY

Controls the amount of the change in pitch. A value of 0 turns off the PITCH EG so there is no pitch change.

Value	Degree of pitch change
0	None (PITCH EG is OFF)
↑	↑
15	Maximum pitch change

5 DCA EG

DCA EG		
35	ATTACK	0 ◀ ▶ 15
36	RELEASE	0 ◀ ▶ 15

Controls the change in volume over the time between when a key is played and released.

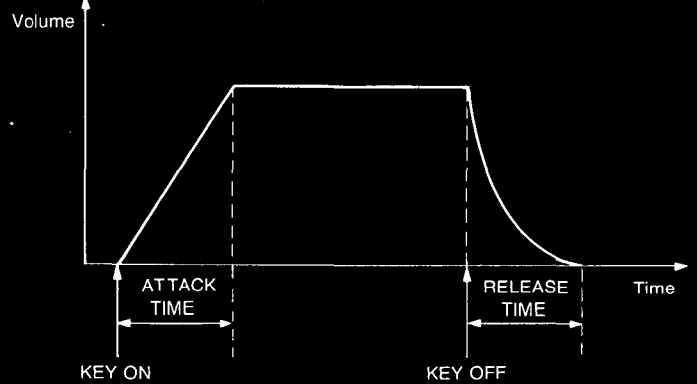

(DCA stands for digital controlled amplifier.)

35 ATTACK

Controls how long it takes for volume to rise to the maximum after a key is played. (If attack is too short then a clicking sound may be heard when a key is played.)

Value	Time to maximum volume
0	Short
↑	↑
15	Long

VOCODER MODE AND INTERNAL WAVE MODE

36 RELEASE

Controls how long it takes for the sound to fade away after a key is released.
(If the release time is too short then a clicking sound may be heard when keys are released.)

Value	Release Time
0	Short
↑	↑
15	Long

6 MG (modulation generator)

MG	
41	FREQUENCY 0 ◀ ▶ 15
42	DELAY 0 ◀ ▶ 15
43	PITCH 0 ◀ ▶ 15
44	DCA 0 ◀ ▶ 15

For vibrato (cyclic variation in frequency) and tremolo (cyclic variation in volume).
(At high modulation intensity, vibrato and tremolo may be accompanied by cyclic noise.)

41 FREQUENCY (Modulation Frequency)

Controls the speed (cyclic variation) of the vibrato or tremolo effect.

Value	SPEED of vibrato or tremolo
0	Slow
↑	↑
15	Fast

42 DELAY (Delay Time)

Controls the time delay before the onset of vibrato or tremolo effect after a key is played.

Value	Delay time
0	Effect begins when key is pressed
↑	↑
15	Long

43

PITCH (Modulation)

Controls vibrato intensity, that is the amount of pitch variation in the effect.

Value	Vibrato intensity
0	No vibrato
↑	↑
15	Maximum vibrato

44

DCA (Modulation)

Controls tremolo intensity (modulation depth).

Value	Tremolo intensity
0	No tremolo
↑	↑
15	Maximum tremolo

★ MIDI Control of Vibrato & Tremolo

Your MIDI keyboard's joy stick or modulation wheel (or related device) can be used to control vibrato and tremolo intensity if operation of these devices causes control No.1 and control No.2 "control change messages" to be sent via MIDI. Control No.1 determines vibrato intensity while control No.2 controls tremolo intensity.

Even if the "43 PITCH" and "44 DCA" parameter values are set to "0", you can add tremolo by using these MIDI controls. Even if the "42 DELAY" parameter is set for a long delay time, vibrato or tremolo will occur immediately if they are controlled via these MIDI control messages.

The frequency of the effect depends on the DVP-1's "41 FREQUENCY" parameter value so vibrato and tremolo speed remain the same regardless of whether you are using these MIDI control messages or using internal control. To use MIDI control for vibrato and tremolo you must have the "84 ENABLE" parameter set to "2" (ALL). (See page 19 "ENABLE")

Example: Modulation intensity (depth) control using the joy stick on the POLY-800, DW-6000, or DW-8000.

Vibrato intensity

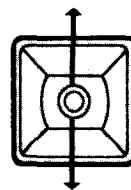

Tremolo intensity

Moving the joystick up controls DVP-1 vibrato depth via the MIDI control No.1 control change message. Moving the joystick down controls DVP-1 tremolo depth via the MIDI control No.2 control change message.

84	ENABLE	NOTE DATA	ALL
		1	2

VOCODER MODE AND INTERNAL WAVE MODE

7 BEND

BEND			
45	PITCH	0	◀ ▶ 12
46	FORMANT	OFF	ON
		0	1

In the vocoder and internal wave modes, pitch and tone color can be changed by MIDI pitch bender messages generated by using the connected MIDI keyboard's joy stick or pitch bend wheel.

The parameters in this section are related to this MIDI pitch bender message control capability.

To use MIDI pitch bend control you must have the DVP-1's "84 ENABLE" parameter set to "2" (ALL). There will be no effect on pitch or tone color if set to the "1" (NOTE DATA) value. (For details, refer to the "84 ENABLE" parameter.)

45

PITCH (Bend)

Controls the maximum rise or fall in pitch occurring in pitch bends.

Value	Maximum pitch change
0	No change
↑ ↓	(Adjustable in semitone steps)
12	± 1 octave

46

FORMANT (Bend)

MIDI pitch bender messages can also be used to shift formants and thereby change the timbre. This capability is turned on or off by the value selected for this parameter.

When this parameter is on (value 1) an upward pitch bend will be accompanied by format shift in the "reduce" direction. A downward pitch bend will be accompanied by a formant shift in the "expand" direction. (For details, refer to the "11 SHIFT" parameter.)

Value	Formant bend
0	OFF
1	ON

8 PORTAMENTO

PORTAMENTO			
47	TIME	0	▶ 15
48	HOLD	OFF	ON
		0	1

DVP-1 Rear Panel

PORTAMENTO F

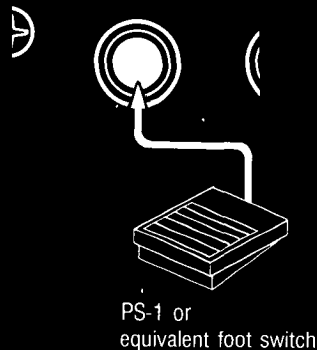

In the DVP-1's vocoder and internal waveform modes you can obtain gradual pitch transitions from note to note when you play one key after another on the MIDI keyboard. This effect is called "portamento." This section also allows notes to be "held" after you release keys on the keyboard. These "hold" and "portamento" effects are controlled by the parameters in this section.

A foot switch (Korg PS-1 or equivalent) connected to the rear panel portamento jack can be used to turn the hold and portamento effects on and off. (MIDI control is also possible.) If foot switch control is used (whether it be an actual switch or a MIDI message), the effect turns on only while the foot switch is depressed. Of course, the parameters must be set so that you can obtain the desired effects.

Note that the portamento foot switch simultaneously controls the hold effect.

47 TIME (Portamento Time)

Portamento is a gradual and continuous change in pitch from one note to the next. The value of this parameter determines how long it takes for the pitch to change.

Value	Portamento time
0	No portamento effect (Portamento off)
↑	↑
15	Long

48 HOLD

When you release a key this effect holds the note as if you had kept the key depressed. This parameter's value determines whether the hold effect is on or off.

Value	Hold effect
0	OFF
1	ON

★ MIDI Control of Portamento & Hold

A MIDI control change message (generated by a MIDI keyboard switch or pedal) from a connected MIDI keyboard can control on/off switching of the portamento and hold effect on the DVP-1.

As when using a foot switch connected to the DVP-1 rear panel portamento jack, you must set parameters 47 and 48 to obtain the effects that you want.

Example: Using the DW-6000 or DW-8000 for control of DVP-1 portamento and hold effects.

DW-6000 or DW-8000 rear panel

ROG. UP PORTAMENTO DAMPER

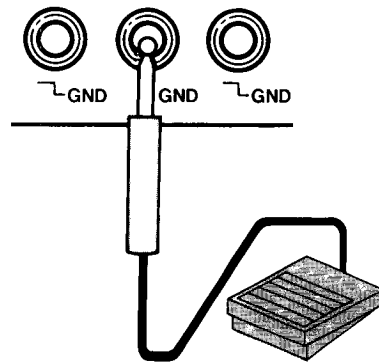

When portamento is operated on the DW-6000 or DW-8000 by a foot switch (or other device) then a No. 65 control change message is sent to the DVP-1 to control its portamento and hold effects.

When using MIDI control for the portamento and hold effects, it is necessary to set the "84 ENABLE" parameter value to "2" (ALL). (For details, refer to the "84 ENABLE" parameter.)

Also, the "88 FOOT SWITCH" parameter value must be set to a value other than "0" (DISABLE). (For details, refer to the "88 FOOT SWITCH" parameter.)

		NOTE DATA	ALL
84	ENABLE	1	2

		DISABLE	MODE 1	MODE 2
88	FOOT SWITCH	0	1	2

HARMONIZE MODE

1. Harmonize Mode Operation

- The Harmonize mode takes the input signal pitch and raises it or lowers it by a particular amount to produce its output. When the input signal pitch changes, the output signal pitch changes too. Pitch can be changed over a range of one octave above or below the input signal pitch. The amount of pitch change can be specified in semitone steps within this range.

Example: To raise input signal pitch by five degrees.

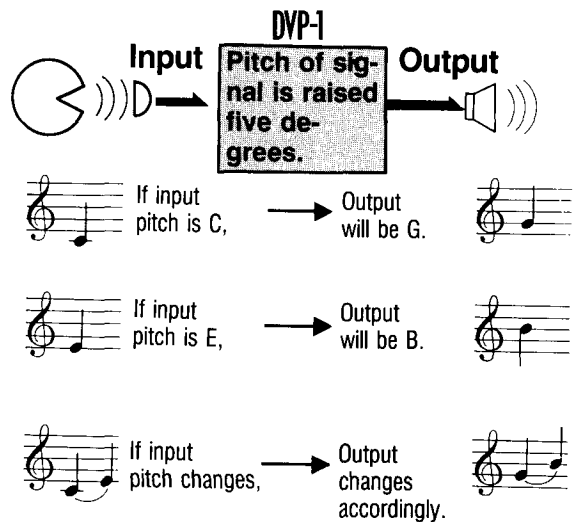

- The Harmonize mode has five harmonize units so it can generate chords of up to five notes. (Only four notes at once are possible when the chorus effect is turned on.)

Example: Pitch change set to "0", "3rd up", and "5th up."

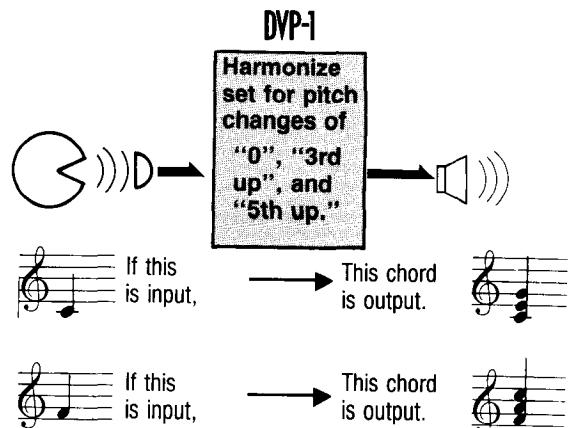

- There are two main ways to use the Harmonize mode. You can use a MIDI keyboard to specify, in real time, the amount of pitch change and "output on/off."

Or you can set the CHORD parameters, ahead of time, to determine the amount of pitch change and "output on/off."

Example: Two ways of using the Harmonize mode.

- ① Control by MIDI keyboard.

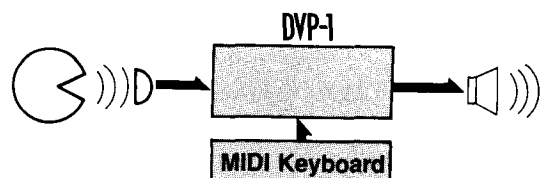

- ② Control by CHORD parameters.

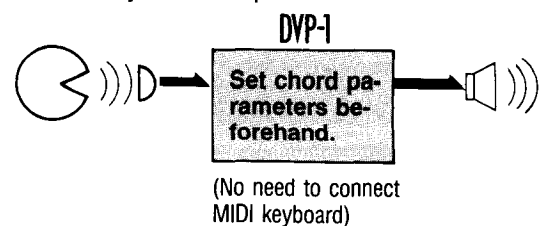

HARMONIZE MODE

■ If a MIDI keyboard is to be used to control the amount of pitch change, then it is necessary to set the "key note" in relation to which you will play other notes, thereby specifying the amount and direction of pitch change. That is, the interval between the key note and played notes determine the amount of pitch change. Likewise, notes played above the key note cause a rise in input pitch: notes played below the key note cause a drop in input pitch. (If you play the key selected as the key note then the amount of pitch change will be "0" and the input will be reproduced in the output without any pitch change.)

■ It does not matter which note is selected as the key note. What determines the amount and direction of pitch change is the relationship between keys played on the keyboard and the specified key note.

■ In the Harmonize mode, pitch changes can be obtained over a range of one octave above and below the input signal pitch. Therefore, you can play keys on the keyboard that are up to one octave higher or lower than the key note. Keys more than one octave removed from the key note will be sounded as if they were played within the nearest valid octave. In other words, they are "folded back" (similar to the situation described in the section on "valid note number range")

■ To select the Harmonize mode, press the HARMONIZE key in the MODE section on the DVP-1 front panel.

Example: With "C" as the key note, keys which must be played to obtain output notes a 3rd above and a 4th below the input signal pitch.

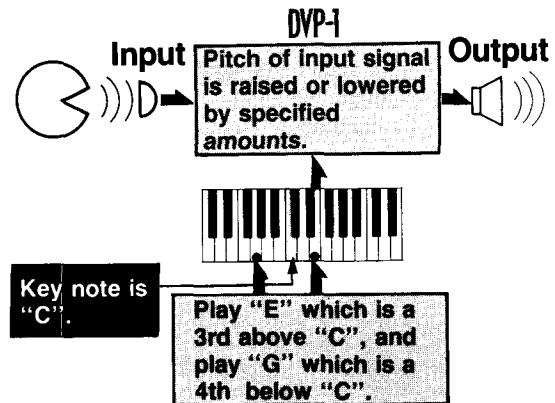

Example: With "F" as the key note, keys which must be played to obtain output notes that are a 3rd above and a 4th below the input signal pitch, as in the previous example.

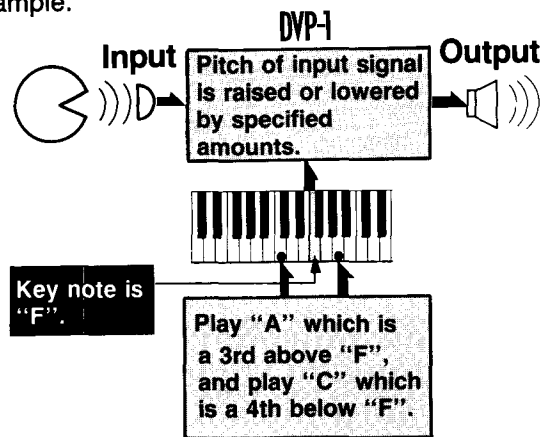

Example: Key note is set to "C3".

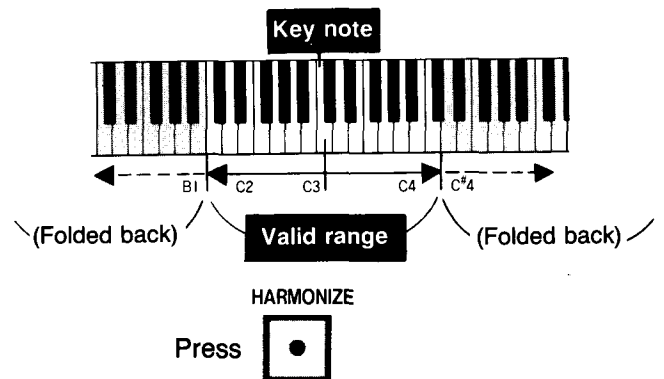

Note: The harmonize mode is designed to work with monophonic inputs. It may not operate normally if chords are present in the input signal.

2. Parameters for Harmonize Mode

■ The following parameters are used to control operation in the Harmonize mode.

HARMONIZE

51	KEY NOTE	C1 ◀ ▶ C6	
52	KEY CHANGE	DISABLE 0	ENABLE 1
53	CHORD MEMORY	DISABLE 0	ENABLE 1
CHORD			
54	NOTE 1	-12 ◀ ▶ 12	
55	NOTE 2	-12 ◀ ▶ 12	
56	NOTE 3	-12 ◀ ▶ 12	
57	NOTE 4	-12 ◀ ▶ 12	
58	NOTE 5	-12 ◀ ▶ 12 --;OFF	

1 CONTROL

Parameters used in the Harmonize mode.

51	KEY NOTE	C1 ◀ ▶ C6	
52	KEY CHANGE	DISABLE 0	ENABLE 1
53	CHORD MEMORY	DISABLE 0	ENABLE 1

51 KEY NOTE

Sets the “key note” used as the reference for determining the direction and amount of pitch change when a MIDI keyboard is employed for control of the Harmonize mode. The “valid keyboard range” for MIDI control of harmonize mode output is one octave below and above the key note. This can be set to any semitone from C1 to C6. A dot on the value indicator means a sharp (#).

Example: [. 4 = C#4

Value	Key note
[1	C1
↑	↑ (Adjustable in semitone steps)
[6	C6

HARMONIZE MODE

52

KEY CHANGE

This parameter's value determines whether the key change function will be on or off.

Value	Key change
0	Disabled (off)
1	Enabled (on)

★ The Key Change Function

The key change function is effective when playing chords on the keyboard. When the key change function is on, then the key note set in the "51 KEY NOTE" parameter becomes ineffective. Instead, the first note that you play becomes the key note (thereby also changing the value of the "51 KEY NOTE" parameter). The input signal pitch is then shifted by the amounts determined by the relationships between other notes played and the key note itself. This creates a chord that includes the original input note pitch.

This lets you set the key note and its surrounding "valid range" (an octave above and below the key note) to wherever you are playing on the keyboard. You can then play chords freely within this new range without considerations of "foldback." (However, the first note played (the one which becomes the key note) must be within the range of C1 to C6). Keys played outside of this range will not cause the key note to change.

Example: Using any initial key, produce a chord consisting of a pitch change of "0", a third up, and a fifth up in relation to the input signal pitch.

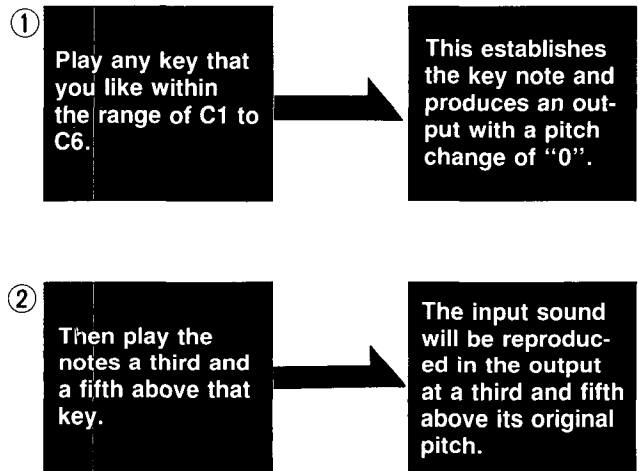

53

CHORD MEMORY

When using a MIDI keyboard for harmonize mode pitch control, sound will be produced only while keys are pressed if the value of this parameter is "0".

However, if you set this parameter's value to "1", then the keys will be "held" after you have released them and sound will continue to be produced. (In this case, the CHORD parameter (numbers 54 ~ 58) pitch change values are set by the relationships between the key note and the notes played above and below it.)

Moreover, if this value is set to "1", then the CHORD parameters (beginning with number 54), can be used to set the amount of pitch change. Output will then be produced according to those values and a MIDI keyboard will not be needed. (Refer to following section on the CHORD parameters.)

Value	Chord memory
0	Disabled (chords not held)
1	Enabled (chords held)

2 CHORD

CHORD			
54	NOTE 1	-12	◀ ▶ 12
55	NOTE 2	-12	◀ ▶ 12
56	NOTE 3	-12	◀ ▶ 12
57	NOTE 4	-12	◀ ▶ 12
58	NOTE 5	-12	◀ ▶ 12 --;OFF

With parameter "53 CHORD MEMORY" set to "/" (enable), you can use these "CHORD" parameters to control the amount of pitch change, if any, produced by each of the five harmonize modules. In this way, you can produce polyphonic output from monophonic input without needing to use a MIDI keyboard.

There are five CHORD parameters from "NOTE 1" to "NOTE 5" which can be set in semitone increments over a ± 1 -octave range.

To set the values (amount of pitch change) for these parameters you can use the VALUE EDITOR controls (DOWN and UP keys, etc.). Or you can set parameter "53 CHORD MEMORY" to a value of "/" and use a MIDI keyboard.

Furthermore, if "53 CHORD MEMORY" is set to "/" and a chord relationship is set up in the CHORD parameter values, then you can store that chord relationship in the programmer memory along with other parameter values. This procedure is described in the later section on the "program write function." (This capability is called "chord memory.")

HARMONIZE MODE



NOTE 1 ~ NOTE 5

Each of these determines whether its harmonize unit is on or off and, if on, what amount and what direction of pitch change it will produce.

If the value display shows "--", the harmonize unit is off and will produce no output.

At values other than "--" the harmonize unit is on and its particular value and sign (- or no sign) refers to the amount and direction of pitch change produced (that is, the number of semitones above or below input pitch).

Numbers preceded by the "-" sign refer to a pitch difference below the input signal pitch. Otherwise the pitch difference is upward.

These values can be set by playing a MIDI keyboard. In this case the parameter number is determined by the order in which the keys are played, while the value is determined by the relationship (number of semitones) above or below the key note.

If the chorus effect is on, then only parameters 54 through 57 are effective. If "unison" is on, then only parameter 54 is effective. (Refer to sections on chorus and unison, respectively.)

Value	Amount of pitch change (on/off status)
--	Off (no output for this unit)
-12	One octave (12 semitones) below input pitch.
↕	↕ (Adjustable in semitone steps)
0	Output with no pitch change
↕	↕ (Adjustable in semitone steps)
12	One octave (12 semitones) above input pitch.
--	Off (No output for this unit)

NOTE:

If two units are set to the same value then the waveforms may cancel each other, producing a drop in volume.

PITCH SHIFT MODE

1. Pitch Shift Mode Operation

■ The Pitch Shift mode works like a conventional harmonize module, raising or lowering the pitch of the input signal by an amount specified by the parameter values. Pitch can be changed by any amount from -1200 cents to +1299 cents in 1-cent steps. (A cent is a pitch measurement unit. One semitone is 100 cents. One octave is 1200 cents.)

■ This can be used to “fatten” the sound. You can raise or lower the pitch by a small amount, mixing the detuned result back in with the input. Or, feedback can be prevented by changing vocal pitch very slightly and outputting only the pitch shifted result. (Direct output level is reduced to zero.) Alternatively, you can set the amount of Pitch Shift to “0” and use the chorus and gate effects by themselves. (Refer to the sections on chorus and gate functions for details.)

When producing conventional pitch shift effects, only one of the five harmonize units is used. However, the “74 DETUNE” parameter can enable all units to be detuned by small but differing amounts, thereby yielding an even fatter sound. (See parameters for unison control.)

■ Press the PITCH SHIFT key to select the pitch shift mode.

Example: Pitch Shift mode operation

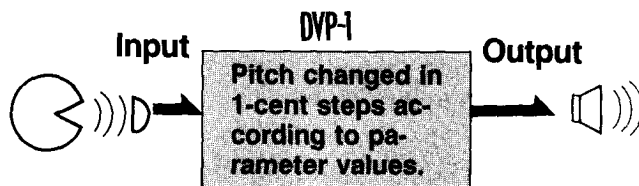

Conventional Pitch Shift mode (74 DETUNE at 0)

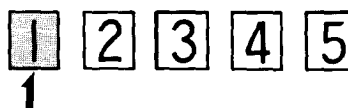

Only the first unit is used.

If parameter “74 DETUNE” is set to 1~3.

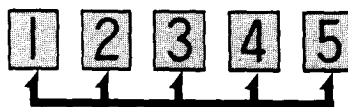

All units are detuned and used simultaneously.

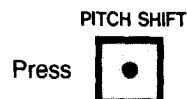

NOTE:

The Pitch Shift mode is designed to work with monophonic inputs. It may not operate normally with polyphonic inputs (chords).

2. Parameters for Pitch Shift mode

■ The following parameters are used to control Pitch Shift operation.

PITCH SHIFT

SHIFT LEVEL		
61	COARSE	-12 ◀ ▶ 12
62	FINE	0 ◀ ▶ 99

1 SHIFT LEVEL

SHIFT LEVEL

61 COARSE -12 ◀ ▶ 12

62 FINE 0 ◀ ▶ 99

These parameters control the amount of Pitch Shift.

61 COARSE

For adjustment of pitch in semitone (100-cent) increments.

Value	Amount of Pitch Shift (semitone steps)
-12	Pitch lowered 12 semitones (one octave). ↑ (Adjustable in semitone steps)
0	Input is reproduced at output without any pitch change. ↑ (Adjustable in semitone steps)
12	Pitch raised 12 semitones (one octave).

62 FINE

This is adjustable in 1-cent steps and is added to the parameter "61 COARSE" value to arrive at the total pitch shift.

Value	Amount of added pitch shift 1-cent steps.
0	Nothing added (Coarse value left as is). ↑ (Adjustable in 1-cent steps)
99	99 cents added to coarse value.

OTHER FUNCTIONS

1. Chorus

1 Chorus operation

- Built-in digital chorus can be used in all modes. Press the CHORUS key to turn on this effect. The key's LED illuminates when the Chorus effect is on. To turn off the effect, press the key again.

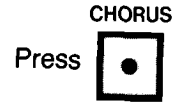

One of the five units is enlisted to create the Chorus effect. Therefore, when chorus is selected, each mode's output becomes "4-voice polyphonic." (So, of the five CHORD parameters used in the harmonize mode to set the amount of pitch change, the 5th unit parameter "58 NOTE 5" becomes inoperative.)

NOTE:

When the CHORUS key is pressed, output sound level becomes low slightly.

2 Chorus parameters

CHORUS		
71	SPEED	1 ◀ ▶ 4
72	INTENSITY	1 ◀ ▶ 4
73	EFFECT	1 ◀ ▶ 3

These parameters (speed, intensity, effect) control the Chorus effect.

71 SPEED

Determines the speed of the cyclic variations comprising the Chorus effect.

Value	Chorus speed
1	Slow
↕	↕
4	Fast

72 INTENSITY

Controls the depth of modulation in the Chorus effect.

Value	Chorus modulation depth
1	Shallow
↕	↕
4	Deep

OTHER FUNCTIONS

73 EFFECT

The DVP-1 outputs a mixture of sound with and without the chorus effect. This parameter's value determines the mixture ratio of these two sounds.

Value	Chorus volume ¹ (Amount of signal without chorus)
1	Low (High)
↕	↕
3	High (Low)

2. Unison

- The vocoder mode, internal wave mode, and harmonize mode use five units to enable 5-voice polyphonic output. If you turn on the Unison mode then only the first unit will operate and the output will become monophonic. (This is true as long as the detune parameter value is "0".) If you set the Unison mode's DETUNE parameter to a value from "1" to "3" then each of the five units will gain a slightly different detuning and all units will sound together, creating a fat or layered sound.

(The Unison mode is monophonic. Only the first of the Harmonize mode's CHORD parameters can be used to specify the output pitch change. Parameters "55 NOTE 2" through "58 NOTE 5" have no effect.)

- To use the unison function, press the UNISON key on the front panel so that its LED illuminated. (To turn off, press again.)

If unison is off:



Units are used according to the number of keys placed.

If unison is on (and detune is at "0"):

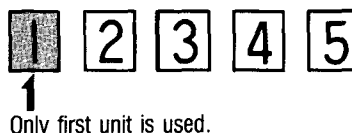

Only first unit is used.

If detune is set to 1, 2 or 3 when unison is on:



All units sound together when one key is played. Each unit has a slightly different pitch.

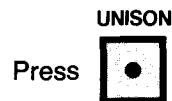

2 Unison parameters.

UNISON
74 DETUNE 0 ◀ ▶ 3

Unison affects the Vocoder mode, Internal Wave mode, and Harmonize mode. In these modes, the detune parameter becomes effective when the UNISON key is on, allowing each unit to produce a slightly different pitch, thereby fattening the sound. (In the Pitch Shift mode, this parameter can be used regardless of whether the unison effect is on or off.)

74**DETUNE**

At a value of "0", only the first unit is used. At values other than "0", all five units are used together. The larger the value, the greater the pitch differences between units.

Value	Detuning
0	Only first unit is used.
1	All five units are used with small pitch differences.
2	
3	All five units are used with large pitch differences.

3. Gate

1 Gate operation

■ The gate circuit attenuates the output signal when the input signal drops below a particular level. This helps prevent unwanted noise and feedback. The gate does not operate in the Internal Wave mode.

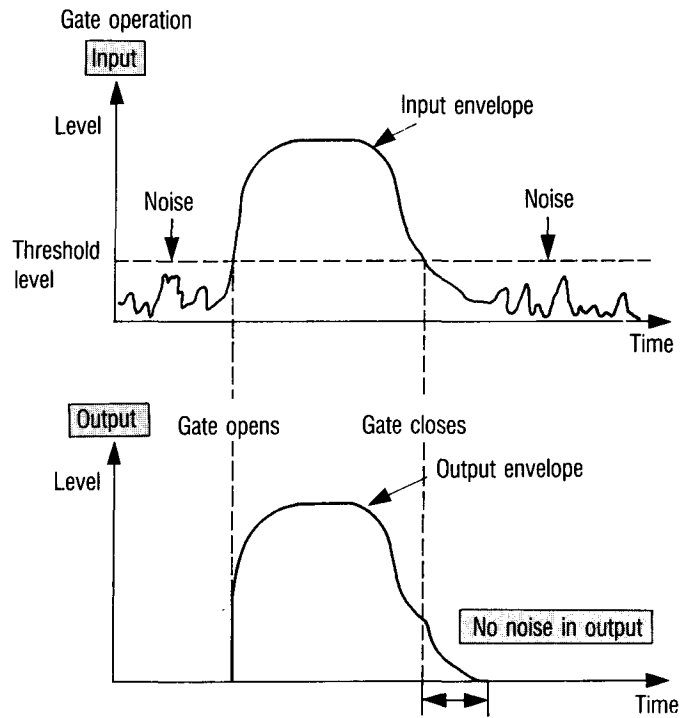

2 Gate parameters

GATE	
81	THRESHOLD 0 ◀ ▶ 7
82	DECAY 0 ◀ ▶ 7

The Threshold and Decay parameters are used to control the gate function.
 ★ These parameters can not be stored in the programmer memory.

81 THRESHOLD

This sets the threshold volume level for the input. If input falls below this value then the gate attenuates the output according to the decay time set by the "82 DECAY" parameter.

The gate opens when the input signal rises above the threshold. The higher the threshold parameter value, the higher the input signal must rise in volume before it triggers the gate to open.

Value	Threshold level
0	Minimum (Gate is always open)
↑	↑
7	High (Gate opens only at high volume)

**DECAY**

Determines how gradually the output is attenuated when the input falls below the threshold level.

Value	Decay time
0	Minimum (Output cuts off immediately as the gate closes.)
↕	↕
7	Long (Output is gradually diminished.)

4. Freeze

Freeze Operation

To use the Freeze function, connect a foot switch (PS-1 or equivalent) to the rear panel FREEZE jack.

When the foot switch is depressed, the DVP-1 takes part of the waveform and keeps repeating that cycle, using it instead of the external input, until the foot switch is turned off.

With this Freeze function, you can capture a brief input, retaining that sound for as long as you like.

The Freeze function can be used in the Vocoder mode, Harmonize mode, and Pitch Shift mode. Depending on freeze foot switch operation timing, noise may appear in the output. Try pressing the foot switch again if this occurs.

DVP-1 rear panel

INTO FREEZE DIR

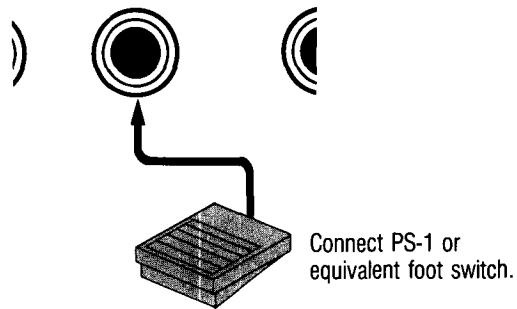

Freeze operation

If the Freeze foot switch is pressed with the input signal below:

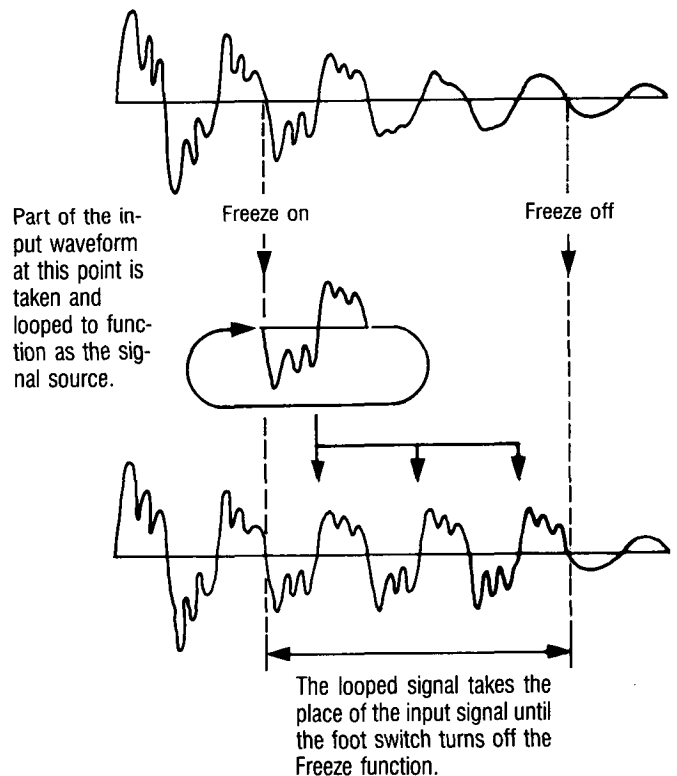

2 MIDI control of the Freeze function

- Freeze on/off control can be obtained by using MIDI control change message No. 64 or No. 69, so you can use a MIDI keyboard instead of pressing the foot switch.

Example: Using the DW-6000 or DW-8000 for control of the Freeze function. (Refer to the "84 ENABLE" parameter.)

DW-6000 or DW-8000 rear panel

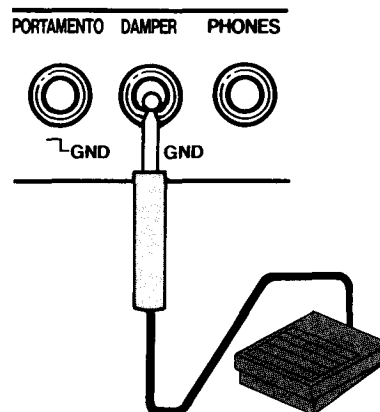

When the DW-6000 or DW-8000 damper is operated by the foot switch, it generates a control No. 64 control change message which controls the DVP-1 Freeze function.

- To use MIDI control the the Freeze function you must have the "84 ENABLE" parameter set to "2" (ALL).

The parameter "88 FOOT SWITCH" value "1" or "2" determines whether MIDI control No. 64 or 69 will be used for freeze control. For control via the DW-6000 or DW-8000 damper foot switch, the DVP-1 "88 FOOT SWITCH" value must be "1" (mode 1). (Refer to the "88 FOOT SWITCH" parameter.)

		NOTE DATA	ALL
84	ENABLE	1	2

		DISABLE	MODE 1	MODE 2
88	FOOT SWITCH	0	1	2

PROGRAM WRITE (Writing Programs to Memory)

1. What Can Be Stored

- The DVP-1 programmer memory can hold 64 sets of settings or "programs". In these programs you can store the settings of parameters 11 ~ 74 as well as the mode to be used and the on/off status of chorus and unison functions.

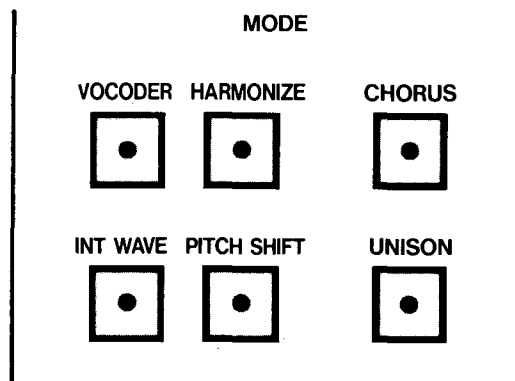

VOCODER		INTERNAL		PITCH EG		MG		HARMONIZE			PITCH SHIFT		CHORUS	
FORMANT		WAVEFORM		ATTACK		FREQUENCY		KEY NOTE C1 → C6			SHIFT LEVEL		SPEED	
11	SHIFT -15 → 15	21	1 → 8	31	0 → 15	41	0 → 15	51	KEY NOTE	61	COARSE -12 → 12	71	1 → 4	
12	KBD TRACK OFF HALF FULL 0 1 2			32	DECAY 0 → 15	42	DELAY 0 → 15	52	KEY CHANGE DISABLE 0 ENABLE 1	62	FINE 0 → 99	72	INTENSITY 1 → 4	
13	WINDOW LENGTH 1 → 8			33	POLARITY 1 2	43	PITCH 0 → 15	53	CHORD MEMORY DISABLE 0 ENABLE 1			73	EFFECT 1 → 3	
BREATH BYPASS				34	INTENSITY 0 → 15	44	DCA 0 → 15	CHORD					UNISON	
14	LEVEL 0 → 7			DCA EG		BEND		54	NOTE 1 -12 → 12			74	DETUNE 0 → 3	
15	LEVEL THRESHOLD 1 2			35	ATTACK 0 → 15	45	PITCH 0 → 12	55	NOTE 2 -12 → 12					
16	PITCH THRESHOLD 1 2			RELEASE		FORMANT OFF ON 0 1		56	NOTE 3 -12 → 12					
	▼: VOCODER MODE ONLY					PORTAMENTO		57	NOTE 4 -12 → 12					
						47	TIME 0 → 15	58	NOTE 5 -12 → 12					
						48	HOLD OFF ON 0 1		---:OFF					



- The parameters which can be edited in a particular mode are limited. However, the programmer stores the settings of all of the mode parameters, regardless of which mode is selected. Therefore, you can recall a program that uses a particular mode, then switch modes to use the other parameter settings that were stored with it. (Refer to section on modes and their parameters.)

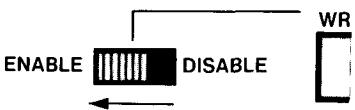
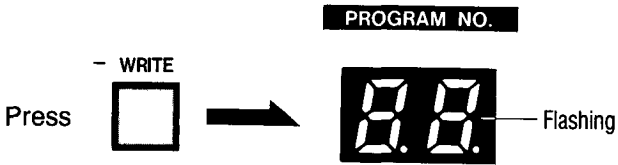
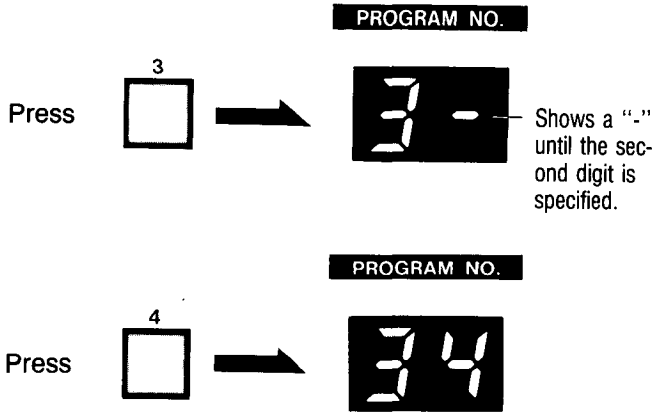

2. Program Write Operation

■ Follow this procedure to store programs in memory.

Procedure	Display and Controls
<p>① Select parameters and adjust their values to achieve the desired effect. Select the mode and set chorus and unison functions to on or off as desired.</p>	
<p>② Set the front panel WRITE switch to the ENABLE position.</p>	
<p>③ Press the WRITE key on the front panel. The program number display will flash.</p>	
<p>④ Press the number keys to select the desired program number. When a program number is specified, the program (set up in step ① above) is written to memory under that number. (Any previous program is erased from that program number.)</p> <p>★ If you want to use a program number previously selected when editing (in step ① above), press the WRITE key instead of specifying a number.</p>	<p>Example: To store under program number 34.</p>  <p>The new setting is now stored under program number 34. (Any previous settings under this number are erased.)</p>
<p>⑤ Return the front panel WRITE switch to the DISABLE position.</p> <p>★ Always leave the WRITE switch at the DISABLE position when not writing programs to memory. This protects your programs from erasure in case the WRITE key is pressed.</p>	

3. Program Transfer and Editing

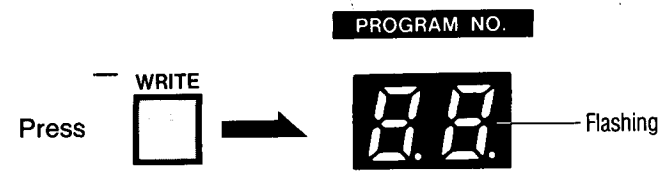
- Settings stored under one program number can be transferred to a different program number. This capability lets you rearrange your settings in the other in which you intend to use them when performing. Follow this procedure to transfer settings.

Procedure	Display and Controls
<p>① Set the front panel WRITE switch to the ENABLE position.</p>	
<p>② Use the number keys to select the program number that holds the setting that you want to transfer.</p>	
<p>③ Press the front panel WRITE key. The program number selected in the previous step will flash.</p>	
<p>④ Press the number keys to select the program number under which you wish to store the setting. When a number has been specified, the setting will be stored under it. (At the same time, any previous setting stored under that number will be erased.)</p> <p>★ If you want to transfer to a number which contains desired settings, first transfer the destination number's current settings to yet another number.</p>	
<p>⑤ Repeat steps ②~④ above to rearrange your programs (settings).</p>	
<p>⑥ When transfer and editing are complete, return the front panel WRITE switch to the DISABLE position.</p>	

MIDI IMPLEMENTATION

1. Transmitted Data

1 SYSTEM EXCLUSIVE MESSAGES

1 DEVICE ID

BYTE	DESCRIPTION
1 1 1 1 0 0 0 0	Exclusive status
0 1 0 0 0 0 1 0	KORG ID 42H
0 0 1 1 n n n n	Format ID 3nH (nnnn=channel number) NOTE 1
0 0 0 0 1 0 0 1	DVP-1 ID 09H
1 1 1 1 0 1 1 1	EOX

★ The DEVICE ID is sent when a DEVICE ID REQUEST is received.

2 WRITE COMPLETED

BYTE	DESCRIPTION
1 1 1 1 0 0 0 0	Exclusive status
0 1 0 0 0 0 1 0	KORG ID 42H
0 0 1 1 n n n n	Format ID 3nH (nnnn=channel number) NOTE 1
0 0 0 0 1 0 0 1	DVP-1 ID 09H
0 0 1 0 0 0 0 1	Write Completed 21H
1 1 1 1 0 1 1 1	EOX

★ WRITE COMPLETED is sent after a WRITE REQUEST has been received and a program write performed.

MIDI IMPLEMENTATION

③WRITE ERROR

BYTE	DESCRIPTION
1 1 1 1 0 0 0 0	Exclusive status
0 1 0 0 0 0 1 0	KORG ID 42H
0 0 1 1 n n n n	Format ID 3nH (nnnn=channel number) NOTE 1
0 0 0 0 1 0 0 1	DVP-1 ID 09H
0 0 1 0 0 0 1 0	Write Error 22H
1 1 1 1 0 1 1 1	EOX

★ A WRITE ERROR is sent if a program write was not performed after receipt of a WRITE REQUEST (as occurs if the front panel write switch is set to the disable position.)

④DATA SAVE (DATA DUMP)

BYTE	DESCRIPTION
1 1 1 1 0 0 0 0	Exclusive status
0 1 0 0 0 0 1 0	KORG ID 42H
0 0 1 1 n n n n	Format ID 3nH (nnnn=channel number) NOTE 1
0 0 0 0 1 0 0 1	DVP-1 ID 09H
0 1 0 0 0 0 0 0	Data Dump 40H
0 v v v v v v v v	Data 24 bytes (See DVP-1 BIT MAP)
⋮	
0 v v v v v v v v	
1 1 1 1 0 1 1 1	EOX

★ DATA SAVE (DATA DUMP) is sent when a DATA SAVE REQUEST is received.

NOTE:

1. nnnn = 0~15: Channel number set by parameter number 83 (exclusive message transmission channel).

2. Recognized Receive Data

1 CHANNEL MESSAGES

STATUS	SECOND	THIRD	DESCRIPTION
1 0 0 0 n n n n	0 k k k k k k k k	0 x x x x x x x x	Note Off Velocity will be ignored. NOTE 1
1 0 0 1 n n n n	0 k k k k k k k k	0 v v v v v v v v	Note On (0vvvvv>0) Velocity will be ignored. NOTE 1
1 0 0 1 n n n n	0 k k k k k k k k	0 0 0 0 0 0 0 0	Note Off NOTE 1
1 0 1 1 n n n n	0 0 0 0 0 0 0 1	0 v v v v v v v v	Pitch Modulation (7bit resolution)
1 0 1 1 n n n n	0 0 0 0 0 0 1 0	0 v v v v v v v v	DCA Modulation (7bit resolution)
1 0 1 1 n n n n	0 0 0 0 0 1 1 1	0 v v v v v v v v	Volume (7bit resolution)
1 0 1 1 n n n n	0 1 0 0 0 0 0 0	0 0 0 0 0 0 0 0	Freeze Off NOTE 2
1 0 1 1 n n n n	0 1 0 0 0 0 0 0	0 1 1 1 1 1 1 1	Freeze On NOTE 2
1 0 1 1 n n n n	0 1 0 0 0 0 0 1	0 0 0 0 0 0 0 0	Portamento Off
1 0 1 1 n n n n	0 1 0 0 0 0 0 1	1 1 1 1 1 1 1 1	Portamento On
1 0 1 1 n n n n	0 1 0 0 0 1 0 1	0 0 0 0 0 0 0 0	Freeze Off NOTE 2
1 0 1 1 n n n n	0 1 0 0 0 1 0 1	0 1 1 1 1 1 1 1	Freeze On NOTE 2
1 0 1 1 n n n n	0 1 1 1 1 0 1 1	0 0 0 0 0 0 0 0	All Notes Off
1 0 1 1 n n n n	0 1 1 1 1 1 0 0	0 0 0 0 0 0 0 0	Omni Mode Off (All Notes Off)
1 0 1 1 n n n n	0 1 1 1 1 1 0 1	0 0 0 0 0 0 0 0	Omni Mode On (All Notes Off)
1 0 1 1 n n n n	0 1 1 1 1 1 1 0	0 x x x x x x x x	(All Notes Off)
1 0 1 1 n n n n	0 1 1 1 1 1 1 1	0 0 0 0 0 0 0 0	(All Notes Off)
1 1 0 0 n n n n	0 p p p p p p p p	—————	Program Change NOTE 3
1 1 1 0 n n n n	0 v v v v v v v v	0 v x x x x x x x x	Pitch Bender Change (8bit resolution)

NOTE:

- NOTE NUMBER (0kkkkkkk) = 24~84: If message data beyond this range is received, then the note will be voiced as the same note name within the nearest valid octave.
The parameter 86 and 87 key window values can limit the range of note-on/note-off data which will be voiced.
- Parameter number 88 allows this to be set to control No. 64 or 69.
- Program number (0ppppppp) = 0~63: If program number data higher than 63 is received, then 64 is subtracted from that data to arrive at the program number data that will be used.
Program numbers are indicated on the display with the numbering system used by the DVP-1. This results in the kind of relationships shown here.

Program number	Displayed number
0	→ #11
1	→ #12
⋮	
62	→ #87
63	→ #88

MIDI IMPLEMENTATION

2 SYSTEM REAL TIME MESSAGES

STATUS	DESCRIPTION
1 1 1 1 1 1 1 0	Active Sensing

★ 640ms time out

Active sensing is always received, regardless of a "0" value for parameter number 84.

3 SYSTEM EXCLUSIVE MESSAGES

1 DEVICE ID REQUEST

BYTE	DESCRIPTION
1 1 1 1 0 0 0 0	Exclusive status
0 1 0 0 0 0 1 0	KORG ID 42H
0 1 0 0 n n n n	Format ID 4nH (nnnn=channel number) NOTE 1
1 1 1 1 0 1 1 1	EOX

②WRITE REQUEST

BYTE	DESCRIPTION
1 1 1 1 0 0 0 0	Exclusive status
0 1 0 0 0 0 1 0	KORG ID 42H
0 0 1 1 n n n n	Format ID 3nH (nnnn=channel number) NOTE 1
0 0 0 0 1 0 0 1	DVP-I ID 09H
0 0 0 1 0 0 0 1	Write Request 11H
0 p p p p p p p p	Program Number (p p p p p p p = 0 -63)
1 1 1 1 0 1 1 1	EOX

③DATA SAVE REQUEST

BYTE	DESCRIPTION
1 1 1 1 0 0 0 0	Exclusive status
0 1 0 0 0 0 1 0	KORG ID 42H
0 0 1 1 n n n n	Format ID 3nH (nnnn=channel number) NOTE 1
0 0 0 0 1 0 0 1	DVP-I ID 09H
0 0 0 1 0 0 0 0	Data Save Request 10H
1 1 1 1 0 1 1 1	EOX

MIDI IMPLEMENTATION

4 DATA LOAD (DATA DUMP)

BYTE	DESCRIPTION
1 1 1 1 0 0 0 0	Exclusive status
0 1 0 0 0 0 1 0	KORG ID 42H
0 0 1 1 n n n n	Format ID 3nH (nnnn=channel number) NOTE 1
0 0 0 0 1 0 0 1	DVP-1 ID 09H
0 1 0 0 0 0 0 0	Data Dump 40H
0 v v v v v v v v	Data 24 bytes
⋮	(See DVP-1 BIT MAP)
0 v v v v v v v v	
1 1 1 1 0 1 1 1	EOX

5 PARAMETER CHANGE

BYTE	DESCRIPTION
1 1 1 1 0 0 0 0	Exclusive status
0 1 0 0 0 0 1 0	KORG ID 42H
0 0 1 1 n n n n	Format ID 3nH (nnnn=channel number) NOTE 1
0 0 0 0 1 0 0 1	DVP-1 ID 09H
0 1 0 0 0 0 0 1	Parameter Change 41H
0 v v v v v v v v	Parameter Offset (See DVP-1 BIT MAP)
0 v v v v v v v v	Parameter Value (See DVP-1 BIT MAP)
1 1 1 1 0 1 1 1	EOX

NOTE:

1. nnnn = 0~15: Channel number set by parameter number 83 (exclusive message transmission channel).

3. Using the System Exclusive Messages

1 DVP-1 BIT MAP

PARAMETER OFFSET	BIT PATTERN							
	MSB							LSB
	7	6	5	4	3	2	1	0
0	0	KBD TRACK		FORMANT SHIFT				
1	0	WINDOW LENGTH			0	INTERNAL WAVEFORM		
2	0	BREATH BYPASS LEVEL			PITCH EG ATTACK			
3	0	0	PITCH THRESHOLD	LEVEL THRESHOLD	PITCH EG DECAY			
4	0	0	0	PITCH EG POLARITY	PITCH EG INTENSITY			
5	0	0	0	0	DCA EG ATTACK			
6	0	0	0	0	DCA EG RELEASE			
7	0	0	0	0	MG FREQUENCY			
8	0	0	0	0	MG DELAY			
9	0	0	0	0	MG PITCH			
10	0	0	0	0	MG DCA			
11	0	0	0	BEND FORMANT	BEND PITCH			
12	0	0	0	HOLD	PORTAMENTO TIME			
13	0	UNISON DETUNE		PITCH SHIFT COARSE				
14	0	PITCH SHIFT FINE						
15	0	0	CHORUS EFFECT		CHORUS INTENSITY		CHORUS SPEED	
16	0	0	0	0	0	0	KEY CHANGE	CHORD MEMORY
17	0	KEY NOTE						
18	0	0	NOTE 1 ON/OFF	NOTE 1				
19	0	0	NOTE 2 ON/OFF	NOTE 2				
20	0	0	NOTE 3 ON/OFF	NOTE 3				
21	0	0	NOTE 4 ON/OFF	NOTE 4				
22	0	0	NOTE 5 ON/OFF	NOTE 5				
23	0	0	0	0	CHORUS ON/OFF	UNISON ON/OFF	MODE	

MIDI IMPLEMENTATION

2 Bit map and corresponding parameter values

PARAMETER NO., NAME MODE	PARAMETER OFFSET	BIT	CORRESPONDING PARAMETER VALUE, MODE
11 FORMANT SHIFT	0	b4-b0	00000 - 01111 = 0 - 15 11111 - 10001 = (-1) - (-15) * 10000 = INHIBIT
12 KBD TRACK	0	b6-b5	00 - 10 = 0(OFF) - 2(FULL) 11 = INHIBIT
13 WINDOW LENGTH	1	b6-b4	000 - 111 = 1 - 8
14 BREATH BYPASS LEVEL	2	b6-b4	000 - 111 = 0 - 7
15 LEVEL THRESHOLD	3	b4	0 - 1 = 1 - 2
16 PITCH THRESHOLD	3	b5	0 - 1 = 1 - 2
21 INTERNAL WAVEFORM	1	b2-b0	000 - 111 = 1 - 8
31 PITCH EG ATTACK	2	b3-b0	0000 - 1111 = 0 - 15
32 PITCH EG DECAY	3	b3-b0	0000 - 1111 = 0 - 15
33 PITCH EG POLARITY	4	b4	0 - 1 = 1(V-) - 2(Λ)
34 PITCH EG INTENSITY	4	b3-b0	0000 - 1111 = 0 - 15
35 DCA EG ATTACK	5	b3-b0	0000 - 1111 = 0 - 15
36 DCA EG RELEASE	6	b3-b0	0000 - 1111 = 0 - 15
41 MG FREQUENCY	7	b3-b0	0000 - 1111 = 0 - 15
42 MG DELAY	8	b3-b0	0000 - 1111 = 0 - 15
43 MG PITCH	9	b3-b0	0000 - 1111 = 0 - 15
44 MG DCA	10	b3-b0	0000 - 1111 = 0 - 15
45 BEND PITCH	11	b3-b0	0000 - 1100 = 0 - 12 1101 - 1111 = INHIBIT
46 BEND FORMANT	11	b4	0 - 1 = 0(OFF) - 1(ON)
47 PORTAMENTO TIME	12	b3-b0	0000 - 1111 = 0 - 15
48 HOLD	12	b4	0 - 1 = 0(OFF) - 1(ON)
51 KEY NOTE	17	b6-b0	0011000 - 1010100 = C 1 - C 6 <small>(Same as MIDI's NOTE number.)</small> 0000000 - 0010111 = INHIBIT 1010101 - 1111111 = INHIBIT
52 KEY CHANGE	16	b1	0 - 1 = 0(DISABLE) - 1(ENABLE)

53 CHORD MEMORY	16	b0	0 - 1 = 0(DISABLE) - 1(ENABLE)
54 NOTE 1~58 NOTE 5	18-22	b5	0 - 1 = (OFF) - (ON)
		b4-b0	00000 - 01100 = 0 - 12 11111 - 10100 = (-1) - (-12) * 01101 - 01111 = INHIBIT 10011 - 10000 = INHIBIT
61 PITCH SHIFT COARSE	13	b4-b0	00000 - 01100 = 0 - 12 11111 - 10100 = (-1) - (-12) * 01101 - 01111 = INHIBIT 10011 - 10000 = INHIBIT
62 PITCH SHIFT FINE	14	b6-b0	0000000 - 1100011 = 0 - 99 1100100 - 1111111 = INHIBIT
71 CHORUS SPEED	15	b1-b0	00 - 11 = 1 - 4
72 CHORUS INTENSITY	15	b3-b2	00 - 11 = 1 - 4
73 CHORUS EFFECT	15	b5-b4	00 - 10 = 1 - 3 11 = INHIBIT
74 UNISON DETUNE	13	b6-b5	00 - 11 = 0 - 3
MODE	23	b1-b0	00 = VOCODER 01 = HARMONIZE 10 = INTERNAL WAVE 11 = PITCH SHIFT
CHORUS ON/OFF	23	b3	0 - 1 = (OFF) - (ON)
UNISON ON/OFF	23	b2	0 - 1 = (OFF) - (ON)

* = 2's COMPLEMENT

MIDI IMPLEMENTATION

☒ Communications between a Computer and the DVP-1

- The DVP-1 can send and receive the following kinds of information via system exclusive messages.

Sending

DEVICE ID	: Identifies equipment. Sent when a DEVICE ID REQUEST is received.
WRITE COMPLETED	: Indicates a successful program write. Sent in response to a WRITE REQUEST.
WRITE ERROR	: Indicates program write failure due to front panel write switch being set to DISABLE. Sent in response to a WRITE REQUEST.
DATA SAVE (DATA DUMP)	: The program data. Sent in response to a DATA SAVE REQUEST.

Receiving

DEVICE ID REQUEST	: A request to send the DEVICE ID.
WRITE REQUEST	: Request to write loaded program data to the DVP-1 programmer.
DATA SAVE REQUEST	: A command to send program data.
DATA LOAD (DATA DUMP)	: The program data to be loaded to the DVP-1.
PARAMETER CHANGE	: Data which changes parameter values.

- These system exclusive messages can be used for data transmission between the DVP-1 and a computer equipped with a MIDI interface and software that handles these system exclusive messages.

- Setup is shown here:



- All DVP-1 exclusive messages use a “channel” determined by the value of parameter number 83. The channel set on the DVP-1 must match the channel used by the computer. Otherwise messages will be ignored. (This channel is for exclusive messages only and has no effect on omni mode channel mode messages.) If these channels are used then several DVP-1 units can be used in a system and program control can be independently performed for each.

■ Communications Examples

① To determine what equipment is connected to the computer.

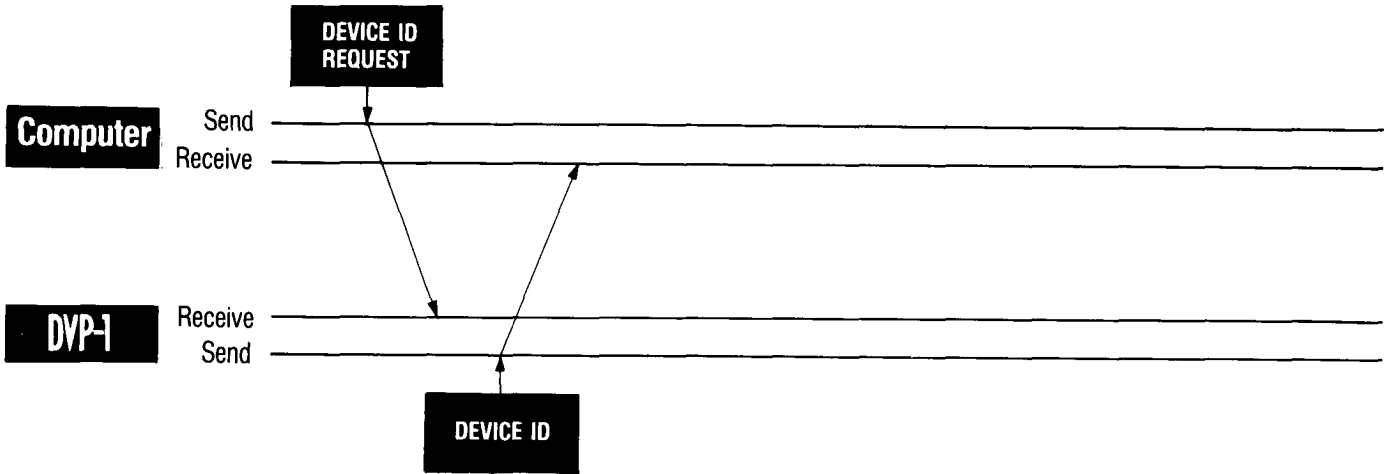

② To edit program data within the DVP-1.

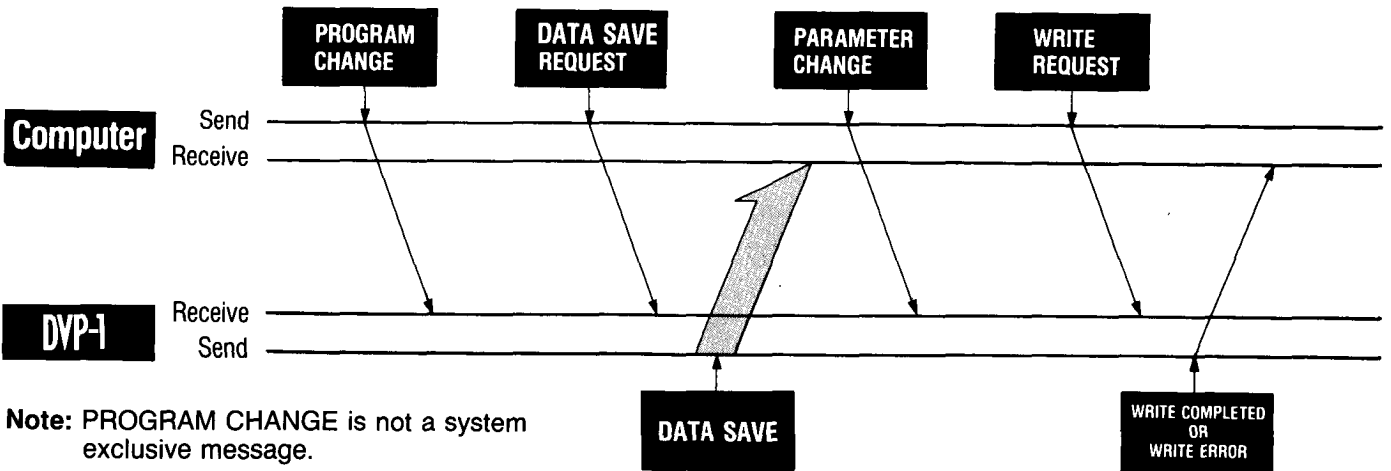

Note: PROGRAM CHANGE is not a system exclusive message.

③ To edit program data prepared on the computer.

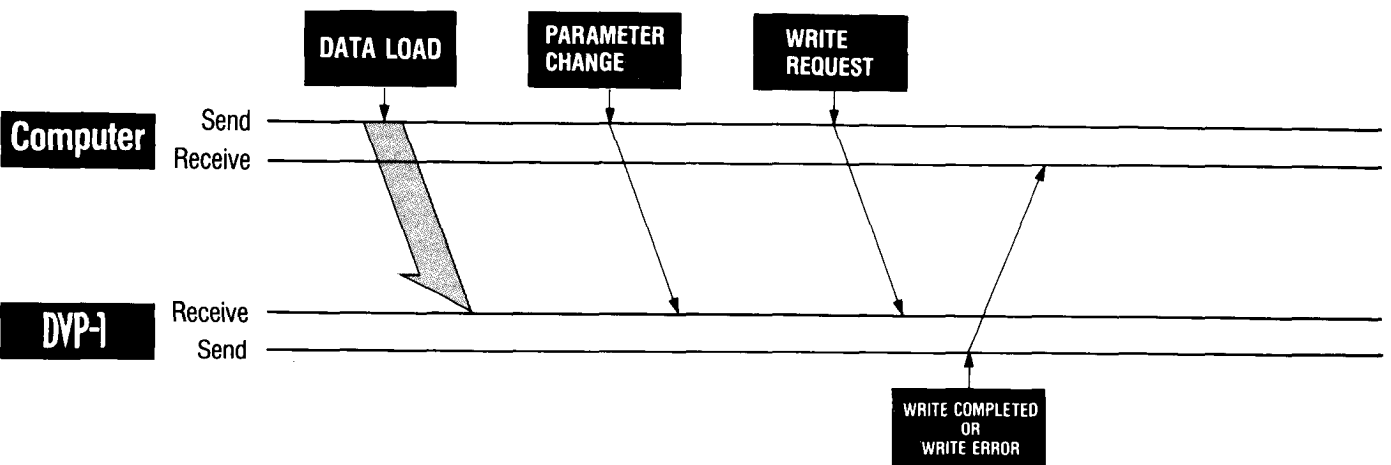

MIDI IMPLEMENTATION

4 To save all 64 programs from the DVP-1 to the computer.

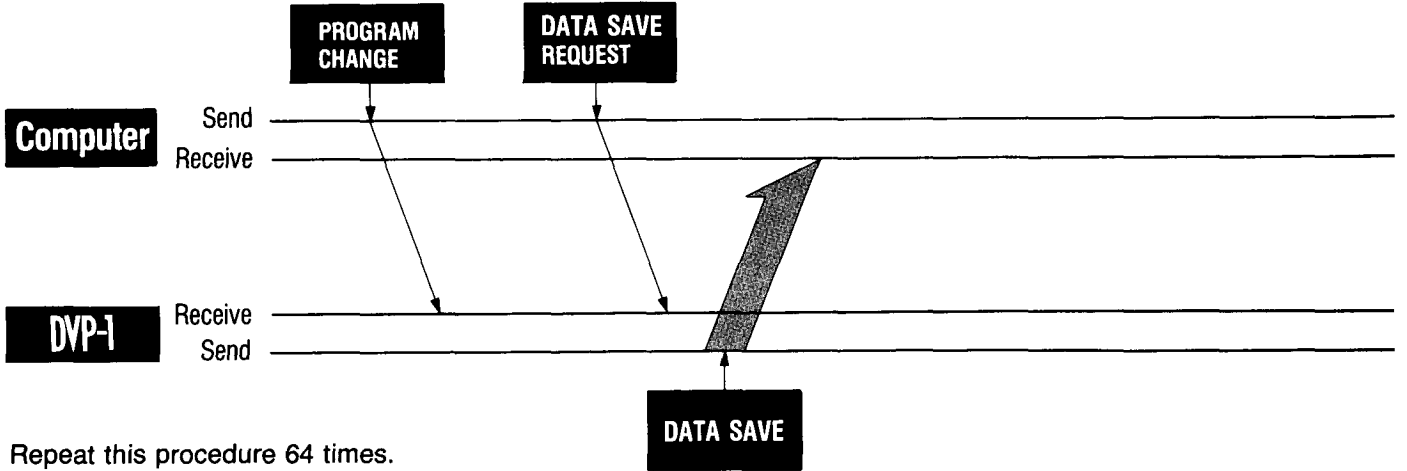

5 To load all 64 programs to the DVP-1 from the computer.

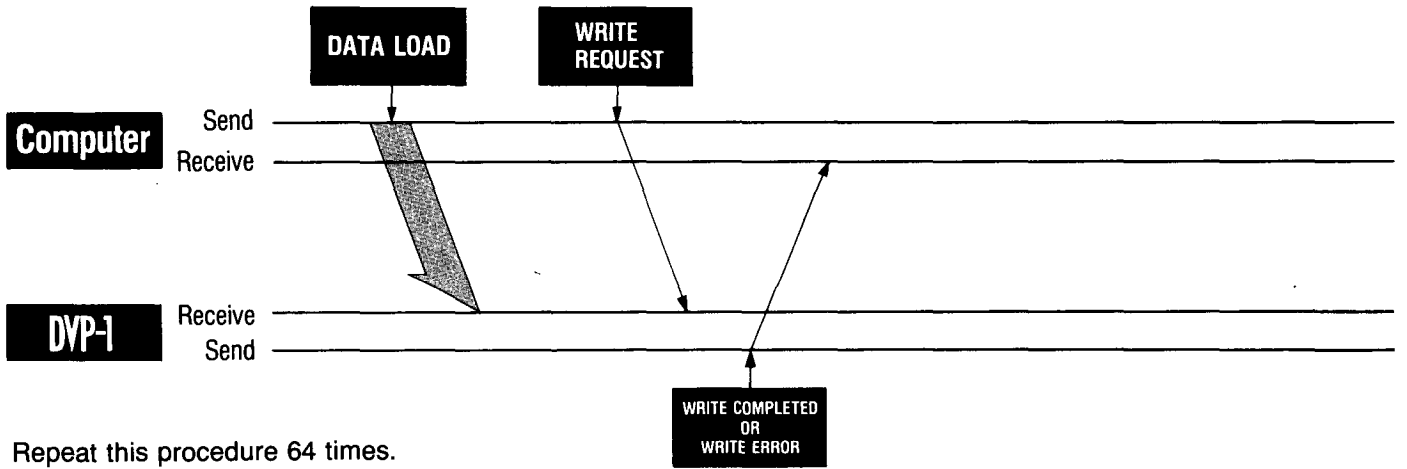

SPECIFICATIONS & OPTIONS

1. Modes : Vocoder, Internal wave, Harmonize, Pitch shift
2. Range : Vocoder and internal wave modes: 5 octaves
Harmonize: 1 octave above and below key note
Pitch shift: - 1200 cents to + 1299 cents (1-cent steps)
3. Audio processing method : Digital processing by DSP (×2)
4. A/D, D/A quantization bits : A/D 12-bit: D/A 16-bit (linear)
5. Polyphonic voices : 5 (4 when chorus is ON)
6. Program capacity : 64
7. Inputs : 3P cannon (impedance: 10kohms), Standard phone jack (impedance 100kohms), (Input level: - 50dB/ - 10dB/ + 4dB)
8. Outputs : Direct out (impedance 1kohm), Mix out (impedance: H = 1kohm, L = 10kohm; output level H:L = 10:1), Phones out.
9. Frequency response : Direct: 20Hz ~ 20kHz (±3dB)
Effect: 20Hz ~ 6.5kHz (- 3dB), 20Hz ~ 9kHz (- 6dB)
10. Dynamic range : Direct 104dB
11. S/N ratio : Effect: 70dB (JIS-A, Pitch shift mode, Attenuator at +4dB).
12. Parameters : Vocoder & internal wave modes: Formant (Formant shift, Keyboard track, Window length), Breath bypass (Level, Level threshold, Pitch threshold), Internal (Waveform), Pitch EG (Attack time, Decay time, Polarity, Intensity), DCA EG (Attack time, Release time), MG (Frequency, Delay, Pitch, DCA), Bend (Pitch, Formant), Portamento (Portamento time, Hold).
Harmonize mode: Key note, Key change, Chord memory, Chord (Note 1 ~ Note 5).
Pitch shift mode: Shift level (Coarse, Fine)
Chorus: Speed, Intensity, Effect level.
Unison: Detune.
Gate: Threshold, Decay
MIDI: Channel, Enable, OMNI, Key window bottom, Key window top, Foot switch.
13. Controls : Input Attenuator, Input level control, Direct level control, Effect level control, Total level control, Tune (±50 cents), Mode keys (×4), Chorus key, Unison key, Write switch, Write key, Program key, Parameter key, Bank hold key, Number keys (1 ~ 8), Edit control, UP key, DOWN key, Power switch, HIGH/LOW switch (Output level switch).
14. Indicators : Input level indicator, MIDI indicator, Program number display, Parameter number display, Value display.
15. Control inputs : Freeze (⌫ GND), Portamento (⌫ GND), MIDI (IN/OUT/THRU)
16. Power supply voltage : Local voltage
17. Power consumption : 30W
18. Weight : 6.3kg (not including rack mount adaptors)
19. Dimensions : 429.5(W) × 412.5(D) × 90(H)mm (not including rack mount adaptors)
20. Supplied accessories : Rack mount adaptors, AC cord, SYNC/MIDI cable (3m)
21. Options : Memory expander MEX-8000, Headset KH-V10, Pedal switch PS-1, Dual foot switch S-2, 2U rack case, MIDI cable (7m/10m/12m), SYNC/MIDI cable (1.5m/3m/5m), SYNC MIDI cable set (1m & 0.5m).

★ Specifications subject to change without notice.

N O T I C E

Korg products are manufactured under strict specifications and voltages required by each country. These products are warranted by the Korg distributor only in each country. Any Korg product not sold with a warranty card or carrying a serial number disqualifies the product sold from the manufacturer's/distributor's warranty and liability. This requirement is for your own protection and safety.

KORG

KEIO ELECTRONIC LABORATORY CORPORATION
15-12, Shimotakaido 1-chome, Suginami-ku, Tokyo, Japan.

©KEIO ELECTRONIC LABORATORY CORP. 1985

6011 ETH PRINTED IN JAPAN