

GUITAR PERFORMANCE PROCESSOR

Owner's Manual

Names of the parts and their functions	2
First, connect your guitar	4
Let's play an effect program	
1.What is an effect program?	5
CLEAN, CRUNCH, LEAD	5
2.How to select an effect program	6
3.How to bypass	8
4.How to use the volume pedal	9
Try creating effects yourself	
1.What is the IPE system?	10
DRIVE	12
TONE	12
SPEED	13
TIME	13
LEVEL	14
NR	14
2. Original value display	15
3. Compare mode	16
Storing the effect you created (Program writing)	17
Useful functions to know	
1. Edit knob lock mode (compare mode)	20
2. Effect program initialization	21
Troubleshooting	22
Specifications/Options	24

KORG



Usage precautions

■ Location

Avoid using your **G3** in the following locations, which could cause a malfunction.

- Locations subject to direct sunlight
- Locations with extremely high or extremely low temperature or humidity
- Locations with much sand or dust
- Locations that subject to excessive vibration

■ Power supply

Always use the AC adaptor that comes with the **G3**.

■ Effects on other electrical equipment

The **G3** uses a microcomputer and therefore may cause interference on radios or TVs. If so, move the **G3** away from these device.

■ Handle gently

Do not apply excess force to the switches and knobs. Doing so can lead to malfunctions.

■ Cleaning

Always clean the outside case with a dry, soft cloth. Never use any liquid like benzine or paint thinner, cleaning compounds, highly flammable polishes, or the like.

■ Warranty card procedure

The warranty period is one year from the date of purchase. During that period repairs are free. However, the warranty is not valid unless you have the warranty card filled out by the store where you purchased your **G3**. After filling out the warranty card correctly at the store, store it carefully in case you ever need it.

■ Take care of this user's manual.

Even after you have read this user's manual, store it away carefully for future reference.

THE FCC REGULATION WARNING

This equipment generates and uses radio frequency energy and if not installed and used properly, that is, in strict accordance with the manufacturer's instructions, may cause interference to radio and television reception. It has been type tested and found to comply with the limits for a Class B computing device in accordance with the specifications in Subpart J of Part 15 of FCC rules, which are designed to provide reasonable protection against such influence in a residential installation.

If this equipment does cause interference to radio or television reception, which can be determined by turning the equipment off and on, the user is encouraged to try to correct the interference by one or more the following measures:

- Reorient the receiving antenna
- Relocate the equipment with respect to the receiver
- Move the equipment away from the receiver
- Plug the equipment into a different outlet so that it and the receiver are on different branch circuits

If necessary, the user should consult the dealer or an experienced radio/television technician for additional suggestions. The user may find the following booklet prepared by the Federal Communications Commission helpful: "How to Identify and Resolve Radio-TV Interference Problems"

This booklet is available from the U.S. Government Printing Office, Washington, D.C. 20402, Stock No.004-000-000345 - 4.

CANADA

THIS DIGITAL APPARATUS DOES NOT EXCEED THE "CLASS B" LIMITS FOR RADIO NOISE EMISSIONS FROM DIGITAL APPARATUS SET OUT IN THE RADIO INTERFERENCE REGULATION OF THE CANADIAN DEPARTMENT OF COMMUNICATIONS.

LE PRESENT APPAREIL NUMERIQUE N'EMET PAS DE BRUITS RADIOELECTRIQUES DEPASSANT LES LIMITES APPLICABLES AUX APPAREILS NUMERIQUES DE LA "CLASSE B" PRESCRITES DANS LE REGLEMENT SUR LE BROUILLAGE RADIOELECTRIQUE EDICTE PAR LE MINISTERE DES COMMUNICATIONS DU CANADA.

Thank you for purchasing the Korg **G3**. The Korg **G3** is an unprecedented, completely new type of compact multi-effects processor that introduces the newly developed **IPE system**; a breakthrough method that allows the guitarist to freely create various effects quicker and easier than ever before.

Now that you have this new machine, you are probably eager to try it out. Even if you are the type of person who does not feel comfortable with new equipment until you have at least read quickly through the entire manual, we recommend that you first turn to "**First, connect your guitar**" on Page 4. Connect your guitar to the **G3** and check out the sound of the **G3**. As long as you are careful with the input volume and the output volume and with switching the power on and off, you will not damage your new piece of equipment. Play your guitar and turn the **G3's edit knobs** various ways. Listen to the different ways the effects change. See, you have mastered the **G3's IPE system** already!

Then when questions come up, such as "How can I store an effect I have created and use it whenever I want?" or "What is the best way to switch between a number of different effects?", read this manual again. This user's manual helps your fingers and your ears get used to the **G3** and helps the **G3** become an important tool with which you and your guitar can create your own sound. So be sure to store it carefully.

Names of the parts and their functions

Front panel

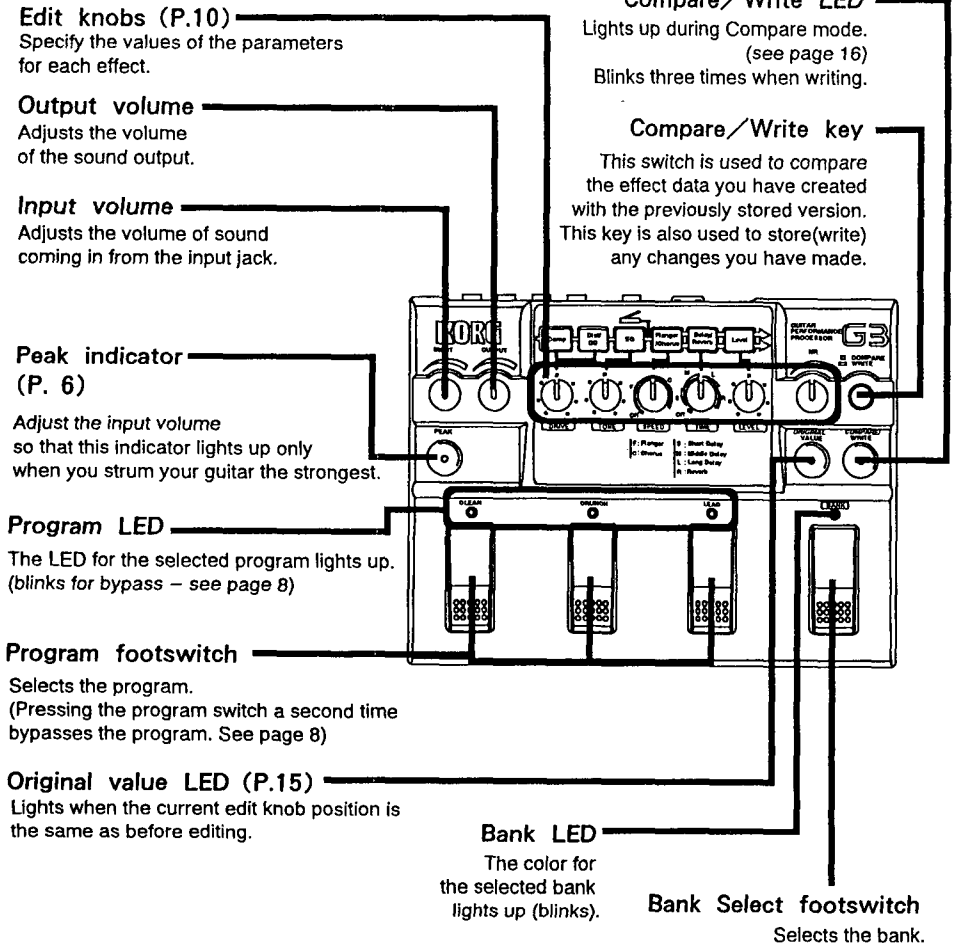

Rear panel

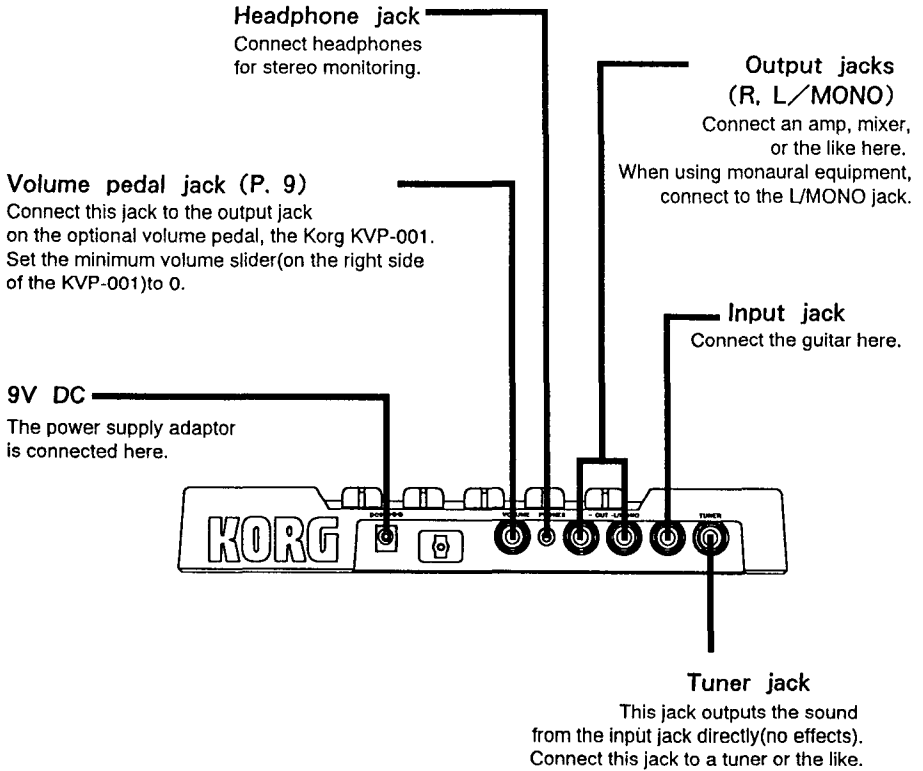

First, connect your guitar

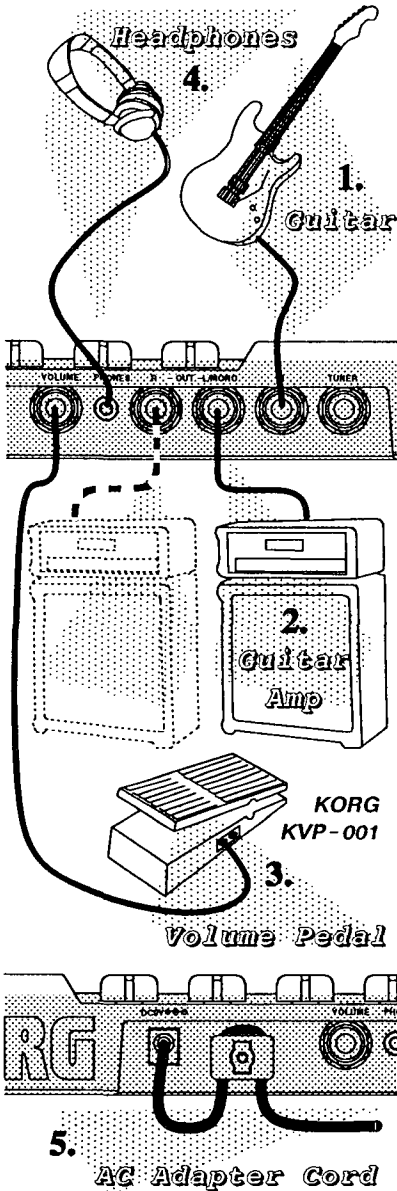

1. Connect your guitar to the **input jack**.

2. Connect the **output jack(s)** to your guitar amp(s).

Using the **G3** stereo sounds best. However, when using monaural equipment, connect the **L/MONO jack** only.

3. When using the optional volume pedal, connect the **Korg KVP - 001 volume pedal** to the volume pedal input jack. (See Page 9)

4. Use headphones to monitor the sound in stereo, and for "silent practicing".

5. After all the above connections are complete, connect the power adaptor.

The **G3** has no power switch. When you connect the power adaptor, the **G3** is on.

Fit the power adapter cord through the Cord Holder to prevent it from being accidentally unplugged.

Note : Lower the volume on all connected equipment before disconnecting the **G3** power.

Let's play an effect program

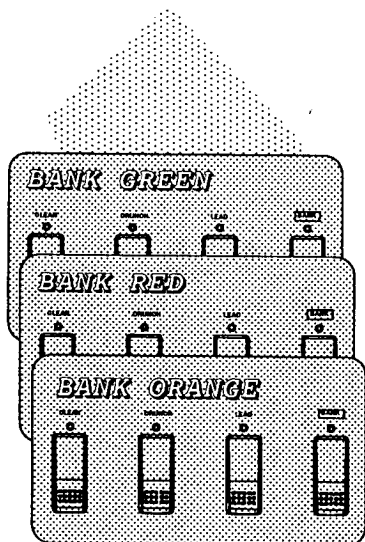

CLEAN **LEAD**
CRUNCH

1. What is an effect program?

The **G3** has three types of effect programs (**Clean**, **Crunch**, and **Lead**) in three banks, the **GREEN Bank**, the **RED Bank**, and the **ORANGE Bank**.

Therefore you can switch among **9** effect programs. These nine programs stored into the **G3** are called **effect programs**.

Each of the effect programs can be edited (remade to suit your desires) and stored .

CLEAN: stores clean effects with no distortion or overdrive effect.

CRUNCH: stores overdrive type effects.

LEAD: stores distortion type effects.

You can alter these effect programs to bring them even closer to the sound you want or you can create entirely new and different sounds based on these effect programs.

2. Selecting an effect program

1.

Guitar Input

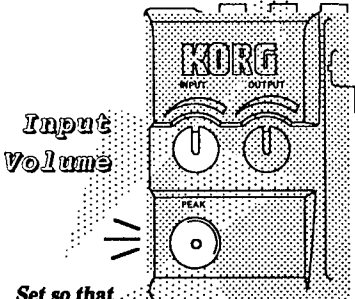

Set so that the indicator only lights up when you strum hardest.

2.

Bank Select footswitch

Bank LED blinking red

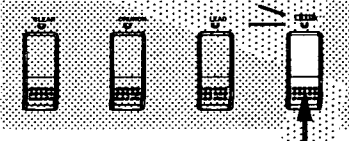

Green

Orange

Red

3.

Program footswitches

Bank LED stays red

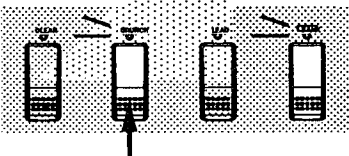

1. First, strum your guitar and adjust the input level. If the input level is too low, the **peak indicator** will not light up no matter how hard you strum your guitar. On the other hand, if the input level is too high, the peak indicator stays lit up most of the time. In either of these cases, the **G3** will not work correctly and you will not be able to obtain the desired effect.

Adjust the input volume so that the peak indicator lights up only when you strum your guitar the hardest.

Note : The sound may be distorted sometimes, even though the peak indicator is not lit, depending on the position of the edit knobs. If this happens, lower the input level until distortion no longer occurs.

2. Next, select the bank with the bank footswitch. Each time the **Bank Select footswitch** is pressed, the bank moves to the next bank in the following order:

green → red → orange

As an example, select the **RED Bank**. The **bank LED** blinks red.

3. Select a program with one of the **program footswitches (Clean, Crunch, Lead)**.

As an example, try selecting the **Clean** program in the **RED Bank**.

The **Clean program LED** lights up.

At the same time, the **bank LED** stops **blinking** and stays lit up red.

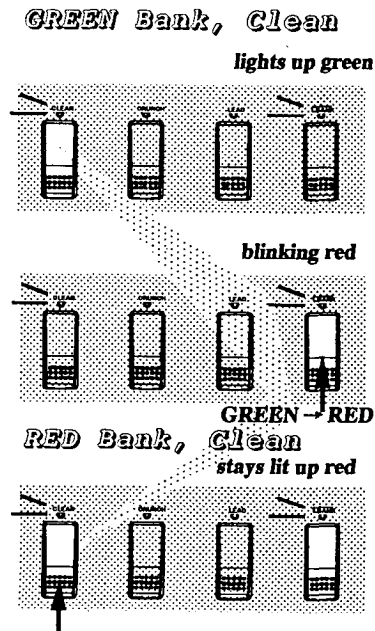
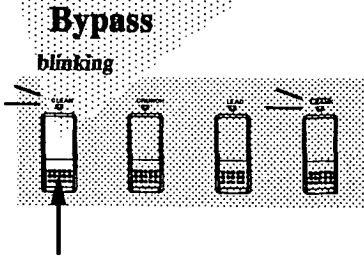

4. Now the **RED Bank, Clean** has been selected. When you play your guitar you can play with the effect sound of the **Clean** program.

5. When you want to temporarily output sound with no effect (**bypass**), **press the currently selected program footswitch** (in this case the **Clean** switch) **again**.

During bypassing, the selected program LED blinks. (For details on bypassing, see Page 8 “**How to bypass**”.)

6. Try playing the different programs in the banks by repeating Steps **2** through **5**. To select a different program in the same bank, just press that program footswitch.

Note : Pressing the bank footswitch alone **does not change the program**. The program is not changed until the moment you press the program footswitch.

For example, to switch from the **GREEN Bank Clean program** to the **RED Bank Clean program**, first press the Bank Select footswitch to switch the bank from **GREEN** to **RED**, then press the Clean program footswitch again.

GREEN Bank, Clean

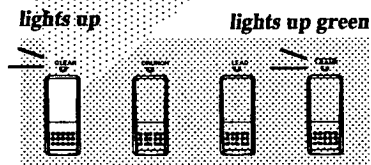

3. How to bypass

If you press the currently selected program footswitch a second time, that program LED blinks and the direct, **bypassed sound** (sound with no effects) is output.

To return to the effect sound, press the program footswitch again.

Note : Bypass mode will be cancelled when you switch to another effect program.

Note :When the effect is being bypassed, editing does not change the sound.

Edit after returning to the effect sound.

4. How to use the volume pedal

You can use the **volume pedal** to simulate violin and "backwards" guitar sounds, and for other playing techniques.

Volume pedal playing is a technique in which the volume is raised after picking, so that the pick attack is not heard. Try moving the volume pedal at different speeds and with different effect programs.



Always use the **Korg KVP - 001 volume pedal**. Connect the **OUTPUT** jack of the **KVP - 001** to the **volume pedal input jack (VOLUME)** of the **G3**.

Set the **minimum volume slider** on the **right side** of the **KVP-001** to **0**.

Try creating effects yourself

Edit knobs

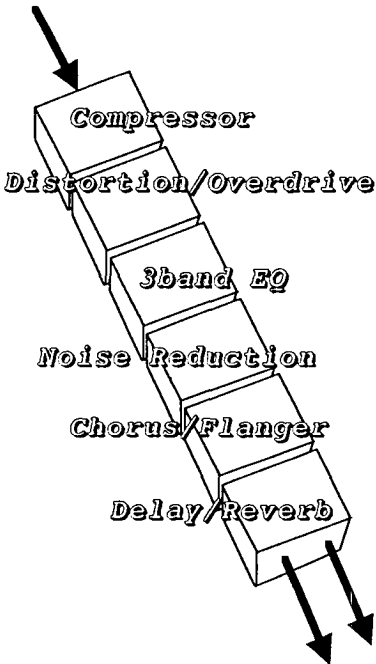
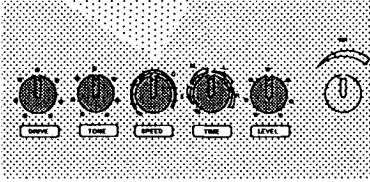

You can change the **G3's** preset nine effect programs anyway you want to match your own desires.

With the **G3**, you can easily create the effect sound you want simply by moving the five knobs on the panel. You can also store these edited programs for later use.

1. What is the IPE(Integrated Parameter Edit) system?

The **G3** actually has a total of nine different effects: **compressor, overdrive/distortion, 3band equalizer, chorus/flanger, delay/reverb, and noise reduction.**

Ordinary effect processors have various settings, called parameters, for each effect that determine the sound's timbre. For example, the chorus effect has parameters such as delay time, LFO speed, depth, and effect balance to determine factors such as the depth, speed, and the balance of the effected sound and non-effected sound.

With previous effect processors, in order to specify the optimum effect settings for different playing situations, such as lead and backing, the player had to

know the function of each of many parameters. Then when many effect processors were assembled into a multi-effects processor, it was quite an effort just to figure out which parameters to operate and which to ignore.

With the **G3**, you can create the sound you want using musical, rather than technical, terms, such as a rock sound, heavy metal sound, bright sound, or thick, shimmering sound; you don't have to bother with complicated parameters.

Turning the **DRIVE, TONE, SPEED, TIME, LEVEL,** or **NR** edit knobs automatically sets various parameters for those effects to always provide the best balance. This is the **IPE system**.

The **G3** has **Clean, Crunch,** and **Lead** programs. When one of these programs is selected, the **DRIVE, TONE, SPEED,** and **TIME** knobs function differently ways so as to operate in the optimum way for clean, crunch, or lead effects.

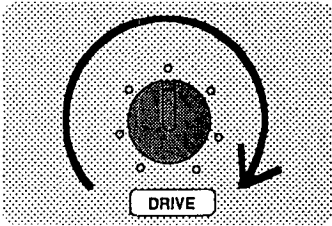

DRIVE

When a **CLEAN** program is selected:

The farther you turn the edit knob to the right, the more of a **punchy, attack sound** you get.

When a **CRUNCH** or **LEAD** program is selected:

DRIVE specifies the strength of the distortion.

Turning **DRIVE** to the right **increases the distortion**.

TONE

Clean

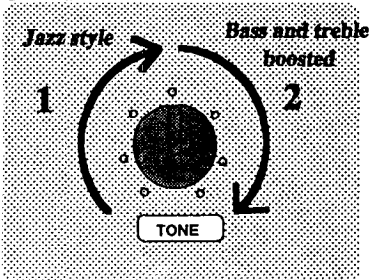

When a **CLEAN** program is selected:

In range **1**, the sound is a **soft jazz sound**. Turning the edit knob to the left makes the sound softer.

In range **2**, the sound has the **bass and treble boosted with the middle cut**. Turning the edit knob to the right makes this effect more intense.

When the edit knob is at the center, the sound does not have the equalizer applied.

Crunch

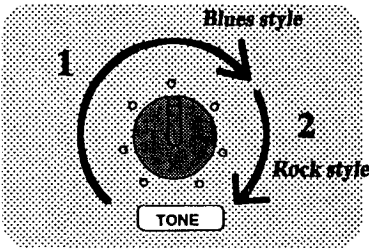

When a **CRUNCH** program is selected:

In range **1**, the sound is **bluesy** with the mid frequencies emphasized. In this range, turning this edit knob to the right **raises the emphasized tones**.

In range **2**, the sound is a **bright rock sound**. Turning the edit knob to the right **makes the sound brighter**.

Lead

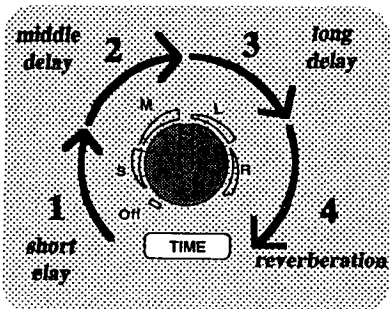
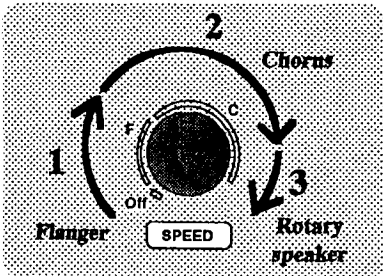
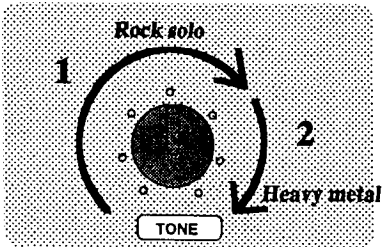

When a **LEAD** program is selected:

In range **1**, the sound has the middle range emphasized **for rock solos**. In this range, turning this edit knob to the right raises the emphasized sound region.

In range **2**, the sound is a **heavy metal style** sound with both the lowest and highest frequencies boosted with middle cut. In this range, turning the edit knob to the right makes this effect more intense.

SPEED

For all programs

(**CLEAN, CRUNCH, and LEAD**):

In range **1**, the sound has a **flanger** effect. Within this range, turning the edit knob to the right makes the flanger undulation faster and deeper.

In range **2**, the sound has a **chorus** effect. Within this range, turning the edit knob to the right makes the chorus effect faster and thicker.

In range **3**, the sound has a **rotary speaker** type effect. Turning the edit knob to the right makes the apparent speaker rotation faster.

Turning this edit knob all the way to the left switches off the chorus/flanger effect.

TIME

For all programs

(**CLEAN, CRUNCH, and LEAD**):

In range **1**, the sound has a **short delay** effect. Within this range, turning the edit knob to the right makes the delay sound louder.

In range **2**, the sound has a **middle delay** effect. Within this range, turning the edit knob to the right makes the delay sound louder and increases the number of repeats.

In range **3**, the sound has a **long delay** effect. Within this range, turning the edit knob to the right makes the delay sound louder and increases the number of repeats.

In range **4**, the sound has a **reverberation** effect. Within this range, turning the edit knob to the right makes the reverberation louder and the reverberation time longer.

Turning this edit knob all the way to the left switches off the delay/reverberation effect.

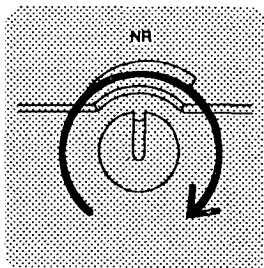
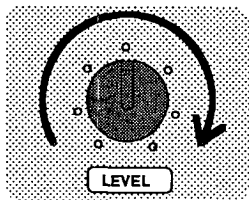

LEVEL

For all programs

(**CLEAN**, **CRUNCH**, and **LEAD**):

This edit knob adjusts the overall volume of the program sound. Turning it to the right raises the volume.

N.R.

For all programs

(**CLEAN**, **CRUNCH**, and **LEAD**):

This edit knob sets the strength of the **noise reduction** effect. Turning this edit knob to the right increases the noise suppression effect.

Turn this edit knob to a level at which the noise does not bother you when the guitar string is gently muted.

Note : The scale marks that appear around the edit knobs show the range in which the respective effects are obtained and rough criteria for their intensity. The position where the effect is switched off and the position of the marks do not always match exactly.

2. Original value display

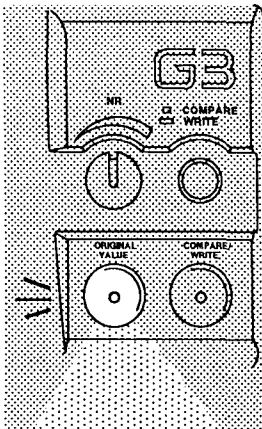

Original Value

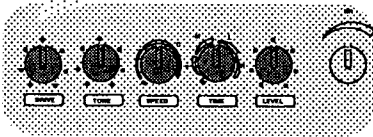

When you change the nine **G3** effect programs the way you like, there may be times when you want to know what edit knob positions were used in the original effect program. When creating a new sound and comparing it with the original program, the **original value LED** is a benchmark.

On your amps and effects processors, you probably have tape marking your regular settings for the volume, tone, and other knobs. The original value display resembles this. When you store the program you created, the edit knob positions are marked automatically and can be checked later.

The original value LED lights up when the DRIVE, TONE, SPEED, TIME, LEVEL, or NR edit knob is at the same position as in the original program.

Note: If you turn the edit knob too fast, the original value LED will light up so briefly that you will not be able to see it. To check the original value position, turn the edit knob slowly while watching the original value LED.

3. Compare mode

Compare/Write Key

Compare mode

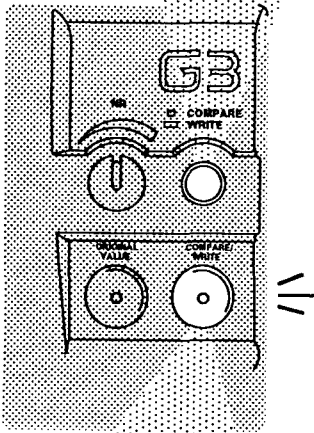

Compare/Write LED

When you press the **Compare/Write key**, the **Compare/Write LED** lights up. In the **G3's** normal mode (the mode you go into by just plugging in the power), you can create various sounds by moving the edit knobs. But sometimes you want to hear the sound of the original effect program and compare it to the currently edited version.

In **Compare mode**, you can hear the program originally stored in memory and **can switch back and forth between the original program and the edited version by pressing the Compare/Write key.**

Note : In Compare mode, moving the edit knobs does not change the sound.

To edit, press the Compare/Write key to exit compare mode.

Note : When the effects are being bypassed, pressing the Compare/Write key does not put the **G3** into Compare mode and does not light up the Compare/Write LED.

Storing the effect you created

(Program writing)

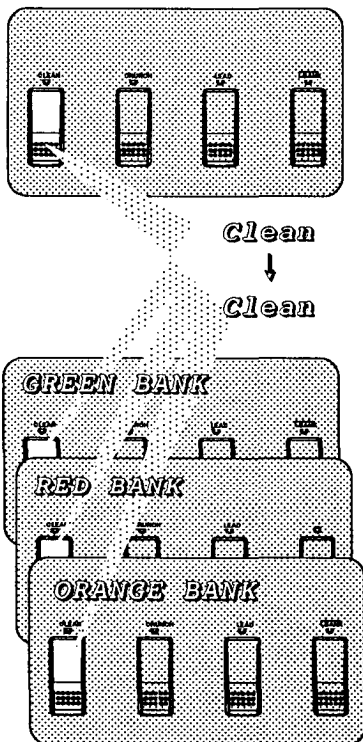

After you have created a sound, you can store the effect program you have created. This operation is called **program writing**.

If you do not carry out a program write, the moment you press another program footswitch or unplug the power, the program you worked so hard to create vanishes.

You store your programs in the corresponding program locations in the **GREEN Bank**, the **RED Bank**, or the **ORANGE Bank**; the same place where the preset programs are stored.

For example, a new effect program you created by editing a **CLEAN** program can only be written into the location of a **CLEAN** program (although the bank can be any one of the three).

Whatever program was in the destination you are writing to will be replaced by the new program.

As an example, let's make a sound based on the **CLEAN** program in program the **RED Bank** and write the resulting data as a new program.

1. Writing to the same bank:

Hold down the Compare/Write key for at least 1 second.

2. Writing to a different bank:

a) Having completed the sound creation, press the bank footswitch to select the bank you want to write to (in this example the **ORANGE Bank**).

(The Bank LED blinks with the color of the bank you are writing to—in this example, **orange**.)

b) Hold down the Compare/Write key for at least one second.

Note : When you press the Compare/Write key, the mode is first switched to Compare (as explained on Page 16). This means that if you are outputting sound while you write, the effect changes temporarily (because the sound returns to the pre-edit settings), but this does not affect what is written into memory.

The **Compare/Write LED blinks three times** and the edited data is written into memory.

If you wrote to a different bank, the **G3** switches to that bank (the **ORANGE Bank, Clean**, for this example).

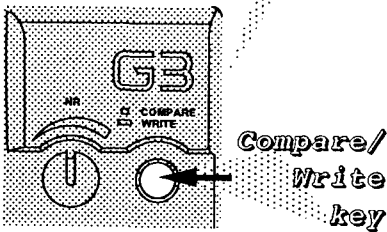
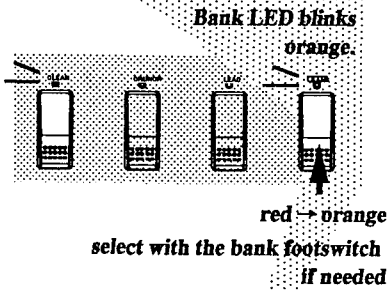

Hold the key down for
at least 1 second
→ data is stored.

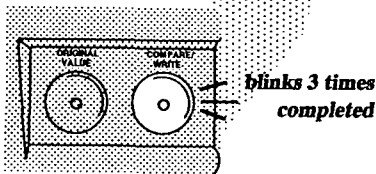

If the **G3** was in Compare mode, Compare mode ends automatically.

The sound you created can be stored to a destination in the following way:

[Edit program]		[Write destination]
CLEAN (GREEN/RED/ORANGE Bank)	→	CLEAN (GREEN/RED/ORANGE Bank)
CRUNCH (GREEN/RED/ORANGE Bank)	→	CRUNCH (GREEN/RED/ORANGE Bank)
LEAD (GREEN/RED/ORANGE Bank)	→	LEAD (GREEN/RED/ORANGE Bank)

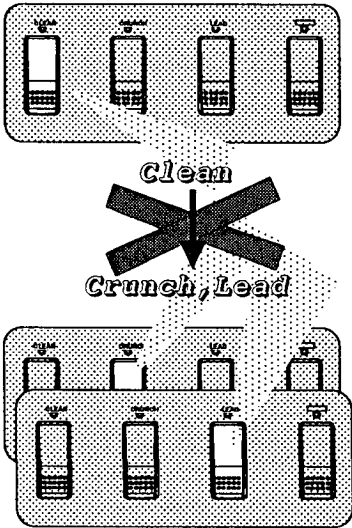

You can not write to a different type program.

For example, a new effect program created by editing a **CLEAN** program can not be written into the location of a **CRUNCH** program or a **LEAD** program.

Note : When you are finished creating your sound, write the sound before pressing any other program footswitch. Pressing another program footswitch first will erase the sound you created!

Note : When the effects are being bypassed, pressing the compare/write key does not write the program and does not light up the Compare/Write LED.

Useful functions to know

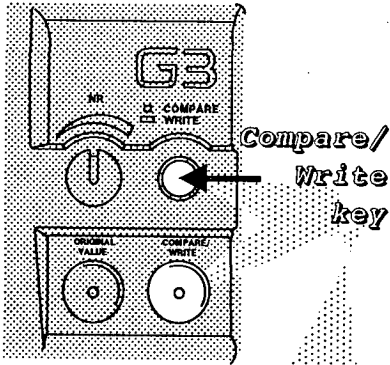

*effect is not changed
by edit knobs*

1. Edit knob Lock mode

(Compare mode)

You can also use the **Compare mode** to make sure that the effect is not accidentally changed while playing.

The basic purpose of Compare mode is to compare your edited sound with the sound stored in memory, but it also functions as a lock for the edit knobs. We recommend that you use this mode for live performances.

2. Preset data initialization

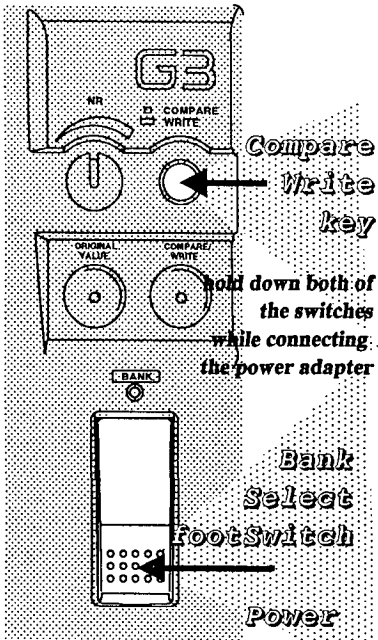

If you hold down the **Bank Select footswitch** and the **Compare/Write key** while you **connect the power**, all the LEDs blink. (If all the LEDs do not blink, but rather some or all of them stay on or stay off, then disconnect the power and try again.)

If you press the Compare/Write key with the **G3** in this state, the Compare/Write LED lights up and the **G3 initializes(resets) all the effect programs** to the original values set at the factory. (If you press some other switch, then the **G3** goes into ordinary mode without initializing the effect programs same as normal power-up mode.)

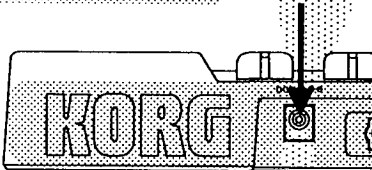

all the LEDs blink

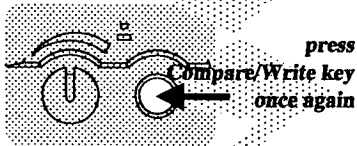

Initialized

Troubleshooting

If you think your **G3** may be broken, first check the following items. If that does not correct the symptom, contact the store where you purchased your **G3** or the nearest Korg service center.

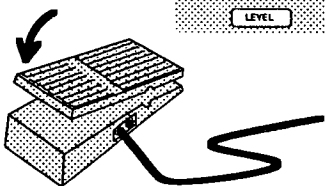
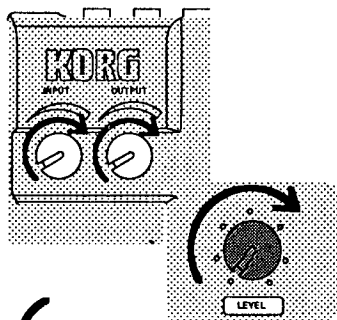

Bypass

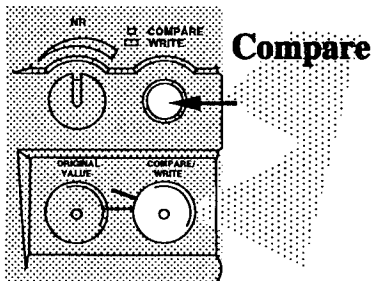
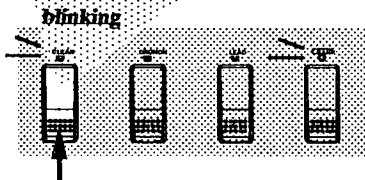

Symptom 1 No sound

1. Is the **input volume** or **output volume** 0?
2. Is the **level knob** turned to minimum?
3. If the **volume pedal** is connected, is it at the minimum volume?

Symptom 2 Effects are not applied or turning the knobs has no effect.

1. Is the effect program being **bypassed**?
If the **program LED** is blinking, the **G3** is in bypass mode.
Press the program footswitch to exit bypass mode.
2. Is the **G3** in **Compare mode**?
If the **Compare/Write LED** is lit up, press the Compare/Write key to exit Compare mode.

Note : The scales marks that appear around the edit knobs show the range in which the respective effects are obtained and rough criteria for their intensity. Therefore, the position where the effect is switched off and the position of the marks do not always match.

Specifications/Options

Built-in effects

Programs

Front panel

Rear panel

Sampling frequency

A/D

D/A

Dynamic range

Power supply

Current consumption

Maximum input level/ impedance

Maximum output level/ impedance

Dimensions

Weight

Options

Compressor, distortion, 3band equalizer, noise reduction, chorus/flanger, reverb/delay 9 (3 × 3banks)

controls: input volume, edit knobs, outputvolume

footswitches: Bank Select footswitch, compare/write key, program footswitches

LEDs: program LEDs, Compare/Write LED, Bank LED, original value LED, Peak indicator 9VDC AC adaptor jack, Input jack, Output jacks (R, L/MONO), Headphone jack, Volume pedal input jack, Tuner output jack

48 kHz

64timesover sampling, 16bit

16bit

90dB or more (IHF - A, when bypassing)

DC9V

250 mA

+ 7.0 dBu/1M Ω

+ 6.0 dBu/5k Ω

281 (W) × 209 (D) × 38 (H) mm

11.1" (W) × 8.2" (D) × 1.5" (H)

1.1kg

Volume pedal **KVP - 001**

The appearance and specifications of the G3 are subject to improvement without prior notice.

NOTICE

KORG products are manufactured under strict specifications and voltages required by each country. These products are warranted by the KORG distributor only in each country. Any KORG product not sold with a warranty card or carrying a serial number disqualifies the product from the manufacturer's/distributor's warranty and liability. This requirement is for your own protection and safety.

KORG

15 - 12, Shimotakaido 1 - chome, Suginami - ku, Tokyo, Japan

© KORG INC. 1993