

POLY-800II

**PROGRAMMABLE
POLYPHONIC
SYNTHESIZER
OWNER'S MANUAL**



KORG

POLY-800II

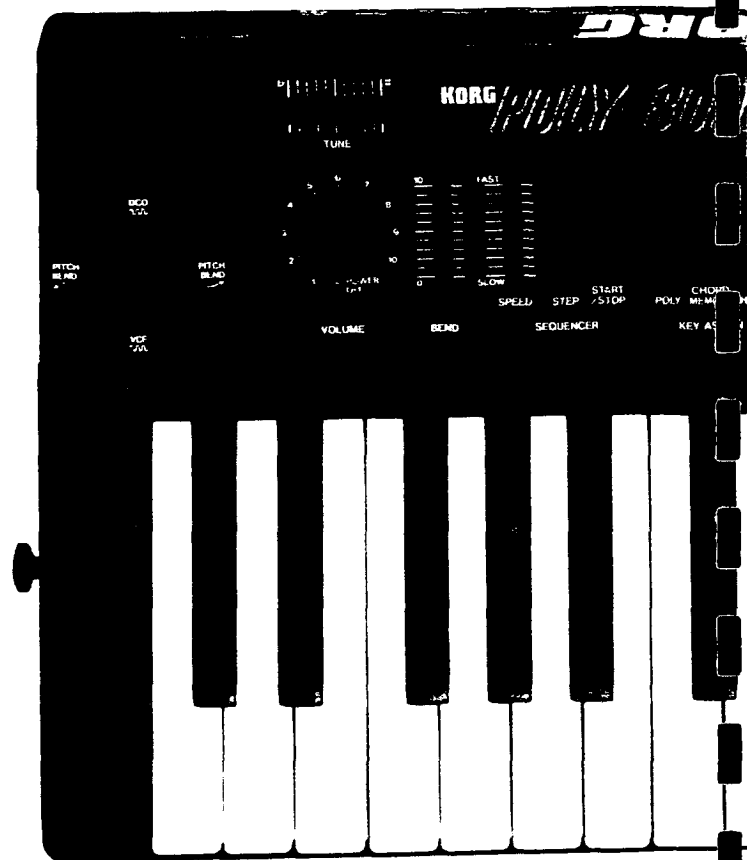

POLY-800II MAJOR FEATURES

1 Digital delay (1024ms maximum) built into an 8-voice, 64-program memory programmable polyphonic synthesizer. Delay settings can be stored in memory along with programmed sounds. Chorus, flanging, short and long delays... many kinds of stereo digital delay effects are possible.

2 Programmable equalizer facilities are also built into the POLY-800II. You can adjust bass and treble response independently and store these EQ settings with particular sounds in the 64-program memory.

Thank You and congratulations on your choice of the KORG POLY-800II. To obtain optimum performance from this advanced instrument, please read this manual carefully before operating.

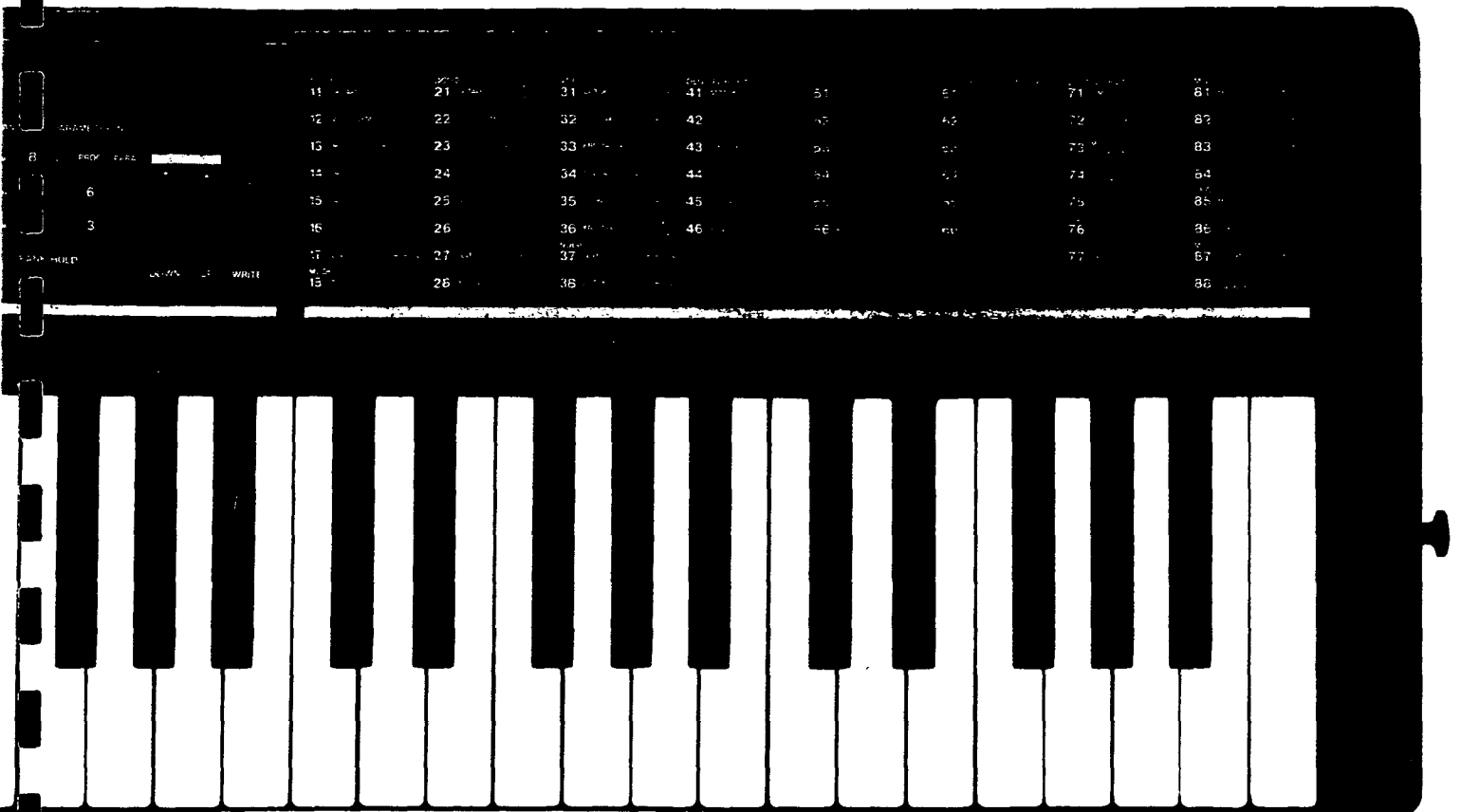

3 Includes a 1000-note sequencer which can be set for repeated or "one time" playback. The REPEAT mode performs arpeggios and automatic bass lines. Sequencer data can be transferred over MIDI, so you can sequence sounds on other synthesizers at the same time.

4 There are two digital-controlled oscillators (DCO1 & DCO2), the basic sound sources, which can be used in a double mode to create an extra fat sound. This doubles up oscillator voice assignments, resulting in 4-voice polyphonic keyboard operation.

5 Three digital envelope generator (DEG) modules provide independent contouring for DCO1, DCO2, and VCF & NOISE. Each DEG has six (ADBSR) adjustable parameters for extremely precise control.

6 The tape interface lets you store sound and sequencer data on cassette.

7 Operates on AC or batteries. Weighs only 4.5kg. Can be worn on stage using built-in strap pins. (With a good wireless transmitter this means you have total on-stage mobility.)

IMPORTANT SAFETY PRECAUTIONS

■ LOCATION

To avoid malfunction do not use this unit in the following locations for long periods of time:

- In direct sunlight.
- Exposed to extremes of temperature or humidity.
- In sandy or dusty places.

■ INPUT/OUTPUT JACKS AND CONNECTION CORDS

Be sure to use standard "guitar" cables with phone plugs, such as the cable supplied with this instrument, for input and output connections to the rear panel of the POLY-800II. Never insert any other kind of plug into these jacks.

■ PREVENTING ELECTRICAL INTERFERENCE

As a microprocessor based device, the POLY-800II is extremely flexible in operation, yet may possibly perform erratically if exposed to electrical interference from other electrical devices and fluorescent lamps. Avoid operating the POLY-800II near possible sources of interference. If something seems to be wrong, try turning off the power, waiting about ten seconds, then turning it back on. This resets the computer circuits to their initial state so performance should return to normal.

■ HANDLE GENTLY

Knobs and switches are designed to provide positive operation with a light touch. Excessive force may cause damage.

■ MAINTENANCE

Wipe the exterior with a soft, dry cloth. Never use paint thinner, benzene or other solvents.

■ KEEP THIS MANUAL

Store this manual in a safe place for future reference.

■ MEMORY BACKUP

- To protect your programmed memory contents, the POLY-800II utilizes a built-in rechargeable backup battery power supply. Battery life is rated at five years or more, so replacement is recommended after five years. Contact your Korg dealer or authorized service center at that time.
- For maximum security, save your sound programs on tape, using the built-in tape interface system. Then if memory contents are accidentally erased or altered, you can simply load the data back into POLY-800II internal memory in seconds!

■ POWER SUPPLY

- This unit uses six C-type (1.5V) batteries. The KORG 9V AC adaptor lets you plug into a wall socket.
- To operate this unit on AC current, never use any AC adaptor other than the KORG AC 9V adaptor for your local AC voltage. Other types of adaptors may cause malfunctions or damage.
- Malfunction or erratic behavior may result if the AC adaptor is plugged into a socket having less than about 90% of the rated voltage or more than about 10% greater than the rated voltage.
- The unit can operate on batteries for about three hours under typical conditions of use (National Hi-Top/SUM-2 DG batteries, play mode, 0 ~ 40 degrees C, 47kohm load, continuous use). Actual time will depend on kind of batteries used and whether or not headphones are plugged in.

Replace the batteries if the display darkens, if pitch becomes unstable, or if other erratic behavior occurs.

- Battery replacement procedure:
 - ① Turn off the power switch. (Remove the AC adaptor from the wall socket if used.)
 - ② Take the cover off the battery compartment in the bottom of the unit.
 - ③ Remove all the old batteries and insert six new C-type batteries of the same kind. Be careful to keep polarity (+ & -) correct for each battery.
 - ④ Snap the cover back on the battery compartment.

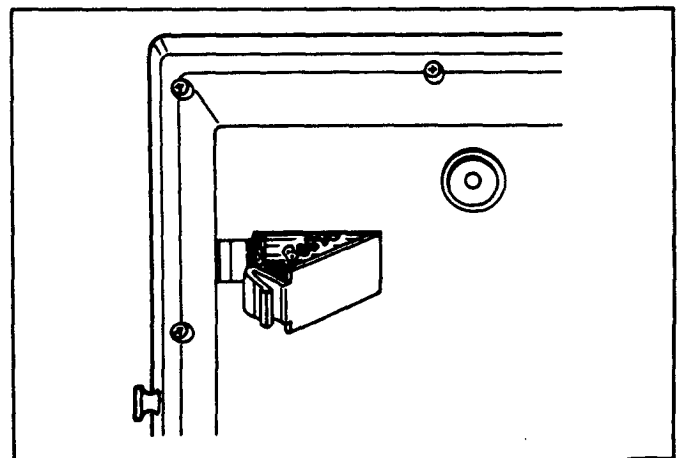

CONTENTS

FEATURES & FUNCTIONS

- 1 Front Panel 6
- 2 Rear Panel/Basic Settings 8

BASIC OPERATION

- 1 Program Selection 10
- 2 Functions for Playing 12

CREATING SOUNDS

- 1 The Setup 15
- 2 Elements of Sound Synthesis 19
- 3 Program Write 35

USING THE SEQUENCER

- 1 Sequencer Operation 38
- 2 Sequencer Parameters 39
- 3 Writing Sequences 40

TAPE INTERFACE

- 1 Saving Program Data on Tape 45
- 2 Verify Procedure 47
- 3 Load Procedure 49
- 4 Tape Interface Precautions 51

MIDI

- 1 How MIDI Works 52
- 2 POLY-800II MIDI Features 56

MIDI IMPLEMENTATION

- 1 Transmitted Data 60
- 2 Recognized Receive Data 62
- 3 Using System Exclusive Messages 64

SPECIFICATIONS & OPTIONS

70

FEATURES & FUNCTIONS

1. Front Panel

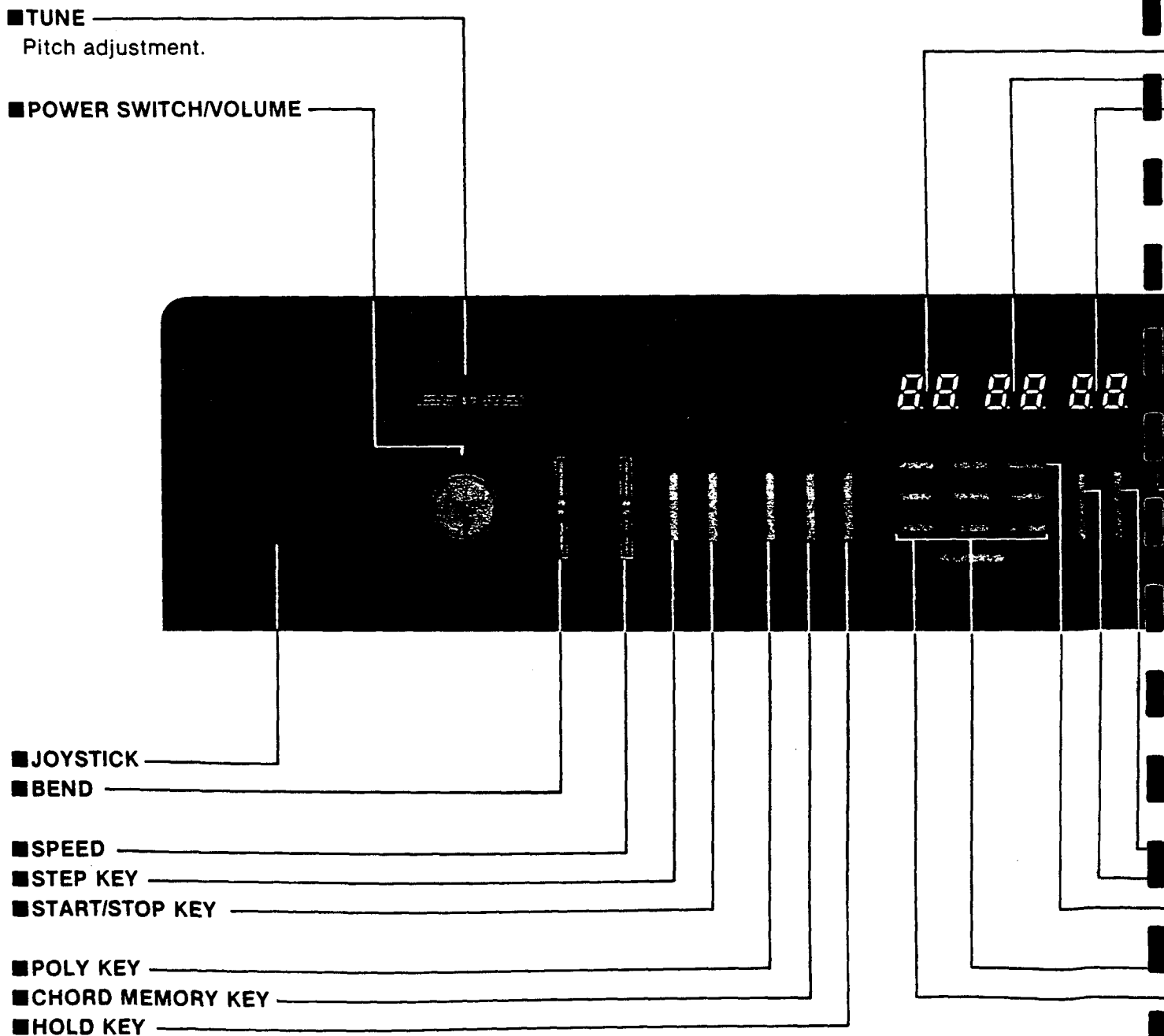

FEATURES & FUNCTIONS

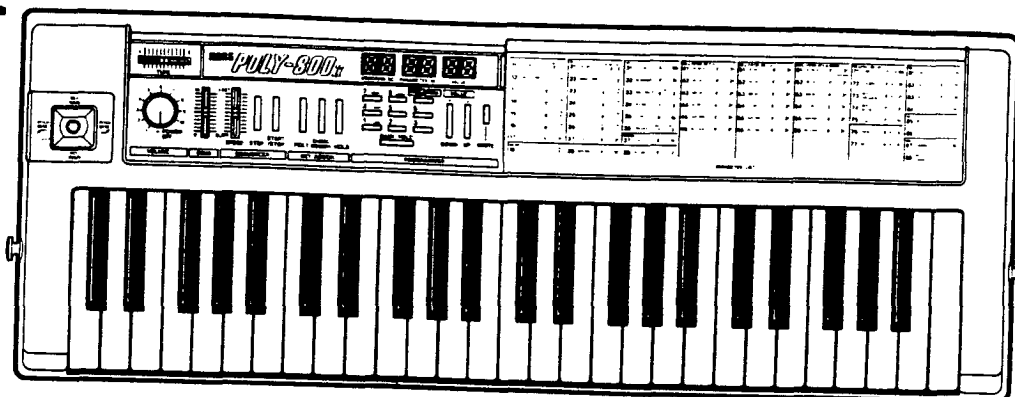

- PROGRAM NUMBER DISPLAY
- PARAMETER NUMBER DISPLAY
- VALUE DISPLAY

- PARAMETER LIST
- WRITE KEY
- UP KEY
- DOWN KEY
- PROGRAM/PARAMETER KEY (Determines whether number keys will be used to select program numbers or parameter numbers.)
- BANK HOLD KEY
- NUMBER KEYS 1~8 (Keys 1 LOAD, 4 SAVE, 7 VERIFY and 8 CANCEL are also used for tape interface operations.)

2. Rear Panel/Basic Settings

- TAPE (TAPE SWITCH, TO TAPE JACK, HIGH/LOW SWITCH, FROM TAPE JACK)
- PROGRAM UP JACK
- MIDI CONNECTORS (IN, OUT)

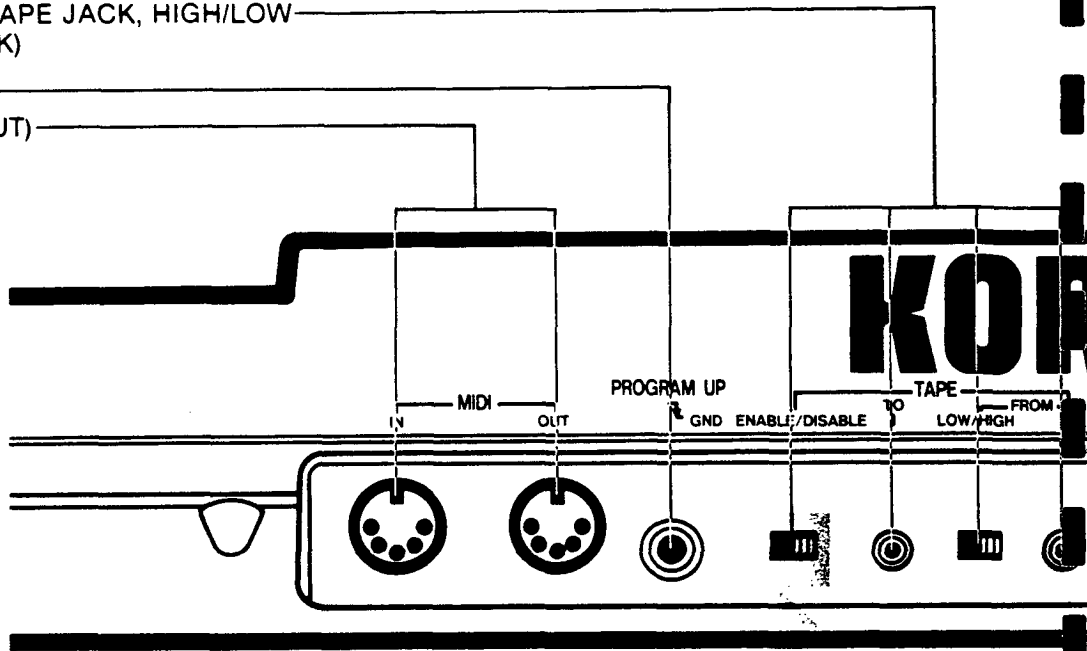

Before turning on the power, complete the basic settings and connections shown here.

Set the TAPE SWITCH to the disable position.

No sound is produced if set to ENABLE.

Set the SEQUENCER WRITE SWITCH to the DISABLE position.

Set the PROGRAM WRITE SWITCH to the DISABLE position.

FEATURES & FUNCTIONS

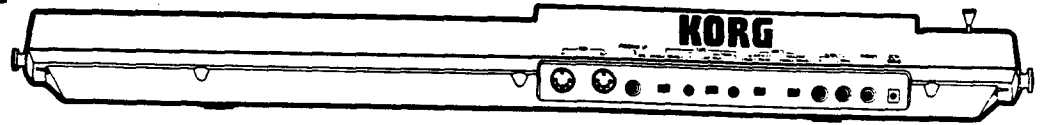

- WRITE SWITCHES (PROGRAM WRITE SWITCH, SEQUENCER WRITE SWITCH)
- OUTPUT JACKS (LEFT/MONO, RIGHT)
- PHONES JACK
- DC9V JACK
- STRAP PIN

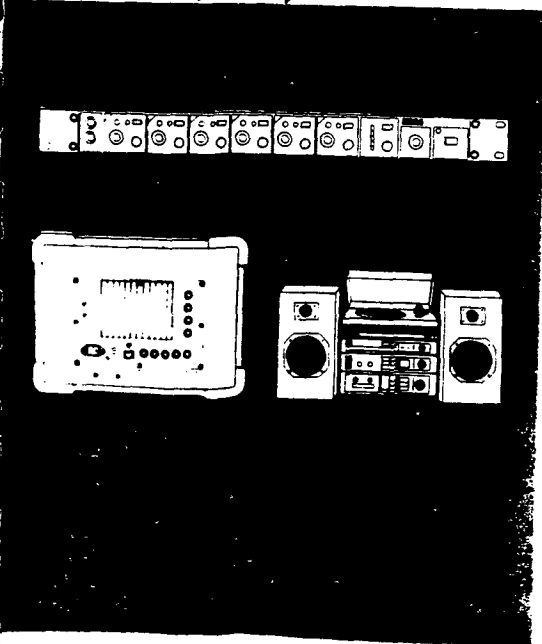
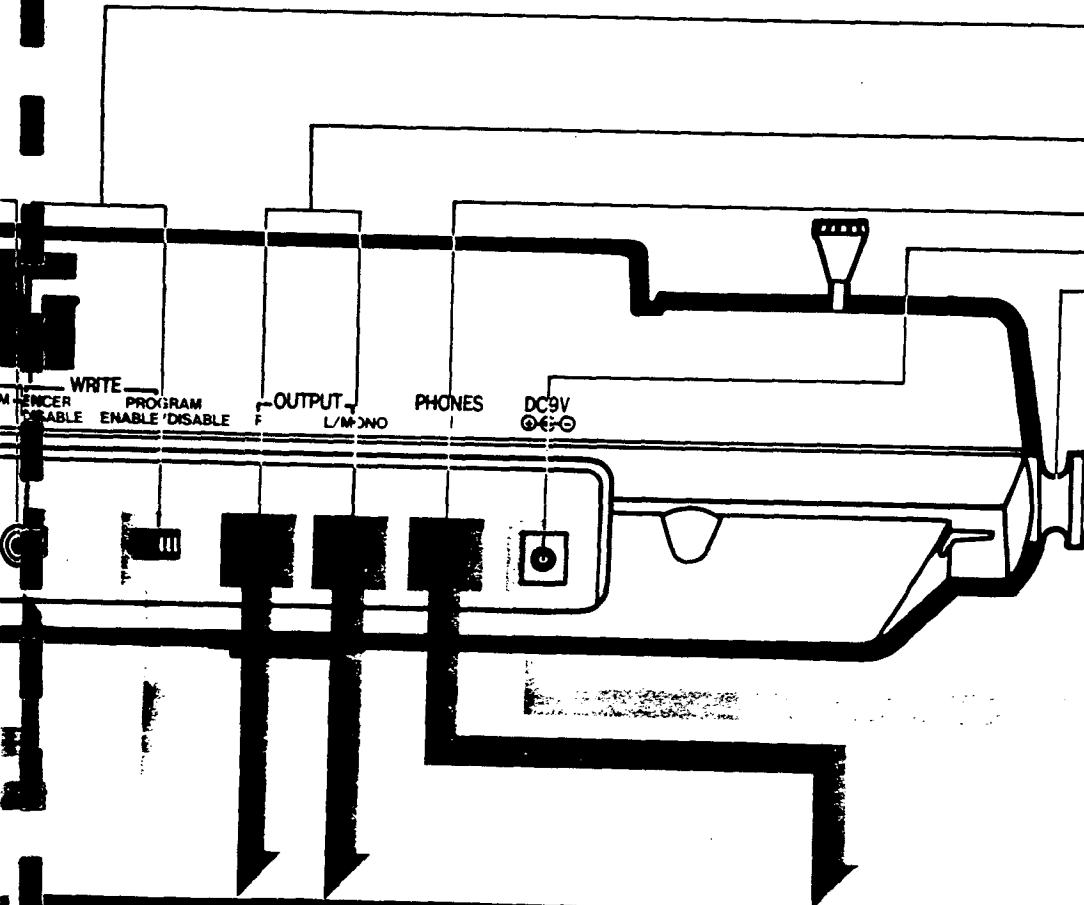

Connect AC adapter (if used) to this socket.

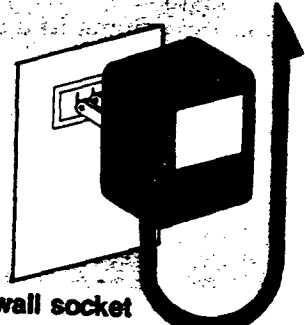

AC wall socket

KAC-301

Caution: Use only the KORG 9V adaptor intended for the local line voltage.

BASIC OPERATION

This section is meant to get you acquainted with the basic operating procedures of the POLY-800II. A menu of 64 sounds is supplied with the synthesizer. First let's learn how to select a sound.

1. Program Selection

1 Program numbers

The POLY-800II can store up to 64 sounds or "programs" in internal memory. Each program has a number. The numbering system runs from 11 to 88. All are two digit numbers. The numbers "9" and "0" are not used. The "program number" is used whenever a program is stored or retrieved.

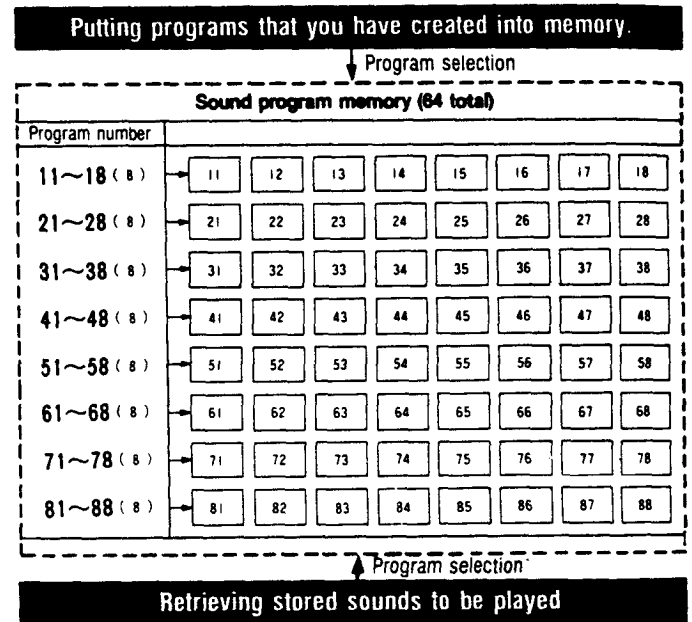

2 Program selection method

The display initially appears as shown here after the power is turned on. This indicates that program number 11 is currently selected. In this state, you can play the keyboard. Adjust the volume to a suitable level.



■ Changing program numbers. Follow this procedure to change program numbers.

Press the number keys to select the program number (11 ~ 88) of your choice.

★ To select numbers that share the same left digit, press the BANK HOLD key. This holds the left digit so that only the right digit changes when you press the number keys. Press BANK HOLD again when you want to release the left digit.

Example: Selecting program number 23.

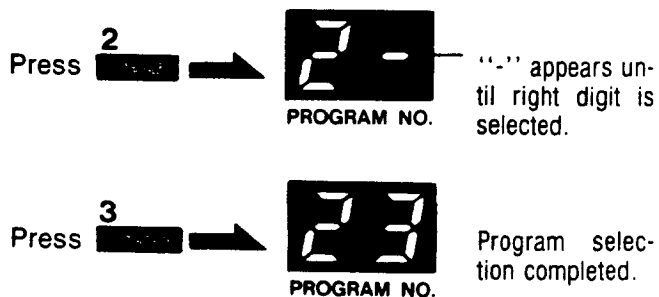

Example: Selecting programs that share the left digit "2".

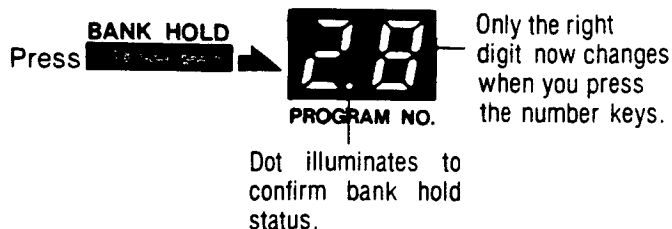

★ Delay sound is momentarily interrupted when program is selected.

③ Double mode and Whole mode

■ Some program numbers appear with an illuminated dot in the parameter display. This indicates that the eight oscillator voices are used in the "double mode." In the double mode each note is voiced by two oscillator circuits so you can play no more than four keys at the same time.

■ If there is no dot then you are in the "whole mode" and can play up to eight keys at once. In the whole mode each key played gets one oscillator voice.

Example: Program number 11.

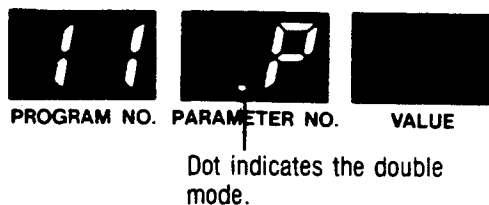

Example: Program number 26

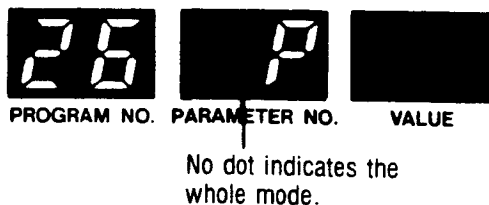

2. Functions for Playing

1 Joystick

■ The joystick lets you temporarily alter pitch and apply vibrato and wah-wah effects.

■ Moving the joystick left and right lowers and raises the pitch. The pitch bend range is determined by the BEND slider control. (Maximum is a perfect fifth up or down.)

■ Push the joystick up (away from you) to add vibrato. Vibrato is a cyclic pitch variation.

■ Pull the joystick down (toward you) to add wah-wah. Wah-wah is a cyclic variation in tone color.

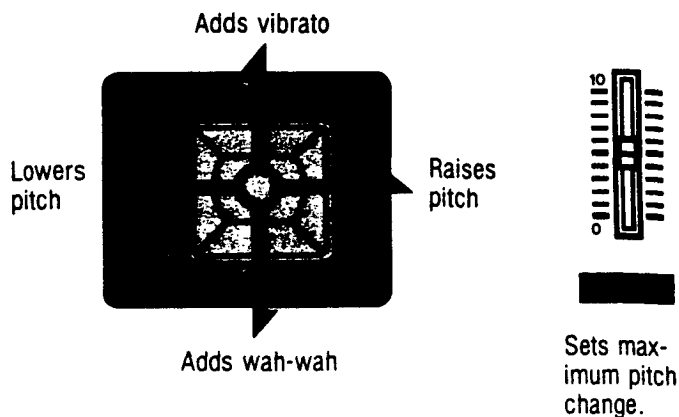

2 Key Assign Mode

■ There are three key assign modes on this instrument: POLY, HOLD, and CHORD MEMORY. These give you more flexibility to obtain the kind of sound that you seek.

■ The POLY mode is used for conventional polyphonic playing. Press the POLY key to select this mode. (The POLY mode is automatically selected when the power is turned on.)

Note:
Normally, you should not play anything on the keyboard while switching key assign modes.



POLY



PARAMETER NO.

"P" indicates POLY mode.

- If you select the HOLD mode then notes played will keep sounding indefinitely after the keys are released.

Press the HOLD key to select this mode.



HOLD

An "H" appears in the parameter display when the HOLD mode is selected.



"H" indicates HOLD mode.

- In the CHORD MEMORY mode the synthesizer remembers a chord formation or interval and reproduces it for each single key played thereafter. (Once the chord has been memorized, you must play monophonically.)

Example: Chord memory operation.

Memorized chord	Note played	Notes produced

Press the CHORD MEMORY KEY to select this mode.



CHORD MEMORY





The display shows the letter "C" to indicate the CHORD MEMORY mode.

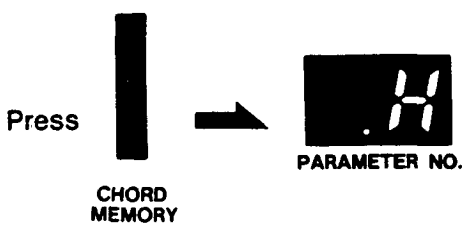

"C" indicates CHORD MEMORY mode.

BASIC OPERATION

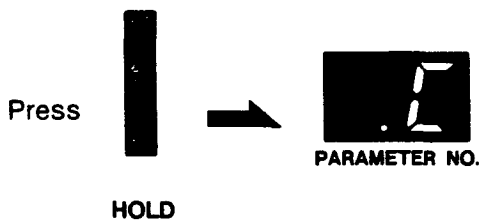
Follow this procedure to use the chord memory.

<p>① Press the HOLD key to select the hold mode.</p>	 <p>Press  →  PARAMETER NO.</p>
<p>② Play the desired chord on the keyboard. The sound will be held. Take your hands off the keyboard.</p>	
<p>③ Press the CHORD MEMORY key. The chord is now memorized.</p>	 <p>Press  →  PARAMETER NO.</p>

A chord stays in memory until you go through the process of putting a different chord in memory. So if you are playing in the POLY mode, you can start using your stored chord formation by pressing the CHORD MEMORY button. (However, if you switch to the CHORD MEMORY mode directly from the HOLD mode then you are going through the same steps as are used to put a chord into memory. So the chord will change to whatever was being played at the time you switched modes.)

Note:

When a chord containing five or more notes is memorized in the WHOLE mode (8-voice polyphonic) and you then change to a program using the DOUBLE (4-voice polyphonic) mode, only the first four notes will be reproduced. However, the full chord will be restored whenever you return to the WHOLE mode.

Program Up

- You can advance the program number one number at a time with a foot switch connected to the PROGRAM UP jack on the rear panel.

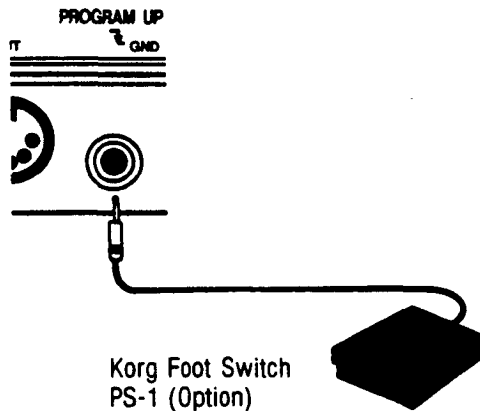

CREATING SOUNDS (How to make new sounds)

This section covers the theory and practice of sound synthesis, describing how to create and store sound programs.

1. The Setup

How the POLY-800II is organized.

Sound signals run through distinct circuits which we refer to as "modules". Each module helps mold the sound in a particular way, modifying its pitch, its timbre, its dynamics, and so on.

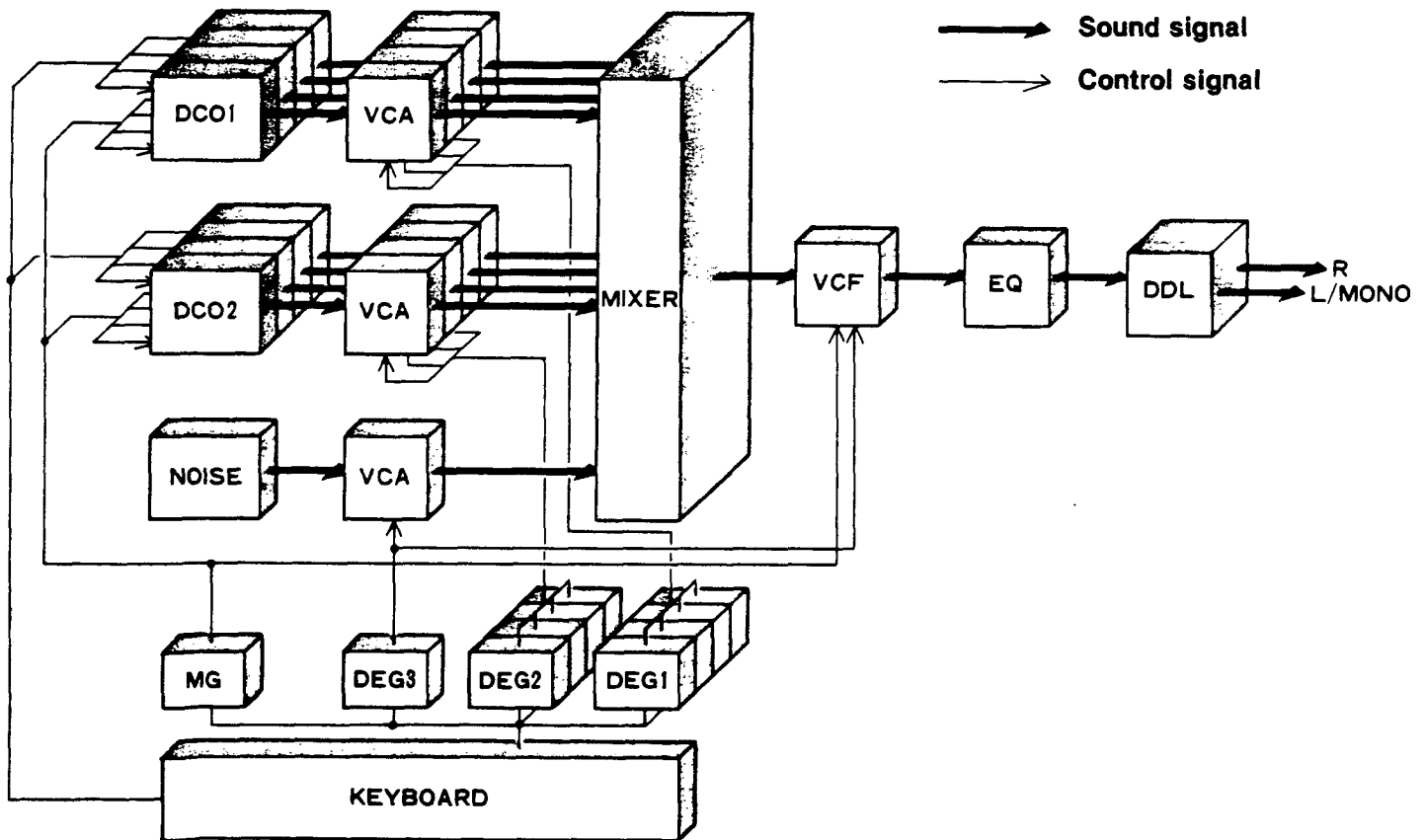

CREATING SOUNDS

DCO: Digital Controlled Oscillator. DCO1 and DCO2 give you a choice of waveforms which determine the essential pitch and timbre of your sound. These are sound source modules controlled by digital data.

NOISE: White noise can also be used as a sound source, together with or independently of the DCOs. Noise is the basis for wind, wave, and electronic drum sounds.

VCA, DEG: Voltage Controlled Amplifier and Digital Envelope Generator. These work together to control the changes in volume level which provide individual note articulation. That is, how each note attacks, decays, etc. DEG3 modulates the VCF cutoff frequency, affecting the way the timbre (brightness, etc.) changes over time.

MIXER: Adjusts the relative volume balance of the DCO1, DCO2, and NOISE sounds while mixing them together.

2 PARAMETERS & VALUES

Each of the synthesizer's modules has various "parameters" which affect the sound in particular ways. By setting the values of each parameter, you can create almost any sound that you want. To use this system, you choose a "parameter number" and then adjust that parameter's "value."

All available parameters are shown on a "parameter list" covering the right side of the front panel. For example, if you want to adjust the VCF cutoff frequency, you select parameter number 31 and change its value.

3 THEORY & PRACTICE

On this synthesizer, you do not start with a blank slate. Rather, you change or edit the current programs. Use the program selection procedure to find a sound that is close to what you want. Then adjust the values of some of its parameters. By starting with a sound that is related to your desired sound, you diminish the number of parameters that you will need to adjust. (After creating a program you can store it in the programmer by using the "program write" procedure.)

VCF: Voltage Controlled Filter. Affects the timbre of the sound by removing overtones or harmonics. The VCF can be controlled by DEG3 to produce variations in the brightness of the sound as each note is articulated.

EQ: Equalizer. Final tonal control.

DDL: Digital Delay. Applies delay effects including chorus, flanging, and echoes to the sound.

MG: Modulation Generator. Used to produce cyclic pitch variations (vibrato) by modulating the DCO, or cyclic tonal variations (wah-wah) by modulating the VCF.

Details concerning these modules will be found in the section on "the elements of sound synthesis."

Example: Some VCF parameters.

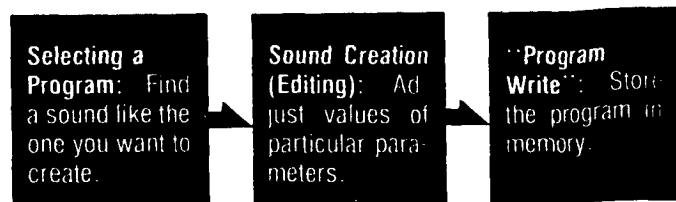
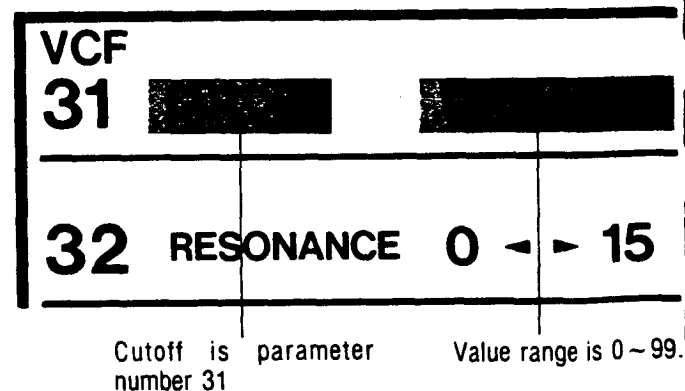

4 Value Editing

■ When you change parameter values, you change the sound. Here's how.

① Select a program that sounds similar to the one that you want to create. Use the program selection procedure to do this.

② Press the PROG/ PARA key to switch to parameter selection. The PARAMETER NO. display should show the currently selected parameter number.
(To switch to a different program, press the PROG/PARA key again.)



③ Look at the parameter list and choose the parameter number that you need to adjust. (The VALUE display will show the parameter's current value.)

Example: Selecting VCF CUTOFF, parameter number 31.

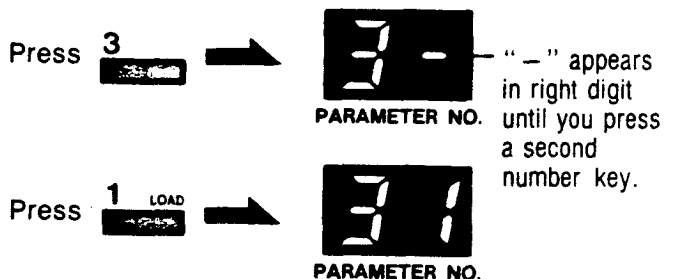

★ You can press the BANK HOLD key to keep the left digit from changing. This is useful when you want to adjust several related parameters. All of the VCF parameters, for example, start with "3". When BANK HOLD is on, only the right digit changes when you press the number keys. To release the left digit, press the BANK HOLD key again.

Example: When you want to select parameter number 30.

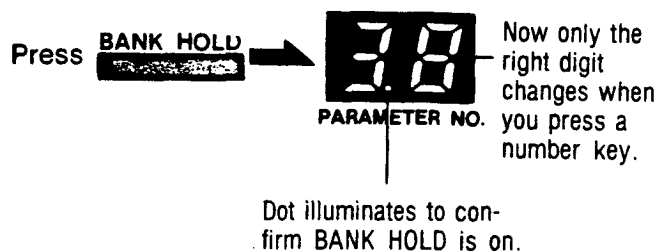

- ④ Press the UP or DOWN key to raise or lower the value of the selected parameter. If you keep either key depressed, the value will increase or decrease rapidly.

The current value is shown in the VALUE display. It changes along with the sound, as you press the VALUE DOWN and UP keys. When the value is changed from the recalled value, then a dot appears in the lower right hand corner of the display. The dot will go out if you return to the original (stored) value while editing.

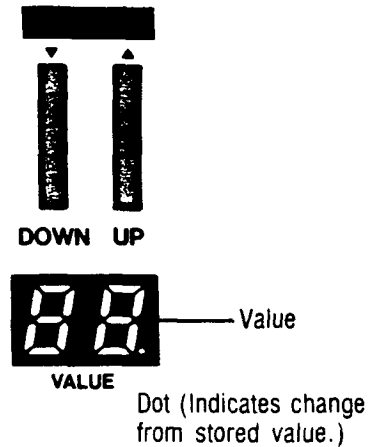

- ⑤ Repeat steps ② and ④ above, calling other parameters and adjusting their values.

(If you want to return to the original sound and cancel all of your changes, simply press the PROG/PARA key and then select the same program number again.)

Instructions for storing your edited sound are found in the "Program Write" section.

2. Elements of Sound Synthesis

(Parameters and their values)

1 DCO1, DCO2

DCO1				DCO2			
11	OCTAVE	LOW	MID HIGH	21	OCTAVE	LOW	MID HIGH
		1	2 3			1	2 3
12	WAVEFORM	<input type="checkbox"/>	<input type="checkbox"/>	22	WAVEFORM	<input type="checkbox"/>	<input type="checkbox"/>
		1	2			1	2
13	16'	OFF	ON	23	16'	OFF	ON
		0	1			0	1
14	8'	OFF	ON	24	8'	OFF	ON
		0	1			0	1
15	4'	OFF	ON	25	4'	OFF	ON
		0	1			0	1
16	2'	OFF	ON	26	2'	OFF	ON
		0	1			0	1
17	LEVEL	0 -- 31		27	LEVEL	0 -- 31	

These two sets of parameters are for control of DCO1 and DCO2 respectively. In the "double" mode, DCO1 and DCO2 are used together to build a fatter sound.

★ DCO2 parameters, numbers 21 - 27, do not function (no value display) when in the SHOLE mode, that is, when parameter number 18 (DCO) is set to a value of "1".

11, 21 OCTAVE

Each DCO can produce mixed outputs combining square wave harmonics of different "feet": 16', 8', 4', and 2'. (Each shorter foot number is 1-octave higher than the previous one. 8' is an octave above 16', 4' is another octave higher, etc.)

Use this parameter to select the basic overall pitch range of your sound.



VALUE	OCTAVE
1	LOW (one octave below middle)
2	MIDDLE
3	HIGH (one octave above middle)

CREATING SOUNDS

12, 22 WAVEFORM

This parameter selects the actual levels of the individual squarewave harmonics that are added together.

This helps determine the shape (and basic tone color) of the waveform produced by mixing the different harmonics in parameters 13 ~ 16 (and 23 ~ 26).

VALUE	WAVEFORM mode
1	
2	

At VALUE 1 (), the 16' ~ 2' harmonics are mixed at the same level, so you have a richer overtone structure.

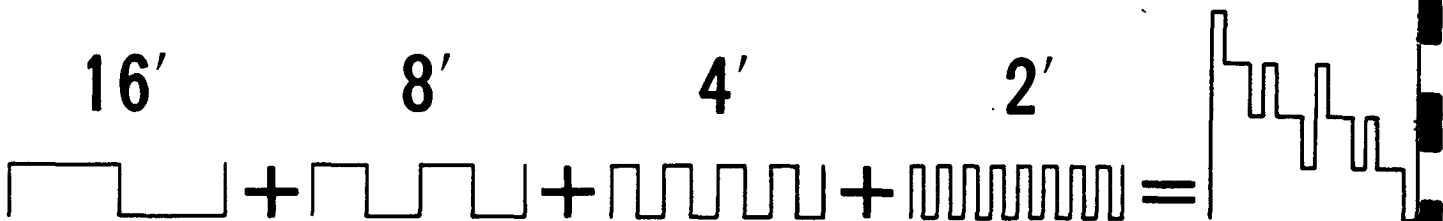

At VALUE 2 (), the 8' harmonic is mixed at half the level of 16', 4' at 1/4 the level, and 2' at 1/8 the level. These ratios result in a stepped sawtooth waveform.

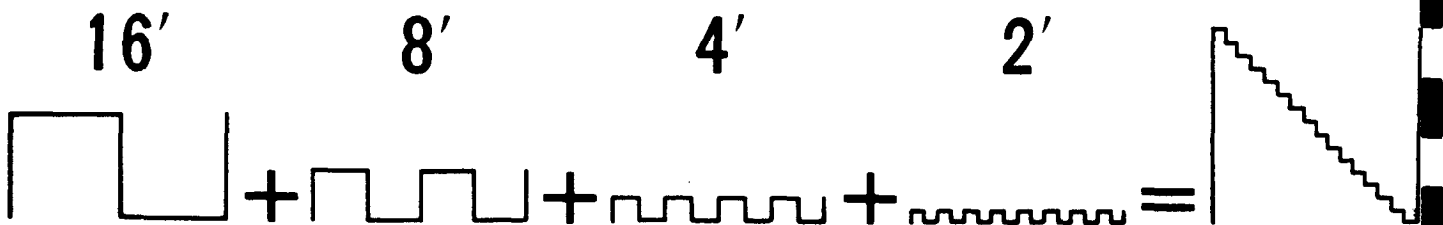

Select the waveform according to the kind of timbre characteristics you want.

13 ~ 16, 23 ~ 26 HARMONICS 16' ~ 2'

These parameters let you switch each of the individual squarewave harmonics on or off. Together with the WAVEFORM value (which controls the mixing ratio) your choice of harmonics helps determine the resulting waveform and timbre. Turn each of these on or off according to the kind of timbre you want.

For example, if you set the WAVEFORM to 2 (\sim) and turn off the 8' parameter while leaving the other harmonics on, you will get the kind of waveform shown here.

VALUE	16'	8'	4'	2'
0	OFF	OFF	OFF	OFF
!	ON	ON	ON	ON

NOTE:
If the 2' harmonic is used at the OCTAVE "HIGH" setting, then the highest octave will be voiced at the same pitch as sounds one octave lower.

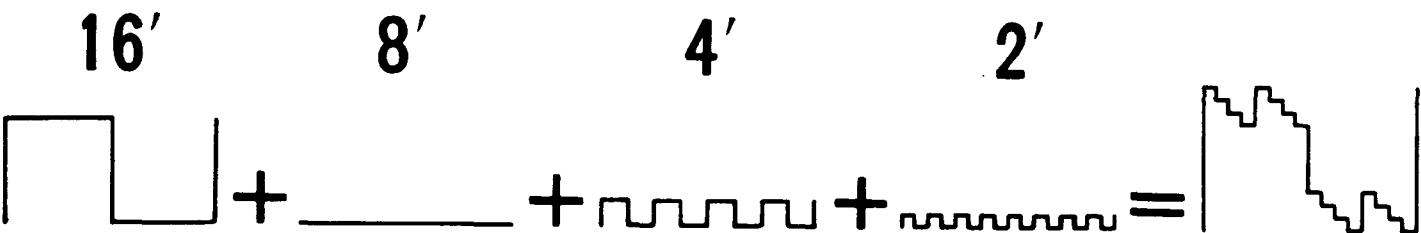

17, 27 LEVEL

Sets the maximum volume level for each DCO. This lets you adjust the balance between DCO1 and DCO2. It is also useful for adjusting volume to match other sounds (so volume stays the same when you switch to other programs).

VALUE	DCO Volume level
0	Silent (no output from DCO)
↑	↑
3 !	Maximum

CREATING SOUNDS

2 MODE

MODE 18 DCO WHOLE 1 DOUBLE 2 28 INTERVAL 0 -- 12 38 DETUNE 0 -- 3

These parameters affect the way that the two oscillator modules (DCO1 and DCO2) are used by the synthesizer.

18 DCO

You can choose between the WHOLE mode and the DOUBLE mode.

This is an 8-voice synthesizer. There are four voices in DCO1 and another four voices in DCO2.

When you select the WHOLE mode, the four voices in DCO2 are put under the control of the DCO1 settings. In this mode you can play up to eight keys at once. However, the DCO2 parameters, the DEG2 (FOR DCO2) parameters, and the 28 INTERVAL and 38 DETUNE parameters have no effect.

If you select the DOUBLE mode then four voices are under the control of DCO1 and the other four voices are under the control of DCO2. When a key is played, you get the sound of a voice each from DCO1 and DCO2. That is, two voices sound for each key played. This produces a fatter sound. (But a maximum of only four keys can be played at once.)

VALUE	DCO mode	
1	WHOLE	(8-voice polyphonic)
2	DOUBLE	(4-voice polyphonic)

Example: In whole mode. Eight voices are under control of DCO1.

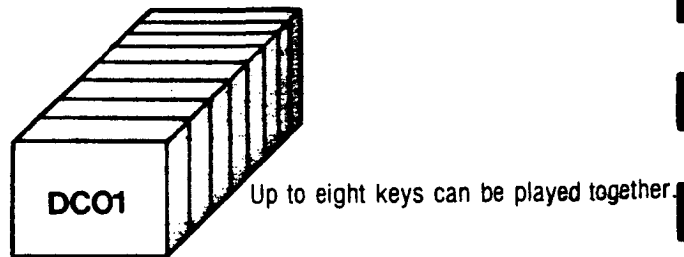

Example: In double mode. DCO1 controls four voices; DCO2 controls another four voices.

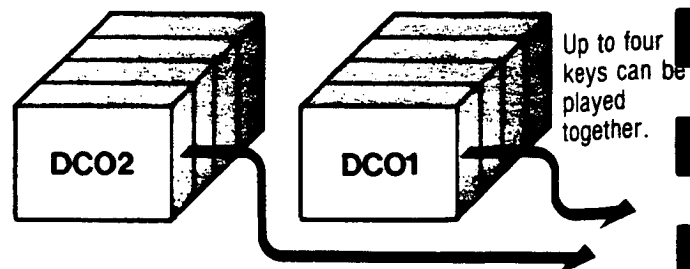

Two voices sound for each key so you obtain a fatter sound.

28 INTERVAL

This lets you transpose or "offset" the pitch of DCO2 so that it sounds at a constant interval above DCO1. The value range covers a full octave in semitone steps. This is effective in the DOUBLE mode since it gives you harmonies between the notes produced by the two oscillators.

However, this parameter has no effect when in the WHOLE mode (18 DCO set to 1).

VALUE	DCO2 pitch difference
0 ↑ 12	No difference (Adjustable in semitone steps) ↑ One octave higher

Example: Assuming the same basic settings for DCO1 and DCO2, we get the result shown here if the INTERVAL value is set to "7".

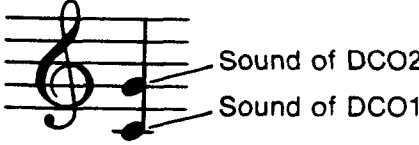
Note played	Notes produced
	
	A perfect 5th (7 semitones) interval is produced.

38 DETUNE

For fine adjustment of DCO2 pitch. By setting slight pitch differences between the two oscillators in the DOUBLE mode, you can cause beating between the frequencies, thereby creating a fatter sound. This parameter has no effect when parameter "18 DCO" is in the WHOLE mode.

VALUE	DCO2 detuning
0 ↑ 3	None (same pitch) ↑ Maximum detuning

3 NOISE

NOISE
37 LEVEL 0 - - 15

Besides the two DCOs you can also use white noise as a sound source. This parameter controls the volume of this noise.

37 LEVEL

White noise volume adjustment.

VALUE	NOISE level
0	No noise produced
↑	↑
15	Maximum noise volume

4 VCF

VCF
31 CUTOFF 0 - - 99
32 RESONANCE 0 - - 15
33 KBD TRACK OFF HALF FULL
0 1 2
34 POLARITY 1 2
35 EG INT 0 - - 15
36 TRIGGER SINGLE MULTI
1 2

The voltage controlled filters remove or emphasize portions of the basic waveform harmonics. This affects the timbre of the DCO1, DCO2, and NOISE waveforms. The VCF works as a low-pass filter, removing frequencies above the selected CUTOFF frequency (while allowing lower frequencies to pass through). VCF operation is controlled by the parameters in this section.

31 CUTOFF

This determines the cutoff frequency of the low-pass filter. The higher the cutoff frequency, the brighter the sound.
 At the highest value, "99", all harmonics contained in the DCO1, DCO2 and NOISE waveforms are passed. The lower the value, the more harmonics are cut off, so the sound becomes progressively rounder or less bright.

NOTE:
 In some cases you may not hear any sound if this parameter's value is at or near "0".

VALUE	TIMBRE
0	Dull or rounded
↕	↕
99	Bright, unchanged timbre

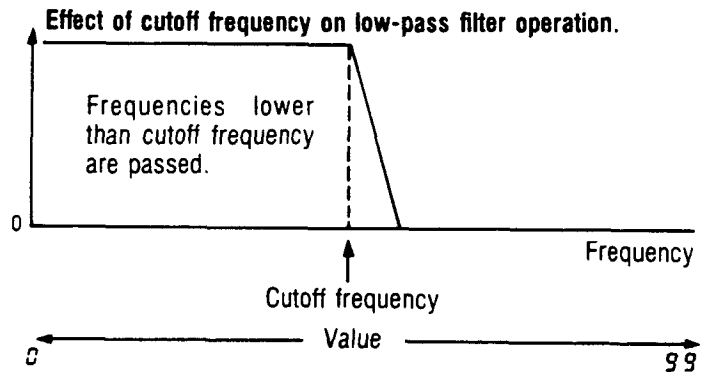

32 RESONANCE

This parameter emphasizes the harmonics near the cutoff frequency, producing a characteristic peaky, bandpass, or wah-wah type of sound. The higher the value, the higher the resonance peak and the more obvious the effect. At or near the maximum value, "15", you get a self-oscillation effect at the cutoff frequency. This produces a pure sine wave, which acts as an extra pitch or sound source and can be used for special effects.

VALUE	EFFECT
0	None
↕	↕
15	Ringing "peaky" sound.

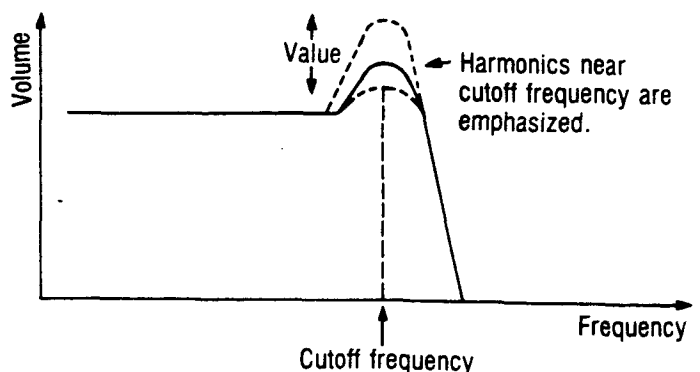

CREATING SOUNDS

33 KBD TRACK

Keyboard tracking affects how the cutoff frequency changes as you play notes higher or lower on the keyboard. At higher values (1 or 2) cutoff rises with keyboard pitch, increasing total brightness as is characteristic of most musical instruments.

NOTE:

This is the parameter to adjust if you want the same brightness from low notes as high notes when you play the upper and lower octaves of the keyboard at the same time.



34 POLARITY

Determines how the cutoff frequency is affected by DEG3. You can choose a normal (VALUE 2) polarity, so that brightness increases in proportion to volume (as with most musical instruments); or inverted polarity (VALUE 1) for special sounds where you want the opposite effect.

35 EG INT

This "EG intensity" parameter's value determine the degree to which DEG3 affects the cutoff frequency. The higher the value, the more obvious will be the change in timbre.

VALUE	Keyboard tracking effect
0	OFF (0%: No change in cutoff frequency)
1	HALF (50%)
2	FULL (100%: Maximum tracking)

VALUE	Effect on DEG3 envelope
1	 Cutoff frequency is swept down during the attack portion of the envelope, lessening the initial brightness of the sound.
2	 Cutoff frequency is swept up during the attack portion of the envelope, so the sound first becomes brighter before it returns to normal.

VALUE	Intensity of DEG3 effect on VC
0	No modulation (No change in timbre)
15	Maximum modulation (Maximum timbre change)

36

TRIGGER

Selects the kind of trigger used for DEG3 modulation of the VCF cutoff frequency.

At value "1" (single trigger) DEG3 is triggered by the first note played and no new envelope is generated until all keys are released and a new "first key" is played. At value "2" (multiple trigger) DEG3 is triggered with each key played, so you get a new envelope (attack, decay, etc. cycle) for each note.

VALUE	TRIGGER
1	SINGLE
2	MULTI

5 DEG1, DEG2

DEG1(FOR DCO1)		
41	ATTACK	0 - - 31
42	DECAY	0 - - 31
43	BREAK P.	0 - - 31
44	SLOPE	0 - - 31
45	SUSTAIN	0 - - 31
46	RELEASE	0 - - 31

DEG2(FOR DCO2)		
51	ATTACK	0 - - 31
52	DECAY	0 - - 31
53	BREAK P.	0 - - 31
54	SLOPE	0 - - 31
55	SUSTAIN	0 - - 31
56	RELEASE	0 - - 31

These two digital envelope generators control the contour of the sound, that is, how volume changes dynamically over time. Each of the two DCOs has its own DEG.

In the DOUBLE mode DEG1 controls DCO1 while DEG2 provides independent control over DCO2.

In the WHOLE mode, all voices are under the control of DEG1. In this case, DEG2 parameter settings have no effect and DEG2 values are not displayed.

The following six parameters determine the volume change.

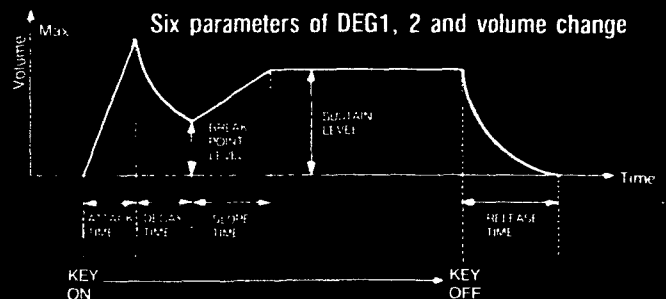

CREATING SOUNDS

41, 51 ATTACK (Rate)

Controls how long it takes for the volume to rise from zero to its maximum level after a note is played on the keyboard.

VALUE	Attack time
0	Short
↑	↑
31	Long

42, 52 DECAY (Rate)

Determines how long it takes for the volume to fall from its maximum attack level to the break point level.

VALUE	Decay time
0	Short
↑	↑
31	Long

43, 53 BREAK P. (Break Point Level)

Determines the level at which volume stops dropping during the decay. If this is set to the same value as the sustain level, then the envelope becomes a conventional ADSR type (as if it had no break point or slope parameters).

VALUE	Break point level
0	0
↑	↑
31	Max.

44, 54 SLOPE (Rate)

Determines how long it takes for volume to change from the break point level to the sustain level. Note that if the break point is lower than the sustain level, then the slope functions as a second attack. If the break point is higher than sustain, then slope functions as a second decay.

VALUE	Slope time
0	Short
↑	↑
31	Long

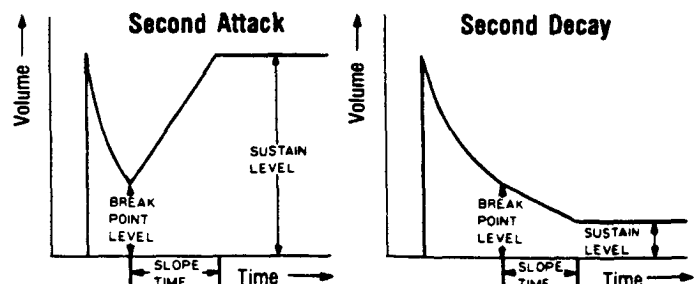

45, 55 SUSTAIN (Level)

Determines the level at which volume is held after the attack, decay, and slope phases are completed, for as long as the note is held down on the keyboard.

VALUE	Sustain level
0	0
↑	↑
31	MAX

46, 56 RELEASE (Rate)

Determines how long it takes for the sound to fade away after you release the note on the keyboard.

VALUE	Release time
0	Short
↑	↑
31	Long

6 DEG3

DEG3 (FOR VCF & NOISE)		
61	ATTACK	0 - - 31
62	DECAY	0 - - 31
63	BREAK P	0 - - 31
64	SLOPE	0 - - 31
65	SUSTAIN	0 - - 31
66	RELEASE	0 - - 31

The timbre or tone color and noise level can also be varied dynamically over time. This is the job of DEG3.

DEG3 produces a control voltage which affects the VCF cutoff frequency in accordance with the 34 POLARITY and 35 EG INT parameters. (See sections on these parameters for details.)

DEG3 also adjusts the noise level dynamically. (The DEG3 output voltage fluctuations are converted directly into noise volume fluctuations.)

DEG3 output voltage is controlled by six parameters as shown here.

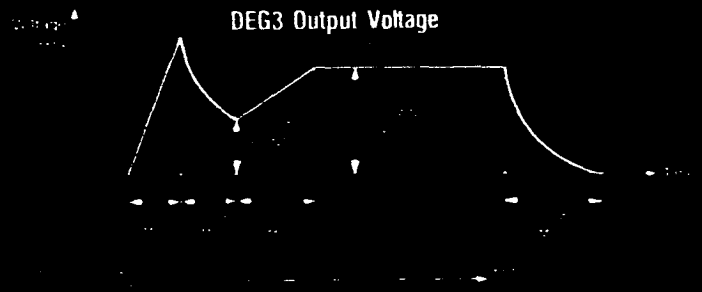

CREATING SOUNDS



ATTACK (Rate)

The parameter controls how long it takes for the DEG3 output voltage to rise from zero to its maximum level.

VALUE	Attack time
0	Short
↑	↑
31	Long



DECAY (Rate)

This parameter controls how long it takes for DEG3 output voltage to fall from its maximum level (after an attack time) to the break point level.

VALUE	Decay time
0	Short
↑	↑
31	Long



BREAK P. (Break Point Level)

This parameter determines the DEG3 output voltage after the decay time. If this is set to the same value as the sustain level, then the envelope becomes a conventional ADSR type.

VALUE	Break point level
0	0
↑	↑
31	Max.



SLOPE (Rate)

This parameter controls how long it takes for the DEG3 output voltage to change from the break point level to the sustain level.

VALUE	Slope time
0	Short
↑	↑
31	Long



SUSTAIN (Level)

This parameter determines the DEG3 output voltage after the slope time.

VALUE	Sustain level
0	0
↑	↑
31	Max.



RELEASE (Rate)

This parameter determines how long it takes for the DEG3 output voltage to fall to zero level after the note is released on the keyboard.

VALUE	Release time
0	Short
↑	↑
31	Long

DIGITAL DELAY

DIGITAL DELAY		
71	TIME	0 - - 99
72	FEEDBACK	0 - - 15
73	MOD FREQUENCY	0 - - 31
74	MOD INTENSITY	0 - - 31
75	EFFECT LEVEL	0 - - 15

The built-in digital delay enables a variety of echo and delay effects including chorus and flanging. The parameters in this section control operation of the digital delay.

★ Delay sound output is momentarily interrupted when you change the values of these parameters.

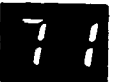

TIME

The value of this parameter determines the delay time. Smaller values produce shorter delays, suitable for chorus, flanging, and doubling effects. Larger values produce longer delays, up to a maximum of about 1024ms.

VALUE	Delay time
0	Short
↑	↑
99	Long (About 1024ms)



FEEDBACK

Controls how much (if any) of the delayed sound is sent back into the input of the delay circuitry. With longer delay times, feedback determines the number of times that the echo is repeated. Short delay times and a high feedback level are used (with modulation) to produce flanging.

VALUE	Feedback level
0	No feedback
↑	↑
15	Maximum

CREATING SOUNDS

73

MOD FREQUENCY

This controls the frequency (cycles per second) of the low frequency oscillator which can be used to modulate the delay time.

Modulation is used for chorus and flanging effects.

VALUE	Modulation frequency
0	Slow
↑	↑
31	Fast

74

MOD INTENSITY

Determines the depth to which the delay time will be affected by the low frequency oscillator (MOD. FREQUENCY).

When this value is "0", there is no modulation of the delay time. Adjust the value as necessary for chorus, flanging, and related effects.

VALUE	Modulation depth
0	No modulation
↑	↑
31	Deep

75

EFFECT LEVEL

This controls the volume of the digital delay sound in the output mix. (The signal from the digital delay is mixed with the normal synthesizer signal in the output.) When this value is "0", no delay is heard.

VALUE	Delay effect volume
0	No delay effect (digital delay not used)
↑	↑
15	Maximum

EQ

EQ			
76	TREBLE	- 6	- - 6
77	BASS	- 6	- - 6

The EQ or equalization section has treble and bass tone controls which can be used to "fine tune" the sound.

★ Delay sound output is momentarily interrupted when you change the values of these parameters.

76 TREBLE

Provides boost or attenuation in the high frequency range around 2kHz.
 Values above "0" boost the treble response.
 Values below "0" (with a minus sign to the left of the number) attenuate the response.
 At "0" there is no change.

VALUE	Equalization
- 6	Reduced treble (minimum)
↓	↓
0	No equalization applied
↓	↓
6	Elevated treble response (maximum)

77 BASS

Provides boost or attenuation in the low frequency range around 300Hz.
 Values above "0" (with no "-" sign) boost the bass response.
 Values below "0" attenuate the response.
 At "0" there is no change.

VALUE	Equalization
- 6	Reduced bass (minimum)
↓	↓
0	No equalization applied
↓	↓
6	Elevated bass response (maximum)

CREATING SOUNDS

MG

MG		
81	FREQ	0 - - 15
82	DELAY	0 - - 15
83	DCO	0 - - 15
84	VCF	0 - - 15

The modulation generator provides cyclic modulation of DCO pitch (for vibrato effects) and VCF cutoff frequency (for wah-wah effects). The four parameters in this section are used to create and adjust these kinds of modulation effects.

81

FREQ

Adjusts the speed of the vibrato or wah-wah effect. This parameter's value also determines the speed of the DCO and VCF modulation effects produced when moving the joystick. (See section on joystick.)

VALUE	Speed of vibrato or filter mod
0	Slow
↑	↑
15	Fast

82

DELAY

Determines the amount of delay following key depression prior to the onset of vibrato or other modulation effects. At 0, there is no delay, and modulation begins immediately when the first note is played. The higher the value, the longer the delay.

VALUE	Delay time
0	None: modulation effect starts immediately
↑	↑
15	Long delay

83

DCO (vibrato depth)

Controls the amount of pitch variation in the vibrato effect (that is, the depth of frequency modulation).

VALUE	Vibrato depth
0	No effect
↑	↑
15	Deep

84

VCF (filter mod depth)

Controls the depth of cyclic filter mod effects (that is, the depth of VCF cutoff frequency modulation).

VALUE	Filter mod depth
0	No effect
↑	↑
15	Deep

3. Program Write

(Putting sounds into programmer memory)

1 Program write procedure

Follow this procedure to store edited sounds in memory.

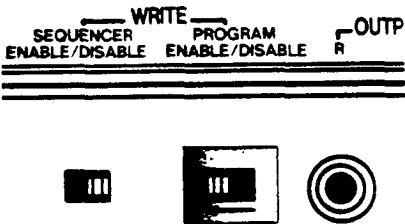
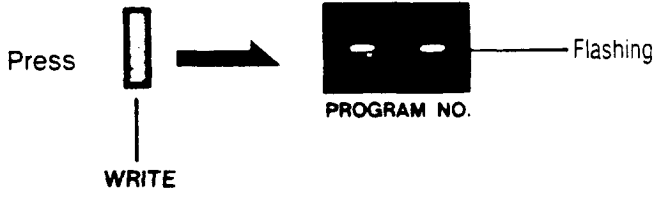
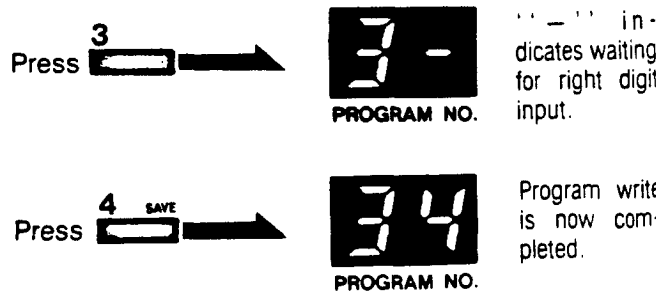
<p>① Create a sound (as described in the previous section of this manual).</p>	
<p>② Set the rear panel PROGRAM WRITE switch to the ENABLE position.</p>	
<p>③ Press the WRITE key on the front panel. The PROGRAM NO. display will start flashing.</p>	
<p>④ Use the NUMBER keys (1-8) to select a 2-digit number under which to store your sound. When you input the second (right) digit of the number, the previous data stored under that program number is erased and replaced by the new sound data that you have created.</p> <p>★ The previous contents of a program number are not erased until you specify the right digit of the number. If you make a mistake in the left digit (and have not yet selected the right digit) then you can start over by pressing the WRITE key again. Or you can cancel the procedure by returning the rear panel PROGRAM WRITE switch to the DISABLE position.</p>	<p>Example: Storing your sound under program number 34.</p>  <p>... indicates waiting for right digit input.</p> <p>Program write is now completed.</p>

CREATING SOUNDS

- ⑤ Return the PROGRAM WRITE switch to the DISABLE position.

★ Always return the rear panel PROGRAM WRITE switch to the DISABLE position after completing this procedure. This protects against accidental overwriting (erasure) of memory contents as can happen if you unintentionally press the WRITE key.

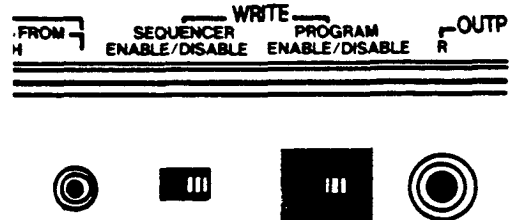

Note:

Values of parameters 11 ~ 84 can be stored in programmer memory.
Values of parameter numbers 85 and 86 (SEQ) and 87 and 88 (MIDI) can not be stored in programmer memory.

② Program transfer and editing

- Settings stored under one program number can be transferred to a different program number. This capability lets you rearrange your settings in the other in which you intend to use them when performing.
Follow this procedure to transfer settings.

- ① Set the rear panel WRITE switch to the ENABLE position.

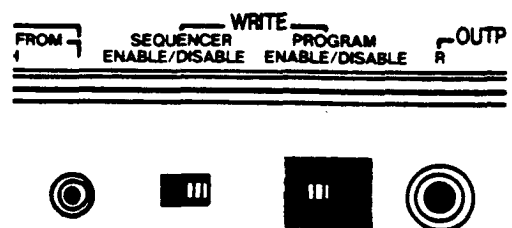

- ② Use the number keys to select the program number of the sound that you want to transfer.

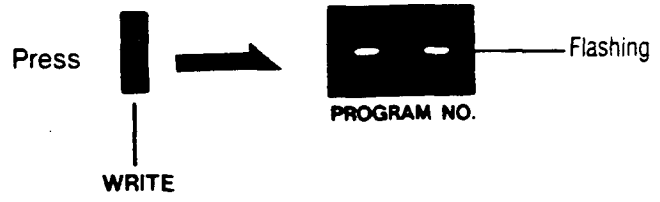
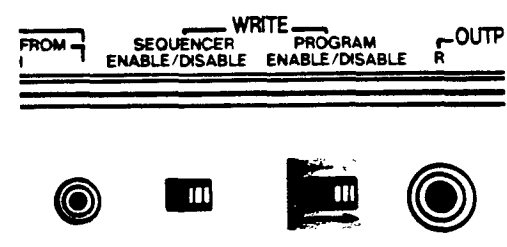
<p>3 Press the front panel WRITE key. The program number selected in the previous step will flash.</p>	 <p>Press WRITE → PROGRAM NO. Flashing</p>
<p>4 Press the number keys to select the program number under which you wish to store the sound. When a number has been specified, the sound will be stored under it. (At the same time, any previous sound stored under that number will be erased.)</p> <p>★ If you want to transfer to a number which contains desired sound, first transfer the destination number's current sound to yet another number.</p>	
<p>5 Repeat steps ② ~ ④ above to rearrange your programs.</p>	
<p>6 When transfer and editing are complete, return the rear panel WRITE switch to the DISABLE position.</p>	 <p>FROM SEQUENCER WRITE PROGRAM OUTP ENABLE/DISABLE ENABLE/DISABLE R</p>

USING THE SEQUENCER

1. Sequencer Operation

- This built-in polyphonic sequencer automatically plays music according to your instructions. Sequences of up to 1000 notes are possible. There is already a sample sequence stored in memory. First let's learn how to reproduce this data. Follow the instructions as illustrated here.

<p>① Check to be sure that the rear panel SEQUENCER WRITE switch is set to the DISABLE position.</p> <ul style="list-style-type: none"> ★ If you operate the sequencer when the switch is at the ENABLE position then all of the data will be erased. (ENABLE is the position used to write new data.) Confirm that the switch is at DISABLE before playing back stored data. ★ The "poly" key assign mode must be selected when using the sequencer. Confirm that the parameter number indicator shows "P". 	<p>OM SEQUENCER WRITE ENABLE/DISABLE ENABLE/D</p> <p>PARAMETER NO. "P" indication</p>
<p>② Press the START/STOP key on the front panel. This starts playback of the stored sequence. Adjust the SPEED slider to obtain the desired playback speed.</p>	<p>Press START/STOP</p> <p>Playback begins</p> <p>FAST SLOW SPEED</p> <p>Adjust playback speed</p>
<p>③ To stop playback, press the START/STOP key again.</p> <ul style="list-style-type: none"> ★ Playback stops automatically at the end of the data if in the ONE TIME mode (parameter 85 MODE value of "1"). (See section on sequencer parameters.) 	<p>During playback Press START/STOP</p> <p>Playback terminates</p>

2. Sequencer Parameters

SEO		ONE TIME	REPEAT
85	MODE	1	2
86	CLK	INT	EXT
		1	2

These parameters control how the sequencer operates. The procedures for calling these parameters and changing values are the same as for any other parameters.

★ The current values of these parameters are retained when power is turned off and on. However, they can not be stored in programmer memory.



MODE

You can opt to have the sequencer play back the entire data once and then stop (value "1"), or play back the entire data repeatedly (value "2").

VALUE	Sequencer mode
1	ONE TIME (Play data through once and stop.)
2	REPEAT (Play data through repeatedly.)



CLK (Clock)

Determines whether playback (speed and start/stop) will be controlled internally (value "1") or by external clock and control signals received through MIDI (value "2").

(See section on synchronized play with other sequencers.)

VALUE	Clock
1	INT (Internal)
2	EXT (External, through MIDI)

Note:

When the CLK parameter value is "2" (EXT), then the POLY-800II's START/STOP key does not have any effect on sequencer operation.

3. Writing Sequences

■ This sequencer uses a procedure called "step write" to put music data into memory. This means that you decide the smallest note (or rest) length that will be needed and call that a "step". To write notes longer than a single step, you extend the length by pressing the STEP key (sort of like using a tie to link short notes). To write rests, you press the STEP key the number of times that adds up to the desired length of the rest. Sequences are written by repeating this kind of procedure.

■ Play the desired note(s) on the keyboard. It does not matter how long you hold down the keys. A step is written when you release the keys. To write notes longer than a single step, keep the keyboard keys depressed and press the step key for the number of "ties" that you will need. Then release the keyboard keys. Chords and intervals are played in the same way.

Note:

To write a series of single notes you must be sure to completely release each key before depressing the next key. Whenever more than one key is depressed, the notes are interpreted as a chord. Therefore, you should not play legato style while programming the sequencer.

■ Rests are inserted by pressing the STEP key without depressing any keys on the keyboard. Press the step key once to write a rest that is the length of one step. For rests that are longer than one step, press again to extend the rest another step, and so on, until you achieve the desired length.

■ If you make a mistake, press the START/STOP key to back up as far as necessary. (Take your fingers off the keys when you do this.) Each press of the START/STOP key takes you back one step (and deletes the previous data at that step). Then input the correct data from the point where the mistake occurred.

Example:

Conceptualization of this rhythmic phrase: ♩ , ♪ ♪ ♪ ♪ ,

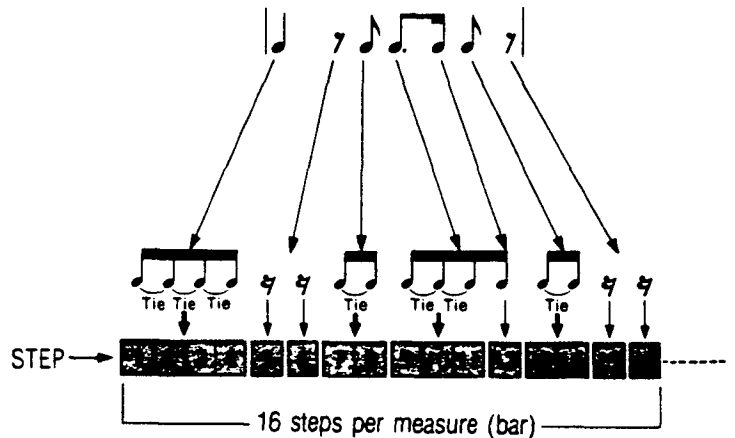

Example: Assuming that the shortest note (or rest) is a 16th note, here is how to input a quarter note "C".

① Play "C" on the keyboard.



Play "C"

② Keep "C" depressed and at the same time press the STEP key three times.



③ Release "C".

Example: Assuming that the shortest note (or rest) is a 16th note, here is how to input a quarter rest.

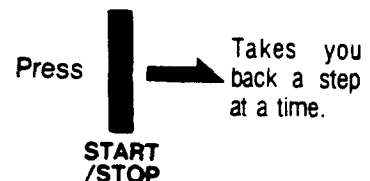
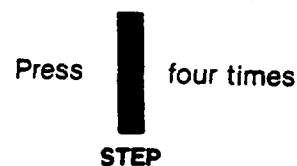

- Chords of up to eight notes can be written into the sequencer if the currently selected program is in the WHOLE mode. (In the DOUBLE mode, chords of up to four notes can be written.)
If you write chords of more than four notes in the WHOLE mode and play back the sequence using a program in the DOUBLE mode, then only four of the notes will be reproduced.
- Now let's try writing a sample sequence.
Here is a short musical phrase which we will put into the sequencer.

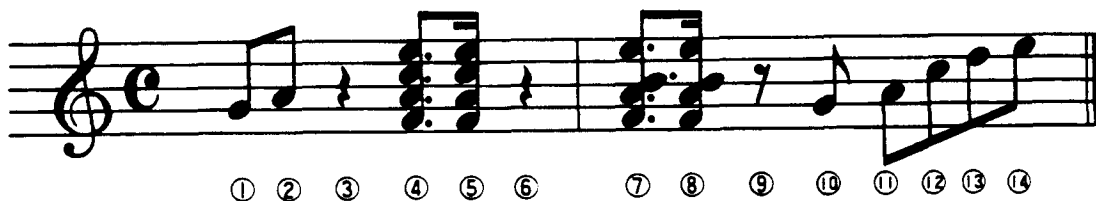







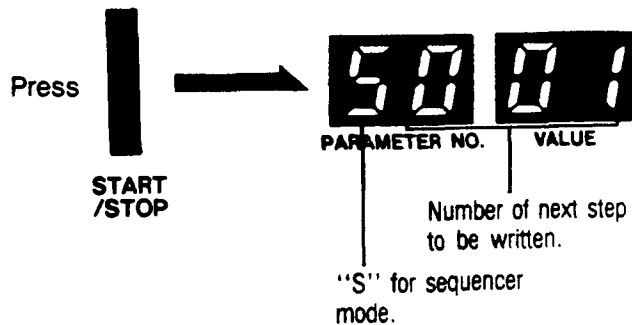
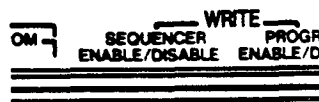











The smallest time value is a 16th note, so all notes and rests will be based on steps of that value.

★ Prepare to write:
Set the rear panel SEQUENCER WRITE switch to the ENABLE position.



Press the START/STOP key. Previous sequencer data is now all erased. You can now begin writing in new data.
The PARAMETER NO. and VALUE displays show the next step number which can be written.



USING THE SEQUENCER

<p>① Play "G", hold it, press the STEP key once, and release the note.</p> <p>The display should show 003.</p>	<p>Play and hold  Press  once and release note</p> <p>STEP</p> <p></p> <p>PARAMETER NO. VALUE</p>
<p>② Play "A", hold it, press the STEP key once, and release the note.</p> <p>The display should show 005.</p>	<p>Play and hold  Press  once and release note</p> <p>STEP</p> <p></p> <p>PARAMETER NO. VALUE</p>
<p>③ To insert a quarter rest, press the STEP key four times (without playing any notes).</p> <p>The display should show 009.</p>	<p>Press  four times. </p> <p>STEP</p> <p></p> <p>PARAMETER NO. VALUE</p>
<p>④ While holding down an "F, A, C, E" chord, press the STEP key twice and then release the notes.</p> <p>The display should show 012.</p>	<p>Play and hold  Press  twice and release note</p> <p>STEP</p> <p></p> <p>PARAMETER NO. VALUE</p>
<p>⑤ Play the same chord again and release it.</p> <p>The display should show 013.</p>	<p>Play and release  </p> <p></p> <p>PARAMETER NO. VALUE</p>
<p>⑥ Quarter note rest. Press the STEP key four times.</p> <p>The display should show 017.</p>	<p>Press  four times </p> <p>STEP</p> <p></p> <p>PARAMETER NO. VALUE</p>

1 While holding down an "F, A, B, E" chord, press the STEP key twice and then release the notes.

Play and hold  Press  twice and release note

STEP



PARAMETER NO. VALUE

The display should show 020.

2 Play the same chord again and release it.

Play and release  →



PARAMETER NO. VALUE

The display should show 021.

3 Insert an 8th rest by pressing the STEP key twice.

Press  twice →





PARAMETER NO. VALUE

STEP

The display should show 023.

4 Play "G", press the STEP key once, then release the note.

Play and hold  Press  once and release note



STEP



PARAMETER NO. VALUE

The display should show 025.

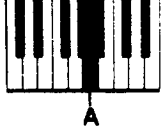
5 Play "A", press the STEP key once, then release the note.

Play and hold  Press  once and release note



STEP



PARAMETER NO. VALUE

The display should show 027.

6 Play "C", press the STEP key once, then release the note.

Play and hold  Press  once and release note

STEP



PARAMETER NO. VALUE

The display should show 029.

USING THE SEQUENCER

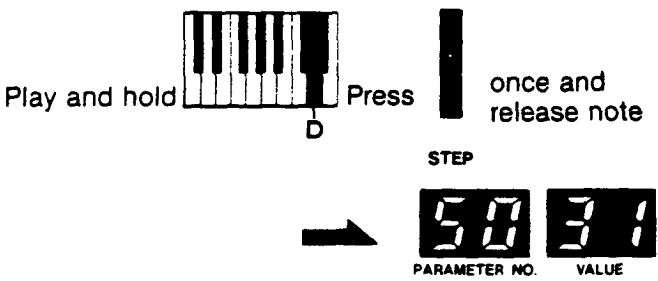
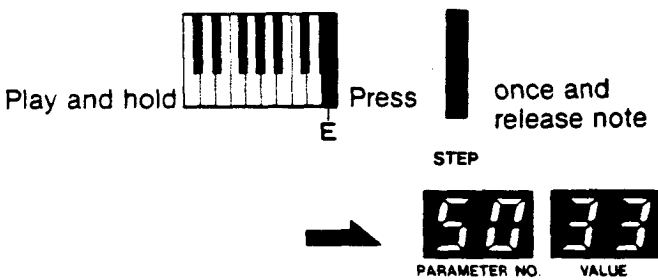
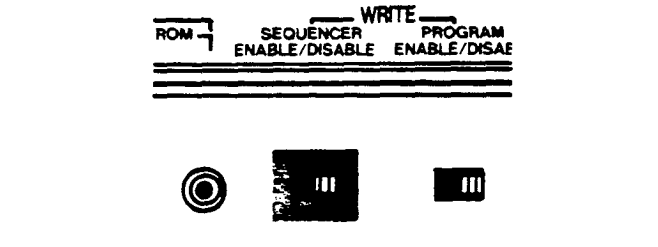
<p>⑬ Play "D", press the STEP key once, then release the note.</p> <p>The display should show 031.</p>	
<p>⑭ Play "E", press the STEP key once, then release the note.</p> <p>The display should show 033.</p>	
<p>★ The phrase has now been written into sequencer memory. Return the rear panel SEQUENCER WRITE switch to the DISABLE position. The display returns to normal and you can now play back the stored sequencer data.</p>	

- If you write only single notes then up to 1000 steps can be stored. However, chords take up more memory so the number of available steps decreases.

When all memory has been used up, the display will automatically cease to show the step number and instead return to non-sequencer indication.

However, the sequencer remains in the "write mode" as long as the rear panel SEQUENCER WRITE switch is at the ENABLE position.

To protect your data, be sure to return the SEQUENCER WRITE switch to the DISABLE position before pressing the START/STOP key.



Amount to

£90

.....

.....

..... Long initial consultation.....

professional services

that his fees for

..... Mrs Clare Eoen.....

and begs to inform

presents his compliments

Dr. M. W. J. Carney

3rd April 1990

HILL HOUSE,
MOUNT PARK ROAD,
HARROW ON THE HILL,
MIDDLESEX,
HA1 3JY

TAPE INTERFACE



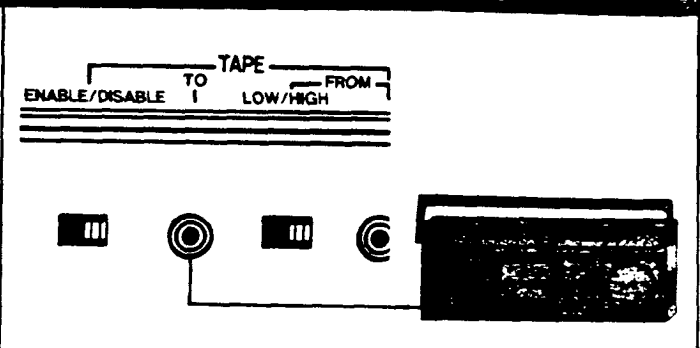
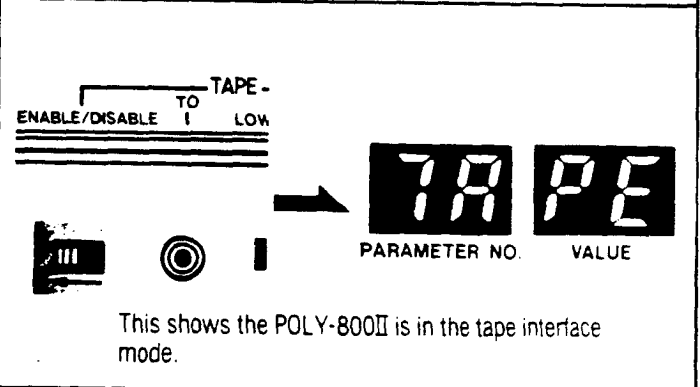

The POLY-800II is equipped with a tape interface that lets you SAVE all sound data and sequencer data stored in memory on cassette tape. Later you can LOAD the data from the tape back into the POLY-800II's internal memory. A wide variety of sound and sequencer data can be stored on cassette tape.

1. Saving Program Data on Tape

Follow the procedures below to write POLY-800II program memory contents to your connected tape recorder.

<p>① Connect the POLY-800II rear panel TO TAPE jack to the microphone (mic) input jack on the tape recorder. You may need a plug adaptor or special connection cord if the input jack is not the usual "mini jack" size.</p>	
<p>② Set the POLY-800II rear panel TAPE switch to the ENABLE position.</p>	 <p>This shows the POLY-800II is in the tape interface mode.</p>
<p>③ Prepare the tape recorder for recording. Begin recording and let the tape advance until it is past the leader tape (at the beginning of the cassette).</p>	
<p>④ Press the recorder's pause key at the point from which you will begin recording data. At this point, the POLY-800II is sending out a test tone as a reference for setting recording level (input level) on the tape recorder. Adjust the tape recorder's recording level as you would normally (refer to tape recorder's instruction manual).</p>	
<p>⑤ After setting recording level, release the pause key so that the recorder begins recording.</p>	

TAPE INTERFACE

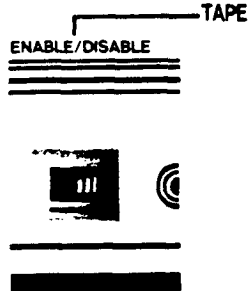
<p>⑥ Press the SAVE key on the POLY-800II will start sending data.</p> <p>(You can cancel the SAVE procedure by pressing the CANCEL key.)</p>	<p>Press  →</p> <div style="display: flex; justify-content: space-around; align-items: center;"> <div style="text-align: center;">  PARAMETER NO. </div> <div style="text-align: center;">  VALUE </div> </div> <p>The DISPLAY will show "SAVE" to confirm the SAVE mode.</p>
<p>⑦ When the DISPLAY again shows TAPE, the you can stop the tape recorder.</p> <p>This completes the SAVE procedure. However, it is good practice to repeat the SAVE procedure several times, as a hedge against the possibility of losing data because of tape dropouts.</p>	<div style="display: flex; justify-content: space-around; align-items: center;"> <div style="text-align: center;">  PARAMETER NO. </div> <div style="text-align: center;">  VALUE </div> </div>
<p>⑧ Reset the POLY-800II rear panel TAPE switch to the DISABLE position.</p>	
<p>⑨ Follow the VERIFY procedure to check if the data from POLY-800II has precisely recorded on tape or not.</p>	

■ If you listen to a tape of recorded data, you will hear the following tones:

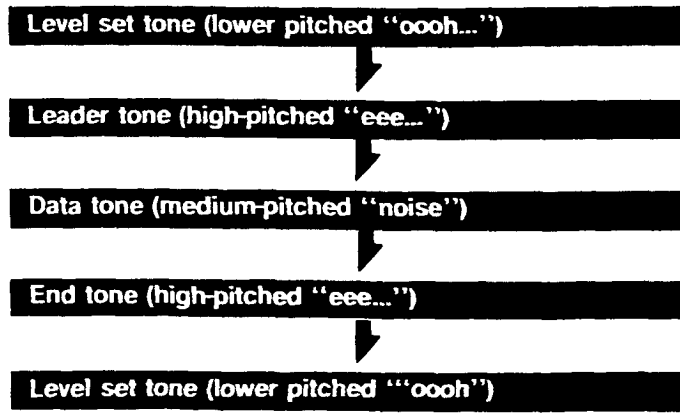



- Leader tone:** Indicates the start of VERIFY and LOAD operations.
- Data tone:** The actual digital data from POLY-800II program memory.
- End tone:** Indicates the end of the operation.

2. VERIFY Procedure

■ The VERIFY procedure should always be used immediately after you finish a SAVE (or LOAD) operation. This is to make sure that data has been properly recorded. It is also useful for determining the best playback level setting for your recorder.

<p>① Connect the POLY-800II rear panel FROM TAPE jack to the output jack (earphone, line out, etc.) of your recorder. Set the LOW/HIGH switch to match your tape recorder's output signal level.</p>	<table border="1" data-bbox="1021 660 1484 795"> <tr> <td>Recorder output jack</td> <td>LOW/HIGH</td> </tr> <tr> <td>AUX. (line out)</td> <td>LOW</td> </tr> <tr> <td>Earphone or headphone output</td> <td>HIGH</td> </tr> </table>	Recorder output jack	LOW/HIGH	AUX. (line out)	LOW	Earphone or headphone output	HIGH
Recorder output jack	LOW/HIGH						
AUX. (line out)	LOW						
Earphone or headphone output	HIGH						
<p>② Set the POLY-800II rear panel TAPE switch to the ENABLE position.</p>	<p>ENABLE/DISABLE TAPE</p> <p>This shows the POLY-800II is in the tape interface mode.</p> <p>PARAMETER NO. VALUE</p> <p>7A PE</p>						
<p>③ Set the tape recorder's playback volume a bit higher than usual. If the recorder has tone controls, set them to the center positions.</p>							
<p>④ Rewind the tape. Begin tape playback. Stop the tape (using the stop or pause key) when you reach the beginning of the leader tone.</p>							
<p>⑤ Press the VERIFY key on the POLY-800II (You can cancel the VERIFY procedure by pressing the CANCEL key.)</p>	<p>Press 7 VERIFY</p> <p>PARAMETER NO. VALUE</p> <p>7r FY</p> <p>The DISPLAY will show "VrFY" to confirm the VERIFY mode.</p>						
<p>⑥ Start the tape recorder (press the play key or release the pause key).</p>							

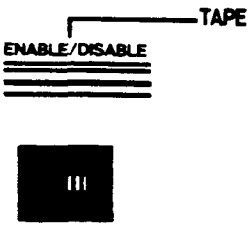

TAPE INTERFACE

<p>⑦ If the recorded data matches the POLY-800II internal memory data then the DISPLAY will give a "Good" indication. The DISPLAY will appear as shown here if data is successfully verified.</p>	 <p>PARAMETER NO. VALUE</p> <p>The "Good" display indicated the completion of verify.</p>
<ul style="list-style-type: none"> ● If you get an error (Err) message as shown here: Press the CANCEL Key, lower (or raise) the tape recorder's output volume, and repeat steps ④-⑥. ● If the DISPLAY does not change after ten seconds of tape playback: Raise the tape recorder's output volume level and repeat steps ④-⑥. 	 <p>PARAMETER NO. VALUE</p>  <p>PARAMETER NO. VALUE</p>
<p>⑧ When you get a "Good" message, you can stop the tape recorder. Make a note of the recording level, playback level, and HIGH/LOW switch setting that resulted in the "Good" message.</p>	
<p>⑨ Set the POLY-800II rear panel TAPE switch to the DISABLE position.</p>	





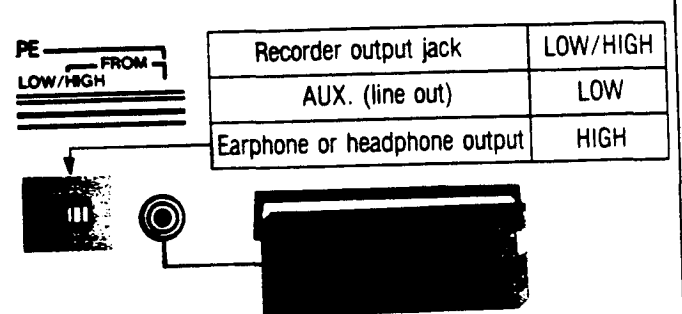
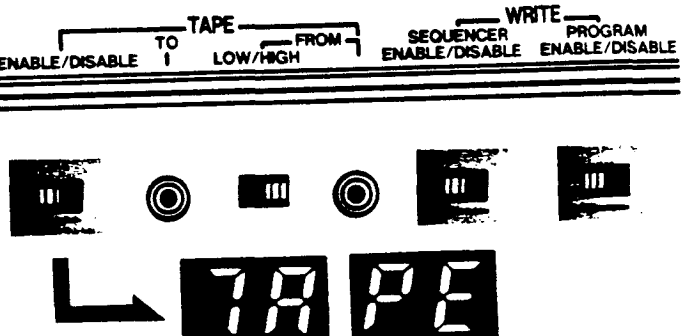





Note: You will not get a "Good" message if the recorded data is different in any way from the data in the POLY-800II's internal memory. If you change a single parameter value or the key assign mode and then try VERIFY, you will get an error "Err" message. If you still don't get a "Good" message after trying many different output level settings on the tape recorder (and HIGH/LOW switch settings on the POLY-800II) then your recording level may be wrong. Try saving again at a different recording level.

3. Load Procedure

■ This procedure is used to put recorded data back into the POLY-800II's internal memory.

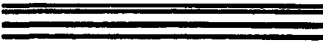
Key Operations and Display Readouts							
<p>① Connect the POLY-800II rear panel FROM TAPE jack to the output jack (earphone, line out, etc.) of your recorder. Set the LOW/HIGH switch to match your tape recorder's output signal level.</p>	 <table border="1" data-bbox="1006 582 1494 739"> <tr> <td>Recorder output jack</td> <td>LOW/HIGH</td> </tr> <tr> <td>AUX. (line out)</td> <td>LOW</td> </tr> <tr> <td>Earphone or headphone output</td> <td>HIGH</td> </tr> </table>	Recorder output jack	LOW/HIGH	AUX. (line out)	LOW	Earphone or headphone output	HIGH
Recorder output jack	LOW/HIGH						
AUX. (line out)	LOW						
Earphone or headphone output	HIGH						
<p>② Set the POLY-800II rear panel PROGRAM WRITE switch, SEQUENCER WRITE switch and TAPE switch to the ENABLE positions.</p>	 <p>PARAMETER NO. VALUE This shows the POLY-800II is in the tape interface mode.</p>						
<p>③ Set the tape recorder's playback volume to the level that produced a "Good" indication when you use the VERIFY procedure. If the recorder has tone controls, set them to the center positions.</p>							
<p>④ Rewind the tape. Begin tape playback. Stop the tape (using the stop or pause key) when you reach the beginning of the leader tone.</p>							
<p>⑤ Press the LOAD key</p> <p>(You can cancel the LOAD procedure by pressing the CANCEL key.)</p>	 <p>Press  →</p> <p>PARAMETER NO. VALUE</p> <p>The DISPLAY will show "LoAd" to confirm the LOAD mode.</p>						

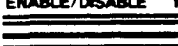
TAPE INTERFACE

<p>⑥ Start tape playback (press the play key or release the pause key).</p>	
<p>⑦ If the data has successfully loaded into internal memory the DISPLAY will give a "Good" indication.</p>	<div style="display: flex; justify-content: space-around; align-items: center;"> <div style="text-align: center;">  <p>PARAMETER NO.</p> </div> <div style="text-align: center;">  <p>VALUE</p> </div> </div> <p>The "Good" display indicates the completion of loading.</p>
<ul style="list-style-type: none"> ● If you get an error (Err) message as shown here Press the CANCEL Key, lower (or raise) the tape recorder's output volume, and repeat steps ④-⑥. ● If the DISPLAY does not change after ten seconds of tape playback Raise the tape recorder's output volume level and repeat steps ④-⑥. 	<div style="display: flex; justify-content: space-around; align-items: center;"> <div style="text-align: center;">  <p>PARAMETER NO.</p> </div> <div style="text-align: center;">  <p>VALUE</p> </div> <div style="text-align: center;"> <p>Press </p> </div> </div> <div style="display: flex; justify-content: space-around; align-items: center; margin-top: 20px;"> <div style="text-align: center;">  <p>PARAMETER NO.</p> </div> <div style="text-align: center;">  <p>VALUE</p> </div> </div>
<p>⑧ When you get a "Good" message, you can stop the tape recorder.</p>	
<p>⑨ Set the POLY-800II rear panel PROGRAM WRITE switch and SEQUENCER WRITE switch to the DISABLE position.</p>	<div style="display: flex; justify-content: space-between; align-items: center;"> <div style="text-align: center;"> <p>WRITE</p> <p>SEQUENCER PROGRAM ENABLE/DISABLE ENABLE/DISABLE</p>  </div> <div style="text-align: center;">  </div> <div style="text-align: center;">  </div> </div> <p>Follow the VERIFY procedure to check if the data from the tape has precisely loaded into the programmer or not.</p>
<p>⑩ Set the POLY-800II rear panel TAPE switch to the DISABLE position.</p>	<div style="text-align: center;"> <p>TAPE</p> <p>TC</p> <p>ENABLE/DISABLE</p>  </div> <div style="display: flex; justify-content: center; align-items: center; margin-top: 20px;">   </div>

4. Tape Interface Precautions

- 1 After a SAVE, LOAD, or VERIFY operation, reset the rear panel TAPE switch to DISABLE. If it remains set to ENABLE, the POLY-800II cannot be played.
- 2 If the tape recorder head is dirty, wow and flutter are excessive, or there are fluctuations in output (due to weak batteries, etc.), SAVE, LOAD, or VERIFY operations may not be correctly completed.
- 3 When using a stereophonic tape recorder, use the left channel only for the SAVE operation. Otherwise, VERIFY and LOAD operations may not be done.
- 4 Do not vibrate the tape recorder by moving it or change the output level settings during SAVE, LOAD, or VERIFY operation. Otherwise, incorrect operation may result.
- 5 VERIFY and LOAD procedures requires signal levels within the allowable range shown here.

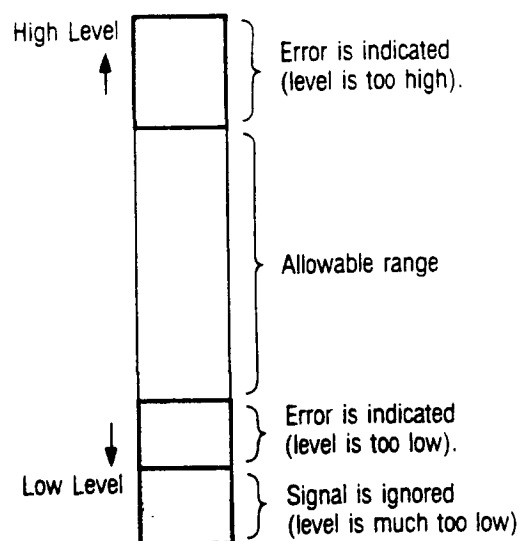

MIDI

MIDI (which stands for "Musical Instrument Digital Interface") is a "universal language" adopted by most musical instrument manufacturers which allows MIDI equipped instruments to communicate and control each other. The DW-8000 is MIDI equipped, so it can be connected to other MIDI equipped synthesizers, sequencers, rhythm machines, and personal computers.

1. How MIDI Works

1 The MIDI Control System

In the early days of electronic music, it was possible to "interface" (ie, interconnect) older monophonic synthesizers together by using two simple voltage signals. One was a CV (control voltage) signal that determined pitch. The other was a trigger signal that started and stopped each note.

But such techniques are too cumbersome and unreliable for today's computerized polyphonic synthesizers. So the MIDI format was developed. In contrast to the older CV/Gate voltage signals, MIDI uses 8-bit digital words transmitted serially from instrument to instrument to communicate pitch, note on/off, and all kinds of information.

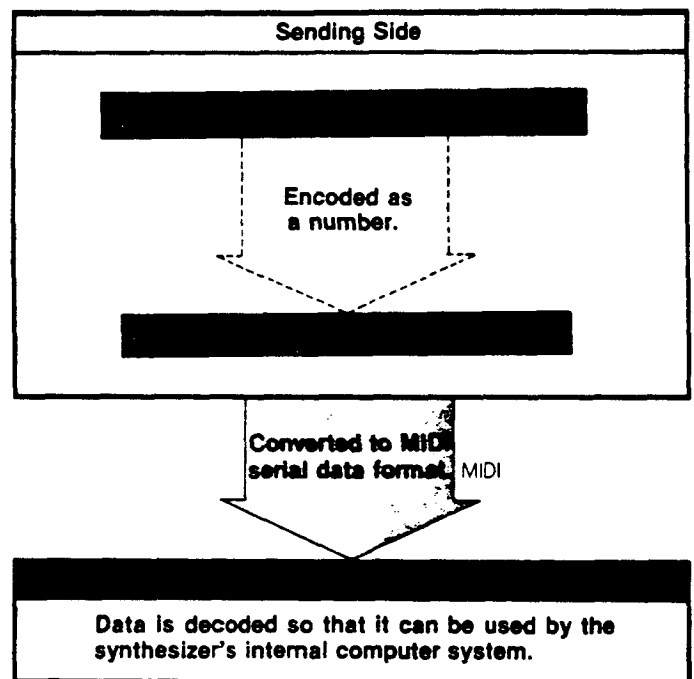

2 MIDI Channels

- One "master" sequencer, synthesizer or computer can control many "slave" synthesizers through MIDI. Up to 16 channels (numbered 1 - 16) can be used so that individual synthesizers can be addressed. The controlling sequencer can be set to send on particular channels called the "send channels." The receiving synthesizer can also be assigned a channel called the "receive channel." It is then possible to have each receiving synthesizer respond only to data sent on its particular "receive channel" while ignoring data sent on other channels.

■ For example, if synthesizer A sends a message on channel 1, then messages will not be received by synthesizer B unless its receive channel is number 1. With a sequencer that can send on several channels at once, it is necessary to assign send and receive channel numbers appropriate to the parts that the connected synths are supposed to play.

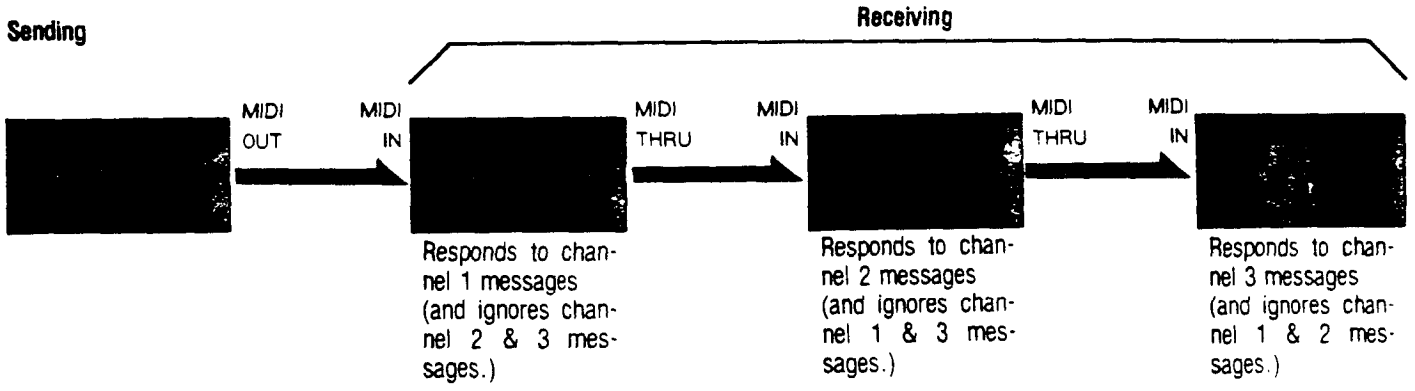
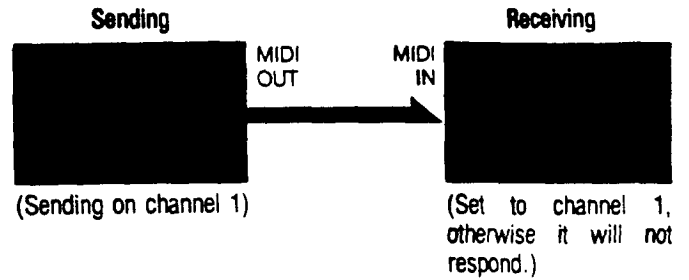

★ Each synth performs a different part, according to data received on its particular channel.

MIDI

3 Kinds of MIDI Data.

MIDI can be used to many kinds of messages that contain instructions and information to be used by the receiving synthesizer and/or rhythm machines. The main kinds of MIDI data are described below.

1. CHANNEL VOICE MESSAGES

These tell the receiving synthesizer(s) which sounds to use, which notes to play, and when to start and stop playing those notes. They may also include instructions to use portamento, modulation, and other effects.

A NOTE ON EVENT

This tells the receiving synth to start playing a note (equivalent to depressing a key on the keyboard).

D PROGRAM CHANGES

This is used to select the sound program number to be used. Therefore, the receiving synth(s) can be made to change its sound by remote control.

B NOTE OFF EVENT

This tells the receiving synth to stop playing a note (equivalent to releasing the key on the keyboard).

E CHANNEL PRESSURE (AFTER TOUCH)

This message indicates the operation of After Touch (a function to add effects such as pitch modulation by pressing harder after playing the key on the keyboard).

C CONTROL CHANGES

This can be used to control pitch modulation, sustain (damper), portamento, and other effects.

F PITCH BENDER CHANGES

This is used to control pitch bend effect.

NOTE ON and NOTE OFF EVENT above also include the following information.

NOTE NUMBER

Every note has a number (representing the key on a keyboard). This number tells the receiving synth which note to play.

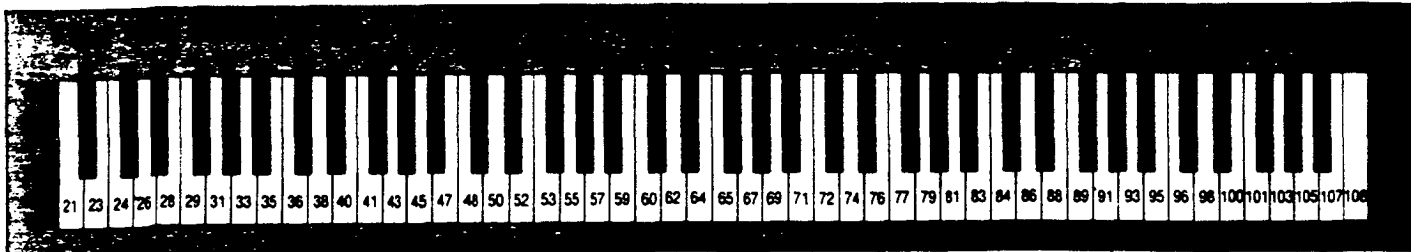

VELOCITY

This determines how loud the note is played. (Not all synths can send or receive this data; however, no problems are created by mixing velocity and non-velocity sensitive keyboards.) The relationship between velocity value and "volume" is shown in the chart here.



2. CHANNEL MODE MESSAGES

These determine the channel mode used for communications.

A OMNI MODE ON, OMNI MODE OFF

When Omni mode is set to ON, the receiving synths will respond to all messages regardless of which channel they are sent on. When Omni mode is OFF, a synth will respond only to messages sent on its particular specified channel. If you turn off Omni mode, then be sure that the sending synth is set to the same channel number as the receiving synth.

Note: POLY-800II is set to the OMNI ON mode when powered ON.

B POLY MODE ON, MONO MODE ON

This determines whether NOTE ON/NOTE OFF will be handled as polyphonic (chords) or monophonic (one note played at a time). In the poly mode, the receiving synth will, of course, be limited by the number of voices that it has. In the mono mode, only one note will be played at a time, even if multiple note data is received.

C ALL NOTES OFF

This message stops all notes currently being voiced. ("All notes off" capability is possessed by OMNI MODE ON, OMNI MODE OFF, POLY MODE ON, and MONO MODE ON messages.)

3. SYSTEM REAL TIME MESSAGES

Used for synchronizing rhythm machines and sequencers.

Includes timing clock and start/stop data.

4. SYSTEM COMMON MESSAGES

Used when there are many MIDI units, including rhythm machines and sequencers, in a complex system. These messages include "song select" to specify song to be played and "song position pointer" to tell the units to start at the same time.

5. SYSTEM EXCLUSIVE MESSAGES

Can be used for passing data pertaining to one manufacturer's products (since each manufacturer has his own particular ID number). Usually used for program SAVE/LOAD and parameter-change operations.

2. POLY-800II MIDI Features

1 Transmitted/Received Messages

■ The POLY-800II can send and receive the following MIDI data.

<ul style="list-style-type: none"> ■ Note OFF (velocity fixed) ■ Note ON (velocity fixed) ■ Control Change <ul style="list-style-type: none"> No.1 DCO modulation No.2 VCF modulation ■ Program Change ■ Pitch Bender Change ■ Timing Clock ■ Start ■ Stop ■ System Exclusive Message 	<ul style="list-style-type: none"> ■ Note OFF (velocity ignored) ■ Note ON (velocity ignored) ■ Control Change <ul style="list-style-type: none"> No.1 DCO modulation No.2 VCF modulation ■ Program Change ■ Pitch Bender Change ■ Omni Mode OFF ■ Omni Mode ON ■ Timing Clock ■ Start ■ Stop ■ System Exclusive Message
---	--

★ Note ON/Note OFF note number range is 36-84.

2 Parameter for MIDI

MIDI			
87	CHANNEL	1	-- 16
88	PROG CHANGE	0	1

Parameters for MIDI are shown to the left. Follow the procedures described in "Value Editing" to specify them. These parameters cannot be stored in individual programs, but can be "stored" as overall performance parameters.

87

CHANNEL

This parameter is used to select a channel for data send and receive. The same channel must be specified for sending and receiving data. (Different channels cannot be selected independently for send and receive.) At power ON, the data send/receive channel is set for that previously selected.

When the POLY-800II power switch is turned on, the OMNI ON mode is selected automatically so the synthesizer receives data on all channels. However, OMNI is turned OFF if and when you "call" this parameter. From that moment on, the synthesizer will only receive on the selected channel. To switch back to OMNI ON, and OMNI Mode ON message must be received from the controlling synthesizer, or you can turn the power off and then on again.

Value	Send/Receive channel
1	ch 1
↑	↑
16	ch 16

Note:

POLY-800II sequencer data is always sent on channel 2. (This can not be changed.)

88

PROGRAM CHANGE

This determines whether the POLY-800II will respond to PROGRAM CHANGE messages received on MIDI. At value "0" the POLY-800II will not change programs even if programs are changed on the connected synth. At value "1" the POLY-800II will change programs whenever the connected synth changes programs. The current value of this parameter is retained when the power is turned off and on.

VALUE	Program change response
0	DISABLE (No external control of program change.)
1	ENABLE (External control of program change.)

2 MIDI connections

■ Turn off the power on all units before making or changing connections. This will help avoid unpredictable effects.

① Using the POLY-800II to control another synthesizer or sound source unit.

★ Use a MIDI cable to connect the POLY-800II MIDI OUT jack to the other unit's MIDI IN jack. Set the receiving unit's MIDI receive channel to the same number as the POLY-800II's MIDI channel number.

★ However, POLY-800II sequencer data is always sent on MIDI channel 2, regardless of the parameter 87 CHANNEL setting. Therefore, if you are going to use sequencer data to control another synth, then be sure to set the receiving synth's MIDI receive channel to number 2.

② Using a remote keyboard or other unit to control the POLY-800II.

★ Use a MIDI cable to connect the controlling unit's MIDI OUT jack to the POLY 800II's MIDI IN jack. Set the POLY-800II MIDI receive channel to match the MIDI send channel of the controlling unit.

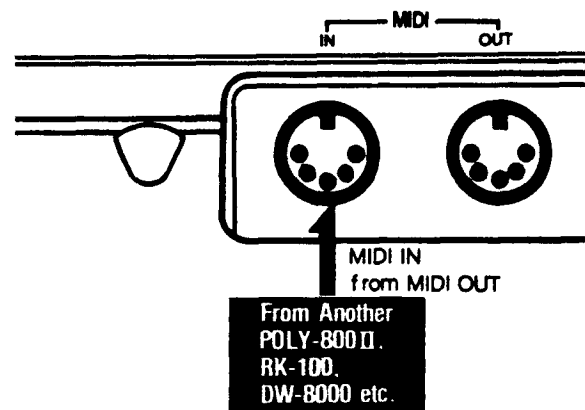
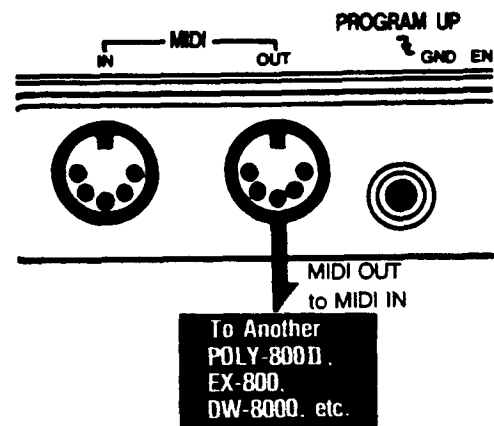

3 Synchronized play with another sequencer.

■ To enable synchronized play, the POLY-800II can be set to respond to start, stop, and timing clock message from a MIDI sequencer or rhythm machine.

① Using the POLY-800II sequencer to control another rhythm machine or sequencer.

★ Connect the POLY-800II MIDI OUT jack to the other unit's MIDI IN jack.

Be sure that the POLY-800II's parameter 86 CLK value is 1 (INT). The connected unit should be set so that it will respond to external clock data and so that it is ready to start playback.

★ Now when you start the POLY-800II sequencer, a "start" message will be sent on MIDI so that the other unit will start at the same instant. Tempo is adjusted by the SPEED slider on the POLY-800II. Likewise, when you stop the POLY-800II, a "stop" message is sent so that the other unit will stop at the same time.

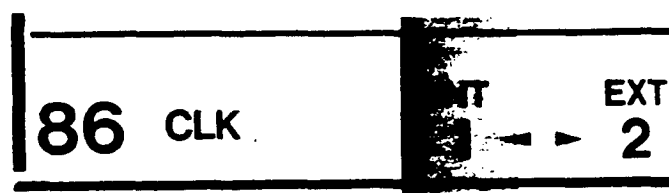

② Using another unit to control the POLY-800II sequencer.

★ Set the POLY-800II's parameter 86 CLK value to 2 (EXT). The connected unit should be set for its internal clock mode (so that it can send timing clock and start/stop messages).

★ Now when you start the connected sequencer, the POLY-800II sequencer will start at the same time. (But it will not start with "continue start" data.)

Tempo is determined by the controlling unit. When you stop sequencer playback on the controlling unit, the POLY-800II will stop at the same time.

★ Start, stop, and tempo control must all be performed on the controlling unit. (The POLY-800II START/STOP key and SPEED slider have no effect.)

■ One "step" on the POLY-800II sequencer is equivalent to a MIDI 16th note (or rest).

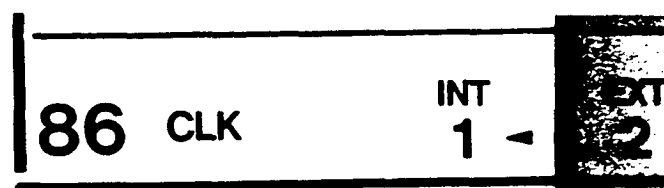

MIDI IMPLEMENTATION

1. Transmitted Data

CHANNEL MESSAGES

1 0 0 0 n n n n	0 k k k k k k k k	0 1 0 0 0 0 0 0	Note Off k k k k k k k k = 36 ~ 84
1 0 0 1 n n n n	0 k k k k k k k k	0 1 0 0 0 0 0 0	Note On k k k k k k k k = 36 ~ 84
1 0 1 1 n n n n	0 0 0 0 0 0 0 1	0 v v v v 0 0 0 0	DCO Modulation (4bit resolution)
1 0 1 1 n n n n	0 0 0 0 0 0 1 0	0 v v v v 0 0 0 0	VCF Modulation (4bit resolution)
1 1 0 0 n n n n	0 p p p p p p p p	—	Program Change p p p p p p p p = 0 ~ 63 (NOTE 1)
1 1 1 0 n n n n	0 0 0 0 0 0 0 0	0 v v v v v v v v	Pitch Bender Change (7bit resolution) v v v v v v v v = 64 : Center LSB is not used

★ nnnn = 0 ~ 15: The channel number set in parameter 87. But sequencer data is fixed at channel 2.

NOTE

1. The relationship between MIDI program numbers (0ppppppp) and display program numbers is shown here.

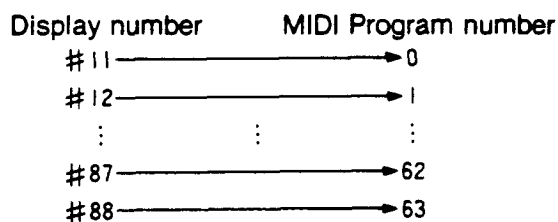

SYSTEM REAL TIME MESSAGES

1 1 1 1 1 0 0 0	Timing Clock (NOTE 2)
1 1 1 1 1 0 1 0	Start (NOTE 2)
1 1 1 1 1 1 0 0	Stop (NOTE 2)

NOTE

2. Sent only during sequencer operation.

3 SYSTEM EXCLUSIVE MESSAGES

① DATA DUMP

<pre> 1 1 1 1 0 0 0 0 0 1 0 0 0 0 1 0 0 0 1 0 0 0 0 1 0 0 0 0 1 1 0 0 0 0 0 0 d d d d 0 0 0 0 d d d d ⋮ 0 0 0 0 s s s s 0 0 0 0 s s s s 1 1 1 1 0 1 1 1 </pre>	<pre> Exclusive Status KORG ID 42H Format ID 21H POLY-800II ID 0CH LSB 4bit } RAM data 1 word MSB 4bit } (5376 Byte) ⋮ LSB 4bit } Check Sum data MSB 4bit } EOX </pre>
--	--

NOTE

DATA DUMP is sent only when a DATA DUMP request is received.
 Also, the $\sum_{n=1}^{256} (\text{RAM data 1 word})_n$ least significant 8 bits are check sum data.

② DATA ERROR

<pre> 1 1 1 1 0 0 0 0 0 1 0 0 0 0 1 0 0 0 1 0 0 0 0 1 0 0 0 0 1 1 0 0 0 0 1 0 0 0 0 0 1 1 1 1 0 1 1 1 </pre>	<pre> Exclusive status KORG ID 42H Format ID 21H POLY-800II ID 0CH Data Error 20H EOX </pre>
--	--

NOTE

Sent only when a check sum error occurs during a data dump.

2. Recognized Receive Data

1 CHANNEL MESSAGES

1 0 0 0 n n n n	0 k k k k k k k k	0 x x x x x x x	Note Off (NOTE 1) Velocity will be ignored
1 0 0 1 n n n n	0 k k k k k k k k	0 v v v v v v v v	Note On (NOTE 1) Velocity will be ignored (v v v v v v v > 0)
1 0 0 1 n n n n 1 0 1 1 n n n n	0 k k k k k k k k 0 0 0 0 0 0 0 1	0 0 0 0 0 0 0 0 0 v v v v x x x x	Note Off DCO Modulation (4 bit resolution)
1 0 1 1 n n n n	0 0 0 0 0 0 1 0	0 v v v v x x x x	VCF Modulation (4 bit resolution)
1 0 1 1 n n n n	0 1 1 1 1 1 0 0 0 1 1 1 1 1 0 1	0 0 0 0 0 0 0 0 0 0 0 0 0 0 0 0	OMNI Mode Off OMNI Mode On
1 1 0 0 n n n n 1 1 1 0 n n n n	0 p p p p p p p p 0 x x x x x x x x	————— 0 v v v v v v v v	Program Change (NOTE 2) Pitch Bender Change LSB will be ignored MSB will be recognized v v v v v v v = 64 : center

★ nnnn = 0 - 15: Channel number set in parameter 87. When OMNI mode is ON, all messages are received, regardless of channel number setting.
When OMNI mode is OFF, the synthesizer responds only to messages received on the currently selected channel number.
The "power on" default is OMNI ON.

NOTE

- Note number (0kkk kkkk) = 36 - 84. Received data beyond this range is voiced as the same note in the nearest octave within the range.
- Program number (0ppp pppp) = 0 - 63. Data higher than 63 is interpreted as the difference obtained by subtracting 64 from the data.

2 SYSTEM REAL TIME MESSAGES

1 1 1 1 1 0 0 0	Timing Clock (NOTE 1)
1 1 1 1 1 0 1 0	Start
1 1 1 1 1 1 0 0	Stop

NOTE

- Timing clock data can be received only in the period between reception of start and stop data.

3 SYSTEM EXCLUSIVE MESSAGES

① DATA DUMP

1 1 1 1 0 0 0 0	Exclusive status
0 1 0 0 0 0 1 0	KORG ID 42 H
0 0 1 0 0 0 0 1	Format ID 21 H
0 0 0 0 1 1 0 0	POLY-800II ID 0CH
0 0 0 0 d d d d	LSB 4bit } RAM data 1 word
0 0 0 0 d d d d	MSB 4bit } (5376 Byte)
⋮	⋮
0 0 0 0 s s s s	LSB 4bit } Check Sum data
0 0 0 0 s s s s	MSB 4bit }
1 1 1 1 0 1 1 1	EOX

NOTE

The $\sum_{n=1}^{2688}$ (RAM data 1 word)_n least significant 8 bits are check sum data.

② DATA DUMP REQUEST

1 1 1 1 0 0 0 0	Exclusive status
0 1 0 0 0 0 1 0	KORG ID 42 H
0 0 1 0 0 0 0 1	Format ID 21 H
0 0 0 0 1 1 0 0	POLY-800II ID 0CH
0 0 0 1 0 0 0 0	Data Dump Request 10 H
1 1 1 1 0 1 1 1	EOX

NOTE

After receiving a DATA DUMP REQUEST, there is a delay of about 300ms before the POLY-800II begins DATA DUMP transmission.

3. Using System Exclusive Messages

1 Communication between the POLY-800II and a computer.

■ The POLY 800II can send and receive the following kinds of information via system exclusive messages. This enables sequencer and other data exchange with a computer equipped with a MIDI interface and suitable software.

Sending

DATA DUMP: This includes the sound data stored in the 64 programs in memory, sequencer data, settings of parameters 85, 86, 87, and 88, and chord memory data. This is sent in response to a DATA DUMP REQUEST.

DUMP ERROR: Sent when a check sum error occurs during reception of DATA DUMP data.

Receiving

DATA DUMP: The program data loaded to the POLY-800II. The contents of this data replace the sound data stored in the 64 programs in memory, sequencer data, settings of parameters 85, 86, 87, and 88, and chord memory data.

DATA DUMP REQUEST: A command to transmit program data. When this request is received, the POLY-800II begins DATA DUMP transmission after a 300ms delay.

■ Setup is shown here:



Communications Examples

① First the computer obtains sound program and sequencer data from the synthesizer for editing. After editing, the data is sent back to the synthesizer.

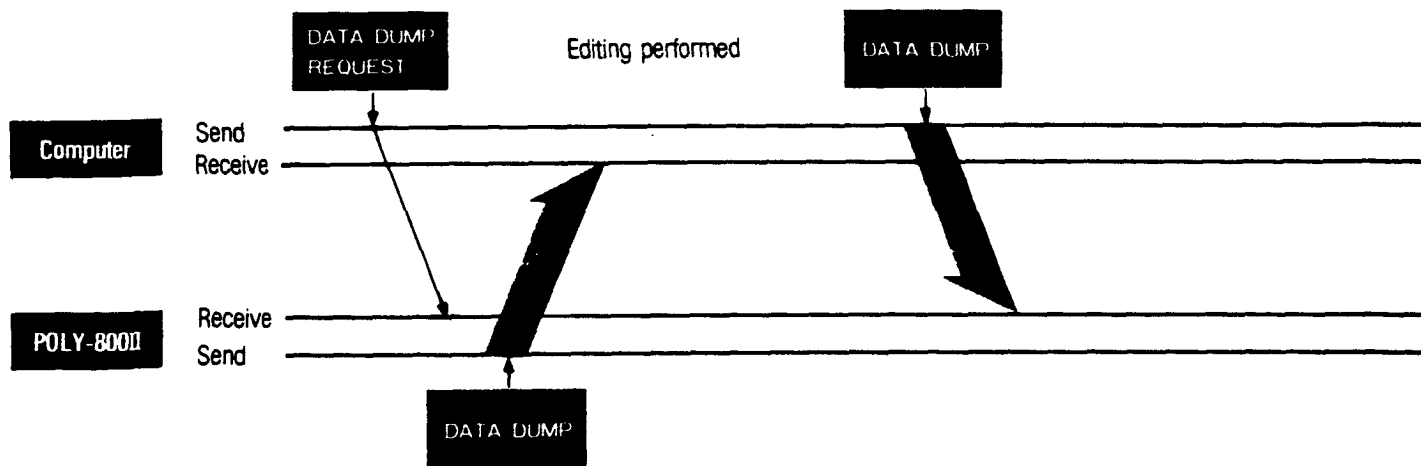

② If an irregularity is detected in the data loaded from the computer.

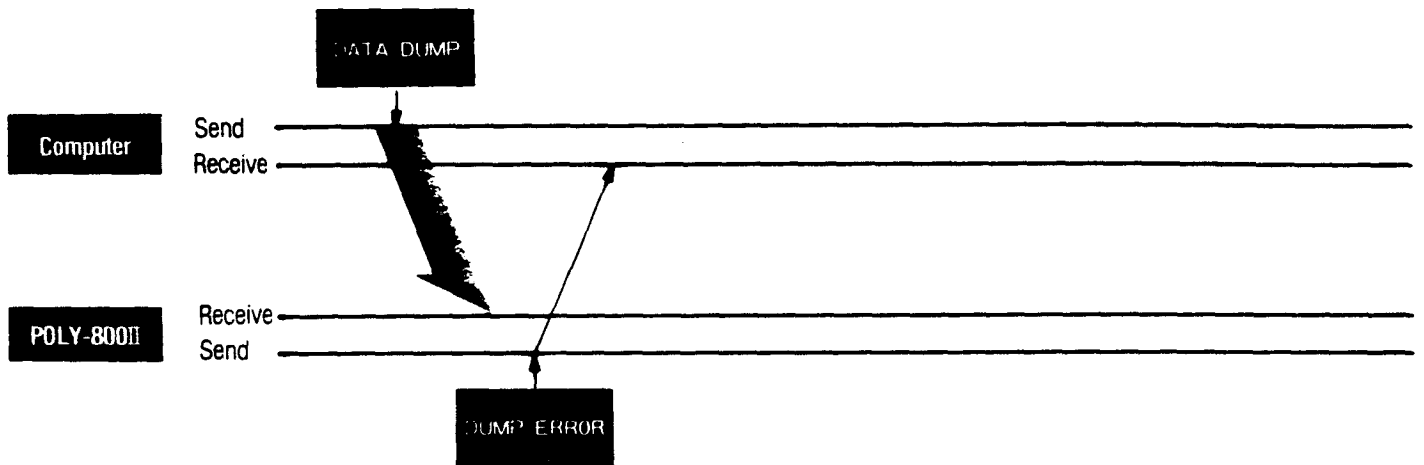

RAM data structure

The RAM data portion of DATA DUMP data is organized as shown here.

		(decimal)
MIDI CHANNEL	0 0 0 H	1
SEQ DATA	0 0 1 H ~ 3 E 8 H	1000
(UNDEFINED)	3 E 9 H ~ 3 F 0 H	8
CHORD MEMORY	3 F 1 H ~ 3 F 8 H	8
SEQ MODE	3 F 9 H	1
SEQ CKL	3 F A H	1
PROG CHANGE DIS/ENA	3 F B H	1
(UNDEFINED)	3 F C H ~ 3 F F H	4
PROG DATA	4 0 0 H ~ A 7 F H	1664

Actually, when this data is transmitted on MIDI, each byte is split at its least significant four bits and sent starting from relative address 000H.
(UNDEFINED data does not affect internal operation; it is only used in the check sum.)

MIDI IMPLEMENTATION

RAM data organization

Bit map for MIDI CHANNEL, SEQ MODE, SEQ CLK, and PROG CHANGE.

	MSB	7	6	5	4	3	2	1	0	LSB
000H		0	0	0	0	← MIDI CHANNEL →				
3F9H		0	0	0	0	0	0	0		← SEQ MODE →
3EAH		0	0	0	0	0	0	0		← SEQ CLK →
3FBH		0	0	0	0	0	0	0		← PROG CHANGE →

★ Bit map relationship with parameter values on front panel.

MIDI CHANNEL	000H	b3-b0	0000-1111 = 1-16	87
SEQ MODE	3F9H	b0	0 = 1 (ONE TIME), 1 = 2 (REPEAT)	85
SEQ CLK	3FAH	b0	0 = 1 (INT), 1 = 2 (EXT)	86
PROG CHANGE D/E	3FBH	b0	0 = 0 (DISABLE), 1 = 1 (ENABLE)	88

Sequencer data has the following structure.

	00H	End
	01H	Rest
	02H	Tie
	k ₁ k ₁ k ₁ k ₁ k ₁ k ₁ k ₁ k ₁ 0 k ₁ k ₁ k ₁ k ₁ k ₁ k ₁ k ₁ k ₁ 0 k ₂ k ₂ k ₂ k ₂ k ₂ k ₂ k ₂ k ₂ k ₃ k ₃ k ₃ k ₃ k ₃ k ₃ k ₃ k ₃	If most significant bit is 0: Other notes exist at same time. If most significant bit is 1: Block end at that point in time. Same as MIDI note number. (24H-54H,) (n = 1-8)

Example:



CHORD MEMORY has the following structure.

0k_nk_nk_nk_nk_nk_nk_nk_n: Same as MIDI note number.

Data: B4H, 02H, B5H, 02H, 01H, 01H, B7H, B9H, 34H, 37H,
 BCH, 02H, 02H, 02H, 02H, 02H, 01H, 01H, 00H.

MIDI IMPLEMENTATION

■ Bit map for each program.

0	← DC02 WAVEFORM →	← DC01 WAVEFORM →	← DC02 OCTAVE →	← DC01 OCTAVE →
1	← DC02 16' ~ 2' →		← DC01 16' ~ 2' →	
2	UNDEFINED	← DC0 MODE →	UNDEFINED	← DC0 DETUNE →
3	← NOISE LEVEL →		← DC0 INTERVAL →	
4	← DC01 LEVEL * →		← VCF EG POLARITY →	← VCF EG INT →
5	UNDEFINED	← DC02 LEVEL →		*
6	← VCF TRIG MODE →	← VCF CUTOFF →		
7	← IMG DELAY →		← MG FREQ →	
8	← IMG VCF INT →		← MG DC0 INT →	
9	* ← DEG1 DECAY →		← DEG1 ATTACK →	
10	*	← DEG1 BREAK P. →		*
11	* ← DEG1 SUSTAIN →		← DEG1 SLOPE → *	
12	*	← DEG1 RELEASE →		*
13	← DEG2 DECAY →		← DEG2 ATTACK → *	
14	* ← DEG2 SLOPE →		← DEG2 BREAK P. →	
15	*	← DEG2 SUSTAIN →		*
16	* ← DEG3 ATTACK →		← DEG2 RELEASE → *	
17	*	← DEG3 DECAY →		*
18	← DEG3 SLOPE →		← DEG3 BREAK P. → *	
19	* ← DEG3 RELEASE →		← DEG3 SUSTAIN →	
20	← VCF KBD TRACK →	← VCF RESONANCE →		*
21	UNDEFINED	← DDL TIME →		
22	← DDL EFFECT LEVEL →		← DDL FEEDBACK →	
23	UNDEFINED		← DDL MOD FREQ →	
24	UNDEFINED		← DDL MOD INT →	
25	← EQ BASS →		← EQ TREBLE →	

"*" Exceeds byte unit.

UNDEFINED data can have any value; it is only used in the check sum.

MIDI IMPLEMENTATION

★ Relationships between bit map and parameter values listed on the front panel (per program).

DCO1 OCTAVE	0	b1—b0	00=1 (LOW), 01=2 (MID), 10=3 (HIGH), 11=INHIBIT	11
DCO2 OCTAVE	0	b3—b2	00=1 (LOW), 01=2 (MID), 10=3 (HIGH), 11=INHIBIT	21
DCO1 WAVE FORM	0	b5—b4	00=1 (∩), 01=2 (∪), 10—11=INHIBIT	12
DCO2 WAVE FORM	0	b7—b6	00=1 (∩), 01=2 (∪), 10—11=INHIBIT	22
DCO1 16'	1	b0	0=0 (OFF), 1=1 (ON)	13
DCO1 8'	1	b1	0=0 (OFF), 1=1 (ON)	14
DCO1 4'	1	b2	0=0 (OFF), 1=1 (ON)	15
DCO1 2'	1	b3	0=0 (OFF), 1=1 (ON)	16
DCO2 16'	1	b4	0=0 (OFF), 1=1 (ON)	23
DCO2 8'	1	b5	0=0 (OFF), 1=1 (ON)	24
DCO2 4'	1	b6	0=0 (OFF), 1=1 (ON)	25
DCO2 2'	1	b7	0=0 (OFF), 1=1 (ON)	26
DCO DETUNE	2	b1—b0	00—11=0—3	38
DCO MODE	2	b6	0=1 (WHOLE), 1=2 (DOUBLE)	18
DCO INTERVAL	3	b3—b0	0000—1100=0—12, 1101—1111=INHIBIT	28
NOISE LEVEL	3	b7—b4	0000—1111=0—15	37
VCF EG INT	4	b3—b0	0000—1111=0—15	35
VCF EG POLARITY	4	b4	0=1 (√), 1=2 (∧)	34
DCO1 LEVEL	4—5	b7—b5, b1—b0	00000—11111=0—31	17
DCO2 LEVEL	5	b6—b2	00000—11111=0—31	27
VCF CUTOFF	6	b6—b0	0000000—1100011=0—99, 1100100—1111111=INHIBIT	31
VCF TRIG MODE	6	b7	0=1 (SINGLE), 1=2 (MULTI)	36
MG FREQ	7	b3—b0	0000—1111=0—15	81
MG DELAY	7	b7—b4	0000—1111=0—15	82
MG DCO INT	8	b3—b0	0000—1111=0—15	83
MG VCF INT	8	b7—b4	0000—1111=0—15	84
DEG1 ATTACK	9	b4—b0	00000—11111=0—31	41
DEG1 DECAY	10—9	b1—b0, b7—b5	00000—11111=0—31	42

MIDI IMPLEMENTATION

DEG1 BREAK P.	10	b6-b2	00000-11111=0-31	43
DEG1 SLOPE	11-10	b3-b0,b7	00000-11111=0-31	44
DEG1 SUSTAIN	12-11	b0,b7-b4	00000-11111=0-31	45
DEG1 RELEASE	12	b5-b1	00000-11111=0-31	46
DEG2 ATTACK	13-12	b2-b0,b7-b6	00000-11111=0-31	51
DEG2 DECAY	13	b7-b3	00000-11111=0-31	52
DEG2 BREAK P.	14	b4-b0	00000-11111=0-31	53
DEG2 SLOPE	15-14	b1-b0,b7-b5	00000-11111=0-31	54
DEG2 SUSTAIN	15	b6-b2	00000-11111=0-31	55
DEG2 RELEASE	16-15	b3-b0,b7	00000-11111=0-31	56
DEG3 ATTACK	17-16	b0,b7-b4	00000-11111=0-31	61
DEG3 DECAY	17	b5-b1	00000-11111=0-31	62
DEG3 BREAK P.	18-17	b2-b1,b7-b6	00000-11111=0-31	63
DEG3 SLOPE	18	b7-b3	00000-11111=0-31	64
DEG3 SUSTAIN	19	b4-b0	00000-11111=0-31	65
DEG3 RELEASE	20-19	b1-b0, b7-b5	00000-11111=0-31	66
VCF RESONANCE	20	b5-b2	0000-1111=0-15	32
VCF KBD TRACK	20	b7-b6	00=0(OFF),01=1(HALF),10=2(FULL),11=INHIBIT	33
DDL TIME	21	b6-b0	0000000-1100011=0-99,1100100-1111111=INHIBIT	71
DDL FEEDBACK	22	b3-b0	0000-1111=0-15	72
DDL EFFECT LEVEL	22	b7-b4	0000-1111-0-15	75
DDL MOD FREQ	23	b4-b0	00000-11111=0-31	73
DDL MOD INT	24	b4-b0	00000-11111=0-31	74
EQ TREBLE	25	b3-b0	0000-0110-1100=(-6)-0-6,1101-1111=INHIBIT	76
EQ BASS	25	b7-b4	0000-0110-1100=(-6)-0-6,1101-1111=INHIBIT	77

SPECIFICATIONS & OPTIONS

Keyboard:	49 keys (C-C)
Voice:	8 voice (WHOLE mode), 4 voice (DOUBLE Mode)
DCO1:	Octave (LOW, MID, HIGH), Waveform (∩, ∟), 16', 8', 4', 2' (ON, OFF), Level adjustment
DCO2:	Octave (LOW, MID, HIGH), Waveform (∩, ∟), 16', 8', 4', 2' (ON, OFF), Level adjustment, Interval (1 Semi tone-perfect 8th), Detune (-20 cent Max.)
DCO Mode:	WHOLE, DOUBLE
NOISE:	Level adjustment
VCF:	Cutoff frequency adjustment, Resonance adjustment, Keyboard track (OFF, HALF, FULL), EG intensity, EG polarity (∩, ∟), EG trigger mode (SINGLE, MULTI)
DEG1, 2, 3:	Attack time, Decay time, Break point level, Slope time, Sustain level, Release time
Digital Delay:	Time (1024 ms Max.), Feedback level, Modulation frequency, Modulation intensity, Effect level
Equalizer:	Bass, Treble
MG:	Frequency, Delay time, DCO intensity, VCF intensity
SEQ Mode:	Mode (ONE TIME, REPEAT), SEQ clock (INT, EXT)
MIDI:	Send/receive channel (ch 1-16), Program change (ENABLE, DISABLE)
TUNE:	±50 cents
POWER:	OFF, Volume adjustment
Joystick:	X axis (Pitch bend), +Y axis (DCO modulation), -Y axis (VCF modulation)
Bend:	Pitch bend width adjustment (±700 cents Max.)
Sequencer:	START/STOP, STEP, SPEED (Slow-Fast)
Key assign mode:	POLY, CHORD MEMORY, HOLD
Programmer:	Number key (1-8), Program/parameter key, BANK HOLD key, Value (UP, DOWN) key, WRITE key
Indicator:	PROGRAM NO. display, PARAMETER NO. display, VALUE display, Bank hold display, Edit display
Tape interface:	Save, Load, Verify, Cancel
Input jacks:	FROM TAPE jack (HIGH/LOW switch), Program up jack (∩ _{GND})
Output jacks:	OUTPUT (R, L/MONO) jack, PHONES jack, TO TAPE jack
Tape switch:	ENABLE/DISABLE
Write switch:	PROGRAM WRITE switch, SEQUENCER WRITE switch
MIDI connectors:	IN, OUT
DC 9V jack:	AC adaptor jack
Strap pin:	2
Dimensions:	780(W) × 87.6(H) × 286(D)
Weight:	4.4 kg (including battery)
Accessories:	Preload data tape, Battery (C-type × 6), Connection cord, AC adapter
Options:	Memory expander MEX-8000, Pedal switch PS-1, Dynamic stereo headphones KH-1000, Stand ST-8B, Hard case, Light bag LB-800, Keyboard strap (black, brown), MIDI cable 12, 10, 7m)

★ Specifications subject to change without notice.

N O T I C E

Korg products are manufactured under strict specifications and voltages required by each country. These products are warranted by the Korg distributor only in each country. Any Korg product not sold with a warranty card or carrying a serial number disqualifies the product sold from the manufacturer's/distributor's warranty and liability. This requirement is for your own protection and safety.

PRELOAD PROGRAM LIST

REAL STRINGS	STAR DUST	HUMAN VOICE	DIGITAL CHIME	BRASS ENSEMBLE I	DIGITAL SYAMISEN	CHIF FLUTE	AFRICAN BASS
STRINGS	LOW STRINGS	BLIZZARD	GLOCKEN & VIOLIN	REAL ATTACK BRASS	TROMBONE	BRASS ENSEMBLE II	DIGITAL BRASS
PIPE ORGAN	JAZZ ORGAN	NEW WAVE ORGAN I	NEW WAVE ORGAN II	CIRCUS ORGAN	FLUTE	FLUTE & PICCOLO	MARCHING FLUTE
SYNTH BASS I	SYNTH BASS II	SYNTH BASS III	ELECTRIC BASS	DIGITAL BASS	SOLO SYNTH	SPACE PERCUSSION	JEW'S HARP
HARMONICA	HARPSICORD	WHISTLE	STEEL DRUM	GERMAN KLAXON	PIANO	VIBES	MUSICAL BOX
SYNTH SOUND I	SYNTH SOUND II	LASER SHOT	REVERSE	SPACE CHIME	NOISE OF ART	ORIENT	AURORA
SYNTH HARPSICORD	TOY PIANO	HONKY TONK	SAVANNA	SYNTH VIBES	ORIENTAL DELAY	ICELAND	NOISE HIT
PAN FLUTE	SUNSET	MID NIGHT	EXORCIST	TWILIGHT	HARMONICS	PERCUSSIVE ORGAN	FINALE

SEQUENCER PRELOAD PATTERN

8va -----

The musical score is written for piano and is divided into three systems. The first system begins with a dynamic marking of *8va* followed by a dashed line, indicating an octave shift. The notation is complex, featuring many chords and arpeggiated figures. The second system continues with similar dense harmonic textures. The third system is shorter and appears to be a concluding phrase.

KORG

KEIO ELECTRONIC LABORATORY CORPORATION
15-12, Shimotakaido 1-chome, Suginami-ku, Tokyo, Japan.

©KEIO ELECTRONIC LABORATORY CORP. 1985

0012 0TH PRINTED IN JAPAN