

modwave native

WAVETABLE SYNTHESIZER

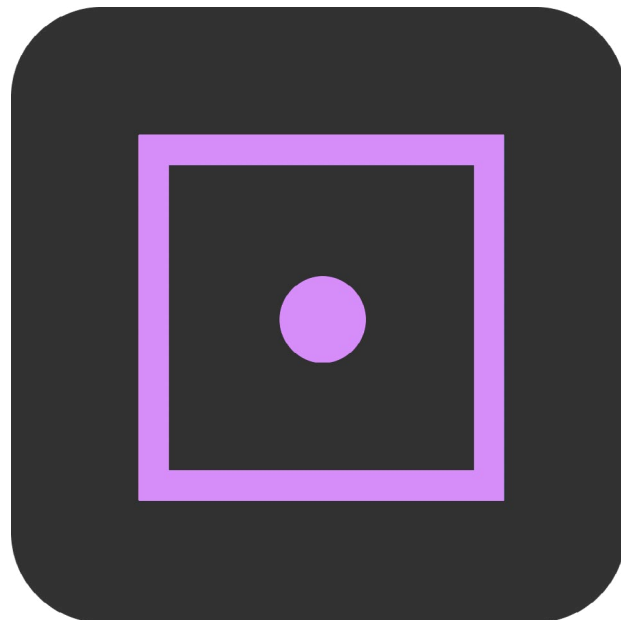

KORG

E1

Contents

Introduction	1
Main Features	1
Structure	2
User Interface Elements	2
Conventions in this manual	3
Getting Started	4
Installation and updates	4
Play page	4
Edit pages	7
Sound Browser	9
Saving Sounds	11
Modulation	13
MIDI Learn	14
Automation	15
Copy/Paste	15
Randomize	16
Main Menu	17
Settings	18
User Sample Banks	22
Synthesis page	23
Oscillator 1/2	24
Filter	29
Common Pitch	33
Amp	34
Motion Sequencing 2.0	36
Overview	36
Sequencer page	37
Motion Sequence	38
Standard Lane Controls	39
Step Probability	40
Master Lane	40
Timing Lane	40
Pitch	42
Shape	44
Seq A/B/C/D	44
Motion Sequence Steps contextual menu	45
Arp & Setup page	47
Arpeggiator	47
Layer Setup	49
Program Setup	50
Zones & Scales page	53
Performance Setup	53
Performance Scale	54
Keyboard Zones	55

Velocity Zones	55
Modulation List page.....	56
Modulation Sources	58
Kaoss Physics	61
Overview	61
Kaoss Physics page.....	62
Kaoss Physics settings.....	63
Kaoss Launch	64
Envelopes	65
Filter/Amp/Osc 1/Osc 2 Envelope	65
Filter/Amp/Osc 1/Osc 2 Envelope Curve	65
Filter/Amp/Osc 1/Osc 2 Envelope Trigger	66
LFOs	67
Filter/Amp/Pitch/Osc 1/Osc 2 LFO.....	67
Key Track.....	70
Filter Key Track	70
Amp Key Track.....	71
Modulation Processors.....	73
Overview	73
Gate	73
Offset	74
Quantize	75
Scale	76
Curve.....	76
Smooth.....	78
Sum	78
Effects page	80
Overview	80
Mini Editors.....	81
Pre FX	81
Mod FX	82
Delay	83
Reverb & EQ page.....	84
Master Reverb.....	84
Master EQ	85
Librarian page	86
Librarian contextual menu.....	88
Import and export.....	88
Importing Wavetables	90
Set Lists.....	92
Set List window	92
Using Set Lists	92
Editing Set Lists	93
Set List contextual menu	94

Troubleshooting	95
No sound	95
The sound has clicks, pops, or noise.....	95
Sound is delayed.....	95
Can't control the software synthesizer from a MIDI device connected to the computer.....	95
Specifications.....	96
Operating requirements	96
Support and service.....	97
Before you contact us.....	97
Information to provide when contacting us	97

Introduction

Thank you for purchasing Korg's modwave native software synthesizer. To help you get the most out of your new instrument, please read this manual carefully.

Main Features

In 1985, Korg's DW-8000 combined digital wavetables with rich analog filters to give users sounds which were impossible to create with analog oscillators. It's still a cult favorite today.

The modwave builds on the DW legacy and transforms it into a modern monster synth, featuring incredibly deep wavetable oscillators, gorgeous filters, wildly flexible modulation, sophisticated pattern sequencing, and macro controls to deliver unique, powerful, and easily customizable sounds and phrases.

Wavetable Oscillators

Start with over 200 wavetables, each containing up to 64 waveforms—from thousands of individual waves. Use the 30+ Modifiers to change their basic character, and the 13 Morph Types to process them in real-time. Create new hybrids from any two wavetables using the unique, realtime A/B Blend.

Expand your palette even more by importing new wavetables using the Editor/Librarian software. Try the many free and commercial wavetable libraries in the standard Serum format*, or create your own using the custom modwave version of the free, cross-platform WaveEdit. Layer wavetables with samples from the built-in, multi-gigabyte PCM library, or import your own samples using Korg's free Sample Builder software.

Kaoss Physics and Motion Sequencing 2.0

modwave also introduces two unique new tools for creating dynamic motion: Kaoss Physics and Motion Sequencing 2.0. Kaoss Physics combines an x/y Kaoss pad with modulatable game physics to create a responsive, interactive controller that is—besides being powerful—a lot of fun to explore. Motion Sequencing 2.0 brings the organic, continuously evolving patterns of the wavestate's Wave Sequencing 2.0 into the world of motion sequencing, including multiple lanes, asynchronous loops, step probability, and more.

Filters

Add vintage character to your sounds with the aggressive MS-20 Lowpass or Highpass filters, or the strong, sweet Polysix Lowpass. Shape and refine with a full collection of resonant 2-pole and 4-pole Lowpass, Highpass, Bandpass, and Band Reject filters. Or, step outside the box with Korg's unique Multi Filter, which creates modulatable blends of multiple modes simultaneously.

Modulation

Most parameters can be modulated, with up to 2,000 modulation destinations per Performance, and no fixed limit on the total number of modulation routings. You can even modulate settings for individual Motion Sequence Steps!

Mod Knobs put macro transformations under your fingertips, making it easy to explore the sonic worlds inside each Performance. Tweaking an existing sound? Quickly identify modulation sources using real-time displays of all envelopes, LFOs, and other primary modulation sources. Easily create modulation routings using drag-and-drop, and get an overview of all routings via the Mod List. Mod Processors let you transform modulation signals using quantization, smoothing, curvature, and more.

Layers and Effects

For even more rich and complex results, layer two Programs together in a Performance—each with their own effects and arpeggiator. modwave native's superb effects deliver production-ready sounds. Each Layer has three dedicated effects (Pre, Mod, and Delay); additionally, the Performance has a Master Reverb and Master EQ.

Presets and Randomization

modwave native comes with about 250 factory Performances, and many more Programs, Wavetables, and Effects Presets. Smooth Sound Transitions let previously-played voices and effects ring out naturally when you change sounds.

Looking for even more inspiration? The "dice" icon at the top of the window generates new sounds via intelligent randomization. Randomize the entire sound or just a part of it, such as the filter, motion sequence, or effects. Use the results directly, or as a jumping-off point for your own creations.

Fully compatible with the hardware modwave synthesizer

modwave native is the fully-compatible software counterpart to the hardware modwave synthesizer.

You can seamlessly exchange sounds between hardware and software. Produce in your DAW with modwave native, and then play the same sounds onstage using the modwave hardware. Create sounds with the hardware's hands-on interface, and then share them with a computer-based collaborator.

Structure

modwave native plays one Performance at a time.

A Performance has two Layers (A and B), Kaoss Physics, and a master reverb and EQ.

Each Layer contains an Arpeggiator, a Program, and other settings such as MIDI channel, key and velocity zones, etc.

A Program includes two Oscillators (1 and 2), each of which may play one or two Wavetables (A and B) or a single Multisample, a Sub Oscillator/Noise Generator, a Filter, an Amp, a Motion Sequence, a set of modulators, a modulation matrix, and three effects: Pre FX, Mod FX, and Delay.

Modwave Structure

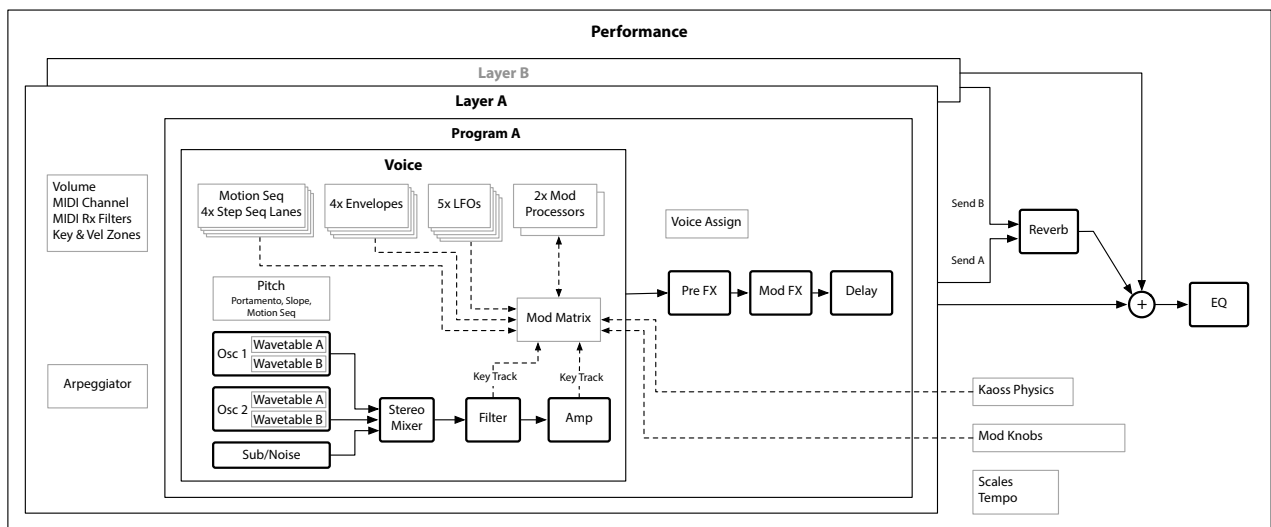

User Interface Elements

Selectors

modwave native keeps track of sounds, and some individual sound elements, using a database. This includes Performances, Programs, Motion Sequences, Motion Sequence Lanes, Effects Presets, Scales, Set Lists, Wavetables, and Multisamples. In the UI, these appear as Selectors:

Selector

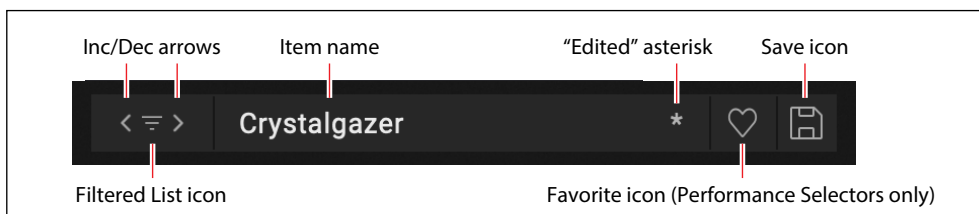

This shows the currently selected item. Use the < and > arrows to step through them one by one, or click on the name to bring up a browser window (see “Sound Browser” on page 9). An asterisk “*” to the right of the name shows that the item has been edited from its saved version.

Important: the arrows step through the list of items according to the Sound Browser window’s sort order, and filtered by the window’s Categories, Collections, and search text. Each individual selector remembers these settings for as long as modwave native is open and unless a new parent sound is selected (for example, the Program is the parent sound of the Motion Sequence).

Introduction

If some items are hidden due to the selected Categories, Collections, and search text, the Filtered List icon appears between the < and > arrows. To clear the filters and show all items in the list, click the Filtered List icon. Alternatively, open the Sound Browser and adjust the filters as desired. For more information, see “Sound Browser” on page 9.

Press the Save icon to bring up the Save dialog. Note that this does not appear for items which can't be edited within modwave native, such as Multisamples and Scales.

Right-click/control-click (macOS) on the name to bring up a contextual menu. For most items, this includes options for saving and renaming. For Programs and Motion Sequences, it also includes Copy and Paste.

For Performances only, the Selector includes the Favorite indicator. This lets you quickly mark Performances as favorites. You can then find them later via the “Favorite” Category. Other data types can also be marked as favorites from the Sound Browser and Librarian, but there wasn't room to include the icon in the smaller Selectors.

Favorite icon (Performance Selectors only)

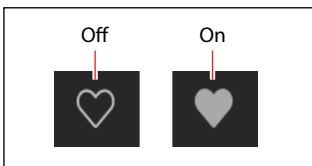

Knobs and sliders

To edit knob values, drag vertically.

To edit slider values, drag in the direction of the slider.

Most knobs and sliders can also be edited by hovering the cursor over the control, and then using the mouse wheel or dragging on the trackpad. The exception is when the controls are in a scrolling list, such as the Mod Inspector panel or the Mod List. In these lists, the mouse wheel and trackpad drag are used for scrolling, and so they are disabled for editing (to avoid unintended changes).

Double-click knobs and sliders to center them.

Graphic editing

Envelopes, LFOs, Key Track generators, Key & Velocity Zones, Filters, and the Master EQ can be edited directly in their respective graphics. To do so:

- 1. Hover the cursor over the graphic to show a colored handle.**

In most cases, this is either a dot or a line. For LFOs, the entire waveform serves as a “handle.”

- 2. Drag the handle to edit the value.**

To edit Envelope Curve settings, use the yellow handles in the middle of the A/D/R segments.

To edit the Fade ranges of Key & Velocity Zones, use Option-drag (macOS) or Alt-drag (Windows).

Conventions in this manual

In this manual, the following text styles indicate:

- **Parameter Names**
- *Parameter Values*

Getting Started

Installation and updates

modwave native uses the Korg Software Pass application for installation and updates. Optionally, modwave native can check for updates automatically; see “Check for Updates” on page 18.

Your software license is registered to your Korg ID. You can download the Korg Software Pass application and manage your Korg ID at <https://id.korg.com>.

Where are sounds stored?

The sound database and factory Multisamples are stored in a dedicated folder structure. This can be created anywhere during the installation process, but as defaults we recommend:

- macOS: /Users/Shared/KORG/modwave native/System
- Windows: \Users\Public\Public Documents\KORG\modwave native\System

User Multisamples can be stored anywhere.

Play page

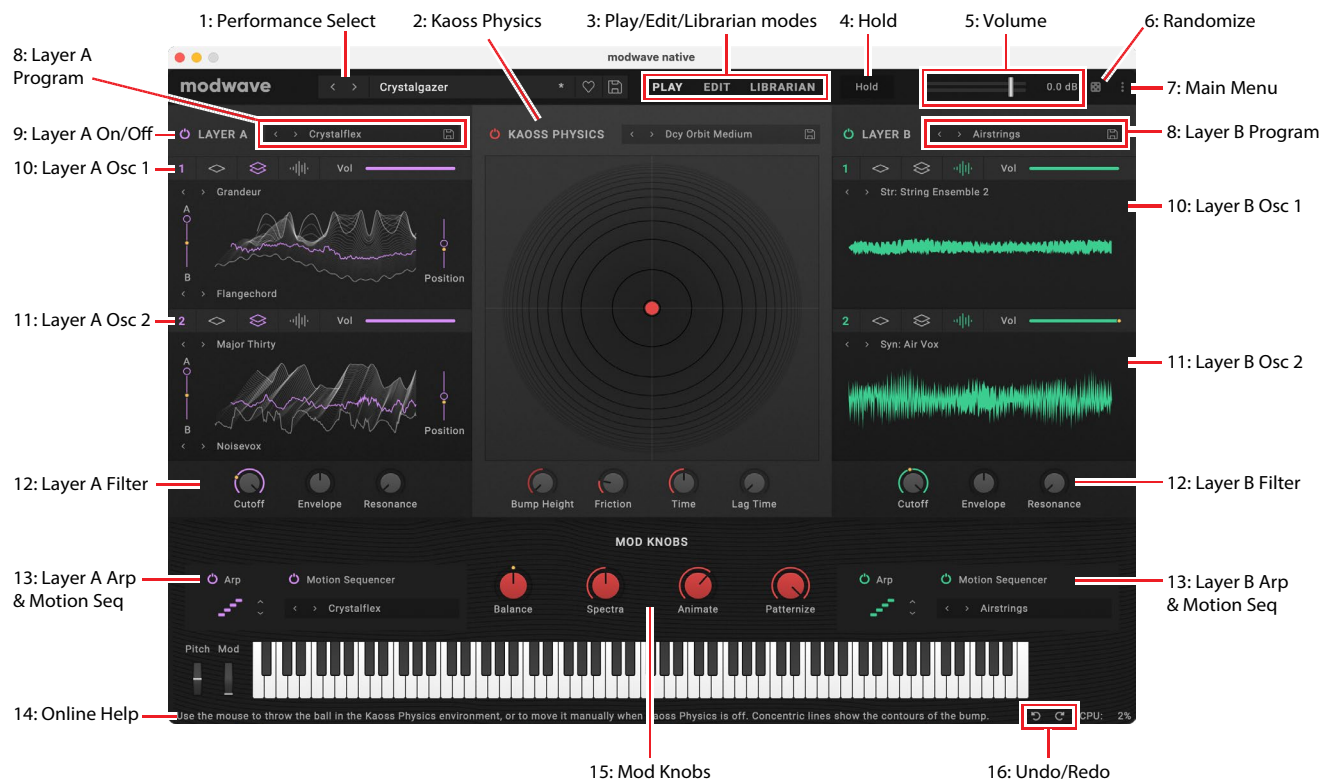

The Play page gives you everything you need to play sounds and make quick edits.

1: Performance Select

The Performance, with its two Layers, is the main way of selecting, editing, and saving sounds.

This shows the currently selected Performance. Use the < and > arrows to step through Performances one by one, or click on the name to bring up a browser window (see “Sound Browser” on page 9). Note that the sounds available via the arrows may be filtered by settings made in the Sound Browser, such as selected Categories or Collections. Right-click/control-click (macOS) on the name to bring up a contextual menu for saving and renaming.

2: Kaoss Physics

Press the power button to turn Kaoss Physics on and off. Presets let you store and recall all of the Kaoss Physics settings. Use the < and > arrows to step through Presets one by one, or click on the name to bring up a browser window.

Start the motion by dragging and releasing the on-screen ball with your mouse or trackpad. You can also directly control the ball by dragging without releasing.

The Concentric rings indicate the selected **Shape**. Black and white shadowing indicates **Bump Height**; darker for negative (“hole”), and lighter for positive (“hill”). Red shadowing indicates **Tilt**. Edge brightness indicates **Bounce** settings; darker for negative (absorptive), and lighter for positive (accelerating).

For more detailed control, use the Kaoss Physics page; see “Kaoss Physics” on page 61.

3: Play/Edit/Librarian modes

The buttons in the top of the main window select whether you’re on the Play page, digging in deep on the Edit pages, or working with the Librarian. For the most part, you can simply switch between these modes without thinking about it. It’s important to note, however, that some menu commands are available only in Librarian mode, and that undo is handled separately for the Librarian and Play/Edit modes.

Menu commands

Menu commands for file operations, such as importing, backing up, and restoring, are available only when the Librarian is active.

Undo/Redo

Undo/redo history is maintained separately for the Librarian and Play/Edit modes. The names of the undo/redo commands change to reflect this; for example, “Editor Undo: Value Change: Cutoff” or “Librarian Undo: Update Name.”

4: Hold

[Off, On]

Use **Hold** to hold notes or chords, leaving your hands free for knobs and modulation. This works differently from the Damper Pedal. When **Hold** is *On*, notes or chords are held indefinitely until you play a new note or chord, at which point the previous notes are cut off and the new ones will sound.

Hold applies only to Layers on the **Global MIDI Channel**.

5: Volume

This controls the overall volume of the Performance. Use the slider or numeric readout to make adjustments, and view the results on the meter behind the slider.

6: Randomize

This brings up a window which can randomize either the entire sound, or selected elements of the sound. For details, see “Randomize” on page 16.

7: Main Menu

This menu gives access to overall settings such as CC assignments and the User Sample Bank, undo/redo, user interface size scaling, “About” information, and Librarian-specific commands. For details, see “Main Menu” on page 17.

8: Layer A/B Program

This is the Program assigned to the Layer (see “Structure” on page 2). Programs contain all of the settings in the Synthesis, Sequencer, and Effects pages. Use the < and > arrows to step through Programs one by one, or click on the name to bring up a browser window. Right-click/control-click (macOS) on the name to bring up a contextual menu for saving and renaming.

9: Layer A/B On/Off

The power buttons turn the Layers on and off.

10 & 11: Layer A/B Osc 1 and Osc 2

These areas include the basic settings for the two oscillators in each Layer, including **Mode** (single Wavetable, double Wavetable, or Sample), **Volume**, Wavetable selection, and Wavetable **Position** and **A/B Blend**. For more information, see “Oscillator 1/2” on page 24.

12: Layer A/B Filter

These areas include the basic settings for the Layer’s filter, including **Cutoff**, **Resonance**, and **Envelope Intensity**. For more information, see “Filter” on page 29.

13: Layer A/B Arp & Motion Seq

These areas include on/off and preset selection for the Layer’s arpeggiator and Motion Sequencer. For more information, see “Arpeggiator” on page 47, and “Motion Sequencing 2.0” on page 36.

14: Online Help

When you hover over a parameter or control, this area shows a brief explanation of what it does or how it works. This area also shows the specific action that will be affected by Undo and Redo; see below.

15: Mod Knobs

The Mod Knobs can control any number of parameters in any of the Layers; they will do different things depending on the specific sound. The knob values are stored, and can themselves be modulated. You can use the Mod Knobs in real-time performance, and also save the results as new sounds.

16: Undo and Redo

modwave native supports multiple levels of undo and redo for most actions, including importing data, deleting, renaming, editing Set Lists, editing parameters, and so on. For instance, you could import a bundle file containing a thousand objects, edit Filter Cutoff, rename all of your Programs, and finally add a new modulation routing to Amp LFO Frequency, and safely undo all actions in turn.

The counter-clockwise arrow (“go back”) is Undo, and the clockwise arrow (“go forward”) is Redo. Hover over the arrows, and the Online Help area shows the action which will be undone or redone.

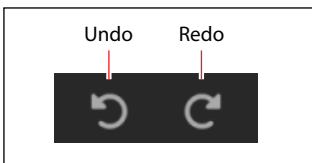

Undo/redo history is maintained separately for the Librarian and Play/Edit modes. The names of the undo/redo commands change to reflect this; for example, “Editor Undo: Value Change: Cutoff” or “Librarian Undo: Update Name.”

Edit pages



The Synthesis, Sequencer, Setup, and Effects pages all follow this basic layout, and the other pages under Edit also include most of these elements.

1: Layer Select

These select a Layer to view and edit. The power buttons turn the Layers on and off. When a Layer is selected, its Synthesis, Motion Sequence, Arp & Setup, and Effects tabs appear below. The edit pages are color-coded to match the layer; A is purple, and B is green.

2: Page Tabs

These select the page shown in the Main Editing Area.

3: Main Editing Area

The parameters for the current Page will appear here. This includes the synthesis parameters, Motion Sequence, detailed effects settings, and so on.

4: Mod Sources

All of the main controllers and programmable modulation sources are shown here, including the keyboard with note number, velocity, aftertouch, and Pitch and Mod Wheels, Kaoss Physics, Envelopes, LFOs, Key Tracking, Mod Processors, and the Step Seq Lanes. Graphics show the mod source outputs, making it easy to figure out what's creating a specific modulation effect. You can drag from the mod sources here to modulate parameters in the main part of the screen, or even other modulation parameters; see "Drag and drop modulation routings" on page 13.

5: Program Select

This is the Program assigned to the Layer (see "Structure" on page 2). Programs contain all of the settings in the Synthesis, Sequencer, and Effects pages. Use the < and > arrows to step through Programs one by one, or click on the name to bring up a browser window. Right-click/control-click (macOS) on the name to bring up a contextual menu for saving and renaming.

6: Sync & Tempo

When **Sync To Host** is *On*, all tempo-related parameters will synchronize to the tempo from the DAW. When it is *Off*, they will use the tempo saved in the Performance.

Getting Started

When running as a stand-alone application, this changes to the **Clock** parameter, which lets you choose the MIDI clock source (*Internal*, *External*, or *Auto*).

Tempo

[40...300]

This is the stored tempo for the Performance. It applies only if **Sync To Host** is *Off* (when running as a plug-in) or when **Clock** is set to *Internal* or *Auto* (when running stand-alone); otherwise, it is grayed out.

7: Mod Knobs

The Mod Knobs can control any number of parameters in any of the Layers; they will do different things depending on the specific sound. The knob values are stored, and can themselves be modulated. You can use the Mod Knobs in real-time performance, and also save the results as new sounds.

You can drag from the Mod Knobs (using their appear-on-hover drag handles) to modulate parameters in the main part of the screen, or even other modulation parameters; see “Drag and drop modulation routings” on page 13. You can also assign MIDI CCs to control the Mod Knobs; see “MIDI Learn” on page 14.

Each Mod Knob can be either unipolar (+) or bipolar (+/-); to change this, right-click/control-click (macOS) on the knob to bring up a contextual menu. Use this same menu to change the Mod Knob names.

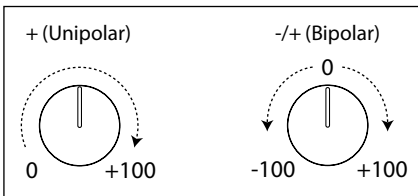

8: Mod Inspector

This shows the modulation routings for the selected parameter. You can add or delete routings from the list, adjust modulation intensity, and change the selected Mod Sources (including adding a second Mod Source for routings created by drag-and-drop).

Sound Browser

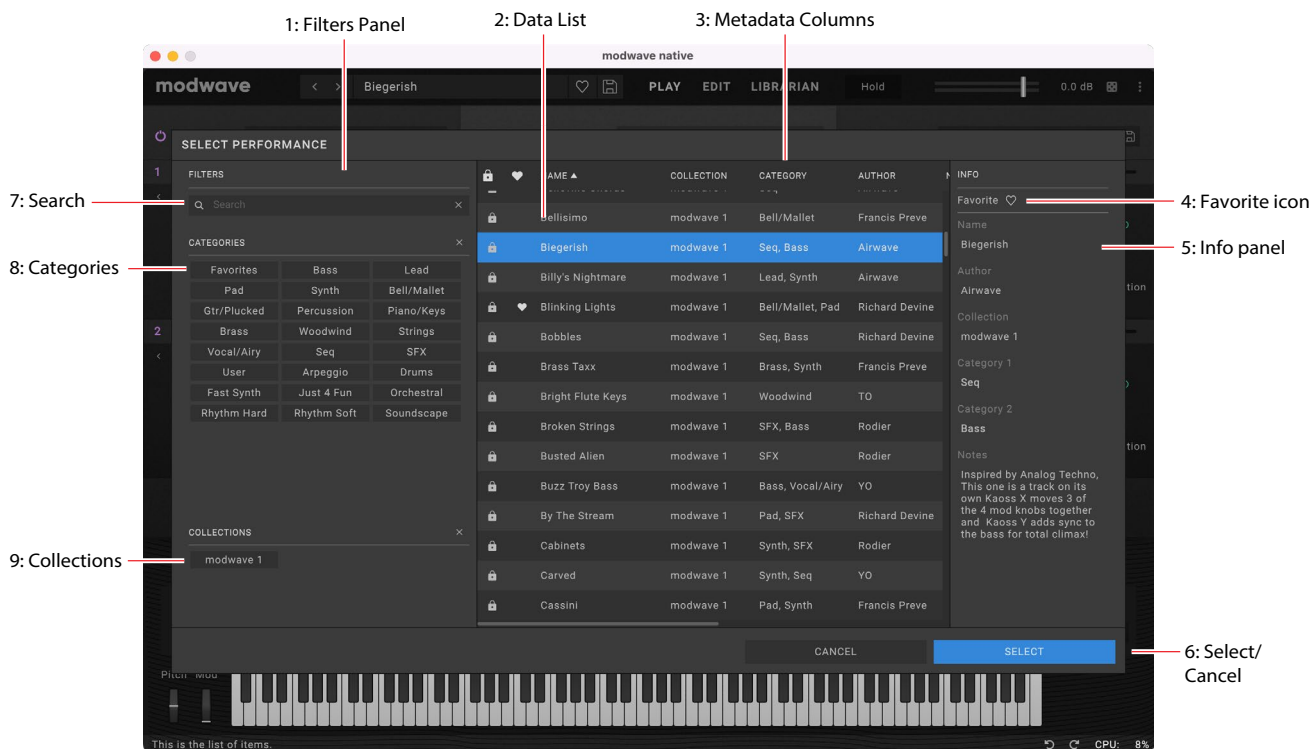

Overview

The Sound Browser is used for selecting any type of sound data, such as Performances, Programs, Motion Sequences, Motion Sequence Lanes, Effects Presets, Multisamples, Wavetables, etc. For editing metadata (such as name, Categories, etc.), use the Librarian instead.

1: Filters Panel

The selections here help you narrow down the number of items in the Data List. Set the Search, Categories, and/or Collections as desired. The Filters Panel can be resized by dragging its right edge, to show one, two, or three columns of Categories and Collections.

Important: The Search, Categories, and Collections settings continue to affect data selection, even after the Sound Browser is closed. Each individual selector remembers these settings for as long as modwave native is open and unless a new parent sound is selected (for example, the Program is the parent sound of the Motion Sequence). For more information, see “Selectors” on page 2.

2: Data List

This shows the list of selectable sound data (Performances in the example above), as filtered by the Search, Category, and Collection settings in the Filters Panel. Click on an item in the list to select it for auditioning, or use the keyboard up/down arrows to browse through items one by one. Click in the list and type a few letters to select sounds by name. Double-click (or press OK) to select and close the browser.

3: Metadata columns

For each item, the list shows the Name, Collection, Category, Author, and Notes, as well as whether or not the item is locked factory data. You can drag the tops of the columns to re-arrange them, or to resize the columns.

Click on a column heading to sort; click again to reverse the sort order. The triangle icon shows which column is selected for sorting, and the direction of the triangle (up or down) shows the sort order.

4: Favorite icon

Click on the heart to mark (or un-mark) an item as a Favorite. You can then find them later via the “Favorite” Category.

Getting Started

Favorite icon

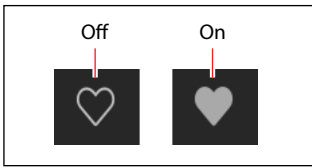

5: Info panel

This panel lets you view the metadata for the selected items, including the Name, Collection, Categories 1 & 2, Author, and Notes. The Inspector panel can be resized by dragging its left edge.

6: Select/Cancel

Press Select to confirm the selection and close the window, or Cancel to revert to the previous selection.

7: Search

Type into this field to filter the list by searching for text in any of the metadata fields. Click on the “X” to clear the field.

8: Categories

Categories let you filter by the type of sound, such as basses, leads, bells, etc. Each sound can be assigned to two Categories, and each data type—Performances, Programs, etc.—has its own list of Categories. Click on a Category name to filter by that Category; click on the “X” to deselect all Categories.

When searching by Category, a sound will be shown if either of its Categories match the search criteria.

This section also includes “Favorites,” which shows all sounds which you’ve marked as favorites. You can use the Favorites selection in combination with any other Categories.

9: Collections

Collections let you filter sounds by group, such as factory sounds, expansion packs, or your own projects. Each sound can be assigned to one Collection. Click on a Collection name to filter by that Collection; click on the “X” to deselect all Collections.

Saving Sounds

The Performance, with its two Layers, is the main way of selecting, editing, and saving sounds. While you can save Programs, Motion Sequences, Motion Sequence Lane Presets, and Effects Presets, you don't have to do so: all data is contained in the Performance.

Similarly, when you load any of these data types into a Performance, a new copy of the data is created in the Performance. Any edits affect only the local copy inside the Performance, and not the original data. This lets you edit freely without worrying about affecting other sounds.

To save a sound or preset:

1. **Go to the Selector for the sound or preset. For more information, see “Selectors” on page 2.**
2. **Press the Save icon, or right-click/control-click (macOS) on the name to open the contextual menu and select the Save command.**

The Save dialog will appear:

Save dialog

SAVE PERFORMANCE

Name
A Bunch of Nonsense

Author
Airwave

Collection
modwave 1

Category 1
Percussion

Category 2
Seq

Notes
This is how I described it. Play it and tell me your opinion!
Lowest C plays a beat.

3. **Set the Name, Author, Collection, and Categories as desired.**

You can also edit all of this metadata later, using the Librarian window.

 **Important:** changing the name does not automatically make a new copy of the sound! Always use **Save As New** when you want to make a copy.

4. **Save the sound, using either Overwrite or Save As New.**

To overwrite the existing sound, use **Overwrite**. To make a new copy and leave the existing sound unchanged, use **Save As New**. Factory sounds may be write-protected, in which case only “Save As New” is available.

Renaming sounds

As described above, Performances store all of the data for their Programs, Motion Sequences, Motion Sequence Lanes, and Effects Presets. This also includes the names of those elements. Because of this, you can rename any of these elements without saving them separately, as long as you then save the enclosing Performance. To do so:

Getting Started

Right-click/control-click (macOS) on the name and select the Rename... command in the contextual menu.

5. Select Rename.

6. Enter the new name, and press OK to confirm.

Names can be up to 24 characters long.

7. Make sure to save the Performance once you're done.

Modulation

Modulation Overview

Most parameters can be modulated. Each modulation routing includes a primary modulation source, an intensity, and a secondary modulation source; the three are multiplied together to create the modulation amount. A single destination, such as Filter Cutoff, can have up to 31 incoming modulation routings. There is no fixed limit on the total number of modulation routings. For descriptions of all of modwave native's modulation sources, see "Modulation Sources" on page 58.

How are mod routings shown?

Modulated values are shown as orange dots on knobs and sliders. If a parameter is shown only as a text or numeric box, and it is modulated, then the text is shown in orange.

The modulation inspector on the right side of the window shows the modulation routings, if any, for the selected parameter. You can also use the inspector to add new modulations or delete existing ones.

Drag and drop modulation routings

To create a modulation routing using drag and drop:

1. **In the Mod Sources footer, click and hold on the *name* of any of the following: the Mod or Pitch wheel, Envelopes, LFOs, Filter or Amp Key Track, or Mod Processors. For Kaoss Physics, click and hold on the letters X, Y, A (for Angle), or D (for Distance.) In the Keyboard page, click and hold on Note # or any of the Vel or AT sources.**

For the Mod Knobs, hover over a knob to show its cross-shaped drag handle, and then click and hold on the handle.

Mod Knob Drag Handle in upper right

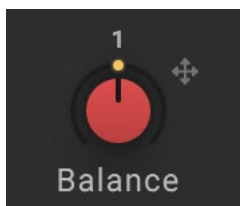

2. **Drag to a modulation destination.**

Most parameters are modulatable. Newly-created modulation routings will appear in the Mod Inspector.

Note: If a parameter cannot be modulated, a message will appear to that effect. If the message "Channel Sources Only" appears, the parameter cannot be modulated from per-voice sources such as LFOs, envelopes, Step Seq Lanes, and Key Track. In this case, choose a different modulation source.

3. **In the Mod Inspector, set the Intensity as desired.**

The maximum Intensity is typically +/- the full range of the parameter, so that regardless of the programmed value, modulation can always reach the minimum or maximum values.

4. **Optionally, assign a second modulator (the Intensity Mod Source), whose value will multiply that of the main Source.**

For example, you could route Step Seq B to Multi Filter **Crossfade**, with the overall amount of the step sequencer modulated by the Amp LFO.

Note: Once a modulation routing is created, you can change either of the sources, but you cannot change the destination.

Manually adding modulation routings

You can also manually add modulation routings using the Mod Inspector. This can be convenient if you want to create a routing using more esoteric mod sources not available via drag-and-drop, such as Prog #of Notes or arbitrary CCs. To do so:

1. **Click on the desired destination parameter.**

Provided that it is modulatable, its name will appear at the top of the Mod Inspector.

2. **In the Mod Inspector, click on the "+" button.**

A new modulation routing will appear.

3. **Select mod sources and set Intensity as desired. If the mod source you want to use is available in the Mod**

Getting Started

Sources footer, you can drag and drop to any Mod Source selector.

Modulating one mod source with another

You can also drag-and-drop to modulate one mod source with another. To do so:

1. **Click and hold on the name of the mod source, as above.**
2. **Drag and hold over the tab for the desired modulation destination.**

For example, to modulate the Filter LFO, hold over the LFOs tab.

After a moment, the tab will open.

3. **Once the tab opens and displays its contents, drag to the desired destination.**

Filter/Pitch/Osc Env Intensities, LFO Intensities, and Key Track Intensities

Modulation works slightly differently for these “Intensity” parameters. When you select them as a destination:

- The modulation destination is set to the main parameter: Filter Cutoff, Amp Level, Position, Morph Amount, Pitch Tune, or Pan
- The Source is set to the Envelope, LFO, or Key Track generator.
- The Intensity Mod Source is set to the selected modulation source.

Filter, Pitch, and Osc 1/2 Env Velocity Intensity

These Envelope Velocity Intensity settings cannot themselves be modulated.

Deleting a modulation routing

To delete a modulation routing:

1. **In the Mod panel, click on the “minus” button to the right of the routing.**

MIDI Learn

You can use your controller to automatically select MIDI CCs as modulation sources, and to directly control the Performance and Layer Mod Knobs.

Using MIDI Learn to control the Mod Knobs

The Performance and Layer Mod Knobs can be controlled directly from MIDI CCs. Unlike normal modulation, this works by directly editing the Mod Knob values, just like turning the knobs on the screen.

 **Important:** Any changes made this way will be saved with the sound. To modulate a parameter with variable intensity, and without causing edits to the sound, use modulation instead.

To use MIDI Learn with the Mod Knobs:

1. **Route a MIDI controller to modwave native.**
 2. **Right-click/control-click (macOS) on the desired Mod Knob.**
- A contextual menu will appear.
3. **Select MIDI Learn from the contextual menu.**
 4. **On the MIDI controller, move a knob, wheel, slider, etc. to generate a CC.**

The CC will be assigned to control the Mod Knob; when you send the CC from a MIDI controller, the knob will move in response. You can confirm this assignment, or edit it manually, in the **CC Assign** section of the contextual menu. If a different Mod Knob had previously been assigned to the same CC, the older assignment will be removed. Note that any fixed CC assignments (CC#1 for Mod Wheel, CC#s 18 & 19 for Kaoss Physics, etc.), and any modulation routings which use MIDI CCs, will continue to work as they did before—so it’s best to use CCs that aren’t being used for other purposes.

Using MIDI Learn to assign CCs as modulation sources

CCs can also be used as modulation sources for any modulatable parameter, and you can use MIDI Learn to assign them. To do so:

1. **Route a MIDI controller to modwave native.**
 2. **Click on the desired destination parameter.**
- Provided that it is modulatable, its name will appear at the top of the Mod Inspector.
3. **In the Mod Inspector, click on the “+” button.**

Getting Started

A new modulation routing will appear.

- 4. Right-click/control-click (MacOS) on one of the Source selectors.**

A contextual menu will appear.

- 5. Select MIDI Learn from the contextual menu.**

- 6. On the MIDI controller, move a knob, wheel, slider, etc. to generate a CC.**

The source will be set to the CC. Note that there are two sets of CC modulators, CC+ and CC +/-; for more information, see “CC +” on page 60. When using MIDI Learn, the CC + version is assigned.

- 7. Set the Intensity as desired.**

Automation

Automation from the plug-in host is supported for most, but not all, modulatable parameters. Even if a parameter is not directly available for automation, you may be able to create a modulation routing from a Mod Knob or Effect Edit knob, and then modulate the knob. Most non-modulatable parameters cannot be automated, including modulation routings themselves (sources and intensities), filter and mod processor types, Multisample selection, and so on.

For Effects, only controls shown in the “Mini Editors” can be automated. This includes Edit 1/2/3, Wet/Dry, and level controls. For individual Motion Sequence Steps steps, automatable parameters include Timing Lane Duration, Pitch Lane Transpose, Shape, and Step Seq Value.

Copy/Paste

You can use copy/paste with:

- Layers
- Programs
- LFOs
- Envelopes
- Kaoss Physics
- Filter & Amp Key Track
- Mod Processors
- Individual effects (Pre FX, Mod FX, Delay, Reverb, and Master EQ)
- Filter settings
- Arpeggiator settings
- Motion Sequence Steps

For example, you can copy from one LFO to another in the same Program, or copy the Filter or Arpeggiator settings from one Layer to another.

Using Copy/Paste

To use copy and paste with anything other than Motion Sequence Steps:

- 1. Right-click (or control-click on MacOS) on the title of the section that you'd like to copy, such as Filter LFO, Arpeggiator, or Mod Processor 2.**

A contextual menu will appear.

- 2. Select Copy from the contextual menu.**

- 3. Right-click (or control-click on MacOS) on the title of the section to which you'd like to Paste.**

Note that this has to be the same type as the copy source; for instance, you can't copy an LFO to an Envelope.

- 4. Select Paste from the contextual menu.**

Copy/Paste for Motion Sequence Steps

Motion Sequence Steps support Copy and Paste, as well as Cut, Insert Before, Insert After, and Delete. Shift-click to select a range of Steps, or select multiple non-continuous items by holding down the Command key on MacOS, or the Ctrl key in Windows. Once you've selected the desired step(s), right-click (or control-click on MacOS) to bring up the contextual menu and choose the desired copy/paste operation. For details, see “Motion Sequence Steps contextual menu” on page 45.

Randomize

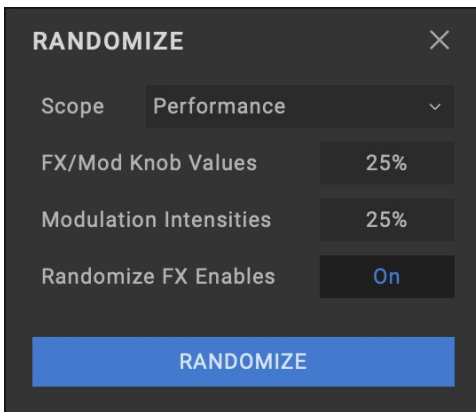

Randomize uses a combination of preset selection and select value randomization, rather than direct randomization of all parameters.

To use Randomize:

1. Press the  (Randomize) button at the top right of the window.

The Randomize dialog will appear.

2. Set the Scope as desired.

Scope controls the parts of the sound that will be randomized. It's set to *Performance* by default, but can be set to Program Select, Layer, Motion Sequence Select, Arpeggiator, Filter, and so on.

Depending on the Scope, additional settings may appear:

Fx/Mod Knob Values randomizes the Mod Knobs (Program and/or Performance, according to **Scope**) and Effects Edit 1/2/3 by the specified percentage.

Modulation Intensities randomizes the standard LFO and Envelope intensities for Filter, Amp, Pitch, and Pan.

Randomize Fx Enables controls the On/Off settings for the Effects (with probability weighted towards On).

Speed randomizes Motion Sequence Speed.

3. Press the Randomize button to randomize the selected Scope.

You can play the sound, and randomize repeatedly, without closing the Randomize window.

Main Menu

This menu gives access to overall settings such as CC assignments and the User Sample Bank, undo/redo, user interface size scaling, “About” information, and Librarian-specific commands. Open the main menu by clicking on the three vertical dots at the top-right of the window:

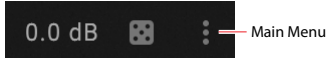

Settings

This opens the Settings dialog, which includes Set List and User Sample Bank selection, Global Scales, CC assignments, and more. See “Settings” on page 18.

Audio/MIDI Settings (standalone only)

This includes audio output and MIDI input/output settings for the stand-alone application.

User Sample Banks...

This opens the User Sample Banks dialog, which sets the folder from which User Sample Banks are loaded. See “User Sample Banks” on page 22.

Size

[50%...150%]

This scales the entire user interface to be smaller or larger.

Import...

This is available only when the Librarian is active. It imports one or more files from disk. For more information, see “Importing data” on page 88.

Export Bundle of All User Sounds...

This is available only when the Librarian is active. It exports a bundle of all non-write-protected data, for backing up or transferring all of your custom sounds at once.

Undo

Returns to the state prior to the previous operation. This applies to any edits made in the Editor windows - for instance, editing synthesis parameters, Motion Sequences, or effects, creating modulation routings, and so on. In the Librarian, it applies to edits of metadata (such as names and categories), Set List edits, creation of new Set Lists, object duplication and deletion, and data Import. The system supports multiple undos, so that you can step backwards and forwards through a series of actions.

Undo/redo history is maintained separately for the Librarian and Edit modes. The names of the undo/redo commands change to reflect this; for example, “Editor Undo: Value Change: Cutoff” or “Librarian Undo: Update Name.”

Redo

Returns to the state prior to executing the “Undo” command. The system supports multiple redos, so that you can step backwards and forwards through a series of actions.

Open Online Manual

This opens the latest version of the PDF manual in your browser.

Open Help Center

This opens the Korg app Help Center (<https://support.korguser.net>) in your browser.

About

This shows the software version number and abbreviated credits. modwave native is the result of a team effort, built through the talents of many more people than can be listed on-screen!

Settings

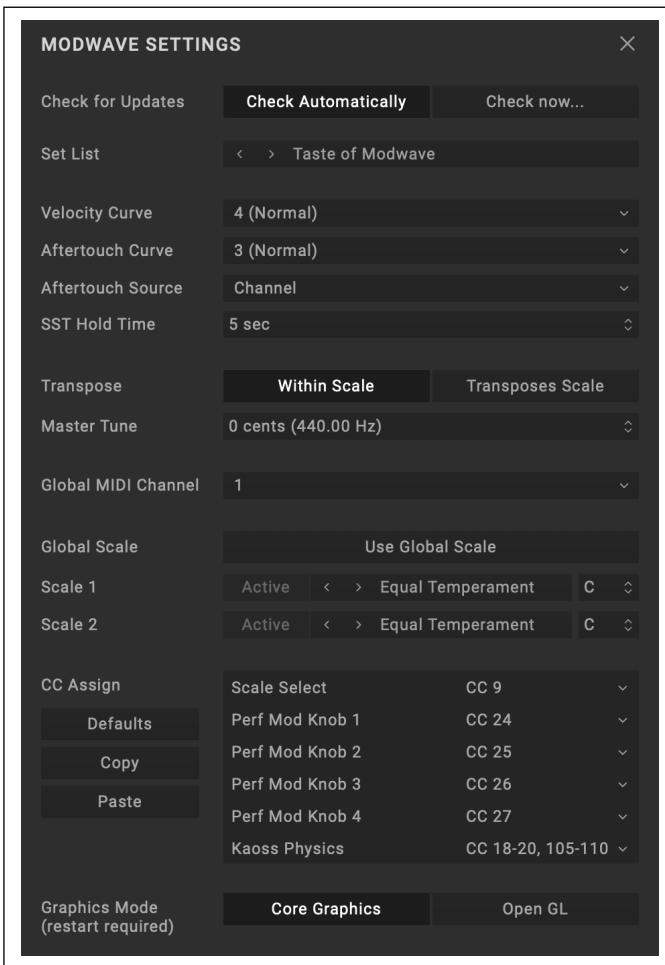

Open this dialog using the **Settings** selection in the Main Menu.

Check for Updates

[*Check Automatically, Check now...*]

Check Automatically: When this is enabled, the software checks at startup to see if a new version is available. If so, a dialog appears with a download link.

Check now...: When this is pressed, the software checks for a new version immediately.

Set List

[*List of Set Lists*]

This selects the active Set List. You can store many Set Lists, and change between them as you like. You can also set this by using the **Make Active** command in the Librarian's contextual menu.

Velocity Curve

[*1 (Heavy), 2, 3, 4 (Normal), 5, 6, 7, 8 (Light), 9 (Wide)*]

This controls how the volume and/or tone responds to variations in keyboard playing dynamics (velocity). Choose the curve that is most appropriate for your controller, playing strength and style.

Velocity curve

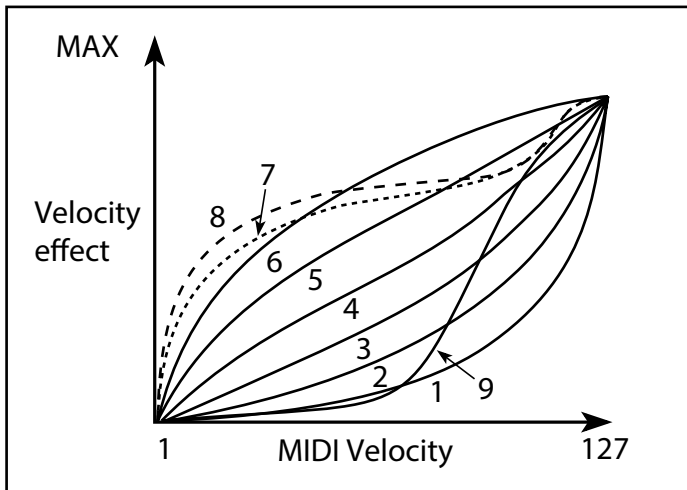

- 1 (Heavy), 2, 3: These are for heavy playing; most of the variation occurs in the upper velocity range.
- 4 (Normal): This is the default.
- 5, 6: These are for lighter playing.
- 7: This is for very light playing, at the expense of control in the middle of the range.
- 8 (Light): This curve produces the most uniform output, for when velocity sensitivity is not desired.
- 9 (Wide): This curve is designed for the heavier touch of weighted keyboards.

Aftertouch Curve

[1 (Heavy), 2, 3 (Normal), 4, 5 (Light), 6 (24-step), 7 (12-step), 8 (Random)]

This setting controls how the sounds respond to variations in pressure applied to the keyboard while playing a note (aftertouch). Choose the curve that is most appropriate for your controller, playing strength and style.

Aftertouch curve

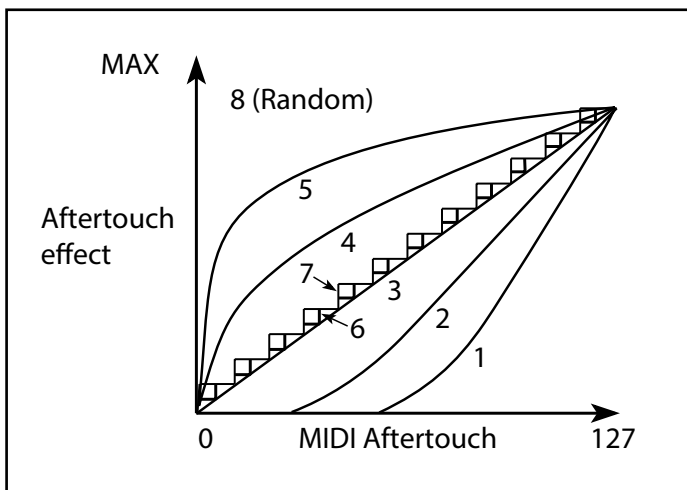

- 1 (Heavy), 2: These are for heavy playing; most of the variation occurs with stronger pressure.
- 3 (Normal): This is the default.
- 4, 5 (Light): These produce changes even with light pressure.
- 6 (24-step), 7 (12-step): These curves result in 24 or 12 steps, respectively. If Aftertouch is modulating pitch with an intensity of one octave, 7 (12-step) lets you use Aftertouch to play a chromatic scale. (For similar results, you could also use a Mod Processor set to Quantize.)
- 8 (Random): This is a random curve. Use this to create special effects, or for applying unpredictable modulation.

Aftertouch Source

[Off, Channel, Poly, Channel+Poly]

This lets you instantly re-configure the synth to take advantage of controllers with Poly Aftertouch.

Off: All aftertouch will be ignored.

Channel: The mod source “Aftertouch” receives Channel Aftertouch. Poly Aftertouch can still be used via the dedicated Poly AT mod source.

Poly: The mod source “Aftertouch” receives Poly Aftertouch. Channel Aftertouch is ignored.

Channel+Poly: The mod source “Aftertouch” receives both Channel and Poly Aftertouch. If both are sent simultaneously, the most recent value is used.

SST Hold Time

[0 ms...60 sec]

This controls the duration of Smooth Sound Transitions. It sets how long reverbs, delays, and note releases continue to ring out after a new sound has been selected. The timer starts after all notes from the previous sound are no longer being held down, and the sustain pedal is released.

Transpose

[Transposes Scale, Within Scale]

This parameter determines how the Performance and Program **Transpose** parameters interact with the Scale and Key.

Within Scale means that transposition uses intervals within the current scale. This option works well if you are using non-equal-tempered scales and want to build parallel intervals (such as “fat fifths”) into your sounds. For example, let’s say that you are using Just Intonation in the key of C. If you transpose one of the Programs up by 7 semitones and play a C, the result will be two notes: C, and G 2 cents sharp (the Just Intonation fifth).

Transposes Scale means that the Scale’s Key changes to match the transposition. This option is useful if you play in non-equal-tempered scales and transpose entire songs—to accommodate singers, for example. In other words, let’s say that the **Key** is set to C, and the third note of the scale (E) is 50 cents flat. If you transpose up by 2 semitones, and play an E, the result will be an F# 50 cents flat—still the third note of the scale.

Master Tune

[-50 (427.47Hz)...+50 (452.89Hz)]

This adjusts the overall tuning in one-cent units, over a range of ± 50 cents. (A cent is 1/100 of a semitone.) At the default of 0, A4 = 440 Hz.

 The value shown for A4’s frequency assumes that the scale is set to Equal Temperament. If a different scale is selected, the actual frequency of A4 may be different.

Global MIDI Channel

[1...16]

This is the basic MIDI channel for modwave native. It applies to:

- MIDI received by any Layer with **Use Global MIDI Channel** enabled
- Program Change (via Set Lists)
- Other global functionality, such as modulation of Mod Knobs, Master Reverb, and Kaoss Physics

Global Scale

[Off, On]

On: The settings on this page control the instrument’s scales. Performance scales are ignored.

Off: The scale settings on this page are ignored.

Note: If both **Global Scale** and **Performance Scale** are *Off*, the system simply uses equal temperament.

Active Scale, 1 (Scale 1), (Key), 2 (Scale 2), (Key)

When **Global Scale** is *On*, these control the scale being used. For details on the scale parameters, see “Active Scale” on page 54.

CC Assign

Kaoss Physics (Kaoss Physics MIDI Control)

[18-20, 105-110; 18-20, 114-119; 102-110; 111-119]

You can control Kaoss Physics from the x/y pad of a modwave keyboard running software version 1.1.2 or later. Make sure that the modwave's Kaoss Physics setting, on the MIDI CC Assign page, matches the setting here! Note that the hardware has an additional option to use SysEx, which is not supported by modwave native (since DAWs don't generally pass SysEx messages to plug-ins). MIDI control works similarly to plug-in automation; for more information, see "Kaoss Physics automation" on page 61.

18-20, 105-110: This is the default. See the chart below for specific CC assignments.

18-20, 114-119; 102-110; 111-119: These are alternative CC assignments, in case the default conflicts with other MIDI gear.

18-19 + SysEx: This is the old combination of CCs and SysEx, for compatibility with old sequencer data.

Kaoss Physics CC Assignments

	18-20, 105-110	18-20, 114-119	102-110	111-119
X Position MSB	18	18	102	111
Y Position MSB	19	19	103	112
Touched On/Off	20	20	104	113
X Position LSB	105	114	105	114
Y Position LSB	106	115	106	115
X Velocity MSB	107	116	107	116
X Velocity LSB	108	117	108	117
Y Velocity MSB	109	118	109	118
Y Velocity LSB	110	119	110	119

Scale Select and Mod Knob 1-4

You can control Scale Select and each Mod Knob directly from MIDI CCs. Unlike normal modulation, this works by directly editing the Scale Select parameter and the Mod Knob values, and any changes will be saved with the sound. To modulate a parameter with variable intensity, and without causing edits to the sound, use modulation instead. For Mod Knobs, you can use MIDI Learn to assign the CCs; see "MIDI Learn" on page 14.

Function	Default CC assignment
Scale Select	9
Mod Knobs 1...4	24...27

Defaults

Pressing the Defaults button resets the CC assignments to the defaults, as shown above.

Copy and Paste

These buttons let you copy and paste the CC assignments between plug-in instances.

Graphics Mode (macOS only)

[Core Graphics, Open GL]

This appears only on macOS. It selects the method used for graphics rendering, which can significantly affect both CPU and GPU usage. Generally speaking, *Core Graphics* is recommended for Apple Silicon-based hardware (such as M1 and M2 processors), and *Open GL* is recommended for Intel-based hardware.

All instances of modwave native must be re-loaded before changes take effect; a reliable way to do this is to restart your DAW.

Core Graphics: Graphics rendering will use Core Graphics. Recommended for Apple Silicon-based hardware.

Open GL: Graphics rendering will use Open GL. Recommended for Intel-based hardware.

User Sample Banks

User Sample Banks let you add more Multisamples to the system. You can create your own Banks, or use Banks from third party sound developers.

modwave native can load many User Sample Banks simultaneously. Note that the hardware modwave can load only one at a time; this is the only significant difference between the hardware and modwave native. All of the Banks must be placed in a single, user-specified folder. To set the location of this folder:

1. Select User Sample Banks... from the main menu.

The User Sample Banks dialog will appear.

User Sample Banks dialog

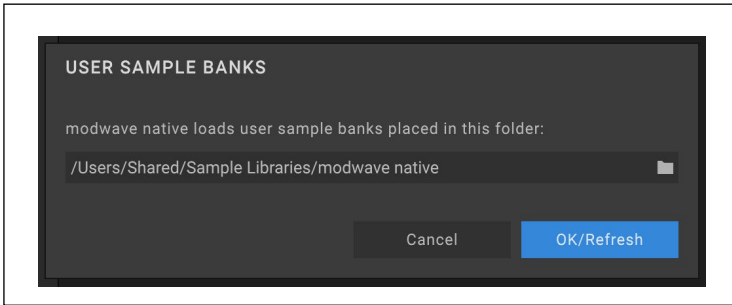

2. Click in the “folder” field (starting with “/Users” in the screen-shot above).

A standard file dialog will appear.

3. Select the desired folder, or create a new one.

All User Sample Banks must be placed at the root level of this folder; sub-folders are not supported. This folder should be located on an SSD, as opposed to a rotational hard drive. Up to 65,535 Banks are supported; note that very high numbers of bank files may cause noticeable slowness when checking the contents of the folder and adding Banks (see “How is the list of User Sample Banks updated?” on page 22).

Adding User Sample Banks

To add a User Sample Bank:

1. Move the .korgcompiledbank file(s) to the folder selected in the User Sample Banks... dialog.

If modwave native isn't already running, then the User Sample Banks will be added to the database automatically the next time it starts up. If modwave native is already running, then take one more step:

2. Open the User Sample Banks... dialog, and press OK/Refresh.

How is the list of User Sample Banks updated?

Every time modwave native instantiates, it checks the contents of the selected folder. If there has been a change in the number of files, or the names, sizes, or modification dates of the files, the User Sample Bank portion of the database will be cleared (to remove potentially obsolete references); all of the bank files in the folder will then be added to the database. With modern computers and SSDs, and a reasonable number of Banks, this should be completed very quickly.

Pressing OK/Refresh in the “User Sample Banks...” dialog also goes through the process above. Use this to update the database if you've added files to the folder while modwave native is already running.

Individual Multisamples are identified by UUID (see the Sample Builder manual for more details), and not by the Bank which contains them. This means that it's possible for the same Multisample to be included in multiple Banks. If this happens, the Multisample is loaded only once, from the last-added Bank (Banks are added in alphabetical order: 0-9, A-Z, a-z). The selected Multisample's source Bank is shown at the bottom of the Inspector in the Sound Browser.

Creating User Sample Banks

User Sample Banks are created by the separate Sample Builder application, which is available as a free download from www.korg.com. After creating or importing Multisamples, use Sample Builder's **Save Bank For Plug-in** command to create a .korgcompiledbank file which can be used by modwave native. For more information, please see the documentation included with the Sample Builder download.

Synthesis page



For information on all of the standard Edit page elements, see “Edit pages” on page 7.

1. Oscillator Mode

This three-way switch controls the basic capabilities of the current Oscillator. *A* plays a single Wavetable, *A/B* plays a blend of two phase-synchronous Wavetables, and *Sample* plays a Multisample.

2: Program Select

This is the Program assigned to the Layer (see “Structure” on page 2). Programs contain all of the settings in the Synthesis, Sequencer, and Effects pages. Use the < and > arrows to step through Programs one by one, or click on the name to bring up a browser window. Right-click/control-click (macOS) on the name to bring up a contextual menu for saving and renaming.

3: Layer Select

These select a Layer to view and edit. The power buttons turn the Layers on and off. When a Layer is selected, its Synthesis, Motion Sequence, Arp & Setup, and Effects tabs appear below. The edit pages are color-coded to match the layer; A is purple, and B is green.

4: Osc Select

The large tabs on the side, labeled 1 and 2, select which of the two oscillators is shown.

5: A/B Blend

This appears only if **Mode** is set to *A/B*. It controls the balance between Waves A and B. For more information, see “A/B Blend” on page 26.

Oscillator 1/2

Overview

Osc 1 and Osc 2 can each play either a single Wavetable, a modulatable blend of two Wavetables, or a Multisample. modwave native ships with over 200 Wavetables, and you can also import your own. The sound of the Wavetables can be changed in different ways. **Wavetable Modifiers** change the way that the tables are generated at load time, resulting in subtle to extreme changes in timbre. **Morph Types** change the way that the Wavetables are played, and can be modulated in real-time from Envelopes, LFOs, and so on.

Oscillator Mode

[A, A/B, Sample]

This three-way switch controls the basic capabilities of the Oscillator.

A: The Oscillator will play a single Wavetable.

A/B: The Oscillator will play a blend of two Wavetables, A and B. Because the Wavetables are phase-synchronous, the result is truly a blend between the two shapes, rather than a simple layering effect. **A/B Blend** lets you control the balance between the two.

Sample: The Oscillator will play a Multisample.

A and A/B Modes

Wave A (Wavetable A)

[List of Wavetables]

This selects the main Wavetable, and appears if **Oscillator Mode** is set to *A* or *A/B*. Use the < and > arrows to step through Wavetables one by one, or click on the name to bring up a browser window. For more information, see “Selectors” on page 2, and “Sound Browser” on page 9.

Listening to the Wavetables

When auditioning Wavetables, play lower-pitched notes. The lower the pitch, the more clearly you’ll hear all of the high harmonics.

By default, the Osc 1 and Osc 2 Envelopes modulate **Position**; this sweeps the Wavetables for their respective oscillators. **Attack** sweeps forward in the Wavetable, and **Decay** sweeps backwards; the **Sustain** level determines the resting point. Try both fast and slow envelope times for both **Attack** and **Decay**—even 10 or more seconds may be useful for particularly complex Wavetables!

Adjust the amount of modulation using **Env Intensity**. Sometimes, you may want the intensity to be at its maximum; other times, especially with more complex Wavetables, much smaller amounts of modulation may be better.

Some Wavetables may be optimized for use with an LFO, to repeatedly sweep **Position** back and forth. To set this up:

1. **Set an LFO to use a Triangle wave.**
2. **Drag the LFO to the Position knob, to create a modulation routing.**
3. **Set Position to 50, and LFO Modulation Intensity to 100.**

Mod A (Wavetable A Modifier)

[None... Gain -6 dB]

Each waveform in a Wavetable is stored as a single 32-bit floating-point table with 2048 samples, referred to below as the “base table.” This corresponds to a pitch of about 25 Hz. Tables for higher pitches are generated when the Wavetable is loaded. The Wavetable Modifier options let you change how these tables are generated, creating different-sounding variations of the stored data.

None: The Wavetable is loaded without alteration.

Odd Only: This preserves only the odd harmonics. All even harmonics (2, 4, 6, etc.) are removed.

Even Only: This preserves the fundamental and all the even harmonics. All odd harmonics (3,5,7, etc.) are removed. The result can sound like a sine wave at the fundamental plus a waveform an octave above that.

Skip Every 3: This removes every third harmonic (3, 6, 9, etc.).

Odd + Clip: This combines *Odd Only* and *Hard Clip*, producing a brighter version of the Wavetable with increased overtones and only odd harmonics.

Synthesis page

Even + Clip: This combines *Even Only* and *Hard Clip*, producing a brighter version of the Wavetable with increased overtones with only even harmonics.

Skip + Clip: This combines *Skip Every 3* and *Hard Clip*, producing a brighter version of the Wavetable with increased overtones and with every third harmonic removed.

Low 20: This removes all but the lowest 20 harmonics.

Low 12: This removes all but the lowest 12 harmonics.

Organ-ize: This emphasizes the harmonics that correspond to organ drawbars: 1 (8'), 2 (4'), 3 (2 2/3'), 4 (2'), 5 (1 3/5'), 6 (1 1/3'), and 8 (1'). The other harmonics are still present, but greatly reduced. The result is drawbar organ sounds with "stops" based on the Wavetable.

Vintage 8: This quantizes to 8 bits and disables band-limiting for all but the highest notes, resulting in a brighter sound with higher noise and significant aliasing.

Vintage 12: This quantizes to 12 bits and disables band-limiting for all but the highest notes, resulting in a brighter sound with moderate amounts of noise and aliasing.

4 Steps: Quantizes the base table to 2 bits, using band-limiting to minimize aliasing (so, you'll notice that the displayed waveform is smoother than a simple 2-bit waveform).

8 Steps: Quantizes the waveform to 3 bits, similar to *4 Steps*, above.

16 Steps: Quantizes the waveform to 4 bits, similar to *4 Steps*, above.

Soft Clip: Applies gentle soft clipping to the base table, adding overtones and increasing brightness.

Hard Clip: Applies a gain of 3.0 and then clips the result, for a greater increase in overtones and brightness.

Infinite Clip: Applies a ridiculous amount of gain, then clips the result.

Note that *Soft Clip*, *Hard Clip*, and *Infinite Clip* are very different from applying clipping to the audio output. The timbre isn't affected by the oscillator level or the number of voices being played, and the results are band-limited to avoid harsh tones.

Tilt Up: This reduces the levels of lower harmonics, and increases the levels of higher harmonics, tilted around the 12th harmonic.

Tilt Up +: Similar to *Tilt Up*, but more extreme.

Tilt Down: This increases the levels of lower harmonics, and reduces the levels of higher harmonics, tilted around the 12th harmonic.

Tilt Down +: This increases the levels of lower harmonics, and reduces the levels of higher harmonics, tilted around the 8th harmonic.

Low Boost: Boosts the first 5 harmonics.

Low Cut: Reduces the fundamental and first few harmonics.

Low Cut +: Reduces the first 5 harmonics.

Muted: Dramatically lowers the level of all harmonics above the fundamental.

Fade Out: Crossfades successive waves in the Wavetable with 0 so that the waveform fades out to 0 as Position increases. Use this to create decaying plucked or percussive sounds just by sweeping the Position.

Reverse: Loads the Wavetable's individual waves in reverse order. This is particularly useful for Wavetables which sweep from a bright or complex sound on one end to a dark or simple sound on the other.

Gain +3 dB, *Gain +6 dB*, *Gain -3 dB*, *Gain -6 dB*: Increase or decrease gain by the specified amounts. These are particularly useful for balancing the volume between Wavetables A and B.

Wave B (Wavetable B)

[List of Wavetables]

This selects the Wavetable for Wave B; it appears only if **Oscillator Mode** is set to *A/B*. **A/B Blend** then controls the mix of Wavetables A and B.

Mod B (Wavetable B Modifier)

[None... Gain -6 dB]

This selects the Modifier for Wave B; it appears only if **Oscillator Mode** is set to *A/B*.

A/B Blend

[0.00...100.00]

This appears only if **Mode** is set to *A/B*. It controls the balance between Waves A and B. Use this to combine characteristics of two different Wavetables (such as a pure-sounding table and a buzzy-sounding one), or the same Wavetable processed by two different **Wavetable Modifiers**.

Tip: Fade between modified and original versions of a Wavetable

1. Set **Mode** to *A/B*.
2. Select the same **Wavetable** for both **A** and **B**.
3. Make sure that **B Offset** is set to 0.00.
4. Set **Wavetable A Modifier** to **None**.
5. Set **Wavetable B Modifier** as desired (for instance, **Hard Clip**).
6. Use **A/B Blend** to fade between the normal and modified versions.

With *Hard Clip*, this will create a sound similar to a low-pass filter. Try modulating **A/B Blend** via an Envelope or LFO! Since Wavetables A and B are phase-locked, you can use this technique to fine-tune the effects of any of the Modifiers. For example, try using this with any of the *Tilt*, *Boost*, or *Cut* options.

Position

[0.00...100.00]

Wavetables contain up to 64 waveforms. **Position** sweeps through all of the waveforms in the Wavetable. 0.00 always selects the first waveform, and 100.00 selects the last waveform. The range between these extremes is divided between the total number of waveforms in the selected Wavetable, as shown below.

Note that when **Mode** is set to *A/B*, Wavetables A and B may have different numbers of waveforms. In this case, **Position** will divide the range evenly for each Wavetable, just as if they were being used individually. For instance, if A has four waveforms and B has 23 (see the graphic below), a **Position** just under 50 will play waveform 2 in A, and waveform 12 in B.

Position

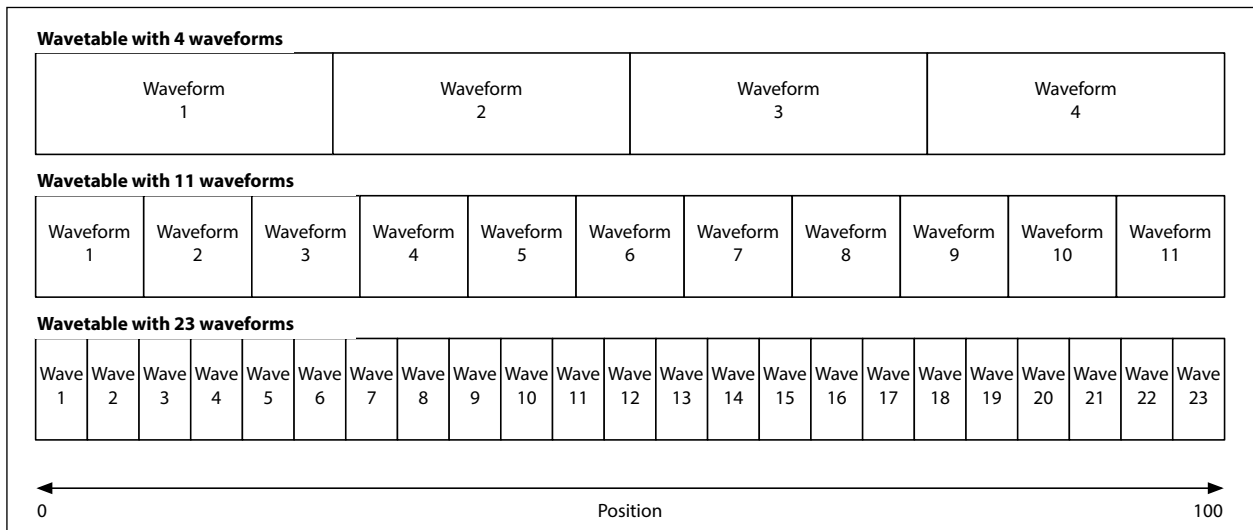

Envelope (Osc 1/2 Envelope Intensity)

[-100.00...+100.00]

This sets the amount of **Position** modulation from the Osc 1 Envelope (for Osc 1) or the Osc 2 Envelope (for Osc 2).

Vel-Env

[-100.00...+100.00]

This lets you use velocity to scale the amount of **Position** modulation from the Osc 1 Envelope (for Osc 1) or the Osc 2 Envelope (for Osc 2).

Xfd Width (Crossfade Width)

[0.00...100.00]

As the **Position** changes, the Wavetable changes from one waveform to another. When changing between two adjacent waveforms, the transition can be gradual or immediate. **Xfade Width** controls the amount of the **Position** range spent interpolating between neighboring waveforms vs. the amount playing single waveforms. Note that this does not affect **A/B Blend**.

It may be helpful to think of the **Position** value range 0-100 as a ribbon, with the Wavetable stretched to fit, regardless of how many waveforms it contains. Each waveform is a stripe on the ribbon. **Xfade Width** controls the amount of blurring between the stripes. A given value for **Position** will always yield the same output, which will be either a solid stripe or some amount of blurring between two stripes. When **Position** changes continuously, as with an envelope or LFO, this causes crossfades between the waveforms.

Xfade Width

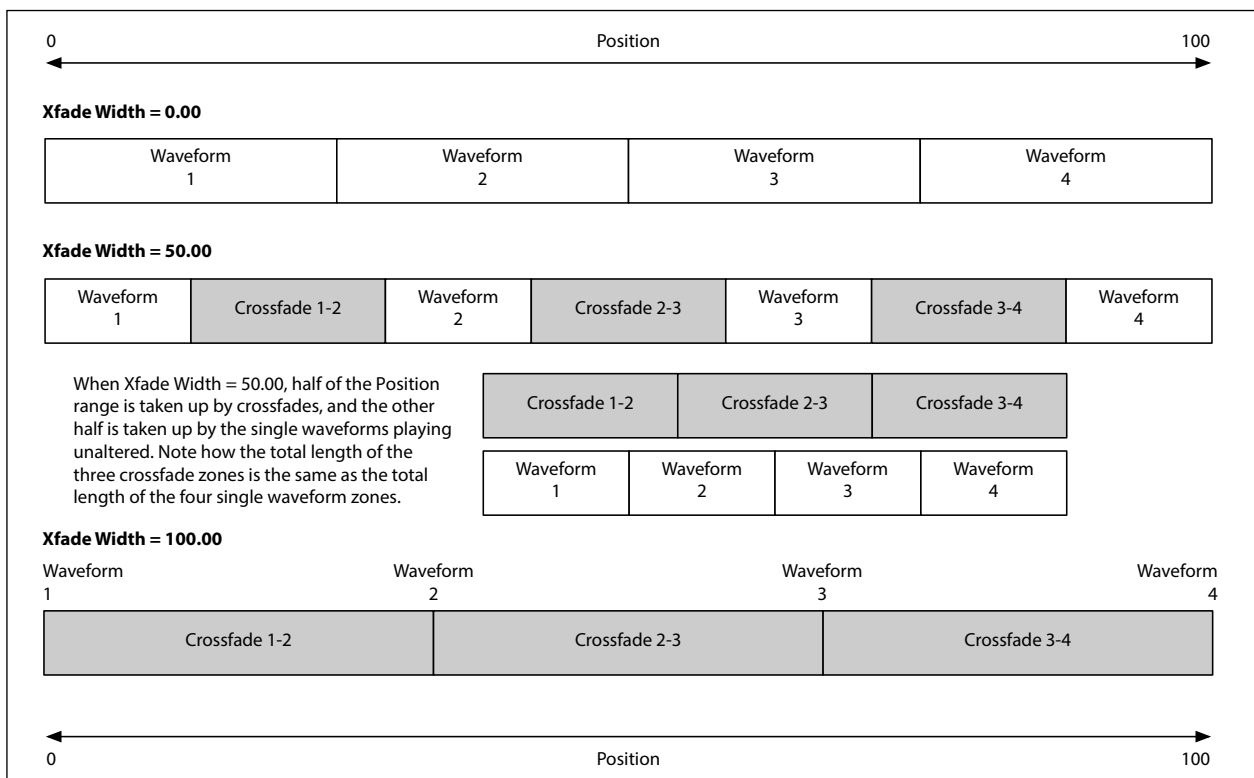

B Offset

[0.00...100.00]

This appears only if **Mode** is set to A/B. It shifts the position of Wavetable B in relation to Wavetable A, allowing for flexibility when combining Wavetables via A/B Blend. For example, you might want to blend the first half of Wavetable A with the second half of Wavetable B.

From a technical perspective, the position of Wavetable B is the sum of **Position** and **B Offset**.

Sample Mode

(Multisample)

[List of Multisamples]

This selects a Multisample for the Oscillator. Use the < and > arrows to step through Multisamples one by one, or click on the name to bring up a browser window.

Start Offset

[Off, 1st...8th, n/a]

In addition to simply starting playback from the beginning, Multisamples may have up to 8 different pre-programmed alternate starting points, or "Start Offsets." These skip part of the beginning of the samples, either to make them more

gentle (for percussive sounds) or to make them start more quickly (for sounds with slow attacks). The number of available offsets will vary depending on the specific Multisample.

If no alternate start points are available, this will show *n/a*.

Channel

[Stereo, Left, Right, n/a]

This applies to stereo Multisamples only; for mono Multisamples, “n/a” is shown. You can choose whether to use the original *Stereo* signal, or only the *Left* or *Right* channels (in mono).

Morph

Morph Type

[List of Morph Types]

The **Morph Types** let you stretch, squeeze, reflect, and otherwise alter the Wavetables in real-time, changing their timbre and—when modulated—creating additional motion in the sound.

When the Oscillator Mode is set to Sample, the **Morph Type** options are limited. For Oscillator 1, Morph is completely unavailable. For Oscillator 2, only *AM* and *Ring Mod* are available.

None: The Wavetable is played unaltered.

Sync: The Wavetable is reset by a phantom oscillator, creating the classic sync sound. Morph Amount controls the frequency of the phantom oscillator.

Windowed Sync: Similar to Sync above, but with reduced high frequencies for lower aliasing.

Stretch: The waveform is stretched in one direction and squeezed in the other, creating an effect similar to Pulse Width Modulation. When Morph Amount is set to 50, the waveform is unaltered.

Flip: This inverts the polarity of a section of the waveform, with the “flip” point determined by Morph Amount.

Mirror: Shrinks the waveform to half its length, and then reflects that half-length waveform around the center as a mirror image. Morph Amount stretches and squeezes the waveform similar to Stretch, above.

Mirror Stretch: This is similar to Mirror, above, but doubles the Stretch effect.

Narrow: As Morph Amount increases, the waveform is compressed towards the front, with zeros filling the rest of the duty cycle. The effect is different from Stretch, but also has some similarities to Pulse Width Modulation.

Narrow Stretch: This combines Narrow and Stretch, compressing the waveform’s length while also stretching and squeezing.

Windowed Narrow: Similar to Narrow above, but with reduced high frequencies for lower aliasing.

W.NarrowStretch: Similar to Narrow Stretch above, but with reduced high frequencies for lower aliasing.

Additional Osc 2 Morph Types

Osc 2 supports all of the **Morph Types** listed above, and three more: *FM*, *AM*, and *Ring Mod*. For all of these, Oscillator 1 is the modulator, and Oscillator 2 is the carrier. If you’re using Oscillator 1 solely as a modulator, you may wish to set its **Level** to 0%.

Note: when using these Morph Types, the waveform graphic will be an approximation.

FM: Oscillator 1 modulates the frequency of Oscillator 2. Morph Amount controls the amount of frequency modulation.

AM, or amplitude modulation, includes both ring modulation, as below, and the dry signal from Oscillator 2. Morph Amount controls the amount of amplitude modulation.

Ring Mod combines the two Oscillators to generate new sideband frequencies based on those inputs. The result can be everything from subtle brightening to wild, dissonant, gong-like timbres. When the frequencies of Oscillators 1 and 2 are the same, the Ring Modulator produces steady, constant waveforms. When they are detuned, it produces more movement and overtones. Morph Amount controls the amount of ring modulation.

Morph (Amount)

[0.00... 100.00]

This controls the intensity of the **Morph** process, as described above.

LFO (Intensity)

[-100.00...+100.00]

This sets the intensity of the **Morph** modulation from the Osc 1 LFO (for Osc 1) or the Osc 2 LFO (for Osc 2).

Pitch and Phase

Octave

[-2, -1, 0, +1, +2]

This sets the basic pitch of the Oscillator, in octaves. The default is 0.

Transpose

[-12...+12]

This adjusts the pitch of the Oscillator in semitones, over a range of ± 1 octave. For Multisamples this also affects the index into the Multisample map, potentially changing the sample selection, similar to transposing the entire keyboard.

Tune

[-12.00...+12.00]

This adjusts the pitch of the Oscillator in semitones with high resolution (good for continuous modulation), over a range of ± 1 octave.

Phase

[-180...+180]

This controls the phase of the waveform at the start of the note. It's most useful when Oscillators 1 and 2 are not detuned. **Phase** is not available when **Mode** is set to *Sample*.

Filter

Type

[Polysix, MS-20 LP, MS-20 HP, 2-pole LP, 2-pole HP, 2-pole BP, 2-pole BR, 4-pole LP, 4-pole HP, 4-pole BP, 4-pole BR, Multi Filter]

LP (Low Pass). This cuts out the parts of the sound which are **higher** than the cutoff frequency. Low Pass is the most common type of filter, and is used to make bright timbres sound darker.

HP (High Pass). This cuts out the parts of the sound which are **lower** than the cutoff frequency. You can use this to make timbres sound thinner or more buzzy.

BP (Band Pass). This cuts out all parts of the sound, both highs and lows, except for the region around the cutoff frequency. Since this filter cuts out both high and low frequencies, its effect can change dramatically depending on the cutoff setting and the oscillator's Multisample or Wavetable.

With low resonance settings, you can use the Band Pass filter to create telephone or vintage phonograph sounds. With higher resonance settings, it can create buzzy or nasal timbres.

BR (Band Reject). This filter type—also called a notch filter—cuts only the parts of the sound directly around the cutoff frequency. Try modulating the cutoff with an LFO to create phaser-like effects.

2-pole LP, HP, BP, and BR: These produce 12dB/octave slopes for LP and HP, and 6dB/octave for BP and BR. A classic synthesizer expander module used this type of filter.

4-pole LP, HP, BP, and BR: These produce 24dB/octave slopes for LP and HP, and 12dB/octave for BP and BR. In comparison to 2-pole filters, these create a sharper roll-off beyond the cutoff frequency with more delicate resonance. Many classic analog synths used this general type of filter.

Multi Filter. This is a complex filter which is capable of all of the 2-pole filter types, and many more besides. See “Multi Filter” on page 31.

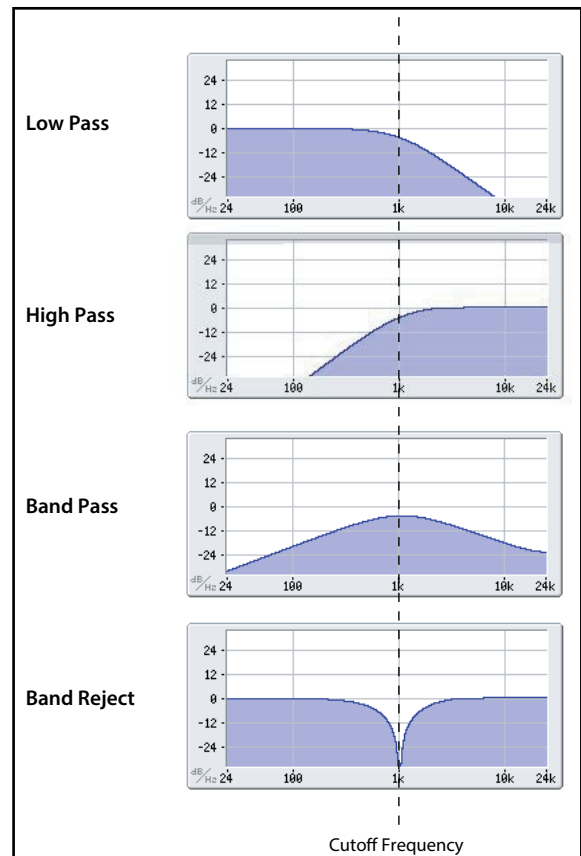

MS-20 LP and HP: These 12dB/octave, self-resonating filters lovingly recreate the distinctive timbral signature of the classic Korg MS-20. Raising **Resonance** will cause increasing amounts of saturation and overdrive, creating a more aggressive tone. Input volume can have a strong effect on this character; for more information, see “Gain” on page 31.
Polysix: This 24dB/octave, self-resonating low-pass filter provides the strong, sweet sound of the classic Korg Polysix.

Cutoff

[-4.00 or +8.00...+136.00 or +138.00 semitones]

This controls the cutoff frequency of the filter, in semitones mapped to MIDI note numbers (60.00 = middle C). The frequency in Hz is also shown. The specific effect of the cutoff frequency will change depending on the selected **Type**, as described above. Most filter types have a range of -4.00 to +138.00, but the *MS-20 LP/HP* and *Polysix* range from +8.00 to +136.00.

Resonance

[0.00...100.00%]

Resonance emphasizes the frequencies around the cutoff frequency, as shown in the diagram below.

When this is set to 0, there is no emphasis, and frequencies beyond the cutoff will simply diminish smoothly.

At medium settings, the resonance will alter the timbre of the filter, making it sound more nasal, or more extreme.

At very high settings, the resonance can be heard as a separate, whistling pitch.

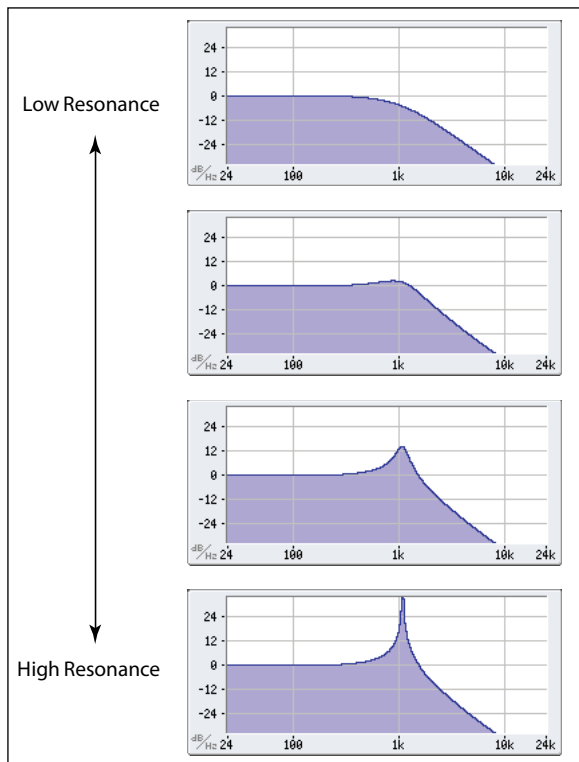

Trim

[0...100]

This adjusts the volume level at the input to the filter. If you notice that the sound is distorting, especially with high **Resonance** settings, you can turn the level down here.

Out (Output Level)

[0...100]

This controls the output level of the filter.

2-Pole LP/HP/BP/BR

(Resonance) Bass

[Full, Tight]

This is available only when **Type** is one of the *2-pole Resonant* or *4-pole Resonant* settings, or *Multi Filter*. **Resonance Bass** controls the character of the filter resonance at low cutoff frequencies. Its effect is most noticeable with high **Resonance** settings.

Tight produces a more restrained resonance, similar to a classic, American, wood-paneled monophonic synthesizer.

Full produces a wide, boomy resonance, reminiscent of a famous five-voice American synthesizer.

4-Pole LP/HP/BP/BR

Resonance Type

[Standard, High]

This is available only when the **Type** is set to one of the *4-pole* settings.

Standard provides the resonance character of a typical analog 4-pole filter.

High creates a more pronounced resonance.

MS-20 LP/HP and Polysix

Gain

[Loud, Less Resonance; Unity, Less Resonance; Normal, 1-osc input; Normal, 2-osc input]

Gain is available only when **Type** is *MS-20 LP*, *MS-20 HP*, or *Polysix*. These filter types include saturation, which interacts with resonance. With anything other than very low resonance settings, input volume can have a strong effect on their character. The *lower* the input gain, the more headroom remains for the resonance to bloom. Use **Gain** to set the basic input level, and then fine-tune with **Trim** if desired.

Normal, 2-osc input: This is the lowest input gain. It will produce the classic resonant sounds of these filters even with extremely loud input signals.

Normal, 1-osc input: This will produce the classic resonant sounds of these filters with a single oscillator playing at full volume. When input is louder than a single full-volume oscillator, the resonance effect will be less pronounced.

Unity, Less Resonance: Volume is unattenuated. This leaves less headroom, so resonance will be less prominent.

Loud, Less Resonance: This provides a slight volume boost on input. This makes it easy to reach saturation with the input level alone, leaving very little headroom for resonance.

Multi Filter

What's a Multi Filter?

Standard multimode filters generate low-pass, high-pass, and band-pass filters simultaneously—but only let you use one of them at a time. The Multi Filter gives you access to all three filter modes simultaneously, in any combination, along with the dry input signal. You can choose from a large number of preset combinations, or create your own complex filter modes using the Manual controls.

This is capable of some cool sounds in and of itself, but things really get interesting when you modulate **Crossfade**; see below..

Crossfade

[0...100]

This is available only when **Type** is *Multi Filter*. **Crossfade** morphs between the Mode 1 and Mode 2 settings. *0* is all Mode 1, *100* is all Mode 2, and *1-99* are intermediate values between the two Modes. Try modulating this with envelopes, LFOs, or real-time controllers.

Preset (Multi Filter Preset)

[List of Presets]

This is available only when **Type** is *Multi Filter*. Presets let you quickly select from a number of useful combinations of Modes 1 and 2. You can also select any combination you wish using the manual controls, described below.

Multi Filter Advanced settings

To dive even deeper into the Multi Filter, press the **Advanced** button. This appears only when Multi Filter is selected, and replaces the normal filter controls with the **Mode 1**, **Mode 2**, and **Manual** controls, as described below. To exit **Advanced** mode, press **Advanced** again.

1 (Mode 1)

[List of filter types]

This sets the filter type for Mode 1.

LP, *HP*, *BP*, and *BR* are the standard filter types. For more information, see “Filter” on page 29.

LP+BP, *LP-BP*, *LP-HP*, *BP+HP*, *BP-HP*, *Dry+LP*, *Dry-LP*, *Dry+BP*, *Dry-BP*, *Dry+LP-HP*, *Dry+LP-BP*, *Dry+BP-LP*, *Dry+BP-HP*, *Dry+HP-LP*, *Dry+HP-BP*, *LP+HP+BP*: These combine two or more filters at equal volumes. *Dry* is the unfiltered input signal. The minus sign (“-”) indicates when the phase of a filter is reversed.

All On uses the Low Pass, High Pass, Band Pass, and Dry signals at equal volumes.

Manual lets you create your own mix of the filters; an additional four parameters will appear. For more information, see “Manual,” below.

2 (Mode 2)

Mode 2 has the same selections as Mode 1.

Manual

When Mode is set to *Manual*, additional parameters appear so that you can create your own mix of the filters.

You may wonder why Band Reject is not included here. This is because it’s not a filter mode per se. Instead, it’s created by equal amounts of High Pass and Low Pass. Try it and see!

LP (Lowpass), HP (Highpass), BP (Bandpass), Dry

[-100%...+100%]

These set the volume of the Lowpass, Highpass, Bandpass, and Dry signals, respectively. Negative values invert the phase.

Filter Mod

These four parameters control the default modulation routings for Filter Cutoff. You can create additional routings as desired, of course.

LFO Intensity

[-142.00...+142.00]

This sets the amount of modulation from the Filter LFO, in semitones.

Envelope Intensity

[-142.00...+142.00]

This sets the amount of modulation from the Filter Envelope, in semitones.

Vel->Env

[-142.00...+142.00]

This lets you use velocity to scale the amount of the Filter Envelope applied to Filter Freq, in semitones.

Key Track

[-142.00...+142.00]

This controls how much the Key Track will affect the Cutoff frequency. The value is the amount, in semitones, that the filter will change over five octaves of keyboard with a standard -1.00/+1.00 slope. The overall effect of the Keyboard Track is a combination of this value and the Keyboard Track shape.

With positive values (+), the effect will be in the direction specified by keyboard tracking; if the Slope goes up, the Cutoff will *increase*.

With negative values (-), the effect will be in the opposite direction; if the Slope goes up, the Cutoff will *decrease*.

To create one-octave-per-octave key tracking (useful when creating pitch through filter resonance):

1. Set the Key Track amount to +60.00 semitones.
2. In Filter Key Track, set Low and Low-Mid Slopes to -1.00, and Mid-High and High Slopes to +1.00.

Common Pitch

These settings apply to the entire Program, including Osc 1/2 and the Sub Oscillator.

Octave

[-2, -1, 0, +1, +2]

This sets the basic pitch, in octaves. The default is 0.

Transpose

[-12...+12]

This adjusts the pitch in semitones, over a range of ± 1 octave. For Multisamples this also affects the index into the Multisample map, potentially changing the sample selection, similar to transposing the entire keyboard.

Tune

[-12.00...+12.00]

This adjusts the pitch in semitones, over a range of ± 1 octave.

Slope

[-1.0...+2.0]

This controls how pitch tracks the keyboard. Normally, it should be set to the default of $+1.0$.

Positive (+) values cause the pitch to rise as you play higher on the keyboard, and negative (-) values cause the pitch to **fall** as you play higher on the keyboard.

When **Slope** is 0, playing different notes on the keyboard won't change the pitch at all; it will be as if you're always playing C4.

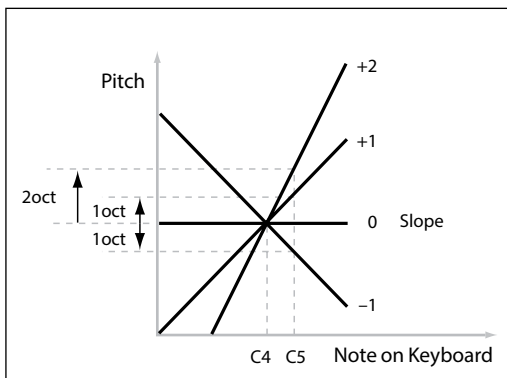

Random (Random Pitch Range)

[0.0...50.0 cents]

This creates random variations in pitch for each note. At the default of 0.0, pitch will be completely stable; higher values create more randomization. This can be helpful for simulating instruments that have natural pitch instabilities, such as analog synths, tape-loop keyboards, or acoustic instruments.

Note: **Random** is not included copy/paste for Common Pitch.

LFO (Intensity)

[-144.00...+144.00]

This controls the initial effect of the Pitch LFO on the pitch, in semitones.

To create a vibrato effect from the Mod Wheel:

1. Create a modulation routing with Mod Wheel as the source and Pitch LFO Intensity as the destination.

Internally, this will actually create a routing to Pitch Tune, with the Pitch LFO as the first source and Mod Wheel as the second.

2. Set the Intensity as desired. 1 semitone is a good starting point.

Now, raising the Mod Wheel will introduce vibrato.

Portamento

Portamento

[Off, On]

Portamento lets the pitch glide smoothly between notes, instead of changing abruptly.

On: Turns on Portamento, so that pitch glides smoothly between notes.

Off: Turns off Portamento. This is the default.

Fingered

[Off, On]

Fingered applies only when **Portamento** is *On*.

On: Playing legato will turn on portamento, and playing detached will turn it off again.

Off: Legato/detached playing will not affect portamento.

Type

[Constant Rate, Constant Time]

Constant Rate: Portamento will always take the same amount of time to glide a given distance in pitch—for instance, one second per octave. Put another way, gliding several octaves will take much longer than gliding a half-step.

Constant Time: Portamento will always take the same amount of time to glide from one note to another, regardless of the difference in pitch. This is especially useful when playing chords, since it ensures that each note in the chord will end its glide at the same time.

Time

[0.0000...50.0000 secs or secs/octave]

This controls the portamento time. If **Type** is set to *Constant Rate*, the units are secs/octave (seconds per octave). If **Type** is set to *Constant Time*, the units are simply secs (seconds).

Amp

Notes on Amp Modulation

Amp modulation scales the Amp **Level** and Amp Envelope, with an upper limit of 2x the original settings to prevent uncontrollably loud output. If the original level is low, the maximum modulated volume will also be low.

(For the technically inclined: Amp modulation is multiplicative. Modulation values are offset by +1.0, so that a value of 0 has no effect. The maximum modulation value—for example, moving the Mod Wheel all the way up—doubles the volume level if the Intensity is +100%, or brings the level to silence if the Intensity is -100%.)

Tip: To start with a low level (or silence) and then use modulation to raise the level to maximum, use the Filter **Output Level** instead.

Level

[0%...100%]

This sets the basic volume of the Program, optimized for per-voice modulation. For adjusting the volumes of Programs within a Performance, it's better to use the Layer **Volume** instead.

Amp LFO Intensity

[-100%...+100%]

This controls the amount of modulation from the Amp LFO.

Velocity

[-100%...+100%]

This reduces volume according to velocity.

With *positive* (+) values, the volume decreases as you play softer.

With *negative* (-) values, the volume decreases as you play harder.

Key Track

[-100%...+100%]

This adjusts the intensity of Key Track's effect on the level. For more information, see "Key Track" on page 70.

Pan

Pan

[L100...L1, C0, R1...R100]

This sets the left-right pan. Note that this can be modulated per voice!

Random Pan

[Off, On]

Off: The normal pan controls, above, apply.

On: Each voice will be randomly panned across the stereo field. All other pan controls are disabled.

Motion Sequencing 2.0

Overview

Motion Sequencing 2.0 is evolved from the wavestate's Wave Sequencing 2.0. Sequences run individually for each voice. Timing, Pitch, Shape, and four sets of Step Sequence values (Seq A-D) are separated into "Lanes." Each lane can have a different number of Steps, its own **Loop Start** and **Loop End**, and its own loop direction or step order randomization. Each Step in each Lane even has its own **Probability**.

Loop points, Step Probabilities, and other parameters in the lanes and their steps can be modulated on a per-note basis, using velocity, LFOs, envelopes, etc. Each time the sequence moves forward, values from the individual lanes are combined to create the output. The result can be either ever-changing rhythmic patterns or smooth, organic modulations.

Motion Sequencing 2.0

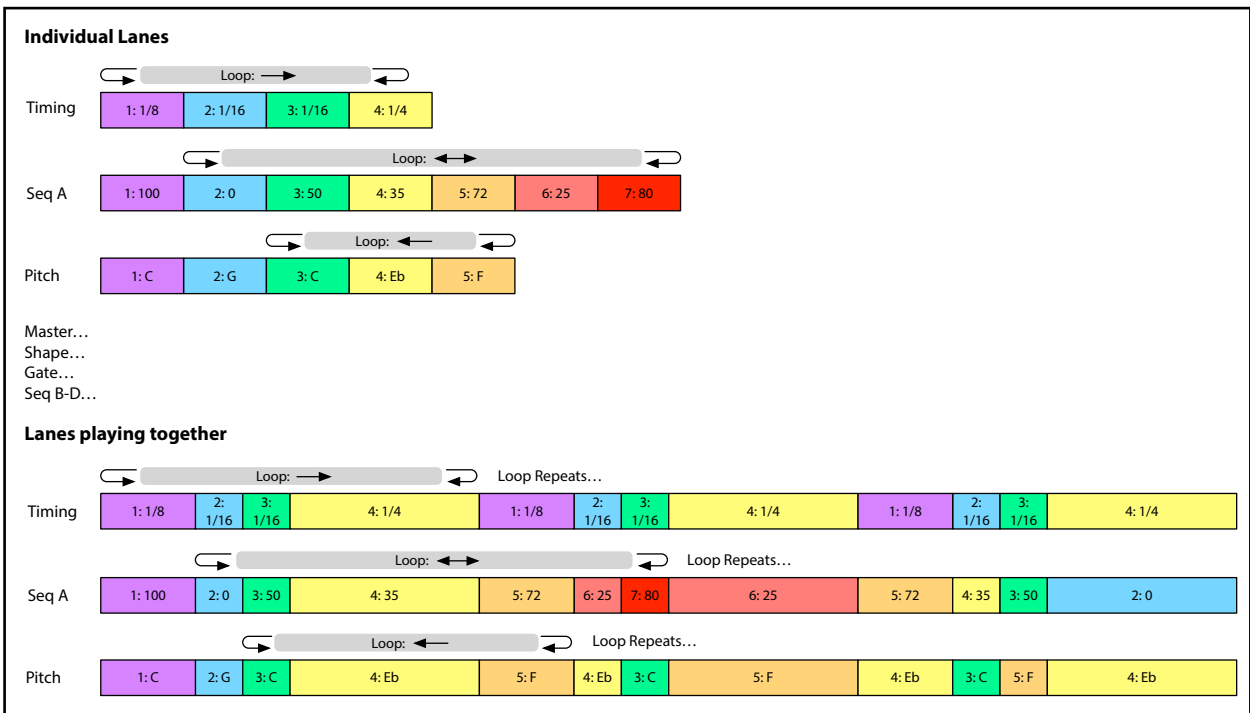

Sequencer page

This page shows a real-time overview of the Motion Sequence for the Program's newest-sounding voice.

Note: Through modulation and probability, each voice in each Lane of each Motion Sequence may be on different steps, and may also have different Start/End settings.

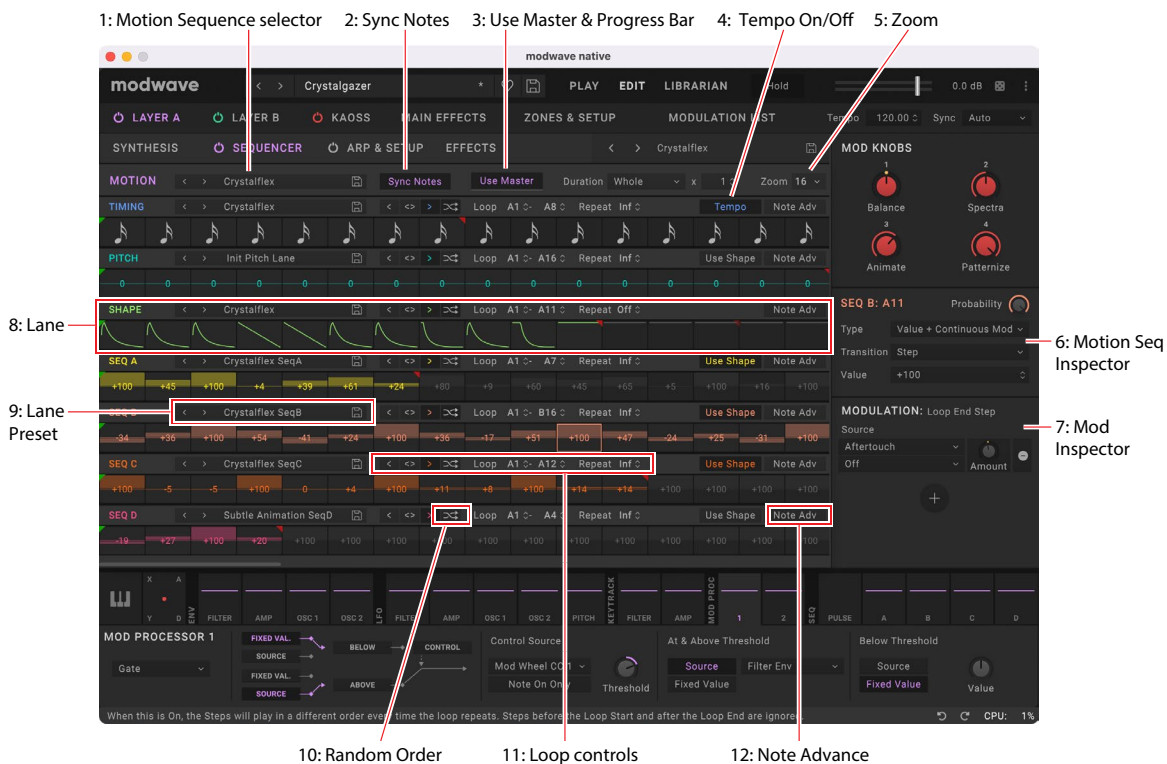

1: Motion Sequence selector

This shows the Motion Sequence for the current Layer's Program. Use the < and > arrows to step through Motion Sequences one by one, or click on the name to bring up a browser window. Right-click/control-click (macOS) on the name to bring up a contextual menu for saving and renaming.

2. Sync Notes

This sets whether individual Motion Sequences play on their own separate timelines, or whether they are sync'd together. For details, see "Sync Notes" on page 38.

3. Use Master

When **Use Master** is *On*, the Master Lane restarts all of the other Lanes after either a specified number of beats or elapsed time, depending on the Timing Lane's **Tempo On/Off** setting. You can use this to create regularly repeating patterns, even if the different Lane have irregular loop lengths. For details, see "Master Lane" on page 40.

Master Lane Progress Bar

This progress bar below the **Use Master** button shows the progress through the Master Lane's loop.

4. Tempo On/Off

Tempo controls both the Master Lane and the Timing Lane. For details, see "Tempo" on page 41.

5: Zoom

Use the 16/32/64 settings to adjust the viewable range of the display, to show 16, 32, or 64 Steps, respectively. For compatibility with the hardware modwave, Steps are named in groups of 16: A1...A16, B1...B16, C1...C16, and D1...D16; you'll see these names in the Motion Sequence Inspector for Lane Loop Start and End points, and when editing individual steps.

6: Motion Sequence Inspector

This area shows details for the currently selected Lane or Step.

To edit Lane parameters, click on the Lane's title. To edit Step parameters, click on a Step.

7: Mod Inspector

This shows the modulation routings for the selected parameter. You can add or delete routings from the list, adjust modulation intensity, and change the selected Mod Sources (including adding a second Mod Source for routings created by drag-and-drop).

8: Lane

This is the main editing area for Motion Sequences. Select Lanes or Steps here to show their details in the Motion Sequence Inspector.

Editing Loop Start and End

The triangles above the Steps show the Loop Start (green) and Loop End (red). To edit, just click and drag on the triangles. Modulated values are shown as transparent versions of these triangles. You can also edit the numeric values in the Loop Controls section.

Editing values on the Step graphics

For the Pitch and Step Sequence Lanes, as well as the Timing Lane when **Tempo** is *Off*, drag on Steps in the graphic to edit the Transpose or Duration, respectively.

For the Shape Lane, as well as the Timing Lane when **Tempo** is *On*, click and hold to bring up a popup menu to select the Shape or note value, respectively.

9: Lane Preset

Each Lane has its own Preset. Use the < and > arrows to step through Presets one by one, or click on the name to bring up a browser window. Right-click/control-click (macOS) on the name to bring up a contextual menu for saving and renaming.

10: Random Order

When this is *On*, the Lane's Steps will play in a different order every time the loop repeats. For details, see "Random Order" on page 40.

11: Loop Controls

These control the Lane's loop, including direction, Random order, Loop Start and End, and number of repeats. For details, see "Standard Lane Controls" on page 39.

12: Note Advance

When this is *On*, each note played will increment the Start Step by one. Try using this with the Arpeggiator!

Motion Sequence

Motion (Motion Sequence)

[List of Motion Sequences]

This shows the currently selected Motion Sequence. Use the < and > arrows to step through Motion Sequences one by one, or click on the name to bring up a browser window. Right-click/control-click (macOS) on the name to bring up a contextual menu for saving and renaming.

Sync Notes

[Off, On]

Sync Notes sets whether individual Motion Sequences play on their own separate timelines, or whether they are sync'd together.

Off: Each of the Program's Motion Sequences will play independently.

Motion Sequencing 2.0

On: If at least one note of the Program is already playing, the Motion Sequence lanes for newly played notes will start on the same steps as those of the oldest note. See the graphic below. There may still be variations due to per-note modulation or Probability.

Sync Notes

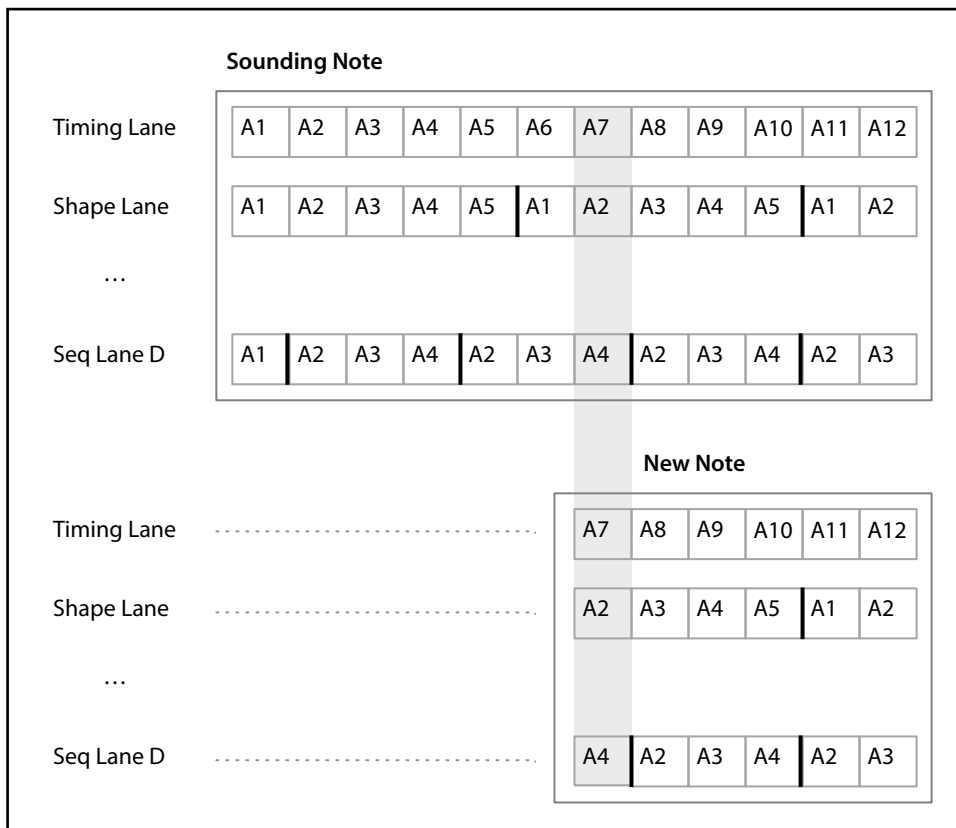

Standard Lane Controls

These controls apply to all lanes except Master. Some Lanes have special parameters in addition to the standard controls, as described in the following sections.

Lane Preset

Lane Presets store all of the parameters for the Lane and its Steps. Explore the system by mixing and matching presets for different Lanes.

Loop Start, Loop End

These control the Steps on which the Lane begins, ends, and loops. You can change them in real-time, while notes are sounding—and also modulate them via LFOs, Envelopes, etc. The **Loop Start** must be less than or equal to the **Loop End**.

These parameters control the Steps on which the Lane begins, ends, and loops. You can change them in real-time, while notes are sounding—and also modulate them via LFOs, Envelopes, etc.

 If you want to modulate loop points, use these parameters to set the maximum loop length. **Loop Start** can only be modulated upwards, and **Loop End** can only be modulated downwards.

Repeats

[Off, 1...100, Inf]

This controls the number of times that the Lane will loop before resting on the last Step. The default is *Inf*, which causes the loop to repeat as long as the note is held.

Loop Mode

This controls the direction of the loop: *Forward*, *Backward*, or alternating *Forward-Backward*.

Note Advance

When this is *On*, each note played will increment the Start Step by one. Try using this with the Arpeggiator!

Random Order

When this is *On*, the Steps will play in a different order every time the loop repeats.

To understand how **Random Order** works, imagine that each Step is on a note-card. Each time the loop plays, or whenever the **Loop Start** or **Loop End** changes, the note-cards from the **Loop Start** through the **Loop End** are shuffled and assigned to new numbers (A1, A2, etc.). Steps before the **Loop Start** and after the **Loop End** are ignored.

Step Probability

Each individual Step has a **Probability** setting, from 0% to 100%. This controls how likely the Step is to play. As with most Step parameters, **Probability** can be modulated; for instance, moving a Mod Knob might make some Steps more likely to occur, and other steps less likely to occur.

If a Step has less than 100% **Probability** and loses the roll of the dice, as it were, it is skipped. (See note about the Timing Lane, below.) Since the Motion Sequence is generated in real-time, we need to avoid a situation in which we repeatedly roll the dice, lose the throw, and roll again and again; eventually, we need to make some sound! So, if two Steps in a row are skipped, the third Step always is played—even if its probability is 0%.

Timing Lane probability

The Timing Lane works slightly differently regarding probability: “skipped” Steps are absorbed into the previous Step. For instance, if A1 and A2 are both 16th notes, and A2 is skipped due to probability, A1 becomes an 8th note. This maintains the overall length of the rhythm.

Master Lane

When **Use Master** is *On*, the Master Lane restarts all of the other Lanes after either a specified number of beats or elapsed time, depending on the Timing Lane’s **Tempo On/Off** setting. You can use this to create regularly repeating patterns, even if the different Lanes all have irregular loop lengths. Unlike other Lanes, Master has no steps, so the standard Lane controls don’t apply.

Use Master

[Off, On]

This parameter is stored in the Motion Sequence, as opposed to the Lane.

Off: The Master Lane is disabled.

On: The Master Lane is enabled, and restarts other Lanes as described above.

Loop Duration

[TEMPO Off: 0.0013... 120.0000 seconds]

[TEMPO On: 32nd-note triplet...2x breve]

If Timing Lane **Tempo** is *Off*, you can set the length of the Master Lane loop in seconds.

If Timing Lane **Tempo** is *On*, this sets the basic length of the Master Lane, relative to the system tempo.

x (Multiply Base Note by...)

[1...32]

This appears only if **Tempo** is *On*. It multiplies the length of the **Base Note**. For instance, if the **Base Note** is set to a whole note, and **Times** is set to 3, the Master Lane will reset every three whole notes.

Timing Lane

This Lane controls the Step durations, creating rhythms or smooth, evolving sounds.

Timing Lane

Preset, Loop Start, Loop End, Loop Mode, Repeats, Note Advance

See “Standard Lane Controls” on page 39.

Tempo

[Off, On]

Tempo controls both the Master Lane and the Timing Lane. The Timing Lane **Speed** parameter is affected as well; see its entry below for details.

Off: Master Lane **Loop Duration** and Timing Lane **Step Duration** are set by time, in seconds.

On: Master Lane **Loop Duration** and Timing Lane **Step Duration** are set by rhythmic values.

Speed

[TEMPO Off: 0.01...100.00]

[TEMPO On: 1/4...4x]

This modifies the speed of the entire Timing Lane. When **Tempo** is *Off*, you can vary this continually from 0.01 (1/100 of the original speed) to 100.00 (100 times the original speed). Try modulating this from an envelope!

When **Tempo** is *On*, you can select tempo-locked ratios from 1/4 to 4x of the original speed.

Swing (Resolution)

[32nd-note triplet...quarter-note]

(Swing Amount)

[-300...+300%]

Swing adjusts the timing of up-beats relative to the Swing Resolution. For instance, if Resolution is set to 1/8, Swing affects every other 8th note.

+100%: Full “swing.” Up-beats become triplets, moving one third of the way toward the next down-beat.

+300%: Up-beats move all the way to the next down-beat.

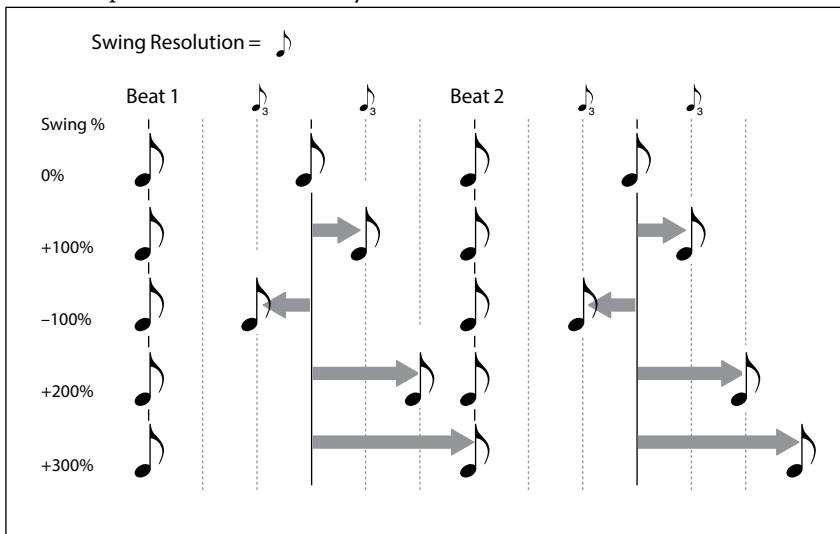

Scale Timing

This command is available in the contextual menu for the Timing Lane. It allows you to edit all of the Timing Lane Step Durations at once, to make the sequence longer or shorter. If you want to change this in real-time, use the Timing Lane **Speed** parameter instead.

Timing Lane Step

Type

[Note, Rest, Gate]

Note: The step will play normally.

Rest: On *Rest* Steps, all Lane outputs are muted. Pitch and Seq Lanes A-D will output a value of zero, instead of the Step's programmed value.

Gate: The sequence will pause at the step until note-off, after which the sequence continues. If this is also the End Step, the Motion Sequence will stay on the step through note-off. By setting a single Timing Step to *Gate*, and then

Motion Sequencing 2.0

modulating the Sample Lane Start Step by velocity, you can create a sound with up to 64 velocity switches. For instance, you can use this to switch between a large number of different Shapes.

Duration

[Tempo Off: 0.0000... 10.0000 seconds]

[Tempo On: List of rhythmic values]

If **Tempo** is *Off*, you can set the length of the step in seconds.

If **Tempo** is *On*, you can set the basic length of the step as a rhythmic value, relative to the system tempo. The values range from a 32nd note to a double breve (four whole notes), including dotted notes and triplets. This length is then modified by **x (Multiply Base Note by...)**, below.

x (Multiply Base Note by...)

[1...32]

This appears only if **Tempo** is *On*. It multiplies the length of the **Duration Base Note**. For instance, if the **Base Note** is set to an eighth note, and **Times** is set to 3, the step will last for a dotted quarter-note.

Probability

See “Step Probability” on page 40.

Pitch

This Lane sets the pitch of each Step.

Pitch Lane

Presets, Loop Start, Loop End, Loop Mode, Repeats, Note Advance

See “Standard Lane Controls” on page 39.

Use Shape

[Off, On]

When this is *On*, non-zero pitch values will be scaled by the Shape Lane. If the pitch offsets are zero, **Shape** has no effect. Note that **Shape** interacts with **Transition**, below; to hear shapes unaltered, set **Transition** to *Off*.

Transition

[Off, Lin, Exp, Log, Individual]

This controls whether the pitch changes abruptly at each new step, or glides to the new value.

Off: Pitch will change abruptly at each step. This is the default.

Lin: The pitch will glide linearly from step to step.

Exp: The pitch will glide from step to step, with most of the change at the end of the glide.

Log: The pitch will glide from step to step, with most of the change at the start of the glide.

Individual: The pitch transitions will be controlled separately per Step. This lets you create melodic patterns which combine abrupt steps and glides, like a classic bass groove-box.

Fit to Scale

[Off, On]

This lets you constrain the Pitch Lane’s output to a specific scale and key—especially useful when playing polyphonically.

Off: Pitch offsets will be played exactly as they are entered in the sequence.

On: Pitches will be constrained to the specified scale and key.

(Scale Key)

[C...B]

This sets the root note of the scale. For instance, if **Scale Key** is set to E, and the **Scale Type** is set to Minor, all notes generated by the Pitch Lane will be confined to notes in the E Minor scale: E, F#, G, A, B, C, or D.

Scale Key only applies if **Fit To Scale** is *On*.

(Scale Type)

[Major, Minor, Hrmnic Maj, Hrmnic Min, Melodic Min, Dorian, Phrygian, Lydian, Mixolydian, Locrian, Penta Maj, Penta Min, Diminished, Half Dim, Augmented, Whole Tone, Tritone, Blues, Bebop Dom, Flamenco, Romani, Hungarian, Persian, Harmonics, Acoustic, Enigmatic]

This selects the scale to which the generated notes will be confined. It only applies if **Fit To Scale** is *On*.

Scale	Notes generated by Pitch Lane (if Scale Key = C)											
	C	C#	D	D#	E	F	F#	G	G#	A	A#	B
Major	C	C	D	E	E	F	G	G	A	A	B	B
Minor	C	C	D	D#	D#	F	G	G	G#	G#	A#	A#
HarmonicMajor	C	C	D	E	E	F	G	G	G#	G#	B	B
HarmonicMinor	C	C	D	D#	D#	F	G	G	G#	G#	B	B
MelodicMinor	C	C	D	D#	D#	F	G	G	A	A	B	B
Dorian	C	C	D	D#	D#	F	G	G	A	A	A#	A#
Phrygian	C	C#	D#	D#	F	F	G	G	G#	G#	A#	A#
Lydian	C	C	D	E	E	F#	F#	G	A	A	B	B
Mixolydian	C	C	D	E	E	F	G	G	A	A	A#	A#
Locrian	C	C#	D#	D#	F	F	F#	F#	G#	G#	A#	A#
MajorPentatonic	C	C	D	D	E	E	G	G	G	A	A	A
MinorPentatonic	C	C	D#	D#	D#	F	F	G	G	A#	A#	A#
Diminished	C	C	D	D#	D#	F	F#	F#	G#	A	A	B
HalfDiminished	C	C	D	D#	F	F	F#	F#	G#	G#	A#	A#
Augmented	C	C	D#	D#	E	E	G	G	G#	G#	B	B
WholeTone	C	C	D	E	E	F#	F#	G#	G#	A#	A#	A#
Tritone	C	C#	C#	E	E	F#	F#	G	G	A#	A#	A#
BluesScale	C	C	D#	D#	D#	F	F#	G	G	A#	A#	A#
BebopDominant	C	C	D	E	E	F	G	G	A	A	A#	B
Flamenco	C	C#	C#	E	E	F	G	G	G#	G#	B	B
Romani	C	C	D	D#	D#	F#	F#	G	G#	G#	A#	A#
HungarianMinor	C	C	D	D#	D#	F#	F#	G	G#	G#	B	B
Persian	C	C#	C#	E	E	F	F#	F#	G#	G#	B	B
Harmonics	C	C	D#	D#	E	F	G	G	G	A	A	A
Acoustic	C	C	D	E	E	F#	F#	G	A	A	A#	A#
Enigmatic	C	C#	C#	E	E	F#	F#	G#	G#	A#	B	B

Pitch Lane Step

Transpose

[-24...+24 semitones]

This offsets the played note by up to two octaves, up or down. This also affects the index into the Multisample map, potentially changing the sample selection, similar to transposing the entire keyboard.

Tune

[-12.00...+12.00 semitones]

This changes the tuning by up to one octave up or down. It does not affect the Multisample map.

Transition

[Off, Lin, Exp, Log]

This controls the transition from *this* Step to the *next* Step: whether the pitch changes abruptly at the next Step, or glides to the new value.

Motion Sequencing 2.0

This applies only if the Pitch Lane **Transition** parameter is set to *Individual*.

Off: Pitch will change abruptly at each step. This is the default.

Lin: The pitch will glide linearly from step to step.

Exp: The pitch will glide from step to step, with most of the change at the end of the glide.

Log: The pitch will glide from step to step, with most of the change at the start of the glide.

Probability

See “Step Probability” on page 40.

Shape

The Shape Lane creates a contour over the duration of the step. It can affect the Pitch Lane and/or any of the Seq Lanes (when the respective Lane’s **Use Shape** is *On*).

Shape Lane

Presets, Loop Start, Loop End, Loop Mode, Repeats, Note Advance

See “Standard Lane Controls” on page 39.

Shape Lane Step

Shape

[List of shapes]

There are a large number of shapes to choose from, including ones with two, three, or four pulses.

Offset

[-1.00...+1.00]

This shifts the entire shape up or down. It works slightly differently from Mod Processor “Offset,” in that the **Offset** is added to the shape, and then the result is scaled by the **Level**, below. For instance, if you want Shape to control volume, but don’t want the volume to drop all the way to silence, set **Offset** to +1.00 and **Level** to +0.50.

Level

[-2.00...+2.00]

This varies the amplitude of the Shape. Negative values invert the shape.

Phase

[-180...+180°]

This controls the start point of the shape. For example, to start in the middle of the shape, set the Phase to +180°.

Probability

See “Step Probability” on page 40.

Seq A/B/C/D

The four Seq Lanes generate modulation sources to control other synthesis parameters, just like envelopes, LFOs, etc.

Important: Motion Sequences run independently per voice. This means that the Step Seq Lane can only modulate per-voice parameters, such as settings in the Amp, Pitch, Filter, Envelopes, and LFOs. Specifically, the Step Seq Lane cannot modulate the Mod Knobs, effects, or Kaoss Physics.

Step Seq Lane

Presets, Loop Start, Loop End, Loop Mode, Repeats, Note Advance

See “Standard Lane Controls” on page 39.

Use Shape

[Off, On]

When this is *On*, non-zero values will be scaled by the Shape Lane.

Transition

[Off, Lin, Exp, Log, Individual]

This controls whether the value changes abruptly at each new step, or glides to the new value.

Off: Pitch will change abruptly at each step. This is the default.

Lin: The pitch will glide linearly from step to step.

Exp: The pitch will glide from step to step, with most of the change at the end of the glide.

Log: The pitch will glide from step to step, with most of the change at the start of the glide.

Individual: The pitch transitions will be controlled separately per Step. This lets you create melodic patterns which combine abrupt steps and glides, like a classic bass groove-box.

Step Seq Lane Step

Type

[Value + Continuous Mod, Value * Random +/-, Value * Random +, Value + S & H Mod]

Value + Continuous Mod: The Step uses the programmed value, and modulation continuously affects the value. For instance, if an LFO is modulating **Value**, you'll hear the LFO's shape during the step.

*Value * Random +/-*: The Step's **Value** is scaled by a bipolar random amount. The result may be either positive or negative.

*Value * Random +*: The Step's **Value** is scaled by a unipolar random amount. If the **Value** is positive, the output will be positive; if the **Value** is negative, the output will be negative.

Value + S & H Mod: The Step uses the programmed value, and modulation is updated only at the start of the Step. For instance, if an LFO is modulating **Value**, only the LFO's amplitude at the very start of the step matters; you will *not* hear the LFO's shape during the step.

Value

[-100...100%]

This sets the output level for the Step.

Transition

[Off, Lin, Exp, Log]

This controls the transition from *this* Step to the *next* Step: whether the value changes abruptly at the next Step, or glides to the new value.

This applies only if the Lane's **Transition** parameter is set to *Individual*.

Off: Pitch will change abruptly at each step. This is the default.

Lin: The pitch will glide linearly from step to step.

Exp: The pitch will glide from step to step, with most of the change at the end of the glide.

Log: The pitch will glide from step to step, with most of the change at the start of the glide.

Probability

See "Step Probability" on page 40.

Motion Sequence Steps contextual menu

Right-click or control-click (macOS) on a Step to bring up the contextual menu. Menu commands are still available when multiple Steps are selected.

Selecting multiple Steps

Shift-click to select a range of Steps, or select multiple non-continuous items by holding down the Command key on MacOS, or the Ctrl key in Windows. Once you've selected the desired step(s), right-click (or control-click on MacOS) to bring up the contextual menu and choose the desired copy/paste operation.

Cut

This cuts the selected Step(s), placing them on the clipboard, and shifts all other Steps to fill in the gap.

Copy Step

This copies the selected Step(s), placing them on the clipboard.

Paste Step

These commands paste the Step(s) on the clipboard over the selected Step(s).

If you have cut or copied multiple Steps, and then select a range of Steps as the Paste destination, the following will happen:

- If a single Step is selected, the Steps will be pasted starting at that step, and then replace as many steps as necessary following that step.
- If you've selected exactly the same number of Steps as are on the clipboard, even if they are discontinuous, Paste will replace only those selected Steps.
- If you've selected fewer Steps than are on the clipboard, even if they are discontinuous, Paste will replace the selected Steps, and then replace as many Steps as necessary following the last selected Step.
- If you've selected more Steps than are on the clipboard, Paste will replace the selected Steps with a loop of the clipboard, stopping at the last selected Step.

Insert Before and Insert After

These commands insert the Step(s) on the clipboard before or after the selected Step.

If a range of steps is selected, only the first or last step matters. **Insert Before** refers to the first selected step, and **Insert After** refers to the last selected step.

Delete Step

This removes the selected Step(s) without affecting the clipboard.

Solo Step

Step solo mode makes the Lane temporarily loop on the selected Step, for auditioning shapes, troubleshooting, etc.

To enter Step Solo mode:

1. **Right-click or control-click (macOS) on a Step to bring up the contextual menu.**
2. **Select the Solo Step command.**

The Step will be marked with a brighter, thicker outline.

The Motion Sequence will play as if that Lane was set to loop on the selected Step. Other Lanes will continue to play normally. If you select other Steps in the current Lane, solo will follow the selected Step.

To exit Step Solo mode, bring up the contextual menu and un-select Solo Step.

Only one Lane at a time can be in Step Solo mode. If you enter Step Solo mode for a second Lane, the first Lane's Step Solo mode is turned off automatically. Changing to a different Layer also turns off Step Solo mode.

Arp & Setup page



Arpeggiator

Each Layer has its own Arpeggiator. Since this is in the Layer, you can leave the Arpeggiator set up and audition it with different Programs. See "Structure" on page 2.

The Arpeggiator is particularly effective in conjunction with Note Advance, so that each generated note starts on a new step in the Lane. Try this with the Sample Lane, for instance, with a single Timing step set to *Gate*.

Arpeggiator

[Off, On]

The power button turns the arpeggiator on and off.

Pattern

Pattern

[Up, Down, Alt1, Alt2, Random]

This controls the note pattern of the Arpeggiator. Most should be self-explanatory. Alt1 and Alt2 each go up and then down; the difference between them is that Alt2 plays the top-most and bottom-most notes twice.

Up



Down

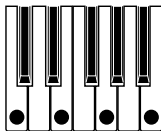

Alt1

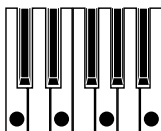

Alt2

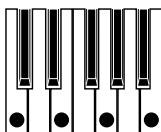

Random

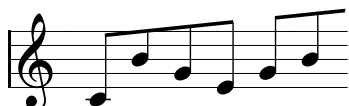
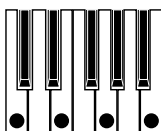

Octaves

[1...4]

This controls the range of the arpeggiated notes. *1* uses the pitches as played. *2-4* transpose upwards by the specified number of octaves.

Sort

[Off, On]

Off: The Arpeggiator Patterns will be based on the order in which the notes were originally played. For instance, *Up* will play the notes in the originally played order, and *Down* will play the notes in reverse order.

On: The Arpeggiator plays notes according to the selected Pattern, sorted from lowest to highest, and ignores the originally played order.

Rhythm

Resolution

[32nd note triplet... 1/4 note]

This controls the speed of the Arpeggiator. Try modulating this from the Mod Wheel!

Gate

[0%...100%]

This sets the length of the arpeggiated notes, as a percentage of the Resolution.

Swing

[-100%...+100%]

This controls the rhythmic swing of the Arpeggiator, based on the Resolution above.

100%: The second rhythmic division will be pushed to the third triplet, for a full swing feel.

-100%: The second rhythmic division will be pulled to the second triplet, for a reverse-swing feel.

Trigger

Latch

[Off, On]

Off: The Arpeggiator will only play as long as notes are being held on the keyboard (or via the damper pedal).

On: The Arpeggiator will continue to play after notes are released.

Sync Notes

[Off, On]

Off: The arpeggiator starts immediately when the first note is played, and does not synchronize to any Motion Sequences or itself when latched. You could use this if you were playing with a human drummer and needed to reset the arpeggiator rhythm to the drummer's beat periodically.

On: The arpeggiator will synchronize to either sounding Motion Sequences or itself when latched. When synchronizing to Motion Sequences, the first note will sound when played, but subsequent arpeggiator-generated notes will be in sync with the Motion Sequence. When playing a latched arpeggiator, new notes will sound when the arpeggiator beat comes around; the arpeggiator's rhythm is not disturbed by playing new notes.

Layer Setup

Volume

[-Inf, -84.9...+6.0 dB]

This controls the volume of the Layer. Note that this is saved in the Performance, but not with the Program—so it's a good choice when balancing levels between Layers.

Pitch

These parameters control the octave and tuning of the Layer. As with Layer volume, this is saved in the Performance, but not with the Program—so it's a good choice when creating detuning or octave offsets between Layers, without making the Program play out of tune if it's saved and selected elsewhere!

Octave

[-3...+3]

This transposes the Layer by 3 octaves, up or down.

Tune

[-100...+100 cents]

This lets you detune the Layer by up to 100 cents (1/100 of a semitone), up or down.

MIDI

Use Global MIDI Channel

[Off, On]

On: This is the default. The Layer will receive on the **Global Channel**.

Off: The Layer will receive on the channel specified below.

MIDI Channel

[1...16]

This is shown only if **Use Global MIDI Channel** is *Off*. It sets the channel on which the Layer will receive MIDI.

Rx Damper

[Off, On]

On: This is the default. The Layer will respond to MIDI CC#64.

Off: The Layer will ignore MIDI CC#64.

Rx Other CCs

[Off, On]

On: This is the default. The Layer will respond normally to MIDI CCs.

Off: The Layer will ignore all MIDI CCs (except for CC#64), as well as Aftertouch, Poly Aftertouch, and Pitch Bend.

Program Setup

Volume

[-Inf, -84.9...0.0 dB]

This controls the overall volume of the Program, for volume-balancing with other sounds.

Transpose

[-60...+60 semitones]

This transposes the Program by up to +/- five octaves, in semitones.

Random Pitch Range

[0.0...50.0 cents]

This parameter creates random variations in pitch for each note. At the default of 0.0, pitch will be completely stable; higher values create more randomization. This can be helpful for simulating instruments that have natural pitch instabilities, such as analog synths, tape-loop keyboards, or acoustic instruments.

Trigger

Trigger On

[Key-On, Key-Off]

Key-On: This is the default setting, in which the Program is played when a key is pressed.

Key-Off: The Program will play as soon as you release the key. You can use this to create the “click” heard when a harpsichord note is released, for instance. In general, when using *Key-Off* it's also best to set the Amp Envelope **Sustain** to 0.

Voice Allocation

Mode = Poly

(Voice Assign) Mode

[Poly, Mono]

This selects the basic voice allocation mode. Depending on which one you select, various other options will appear, such as **Single Trig** (*Poly* mode only) and **Mono Legato** and **Priority** (*Mono* mode only).

Poly: The Program will play polyphonically, allowing you play chords.

Mono: The Program will play monophonically, producing only one note at a time.

Single Trigger

[Off, On]

Single Trigger is available when **Voice Assign Mode** is set to *Poly*.

On: When you play the same note repeatedly, the previous note will be silenced before the next note is sounded, so that the two do not overlap.

Off: When you play the same note repeatedly, the notes will overlap.

Max # of Notes

[Dynamic, 1...32]

Max # of Notes is available when **Voice Assign Mode** is set to *Poly*.

Dynamic is the default. With this setting, you can play as many notes as the system allows.

1-64 limits the number of notes played by the Program. Voices will be allocated dynamically up to this maximum. You can use this to:

Arp & Setup page

- Model the voice-leading of vintage synthesizers
- Control the resources required by individual Programs

This setting does not limit the **Unison Voices** parameter. For instance, if **Max # of Notes** is set to 6, and **Unison Voices** is set to 3, you can play up to 6 notes, each with 3 Unison voices.

Mode = Mono

Mono Legato

[Off, On]

Mono Legato is available when **Voice Assign Mode** is set to *Mono*.

Legato means to play in a smooth, connected way; the next note is played before the last note is released.

On: The first note in a legato phrase will sound normally; subsequent notes in the phrase will sound smoother (for instance, envelopes will continue instead of restarting).

Off: Legato playing will produce the same sound as detached playing.

Priority

[Low, High, Last]

Priority is available when **Voice Assign Mode** is set to *Mono*.

This determines what happens when more than one note is being held down.

Low: The lowest note will sound. Many vintage monophonic analog synths work this way.

High: The highest note will sound.

Last: The most recently played note will sound.

Unison

Unison Voices

[1...16]

Unison can be used in both Mono and Poly modes.

1: Unison is off, and **Stereo Spread** and **Detune** do not apply.

2-16: The Program uses the specified number of stacked, detuned voices to create a thicker sound.

Detune

[0...200 cents]

This parameter sets the tuning spread for the **Unison** voices.

Voices = 3, Detune = 24, Thickness Off

Voices	Detune
1	-12
2	0
3	+12

Voices = 4, Detune = 24, Thickness Off

Voices	Detune
1	-12
2	-4
3	+4
4	+12

Thickness

[0...100]

This parameter controls the character of the detuning for the unison voices.

0: Unison voices are evenly distributed across the **Detune** range, as shown above.

Arp & Setup page

1...100: Unison voices are detuned asymmetrically. This makes the detuning more complex, and changes the way in which the pitches beat against one another—like slightly out-of-tune oscillators in a vintage synthesizer. Higher numbers increase the effect.

Stereo (Spread)

[0...100]

Stereo lets you create a wider stereo field when using **Unison**. It applies only when **Unison Voices** is 2 or greater.

Zones & Scales page



Performance Setup

Hold

[Off, On]

This duplicates the **Hold** button at the top of the window. Use **Hold** to hold notes or chords, leaving your hands free for knobs and modulation. This works differently from the Damper Pedal. When **Hold** is *On*, notes or chords are held indefinitely until you play a new note or chord, at which point the previous notes are cut off and the new ones will sound.

Hold applies only to Layers on the **Global MIDI Channel**.

Volume

[-Inf, -84.9...+6.0 dB]

This controls the volume of the Performance, duplicating the slider at the top of the window.

Octave

[-2...+2]

This transposes the entire Performance by 2 octaves, up or down.

Transpose

[-12...+12]

This transposes the entire Performance by 12 semitones, up or down.

Tempo

[40...300]

This is the stored tempo for the Performance, duplicating the control above the Mod Knobs. It applies only if **Sync To Host** is *Off* (when running as a plug-in) or when **Clock** is set to *Internal* or *Auto* (when running stand-alone); otherwise, it is grayed out.

Performance Scale

Power button (Use Performance Scale)

[Off, On]

On: The Performance Scale settings, below, are used—unless **Global Scale** is *On*, in which case the Global scales are used instead. See "Global Scale" on page 20.

Off: The Performance Scale settings are ignored.

Active Scale

[1, 2]

If **Perf Scale** is *On*, this chooses which of the two scales below is used. You can control this via MIDI; see "CC Assign" on page 21.

1 (Scale 1)

[*Arabic, Equal Temperament, Kirnberger, Pelog, Pure Major, Pure Minor, Pythagoras, Slendro, Stretch, Werkmeister*]

This selects the first scale to be used.

Arabic: This includes the quarter-tone intervals used in Arabic music.

Pythagoras: Especially effective for melodies, this produces 11 completely pure fifths, at the expense of other intervals—thirds in particular. To maintain the tuning of the octave, the final fifth—from sharp four to sharp root—is also quite flat.

Werkmeister (Werkmeister III), Kirnberger (Kirnberger III): These are "Well-Tempered" tunings from the Baroque period.

Pelog: This Indonesian gamelan scale uses seven notes per octave. When **Key** is set to C, use the white keys. The black keys will play the equal tempered pitches.

Pure Major, Pure Minor: These are Just Intonations optimized for major and minor keys, respectively. Unlike the other scales, they maintain the A4 tuning (e.g. A=440 Hz) as set by the **Master Tune** parameter (see "Master Tune" on page 20.). Because of this, the root note of the selected **Key** may shift from its equal-tempered pitch.

Slendro: This Indonesian gamelan scale has five notes per octave. When **Key** is set to C, use C, D, F, G and A. Other notes will play the normal equal-tempered pitches.

Stretch: In this acoustic piano tuning, notes below the middle of the keyboard are progressively more flat, and notes above the middle are progressively more sharp.

(Key)

[C...B]

This controls the root key of the scale. Key applies only to repeating 12-note scales.

Note: Specific combinations of **Scale** and **Key** may skew the reference tuning pitch. For example, A4 might become 442 Hz, instead of 440 Hz. Use **Master Tune** to correct this, if necessary.

2 (Scale 2)

(Key)

These are the second **Scale** and its associated **Key**.

Keyboard Zones

High (A, B), Low (A, B)

[C-1...G9]

These set the highest and lowest notes on which the Layer will sound.

Note: The graphic shows only the standard range of 88 notes.

HFade (High Fade A, B)

[0...127]

0: The **High** key acts as a hard split, with full volume on one side and silence on the other.

1...127: This allows you to create a keyboard crossfade. As the notes approach the **High** key, the volume will fade out gradually. This sets the number of semitones over which the fade-out occurs, working inwards from the **High** key.

To edit Fade ranges in the Zone graphics, use Option-drag (macOS) or Alt-drag (Windows).

LFade (Low Fade A, B)

[0...127]

See "HFade (High Fade A, B)," above.

Velocity Zones

High Vel (A, B), Low Vel (A, B)

[1...127]

These set the highest and lowest velocities on which the Layer will sound.

High Fade (A, B)

[0...126]

0: The **High Vel** acts as a hard split, with full volume on one side and silence on the other.

1...126: This lets you create a velocity crossfade. As velocity approaches the **High Vel**, the volume fades out gradually.

High Fade sets the velocity range over which the fade-out occurs, working inwards from the **High Vel**.

Low Fade (A, B)

See "High Fade (A, B)," above.

Modulation List page

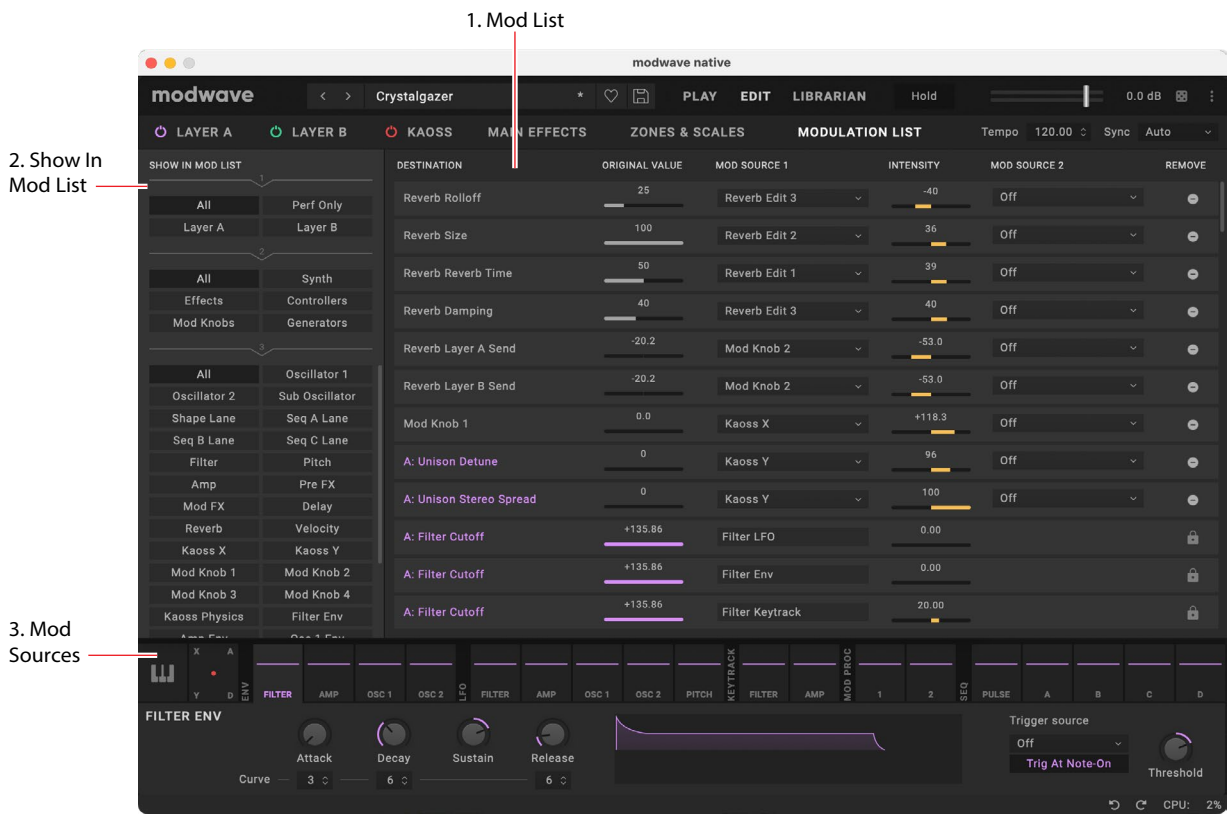

This page gathers together all of the modulation sources and modulation routings into a single screen. You can even edit the original values of the modulated parameters, along with all of the modulation settings.

For general information on using modulation, see “Modulation” on page 13.

1. Show in Mod List

This section lets you filter the Mod List to show only the routings that you’re interested in. There are three sections, ordered from top to bottom, each of which filters the next.

The top section lets you select All modulations, only modulations at the Performance level (such as modulation of Mod Knobs, Master Reverb, or Kaoss Physics), or modulations for the currently selected Layer.

The middle section filters by either destination category (such as Synth or Effects) or source category (such as Controllers or Generators).

The bottom section more specifically, such as by specific synth section (such as the Filter) or a specific controller (such as the Mod Wheel).

2. Mod List

This shows all of the modulation routings which match the criteria set in the Show in Mod List section. You can change mod source selections, adjust modulation Intensities, delete modulation routings, and even edit the value of the original parameter.

Note: built-in modulation routings, such as Filter Envelope modulation of Filter Cutoff or Amp LFO modulation of Level, are not shown here.

3. Mod Knobs

The Mod Knobs are available here, along with all of the other Mod Sources in the footer at the bottom of the window.

4: Layer Select

These select which of the Layers is shown in Column 1 of the Show in Mod List section, as described above.

5: Mod Sources

All of the main controllers and programmable modulation sources are shown here, including the keyboard with note number, velocity, aftertouch, and Pitch and Mod Wheels, Kaoss Physics, Envelopes, LFOs, Key Tracking, Mod Processors, and the Step Seq Lanes. Graphics show the mod source outputs, making it easy to figure out what's creating a specific modulation effect.

Modulation Sources

Controllers

Off

This means that no modulation source is selected.

Mod Wheel CC 1

This is the standard Mod Wheel (unipolar MIDI CC#1).

Kaoss Bttn CC 12

This is the front-panel KAOSS button on the hardware modwave (unipolar MIDI CC#12).

Damper CC 64

This is the damper or sustain pedal (unipolar MIDI CC#64).

Pitch Bend

This is the Pitch Bend wheel (MIDI Pitch Bend). You can use this as a modulator, in addition to its hard-wired control of pitch.

For the direct control of pitch, each Program has settings for Pitch Bend Range Up and Down. These are set by the numbers next to the Pitch Bend wheel in the Keyboard section of the Mod Source panel. Up and Down can be set independently, from -60 to +60 semitones.

Velocity

This is the note-on velocity, representing how hard the note is played on the keyboard.

Exponential Velocity

This is MIDI note-on velocity through an exponential curve. Low velocities won't have very much effect, and the differences between lower velocities won't be very noticeable. On the other hand, high velocities produce increasingly greater effects, and the differences between higher velocities will be more pronounced.

Release Velocity

This is the note-off velocity, representing how quickly the note is released from the keyboard.

Gate and Gate+Damper

Gate is triggered by a new note after all notes have been released, such as at the beginning of a phrase. Gate+Damper is similar, except that it is triggered by a new note-on after all notes and the damper are released.

Note-On Trig and NoteTrig+Damp

Note-On Trig is similar to Gate, but it triggers with every new note-on, even in the middle of a legato phrase. NoteTrig+Damp includes the damper pedal in the equation, as shown in the diagram below.

Gate, Gate+Damper, Note-On Trig, and NoteTrig+Damp

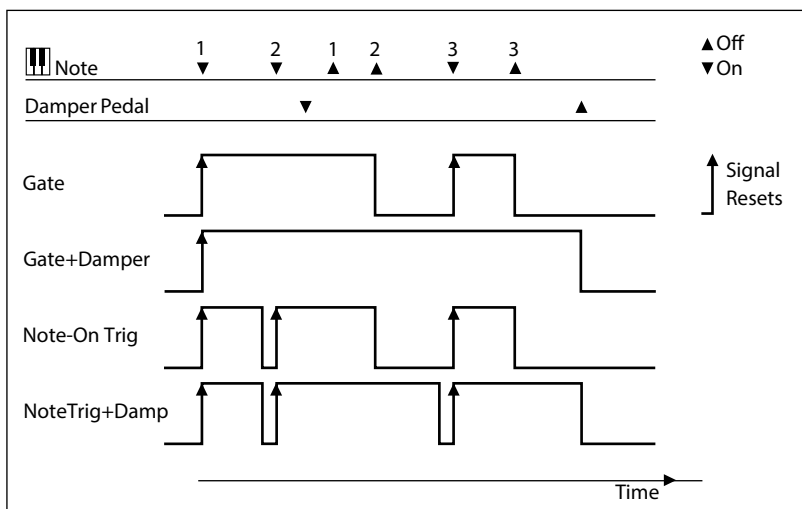

Modulation Sources

Note Number

This provides simple key tracking. C4 is the center, with a value of 0. Below C4 is negative, to a minimum at MIDI note 0; above C4 is positive, to a maximum at MIDI note 127.

Aftertouch and Poly Aftertouch

These are MIDI Aftertouch and Poly Aftertouch, respectively, representing pressure on the keyboard after note-on. Aftertouch can be globally switched to respond to Channel Aftertouch, Poly Aftertouch, both, or neither; for details, see “Aftertouch Source” on page 20.

Kaoss X

Kaoss X is the horizontal position of the Kaoss ball: negative to the left of center, 0 in the middle, and positive to the right.

Kaoss Y

Kaoss Y is the vertical position of the Kaoss Ball: negative below the center, 0 in the middle, and positive above the center.

Kaoss Distance

Kaoss Distance is the distance from the center, which is always positive.

Kaoss Angle

Kaoss Angle is the current angle of the ball relative to the x axis. The value is always positive, regardless of whether it is above or below the x axis.

Mod Knobs

This section of the Modulation Sources list contains the 4 Mod Knobs.

Generators

Filter/Amp/Osc 1/Osc 2 Envelope

These are the four ADSR envelopes.

Filter/Amp/Osc 1/Osc 2 /Pitch LFO

These are the five LFOs.

Filter/Amp Key Track

These are the Key Track generators from the Filter and Amp, respectively.

Mod Process 1/2

These are the two Mod Processors.

Step Pulse

This generates a brief trigger pulse at the start of each Motion Sequence Step.

Step Seq A-D

These are the outputs of the four Step Seq Lanes.

Tempo

This lets you use the system tempo as a modulation source. 120 is the center, for a value of 0; 60BPM is -100, and 240BPM is +100 (the value continues to increase up to 300BPM). Note that this is different from tempo synchronization; for that purpose, use the dedicated Tempo functions for the LFOs, Motion Sequence, and effects.

Program/Performance Note Count and Program/Performance Voice Count

These use the number of notes played on the keyboard, or the number of voices being played by the synth engine, as modulation sources. The Performance variations count all notes or voices in the Performance, while the Program variations only include those in the current Program.

# Notes/Voices	Resulting value
1	0.0
2	0.01

Modulation Sources

# Notes/Voices	Resulting value
3	0.02
...	...
101	1.0

Poly Legato

When you play a legato phrase, the first note of that phrase (and notes within 30 msec of the first note) has a Poly Legato value of 0.0. Subsequent notes in the phrase have a Poly Legato value of 1.0.

CC +

This is a list of MIDI CCs 1 to 119, interpreted as unipolar signals. MIDI values 0-127 are zero to maximum modulation.

CC +/-

This is a list of MIDI CCs 1 to 119, interpreted as bipolar signals. MIDI value 64 is 0; values below 64 produce negative modulation, and values above 64 produce positive modulation.

CCs with fixed assignments

MIDI CCs 1 to 119 can all be used as modulation sources. Some also have preset assignments to specific functions, as detailed below.

MIDI CC#	Fixed assignment
7 (Volume)	Overall volume
11 (Expression)	Overall volume
18	Kaoss Physics X (manual movement)
19	Kaoss Physics Y (manual movement)
64 (Damper)	Damper/sustain pedal
66 (Sostenuto)	Sostenuto (holds only notes sounding when the pedal is first pressed)
67 (Soft)	Reduces velocities of newly-played notes

Kaoss Physics

Overview

Kaoss Physics models a ball rolling on a surface. You can start the motion by dragging and releasing the on-screen ball with your mouse or trackpad, or launch the ball automatically using a trigger source such as *Gate + Damper*. You can also directly control the ball by dragging without releasing. The position of the ball produces several modulation signals, which can be used to control any modulation destination:

- *Kaoss X* is the horizontal position of the ball: negative to the left of center, 0 in the middle, and positive to the right.
- *Kaoss Y* is the vertical position: negative below the center, 0 in the middle, and positive above the center.
- *Kaoss Distance* is the distance from the center, which is always positive.
- *Kaoss Angle* is the current angle of the ball relative to the x axis. The value is always positive, regardless of whether it is above or below the x axis.

Kaoss Angle

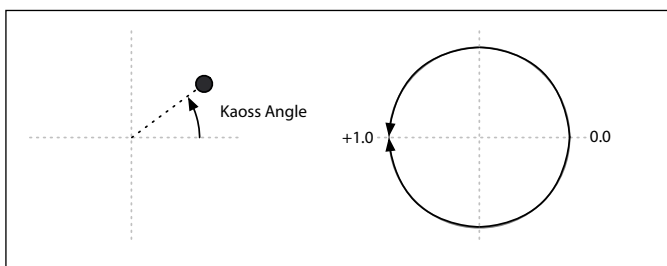

There is a bump in the surface, going either down or up, like a hole or a hill. You can set the height or depth of the bump, and choose one of several different shapes for its slopes. The surface has adjustable friction, so that the ball slows down as it travels. There are walls on the four sides of the surface, and when the ball hits a wall, it bounces off. Walls can slow down the ball, as if they were padded, or accelerate the ball, like bumpers in a pinball machine. The walls can also be removed entirely, so that the surface wraps around to the opposite edges like a vintage arcade game.

Note that most parameters, including **Tilt**, **Friction**, **Time**, **Bump Height** and **Position**, etc., are modulatable. You can even modulate them from the Kaoss Physics outputs—for instance, try modulating **Tilt X** with *Kaoss Y*.

Using Kaoss Physics to create specific results

Kaoss Physics can be interesting in itself, but you can also use it to create specific modulation effects. For instance:

- Use a centered **Bump** with negative **Height** so that the modulation values always eventually return to 0
- Position a **Bump** with positive **Height** on a side or a corner, to push modulation values away from that zone
- Set up opposing edges (top and bottom, and/or left and right) so that one has positive **Bounce** and the other has negative **Bounce**, with the result that the ball repeatedly speeds up and slows down
- Use **Friction** to slow down the ball over time, so that movement ends gradually and naturally
- Use the different forces—**Tilt**, **Friction**, **Bump Height**, and **Bounce**—to oppose and balance one another

Kaoss Physics automation

You can record Kaoss Physics gestures as automation data in your DAW.

The most important automation parameter is **Touched** (*On/Off*). When you're directly controlling the ball by dragging it with the mouse/trackpad, **Touched** is *On*, and the absolute x and y position of the ball is recorded as automation data.

When you release the mouse button and “throw” the ball into the Kaoss Physics environment, **Touched** turns *Off*. The release position, direction, and velocity of the throw are recorded in high resolution as a set of automation parameters. The absolute x and y positions of the ball, however, are not recorded. Instead, the automation data is processed by Kaoss Physics as if you were playing live. Modulation of Kaoss Physics parameters, like **Tilt** and **Time**, can change the results of the recorded gestures.

MIDI Control from the hardware modwave instrument

You can control Kaoss Physics from the x/y pad of a modwave keyboard running software version 1.1.2 or later. Make sure that the hardware modwave's Kaoss Physics CC assignment, on the MIDI CC Assign page, match the

modwave native’s **Kaoss Physics MIDI Control** in the Settings window. For more information, see “Kaoss Physics (Kaoss Physics MIDI Control)” on page 21.

Kaoss Physics page

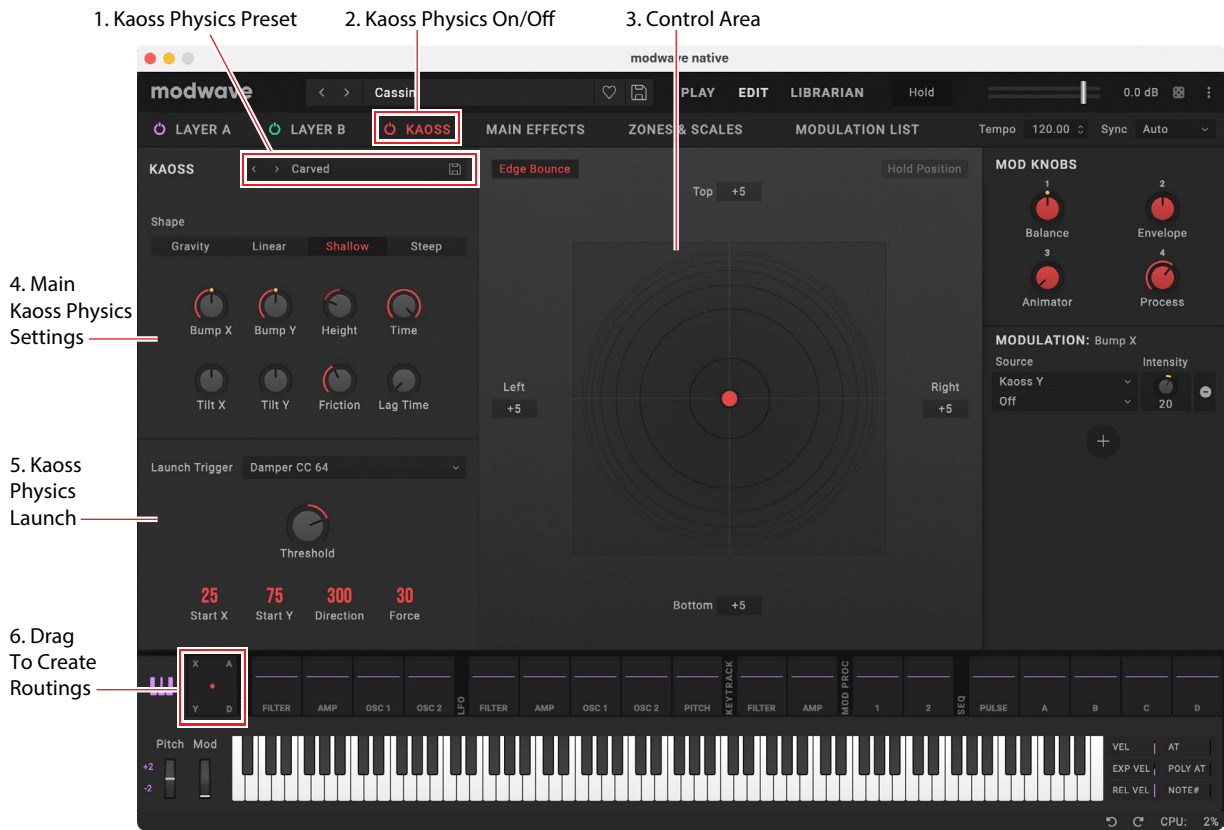

1. Kaoss Physics Preset

[List of Presets]

Presets let you store and recall all of the Kaoss Physics settings. Use the < and > arrows to step through Presets one by one, or click on the name to bring up a browser window. Right-click/control-click (macOS) on the name to bring up a contextual menu for saving and renaming.

2. Kaoss Physics On/Off

Press the power button to turn Kaoss Physics on and off.

Off: The physics model is disabled, and the pad works as a simple x-y pad.

On: The physics model is enabled.

3. Control Area

Start the motion by dragging and releasing the on-screen ball with your mouse or trackpad. You can also directly control the ball by dragging without releasing.

The Concentric rings indicate the selected **Shape**. Black and white shadowing indicates **Bump Height**; darker for negative (“hole”), and lighter for positive (“hill”). Red shadowing indicates **Tilt**. Edge brightness indicates **Bounce** settings; darker for negative (absorptive), and lighter for positive (accelerating).

4. Main Kaoss Physics settings

These are the detailed Kaoss Physics settings, as described below.

5. Kaoss Physics Launch

These are the settings for automatically launching the ball, as described below.

6. Drag To Create Routings

To create modulation routings from Kaoss Physics, click and hold on the letters X, Y, A (for Angle), or D (for Distance), and then drag to the desired mod destination. For more information, see “Drag and drop modulation routings” on page 13.

Kaoss Physics settings

Hold Position

[Off, On]

When **Kaoss Physics** is *Off*, the physics model is disabled, and the pad works as a simple x-y pad (although **Lag Time** still applies). In this mode, **Hold Position** determines what happens when you let go of the ball.

Off: The ball snaps back to the center.

On: The ball remains where it was placed.

Tilt X

[-100...+100]

Tilts the plane from left (negative) to right (positive).

Tilt Y

[-100...+100]

Tilts the plane from down (negative) to up (positive). For instance, tilting Y downward creates “gravity” towards the bottom.

Friction

[0...100]

Controls the energy absorption as the ball travels across the surface.

Time

[0.00x...1.00x]

Slows down time. Note that *1.00* (normal speed) is the maximum; if you want to both speed up and slow down, start at a value in the middle.

Bump Height

[-100...+100]

Positive for convex (a “hill”), negative for concave (a “hole”).

Position X

[0...50...100]

Sets the center point of the bump on the X axis. *50* is the center; *0* is the left side, and *100* is the right.

Position Y

[0...50...100]

Sets the center point of the bump on the Y axis. *50* is the center; *0* is the bottom, and *100* is the top.

Shape

[Gravity, Linear, Shallow, Steep]

Shape controls the slope from the edges of the surface to the center point.

Gravity: The closer to the center, the steeper the slope. With negative Bump Heights, this acts similarly to gravitational attraction.

Linear: Slope is constant over the entire surface.

Shallow: Slope is steep close to the edges and more gentle in the middle, like a shallow bowl.

Steep: Slope is gentle over most of the surface and markedly stronger in the center.

Lag Time

[0 msec... 10 sec]

This controls a set of lag filters which smooth out the modulation values generated by Kaoss Physics. 0 msec is the default; the modulation values directly represent the movement of the ball.

Higher values create increasingly gentle transitions between values, smoothing out abrupt changes. Note: Lag Time affects only the modulation outputs, rather than the motion of the ball.

Edge Bounce

[Off, On]

Off: This removes the walls entirely, so that the surface wraps around to the opposite edges like a vintage arcade game.

On: The ball bounces off of the four walls as specified below.

(Edge Bounce) Top/Bottom/Left/Right

[-100...+100]

These four parameters control what happens when the ball hits each of the walls. They only apply if **Edge Bounce** is *On*.

Negative values slow down the ball, as if the wall was padded. Positive values accelerate the ball, like bumpers in a pinball machine.

Kaoss Launch

This lets you launch the ball automatically using a trigger source. For instance, triggering via *Gate + Damper* will launch the ball whenever you play a new phrase on the keyboard. You can control the start point, direction, and force of the launch.

Start Position X

[0...50...100]

Sets the start point of the launch on the X axis. 50 is the center; 0 is the left side, and 100 is the right.

(Start Position) Y

[0...50...100]

Sets the start point of the launch on the Y axis. 50 is the center; 0 is the bottom, and 100 is the top.

Direction

[0...360°]

This controls the angle of the launch. 0° (and 360°) is straight to the right, 90° is straight up, 180° is straight to the left, and 270° is straight down.

Force

[0...100]

This controls the initial speed of the ball.

Trigger Source

[List of modulation sources]

This selects a source to trigger the launch. Try using *Gate + Damper*. Note that since there is a single Kaoss Physics generator for the entire Performance, per-voice sources such as Envelopes and LFOs cannot be used as triggers.

Trigger Threshold

[-100%...+100%]

This sets the modulation level which will trigger the launch. With *Gate + Damper* as the source, use a positive value of 50%.

When the threshold is positive (or 0), the launch triggers when passing through the threshold moving upwards. In other words, if the value has been below the Threshold, and then changes so that it is equal to or greater than the Threshold, the ball is launched.

When the threshold is negative, the launch triggers when passing through the threshold moving downwards. In other words, if the value has been above the Threshold, and then changes so that it is equal to or below the Threshold, the ball is launched.

Envelopes

Filter/Amp/Osc 1/Osc 2 Envelope

Attack (Attack Time)

[0.000 ms...90 seconds]

This sets how long the envelope takes to rise to the peak level.

Decay (Decay Time)

[0.000 ms...90 seconds]

This sets how long it takes to settle from the peak to the **Sustain** level.

Sustain (Sustain Level)

[-100...+100 (Filter and Pitch) or 0...+100 (Amp)]

This sets the level at the end of the **Decay** time. Once it reaches the **Sustain** level, the envelope will stay there until note-off, unless it is restarted via the **Trigger Source**. The Filter and Osc 1/2 Envelopes can have either positive or negative **Sustain** levels, while the Amp Envelope has only positive **Sustain** levels.

Release (Release Time)

[0.000 ms...90 seconds]

This sets how long it takes the envelope to return to 0 after releasing a note.

Filter/Amp/Osc 1/Osc 2 Envelope Curve

Often, envelopes are pictured as being made out of straight lines. In actuality, they are more likely to be made out of curves.

In other words, each segment's level will change quickly at first, and then slow down as it approaches the next point. This tends to sound better than straight, linear segments.

Classic analog synth envelopes made these curved shapes naturally. The modwave goes a step further than vintage synths, however, and lets you control the amount of curvature separately for each envelope segment.

When you change the curvature, the envelope times remain the same. However, greater curvatures will tend to *sound* faster, because the value changes more quickly at the beginning.

Different curve settings for up and down

Generally, upwards segments use different curvature settings than downward segments. For instance, a **Curve** of 3 is a good default setting for upward segments, such as **Attack**. On the other hand, a **Curve** of 6 or more is good for downward segments, such as **Decay** and **Release**.

Envelope Curve

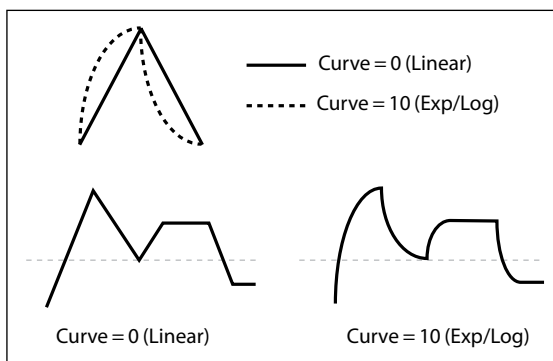

Curvature and Wavetable Position

When using the Osc 1/2 Envelopes to modulate **Position**, curvature is a matter of taste, and results will vary depending on the contents of the Wavetable. A **Curve** of 0 (*linear*) sweeps through the waveforms evenly, with equal time for each.

Envelopes

A **Curve** of *10 (exp/log)* sweeps through the waveforms quickly at the start of the envelope segment, and much more slowly at the end of the segment. By default, the Osc 1/2 Envelopes use *0 (linear)* for all segments.

Attack, Decay, Release Curves

[*0 (Linear), 1...9, 10 (exp/log)*]

These set the curvatures of the **Attack**, **Decay**, and **Release** segments, respectively. You can edit curvatures in the Envelope graphic by hovering over the desired segment and then dragging the yellow dot left or right.

Filter/Amp/Osc 1/Osc 2 Envelope Trigger

Trigger Source

[*List of modulation sources*]

This selects a source to start the envelope, or re-start it if it is already playing. For instance, you can use a tempo-synced LFO to trigger the envelope in a repeating rhythm, or create a looping envelope (see below).

Envelopes started or re-started by the **Trigger Source** work slightly differently from normal. The **Decay** always takes its full time, even if **Sustain** is at maximum; in this case, it acts as a hold time. Following the **Decay** time, the envelope goes to 0 over the **Release** time, even if the note is still being held.

Trigger Threshold

[*-100%...+100%*]

This sets the modulation level which will trigger the envelope. Among other things, you can use this to adjust the exact point in an LFO's phase at which the envelope will be reset, effectively controlling its "groove" against other rhythmic effects.

When the threshold is **positive** (or 0), the envelope resets when passing through the threshold moving upwards. In other words, if the value has been below the **Threshold**, and then changes so that it is equal to or greater than the **Threshold**, the envelope resets.

When the threshold is **negative**, the envelope resets when passing through the threshold moving downwards. In other words, if the value has been above the **Threshold**, and then changes so that it is equal to or below the **Threshold**, the envelope resets.

Note: modulation sources may not always reliably reach the extreme values of +100 or -100. This can happen due to smoothing, or with LFOs when using certain shapes and faster speeds. If this is the case, **Thresholds** of +100 or -100 will cause inconsistent behavior. To avoid this issue, reduce the **Threshold** until the Envelope resets consistently.

Trigger at Note-On

[*Off, On*]

Trigger at Note-On is available for the Filter, Osc 1, and Osc 2 Envelopes only. The Amp Envelope always triggers at note-on.

On: The envelope will start automatically at note-on. This is the default.

Off: The envelope will only start via the **Trigger Source**.

Note: The **Trigger Source's** value at note-on can cause the envelope to trigger instantly. If the **Threshold** is **positive** or 0, this will happen if the value is at or above the **Threshold**; if the **Threshold** is **negative**, this will happen if the value is at or below the **Threshold**.

Tip: Looping Envelopes

You can use these controls to create a simple looping envelope. To do so:

1. **Set the Trigger Source to the same envelope that you're working with.**

For example, if you're setting up the Filter Envelope, set the Trigger Source to the Filter Envelope.

2. **Set the Trigger Threshold to -1.**

3. **Set the Sustain Level to -2.**

Now, the envelope will re-start every time that it reaches the end of the Decay segment.

LFOs

Filter/Amp/Pitch/Osc 1/Osc 2 LFO

The five LFOs—Filter, Amp, Pitch, Osc 1, and Osc 2—all work identically.

Tempo

[Off, On]

On: The LFO synchronizes to the system tempo, with its speed controlled by **Base Note** and **Multiply**.

Off: The LFO speed is controlled by the **Frequency** parameter, in Hz.

Base Note

[List of rhythmic values]

If **Tempo** is *On*, this sets the basic speed of the LFO. The values range from a 32nd note to a double breve (four whole notes), including dotted notes and triplets.

x (Multiply Base Note by...)

[1...32]

If **Tempo** is *On*, this multiplies the length of the **Base Note**. For instance, if the **Base Note** is set to a sixteenth note, and **Times** is set to 3, the LFO will cycle over a dotted eighth note.

Frequency

[0.001...32.000 Hz]

If **Tempo** is *Off*, the LFO speed is set in Hz.

Waveform

[Triangle...Random6 (Continuous)]

Most of the waveforms are self-explanatory, but a few will benefit from more details:

GTR (*Guitar*) is intended for guitar vibrato. It is positive-only, so that when used for pitch, it only bends upwards.

RND 1 (*Random 1*) generates traditional sample and hold waveforms: random level changes with steady timing.

RND 2 (*Random 2*) randomizes both levels and timing.

RND 3 (*Random 3*) generates a pulse wave with random timing.

RND 4-6 are smoothed versions of *Random 1-3*, with slopes instead of steps. Use them to create gentler random variations.

LFO Waveforms

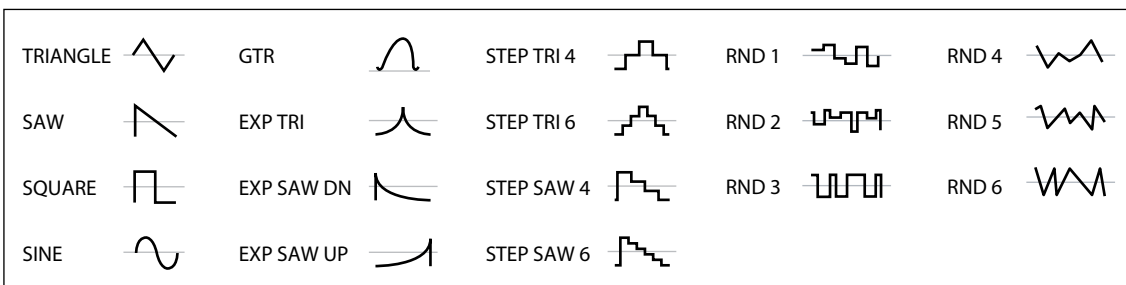

Phase (Start Phase)

[-180...+180]

This controls the phase of the waveform at the start of the note. You can edit **Start Phase** in the LFO graphic by dragging the waveform left or right. If **Random Start Phase** is *On*, this parameter has no effect.

Random (Random Start Phase)

[Off, On]

When **Random Start Phase** is *On*, the LFO will start at a different, random phase every time.

LFOs

Offset

[−100...+100]

By default, almost all of the LFO waveforms are centered around 0, and then swing all the way from -100 to +100. **Offset** lets you shift the LFO up and down, so that—for instance—it's centered on 50, and then swings from -50 to +150.

For example, let's say that you're using an LFO for vibrato. If **Offset** is 0, the vibrato will be centered on the note's original pitch, bending it both up and down.

If **Offset** is +100, on the other hand, the vibrato will only raise the pitch above the original note.

Offset settings and pitch change produced by vibrato

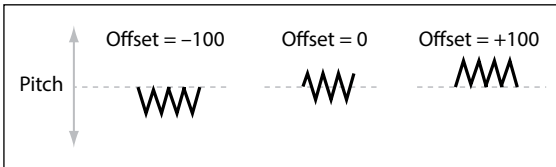

The one exception to this is the *Guitar* waveform, which is designed to emulate bending a string on a guitar—so that the pitch only goes up, and not down. Because of this, the waveform is centered on 50, and not on 0. Of course, you can always use a negative **Offset** to shift it back down below 0 again!

Offset is shown as a dotted line in the LFO graphic, and can be edited by dragging the line up and down.

Offset affects the signal *after* the **Shape** function, as shown below:

LFO Signal Flow

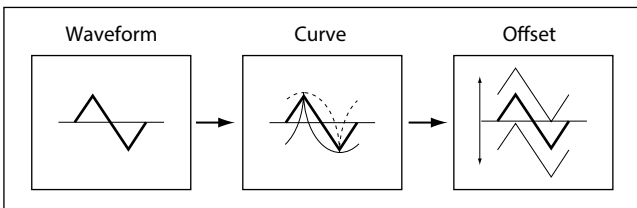

Curve

[−100...+100]

Curve adds curvature to the basic waveform. As you can see in the graphic below, this can make the waveforms either more rounded or more extreme. It can also be useful to emphasize certain value ranges, and deemphasize others.

For example, let's say that you are using a triangle LFO to modulate filter cutoff. If **Curve** emphasizes the high value range, the filter will spend more time at the higher frequencies. If it emphasizes the low range, the filter will spend more time at the lower frequencies.

LFO Curve

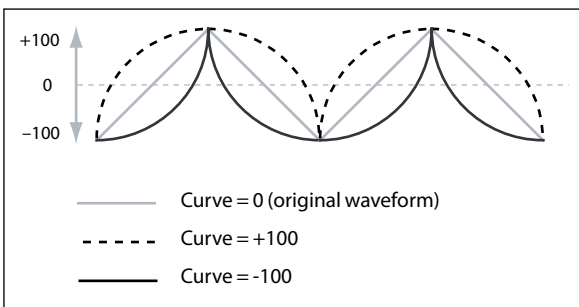

Note: **Curve** does *not* affect the *Square* and *Random 3* waveforms, since their values are always either +100 or -100.

Fade

[0.0000...9.900 sec]

The LFO can fade in gradually, instead of starting immediately at full strength. This sets the time from note-on until the LFO reaches maximum amplitude.

LFOs

Sync Notes

[Off, On]

Off: The LFO starts each time you press a key, and an independent LFO runs for each note. This is the default.

On: The LFO starts from the phase determined by the first note in the phrase, so that the LFOs for all notes being held are synchronized together. **Fade** applies only to the first note in the phrase.

Note: Even if Sync Notes is *On*, each note's LFO speed may still be different if modulated by note number, velocity, key scaling, or other note-specific modulation sources.

Key Track

Filter Key Track

Keyboard Track

Most acoustic instruments get brighter as you play higher pitches. At its most basic, keyboard tracking re-creates this effect by increasing the cutoff frequency of a lowpass filter as you play higher on the keyboard. Usually, some amount of key tracking is necessary in order to make the timbre consistent across the entire range.

The modwave native keyboard tracking can also be much more complex, since it allows you to create different rates of change over up to four different parts of the keyboard. For instance, you can:

- Make the filter cutoff increase very quickly over the middle of the keyboard, and then open more slowly—or not at all—in the higher octaves.
- Make the cutoff increase as you play *lower* on the keyboard.
- Create abrupt changes at certain keys, for split-like effects.

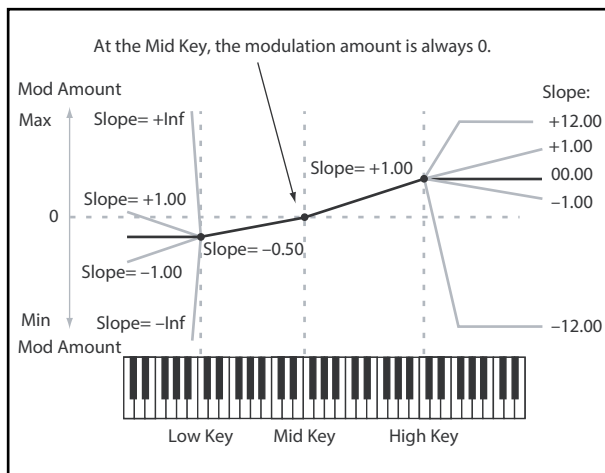

How Key Track works: Keys and Slopes

The keyboard tracking works by creating four ramps, or slopes, between five keys on the keyboard. The bottom and top keys are fixed at the bottom and top of the MIDI range, respectively. You can set the other three keys—named **Low**, **Mid**, and **High**—to be anywhere in between.

The four Slope values control the rate of change between each pair of keys. For instance, if the **Low-Mid Slope** is set to 0, the value will stay the same between the **Low Key** and the **Mid Key**.

You can think of the resulting shape as being like two folding doors attached to a hinge in the center. At the **Mid Key** (the main hinge), the keyboard tracking has no effect. The two folding doors swing out from this center point to create changes in the higher and lower ranges of the keyboard.

Slope

Positive slope values mean that the keyboard tracking output increases as you play farther from the Mid Key; negative slope values mean that it decreases. Because of this, the meaning of positive and negative slopes changes depending on whether the slope is to the left or right of the **Mid Key**.

Low and Low-Mid: negative slopes make the output go down as you play *lower* on the keyboard, and positive slopes make the output go up.

Mid-High and High: negative slopes make the output go down as you play *higher* on the keyboard, and positive slopes make the output go up.

The table below shows how the slopes affect the modulation output:

Slope value	Modulation change
-Inf	0 to minimum in 1 half-step
-10.00	0 to minimum in 6 semitones
-5.00	0 to minimum in 1 octave
-1.00	0 to minimum in 5 octaves
0	no change
+1.00	0 to maximum in 5 octaves
+5.00	0 to maximum in 1 octave
+10.00	0 to maximum in 6 semitones
+Inf	0 to maximum in 1 half-step

KeyTrack

The final effect of Key Track is a combination of the Key Track shape and the modulation intensity. With greater Slope values, the Key Track shape can max out fairly quickly. Because of this, if you want a more intense effect, it's best to increase the modulation intensity first, rather than increasing the Slope.

+Inf and -Inf slopes

+Inf and -Inf are special settings which create abrupt changes for split-like effects. When a slope is set to +Inf or -Inf, the keyboard tracking will go to its extreme highest or lowest value over the span of a single key.

Note: if you set the Mid-High Slope to +Inf or -Inf, the High Slope will have no effect. Similarly, if you set the Low-Mid Slope to +Inf or -Inf, the Low Slope will have no effect.

Low Slope

[-Inf, -12.00...+12.00, +Inf]

This sets the slope between the bottom of the MIDI note range and the Low key. For normal key track, use negative values. -1.00 is the default.

(Low) Key

[C-1...G9]

This sets the breakpoint note between the two lower slopes—the “hinge” of the lower door.

 The Low Key can't be set above the Mid Key.

Low-Mid Slope

[-Inf, -12.00...+12.00, +Inf]

This sets the slope between the Low and Mid keys. For normal key track, use negative values. -1.00 is the default.

Mid Key

[C-1...G9]

This sets the center of the keyboard tracking—the main “hinge.” When this key is played, the Key Track output is 0.

 The Mid Key can't be set below the Low Key, or above the High Key.

Mid-High Slope

[-Inf, -12.00...+12.00, +Inf]

This sets the slope between the Mid and High keys. For normal key track, use positive values. +1.00 is the default.

High Key

[C-1...G9]

This sets the breakpoint note between the two higher slopes—the “hinge” of the upper door.

 The High Key can't be set below the Mid Key.

(High) Slope

[-Inf, -12.00...+12.00, +Inf]

This sets the slope between the High key and the top of the MIDI note range. For normal key track, use positive values. +1.00 is the default.

Amp Key Track

Amp Keyboard Tracking (“Key Track”) changes the volume as you play up and down the keyboard. This may be used to make the volume more consistent, or to create special effects.

The modwave native's Amp Key Track can be fairly complex, if desired. For instance, you can:

- Make the volume increase very quickly over the middle of the keyboard, and then increase more slowly—or not at all—in the higher octaves.
- Create abrupt changes at specific keys.

You can also use Amp Key Track as a general-purpose modulation source, just like the envelopes and LFOs.

For general details on how Key Track works, see “Filter Key Track,” above.

KeyTrack

Differences from Filter Keyboard Track

Amp modulation works slightly differently from other mod routings, in that positive modulation is limited to 2x gain. For more information, see “Notes on Amp Modulation” on page 34. This means that, when applied to Amp Level, Amp Key Track’s negative **Slopes** act as if they are steeper than positive **Slopes**. This only applies to modulation of Amp Level; when modulating other destinations, Amp Key Track acts the same as Filter Key Track.

KeyTrack amount	Slope	Change in level
100%	-Inf	Silent in one half-step
	-12.00	Silent in five semitones
	-5.00	Silent in one octave
	-1.00	Silent in five octaves
	00	no change
	+1.00	2x in five octaves
	+5.00	2x in one octave
	+12.00	2x in five semitones
	+Inf	2x in one half-step

Modulation Processors

Overview

Modulation Processors transform a modulation signal to make it into something new. The original modulation signal also remains available. There are two Modulation Processors per Program.

The Modulation Processor outputs appear in the list of modulation sources, just like the LFOs and Envelopes.

Type

[Gate, Offset, Quantize, Scale, Curve, Smooth, Sum]

This controls the type of processing performed by the Mod Processor. Each is described in detail below.

Gate

This lets you switch between two modulation sources (or fixed values) using a third modulation source.

It's similar to an audio gate with a side-chain, but with even more flexibility—since you get to choose what happens when the gate is closed (below the threshold), as well as when it's open (above the threshold).

For instance, you can use Gate to:

- Apply pitch-bend or other effects to some notes, but not to others (using **Control at Note-On Only**)
- Apply modulation only after the source reaches a certain threshold—for instance, use Velocity to modulate an LFO's frequency, but only once Velocity is greater than 90
- Use a controller to switch between two different LFOs (or any two modulation sources)

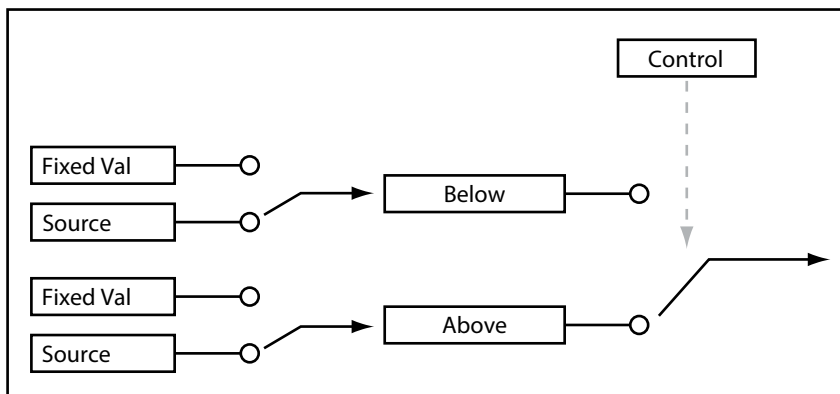

Control

Source

[List of Modulation Sources]

This selects the modulation source to control the Gate.

Threshold

[-100...+100]

This sets the value of the Control Source at which the gate opens or closes.

Control at Note-On Only

[Off, On]

When this is *On*, the value of the Control Source is only evaluated at note-on. The selected output will then remain active throughout the duration of the note, regardless of any subsequent change in the Control Source's value. Note that the output value itself can continue to change; only the selection of **Below** or **At & Above** is fixed.

Below Threshold

[Fixed Value, Source]

This sets the output of the Gate when the Control Source is less than the **Threshold**. When this is set to *Fixed Value*, you can set a value between -100% and $+100\%$. When it is set to *Source*, you can select any modulation source.

At & Above Threshold

[Fixed Value, Source]

This sets the output of the Gate when the Control Source is equal to or greater than the **Threshold**.

Offset

This adds a constant positive or negative offset to a modulation source, and also allows you to double the gain.

Input

[List of Modulation Sources]

This selects the input for the Mod Processor.

Level

[-200%...+200%]

$+200\%$ doubles the original signal level, while -200% doubles the level and inverts the phase.

Offset

[-200%...+200%]

This controls how the **Input** is shifted up or down.

$+200\%$ shifts an input of -100 all the way to $+100$.

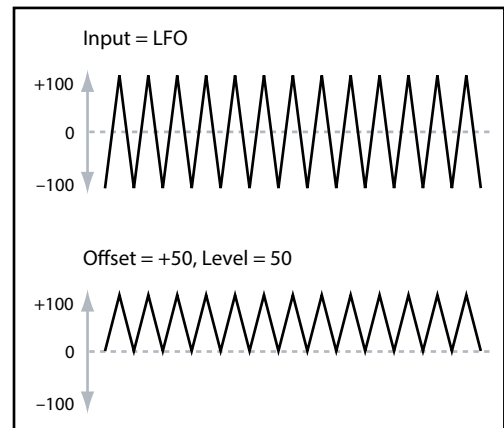

Converting from bipolar to unipolar

You can use *Offset* to convert a bipolar modulation source (both negative and positive), such as an LFO, to a unipolar signal (positive only). To do so:

1. **Select the LFO as the source.**
2. **Set the Input Amount to 50%.**

This cuts the overall level of the LFO in half.

3. **Set the Offset to 50%.**

This shifts the LFO signal up, so that it now swings between 0 and $+100$.

Converting from unipolar to bipolar

Similarly, you can convert a unipolar modulation source to a bipolar signal:

1. **Select the modulation source as desired.**
2. **Set the Input Amount to $+200\%$.**

This doubles the overall level of the modulation source.

3. **Set the Offset to -100% .**

This shifts the Modulation signal down, so that it ranges from -100 to $+100$.

Quantize

This changes a continuous signal into a series of discrete steps. Use this to change the shape of LFOs or envelopes, or to force a controller to land on a few specific values.

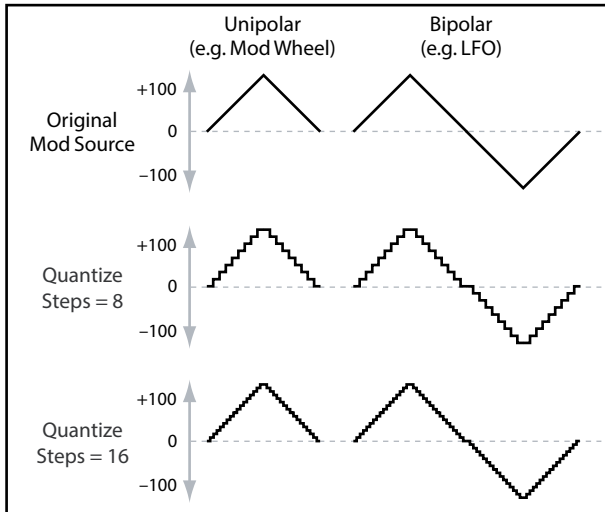

Input

[List of Modulation Sources]

This selects the input for the Mod Processor.

Steps

[1...32]

This controls the severity of the effect. Lower values create more “steppy” effects.

For instance, when this is set to 2, there will be “steps” at 0, 50, and 100. With a bipolar source, there will also be steps at -50 and -100.

Quantized Pitch Bend

You can use Quantize to create quantized pitch bend, for fret-dragging effects, brass rips, and more.

1. **Open the Synthesis tab.**
2. **Click and hold on Mod Processor 1 in the Mod Source footer, and drag it to the *Tune* knob.**
This creates a modulation routing from Mod Processor 1 to Tune.
3. **In the Mod Panel on the right of the window, set the Intensity to any exact half-step value: +5.00, +7.00, etc.**
4. **Click on Mod Processor 1 in the Mod Source footer.**
The footer will change to show Mod Processor 1.
5. **Set Mod Processor 1’s Type to *Quantize*, and set the Input to *Pitch Bend*.**
6. **Set Steps to the same number you used for Intensity, above.**
7. **In the Pitch section of the Synthesis tab, set both Pitch Bend Up and Pitch Bend Down to 0 (so that only the Mod Processor version will affect Pitch).**

Now, moving the Pitch Bend wheel will create quantized pitch bends.

Scale

This processor uses a modulation source to scale the input. For instance, you can control the amount of an LFO with an Envelope, or control the amount of an Envelope with a MIDI controller.

Input

[List of Modulation Sources]

This selects the main input for the Mod Processor.

Main Input Amount

[-100%...+100%]

This controls the gain and polarity of the input signal, before being scaled by the **Scale Source**. Input from the **Scale Source** then adds to this initial amount.

Even if the **Main Input Amount** is set to 0, the **Scale Source** can still control the final amount of the Main Input over the full +/-100 range.

Scale Source

[List of Modulation Sources]

This selects the modulation source to scale the **Input**.

Scale Amount

[-100%...+100%]

This controls the gain and polarity of the effect of the **Scale Source**. For example, the main input is an LFO and the **Scale Source** is an Envelope, positive settings mean that the Envelope will increase the amount of LFO.

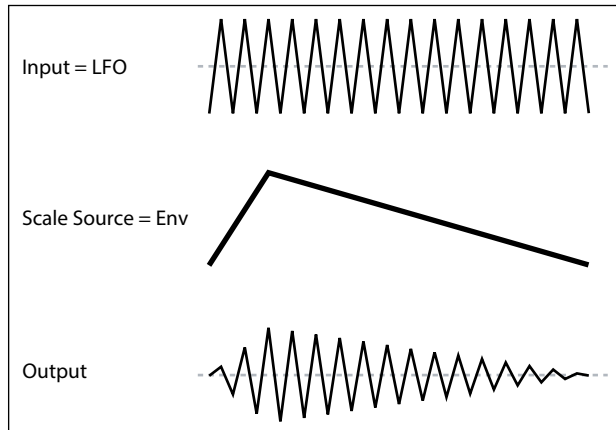

Curve

Curve can create custom controller curves, such as exponential joystick, logarithmic velocity, and so on. It can also alter the shape of programmable modulation sources, such as Envelopes and LFOs.

Note: Curve primarily affects modulation signals which already have some amount of slope, such as envelopes, triangle and sine LFOs, and so on. If the signal has only abrupt transitions from one value to another, like a classic sample-and-hold waveform, Curve will affect the values, but not the transitions between them. Curve does not affect signals which contain only maximum, 0, or minimum values, such as square waves.

Input

[List of Modulation Sources]

This selects the input for the Mod Processor.

Mode

[Symmetric, Asymmetric]

Asymmetric produces a single curve, extending from -100 to +100.

Symmetric produces two matching curves extending outwards from 0 to -100 and +100, respectively.

Modulation Processors

Curve and Mode

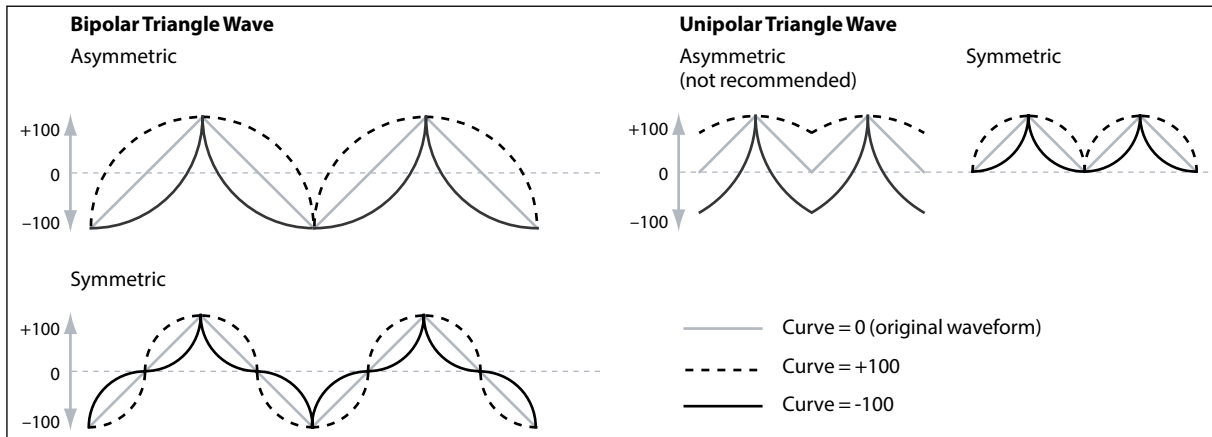

Curve

[−100.00%...+100.00%]

This controls the amount of curvature, and whether the curves are concave or convex.

As you can see in the graphic examples, the curve will emphasize certain value ranges, and deemphasize others. For example, let's say that you are using a triangle LFO, through Curve, to modulate filter cutoff. If Curve emphasizes high values, the filter will spend more time at higher frequencies. If it emphasizes low values, the filter will spend more time at lower frequencies.

Mode	Input	Curve	Result
Symmetric	Unipolar	Positive (+)	emphasizes upper value range
		Negative (-)	emphasizes lower value range
	Bipolar	Positive (+)	emphasizes both upper and lower value ranges, and deemphasizes the center
		Negative (-)	emphasizes center value range, around 0
Asymmetric	Unipolar	Positive (+)	emphasizes extreme upper range, with offset
		Negative (-)	emphasizes extreme lower range, with offset
	Bipolar	Positive (+)	emphasizes upper value range
		Negative (-)	emphasizes lower value range

Bipolar and Unipolar modulation sources

To understand Curve, it helps to understand the difference between *bipolar* and *unipolar* modulation sources.

Bipolar sources can swing all the way from -100 to +100, with 0 in the middle. Most LFOs are bipolar, for instance; so is Pitch Bend. Generally, bipolar modulation sources will work better with the *Asymmetric* mode, but *Symmetric* may also produce interesting results.

Unipolar sources only go from 0 to 100, with 50 in the middle. Often, MIDI controllers are unipolar (though you can also select bipolar versions). Envelopes are usually programmed to be unipolar, even though the Filter and Pitch Envelopes allow negative levels.

With unipolar sources, it's almost always better to use the *Symmetric* mode; *Asymmetric* can cause offsets and other strange results.

Smooth

This creates more gentle transitions between values, smoothing out abrupt changes such as a quick move on a wheel or a sharp edge on an LFO.

You have separate control of the amount of smoothing during the attack (when the signal is increasing) and decay (when it's decreasing).

Low settings provide subtle controller smoothing, creating more gradual aftertouch, for instance. Higher settings create auto-fade effects, transforming a quick gesture into a longer fade-in and/or fade-out event.

Smoothing can also be used to alter the shape of programmable mod sources, such as LFOs and envelopes. For instance, you can turn a “blip” into a simple envelope shape, as shown below.

Input

[List of Modulation Sources]

This selects the input for the Mod Processor.

Attack

[0.000... 10.000 sec]

This controls how long it takes the smoother to reach a new, *higher* value. Higher settings mean longer times.

Decay

[0.000... 10.000 sec]

This controls how long it takes the smoother to reach a new, *lower* value. Higher settings mean longer times.

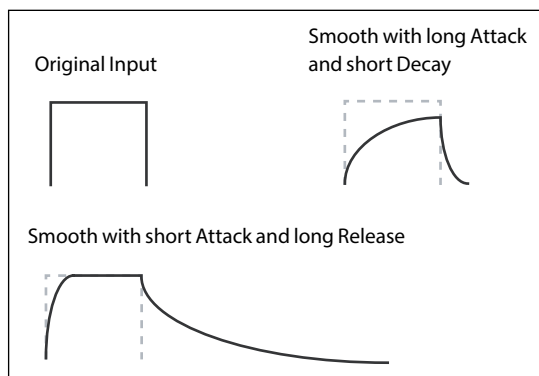

Sum

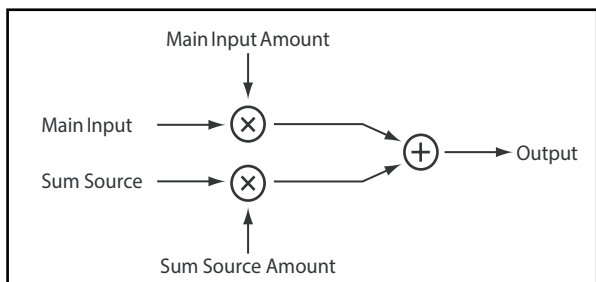

Sum adds two modulation sources together. This is useful if you want to process the combination of two or more signals: for instance, to merge an LFO and an envelope, and then smooth the result.

Input

[List of Modulation Sources]

This selects the main input for the Mod Processor.

Main Input Amount

[-100%...+100%]

This controls the gain and polarity of the **Input**.

Sum Source

[List of Modulation Sources]

This selects the modulation source to merge into the **Input**.

Sum Source Amount

[-100%...+100%]

This controls the gain and polarity of the **Sum Source**.

Modulation Processors

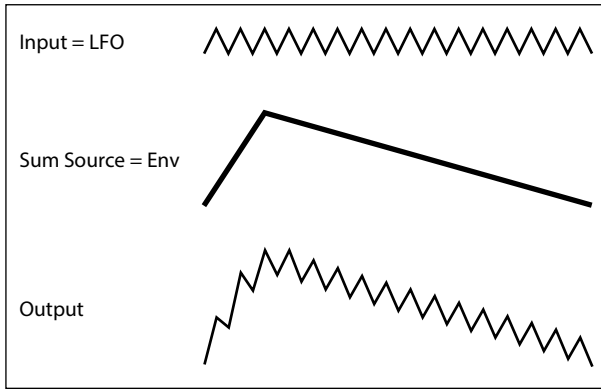

Effects page



Overview

Each Program has its own Pre FX, Mod FX, and Delay.

1. Mini Editor

The three effects have “mini editors” with the most important parameters, providing a quick overview of all of the Program’s effects.

Click anywhere on one of the three mini-editors to show the detailed editor below.

2. Effect Type

For each effect, you can select a **Type** (aka algorithm) and a **Preset** within that **Type**. For full lists of Effect Types, see “Pre FX” on page 81, “Mod FX” on page 82, “Delay” on page 83, and “Master Reverb” on page 84.

Types ending in “all,” such as *Delay All*, *Chorus All*, etc., let you select **Presets** from all related **Types**.

3. Effect Preset

These are the presets available for the selected **Type**.

4. Effect On/Off

Click on the power button to the left of the effect type name (Pre FX, Mod FX etc.) to turn effects on and off.

5. Detailed Editor

This shows all of the detailed parameters for the effect selected by clicking on one of the three mini-editors, above.

Mini Editors

Wet/Dry

[Dry, 1:99...99:1, Wet]

This controls the balance between the original signal (*Dry*) and the effected signal (*Wet*).

FX Edit 1/2/3

Each effect has three “edit” controls. These are macros which may control multiple internal parameters, and which may be set up differently for each **Preset**. There are general conventions for the edit knobs of each effect **Type**, and the names of the knobs change accordingly.

 **Important:** Modulation of internal parameters is allowed only from the FX Edit 1/2/3 knobs. To modulate effects from other sources, such as the Mod Wheel or the Mod Knobs, assign the internal parameter to one of the FX Edit knobs, and then modulate the FX Edit knob from the desired source.

Level controls

Additional level-related parameters may be available, depending on the effect **Type**.

Input Trim

[-Inf, -84.9...0.0 dB]

This controls the volume level into the effect. Use this to alter the response of effects such as the *Waveshaper*, or to compensate for gain increases in effects such as the *Talking Modulator*.

Volume

[-Inf, -84.9...+12.0 dB]

This controls the post-**Drive** output of the **Guitar Amp**. Use it to compensate for level changes caused by **Drive**.

Output Level

[-Inf, -84.9...0.0 dB]

This controls the output volume from the effect. Use it to compensate for level changes in effects such as the *Waveshaper*.

Gain Adjust

[-Inf, -84.9...+24.0 dB]

This is similar to Output Level, but provides up to 24dB of gain. It appears only for the **Modern Compressor**.

Pre FX

Decimator

This stereo effect models vintage digital gear, lowering the sampling frequency and reducing bit depth.

Graphic EQ

This is a stereo graphic EQ with macro controls.

Guitar Amp

This mono effect models a selection of guitar amps and speaker cabinets, for everything from subtle saturation to roaring distortion.

Modern Compressor

This is a stereo compressor with a modern sound.

Parametric EQ

This is a stereo EQ with a single adjustable parametric band. Presets may include additional EQ.

Red Compressor

Need to play chordal passages with smooth, even dynamics? Then, look no further: this mono compressor is modeled on a pedal whose clean sound made it hugely popular.

Ring Modulator

This stereo effect creates a metallic sound by modulating the input via an LFO-controlled oscillator.

Tremolo

This stereo effect modulates volume with an LFO, optionally controlled by an envelope follower.

Wave Shaper

This stereo effect is very sensitive to input level. Different table selections generate various types of overtones and distortion.

Mod FX

Black Chorus/Flanger

This is modeled after a classic mono-in, stereo-out chorus known for both crystal-clean tone and quiet operation, and especially well-suited to tine electric pianos.

Black Phase

This mono phaser is inspired by a classic European pedal effect.

CX-3 Vibrato Chorus

This effect models the scanning chorus and vibrato circuitry of a vintage organ.

EP Chorus

This is inspired by a rare chorus built into a famous modified tine piano.

Harmonic Chorus

This stereo effect applies chorus only to higher frequencies—particularly useful for bass sounds. Some presets use feedback to turn the chorus into a flanger.

Modern Chorus

This stereo effect adds thickness and warmth to the sound by modulating the delay time of the input signal.

Modern Phaser

This is a modern, stereo phaser effect.

Orange Phase

This models a mono phaser pedal which is a favorite on many recordings. It's useful for adding sparkle, animating chord passages, and widening and fattening the sound.

Polysix Ensemble

This models the mono-in, stereo-out ensemble effect built into the classic Korg Polysix synthesizer.

Small Phase

This models a classic mono phaser made in New York City during the 70s, with its warm, rich tone and liquid transparency.

Talking Modulator

This mono effect applies vowel formant filters, like a human voice, to the input.

Vintage Chorus

This models a mono chorus best-known for being built into a guitar amp. **Speed** and **Depth** provide a broader range of sounds than the original device.

Vintage Flanger

A model of a truly classic mono analogue flanger. This amazing stompbox's bucket-brigade technology provides a sweeping, whooshing sound, perfect for chords.

Vintage/Custom Wah

This stereo effect models the tonal character of a vintage wah pedal.

Vox Wah

This effect is modeled on the unique “throaty” tones of two legendary VOX wah pedals: the V847 and the V848 Clyde McCoy model.

Delay

L/C/R Delay

This mono-in, stereo-out multitap delay has three taps panned to the left, right, and center respectively.

Multiband Mod Delay

This monster effect divides the input signal into four frequency bands, with a modulatable delay for each band. It can produce everything from complex, frequency-specific delays to thick choruses.

Reverse Delay

This effect includes a reverse delay followed by additional left and right delays. Presets provide various feedback options.

Stereo/Cross Delay

This true-stereo delay provides up to 2,730 msec of delay time.

Tape Echo

This effect models a tape echo with up to three playback heads, including tape saturation.

Reverb & EQ page

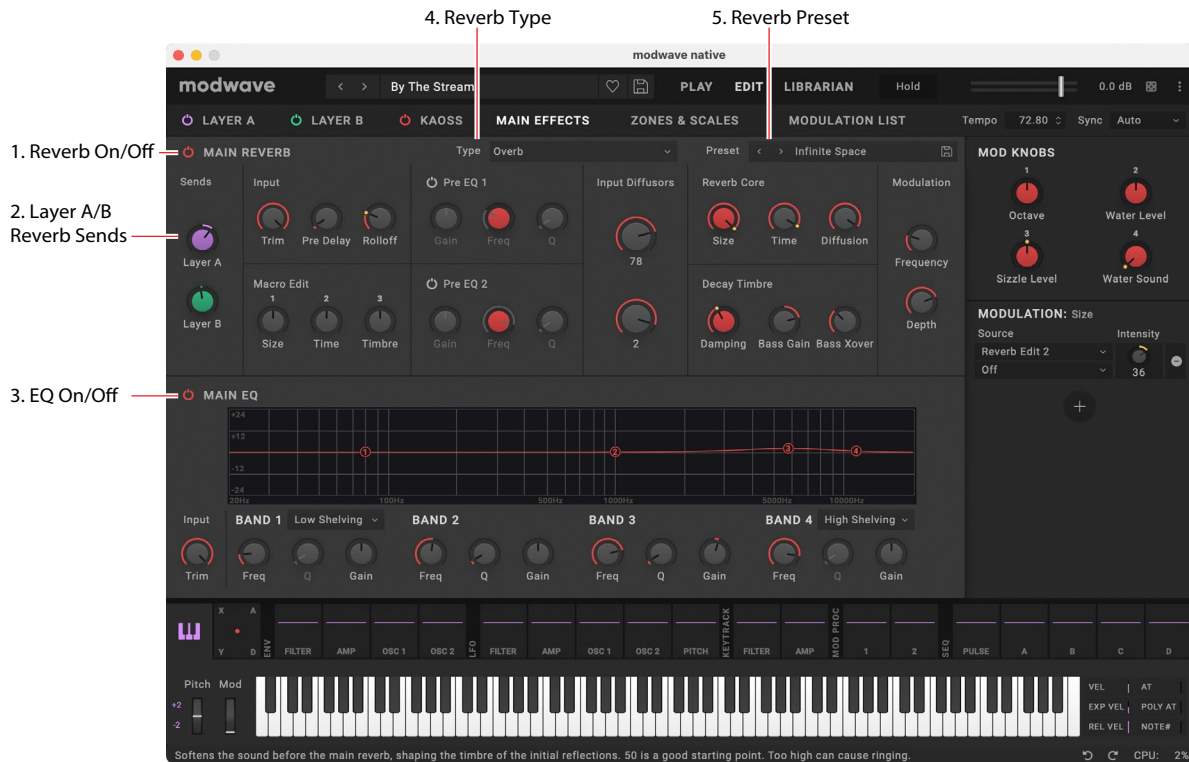

The Performance has a Master Reverb and Master EQ, shared by both Layers. See “Structure” on page 2.

1. Reverb On/Off

The power button turns the reverb on and off.

2. Layer A/B Reverb Sends

The Send knobs control the amount of signal sent from Layers A and B, respectively, to the Master Reverb.

3. EQ On/Off

The power button turns the EQ and off.

4. Reverb Type

For the reverb, you can select a **Type** (aka algorithm) and a **Preset** within that **Type**.

Types ending in “all,” such as *Reverb All*, let you select **Presets** from all related **Types**.

5. Reverb Preset

These are the presets available for the selected **Type**.

Master Reverb

Early Reflections

This provides different early reflection patterns, useful for small ambiances, gated reverbs, and reverse effects.

Overb

The Overb features a high-quality, diffusion-based reverb core, including randomization for richer and smoother reverb timbres.

Master EQ

Performances include a dedicated parametric EQ after the Master Reverb. Use **Trim** to compensate for EQ boosts. The **L** (Low) and **H** (High) bands can be set to *Peak*, *Shelf*, or *Cut* (Low cut/High cut).

Librarian page

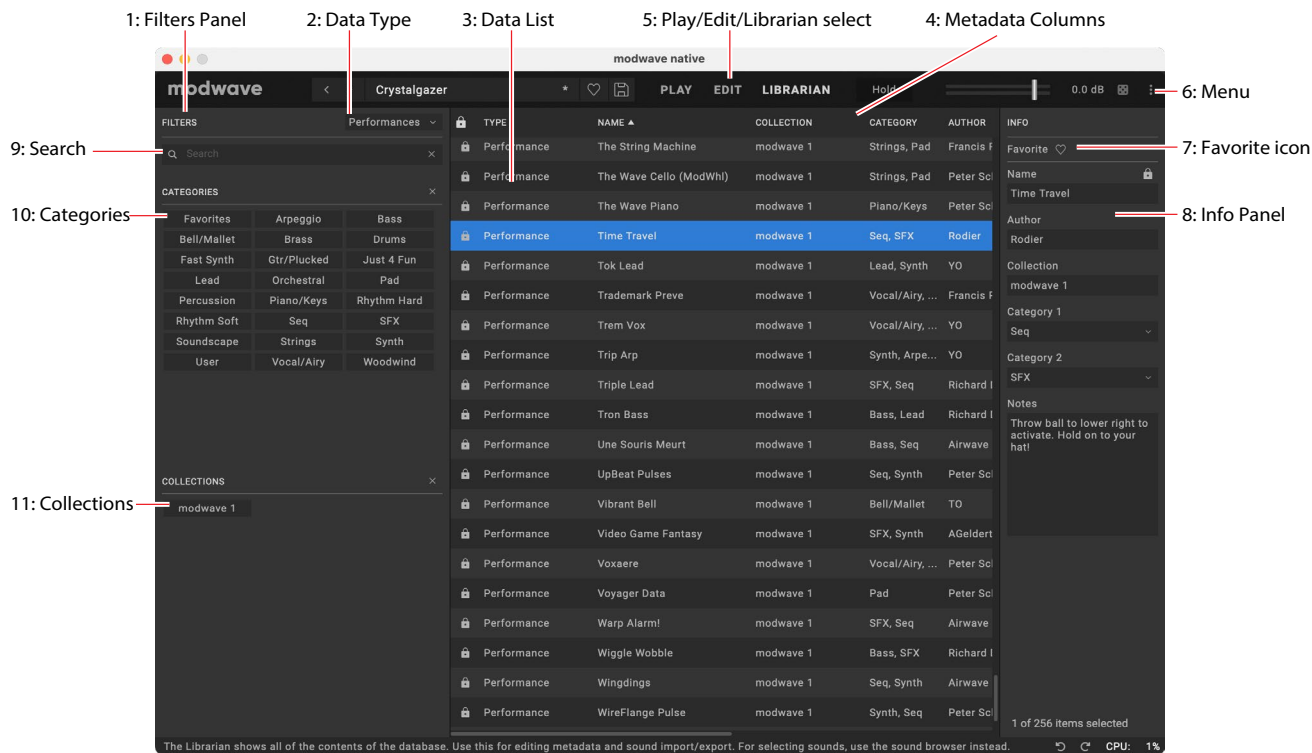

What's the Librarian for?

The Librarian page shows all of the contents of the modwave native. It's most useful for editing metadata for your own sounds, and for importing and exporting data. For selecting sounds, use the pop-up sound browser instead.

1: Filters Panel

The selections here help you narrow down the number of items in the Data List. Set the Data Type, Search, Categories, and/or Collections as desired. The Filters Panel can be resized by dragging its right edge, to show one, two, or three columns of Categories and Collections.

2: Data type

The Librarian can show Performances, Programs, Motion Sequences, Motion Sequence Lane presets, Kaoss Physics presets, Wavetables, Scales, Effects presets, and Set Lists. This menu chooses which type(s) of data are shown in the list. *All Data* shows all types of data at once.

3: Data List

This shows lists of all the data in the modwave native database, as filtered by the Search, Data Type, Category, and Collection settings in the Filters Panel.

Selection

Click on an item in the list to select it for metadata editing or export. Double-clicking on Performances and Set Lists will also select them for playing.

Select multiple non-continuous items by holding down the command key on MacOS, or the Ctrl key in Windows. You can also select a range of items by using Shift.

Lock icons: factory data is write-protected

All of the data shipped from the factory is write-protected, including Performances, Programs, Effects presets, and so on. This is shown by the lock icons in the list and at the top of the Inspector panel. Factory sounds can't be deleted, and their original versions can't be changed, including metadata such as name, author etc. However, you can duplicate them and then edit however you'd like.

4: Metadata columns

For each item, the list shows the Type, Name, Collection, Category, Author, and Notes, as well as whether or not the item is locked factory data. You can drag the top of the columns to re-arrange them, or to resize the columns.

Click on a column heading to sort; click again to reverse the sort order. The triangle icon shows which column is selected for sorting, and the direction of the triangle (up or down) shows the sort order.

5: Play/Edit/Librarian select

The buttons in the upper right of the main window select whether you're working with the Editor or the Librarian. For more information, see "3: Play/Edit/Librarian modes" on page 5.

6: Menu

This menu gives access to overall settings such as CC assignments and the User Sample Bank, undo/redo, user interface size scaling, "About" information, and Librarian-specific commands.

7: Favorite icon

Click on the heart to mark (or un-mark) an item as a Favorite. You can then find them later via the "Favorite" Category. Unlike other metadata, you can change the Favorite setting even for locked factory data.

Favorite icon

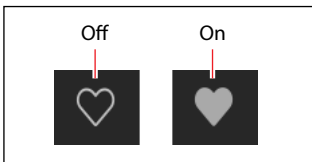

8: Info Panel

This panel lets you view and edit the metadata for the selected items, including the Name, Collection, Categories 1 & 2, Author, and Notes. If more than one item is selected, and the items have different settings for a metadata field (such as the name or category), the field shows the note "<Multiple Values.>"

If the lock icon is shown, the selection includes factory data, and the fields cannot be edited. You can, however, copy text to paste elsewhere.

The Inspector panel can be resized by dragging its left edge.

9: Search

Type into this field to filter the list by searching for text in any of the metadata fields. Click on the "X" to clear the field.

10: Categories

Categories let you filter by the type of sound, such as basses, leads, bells, etc. Each sound can be assigned to two Categories, and each data type—Performances, Programs, etc.—has its own list of Categories. Click on a Category name to filter by that Category; click on the "X" to de-select all Categories.

When searching by Category, a sound will be shown if either of its Categories match the search criteria.

This section also includes "Favorites," which shows all sounds which you've marked as favorites. You can use the Favorites selection in combination with any other Categories.

11: Collections

Categories let you filter sounds by group, such as factory sounds, expansion packs, or your own projects. Each sound can be assigned to one Collection. Click on a Collection name to filter by that Collection; click on the "X" to de-select all Collections.

Librarian contextual menu

Right-click or control-click (macOS) on an item to bring up the contextual menu. Menu commands are still available when multiple items are selected in the list.

Export...

Exports the selected items to individual files on disk. For more information, see “Exporting data” on page 89.

Export Bundle...

This command is available if multiple items are selected. It exports all the selected items to a single file on disk. Use this for distributing a set of sounds, for example.

Duplicate

This duplicates the selected item.

Delete

This removes the selected data. When used with Set List Slots, the Slots are changed to use the Init Performance.

New Set List

This creates a new Set List, with all Slots set to the Init Performance. It is available from the Librarian when showing either All Data or Set Lists.

Open Set List Editor

When a Set List is selected, this opens a Set List window for that Set List. If multiple Set Lists are selected, it opens windows for each of them.

Make Active

When a Performance is selected in the list, this selects the item for playing. (Double-clicking has the same effect.)

When a Set List is selected in the list, this activates that Set List and changes the Set List parameter in the Settings dialog.

Import and export

modwave native reads and writes the same file formats as the hardware modwave’s Editor/Librarian (except for .mwbackup files), so that sounds are fully compatible between the two. The **Import** and **Export** commands let you:

- Load new sounds
- Transfer data between modwave native and the hardware modwave, or from one installation of modwave native to another
- Back up and restore data

Importing data

To import data into modwave native:

1. In the menu, select the Import... command.

A standard file open dialog will appear.

2. Select the file(s) to import.

You can select and import multiple files at once.

3. Press the Open button.

The data in the file(s) will be imported into the database. A message will appear to confirm the import, including information about which files have been added.

Data conflicts

If some of the imported data appears to be different or updated versions of the internal data, a dialog will appear with the text:

“A different or changed item already exists in the database for <item name>”

The dialog offers several options:

Librarian page

Cancel: the item will not be imported.

Overwrite: the item will be imported, replacing the version in the modwave native database.

Make Unique: the item will be imported, and its UUID (see “UUIDs” on page 89) will be changed so that it does not conflict with the version already in the modwave native.

Apply to All: the choice of Cancel, Overwrite, and Make Unique will be applied to all conflicting files in the Import.

If a Set List is imported, and some of its constituent Performances were made unique, then the Set List is edited to point to the new Performances.

UUIDs

modwave native uses a database to keep sounds organized. Internally, sounds are identified not by their names, but rather by a unique tag attached to the file, called a UUID (“Universally Unique Identifier”). This means that even if a sound’s name has been changed, the system still knows it’s the same sound.

When you write a sound, “Overwrite” keeps the UUID the same, and “Save As New” creates a new UUID.

When you import data, the UUIDs in the sounds to be imported are compared with those already in the database. If a sound has the same UUID, but its contents are different, you’ll see the dialog described under “Data conflicts” on page 88.

Exporting data

When exporting two or more pieces of data, you can either save them as separate files or as a single Bundle file.

Exporting as separate files

To export data from modwave native as separate files on disk:

1. **In the Librarian, select the data that you’d like to export.**
2. **Right-click/control-click (macOS) on one of the items, to open the contextual menu.**
3. **In the menu, select the Export... command.**

A standard file open dialog will appear.

4. **Navigate to the location to save the files.**
5. **Press Open to select the current directory and save the files.**

Exporting as a bundle

To export multiple pieces of data from modwave native as a single bundle file:

1. **In the Librarian, select the data that you’d like to export.**
2. **Right-click/control-click (macOS) on one of the items, to open the contextual menu.**
3. **In the menu, select the Export Bundle... command.**
4. **Navigate to the location to save the bundle, and enter a name for the file.**
5. **Press Save to save the bundle file.**

Exporting all user data

To export all of your custom data as a single bundle file, without saving the write-protected factory sounds:

1. **In the menu, select the Export Bundle of All User Sounds... command.**
2. **Navigate to the location to save the bundle, and enter a name for the file.**
3. **Press Save to save the bundle file.**

This exports a bundle of all non-write-protected data, for backing up or transferring all of your custom sounds at once.

Importing and exporting Set Lists

Set Lists refer to up to 64 Performances. When you export a Set List, both the Set List and its referenced Performances are saved together. This makes it easy to import and export groups of sounds.

File Types

modwave native uses the file types below. All of these are compatible with the hardware modwave’s Editor/ Librarian. Note that .mwbackup files, which contain full backups of the hardware modwave, are not supported by modwave native.

Type	Extension	Contents
Performance	mwperf	A single item of the specified type.
Program	mwprog	
Wavetable	mwwavetable	
Kaoss Physics	mwkphysics	
Scale	mwscale	
Motion Sequence	mwmotionseq	
Master Lane	mwmasterln	
Timing Lane	mwtimingln	
Pitch Lane	mwpitchln	
Shape Lane	mwshapeln	
Step Seq Lane	mwstepseqln	
Effect	mweffect	
Set List	mwsetlist	One Set List and all of its referenced Performances
Bundle	mwbundle	Multiple items of any type.

Importing Wavetables

You can import Wavetables in two standard formats. Both formats are specially-prepared .wav files, which contain up to 64 individual waveforms laid out end-to-end, one immediately after the other. Each of the waveforms must be exactly the same length. The two supported formats are:

- 32-bit floating point data, with waveforms exactly 2048 samples long (commonly used by software synthesizers, such as Serum)
- 16-bit linear data, with waveforms exactly 256 samples long (commonly used by modular synth hardware)

The main difference between the two formats is that 2048-sample waveforms allow three more octaves of high harmonics. In practice, this means that bass notes can be brighter in timbre.

 **Important:** .wav files must be in one of the two supported wavetable formats, as described above. Normal audio files, such as recordings of instruments, will not be automatically converted into wavetables.

Importing Wavetables with more than 64 waveforms

modwave native, like many other wavetable synths, crossfades between waveforms in real-time. Some popular wavetable software uses a different approach; instead of crossfading, they create a series of intermediate waveforms and then just switch between them. If the differences between the intermediate waveforms are small, it sounds close enough to a crossfade. To transition between two waveforms, they might create a Wavetable with the first waveform at the start, 254 intermediate waveforms, and then finally the second waveform at the end. To transition this smoothly between 64 different waveforms, they would need to create over sixteen thousand intermediate tables!

modwave native, on the other hand, needs only the 64 original waveforms to create a completely smooth, stepless crossfade. This is kept in mind when importing wavetables. If a 32-bit/2048-sample wavetable has more than 64 waveforms, the modwave native will assume that it's a generated crossfade and drop some of the intermediate waveforms to create a 64-waveform version.

Creating and editing Wavetables

For creating and editing your own Wavetables, we suggest using WaveEdit. WaveEdit is free, and available for MacOS, Windows, and Linux. A version of WaveEdit which is optimized specifically for the modwave, and can create Wavetables in the 32-bit/2048-sample format, can be downloaded here:

<https://github.com/jeremybernstein/modwaveEdit/releases>

The Editor/Librarian can export modwave native-format Wavetables, just like Performances, Programs, etc. However, exported Wavetables cannot be edited. Instead, to make edits to previously imported custom Wavetables:

1. **Open the source file in your Wavetable editing application.**
2. **Edit the Wavetable as desired.**
3. **Save the results to a new .wav file, using the same name as the Wavetable in the modwave native's database.**

Using the same name is important; see "Duplicates and file names," below.

Librarian page

4. In modwave native, Import the .wav file as a Wavetable.
5. When prompted, choose to replace the existing Wavetable.

This will automatically update any existing sounds to use the new version.

Duplicates and file names

.wav-format Wavetables don't have modwave native UUIDs until after they've been imported into the database (see "UUIDs" on page 89). So, to check for duplicate files, modwave native uses the name of the .wav file on disk. If you import a .wav-format Wavetable file, and it has the same name as a Wavetable already in modwave native's database, the Editor/Librarian will ask if you want to overwrite the existing Wavetable, or make a new, unique Wavetable instead.

Set Lists

Set List window

This window shows all 64 Slots of a Set List. You can open multiple Set List windows at once. If one of the windows shows the active Set List (as configured in the Settings dialog), the note “(Active)” appears after its name in the title bar.

Set List window

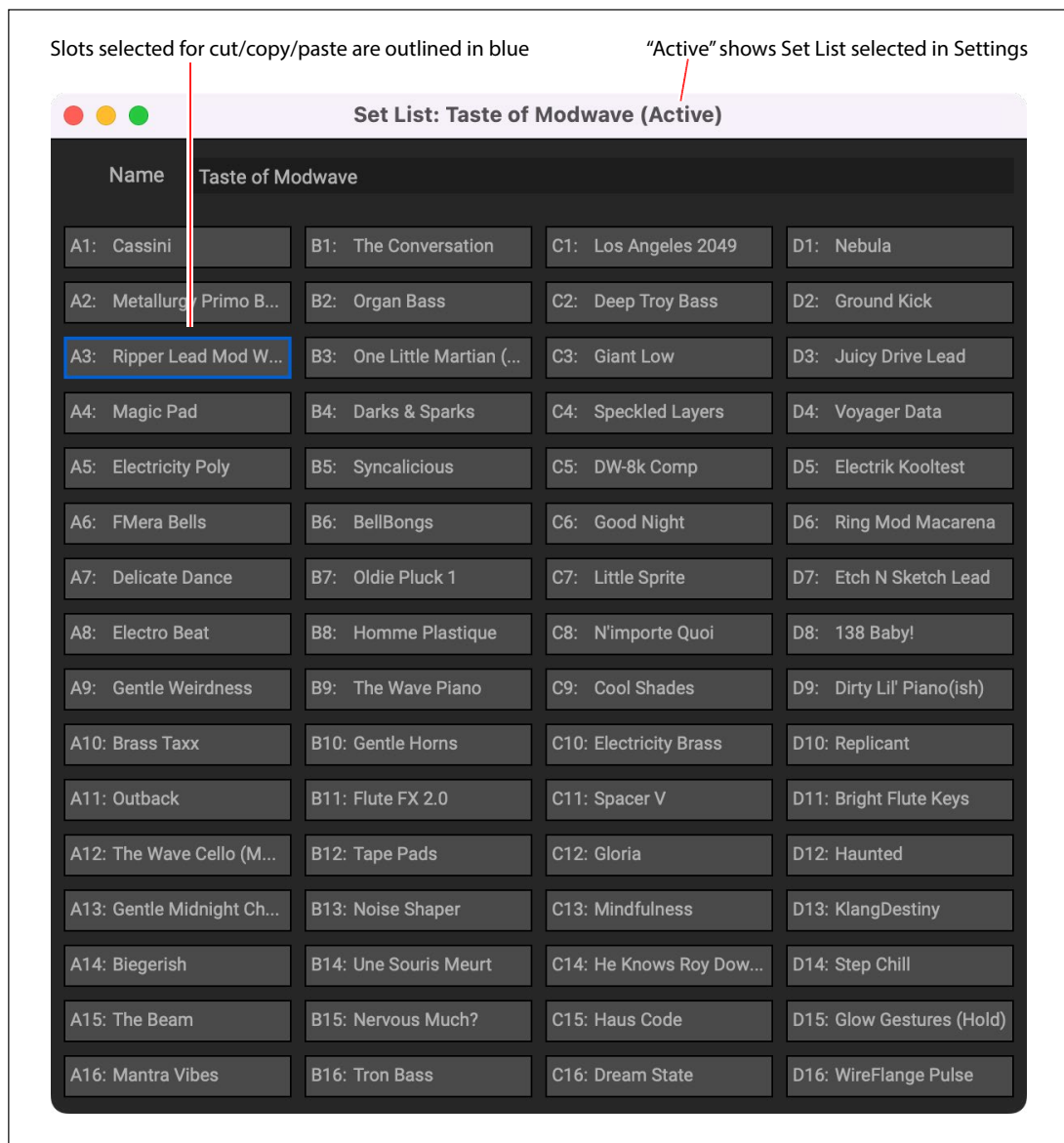

The name of the Set List is shown both in the window’s title bar, and in an editable field at the top of the window. Selected Slots are shown with a blue outline. You can select multiple non-continuous Slots by holding down the command key on MacOS, or the Ctrl key in Windows. Alternatively, select a range of Slots by using Shift.

Using Set Lists

Set Lists let you group and order Performances for gigs or projects. A Set List has 64 Slots, arranged into four banks A-D, corresponding to MIDI Program Change messages 1-64. Note that Set Lists don’t contain separate copies of their sounds; they just point to Performances stored in the database.

 **Note:** Program Change messages are not currently supported for VST3.

Editing Set Lists

Duplicating Set Lists

To duplicate a Set List:

1. In the Librarian, set the Data Type to Set List.
2. Select one or more Set Lists.
3. Right-click/Control-click on one of the selected Set Lists to bring up the contextual menu.
4. Select the Duplicate command.

The selected Set List(s) will be duplicated, with a number appended to their name.

Adding Performances to a Set List

To add Performances to a Set List:

1. In the Librarian, set the Data Type to Set Lists or All Data, and double-click on a Set List.

This will open the Set List window.

2. In the Librarian, set the Data Type to Performances or All Data, and select one or more Performances.
3. Click and hold on a selected Performance, and drag it over a Slot in the Set List window.

The Performance will be pasted over the Slot. If you're dragging multiple Performances, they will be pasted over the Slot and immediately subsequent Slots, as necessary.

Re-arranging Slots in a Set List, or copying from one Set List to another

You can re-arrange the Slots in a Set List, such as using cut, copy, paste, and insert, using either contextual menu commands (right-click, or control-click on MacOS) or drag-and-drop.

You can open multiple Set List windows at once. If one of the windows shows the active Set List, the note "(Active)" appears after its name in the title bar.

Using commands in the contextual menu

To re-arrange Slots using the contextual menu:

1. Select the Slots that you'd like to copy, cut, or delete.

You can select two or more non-continuous Slots using command-click on MacOS, or Ctrl-click in Windows. Alternatively, select a continuous range of Slots by using Shift-click.

2. Select the Cut, Cut and Shift Slots, Copy, or Delete command, as desired.

Bring up the contextual menu by right-clicking/control-clicking on one of the selected Slots. For details on how these work, especially Cut and Shift Slots, see "Cut and Shift Slots" on page 94.

If you delete a Slot, its contents are replaced by the Init Performance.

If using Paste or Insert Before, continue:

3. Select the destination Slot.

 **Important:** if multiple Slots are selected, only the lowest-numbered selection affects the Paste or Insert Before operation; other selections are ignored. For more information, see "Paste" on page 94 and "Insert Before" on page 94.

4. Select the Paste or Insert Before command, as desired.

Using drag-and-drop

To re-arrange Slots using drag-and-drop:

1. Select the Slots that you'd like to copy or cut.
2. Click and drag on top of a Slot to Paste, or to the space between Slots to Insert Before.

The effect on the original Slots depends on whether or not you hold the Option key (MacOS) or Alt key (Windows), and whether you're dragging within a single Set List or from one Set List to another, as shown in the table below.

Destination	Drag action	Edit action	Affect on Original Slots
Same Set List	On top of a Slot	Paste	Changed to Init Performance
	On top of a Slot, holding Option/Alt	Paste	Remain unchanged
	Between Slots	Insert Before	Removed, as with Cut and Shift Slots
	Between Slots, holding Option/Alt	Insert Before	Remain, shifted down with the rest of the Slots

Set Lists

Destination	Drag action	Edit action	Affect on Original Slots
Different Set List	On top of a Slot	Paste	Original Slots always remain unchanged
	Between Slots	Insert Before	

Note that dragging to a different Set List always leaves the original Slots intact; option-drag is not required.

Set List contextual menu

Right-click or control-click (macOS) on a Slot to bring up the contextual menu.

Delete

This removes the selected Slot, and changes it to use the Init Performance.

Note that factory data may not be deleted or changed. Also, there must always be at least one Set List; if there is only a single Set List in the system, it cannot be deleted.

Cut

This cuts the selected Set List Slot(s), placing them on the clipboard, and changes them to use the Init Performance.

Cut and Shift Slots

This cuts the selected Set List Slot(s), and shifts all other Slots to fill in the gap. The newly empty Slots at the end of the Set List will be filled by the Init Performance.

Copy

This copies the selected Set List Slot(s), and places their data on the clipboard for use in Paste or Insert Before.

Paste

This replaces the selected Set List Slot, and potentially subsequent Slots, with the data on the clipboard. If multiple Slots are selected, only the lowest-numbered selection affects the Paste operation; other selections are ignored.

 **Important:** if the clipboard contains multiple Slots, Paste will start with the first selected Slot and then replace as many Slots as necessary, regardless of how many other Slots are selected. For example, if there are four Slots on the clipboard, and you select Slots A3 and A7 and then Paste, Slots A3, A4, A5, and A6 will be replaced with the data from the clipboard.

Insert Before

This inserts the data on the clipboard into the Set List before the selected Set List Slot, and shifts subsequent Slots to make room. Slots at the end of the Set List will be “pushed off the end” and removed.

As with Paste, if multiple Slots are selected, only the lowest-numbered selection affects the Insert Before operation; other selections are ignored.

Duplicate

This duplicates the selected item.

Select All

This selects all Slots in the Set List.

Deselect All

This clears any selected Slots.

New Set List

This creates a new Set List, with all Slots set to the Init Performance. It is available from the Librarian when showing either All Data or Set Lists.

Make Active

When an active Set List window is open, this selects the current Set List Slot. When an inactive Set List window is open, this selects the Performance assigned to the Set List Slot.

Troubleshooting

Please check the following points if you experience problems.

No sound

- Are the main Level or any other volume-related parameters set to 0?
 - Is your computer set to produce sound?
 - If you're using Windows, open the Control Panel and check "Sound and Audio Device Properties."
 - If you're using macOS, check System Settings/Sound and the Audio Devices section of Audio MIDI Setup (in Applications/Utilities).
 - If you're using your computer's sound card, is the sound card set up correctly?
 - If you've connected an audio device to your computer, is the audio device set up so that sound is being output from it?
 - If you're using the stand-alone version, have you made the appropriate settings in the **Audio/MIDI Settings** window? See "Audio/MIDI Settings (standalone only)" on page 17.
-

The sound has clicks, pops, or noise

You may experience clicks, pops, or noise if your computer's CPU is experiencing a heavy load.

If you are having this type of problem, try the following.

- If other applications are running, close them.
 - Reduce the maximum polyphony of the synthesizer you're using.
 - In the **Audio/MIDI Settings** window, increase the audio buffer size. Note that this will also increase the latency (the delay before you hear sound).
-

Sound is delayed

Latency is determined by "the number of samples" x "the number of buffers." If you are using a plug-in host, adjust the buffer size in the host application. If you are using the stand-alone version, go to the **Audio/MIDI Settings** window and set the **Audio Buffer Size** to the lowest setting that still allows stable operation.

Can't control the software synthesizer from a MIDI device connected to the computer

- Are your computer and MIDI device connected correctly?
- Is the connected MIDI device detected by your computer?
- If you're using Windows, open the Control Panel and check Sound and Audio Device Properties/Hardware.
- If you're using macOS, open the MIDI section of Audio MIDI Setup (in Applications/Utilities), and make sure that your MIDI device is detected.
- If you are using the stand-alone version, go to the **Audio/MIDI Settings** window and confirm that the desired MIDI controller is selected.

Specifications

- Maximum polyphony: 32 notes (depending on the computer's CPU)
- Number of Layers: 2
- Presets: 250
- Effects: 31 types
- Modulation: Most parameters can be modulated, including parameters of individual Motion Sequence Steps. Depending on Motion Sequence length, there can be more than 1,000 potential modulation targets per Program.
- Standalone operation or as a VST3/AU/AAX Native plug-in instrument
- Real-time MIDI control and automation is supported

Operating requirements

MacOS

- OS: macOS 10.14 Mojave or later (with latest updates)
- CPU: Apple M1 or better, or Intel Core i5 or better (for Intel, Core i7 or better recommended)
- Memory: 8 GB RAM or more (16 GB RAM or more recommended)
- Storage: 8 GB or more free space (SSD recommended)
- Internet connection
- Plug-in: AU, VST3, AAX (64-bit only)

Windows

- OS: Windows 10 or later, 64-bit (with latest updates); 32-bit operating systems are not supported
- CPU: Intel Core i5 or better (Core i7 or better recommended)
- Memory: 8 GB RAM or more (16 GB RAM or more recommended)
- Storage: 8 GB or more free space (SSD recommended)
- Internet connection
- Plug-in: VST3, AAX (64-bit only)

* Appearance and specifications of this product are subject to change without notice.

Support and service

If you have questions about the product, please contact the Korg distributor for the country in which you purchased it.

Before you contact us

- Before you contact us, check whether this manual or the Korg app Help Center (<https://support.korguser.net>) has an answer for your question.
 - Please be aware that we cannot answer questions about products that are not made by Korg (such as third-party software, controllers, or audio devices), or general questions about creating songs or sounds.
-

Information to provide when contacting us

In order for us to help you, we'll need the following information:

- Your name
- The name and version of the product (you can find the version using the About command in the three-dot menu)
- Your computer hardware and operating system name and version
- Your question (provide as much detail as possible)

Apple, Mac, and the Mac logo are trademarks of Apple Inc., registered in the U.S. and other countries.

Windows 10 is a trademark of Microsoft Corporation in the US and other countries.

All product names and company names are the trademarks or registered trademarks of their respective owners. Specifications and appearance are subject to change without notice for improvement.