

DL8000R

DIGITAL MULTI TAP DELAY

Owner's Manual

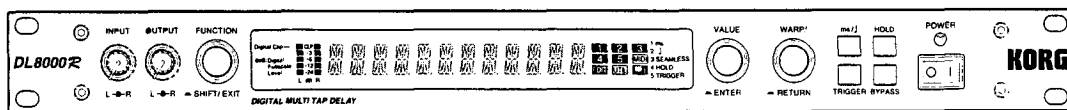

Table of Contents

Controls and Functions	4	Time Mode and Tempo Mode	11
Front Panel	4	Parameter values during mode changes	11
Rear Panel	5	Tap Tempo and Audio Trigger	12
		Tap Tempo delay	12
		Audio Trigger delay	12
		About Note Resolution	12
		Rhythm function	12
Using the DL8000R	6		
Basic Operation	6		
Editing	7		
Main parameter and Sub-parameter	7		
Renaming a Program	7		
Writing	8		
Writing a Program	8		
Writing the Utility parameters	8		
Compare Function	8		
Real Time Control	9		
Control with the [WARP!] knob	9		
Control with the foot pedal or MIDI messages ...	10		
Control with LFO	10		
Control with the envelope	11		
		Appendix	13
		Parameter List	13
		Program Edit mode	13
		Utility mode	14
		About Messages	16
		Troubleshooting	16
		Specifications	17
		MIDI IMPLEMENTATION CHART	18

KORG

Precautions

Location

Using the unit in the following locations can result in a malfunction.

- In direct sunlight
- Locations of extreme temperature or humidity
- Excessively dusty or dirty locations
- Locations of excessive vibration

Power supply

Please connect the designated AC adaptor to an AC outlet of the correct voltage. Do not connect it to an AC outlet of voltage other than that for which your unit is intended.

Handling

To avoid breakage, do not apply excessive force to the switches or controls.

Care

If the exterior becomes dirty, wipe it with a clean, dry cloth. Do not use liquid cleaners such as benzene or thinner, or cleaning compounds or flammable polishes.

Keep this manual

After reading this manual, please keep it for later reference.

Keeping foreign matter out of your equipment

- Never set any container with liquid in it near this equipment. If liquid gets into the equipment, it could cause a breakdown, fire, or electrical shock.
- Be careful not to let metal objects get into the equipment. If something does slip into the equipment, unplug the AC adaptor from the wall outlet. Then contact your nearest Korg dealer or the store where the equipment was purchased.

CE mark for European Harmonized Standards

CE mark which is attached to our company's products of AC mains operated apparatus until December 31, 1996 means it conforms to EMC Directive (89/336/EEC) and CE mark Directive (93/68/EEC).

And, CE mark which is attached after January 1, 1997 means it conforms to EMC Directive (89/336/EEC), CE mark Directive (93/68/EEC) and Low Voltage Directive (73/23/EEC).

Also, CE mark which is attached to our company's products of Battery operated apparatus means it conforms to EMC Directive (89/336/EEC) and CE mark Directive (93/68/EEC).

THE FCC REGULATION WARNING

This equipment has been tested and found to comply with the limits for a Class B digital device, pursuant to Part 15 of the FCC Rules. These limits are designed to provide reasonable protection against harmful interference in a residential installation. This equipment generates, uses, and can radiate radio frequency energy and, if not installed and used in accordance with the instructions, may cause harmful interference to radio communications. However, there is no guarantee that interference will not occur in a particular installation. If this equipment does cause harmful interference to radio or television reception, which can be determined by turning the equipment off and on, the user is encouraged to try to correct the interference by one or more of the following measures:

- Reorient or relocate the receiving antenna.
- Increase the separation between the equipment and receiver.
- Connect the equipment into an outlet on a circuit different from that to which the receiver is connected.
- Consult the dealer or an experienced radio/TV technician for help.

Unauthorized changes or modification to this system can void the user's authority to operate this equipment.

DL8000R

Preset Program List

The ROM area 128~255 contains the preset Programs. You cannot write data in this area.

The User area 0~127 contains the same preset Programs as the ROM area, but you can store your effect Programs in this area.

If you connect the DL8000R with a recording console via the send/return connections, set DIRECT OFFST (sub-parameter of MIX OFFSET) in Utility mode to -INF. With this setting, only the effect sound will be output, but not the direct (dry) sound.

Liste des Programmes d'usine

Les mémoires mortes (128~255) contiennent les Programmes d'usine. Il n'est pas possible d'y sauvegarder des données. La section utilisateur (0~127), par contre, contient des mémoires où vous pouvez sauvegarder vos propres réglages. A la livraison, ces mémoires contiennent les mêmes Programmes que les mémoires mortes.

Si vous reliez le DL8000R aux bornes AUX SEND et RETURN d'une console de mixage, il convient de mettre le paramètre DIRECT OFFST (paramètre auxiliaire MIX OFFSET, Mode Utility) sur -INF. De cette façon, le DL8000R renvoie uniquement le signal d'effet au lieu d'un mélange de signal direct et de signal d'effet.

Preset Program-Liste

Der ROM-Bereich 128~255 enthält die voreingestellten Programme. In diesen Bereich können Sie keine Daten schreiben. Der User-Bereich 0~127 enthält die gleichen voreingestellten Programme wie der ROM-Bereich, aber Sie können Ihre Effekt-Programme in diesem Bereich speichern.

Wenn Sie das DL8000R mit den AUX SEND- und RETURN-Buchsen eines Mischpultes verbinden, müssen Sie den DIRECT OFFST-Parameter (Sub-Parameter der MIX OFFSET-Funktion, Utility-Modus) auf -INF stellen. Dann überträgt das DL8000R nämlich nur das Effektsignal statt einer Mischung von Direkt- und Effektsignal.

プリセット・プログラム・リスト

128~255はROMエリアで、プリセット・プログラムが収められています(このエリアへはライトできません)。

0~127はユーザー・エリアで、工場出荷時はROMエリアと同じプログラムが収められています。新たに作ったエフェクトは、ユーザー・エリアへライト(保存)してください。

レコーディング・コンソール等の SEND、RETURN で本機を使用する場合は、UTILITY モードの DIRECT OFFST (MIX OFFSET のサブ・パラメータ) を -INF に設定してください。このとき、ダイレクト音は出力されずエフェクト音のみ出力されます。

128 TURNTHEWARP	144 TRIPLET	160 RANDOM DELAY	176 ENV+CHORUS	192 EXP*RES	208 REC ELC GTR	224 GROOVE LOOP2	240 WAH FLUTTER
129 MULTITAP DLY	145 PAN DELAY	161 SPACE DELAY	177 JIMI MOD	193 STEREO JET	209 REC GTR SOLO	225 REGGAE*DELAY	241 KAI-MAD-KAI
130 WARP DELAY	146 ST-MOD DELAY	162 DRIPPIN'	178 MONO DLY/CHO	194 SLOW TREM	210 REC A-PIANO	226 SERIESRHYTHM	242 DESSERT
131 MANUAL*MOD	147 OLD DIGITAL	163 2-TAP CHORUS	179 AMBICHORUS*1	195 MIDI TREM	211 REC E-PIANO	227 TEMPOPINGPON	243 SPRING TAP
132 TECHNO*DELAY	148 PWRCRD RIFF	164 MONO CHORUS	180 AMBICHORUS*2	196 VIBE/TREM	212 TWIN PEAKS	228 POLY RHYTHM	244 MAD FLANGE
133 CHORUS/FLANG	149 DIST SOLO	165 ANLG CHORUS	181 RICH CHORUS	197 VIBROFLANGE	213 NIAGARA ECHO	229 FACTORY	245 BUZZER
134 PHAT CHORUS	150 SYNTH SOLO	166 SIMPLECHORUS	182 NOT-IN-PITCH	198 TREM DELAY *1	214 TILE>>>ECHO	230 SCRATCH HOLD	246 PEDAL DLY*1
135 MULTI+FLANGE	151 WARP FEEDDLY	167 CHRS 4 DIST	183 MONO FLANGER	199 TREM DELAY *2	215 HARDVERB	231 REC PERC	247 PEDAL DLY*2
136 TREM CHORUS	152 250MS DELAY	168 WIDE CHORUS	184 SIMPLEFLANGE	200 PAN L))(((R	216 HARDVERB*MOD	232 ISLAND PERC	248 PEDAL DLY*3
137 MONO DELAY	153 500MS DELAY	169 GTR CHORUS	185 FLNG 4 DIST	201 PINGPONGWARP	217 TOMMY ECHO	233 REC STEREO*1	249 PEDAL CHORUS
138 EASY DELAY	154 1000MS DELAY	170 VOX CHORUS*1	186 FLANGE DELAY	202 REC EMT PRE	218 60[BPM]DELAY	234 REC STEREO*2	250 PDL DLY/CHO
139 STEREO SLAP	155 4800MS DELAY	171 VOX CHORUS*2	187 ENV FLANG/CH	203 REC F VOCAL	219 94[BPM]DELAY	235 C-RESONATOR	251 PEDAL FLANGE
140 STEREO DELAY	156 10 SECONDS	172 JC CHORUS	188 FLANGE-180	204 LA VOX DLY*1	220 128[BPM]DLY	236 CELLULAR PHN	252 PEDAL MOD
141 PINGPONG DLY	157 LTR FRM HOME	173 PANNEDCHORUS	189 AMBI-FLANGE	205 LA VOX DLY*2	221 192[BPM]DLY	237 DYNAMIC MIC	253 DYNA-MIDIDLY
142 CROSS DELAY1	158 STILL LIFE	174 RNDM+CHORUS	190 MULTI-FLANGE	206 VOX DOUBLING	222 SHUFFLE DLY	238 CARBON MIC	254 MIDI CLK DLY
143 CROSS DELAY2	159 SPLATTER	175 MULTI+CHORUS	191 RESO*FLANGE	207 REC ACC GTR	223 GROOVE LOOP1	239 HARDSLAYON	255 BYPASS

Thank you for purchasing the Korg DL8000R, digital multi tap delay unit. Please read this Owner's Manual thoroughly to make the best use of this product for an extended period of time, and keep it in a safe place for future reference.

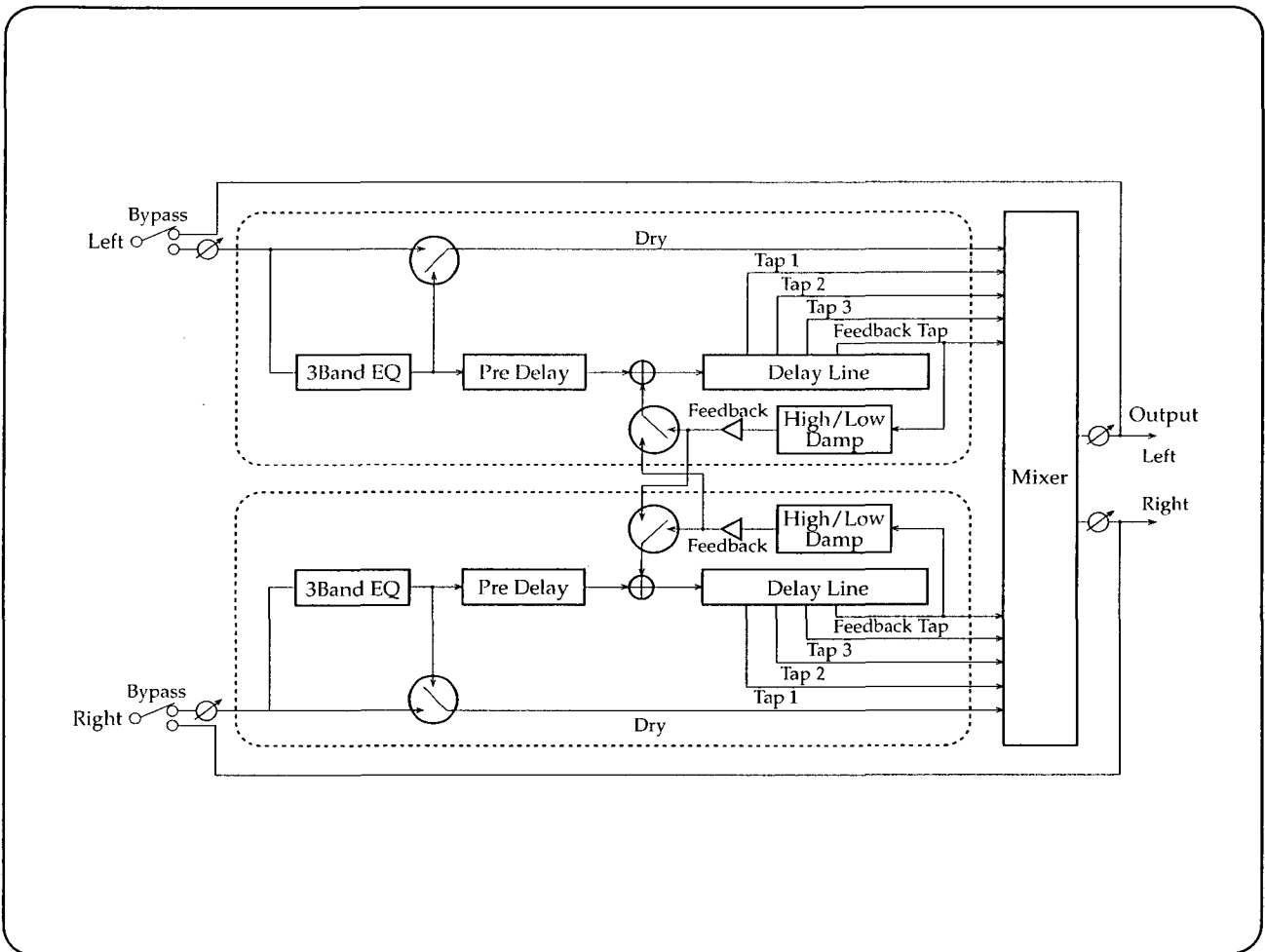

Controls and Functions

Front Panel

[Function] knob

Turning this knob allows you to select a mode, a Program Edit parameter, or a Utility parameter. If you have selected a parameter that has sub-parameters, pressing this knob will cause the LCD to display one of the sub-parameters. Press this knob to move between the layers for main parameters and sub-parameters. (SHIFT/EXIT function)

[VALUE] knob

Turning this knob allows you to select a Program or change the value of the selected parameter. Pressing this knob will allow you to write the Program Edit mode or Utility mode parameters. (ENTER function)

[ms/] key

Press this key to switch between Time mode (ms) and Tempo mode (BPM) (see page 11). In Time mode, the [1] indicator on the right of the LCD lights up. In Tempo mode, the [2] indicator lights up.

Power switch

This switch turns the power to the unit on and off.

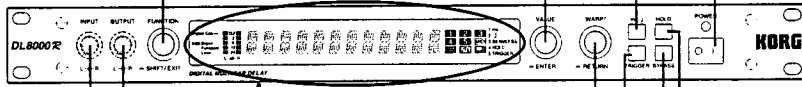

[INPUT] knob

This knob allows you to adjust the left and right input levels.

[OUTPUT] knob

This knob allows you to adjust the left and right output levels.

[WARP!] knob

The DL8000R features a [WARP!] knob that can be assigned parameters for realtime control. (see page 9) Turning this knob will temporarily change the value of the assigned parameter. (The Program selection will not be changed.) How the value changes depends on what parameter has been assigned to the knob. Pressing the knob will reset the changed parameter to the original value. (RETURN function)

[HOLD] key

Pressing this key will cause the delay sound to be output using the current delay time (HOLD function). Press the key again to cancel this function. When this function is enabled, the [4] indicator on the right of the LCD will light up.

[BYPASS] key

Pressing this key will cause a dry sound (non-effect sound) to be output (BYPASS function). Press the key again to cancel the function. When the power is turned off, the setting becomes BYPASS. **▲** With the BYPASS function, the sound input at the INPUT jack will be output with the same volume level. Adjust the level using the connected device.

[TRIGGER] key

Press this key to activate the Audio Trigger delay and the Tap Tempo delay. When the Audio Trigger delay is active, the [5] indicator on the right of the LCD lights up.

Level meter

The level meter indicates the input level. The CLP (clip) indicator will light up if the input level is too high.

[1] This indicator lights up in Time mode.

[2] This indicator lights up in Tempo mode.

[4] This indicator lights up when you use the HOLD function.

[3] This indicator lights up in Seamless mode.

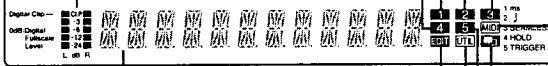

[MIDI]

This indicator lights up when the unit receives MIDI messages.

Display

The display indicates Programs and various parameters.

[EDIT]

This indicator lights up in Program Edit mode. It will flash to caution you if you try to change modes without writing the edited parameter value.

[] (SHIFT)

This indicator flashes if the main parameter displayed in Program Edit mode or Utility mode has a sub-parameter layer. It lights up when the sub-parameter is displayed.

[UTIL]

This indicator lights up in Utility mode. It will flash to caution you if you try to change modes without writing the edited parameter value.

[5]

This indicator lights up when the Audio Trigger delay is active.

Rear Panel

Powered monitor speakers

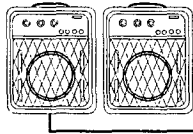

OUTPUT

Mixer

OUTPUT

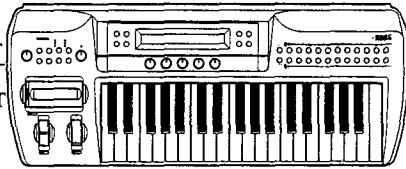

INPUT

Powered monitor speakers/mixer

⚠ The DL8000R outputs a very high-level signal, which may cause connected equipment to be damaged in some cases. Be sure to adjust the output level using the [OUTPUT] knob before connecting to speakers or a mixer.

Connecting a sound source
Connect the AUX SEND jack of a mixer or the output jack of a synthesizer to the DL8000R's INPUT jack. Use the INPUT (L/MONO) jack for a monaural connection.

RETURN

AUX SEND

OUTPUT jack (L, R)

INPUT jack (L/MONO, R)

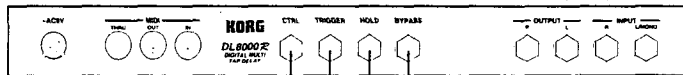

ACIN jack

To the AC outlet

Connecting the power supply
⚠ Be sure to use the AC/AC power supply included in the package.

To a MIDI effect unit

To a computer/sequencer

MIDI OUT connection
Connect the MIDI OUT jack of the DL8000R to the MIDI IN jack of a MIDI device. This connection is primarily used to store data on the MIDI device. You will need a MIDI interface to connect the computer to the DL8000R.

BYPASS jack
Used to activate the Bypass function via a connected pedal switch.

HOLD jack
Used to activate the Hold function via a connected pedal switch.

TRIGGER jack
Used to control the Audio Trigger delay and Tap Tempo delay.

CTRL jack
Used to connect a pedal switch or expression pedal. You will be able to control the DL8000R's various parameters in real time.

To a computer/sequencer/MIDI foot controller/MIDI keyboard/MIDI tone generator, etc.

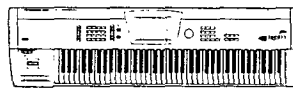

MIDI IN connection
Connect the MIDI IN jack of the DL8000R to the MIDI OUT jack of a MIDI device. This connection is mainly used to control the DL8000R from a MIDI device. You will need a MIDI interface to connect a computer to the DL8000R.

Use an optional foot switch PS-1/2, or an optional expression pedal EXP-2 or XVP-10. Select the foot pedal type in the FOOT PEDAL parameter of Utility mode before using the foot switch or expression pedal.

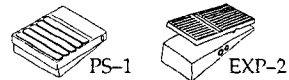

Using the DL8000R

Basic Operation

① Powering up

After you make all connections (refer to "Rear Panel" on page 5), turn on the power switch. The DL8000R will enter Program Select mode and the display will indicate a Program.

⚠ Be sure to lower the volume level of the connected devices before you turn the power on or off.

② Setting the input level

Input the sound from a connected device to the DL8000R, and use the [INPUT] knob to set the appropriate input level. If the level is too high, the CLP indicator on the left of the LCD will light up.

⚠ The CLP indicator may light up, depending on the effect settings, even if the input level is not high. If that is the case, the signal inside the unit circuit is overflowing during digital processing. Lower the internal signal level using the level parameter (MIXER sub-parameter) in the Program Edit mode.

③ Setting the output level

Turn the [OUTPUT] knob to set an appropriate output level.

④ Selecting a Program

Turn the [VALUE] knob to select a Program.

* There are two methods to select a Program on the DL8000R: DIR (direct mode) (factory default) and 2STP (2-step mode).

In Direct mode, turn the [VALUE] knob in Program Select mode to select a Program.

In 2-step mode, select a Program in the same way as in Direct mode, then press the [VALUE] knob once to confirm the selection.

To change modes, go to the PROGRAM sub-parameter in the Utility mode and select PROGRAM MODE.

You may also select a Program by sending MIDI Program Change messages to the DL8000R.

Refer to "Preset Program List" for the factory preset programs.

* When you turn on the power to the DL8000R, the display will indicate the Program number that has been selected for the WAKE UP parameter (PROGRAM sub-parameter) in Utility mode.

⑤ Selecting mode and parameter (Refer to the diagram below.)

When you turn the power on to the DL8000R, it automatically enters the Program Select mode. You can select a Program in this mode.

Turn the [FUNCTION] knob clockwise in Program Select mode to enter the Program Edit mode. The LCD will indicate the Program Edit main parameter, and the [EDIT] indicator will light up. In this mode, you can edit the Program parameters to set up the effect programs.

Turning the [FUNCTION] knob clockwise in the Program Edit mode will cause the DL8000R to enter the Utility mode. The LCD will indicate the Utility main parameter, and the [UTIL] indicator will light up.

In this mode, you can make the basic settings for the DL8000R, including the transmission and reception of MIDI messages.

If the [] indicator flashes while the LCD is indicating the main parameter, it means that the main parameter has a lower layer which contains detailed sub-parameters. Press the [FUNCTION] knob to switch to one of the sub-parameters. (The [] indicator will light up when the LCD indicates the sub-parameter.)

* Either an abbreviated name appears or the full name scrolls on the display as the parameter name. (An abbreviated name is the factory default setting.)

To change modes, select DISPLAY in Utility mode, and press the [FUNCTION] knob to go down to the sub-parameter layer. Turn the [FUNCTION] knob to select ABBREV MODE, and use the [VALUE] knob to select 1 or 2. "1" is abbreviated mode, and "2" is scroll mode.

The ABBREV TIME parameter (DISPLAY sub-parameter) allows you to adjust the time required to switch to the abbreviated name display, and the scroll speed.

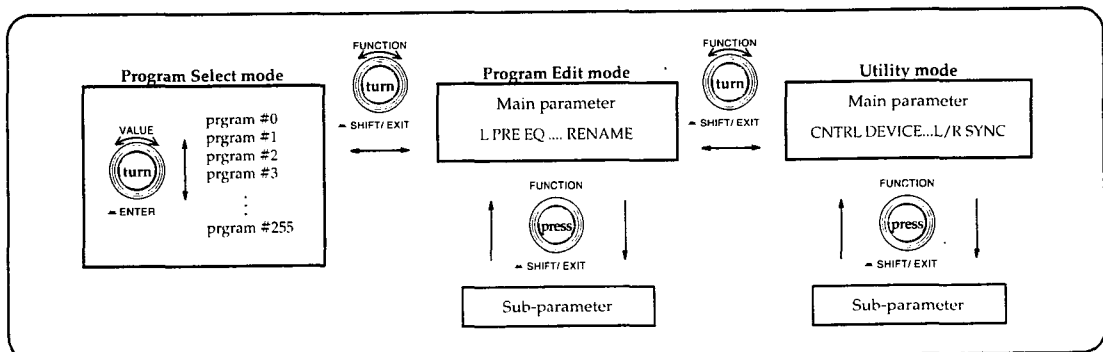

⑥ Operating the [WARP!] knob

All of the factory programs have parameters assigned to the [WARP!] knob for real time control.

⑦ Editing the parameter (see page 7)

You can change the parameter values of the selected Program to create a new effect program.

⑧ Writing (see page 8)

After you create a new effect program or change the Utility parameter, press the [VALUE] knob to store it.

▲ Pressing and holding down the [VALUE] knob for more than two seconds will cause the Compare (see page 8) function to activate, and the LCD will indicate "COMPARE."

▲ If you write a new Program, the data in the destination Program will be overwritten by the new Program data.

▲ All changes will be lost if you turn off the power without writing them to memory.

● Restoring the factory default settings

Select the PRESET parameter (MEMORY sub-parameter) of Utility mode, and press the [VALUE] knob.

▲ If you load the factory preset Programs, all existing Program data will be replaced by the factory preset data, and you will lose the current data forever. Store important data first to a MIDI data filer.

Editing

You can edit the parameters in Program Edit mode to create a new effect program. You can also edit the basic Utility parameters, such as those for the Real Time Control function, according to your purposes.

① Turn the [FUNCTION] knob to select a parameter.

② Turn the [VALUE] knob to change the value.

If the EDIT L/R SYNC parameter of the Utility mode has been set to ON, editing the L (Left) or R (Right) parameter will cause the other parameter value to change simultaneously.

For example, if you wish to set the L and R feedback parameters to the same value, set the EDIT L/R SYNC parameter ON. Then change the value of the L BACK LEVL parameter or the R FBCK LEVL parameter.

If the currently-displayed parameter value is different from its original value, a dot next to the parameter name will light up.

Main parameter and Sub-parameter

The Program Edit mode and the Utility mode have a **two-layer structure**, in which the main parameters are on top of the sub-parameters. To switch between these two layers, press the [FUNCTION] knob.

If the main parameter currently displayed has a sub-parameter, the [] indicator will flash. When the sub-parameter appears, the [] indicator will light up.

Renaming a Program

You can name a Program, using up to twelve characters.

① Turn the [FUNCTION] knob to select the RENAME parameter in Program Edit mode.

② Press the [FUNCTION] knob to enter the sub-parameter layer.

③ Turn the [FUNCTION] knob to select the character you wish to change.

④ Turn the [VALUE] knob to select a new character.

The following table shows 65 characters that can be selected. If you select a space, the LCD will indicate "L".

	!	"	#	\$	%	&	'	()
*	+	,	-	.	/	0	1	2	3
4	5	6	7	8	9	:	;	=	
<	>	?	@	A	B	C	D	E	F
G	H	I	J	K	L	M	N	O	P
Q	R	S	T	U	V	W	X	Y	Z
[]	^	_	`					

Writing

Writing a Program

Store important Programs you have created by changing the parameters in Program Edit mode. If you try to switch to another mode without writing the edits, the [EDIT] indicator will flash.

⚠ If you write a new Program, the data in the destination Program will be overwritten by the new Program data.

⚠ You cannot write data when the WRITE PROTECT parameter (MEMORY sub-parameter) in Utility mode is ON.

① **Press the [VALUE] knob.**

The LCD will indicate the current Program number and the destination Program number.

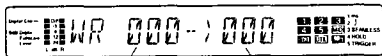

Current Program number Destination Program number

Press the [FUNCTION] knob again to cancel the write operation.

⚠ Pressing the [VALUE] knob for more than two seconds will display "COMPARE" and activate the Compare function (see page 8).

② **Turn the [VALUE] knob to select the destination Program number.**

You can select from 0 through 127. (Numbers 128 through 255 are used for the ROM area and are not available.)

③ **Press the [VALUE] knob.**

The Program will be written into the destination Program. When the Write operation is complete, the display will show "COMPLETED" as follows, then return to the previous indication.

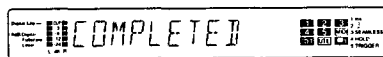

Writing the Utility parameters

If you have edited the value of the Utility parameter and you wish to store the edit, use the Write function. The [UTIL] indicator on the right of the LCD will flash if you try to switch to another mode without writing it.

Unlike the Write function in Program Edit mode, you cannot specify the destination or use the Compare function or the Write Protect function.

⚠ All changes will be lost if you turn off the power without writing them.

① **Press the [VALUE] knob.**

The LCD will indicate the following:

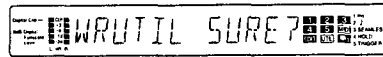

Press the [FUNCTION] knob to cancel the Write operation.

② **Press the [VALUE] knob.**

When the Write operation is complete, the LCD will indicate "COMPLETED" as follows, and return to the previous display.

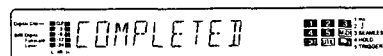

Compare Function

Using the Compare function while editing the parameters in Program Edit mode will allow you to listen to and compare the sound before and after the edit.

① **Press and hold the [VALUE] knob for more than two seconds.**

The Compare function will activate, and the LCD will display the following message:

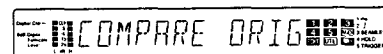

The effect program will be applied with its original parameter settings.

② **Press the [VALUE] knob to use the edited effect settings, and the LCD will indicate the following message:**

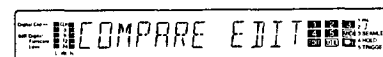

③ **Press the [VALUE] knob again to use the original effect settings, and the LCD will indicate "COMPARE ORIG" as shown in Step ①.**

In this way, you can switch between the original and the edited parameter settings when you press the [VALUE] knob repeatedly.

To quit the Compare function, press the [FUNCTION] knob.

Real Time Control

You can assign parameters to the [WARP!] knob, the CTRL jack, the connected foot pedal, MIDI messages, LFO, input signal envelope, or other controllers to change their values. Operating the assigned controller during performance will cause the parameter settings to change and will allow you to add expression to the phrases you play.

-  After you make the settings for Utility mode or Program Edit mode, be sure to perform the Write function if you wish to save the settings. (p. 8)

Control with the [WARP!] knob

All of the factory programs have parameters assigned to the [WARP!] knob for real time control.

On the DL8000R, you can set the parameter that is assigned to the [WARP!] knob for each individual Program.

For example, follow the procedure below so that rotating the [WARP!] knob for two complete turns will change the L FBACK LEVL value (the amount of feedback) in Program Edit mode from the current value to -6:

<Setting the Utility mode>

- ① Turn the [FUNCTION] knob to select the CNTRL DEVICE parameter in Utility mode. The [UTIL] indicator will light up, indicating that the unit enters Utility mode. Also, the [] indicator will flash, indicating that the parameter has its sub-parameter.
 - ② Press the [FUNCTION] knob to go down to the sub-parameter layer.
 - a Rotate the [FUNCTION] knob to select one of CONTROLLER1-8. CONTROLLER1 is selected here as an example.
 - b Turn the [VALUE] knob to select the WARP! parameter. If you select a controller here, such as a pedal or a MIDI control change, you can change the feedback amount using such a controller.
 - ③ Press the [FUNCTION] knob to go back to the main parameter layer.

<Setting the Program Edit mode>

- ④ Turn the [FUNCTION] knob counter-clockwise to select one of EXPRESSION1-8 in Program Edit mode. The [EDIT] indicator will light up, and the [] indicator will flash. Select EXPRESSION1 as an example.
 - ⑤ Turn the [VALUE] knob to set this ON.
 - ⑥ Press the [FUNCTION] knob to enter the sub-parameter layer.
 - a Turn the [FUNCTION] knob one click clockwise to select EXP1 SOURCE. Select CR1 here as an example.
 - b Turn the [VALUE] knob to set the parameter for the control device that was selected in Step ②a. Select CR1 here as an example.
 - c Turn the [FUNCTION] knob one click counter-clockwise to select EXP1 TARGET, and turn the [VALUE] knob to select a parameter to control. Select L FBACK as an example.
 - d Turn the [FUNCTION] knob two clicks clockwise to select EXP1 RANGE, and turn the [VALUE] knob to set the parameter to -6.
 - e Turn the [FUNCTION] knob one click clockwise to select EXP1 POLARTY, and turn the [VALUE] knob to set the parameter to +. If you set the knob to "+," rotating the [WARP!] knob clockwise will cause the value to approach the value specified in Step ⑥d. If you set to "-," rotating the [WARP!] knob counter-clockwise will cause the value to approach the value specified in Step ⑥d.
 - ⑦ Press the [FUNCTION] knob to go back to the main parameter layer.
 - ⑧ Turn the [FUNCTION] knob clockwise to select WARP! RESLT, and turn the [VALUE] knob to set to "2." The WARP! RESLT parameter is used to set the resolution of the [WARP!] knob, that is, how many times you need to rotate the [WARP!] knob to reach the value specified in Step ⑥d. If you set the parameter to "2," the value of the target parameter (L FBLVL in this example) will change from the current value to (-6) when you rotate the knob two complete turns.

<Operating the [WARP!] knob>

After you finish setting the WARP parameter, you can perform the following operations:

- **Turning the [WARP!] knob clockwise will cause the feedback value to increase gradually, and when you turn it for two rounds, the RANGE1 value (-6) will be reached. Turning the knob counter-clockwise will cause the feedback value to decrease.**

The parameter will change while you turn the WARP! RESL knob around twice. If the EXP1 POLARTY setting is "+," turning the knob clockwise will cause the value to increase up to the EXP1 RANGE value, and turning it counter-clockwise will cause the value to go back to the original value.

- **Pressing the [WARP!] knob after you turned the knob will reset the parameter to its original value.**

Control with a foot pedal or MIDI messages

You can control parameters by operating a foot pedal connected to the CTRL jack, or by sending MIDI Control Change, MIDI Velocity, or other MIDI messages to the DL8000R.

For example, follow the procedure below to change the L TAP1 LEVEL parameter from the current value to 0dB when the DL8000R receives MIDI Control Change 1.

<Utility mode setting>

- ① **Follow the steps ①-③ in the "Control with the [WARP!] knob" section. Select CC001 in Step ②b.**

Select PEDAL in Step ②b if you wish to control the parameter from a foot pedal connected to the CTRL jack.

<Program Edit mode setting>

- ② **Turn the [FUNCTION] knob counter-clockwise to select EXPRESSION1-8 in the Program Edit mode.**
Select EXPRESSION1 here as an example.
- ③ **Turn the [VALUE] knob to set this to ON.**
- ④ **Press the [FUNCTION] knob to switch to the sub-parameter layer.**
 - a **Turn the [FUNCTION] knob one click clockwise to select EXP1 SOURCE, and turn the [VALUE] knob to set the control device you have selected in Step ①.**
Select CR1 as an example.

- b **Turn the [FUNCTION] knob one click counter-clockwise to select EXP1 TARGET, and turn the [VALUE] knob to select a parameter to change.**

L1 LVL is selected here as an example.

- c **Turn the [FUNCTION] knob two click clockwise to select EXP1 RANGE, and turn the [VALUE] knob to set the parameter to 0dB.**

- d **Turn the [FUNCTION] knob one clicks clockwise to select EXP1 POLARTY, and turn the [VALUE] knob to set the direction of change.**

With the + setting, the parameter setting will become the current value when the MIDI Control Change data byte is 0. As the MIDI Control Change byte increases, the setting approaches the value specified in Step ④c.

With the - setting, the parameter setting will become the current value when the MIDI Control Change data byte is 127 (=7F). As the MIDI Control Change byte decreases, the setting approaches the value specified in Step ④c.

Control with LFO

The parameters can be also controlled with the LFO. For example, follow the steps below to modulate the L FBTAP TIME parameter using the LFO.

<Settings in Program Edit mode>

- ① **Turn the [FUNCTION] knob counter-clockwise to select LFO in Program Edit mode, and turn the [VALUE] knob to set it to ON.**
- ② **Press the [FUNCTION] knob to switch to the sub-parameter layer.**
 - a **Turn the [FUNCTION] knob to select LFO SPEED, and turn the [VALUE] knob to adjust the LFO speed.**
- ③ **Press the [FUNCTION] knob to return to the main parameter layer, and turn the [FUNCTION] knob counter-clockwise to select L FBTAP TIME.**
- ④ **Press the [FUNCTION] knob to switch to the sub-parameter layer.**
 - a **Turn the [VALUE] knob to set L FBTAP MOD to ON.**
 - b **Turn the [FUNCTION] knob one click clockwise to select MOD SRC, and turn the [VALUE] knob to set it to LFO.**

- c Turn the [FUNCTION] knob one click clockwise to select MOD DPTH, and turn the [VALUE] knob to adjust the depth. You can "expand" the modulation effect by setting the same value to the R FBTAP TIME main parameter and slip the right and left LFO out of phase with each other using the LFO PHASE sub-parameter (LFO sub-parameter).

Control with the envelope

The parameters can be also controlled with the input signal envelope.

For example, to control the L FBTAP TIME main parameter using the envelope, follow the procedure below:

<Setting the Utility parameters>

- ① Turn the [FUNCTION] knob clockwise to select AUDIO CNTRL in Utility mode, and press the [FUNCTION] knob to switch to the sub-parameter layer.
 - a Turn the [FUNCTION] knob to select ENVELOP SENS, and turn the [VALUE] knob to adjust the envelope sensitivity.
 - b Turn the [FUNCTION] knob clockwise to select ENVELP RELEAS, and turn the [VALUE] knob to adjust the envelope's release time.
- ② Press the [FUNCTION] knob to return to the main parameter layer.

<Setting the Program Edit parameters>

- ③ Turn the [FUNCTION] knob counter-clockwise to select L FBTAP TIME, and press the [FUNCTION] knob to switch to the sub-parameter layer.
 - a Turn the [VALUE] knob to set L FBTAP MOD to ON.
 - b Turn the [FUNCTION] knob one click clockwise to select LFB MOD SRC, and turn the [VALUE] knob to select ENV.
 - c Turn the [FUNCTION] knob one click clockwise to select LFB MOD DPTH, and turn the [VALUE] knob to adjust the depth.

Time Mode and Tempo Mode

Pressing the [ms/♪] key on the front panel allows you to toggle between Time mode and Tempo mode. In Time mode, the [1] indicator on the right of the LCD will light up, and in Tempo mode, the [2] indicator will light up.

You can set the delay time for the Feedback Tap and Taps 1-3 in milliseconds in **Time mode**, which allows you to create a complex Tap Tempo delay. If you set the delay time using the [TRIGGER] key in real time, only the Feedback Tap delay time will be set (but not the delay time for the Taps 1-3).

Setting the value of the TEMPO and L RHYTHM PAT (R RHYTHM PAT) parameters in the **Tempo mode** will cause the Feedback Tap delay time, and the delay time and level of Taps 1-3 to be automatically generated. Also, setting the tempo using the [TRIGGER] key in real time will cause the Feedback Tap delay time and the delay time and level of Taps 1-3 to be automatically specified based on the real time rhythm pattern.

Parameter values during mode changes

When you switch to another mode, the parameter values will also change. However, if you return to the previous mode without editing the parameters, the original values will be restored.

<Time mode → Tempo mode>

The L FBTAP TIME parameter set in Time mode will be converted to TEMPO. The L RHYTHM PAT and R RHYTHM PAT parameters will indicate the rhythm pattern previously set in Tempo mode. However, they will not be converted from the values set in Time mode. You will need to specify these values again so that the L RHYTHM PAT and R RHYTHM PAT settings will become valid. If you change the TEMPO value before setting the L RHYTHM PAT and R RHYTHM PAT value, the Tap delay time will be changed according to the L RHYTHM PAT and R RHYTHM PAT parameters, but the Tap level will not be changed.

<Tempo mode → Time mode>

The delay time and level of each Tap that was automatically set by the rhythm parameter in Tempo Mode can be adjusted by the following parameters:

Delay time: L TAP1 TIME-L TAP3 TIME, R TAP1 TIME-R TAP3 TIME, L FBTAP TIME, R FBTAP TIME (These are main parameters).

Level: L TAP1 LEVEL-L TAP3 LEVEL, R TAP1 LEVEL-R TAP3 LEVEL, L FBTAP LEVL, R FBTAP LEVL (These are MIXER's sub-parameters).

Tap Tempo and Audio Trigger

You can set the delay time in real time using the [TRIGGER] key or a connected foot switch. There are two methods by which to achieve this: Tap Tempo delay and Audio Trigger delay.

To use a foot switch, first connect the foot switch to the TRIGGER jack on the DL8000R and select the type of a foot pedal in the FOOT PEDAL parameter in Utility mode.

Tap Tempo delay

When you press the [TRIGGER] key (or the foot pedal) a few times, the time interval between the last two hits will be defined as the note duration for the R-TAP parameter, which specifies the tempo. Using this tempo as a reference, the DL8000R will automatically generate the Feedback Tap delay time (or the length the rhythm pattern cycle in Tempo mode).

Press the [TRIGGER] key (or a foot pedal) a few times lightly to select the Tap Tempo delay.

Audio Trigger delay

The DL8000R detects an input signal in excess of the threshold and interprets it as a trigger signal. The time interval between two trigger signals will be defined as the note duration for the R-AUD parameter, which specifies the tempo. Using this tempo as a reference, along with the FACTOR parameter, the DL8000R will automatically generate the Feedback Tap delay time (or the length of one rhythm pattern cycle in Tempo mode).

Use the TRIGGER THR parameter (AUDIO CNTRL sub-parameter) in the Utility mode to adjust the threshold level.

Press the [TRIGGER] key (or the foot pedal) for more than one second to enter the Audio Trigger delay setting mode.

About Note Resolution

The delay time is determined by the tempo value and the FACTOR parameter. In the RESULT TAP, RESULT AUDIO, and RESULT MIDI parameters, you can specify which note will define the input tempo.

You can enter the tempo value in the TEMPO parameter of Program Edit mode (in Tempo mode), using the Tap Tempo or Audio Trigger technique, or sending MIDI clock to the unit.

The NOTE RESULT FACTOR parameter allows you to specify which note will be used to define the delay time based on the input tempo.

For example, if you wish to set the delay time to the

same length as the tempo, set the FACTOR to 1.

FACTOR setting and delay time

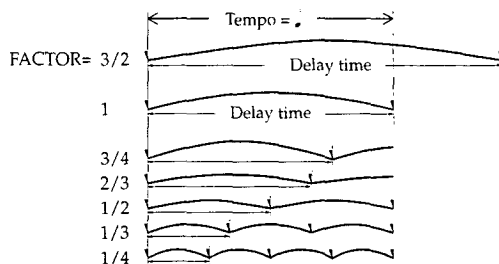

Rhythm function

The Rhythm function of the DL8000R treats the delay time specified by the tempo and the FACTOR parameter as one cycle, uses it to adjust the Tap delay time and level, and automatically generates a rhythm sequence of up to four notes per channel.

1. Press the [ms/♩] key to switch to Tempo mode.

The [2] indicator on the right of the LCD will light up in Tempo mode.

2. Turn the [FUNCTION] knob to select L RHYTHM PAT or R RHYTHM PAT in Program Edit mode.

Select L RHYTHM PAT here as an example.

3. Turn the [VALUE] knob to select the rhythm pattern.

The rhythm pattern is expressed as a note duration such that one cycle equals one quarter note. Therefore, the actual length of one pattern cycle is obtained by the length of the corresponding tempo's quarter note multiplied by the FACTOR value.

The pattern consists of Taps 1–3 and FB.

To add a subtle rhythmic nuances, go to Time mode after you select the pattern, adjust the Tap delay time in the L TAP1 TIME–L TAP3 TIME, L FBTAP TIME parameter, and adjust the level and pan values in the MIXER parameter.

Appendix

Parameter List

Program Edit mode

LEFT PRE EQ* (L PRE EQ)	[OFF, ON]
Set this ON when you are using the pre-delay-line equalizer.	
L LOW GAIN* (L LOW G)	[-15...+15dB]
Used to adjust the gain of the low-range equalizer.	
L LOW FREQ* (L LOW F)	[31.5Hz...1KHz]
Used to adjust the cut-off frequency of the low-range equalizer.	
L MID GAIN* (L MID G)	[-15...+15dB]
Used to adjust the gain of the mid-range equalizer.	
L MID FREQ* (L MID F)	[80Hz...8KHz]
Used to adjust the peak frequency of the mid-range equalizer.	
L MID Q* (L MID Q)	[0.3...10]
Used to adjust the bandwidth of the mid-range equalizer.	
L HIGH GAIN* (L HI G)	[-15...+15dB]
Used to adjust the gain of the high-range equalizer.	
L HIGH FREQ* (L HI F)	[1...16KHz]
Used to adjust the cut-off frequency of the high-range equalizer.	
L EQ LEVEL* (L LVL)	[-INF...6dB]
Used to correct the level that was amplified or attenuated by the equalizer.	
L PRE DELAY* (L PREDLY)	[0...400ms]
Used to set the initial delay time in milliseconds.	
L TAP1...3 TIME* (L1...3 TIME)	[0.1...4800ms]
Displayed in Time mode . Used to adjust the Tap delay time in milliseconds.	
L TAP1...3 MOD* (L1...3 MOD)	[OFF, ON]
Set this to ON to modulate the delay time.	
L1...3 MOD SOURC* (L1...3 SRC)	[LFO, ENV, CR1...8]
Used to select the source to modulate. Options are LFO, Envelope, Controllers 1-8.	
L1...3 MOD DEPTH* (L1...3 DPTH)	[0...99]
Used to adjust the depth of modulation if LFO or ENV has been selected for L1-3 SRC.	
L1...3 TRGT TIME* (L1...3 TRGT)	[0.1...4800ms]
Used to set the delay time when the controller has the maximum value if CR1-8 has been selected for L1-3 SRC.	
L1...3 MOD PLRTY* (L1...3 MPLRTY)	[+, -]
Used to set the direction of the controller operation if CR1-8 has been selected for L1-3 SRC.	
LFBTAP TIME* (LFBTIME)	[0.1...4800ms]
Displayed in Time mode . Used to adjust the Feedback Tap delay time in milliseconds.	
LFBTAP MOD* (LFB MOD)	[OFF, ON]
Set this to ON to modulate the delay time with the controller.	
LFB MOD SRC* (LFB SRC)	[LFO, ENV, CR1...8]
Used to select the modulation source. Options are LFO, Envelope, Controllers 1-8.	
LFB MOD DPTH* (LFB DPTH)	[0...99]
Used to adjust the modulation depth if LFO or ENV has been selected for LFB SRC.	
LFB TRGT TIM* (LFBTRGT)	[0.1...4800ms]
Used to set the delay time when the controller has the maximum value if CR1-8 has been selected for LFB SRC.	
LFB M PLRTY* (LFB MPLRTY)	[+, -]
Used to set the direction of the controller operation if CR1-8 has been selected for LFB SRC.	
TEMPO (TEMPO)	[♩ = 50...208]
Displayed in Tempo mode . Used to set the left and right Feedback Tap delay time in BPM units. Setting the L PTRN (or R PTRN) parameter will automatically set the delay time of the left and right Taps. The delay time set here will be also used in Time mode.	
FACTOR (FACTOR)	[X1/4...X4]
Used to set the length of the delay time for the corresponding Tempo.	
TEMPO MOD (T MOD)	[OFF, ON]
Set this to ON to modulate the tempo.	
T MOD SOURCE (T SRC)	[LFO, ENV, CR1...8]
Used to select the modulation source. The options are LFO, Envelope, Controller 1-8.	
T MOD DEPTH (T DEPTH)	[0...99]
Used to adjust the modulation depth if LFO or ENV has been selected for T SRC.	
T MOD RANGE (T RANGE)	[50...208]
Used to set the tempo value when the controller has the maximum value if CR1-8 has been selected for T SRC.	
T MOD PLRTY (T MODPLRTY)	[+, -]
Used to set the direction of the controller operation if CR1-8 has been selected for T SRC.	
L RHYTHM PAT* (L PTRN)	[♩ ... ♪♪♩]
Displayed in Tempo mode . Used to select a rhythm. (The tap delay time and level will be automatically specified.)	
LFBACK LEVL* (LFBACK)	[-INF...0dB]
Used to specify the feedback amount.	
LFBACK PLTY* (LFB PLRTY)	[+, -]
Used to specify positive or negative feedback.	
LLOW DAMP* (L L-DMP)	[THRU, 31.5Hz..1KHz]
Used to specify the low frequency range that will be attenuated at each feedback level.	
LHIGH DAMP* (L H-DMP)	[THRU, 16...1KHz]
Used to specify the high frequency range that will be attenuated at each feedback level.	
LFO (LFO)	[OFF, ON]
Turn this ON when you are using the LFO.	
LFO SPEED (LFO SPD)	[0.01...16Hz]
Used to adjust the LFO speed.	
LFO PHASE (LFO PHAS)	[0...180deg]
Used to adjust the difference between the left and right LFO phases.	
LFO TYPE (LFO TYPE)	[SIN, TRI, EXP, LOG, RND]
Used to set the type of waveform.	
LFO TRIGGER (LFO TRIG)	[OFF, ON]
Turn this ON to oscillate the LFO in sync with the input signal.	
LFO TRIG THR (TRIG THR)	[-36...0dB]
Used to adjust the threshold level at which the LFO oscillation is triggered.	

* These parameters are set for left and right delay lines. The letter "L" before the parameter name means "left" parameter, and "R" means "Right" parameter.

FB TYPE (FB TYPE) [NORM, CROS]

Feedback inside each delay line with the **NORM** setting.
Feedback across the delay lines with the **CROS** setting.

L DLY INPUT* (L DLY IN) [ON, OFF]
Delay line input switch.
Signal is input to the delay line with the **ON** setting.
No signal is input with the **OFF** setting.

MIXER (MIXER)

This parameter group allows you to specify each Tap level and pan position, and the direct sound level and pan position.

DELAY LEVEL (DLY LVL) [-INF...0dB]
Used to adjust the output level of the delay sound.

DLY L/R BAL (DLY BAL) [L20...C0...R20]
Used to adjust the output balance of the left and right delay sound.

L TAP1...3 LEVEL* (L1...3 LVL) [-INF...0dB]
Used to adjust the volume level balance of each Tap.

L TAP1...3 PAN* (L1...3 PAN) [L20...C0...R20]
Used to adjust the pan position of each Tap.

L1...3 POLARITY* (L1...3 PLRTY) [+ , -]
Used to adjust the phase of each Tap.

L FBTAP LEVL* (LFB LVL) [-INF...0dB]
Used to adjust the volume level balance of feedback Tap.

L FBTAP PAN* (LFB PAN) [L20...C0...R20]
Used to adjust the pan position of feedback Tap.

LFB POLARITY* (LFB PLRTY) [+ , -]
Used to adjust the phase of feedback Tap.

DIRECT (DIR) [PRE_EQ, POST_EQ]
The direct input sound will be output unprocessed with the **PRE_EQ** setting.
The direct input sound will be EQ'd before being output with the **POST_EQ** setting.

DIRECT LEVEL (DIR LVL) [-INF...0dB]
Used to adjust the output level of the direct sound.

DIR L/R BAL (DIR BAL) [L20...C0...R20]
Used to adjust the output balance between left and right direct sound.

NOTE RESLT (NOTE RESLT)

This parameter group allows you to set the note resolution for the delay time specified in the Tempo mode.
Refer to "About Note Resolution" on page 12 for more information about the length of the delay time.

FACTOR (FACTOR) [X1/4...X4]
Used to set the length of the delay time for the corresponding Tempo.

RESLT TAP (R-TAP) [♪...]
Determines the note resolution for setting the delay time with the Tap Tempo technique.

RESLT AUDIO (R-AUD) [♪...]
Determines the note resolution for setting the delay time with the Audio Trigger technique.

RESLT MIDI (R-MIDI) [♪... , OFF]
Determines the note resolution for setting the delay time with the MIDI clock.

EXPRESSION 1...8 (EXP1...8) [OFF, ON]

When this is **ON**, you can control the parameters in real time using the LFO, Envelope, or Controller.

EXP1...8 TARGET (TG1...8) [L FBCK...DIR LVL]
Used to specify a parameter to be controlled by EXP 1-8.
You may not be able to select some parameters here depending on the SRC 1-8 settings.

EXP1...8 SOURCE (SRC1...8) [LFO, ENV, CR1...8]
Used to select the control source. Options are LFO, Envelope, and Controller 1-8.
You may not be able to select some sources here depending on the TG 1-8 settings.

EXP1...8 DEPTH (DPHT1...8) [0...99]
Used to adjust the control depth if LFO or ENV has been selected for SRC1-8.

EXP1...8 RANGE (RANGE1...8) [According to the TG1-8 setting]
Used to set the parameter value when the controller has the maximum (minimum) value if CR1-8 has been selected for SRC1-8.

EXP1...8 POLARTY (POLARITY1...8) [+ , -]
Used to set the direction of the controller operation if CR1-8 has been selected for SRC1-8.

WARP! RESLT (WARP) [0...20]

Used to set the resolution of the [WARP!] knob.

RENAME (RENAME)

Used to name the Program.
Use the [FUNCTION] knob to specify the position of the character, and select a letter using the [VALUE] knob.

Utility mode

CNTRL DEVICE (CNTRL DEVICE)

These parameters are used to assign the control devices to Controller 1-8.

CONTROLLER1...8 (CR1...8) [WARP!, PEDAL, CC0...120, A.TOUCH, PBEND, VELOCITY, NOTE_NUM]
Allows you to assign the control device, such as the [WARP!] knob, foot pedal connected to the control jack, and MIDI Control Change messages as a controller.

CONTROL INIT (CTL INIT) [ENA, DIS]
Selecting **ENA** (Enable) will cause the controller to be initialized when the Program is changed.

MIDI (MIDI)

This parameter group allows you to set the MIDI-related parameters.

MIDI CHANNEL (MIDI CH) [1...16]
Used to set the MIDI channel.

PROG CHANGE (PROG CHG) [ENA, DIS]
Select **ENA** (Enable) to transmit/receive the MIDI Program Change messages.

CTRL CHANGE (CTRL CHG) [ENA, DIS]
Select **ENA** (Enable) to transmit/receive the MIDI Control Change messages.

EXCLUSIVE (EXCLUSIV) [ENA, DIS]
Select **ENA** (Enable) to transmit/receive the MIDI Exclusive data.

DUMP CURRENT (CURNT [DUMP])
Selecting this parameter and pressing the [VALUE] knob will cause the current Program to be transmitted as Exclusive data. (Data will be transmitted regardless of the setting of the EXCLUSIV parameter.)

DUMP ALL (ALL [DUMP])
Selecting this parameter and pressing the [VALUE] knob will cause all the Programs to be transmitted as Exclusive data. (Data will be transmitted regardless of the setting of the EXCLUSIV parameter.)

* These parameters are set for left and right delay lines. The letter "L" before the parameter name means "left" parameter, and "R" means "Right" parameter.

ms/♩(ms/♩)	[CC0...120]
HOLD (HOLD)	[CC0...120]
BYPASS (BYPASS)	[CC0...120]

Used to assign MIDI Control Change numbers to the [ms/♩] key, [HOLD] key, and [BYPASS] key on the front panel. Receiving the MIDI Control Change number assigned here will cause the same action as when you press these keys on the front panel.

Pressing these keys on the front panel will cause the MIDI Control Change number set here to be transmitted.

TRIG (TRIG)	[CC0...120]
-------------	-------------

Used to assign the MIDI Control Change number to the [TRIGGER] key on the front panel.

Receiving the MIDI Control Change number assigned here will activate the Audio Trigger delay.

Pressing and holding down the [TRIGGER] key for more than one second will cause the assigned MIDI Control Change number to be transmitted with the Audio Trigger timing.

TAP (TAP)	[CC0...120]
-----------	-------------

Used to assign the MIDI Control Change number to the [TRIGGER] key on the front panel.

Receiving the MIDI Control Change number assigned here will activate the Tap Tempo delay.

Pressing the [TRIGGER] key quickly will cause the assigned MIDI Control Change number to be transmitted.

PROGRAM (PROGRAM)

These parameters are the settings related to the selection of Programs.

PROGCHG MODE (PC MODE)	[DIR, 2STP]
------------------------	-------------

Used to set the method of Program selection.

With the **DIR** setting, the Program selection will be confirmed when you turn the [VALUE] knob to select the Program.

With the **2STP** setting, the Program selection will be confirmed when you press the [VALUE] knob after turning the [VALUE] knob and selecting the Program. In this case, the Program number will flash until the selection is confirmed. Once you press the [VALUE] knob, a new Program will be selected.

SEAMLESS (SEAMLESS)	[OFF, ON]
---------------------	-----------

With this parameter **ON**, the delay sound before the Program was changed will remain.

The delay you set before changing Programs applies to the sound until you change Programs, at which point, the new Program delay will be applied to the sound.

With this parameter **OFF**, all sound will be off at the moment when you change the Program, and the previous Program sound will not be heard.

WAKE UP PROG (WAKE UP)	[0...127]
------------------------	-----------

When you turn on the power to the DL8000R, it will recall the Program selected here.

MAP (MAP)	[OFF, ON]
-----------	-----------

This parameter allows you to assign the DL8000R Program numbers to the MIDI Program numbers.

With the **ON** setting, the specified Program map will be used.

To specify the Program map, first press the [FUNCTION] knob. (The display will change as follows:)

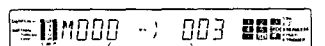

Received MIDI Program number Assigned Program number

Turn the [FUNCTION] knob to select the MIDI Program Change number, and turn the [VALUE] knob to assign the Program number.

Finally, press the [FUNCTION] knob to complete the setting.

With the **OFF** setting, the MIDI Program Change number

will be assigned to the same number of the Program. That is, for example, MIDI Program Change number 1 will be assigned to Program 1.

AUDIO CNTRL (AUDIO CNTRL)

This parameter group allows you to set the audio signal controller.

ENVELOP SENS (ENV SENS)	[0...30]
-------------------------	----------

Used to set the sensitivity of the envelope controller.

ENVLP RELEAS (ENV RLS)	[0...30]
------------------------	----------

Used to set the release time of the envelope controller.

TRIGGER THR (TRIG THR)	[-36...0dB]
------------------------	-------------

Used to set the threshold level of the Audio Trigger.

DISPLAY (DISPLAY)

These parameters are related to the display.

DISPLAY MODE (DSP MODE)	[NAME, NUM, TIME, MAP]
-------------------------	------------------------

Used to set the items to be displayed in Program mode.

NAME: The LCD will indicate the currently selected Program name.

NUM: The LCD will indicate the currently selected Program number and part of the Program name.

TIME: The LCD will indicate the value of LFBTIME and RFBTIME in Time mode, and Tempo in Tempo mode.

MAP: The LCD will indicate the Program Change number received via MIDI, and the corresponding Program number.

ABBRV TIME (ABRV TIME)	[0...8]
------------------------	---------

When **ABRV MODE** is set to 1, this parameter is used to set the time required for the parameter name to change from full-name indication to an abbreviated display.

If you select "0," an abbreviated name will appear. If you select "1" or higher, the full parameter name will appear first, then it will change to an abbreviated form. The higher the number, the longer the time required to change the indication.

If **ABRV MODE** is set to 2, this parameter allows you to set the scrolling speed.

The higher the value is, the slower the scrolling speed.

ABBRV MODE (ABRV MODE)	[1, 2]
------------------------	--------

Used to set the indication of a parameter name.

With "1," an abbreviated name will appear.

With "2," a parameter name will scroll.

DIMMER (DIMMER)	[1...8]
-----------------	---------

Used to adjust the brightness of the LCD.

FOOT PEDAL (FOOT PEDAL)

These parameters are used to set the type of the foot pedals connected to the jacks on the real panel.

BYPASS PEDAL (BYPASS)	[L, H, U, D, U/D]
-----------------------	-------------------

TRIGGR PEDAL (TRIG)	[U, D]
---------------------	--------

HOLD PEDAL (HOLD)	[L, H, U, D, U/D]
-------------------	-------------------

Used to set the type of the foot pedals connected to the jacks.

L: The foot switch is active when it is closed.

H: The foot switch is active when it is open.

U: The foot switch is active only at the moment it is switched from close to open.

D: The foot switch is active only at the moment it is switched from open to close.

U/D: The foot switch is active each time it is switched.

MEMORY (MOEMORY)

These parameters are related to the Program memory.

WRITE PROTCT (W-PROTCT)	[OFF, ON]
-------------------------	-----------

With the **ON** setting, writing a Program will be prohibited.

PRESET (PRESET [LOAD])

Allows you to load the factory preset Programs.

⚠ If you load the factory preset Programs, all existing Program data will be replaced by the factory preset data, and you will lose the current data forever. Store important data first to a MIDI data filer.

Press the [VALUE] knob to load the data.

MIX OFFSET (MIX OFFSET)

This function is used to adjust the direct/effect balance of all Programs simultaneously.

DIRECT OFFST (DIR OFS) [-INF...0dB]
Used to adjust the volume level of the direct sound of all Programs.

DELAY OFFSET (DLY OFS) [-INF...0dB]
Used to adjust the volume level of the delay sound of all Programs.

EDIT L/R SNC (L/R SYNC) [OFF, ON]

When this parameter is ON, setting the left or right parameter will automatically set the other to the same value.

About Messages

COMPLETED

The operation is completed.

LOADING...

The factory default Programs are being loaded.

PROTECTED

WRITE PROTCT is ON, and you could not write the data. Turn off WRITE PROTCT for the MEMORY parameter in Utility mode.

READ ONLY

You have tried to write data to the ROM area. (You cannot write data to the ROM area.) Write the data to the User area (0-127).

Troubleshooting

If you suspect a malfunction, first check the items below. If the situation does not improve, consult your dealer or contact Korg Information.

The power is not turned on.

Is the AC/AC power supply connected correctly?
➔ Check the connection.

No sound is heard, or the volume level is very low.

Is the power to the sound source and/or the powered monitor speakers ON?
Are the sound source and/or the powered monitor speakers connected correctly?
➔ Check the setting and connection of each device.

Is the connecting cable damaged?
➔ Check the connecting cable.

Is the output level of the sound source or the [OUTPUT] knob or [INPUT] knob of the DL8000R set to 0?

➔ Adjust the volume level using the output level of the sound source or the [OUTPUT] knob and [INPUT] knob of the DL8000R.

Is the MIXER parameter level set to -INF?

➔ Adjust the level using the MIXER sub-parameter in Program Edit mode.

Is only one of the OUTPUT jacks (L or R) connected?

➔ Adjust the output balance using the MIXER sub-parameter in Program Edit mode, or make a stereo output connection.

The connected foot pedal is disabled.

Do the foot pedal type and the FOOT PEDAL parameter settings match?

➔ Set the FOOT PEDAL sub-parameter in Utility mode to match the type of the connected foot pedal.

Is the connecting cable damaged?

➔ Check the foot pedal cable.

No effect is applied.

Is the Bypass function canceled?

➔ Cancel the Bypass function using the [BYPASS] key or the pedal switch connected to the BYPASS jack.

Operation of the [WARP!] or the pedal switch connected to the CTRL jack is not effective.

Is the device set correctly in Utility mode so that the [WARP!] knob or the pedal switch connected to the CTRL jack will be effective? Also, is the parameter to be controlled selected correctly in Program Edit mode?

➔ Check the settings of each mode. Refer to "Control with the [WARP!] knob" on page 9.

I cannot obtain the expected effect using the LFO or envelope control.

Is the parameter to be controlled set to the maximum or minimum?

➔ You will be unable to obtain a greater effect if the parameter value exceeds the maximum or minimum limits. Adjust the value.

I cannot get the expected delay time for the Tap Tempo delay.

Is the note resolution set correctly?

➔ Adjust the RESULT TAP and FACTOR (NOTE RESULT sub-parameter) parameter in Program Edit mode.

Which mode is selected, Time mode or Tempo mode?

➔ The operation of the Tap Tempo delay varies depending on the selected mode. Refer to "Time Mode and Tempo Mode" on page 11.

I cannot get the expected delay time for the Audio Trigger delay.

Is the note resolution set correctly?

- ➔ Adjust the RESULT AUDIO and FACTOR (NOTE RESULT sub-parameter) parameter in Program Edit mode.

Is the threshold set correctly?

- ➔ Adjust the TRIGGER THR parameter (AUDIO CNTRL sub-parameter) in Program Edit mode.

The Program cannot be stored.

Is the Write Protect parameter ON?

- ➔ Set the WRITE PROTCT parameter (MEMORY sub-parameter) in Utility mode to OFF.

Did you try to write data to the ROM area (128–255)?

- ➔ Write data to the User area (0–127).

Specifications

- Controls: [INPUT] knob (L, R), [OUTPUT] knob (L, R), [FUNCTION] knob, [VALUE] knob, [WARP!] knob, [ms/↓] key, [HOLD] key, [TRIGGER] key, [BYPASS] key, Power switch
- I/O: INPUT jack (L/MONO, R) (standard), OUTPUT jack (L, R) (standard), BYPASS jack (standard), HOLD jack (standard), TRIGGER jack (standard), CTRL jack (standard), AC9V IN (standard DIN-4pin connector), MIDI jacks (IN, OUT, THRU)
- Display: 12 digits, Alpha-numeric
- Preset Program: 256 (User area: 128, ROM area: 128)
- Maximum Pre-delay time: 400ms
Maximum delay time: 4,800ms
Delay line serial connection: 10,000ms
(400ms + 4,800ms + 4,800ms)
- Maximum input level: +20.0dBu
- Sensitivity: -10dBu—+8.0dBu (at 12dB of head room)
- Input impedance: 500kΩ
- Maximum output level: +20.0dBu
- Output load impedance: 600Ω or more
- Response: 20Hz–20kHz (±1.0dB)
- Dynamic range: 96dB (@1kHz AWTD 22kHz-LPF)
- T.H.D.+ N: 0.03% (@1kHz F.S. 22kHz-LPF)
- A/D, D/A resolution: 18-bit linear
Sampling rate: 48kHz (128 times oversampling bit stream ADC, DAC)
- Outside dimensions (W x D x H):
482 x 216 x 44 (mm)
- Weight: 2.4kg
- Power supply: AC 9V
Current consumption: 2000mA (max.)
- Operating temperature: 0–40°C (no condensation)
- Accessories: Owner's Manual, Rubber pad, AC/AC power supply
(F.S. = digital full scale level)
(0dBu=0.775Vrms)

The dimensions and specifications are subject to change for improvement without notice.

MIDI IMPLEMENTATION CHART (DL8000R)

Function		Transmitted	Recognized	Remarks
Basic Channel	Default	1 - 16	1-16	Memorized
	Changed	1 - 16	1-16	
Mode	Default		X	
	Messages	X	X	
	Altered	*****	X	
Note Number:		X	O 0-127	Received as control source *C
	True Voice	*****	X	
Velocity	Note On	X	O 9n, V=1 - 127	Received as control source *C
	Note Off	X	X	
Aftertouch	Key	X	X	
	Channel	X	O	Received as control source *C
Pitch Bend		X	O	Received as control source *C
Control Change	0, 32	O	O	Bank Select (MSB, LSB) *P
	0 - 120	O	O	Received as control source *1 *C
	121	X	O	Reset All Controllers
Program Change		O 0 - 127	O 0 - 127	*P
	Variable Range	*****	0 - 127	
System Exclusive		O	O	*E
System Common	Song Position	X	X	
	Song Select	X	X	
	Tune	X	X	
System Real Time	Clock	X	X	
	Command	O	O	*2
Aux Messages	Local On/Off	X	X	
	All Notes Off	X	X	
	Active Sense	X	X	
	Reset	X	X	
Notes	*C, *P, *E: Sent and received when MIDI Filter (Control Change, Program Change, System Exclusive) is set to ENA. *1: Sent and received when control change is assigned to switch. *2: Sent and received when MIDI clock resolution is not set to OFF.			

Mode 1: OMNI ON, POLY
 Mode 3: OMNI OFF, POLY

Mode 2: OMNI ON, MONO
 Mode 4: OMNI OFF, MONO

O: Yes
 X: No

NOTICE

KORG products are manufactured under strict specifications and voltages required by each country. These products are warranted by the KORG distributor only in each country. Any KORG product not sold with a warranty card or carrying a serial number disqualifies the product sold from the manufacturer's/distributor's warranty and liability. This requirement is for your own protection and safety.

KORG KORG INC.

15 - 12, Shimotakaido 1 - chome, Suginami-ku, Tokyo, Japan.