

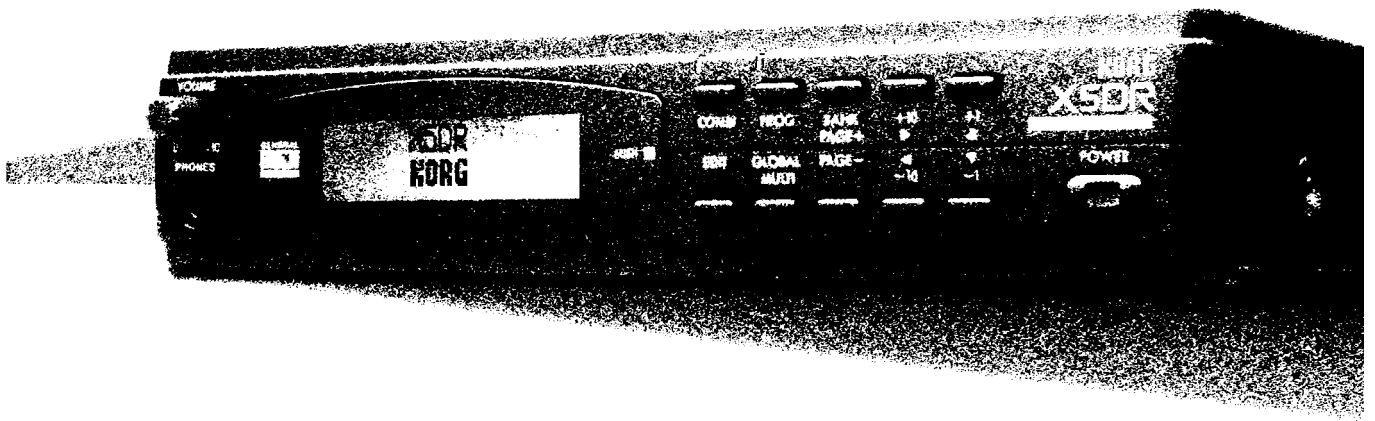

X5DR

AI² SYNTHESIS MODULE

GENERAL
MIDI
INSTRUMENT



Owner's Manual

 AI² Synthesis System

KORG

Ⓔ ①

Introduction

Features of the X5DR

Superior Sound with Korg's AI² Synthesis System

The Korg X5DR employs Korg's AI² Synthesis System for all digital processing. From the tone generator—with its 8MB capacity—to the filters, amplifier, and effect units, all audio is handled in the digital domain, which ensures the highest quality sound with absolutely no signal loss or deterioration in audio quality.

Based on state-of-the-art PCM technology, the AI² Synthesis System is technology developed by Korg to capture the true essence of acoustic sound for use in a tone generator. Since its introduction in Korg's 01/W series, X2/X3/X5, and i2/i3 synthesizers, the AI² Synthesis System has received unqualified praise from musicians and artists throughout the world. With the X5DR, you will enjoy a richness and variety of sound at a level of excellence that meets or exceeds the quality of audio CDs.

Multisounds Let You Create an Endless Variety of Sounds

The X5DR contains 430 built-in Multisounds, which are multi-sampled PCM waveforms. These Multisounds allow you to simulate a range of acoustic sounds, from drums and percussion to piano, guitar, and trumpet. The X5DR also features unique Multisounds—such as Synth and Special Effects—which provide a wide variety of flexible tools for sound creation. In fact, the X5DR can generate a virtually endless variety of sounds.

These built-in Multisounds can be played in their unmodified form. They can also be modified to create the sound of various musical instruments once they pass through a powerful VDF (filter) and VDA (amplifier). You can also add a rich expressiveness to a performance by altering the sound using the key touch velocity, or by adjusting the brightness of the sound or the depth of the vibrato using MIDI modulation messages.

Rich, large-scale ensembles with 64-voice polyphony

The X5DR's 64-voice polyphonic capability allows you to create complex ensemble and large-scale orchestral sounds. Combinations of multiple Programs and features in Multi mode will help you achieve such effects. The X5DR can simulate a magnificent piano sound, replete with a damper pedal, and ensembles of various instrumental parts without any notes cutting off.

236 Programs in Banks A and G

Bank A contains 100 Programs and Bank G contains 136 General MIDI (GM) compatible Programs. You can store your own Programs in Bank A.

Programs comprise the basic sounds of the X5DR. You can play different Programs in a song; you can even layer them in Combinations.

One Hundred Combination Slots Allow for an Endless Variety of Programs

Up to 100 Combinations can be stored in the X5DR. Up to eight Programs can be assigned to each Combination. In Combinations, you can layer or split multiple Programs by setting the Key Window or Velocity Window parameters.

Combinations are powerful sound tools, especially for live performance. The Combination types *layer*, *split*, and *velocity switch* provide various sound structures.

Drum Kits Support a Variety of Rhythms

The X5DR provides 215 types of popular drum sounds, including both standard drum and percussion sounds. You can create two Drum Kits by assigning different drum sounds to each key on the keyboard. There are also eight ROM Drum Kits available.

A Drum Kit supports the rhythm of a song. Assigning a different drum sound to each key allows you to create a wide variety of rhythm parts. You can also edit the drum sounds using VDF, VDA, and effect units.

Extensive Presets Produce a Wide Range of Truly Practical Sounds

The X5DR utilizes various Programs, Combinations, and Drum Kits as Preset data. You can load the sounds stored in Presets a and b into the Program or Combination memory for immediate use. The Preset Load operation loads data from all preset sounds to one particular sound slot.

The versatile editing functions of the X5DR let you create original sounds very easily. On the other hand, it is quite a bit of work to create a good sound from scratch. Given such circumstances, Preset data can be very handy. You can use the data immediately after you load a sound, choosing from a broad selection. You can use Preset data just as it is, without modification. You can also use Preset data as the raw material for sound editing. You may be able to glean a few ideas for sound-making from the Preset sounds.

Digital Multi-Effects Processors: To Create and Add Dimension to Sounds

The X5DR contains two independent digital multi-effects processors that can produce various effects such as reverb, delay, EQ, distortion rotary speaker, etc. These effects are very useful when you want to create a new sound or add dimension to a sound. Some effects are actually a combination of two effects. Using the X5DR's two independent digital multi-effects processors, you can use up to four independent effects simultaneously.

The effects processors allow you to apply effects and edit the sounds directly on the X5DR, instead of connecting external effect units. Placement settings are useful for processing the sound and adding width or depth to the sound. Each Program and Combination can have its own effect settings.

A wide range of scale types accommodates numerous musical genres

In addition to the conventional equal temperament and pure temperament types of tuning, a wide variety of scales is also available. These scales include the Werkmeister III, Kirnberger III, Arabic, and Indonesian scales. These scales cover a broad range of musical genres, from classical to various ethnic music, and prove extremely useful in the creation of realistic simulations of various instruments.

Western music generally uses a twelve-tone equal temperament that allows you to play in any key and to transpose the key easily. However, the X5DR provides various scale types that will make the sound of chords and the flow of phrases more beautiful, and which will allow you to perform music utilizing temperaments other than the equal temperament, including the very complex and subtle temperaments used in many ethnic musical pieces.

Multi Mode for GM

Since the X5DR conforms to the GM (General MIDI) standard in Multi mode, it can function as a tone generator for computer music. It can also play GM songs (performance data designed for a GM tone generator). Using original Programs in Bank A, or utilizing Key Window and Velocity Window parameters, you can perform high-quality ensemble pieces.

The X5DR can be used as a GM tone generator with standard specifications. You can also combine different Programs and play original Programs via computer.

Equipped with a personal computer interface

The built-in computer interface enables a direct connection to the serial port of your personal computer (Apple Macintosh or IBM-PC compatible).

You can connect the X5DR to a computer through either a MIDI connection using a MIDI interface, or through a direct connection using a serial cable. Using the Korg MIDI Driver will allow you to control data transmission from MIDI OUT independently of the X5DR tone generator, or to simultaneously control an external MIDI device.

Controls

Front Panel

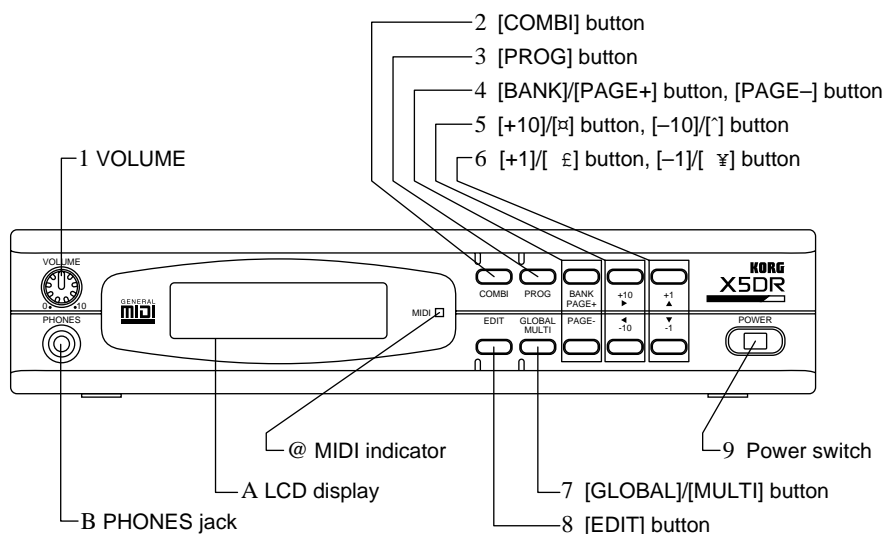

About Color Codes for Letters and Numbers on the Keys:

White letters and numbers are used to select the Program/Combination numbers in Program Play mode and Combination Play mode. Blue letters and numbers are used to edit and set up parameters in other modes.

1 VOLUME

This VOLUME knob is used to adjust the entire volume level. (That is, it simultaneously adjusts the volume at the OUTPUT connector on the rear panel and the volume at the PHONES jack.)

2 [COMBI] button

Press this button to select the Combination Play mode. Pressing this button repeatedly will toggle the displays for Timbres 1–4 and Timbres 5–8.

3 [PROG] button

Press this button to select the Program Play mode.

4 [BANK]/[PAGE+] button, [PAGE-] button

Repeatedly pressing the [BANK] button in Program Play mode will toggle between Bank A and Bank G.

Pressing this button in Program Edit mode, Combination Edit mode, Multi mode, or Global mode will change the page shown on the LCD. Press the [PAGE+] button to select the next page; press the [PAGE-] button to select the previous page.

5 [+10]/[Ⓜ] button, [-10]/[√] button

The [+10] and [-10] buttons increment and decrement the Program and Combination numbers in steps of 10 in Program Play mode and Combination Play mode.

In Program Edit mode, Combination Edit mode, Multi mode, and Global mode, the [Ⓜ] and [√] buttons allow you to move the flashing cursor around the LCD to select parameters. When one display page includes multiple LCD screens, you can switch screens by moving the cursor.

6 [+1]/[▲] button, [-1]/[▼] button

In Program Play mode and Combination Play mode, pressing the [+1] and [-1] buttons increment and decrement the Program and Combination numbers in steps of 1.

In Program Edit mode, Combination Edit mode, Multi mode, and Global mode, these buttons can be used to increase and decrease the currently-selected parameter value. In these modes, pressing one of these buttons while pressing and holding down the [▲] or [▼] button will change the parameter value very quickly.

These buttons are also used when the X5DR requires a yes or no answer from you on the LCD screen. When the message "-- OK?" appears, press the [▲] button to continue, or the [▼] button to cancel.

7 [GLOBAL]/[MULTI] button

Press this button to enter Multi mode or Global mode. This button also switches the mode between Multi mode and Global mode. In Multi mode, the indicator lights up; in Global mode, the indicator flashes.

8 [EDIT] button

In Program Play mode, press this button to select the Program Edit mode. In Combination Play mode, press this button to select the Combination Edit mode.

9 Power switch

This switch is used to power on and power off the X5DR.

0 MIDI indicator

This indicator lights up when the X5DR receives MIDI data via the MIDI IN jack or the TO HOST jack.

A LCD

This visual interface displays the current Program name and Combination name in Program Play mode and Combination Play mode, respectively. In other modes, it displays parameters.

B PHONES jack

Connect the headphones to this stereo mini jack.

Rear Panel

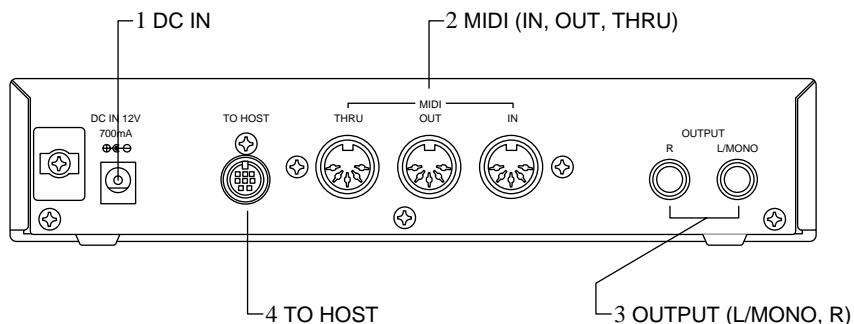

1 DC IN

Connect the AC adapter here.

Note: Do not use adapters other than the AC adapter that comes with the X5DR! Otherwise, a malfunction may occur.

2 MIDI (IN, OUT, THRU)

These connections are used to connect external MIDI instruments. MIDI IN receives MIDI data from an external MIDI instrument. MIDI OUT outputs MIDI data from the X5DR to a connected MIDI instrument. MIDI THRU outputs MIDI data received at the MIDI IN connection.

3 OUTPUT (L/MONO, R)

These 1/4 inch phone jack connections should be connected to the inputs of a powered monitor, stereo amplifier, mixer, or multi-track tape recorder. Use the L/MONO connection for mono playback.

4 TO HOST

This connection is used to connect a computer to the X5DR via an optional cable (AG-001/002/003). This enables you to play the X5DR via a connected computer.

Table of Contents

Introduction	i
Features of the X5DR	i
Controls	iii
Front Panel	iii
Rear Panel	v
Table of Contents	vii
About this manual	xii

Start-up Guide

Using a Keyboard

Connections	1
MIDI Keyboard Settings	2
Listening to a Demo performance	3
Playing Programs	4
If No Sound is Produced:	5
Program Examples	5
Playing Combinations	7
Combination Examples	8

Using a Computer/Sequencer

Connections	9
Connecting a computer or sequencer	10
Connection via MIDI	11
Connecting an IBM PC (Compatible) Computer	12
Connecting an Apple Macintosh Computer	13
Settings Required When a Computer is Connected	14
Listening to a Demo performance	15
Playing the X5DR in Multi Mode (Playing Back GM Scores).....	16
Structure of Multi Mode	17
Selecting a Track Program From a Computer or Sequencer	17
Performance settings	18
Notes on Playing Back GM Scores	18
If You Cannot Play the X5DR	19
Loading Preset Data	20

Basic Guide

1. X5DR Modes

Program Play mode	21
Playing Programs	21
Basic operation in Program Play mode	21
Program Edit Mode	23
Basic operation in Program Edit mode	23
Combination Play Mode	24
Playing Combinations	24
Basic operation in Combination Play mode.	24
Combination Types	25
Combination Edit mode	26
Basic operation in Combination Edit mode	26
Multi Mode	27
Playing the X5DR in Multi mode	27
Basic operation in Multi mode	27
Global Mode	29
Basic operation in Global mode	29

2. Performance Techniques

Structure of the X5DR	30
Control via MIDI/Sequencer	30
Signal flow in various modes	31
Received MIDI data	32
Performance Functions	34
Keyboard Velocity	34
Pitch Bend/Modulation Wheel	34
Effect Dynamic Modulation	35
After Touch	35

3. Editing

Basic Concepts	36
Sound Structure	36
EG and MG	37
Editing Programs	38
Before Editing	38
Checking the Sound While Editing	39
Adjusting the Attack of Programs	40
Adjusting the Decay	41
Adjusting the Release	42
Adjusting the Tonal Brightness	42
Editing a Multisound (Basic Waveform)	44
Adjusting Modulation	44
Adjusting the Panpot	45
About Double Mode	45
Some Hints for Editing Programs	46
Editing Effects	47
Effect Types	47
Effects and Sound Level	50
Editing Combinations.....	51
Layering Multiple Programs	51
Adjusting the Volume	52
Adjusting the Key Window	52
Adjusting the Velocity Window	52
More About Combination Edit	52
Editing a Drum Kit	53

Preparing to Play a Drum Kit	53
Editing a Drum Kit	53
Creating a Drum Program Using a ROM Drum Kit	56
4. Application Guide	
General Troubleshooting	57
Nothing is displayed on the LCD when the power switch is turned on.	57
The X5DR does not produce any sound.	57
The sound does not stop.	57
The X5DR does not respond to incoming MIDI data.	57
You cannot change Programs or Combinations.	58
The wrong sounds are produced.	58
You cannot write a Program or Combination.	58
You cannot select the parameter pages for OSC2 (e.g., VDF2 and VDA 2).	58
The X5DR does not play the specified drum sounds.	58
The X5DR does not play GM-compatible song data correctly.	58
The X5DR doesn't transmit MIDI Exclusive messages.	59
Performance Applications	60
Tuning the X5DR to Other Musical Instruments	60
Changing the Key Velocity Sensitivity	60
Changing the Note Range	60
Adjusting Effects while Playing	60
Changing the Sequence of Programs or Combinations	60
Combining Multiple Programs	60
Changing the Controller Functions in Combinations	61
Playing the Keyboard in Split Mode	61
Selecting a Particular Sound Quickly	61
Using a Different Scale	61
Editing Applications	62
Editing the Sounds	62
Copying Effect Settings	62
Editing the Sound from a Computer	62
Restoring the Parameter Values to the Factory Settings	62
Saving Sound Data	62
MIDI Applications	63
Playing Multiple parts from a Sequencer	63
Creating a GM Song	63
Using Two X5DR's (Using 128 Voices)	63
Convenient Functions	64
Page Memory	64
[▲]/[▼] buttons	64
5. About MIDI	
What is MIDI?	65
MIDI Connectors	65
MIDI Channel	65
MIDI Information	66
Channel Message	66
Note On/Off	66
Program Change	66
Pitch Bend	67
After Touch	67
Control Change	68
System Messages	73
System Exclusive messages	73
About the MIDI Filter	75

Reference Guide

Parameter Guide

About this chapter	77
--------------------------	----

1. Program Parameters

Functions in Program Mode	78
---------------------------------	----

2. COMBINATION Parameters

Functions in COMBINATION mode	100
-------------------------------------	-----

3. Multi Setup Parameters

Multi Setup Functions	107
-----------------------------	-----

4. Effect Parameters

Effect Parameter	115
------------------------	-----

5. Global Parameters

Functions in Global Mode	146
--------------------------------	-----

Appendix

General Error Messages	161
Program Edit Mode & Combination Edit Mode Error Messages	161
Specifications	161
Options	161
MIDI Data Format	163
Program Change and Bank Select Reception in Combination Play Mode	172
PC Interface Technical Information Chart	172
MIDI Panpot, Send Data	173
Wiring Diagram of Dedicated Connecting Cables	173
Installing and Setting Up the KORG MIDI Driver	174
Installing the KORG MIDI Driver in MS Windows	174
Setting Up the KORG MIDI Driver (Windows)	176
Installing the KORG MIDI Driver on a Macintosh Computer	177
Setting Up the KORG MIDI Driver for the Macintosh	178
MIDI File Translator	179
MIDI Implementation Chart	180
INDEX.....	182
Voice Name List	185

About this manual

This manual consists of the following chapters to enable you to extract information relevant to your environment and applications.

Start-up Guide

This chapter explains the set-up procedure and basic operation of the X5DR. This chapter is divided into two sections: “Using a Keyboard” and “Using a Computer/Sequencer.” Read the “Using a Keyboard” section if you use the X5DR as an extended tone generator for your MIDI keyboard. Read the “Using a Computer/Sequencer” section if you use a computer music system or MIDI sequencer.

Basic Guide

This chapter explains the X5DR's configuration and modes. Read this chapter after you have mastered the basic operations described in the Start-up Guide. This chapter also explains how to edit Programs to create new sounds. Refer to this chapter to make the best use of the versatile functions and various sounds of the X5DR.

Reference Guide

This chapter explains the function of each mode and the parameters of the X5DR in detail.

<<About MIDI>>

This manual assumes that you have a basic knowledge of MIDI. If you are using a synthesizer or a MIDI device for the first time, read the section entitled “5. About MIDI” in the Basic Guide.

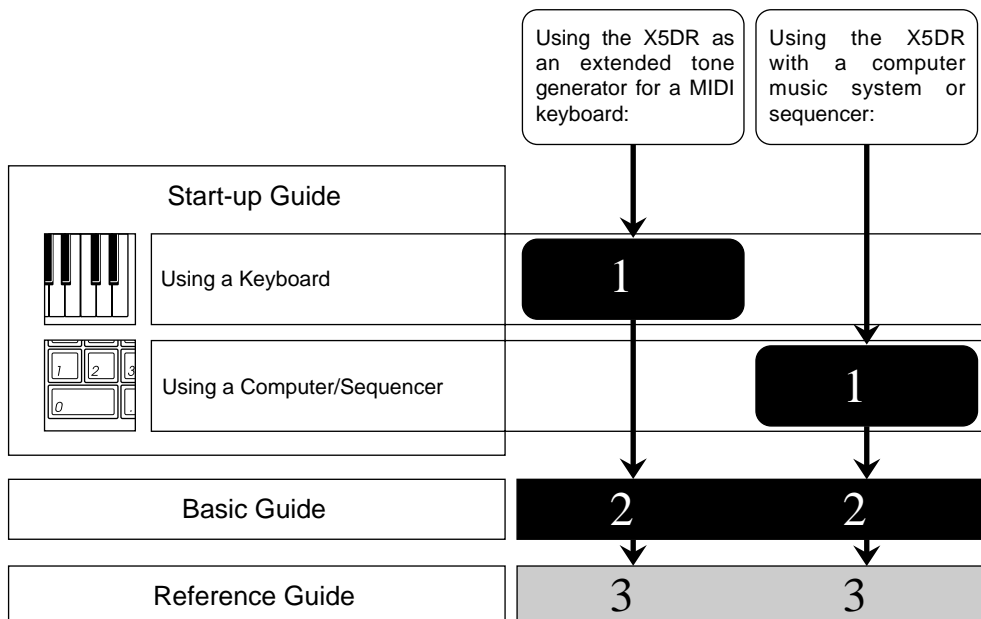

Note: The Program, Combination, and Multi Track Program names shown on the LCD screen in this manual are assumed names, and do not necessarily match the names found on the X5DR.

Start-up Guide



Using a Keyboard

Connections

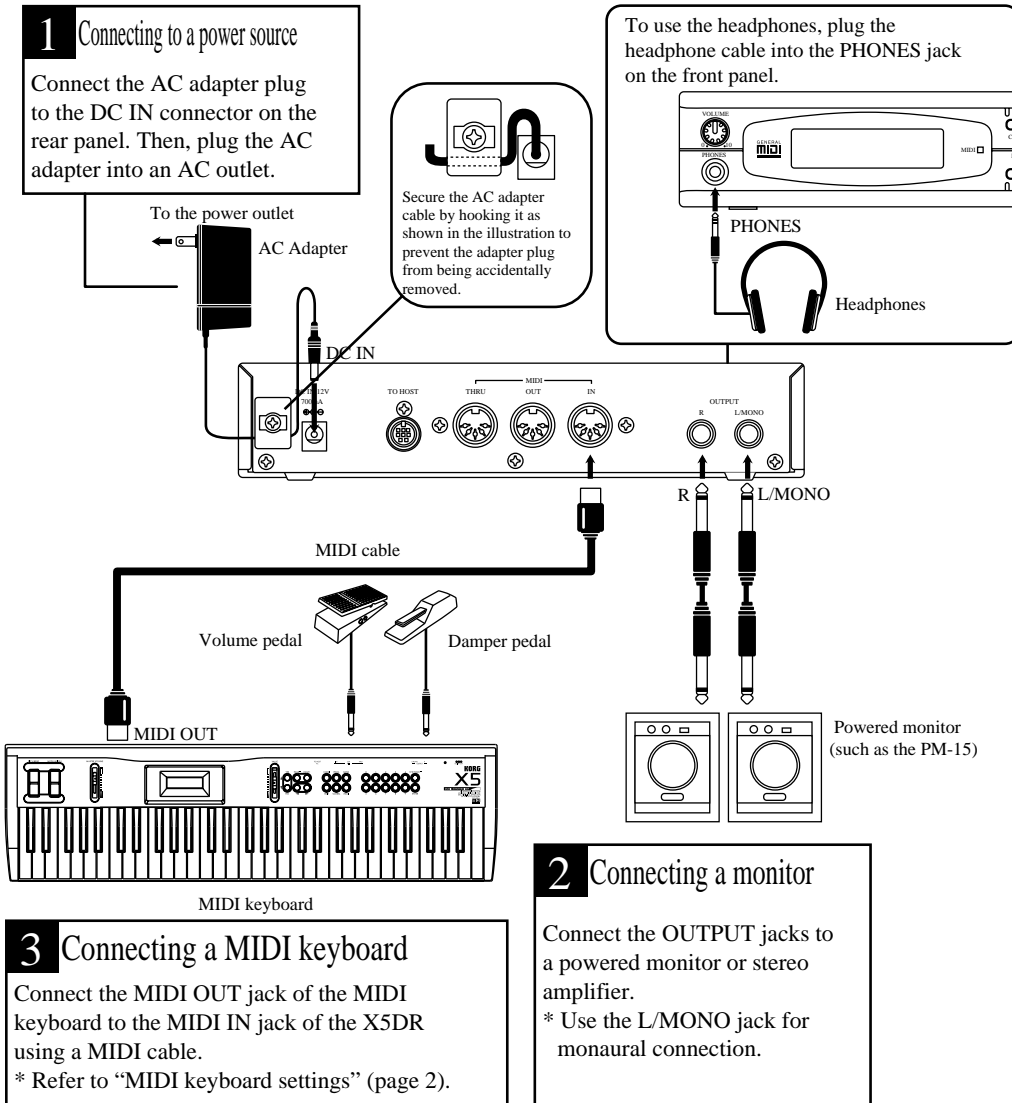

Powered monitor/stereo amplifier

In order to playback the X5DR's high-fidelity sound, we recommend that you connect the X5DR to powered monitors (i.e., speakers with built-in amplifiers, such as the optional PM-15). If you are going to connect a stereo amplifier or other device (such as a stereo radio or a cassette tape recorder), use the connector labeled "LINE IN" or "AUX IN" on those devices.



If you connect the X5DR to a domestic hi-fi system, be careful not to raise the volume level too high, or you may damage the speakers.



MIDI Keyboard Settings

Use the following MIDI keyboard transmit settings before you play the X5DR from a connected keyboard. Refer to the MIDI keyboard manual for detailed settings.

- The X5DR is a MIDI tone module that receives MIDI data sent from external MIDI devices (such as a MIDI keyboard, computer, or sequencer) to playback data. Refer to the section “Using a Computer/Sequencer” on page 9 for details when you wish to play the X5DR from a connected computer or sequencer.

MIDI transmit channel

Set the MIDI keyboard transmit channel to “1.” If you wish to use a different MIDI transmit channel on the MIDI keyboard, you must change the MIDI receive channel on the X5DR accordingly.

- If you cannot change the MIDI keyboard transmit channel (in other words, if its MIDI channel is fixed), set the Global MIDI Channel on the X5DR to the same number as the MIDI transmit channel on the MIDI keyboard.

MIDI transmit filter

MIDI keyboards allow you to transmit various MIDI data.

The X5DR can receive the following MIDI messages:

- Note On/Off (Note message) --- Very basic message for keyboard performance.
- Program Change message --- Changes Programs.
- Control Change --- Controller and performance mode message.
- Pitch Bend --- Bender (joystick, wheel, lever) pitch variation message.
- After Touch (Channel Pressure) --- Information about pressing the keys after a note has been struck.
- Not all MIDI keyboards can transmit the MIDI messages listed above. When you are playing the X5DR, it will receive only MIDI data that can be sent from a connected MIDI keyboard. For example, if you are using a MIDI keyboard that does not transmit Pitch Bend messages (such as a digital piano), you cannot achieve a pitch bend effect.

Listening to a Demo performance

The X5DR has two internal songs that demonstrate the X5DR's features. You can play back these songs on the X5DR.

1 Turning the power on/off

Press the power switch to turn the X5DR power on. Pressing the power switch again will turn the power off.

! Make sure that the connected powered speaker or stereo amplifier is turned off before you power-on the X5DR.

2 Adjusting the volume level

Use the VOLUME knob to set the optimum volume level.
* The headphone volume level will be adjusted at the same time.

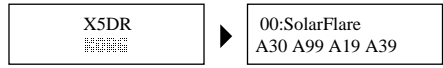

When you turn the X5DR power on, the screen will show the opening message for a few seconds, then show the Combination Play mode indication.

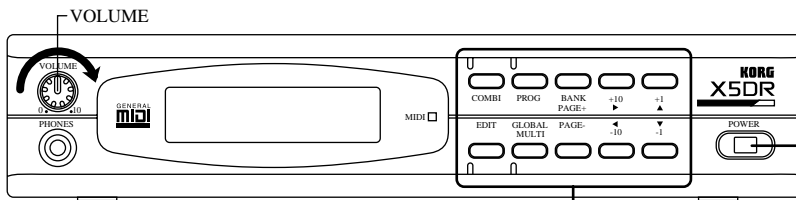

3 Demo performance

Demo Song 1: AROUND THE WORLD By Stephen Kay
Demo Song 2: WE'VE GOT DREAMS By KORG Inc.

■ Combination Play mode
The X5DR automatically enters Combination Play mode when you turn the power on.

■ To enter Demo mode:
Press the [COMBI] button and [EDIT] button simultaneously.

Demo Play
Press any key

* Four indicators will flash in Demo mode.

■ Operation in Demo mode

Demo Song 1: AROUND THE WORLD
Demo Song 2: WE'VE GOT DREAMS

Pressing one of these buttons will stop playback.

The X5DR will repeat playback of Demo songs 1 and 2.

The X5DR will play back Demo song 1, then Demo song 2.

■ To quit Demo mode:
Press one of the following buttons when playback is stopped.

00:SolarFlare
A30 A99 A19 A39

* The X5DR will quit Demo mode, and enter Combination Play mode.

▶ To listen to playback:
Press the [COMBI] button to playback Demo song 1.
Press the [PROG] button to playback Demo song 2.
* Press the [EDIT] button to play demo songs 1 and 2 consecutively. Press the [GLOBAL]/[MULTI] button to repeat the demo songs in an endless loop.

■ To stop playback:
If you wish to stop the demo song, press any button.

Listen to and enjoy the wonderful sound, the versatile tone, and the rich expressiveness of the Korg X5DR.

Playing Programs

The X5DR has two types of sounds: Programs and Combinations. First we will listen to some Programs.

1 Program Play mode

Program Play mode enables you to play Programs. Press the [PROG] button to enter Program Play mode.

A00:PipeDreams

— Program name

— Program number

— Program Bank

The display shows the Program Bank number, Program number, and Program name.

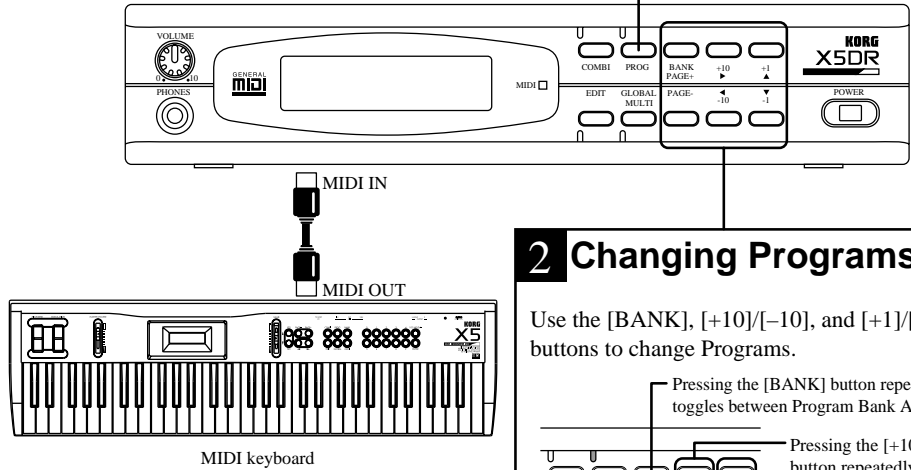

2 Changing Programs (1)

Use the [BANK], [+10]/[-10], and [+1]/[-1] buttons to change Programs.

Pressing the [BANK] button repeatedly toggles between Program Bank A and Bank G.

Pressing the [+10] or [-10] button repeatedly increments or decrements a Program number by 10.

Pressing the [+1] or [-1] button repeatedly increments or decrements a Program number by 1.

The X5DR has 100 Programs in Bank A (A00-99), and 136 Programs in Bank G (G01-136), for a total of 236 Programs.

Bank A
A00-99

Bank G
G01-136

Listen to various Programs by changing Program numbers.

* When the X5DR is shipped from the factory, Bank A contains Preset Programs. (See page 20, 156.)

3 Changing Programs (2)

When you wish to change Programs from a connected MIDI keyboard (or external MIDI device), you must send Program Change messages (and also Bank Select messages if you wish to change the Bank).

While Bank A is selected:
 Sending Program Change messages 0-99 will select Programs A00-99.

While Bank G is selected:
 Sending Program Change messages 0-127 will select Programs G01-128.
 * To select Programs G129-136, send Bank Select messages to change the Bank.

* Send the Bank Select messages to change the Banks between A and G. (See page 22, 68.)

If No Sound is Produced:

If no sound is produced from the X5DR when you play the MIDI keyboard, or if you cannot change Programs, check the following items:

No sound is produced:

- Check to see if the Demo songs can be played. If not, check to see if the volume level of the X5DR and the connected powered monitor or stereo amplifier is sufficient. Ensure that the audio cable is connected correctly.
- If the Demo songs can be played back, confirm that the unit is in Program Play mode. In Demo mode, you cannot play Programs.
- Check the MIDI cable connections and MIDI transmit channel on the MIDI keyboard. Set the MIDI transmit channel of the MIDI keyboard to 1. If you cannot change the MIDI transmit channel of the MIDI keyboard (if it is fixed), change the X5DR's MIDI receive channel on page 2A MIDI GLOBAL in Global mode. (See page 151).

If you cannot change Programs:

- If you cannot change Programs from the connected MIDI keyboard, check the transmit functions on the MIDI keyboard. Some MIDI keyboards can be set so that they will not transmit any Program Change messages. Some MIDI keyboards cannot transmit Bank Select messages, and some interpret Bank Select messages differently from the X5DR. Check the transmit function of your MIDI keyboard.
- You can set the X5DR so that it will not receive Program Change or Bank Select messages. (The default setting is to receive both messages.) If Programs are not changed when the MIDI keyboard transmits Program Change or Bank Select messages, check the MIDI FILTER setting on page 2C Global mode. (See page 152.)

Program Examples

The X5DR has 100 Programs (A00–99) in Bank A and 136 Programs (G01–136) in Bank G. Play and listen to a variety of Programs. The following Programs exemplify the unique sound of the X5DR. Take a listen to the following Programs.

A01:X Piano

This acoustic piano sound simulates a real piano—even the sound produced when the hammer hits the string. Notice how dynamically the volume level and tonal color of the sound varies, depending on key velocity (how strongly you strike the keys on the MIDI keyboard). Playing the keyboard hard will make a bright sparkling sound, and playing it softly will make a calmer sound. The simulation ranges from metallic lows to a short, hard attack in the high range. The polyphony of 64 voices on the X5DR allows you to play glissando and damper pedal effects.

A02:BigStrings

This Program recreates the dignified sound of a string section (including violin, viola, and cello). The attack of the sound changes depending on the key velocity. Playing the keyboard softly slows the attack, and playing the keyboard hard will make the attack very fast. With a fast key velocity, it simulates an immediate attack and a bright sound with a subtle touch of bow attack, allowing for a variety of performance expressions through key touch.

A08:Xanalog

This is a brass sound (such as trumpet or trombone) created on an analog synthesizer, generally known as Synth Brass. You will also notice how dynamically the volume level and tonal color of the sound varies depending on the key velocity and key range. This Program is suitable for playing chords. Although the X5DR is an all-digital synthesizer, it is also good at old classic analog sounds.



Using a Keyboard

A09:[KrazyKit]

This is a Program for a rhythm part (Drum Program), with a different sound assigned to each key on the keyboard. The A09:[KrazyKit] Program contains not only drum sounds but human voices and various effect sounds. When you play key C3 on the keyboard, the sound does not stop—rather, the sound volume increases. Play key B2 to stop this sound.

A17:Velo Flute

This Program is a unique sound that simulates the sound of a flute. Play this Program with different key velocities to change the tonal expression. You can also add vibrato effects by sending modulation information.

A37:FreshWaves

This Program has a sparkling attack, unique to digital synthesizers. The X5DR offers metallic and clear sounds, such as in this Program. Key touch affects the brightness of the sound. It is very effective when used like an electric piano.

A84:FeedbackGt

This is a powerful distorted guitar sound (amplifier distortion). As the name suggests, the sound gradually changes to feedback. It sounds a lot like a guitar with a fully-cranked amp. Try some guitar solos using modulation and pitch bend. The Delay effect can also be used to great advantage.

A90:Universe X

This fantastic synth sound combines the soft sound of a female chorus with a sparkling tremolo-like sound. Combine different types of sounds for interesting variations, and expand your collection of creative sounds.

The Programs described above represent only a few of the Preset a Programs. Try several different Programs and enjoy the great sounds of the X5DR.

<<About Drum Kits>>

The following Programs use a Drum Kit: A09:[KrazyKit], A19:[ComboKit], and G129:GM Kit through G136:Orch Kit.

A Drum Kit is a Program that consists of different drum sounds assigned to each key on the keyboard. Therefore, one Drum Kit can play various drum and percussion sounds, instead of playing scales. The X5DR has 8 Drum Kits in ROM and 2 Drum Kits in RAM. To play one of these kits, select one in a Program. (First, set 0A OSC Mode in Program Edit mode to DRUMS, then select the desirable kit for 1A OSC1 SOUND.) (See page 53, 79, 80). You can edit the sound key assignments and settings of the Drum Kits in Global mode. (See page 53, 158).

<<About Preset Data>>

The X5DR has high quality preset sound data. There are two types of preset data: PRE-a and PRE-b, and each contains 100 Programs, 100 Combinations, and 2 Drum Kits. Preset data PRE-a is pre-loaded as the factory setting. To listen to or use PRE-b sounds, you need to load the preset data PRE-b. Refer to “Loading Preset Data” on page 20, 156 for details.

Playing Combinations

Combinations are another type of sound on the X5DR. We will listen to some Combinations now. A Combination consists of several Programs. You can play different Programs by applying a different key touch on the keyboard, or you can use Combinations to obtain a more complex sound.

1 Combination Play mode

You can play Combinations in Combination Play mode. Press the [COMBI] button to enter Combination Play mode.

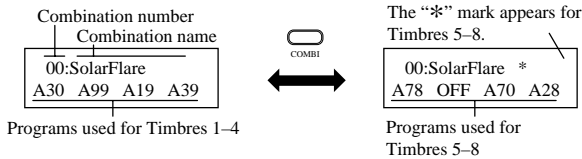

What is Combination?

A Combination is a sound that consists of up to eight Programs. Combinations allow you to:

- Produce a thick and complex sound by layering multiple Programs (Layer)
 - Produce the sound of different Programs depending on the range of the keyboard (Split)
 - Play different Programs by applying a different key touch to the keyboard (Velocity Switch).
- Try different key ranges and key velocities.

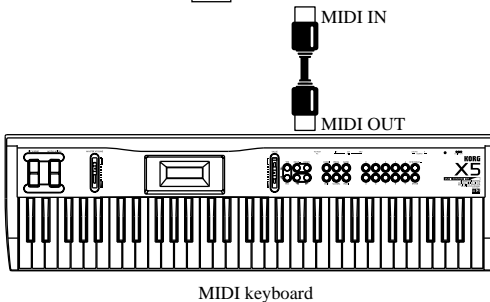
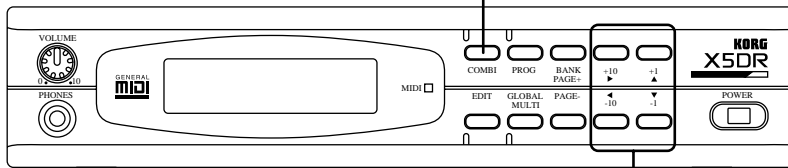

2 Changing Combinations (1)

Use the [+10]/[-10] or the [+1]/[-1] buttons to change Combinations.

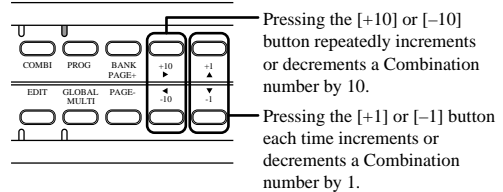

The X5DR has 100 Combinations (00–99).

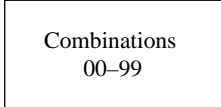

Listen to various Combinations by changing the Combination numbers.

* When the X5DR is shipped from the factory, it has Preset a Combinations. (See page 20, 156)

3 Changing Combinations (2)

When you wish to change Combinations from a connected MIDI keyboard, you need to send Program Change messages.

Sending Program Change messages 0–99 will select Combinations 00–99 respectively.



Using a Keyboard

Combination Examples

The X5DR has 100 Combinations (00–99). Play and listen to a variety of Combinations. The following are some examples of the X5DR's unique Combinations. Take a listen to the following:

12:Wind→Orch

This orchestra sound combines woodwind, strings, and timpani sounds. With a low key velocity, the woodwind sound is produced, and with a high key velocity, a strings sound is produced. This allows you to play two different sounds by switching the key velocity. In the low range, the timpani sound and cymbal sound are produced only when you play the key with a high key velocity. In this way, Combinations allow you to play different Programs easily, depending only on the key range and key touch.

15:<The East>

This is an oriental Combination that consists of koto, shakuhachi, gamelan, and gong sounds. Playing this Combination for even a short phrase is very effective and interesting because it contains exotic ethnic instruments. This sound also changes depending on the key range and key velocity.

26:Cathedral

This is a sublime pipe organ. This thick, heavy sound is created by layering multiple Programs. You can easily add thickness, width, and spaciousness to the sound by combining different Programs.

39:<<<Hell>>>

As you might guess from the name, this is a weird sound that combines multiple drum sounds and uses effect sounds, such as voices. You can combine Drum Programs (drum and effect sounds that are assigned to keys) with normal Programs, allowing you to easily create sounds with various characteristics. The next Combination 40:<<Heaven>> is a unique contrast. Listen to and compare these two Combinations.

49:RapToolKit

This Combination consists of drum, bass, guitar, and effect sounds. You can play the drum sound with the left hand, while playing the bass or guitar sound with the right hand. In the mid range, the tonal color changes depending on the key velocity. With a low key velocity, a bass sound is produced. With a high key velocity, a guitar sound is added. The scratch sound and orchestra hit sound are assigned to the higher range.

51:Bs/EP&Str

This combines bass, electric piano, and strings sounds. The bass Program is assigned to the low range, and the electric piano and strings sounds are layered in the mid and high ranges. You can play these different sounds with your left and right hands, which is very helpful in live performance. Using Combination 81:Bass/Piano allows you to play an acoustic bass and acoustic piano.

The Combinations described above are only part of a variety of Combinations the X5DR has to offer in Preset a. Try playing different Combinations to enjoy the great sound of the X5DR.



Using a Computer/Sequencer

Connections

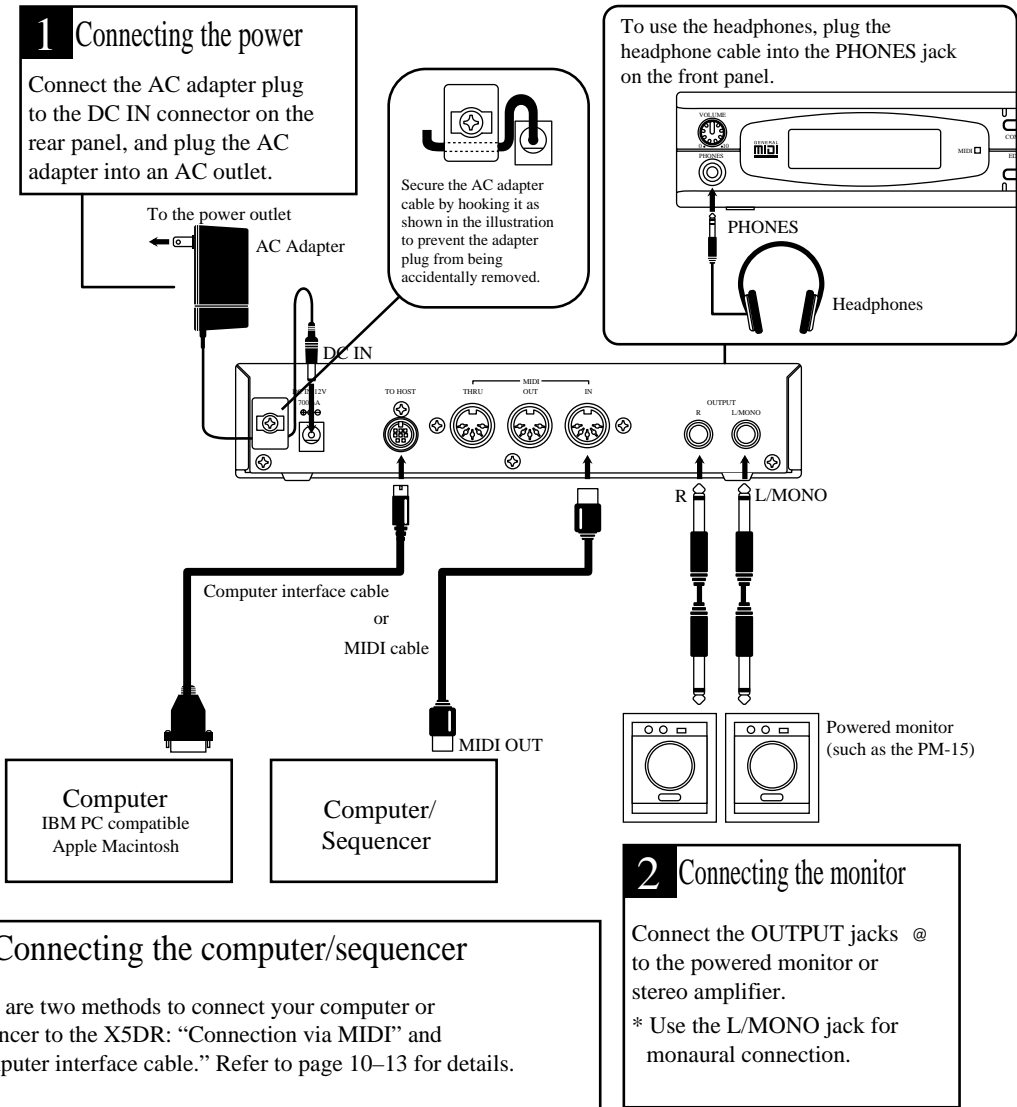

Powered monitor/stereo amplifier

In order to play back the X5DR's high-fidelity sound, we recommend that you connect the X5DR to powered monitors (speakers with built-in amplifiers, such as the optional PM-15). If you are going to connect an audio stereo amplifier or other device (such as a stereo radio or a cassette tape recorder), use the connector labeled "LINE IN" or "AUX IN" on those devices.



If you connect the X5DR to a domestic hi-fi system, be careful not to raise the volume level too high or you may damage the speakers.

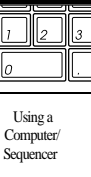

Connecting a computer or sequencer

There are two methods by which you can connect the X5DR to a computer: using a MIDI cable and MIDI interface (connection via MIDI), and using a computer interface cable to connect the computer directly (connection via computer interface cable). Refer to the corresponding section according to your computer and system. If you are using a stand-alone MIDI sequencer, read the section about connection via MIDI.

- Connecting the MIDI sequencer --- “Connection via MIDI” on page 11
- Connecting the computer (Using MIDI interface) ---“Connection via MIDI” on page 11
- Connecting an IBM PC compatible (using a computer interface cable) --- “Connecting an IBM PC (Compatible) Computer” on page 12
- Connecting an Apple Macintosh (using a computer interface cable) ---“Connecting an Apple Macintosh Computer” on page 13

Connecting a computer

By connecting a computer to the X5DR using a computer interface cable, you can play the X5DR sound from the computer. In addition, you can control other connected MIDI devices from the computer using the X5DR as a MIDI interface.

You may connect the following types of computers to the X5DR using a dedicated cable (see page 12–13).

IBM PC (compatible): Optional connection kit AG-001 (Cables, Software “KORG MIDI Driver”)

Apple Macintosh series: Optional connection kit AG-002 (Cables, Software “KORG MIDI Driver”)

You might not be able to use these connections depending on the model of computer or the type of application software you use.

- Do not connect the X5DR to a single external device via both MIDI OUT/IN and TO HOST at the same time. Be sure to use only one of these connectors.

Connection via MIDI

To connect a stand-alone MIDI sequencer or a computer with a MIDI interface to the X5DR, use MIDI cables to connect MIDI OUT of the sequencer or computer (MIDI interface) to MIDI IN on the X5DR.

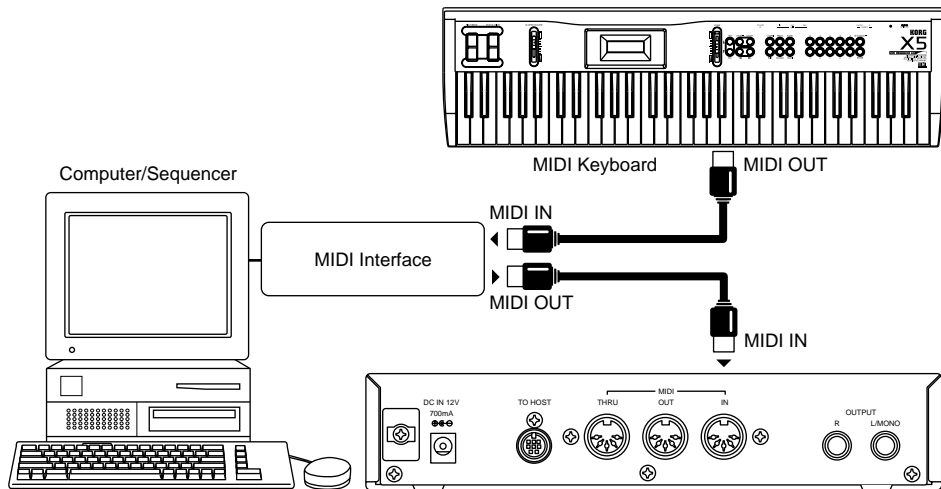

Connect the MIDI OUT jack of the MIDI keyboard to the MIDI IN jack on the sequencer or computer (MIDI interface) using MIDI cables. If you input performance data from the computer or sequencer, you do not have to connect the MIDI keyboard.

If you wish to connect an additional MIDI device, connect it to the MIDI OUT jack of the sequencer or computer (MIDI interface), or to the MIDI THRU jack of the X5DR. Refer to “About MIDI” on page 65 for information on connections using the MIDI THRU jack.

- Refer to the manual that comes with the MIDI interface for information on the connection of the computer and MIDI interface, and the MIDI port settings.

Connecting an IBM PC (Compatible) Computer

Connect the serial port (COM port) of the IBM PC (compatible) computer to the TO HOST connector on the X5DR using a computer interface cable (optional AG-001).

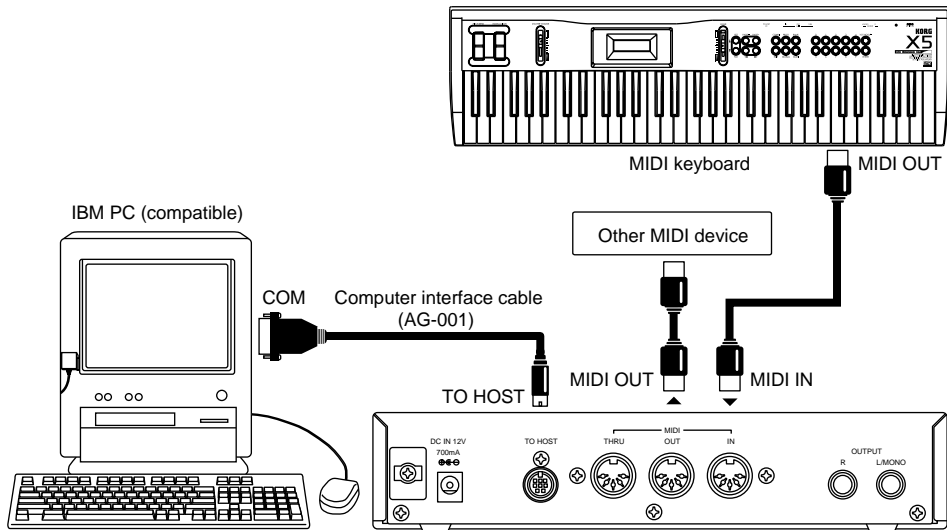

To transmit data (such as Program data) from the TO HOST connector of the X5DR to the computer, set 2B EXT OUT SEL of the Global mode to PCIF. (see page 14.)

- You may not be able to use this connection, depending on the model of computer or the type of sequencer software. Application software that is not compatible with Windows MME (Multimedia Extensions) or Windows 3.1 (except for those specifically supporting the X5DR) cannot be used with this connection.
- If the computer has a 25-pin serial port, use an optional AG-004 9-to-25-pin adapter.

Set 0D PC I/F CLK of the Global mode to "38.4kBPS" (see page 14).

If you use this connection with Windows MME or Windows 3.1, you need to install the Korg MIDI Driver. Refer to page 174 for installation information.

Connecting an Apple Macintosh Computer

Connect the modem port or printer port of the Apple Macintosh computer to the TO HOST connector of the X5DR using a computer interface cable (optional AG-002).

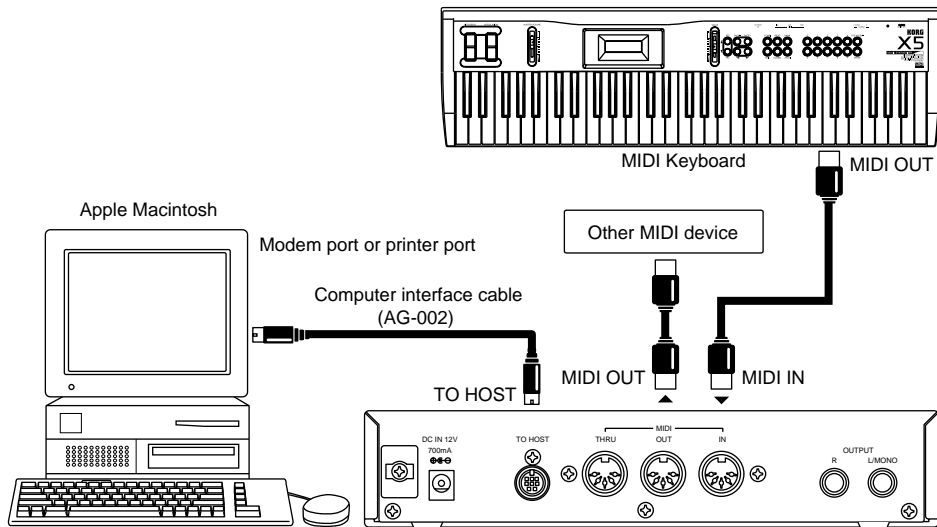

To transmit data (such as Program data) from the TO HOST connector of the X5DR to the computer, set 2B EXT OUT SEL of Global mode to PCIF. (See page 14.)

- This connection might not be used, depending on the model of the computer or the type of sequencer software.
- If your sequencer software has a clock setting, set the clock to 1MHz.

Set 0D PC I/F CLK of the Global mode to "31.25kBPS." (See page 14.)

Installing the Korg MIDI Driver allows the X5DR to output data from its internal tone generator separately from MIDI OUT data. This makes it possible to use the X5DR as a MIDI interface for other connected devices. Refer to page 177 for installation information.

Settings Required When a Computer is Connected

If you have connected the X5DR to the computer using a computer interface cable, set the Computer Select (data transfer rate from/to the computer) and External Out Select (data transmission destination from the X5DR).

Setting Computer Select (0D PCI/F CLK in Global Mode)

- 1 Press the [GLOBAL] button to enter Global mode.
- 2 Select 0A MASTER TUNE (by pressing the [PAGE-] button).
- 3 Press the [Ⓢ] button four times to display 0D PC I/F CLK.
- 4 Use the [▲] and [▼] buttons to set the value.

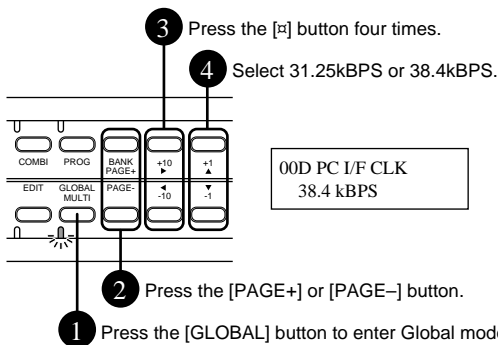

If you connect the X5DR to an IBM PC compatible computer, set this parameter to 38.4kBPS. If you connect the X5DR to an Apple Macintosh computer, select 31.25kBPS.

Setting External Out Select (2B EXT OUT SEL in Global Mode)

- 1 Press the [GLOBAL] button to enter Global mode.
The [GLOBAL] button allows you to switch between Global mode and Multi mode. When the X5DR is in Multi mode (the indicator lights up), press the [GLOBAL] button again to enter Global mode (the indicator flashes).
- 2 Press the [PAGE+] or [PAGE-] button to select 2A MIDI GLOBAL.
- 3 Press the [Ⓢ] button twice to display 2B EXT OUT SEL.
- 4 Use the [▲] and [▼] buttons to assign the function.

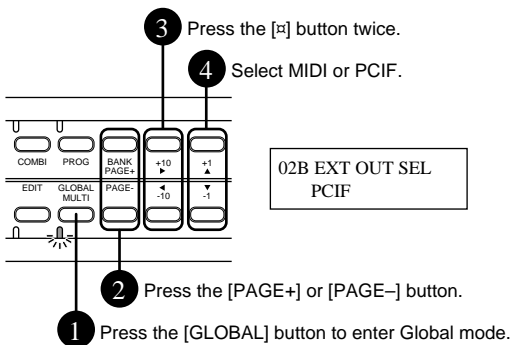

Select "MIDI" to transmit the X5DR data from MIDI OUT, and select "PCIF" to transmit it from TO HOST.

Listening to a Demo performance

The X5DR has two internal songs that demonstrate the X5DR's features. You can play back these songs on the X5DR.

1 Turning the power on/off
 Press the power switch to turn the X5DR power on. Pressing the power switch again will turn the power off.

! Make sure that the connected powered speaker or stereo amplifier is turned off before you power-on the X5DR.

2 Adjusting the volume level
 Use the VOLUME knob to set the optimum volume level.
 * The headphone volume level will be adjusted at the same time.

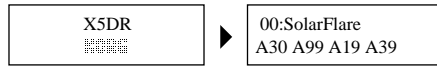

When you turn the X5DR power on, the screen will show the opening message for a few seconds, then show the Combination Play mode indication.

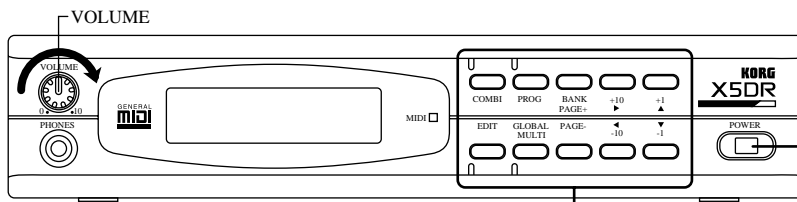

3 Demo performance

Demo Song 1: AROUND THE WORLD By Stephen Kay
 Demo Song 2: WE'VE GOT DREAMS By KORG Inc.

■ Combination Play mode
 The X5DR automatically enters Combination Play mode when you turn the power on.

■ To enter Demo mode:
 Press the [COMBI] button and [EDIT] button simultaneously.

Demo Play
 Press any key

* Four indicators will flash in Demo mode.

■ To quit Demo mode:
 Press one of the following buttons when playback is stopped.

00:SolarFlare
 A30 A99 A19 A39

* The X5DR will quit Demo mode, and enter Combination Play mode.

■ Operation in Demo mode

Demo Song 1: AROUND THE WORLD
 Demo Song 2: WE'VE GOT DREAMS

Pressing one of these buttons will stop playback.

The X5DR will repeat playback of Demo songs 1 and 2.

The X5DR will play back Demo song 1, then Demo song 2.

▶ To listen to playback:
 Press the [COMBI] button to playback Demo song 1.
 Press the [PROG] button to playback Demo song 2.
 * Press the [EDIT] button to play demo songs 1 and 2 consecutively. Press the [GLOBAL]/[MULTI] button to repeat the demo songs in an endless loop.

■ To stop playback:
 If you wish to stop the demo song, press any button.

Listen to and enjoy the wonderful sound, the versatile tone, and the rich expressiveness of the Korg X5DR.

Start-up Guide

Using a Computer/Sequencer

Playing the X5DR in Multi Mode (Playing Back GM Scores)

Multi mode allows you to use the X5DR as a 16-channel multi-timbre (GM) tone generator, controlled from the connected computer, to play ensemble music consisting of multiple instrument parts. This section explains playing the X5DR in Multi mode.

1 Multi mode

Press the [MULTI] button to enter Multi mode.

* The [MULTI] button allows you to switch between Global mode and Multi mode. When the X5DR is in Global mode (the indicator flashes), press the [MULTI] button again to enter Multi mode (the indicator lights up).

GLOBAL MULTI ● Multi mode: The indicator lights up.

GLOBAL MULTI ● Global mode: Indicator flashes.

What is Multi mode?

Multi mode allows you to use the X5DR as a 16-channel multi-timbre (GM) tone generator. You can play different Programs assigned to 16 tracks. When you turn on the power to the X5DR, Multi mode uses a default GM setting, which allows you to play back a GM score (GM performance data) right away. If you wish to restore the GM default setting, send the GM System On message or set 23A SET TO GM accordingly.

* If the GM score is not played back correctly, refer to "Notes on playing back GM scores" on Page 18.

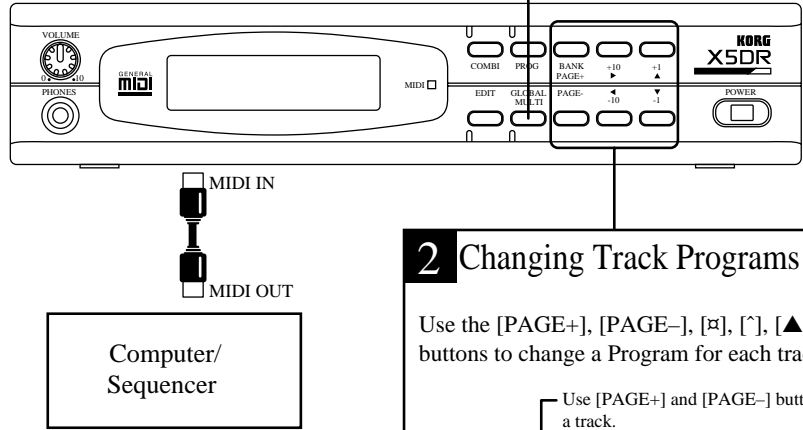

3 Changing Track Programs (2)

When you wish to change Programs from a connected computer or sequencer, you need to send Program Change messages. (See the page 17, 66, 68.)

While Bank A is selected:
Sending Program Change messages 0-99 will select Programs A00-99.

While Bank G is selected:
Sending Program Change messages 0-127 will select Programs G01-128.
* To select Programs G129-136, send Bank Select messages to change the Bank.

* Send the Bank Select messages to change the Banks between A and G.

2 Changing Track Programs (1)

Use the [PAGE+], [PAGE-], [↔], [^], [▲], [▼] buttons to change a Program for each track.

Use [PAGE+] and [PAGE-] buttons to select a track.

Use the [↔] and [^] buttons to select a parameter.

Use the [▲] and [▼] buttons to change the Track Program setting.

Track number (T01-T16)

00A MULTI T01 ∅
G01:Piano

Track Program name
Track Program (A00-99, G01-136)

The X5DR has 100 Programs in Bank A (A00-99), and 136 Programs in Bank G (G01-136), for a total 236 Programs.

* When the X5DR is shipped from the factory, Bank A has Preset a Programs. (See page 20, 156.)

Structure of Multi Mode

Multi mode allows you to use the X5DR as a GM tone generator which conforms to General MIDI System Level 1.

When GM ON messages are received or when the power is turned on, the GM settings are automatically selected. You can restore the GM settings in 23A SET TO GM (see page 114). When the GM settings are selected, MIDI Channels for Tracks 1–16 will become 1–16, respectively. Track 10 (MIDI Channel 10) is used for a rhythm part:G129:GM Kit. Other tracks are assigned G01: Piano.

You can play different Track Programs on each track by transmitting performance information via the MIDI channel that corresponds to each track from a computer or sequencer.

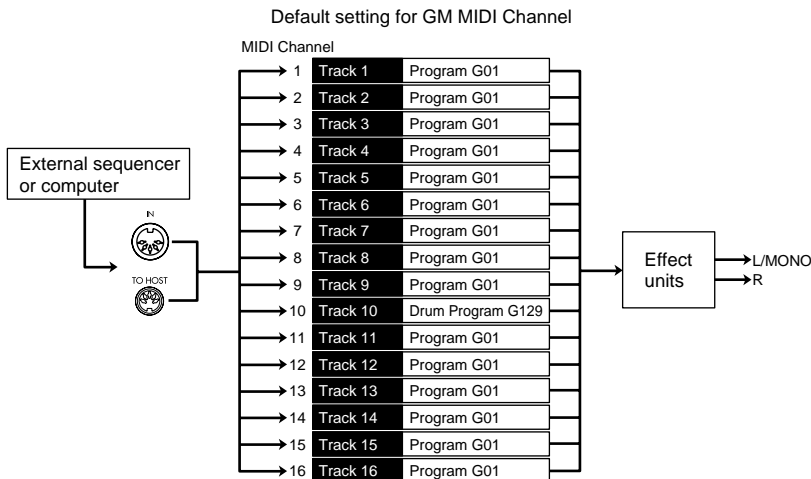

Selecting a Track Program From a Computer or Sequencer

Send the Program Change message on the MIDI channel that corresponds to each track from a connected computer or sequencer to select Track Programs.

To change Program Banks, send Control Change Bank Select (Controller 0/32). The X5DR will select a new Program when it receives a Program Change message following a Bank Select message.

Program Bank	MIDI Bank Select	
Bank A (A00–A99)	CTRL#0=0	CTRL#32=0
Bank G (G01–128)	CTRL#0=56	CTRL#32=any number
Drum Program (G129–136)	CTRL#0=62	CTRL#32=any number

The following Programs G01–128 are different than Programs G129–136 in terms of their response to Bank Select messages.

Program numbers used to select a Drum Program (G129–136) in the Drum Program Bank:

Drum Program	Program Number	Drum Program	Program Number
G129	0	G133	40
G130	16	G134	64
G131	25	G135	24
G132	32	G136	48

- Transmit functions and operations for Bank Select messages and Program numbers are different depending on the type of connected sequencer or sequence software. Refer to your sequencer or sequence software manual for detailed operational information.

Performance settings

Parameters on the X5DR, or MIDI data sent from a computer or sequencer, allow you to make performance settings such as volume level and pan of each track.

On the X5DR, use the [PAGE+] and [PAGE-] buttons to select a track, then use the [Ⓢ] and [√] buttons to select a parameter.

You may set the following parameters by sending the Controllers and RPN from the connected computer or sequencer. You may also set all the parameters using the Exclusive messages.

For details, refer to “Received MIDI data” on page 32, and “MIDI Data” on page 66.

Parameters	MIDI Data
Lev: Volume.....	Controller #7
Pan: Pan.....	Controller #10
Sen: Send C/D	Controller #91/#93
Tra: Transpose.....	RPN 02
Det: Detune.....	RPN01
Bnd: Bend range	RPN 00
Pf: Program Change filter	
Df: Damper filter	
Af: After Touch filter	
Cf: Control Change filter	
KWTop/KWBtm: Key Window	
VWTop/VWBtm: Velocity Window	
MIDI Ch: MIDI channel	

Notes on Playing Back GM Scores

Before playing back performance data (GM scores) for a GM tone generator, make sure that the following settings have been made in Global mode for correct playback.

0B	Key Transpose	+00
0C	Velocity Curve	3
	After Touch Curve	3
1A	Scale Type	Equal Temp
2A	Note Receive	ALL
2C-2D	MIDI Filter	PRG=NUM, EX=DIS, Others=ENA

- See page 146 for the function of each parameter.

Set all the parameters in Multi mode to their default setting. To do so, use 23A SET TO GM (see page 114), or transmit a GM System On message from a computer or sequencer.

Some GM scores may include non-GM MIDI data. In particular, Program Change messages may be interpreted as Bank Select messages (for Bank A) when you are playing back a GM score that uses Bank Select messages. (Bank G contains 128 GM sounds and Drum Programs.) If you wish to play back performance data that has been created, assuming that it will be played back on the X5DR, set the PRG parameter of the MIDI filter in Global mode to “ENA.” To play back other performance data, set this to “NUM” to ignore the Bank Select messages.

If You Cannot Play the X5DR

If no sound is produced from the X5DR or if the sound or performance is not proper, check the following items:

No sound is produced:

- Check to see if Demo songs can be played. If not, check to see if the volume level of the X5DR and the connected powered monitor or stereo amplifier is sufficiently raised. Ensure that the audio cable is connected correctly.
- If Demo songs can be played back, confirm that the unit is in Multi mode.
- Check the connection of the MIDI cables or computer interface cables, and the settings on the computer or sequencer. When the X5DR receives MIDI data, the MIDI indicator lights up. If the MIDI indicator does not light up, the settings on the computer or sequencer may not be correct.
- If you are using a computer interface cable, check to see if 0D PC I/F CLK in Global mode is set correctly. For an IBM PC (compatible), set this parameter to 38.4kBPS. For an Apple Macintosh computer, set it to 31.25kBPS. (See page 14.)
- You need to set up the MIDI port for MIDI data transmission/reception when you are using sequence software on the computer. Check to see if the MIDI port for the connected MIDI interface or KORG MIDI Driver port has been selected. The KORG MIDI Driver allows you to use different MIDI ports for the tone generator inside the X5DR and MIDI data transmitted from the MIDI OUT connector. To play the X5DR, specify the X5DR's tone generator (KORG PC I/F Synth Port).
- Some Windows sequence software may transmit MIDI data via MIDI mapper. If you are using this type of software, use the MIDI mapper on the control panel to change the port name of all the MIDI channel maps to KORG PC I/F Synth Port.

If Programs or Performance Sound Wrong

- If the Program sounds wrong during the playback of the GM score, the GM score may be using the Bank Select message. In this case, set the computer or sequencer so that it will not transmit the Bank Select messages, or set 2C MIDI FILTER in Global mode so that the X5DR will not receive the Bank Select messages. (See page 152.) Then, transmit the GM System On message from the computer or sequencer, or use 23A SET TO GM to restore the default setting, and play the X5DR again.
- If the volume level or pan setting is incorrect, or the parameter settings are not reflected by the performance of the X5DR, the information has probably been cut by the transmission filter of the sequencer/sequence software, or by the KORG MIDI Driver filter. You can set the X5DR using the MIDI FILTER (page 152) in Global mode, and Multi mode so that the X5DR will not receive MIDI messages (page 111). Check these settings again.
- In Multi mode, you can use the X5DR as a 16-part multi-timbral GM tone generator. You can set a Track's Program, volume, and pan settings on the computer or sequencer as well as on the X5DR. (This setting data allows the X5DR to play the performance data in the same conditions.) If these data have not been input, the X5DR may play the performance data using the previous playback settings. Refer to your sequencer/sequence software manual for information on how to create performance data and how to play each track.

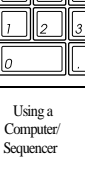

Loading Preset Data

The X5DR has 200 carefully-selected Programs and Combinations (100 types of each) and four Drum Kits (2 types × 2), which are all included as Preset data (Preset a/b).

- Preset a was loaded when the X5DR was shipped from the factory.

1 Press the [Global] button to enter Global mode.

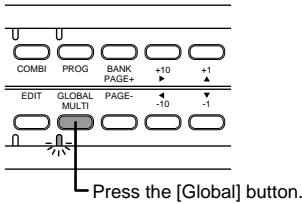

The [GLOBAL] button allows you to switch between Global mode and Multi mode. When the X5DR is in Multi mode (the indicator lights up), press the [GLOBAL] button again to enter Global mode (the indicator flashes).

2 Press the [PAGE+] or [PAGE-] button to select 5A PRESET DATA.

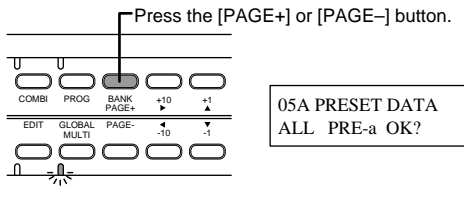

3 Set the left end indication (loading source) to “ALL,” and move the cursor to the next parameter (selecting Preset a and b), and select PRE-a or PRE-b.

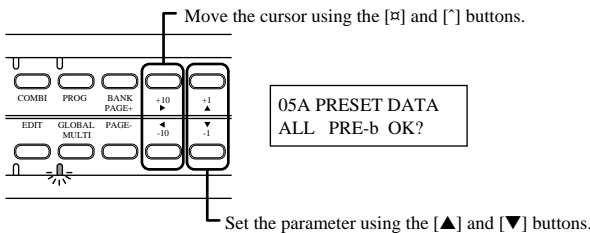

Move the cursor using the [®] and [√] buttons, and set the parameter using the [▲] and [▼] buttons.

4 Move the cursor to “OK?” and press the [▲] button. Press the [▲] button again in response to the message “Are You Sure OK?”.

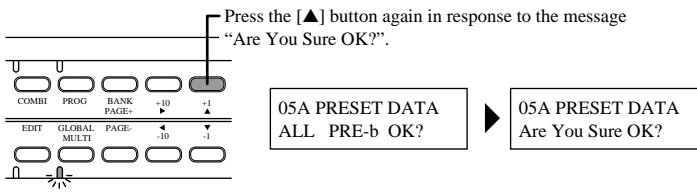

In the example above, the loading source is set to “ALL.” However, you can select different sources. Refer to page 156.

Basic Guide

1. X5DR Modes

There are six operating modes on the X5DR for use with different performances, settings, and functions: Program Play, Program Edit, Combination Play, Combination Edit, Multi, and Global.

Program Play mode

Programs are basic sounds that you can play in Program Play mode. The X5DR contains 236 Programs organized in banks as follows: 100 (A00–99) in RAM (Random Access Memory) where you can store created or edited sounds, and 136 (G01–136) in the built-in preset area.

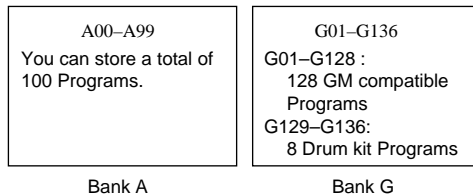

Playing Programs

To play Programs in Program Play mode, set the transmission device (such as a MIDI keyboard or computer) so that its MIDI transmission channel will match the X5DR Global MIDI Channel. Set the X5DR Global MIDI Channel in 2A MIDI GLOBAL in Global mode (see page 151).

Basic operation in Program Play mode

Press the [PROG] button to enter Program Play mode to play Programs.

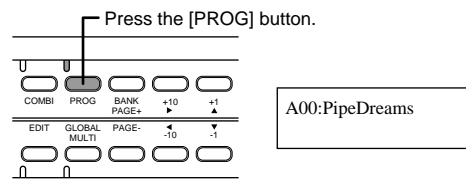

You can switch Programs in Program Play mode by operating the front panel of the X5DR, or by sending MIDI data from an external device.

Changing Programs on the unit

- [BANK] button: Switches between Bank A and G.
- [+10]/[-10] button: Increase/decrease the Program number in steps of 10.

- [+1]/[-1] button: Increase/decrease the Program number in steps of 1.

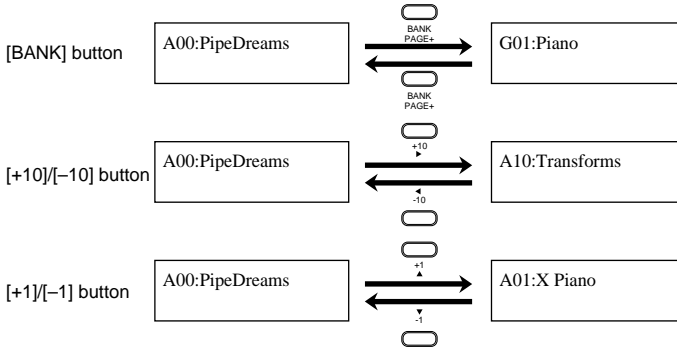
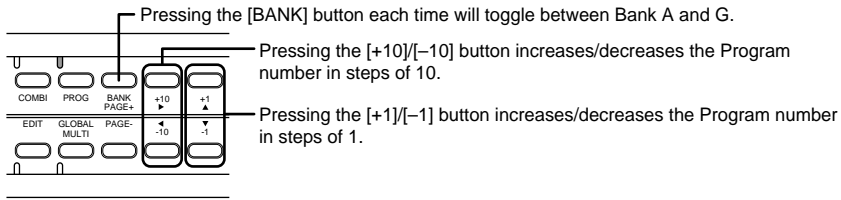

Changing Programs via MIDI

Transmit Program Change messages to change Programs from a MIDI keyboard or external MIDI device. The X5DR will change Programs within the bank when it receives a Program Change message.

- In Bank A, the X5DR interprets MIDI Program Numbers 100–127 as Programs A00–27.
- In Bank G, the X5DR interprets MIDI Program Numbers 0–127 as Programs G01–128.

To change Program Banks, send a Control Change Bank Select (Controller 0/32) message. The X5DR will select a new Program when it receives a Program Change message following a Bank Select message.

Program Bank	MIDI Bank Select	
Bank A (A00–A99)	CTRL#0=0	CTRL#32=0
Bank G (G01–128)	CTRL#0=56	CTRL#32=any number
Drum Program (G129–136)	CTRL#0=62	CTRL#32=any number

The following Programs G01–128 are different than Programs G129–136 in terms of their response to Bank Select messages.

Program numbers are used to select a Drum Program (G129–136) in the Drum Program Bank:

Drum Program	Program Number	Drum Program	Program Number
G129	0	G133	40
G130	16	G134	64
G131	25	G135	24
G132	32	G136	48

- Transmit functions and operations for Bank Select messages and Program numbers are different depending on the type of the connected MIDI keyboard. Refer to your MIDI keyboard manual for detailed operational information.

Program Edit Mode

Program Edit mode allows you to modify the sound of Programs. The figure shows the structure of a Program. You can create your own sound and modify its tonal color by modifying these parameters in Program Edit mode.

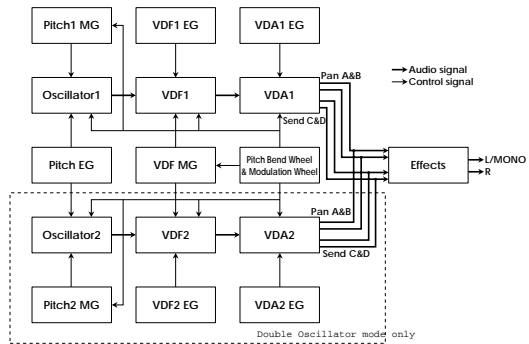

Basic operation in Program Edit mode

Press the [EDIT] button while in Program Play mode to enter Program Edit mode.

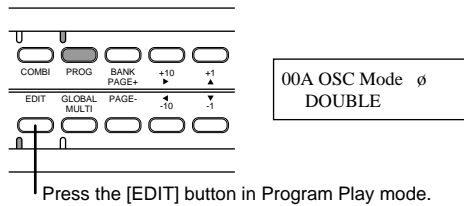

In Program Edit mode, use the [PAGE+] and [PAGE-] buttons to switch the pages, and use the [←] and [→] buttons to move the cursor (flashing line) and select a parameter, and use the [▲] and [▼] buttons to set the value.

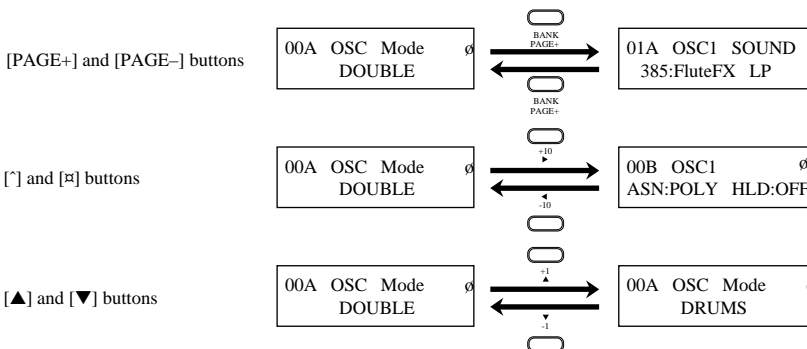
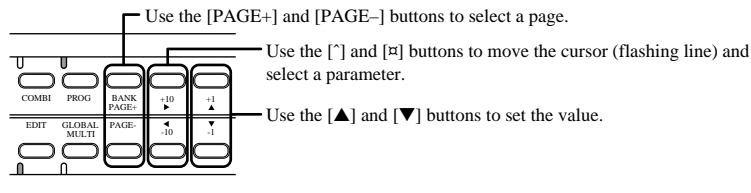

You can write a Program that you created and edited in Program Edit mode to Program Bank A (A00–99).

Refer to “3. Editing” (page 36) for information on how to edit Programs, and refer to “1. Program Parameters” (page 78) for information on the parameter functions.

Combination Play Mode

Combinations (a combination of Programs) can use up to eight Timbres. Each Timbre is assigned a Program. You can play Combinations in Combination Play mode. The X5DR contains 100 Combinations (00–99).

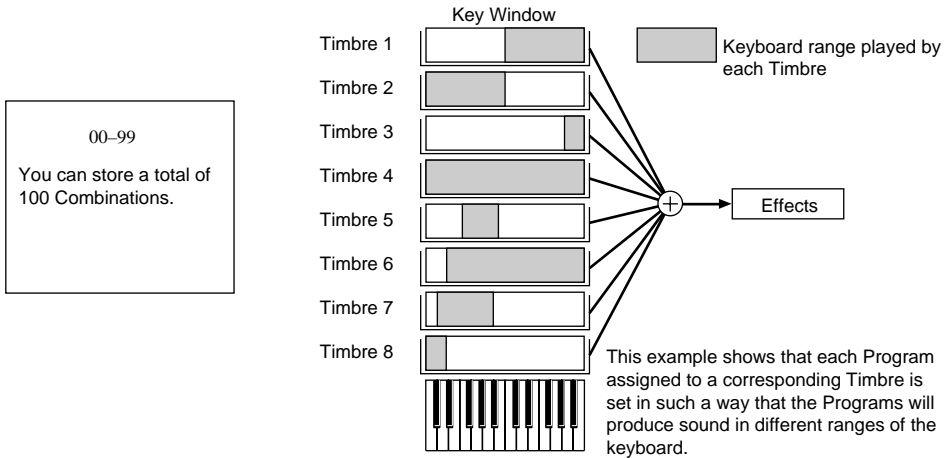

Playing Combinations

The eight Timbres in Combinations can be assigned to different MIDI Channels. (Initially, all Timbres are assigned to MIDI Channel 1.) Set the MIDI receive channel of each Timbre so that it matches the MIDI channel of the transmission device such as a computer or MIDI keyboard.

Combination Play mode allows you to combine up to eight Programs, and is useful in live performance. You can also use the X5DR as a multi-timbral tone generator by assigning a different MIDI channel to each Timbre.

- Each Timbre in a Combination has MIDI filters for MIDI message such as Program Change, Damper (Hold 1), After Touch, and Control Change. Therefore, MIDI data for which the MIDI filter is set to “D (Disable)” will be ignored. (See page 104.)

Basic operation in Combination Play mode.

Press the [COMBI] button to enter Combination Play mode to play Combinations.

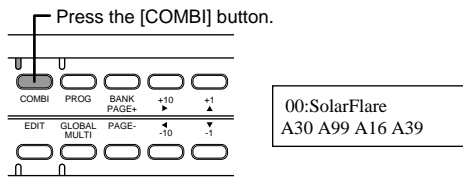

You can switch Combinations in Combination Play mode by operating the front panel of the X5DR, or by sending MIDI data from an external device.

Changing Combinations on the unit

- [+10]/[-10] button: Increase/decrease the Combination number in steps of 10.
- [+1]/[-1] button: Increase/decrease the Combination number in steps of 1.

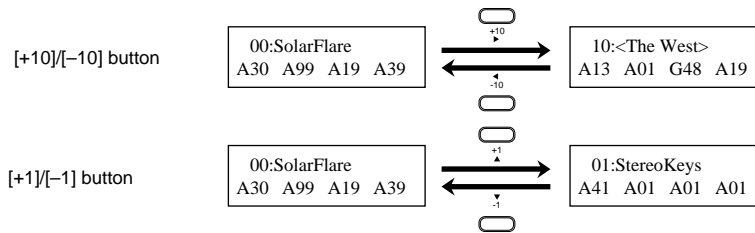
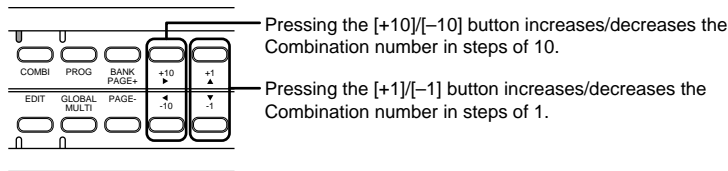

Changing Combinations via MIDI

Transmit a Program Change message on the Global MIDI Channel to change Combinations from an external MIDI device.

When you send Program Change messages to the X5DR for channels other than the Global MIDI Channel, the individual Programs within the Combination will change.

- Refer to page 22 for information on selecting a Program for each Timbre via MIDI.

Combination Types

You can combine various Programs by editing the Timbre settings in Combinations. For example, you can play a different Program with each hand, or you can play different Programs by applying a different key touch (key velocity) to the keyboard. These techniques are very useful and powerful in live performance. Settings that determine the combination of Programs are made in Combination Edit mode. (See “Editing Combinations” on page 51.) Let’s take a look at the various types of Combinations that are available.

Layer

The X5DR produces the sound of multiple Programs simultaneously. When Timbres are layered together, they produce a thick and complex Combination, such as a piano sound overlapped with a strings sound.

Split

Timbres can be set to produce the sound of a different Program when you play a different range on the keyboard. For example, you can play a piano sound in the higher range of the keyboard using your right hand, and play a bass sound in the lower range of the keyboard using your left hand.

VSw (Velocity Switch)

Timbres can be set to respond to a specific key velocity (how firmly you strike the keys). For example, you can set Timbres in such a way that a strings sound is produced when you play the keyboard softly, and a brass sound is produced when you play the keyboard hard.

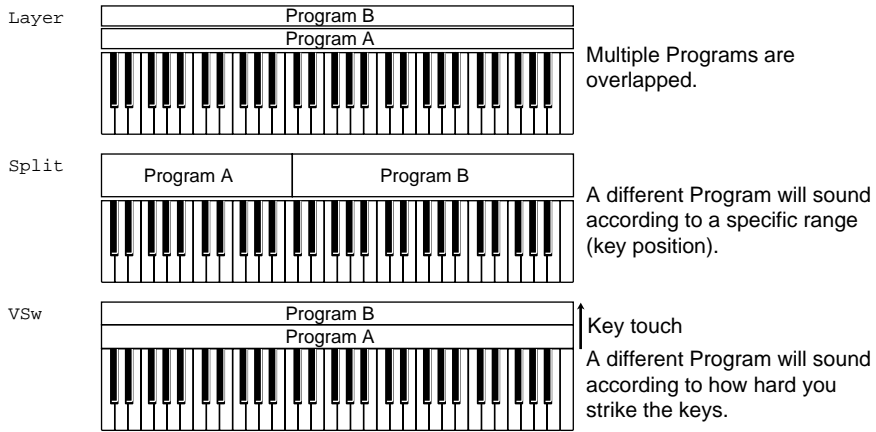

The examples here are all based on the use of two Programs. Since the X5DR allows you to use up to eight Timbres, you can combine these types to create more sophisticated settings.

Combination Edit mode

Combination Edit mode allows you to modify the sound of Combinations. You can change the Programs assigned to the Timbres and edit the voicing range of each Timbre.

Basic operation in Combination Edit mode

Press the [EDIT] button while in Combination Play mode to enter Combination Edit mode.

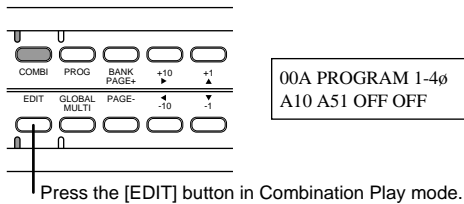

In Combination Edit mode, use the [PAGE+] and [PAGE-] buttons to switch the pages; use the [Ⓜ] and [Ⓝ] buttons to move the cursor (flashing line) and select a parameter; and use the [▲] and [▼] buttons to set the value.

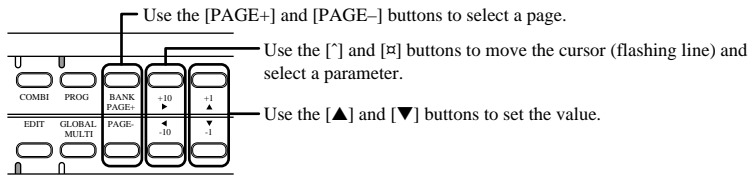

Refer to "Editing Combinations" (page 51) for information on how to edit Combinations, and refer to "2. COMBINATION Parameters" (page 100) for information on the parameter functions.

Multi Mode

In Multi mode, you can play the X5DR as a 16-part multi-timbral GM tone generator. In this mode, 16 tracks are available to play Bank A and G Programs.

Playing the X5DR in Multi mode

In Multi mode, you can use 16 tracks, each of which can be assigned to a different MIDI receive channel. (Initially, Tracks 1–16 are assigned to MIDI receive channels 1–16, respectively.) Transmit data from a transmission device (such as a MIDI keyboard or computer) via the respective MIDI channel.

- Initially, you can use the X5DR as a GM tone generator in Multi mode.

Basic operation in Multi mode

Press the [MULTI] button to enter Multi mode.

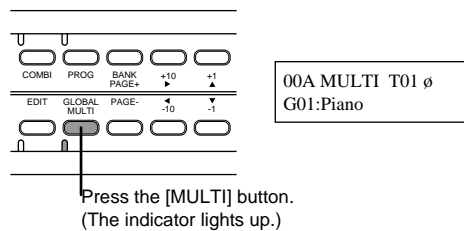

- The [MULTI] button allows you to switch between Global mode and Multi mode. When the X5DR is in Global mode (the indicator flashes), press the [MULTI] button again to enter Multi mode.

You can change each track's settings by means of message sent from the front panel or from an external MIDI device.

Editing on the unit

Use the [PAGE+] and [PAGE-] buttons to switch pages; use the [√] and [Ⓜ] buttons to move the cursor (flashing line) and select a parameter; and use the [▲] and [▼] buttons to set the value.

- Pages 0A–15D are used to set Track parameters. Pages from 16A on are used to set the parameters for the entire Multi mode, such as effect settings and the copy function.

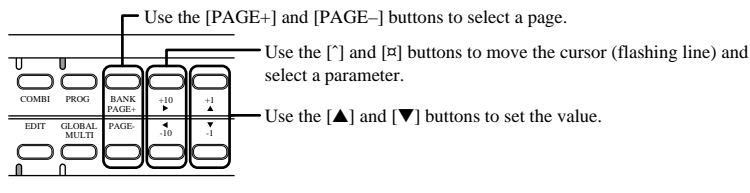

Default settings in Multi mode

The following table shows the default settings for Multi mode that are automatically selected when the X5DR power is turned on, or when the X5DR receives a GM ON message (F0 7E 7F 09 01 F7). You can also use the function on page 23A SET TO GM.

	Track1–9, 11–16	Track 10	
Program	G01: Piano (for all Tracks)	G129: GM Kit	*Can be controlled via MIDI
Level	127 (for all Tracks)	127	
Panpot	CNT (for all Tracks)	PRG	*Can be controlled via MIDI (except for Track 10)
Send C	2 (for all Tracks)	P	*Can be controlled via MIDI (except for Track 10)
Send D	2 (for all Tracks)	0	*Can be controlled via MIDI
Transpose	0 (for all Tracks)	0	*Can be controlled via MIDI
Detune	0 (for all Tracks)	0	*Can be controlled via MIDI
Pitch Bend Range	+2 (for all Tracks)	0	*Can be controlled via MIDI
Program Change Filter	ENA (for all Tracks)	ENA	
Damper Pedal Filter	ENA (for all Tracks)	ENA	
After Touch Filter	ENA (for all Tracks)	ENA	
Control Change Filter	ENA (for all Tracks)	ENA	
Key Window	C-1–G9 (for all Tracks)	C-1–G9	
Velocity Window	001–127 (for all Tracks)	001–127	
Effect	----	----	FX1: Hall, FX2: Chorus 1
MIDI Channel	1–9, 11–16 (Corresponding to the Track number)	10	

Track settings via MIDI

About Program

Sending Bank Select and Program Change messages will select a Program for each Track. Refer to page 22 for information on how to specify Programs.

About Level

Send the Control Change Volume message (Controller #7) or the Expression message (Controller #11) to change the volume level of each Track.

- You cannot change the Level parameter value using MIDI Control Change messages.

About Panpot

Send the Control Change Panpot data (Controller #10) to change the panpot setting for each Track. Track 10 will ignore the Panpot message and its pan setting for each index if a Drum Kit is used, since “PRG” is the default setting for Track 10. However, if the panpot setting for Track 10 is set to any value other than “PRG”, this Track will respond to the received Panpot message. (That is, the panpot settings for all indexes in the Drum Kit will become the same.)

About Send C/D

Send the Control Change Effect Depth message (CTRL#91/93) to change the Send C/D settings for each Track. Track 10 will ignore CTRL#91/93 and its Send C/D setting for each index if a Drum Kit is used, since “P” is the default setting for Track 10. However, if the Send C/D setting for Track 10 is set to any value other than “P”, this Track will respond to the received Send C/D message. (That is, the Send C/D setting for all the indexes in the Drum Kit will become the same.)

About Transpose, Detune, and Pitch Bend Range

You can change these settings for each Track using RPN. Specify the parameter you wish to edit using RPN or Controller #100 or #101, then set the value using the Data Entry controller (Controller #6 or #38)(see page 71).

Global Mode

In this mode you can make settings that affect the entire X5DR (overall tuning and MIDI-related settings), and assign drum sounds to a Drum kit.

Basic operation in Global mode

Press the [GLOBAL] button to enter Global mode.

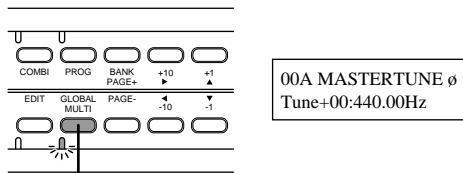

Press the [GLOBAL] button.
(The indicator flashes.)

- The [GLOBAL] button allows you to switch between Global mode and Multi mode. When the X5DR is in Multi mode (the indicator lights up), press the [GLOBAL] button again to enter Multi mode.

Use the [PAGE+] and [PAGE-] buttons to switch the pages; use the [←] and [→] buttons to move the cursor (flashing line) and select a parameter; and use the [▲] and [▼] buttons to set the value.

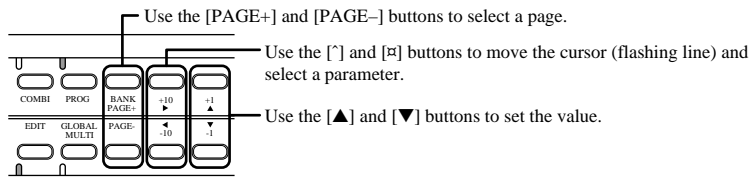

Refer to “5. Global Parameters” (page 146) for each parameter function in Global mode.

2. Performance Techniques

Structure of the X5DR

Control via MIDI/Sequencer

The X5DR is a MIDI tone module that receives MIDI messages from an external MIDI device to playback data. You can also connect a computer directly to the X5DR using a computer interface cable. The following diagram shows how the signal flows between the MIDI connectors, TO HOST connector, and the X5DR (tone generator section).

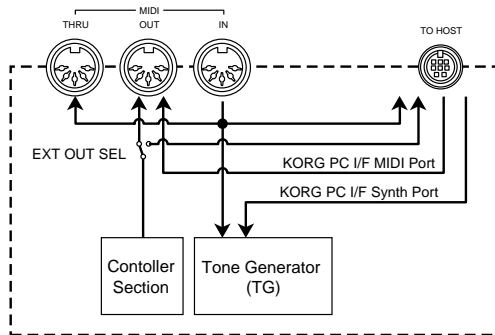

MIDI connector

The signal flows via the MIDI connectors as follows:

MIDI IN

This connector receives MIDI data from an external MIDI device to send it to the tone generator. The received MIDI data is output from the MIDI THRU connector as it is. If the computer is connected to the TO HOST connector, the MIDI data received here is transmitted from the TO HOST connector to the computer.

MIDI OUT

When 2B EXT OUT SEL is set to MIDI in Global mode, the MIDI data (that is output when you operate the panel) is transmitted to an external MIDI device. When EXT OUT SEL is set to PCIF, the data is not output from the MIDI OUT connector. This connector also outputs MIDI data of the KORG PC I/F MIDI Port received at the TO HOST connector.

When 4A MIDI DUMP is selected in Global mode, the signal is transmitted to the destination specified in 4A. (See page 154.)

TO HOST connector

Connecting the TO HOST connector and a computer using a computer interface cable allows you to control the X5DR from the computer, and allows you to send MIDI data to the computer.

From the computer

There are two ports for a signal sent from the computer: KORG PC I/F MIDI Port and KORG PC I/F Synth Port. The signal at the KORG PC I/F MIDI Port is output from the MIDI OUT connector. The signal at the KORG PC I/F Synth Port is sent to the tone generator section.

To the computer

MIDI data received at the MIDI IN connector is transmitted from the TO HOST connector to the computer. When EXT OUT SEL is set to PCIF, the MIDI data (that is output when you operate the panel) is sent from the TO HOST connector to the computer.

- The KORG PC I/F MIDI Port and the KORG PC I/F Synth Port are available when you are using the KORG MIDI Driver. (See page 177) If you are not using the KORG MIDI Driver, the signal is output to both ports simultaneously.

Signal flow in various modes

MIDI data received at the MIDI IN connector and TO HOST connector is transmitted in Program Play mode, Combination Play mode, and Multi mode as follows:

Program Play mode

In Program Play mode, the X5DR receives MIDI data on the Global MIDI Channel to play data. Sending Program Change and Bank Select messages on the Global MIDI Channel will allow you to switch Programs.

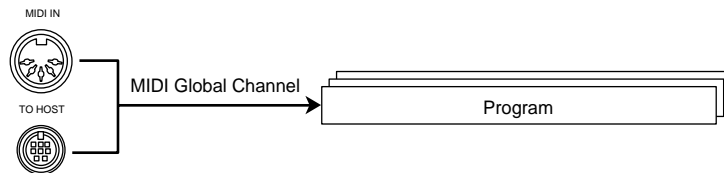

- Set the Global MIDI Channel on 2A MIDI GLOBAL in Global mode. (See page 151.)

Combination Play mode

In Combination Play mode, data is played on the MIDI receive channel of each Timbre. Sending Program Change and Bank Select messages will change the Program used for the respective Timbres. You can change the Combinations by sending Program Change messages on the Global MIDI Channel.

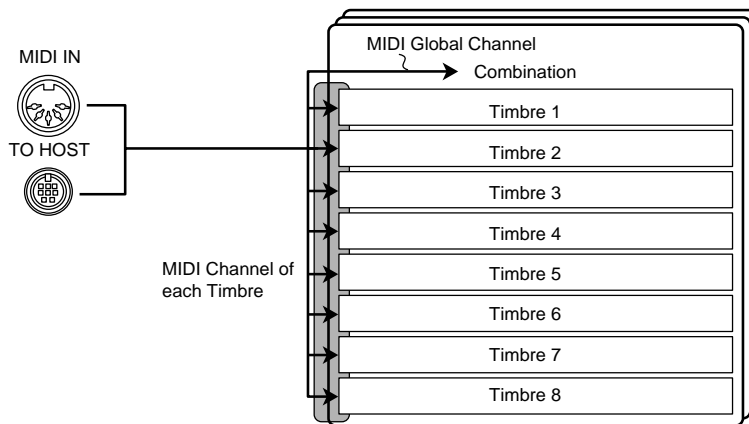

- Set the Global MIDI Channel on 2A MIDI GLOBAL in Global mode. (See page 151)
Set the MIDI channel for each Timbre on 2A, 2B MIDI CH. (See page 102.)
- If the Global MIDI Channel matches a Timbre's MIDI receive channel, receiving a Program Change message will change the Combination.
- Effect control data is received on the Global MIDI channel.

Multi mode

In Multi mode, the X5DR plays back data on each Track's MIDI receive channel. Sending Program Change and Bank Select messages will change the Program used for the corresponding Track. When you turn on the X5DR power, when the X5DR receives a GM system on message, or when 23A SET TO GM in Multi mode is executed, each Track's MIDI receive channel is set to the same number as the Track number.

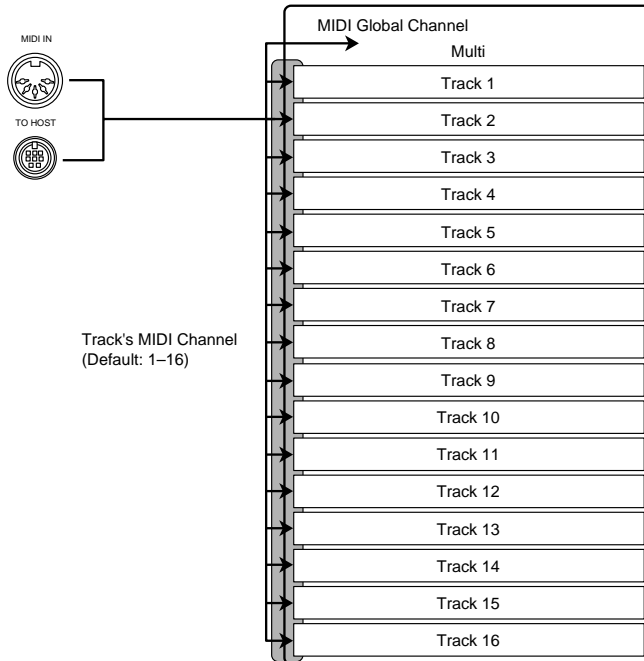

- Effect control data is received on the Global MIDI channel.

Received MIDI data

The X5DR receives the following MIDI data:

Note On/Off (Note information)

This is a message for basic performance data. You can add information regarding the intensity of the notes by using Velocity to describe how strongly you play the keyboard (key touch or key velocity). The X5DR receives all notes (0–127) (sound pitch). However, some note ranges might not play, depending on the particular Program.

Program Change

This message changes the Programs. In Program Play mode and Multi mode, it changes the Programs within the same Bank. In Combination Play mode, sending this message changes Programs on the Timbres' MIDI channel, and it changes Combinations on the Global MIDI Channel. Use the Bank Select message to change the Programs between Bank A and G, or to use the Drum Programs.

Pitch Bend

This message provides a subtle change in pitch (less than a semitone). You can shift the pitch of a note (that was produced by a Note On message) up or down. You can set the bend range (the range of pitch change created by the Pitch Bend message) for each Track using RPN only in Multi mode.

After Touch

While you play the keyboard, pressing the keys harder will control tonal brightness. The X5DR can receive After Touch message (Channel Pressure).

Control Change

Sending this message allows you to adjust performance conditions, such as the volume level and pan settings. Each Controller has its own function. The X5DR can receive the following Control Change messages:

Bank Select (CTRL#0/32)

This changes the Program Bank. Use this message to switch between Banks A and G, and Drum Programs.

Modulation (CTRL#1/2)

This adjusts the depth of modulation effects, such as vibrato. The X5DR receives CTRL#1 (Pitch MG) and CTRL#2 (VDF Cutoff MG).

Pedal (CTRL#4)

This is a message for a pedal controller. The X5DR uses this message to switch between the main and sub scales.

Data Entry (CTRL#6/38)

This message is used to set the value of the selected parameter by means of RPN. This is also used to edit the Programs along with Exclusive data.

Volume (CTRL#7)

This message adjusts the volume level. In particular, this is primarily used to adjust the volume balance between the Timbres/Tracks.

Pan (CTRL#10)

This message sets the panpot A:B (only in Combination Play mode and Multi mode).

Expression (CTRL#11)

This message adjusts the volume level. In particular, it is used to change the volume level over time for performance expression.

Effect Controller (CTRL#12/13)

This message is used as a dynamic modulation source for the effects. Controller #12 controls PEDAL 1, and Controller #13 controls PEDAL 2.

Damper (CTRL#64)

This message transmits data from the damper pedal.

EG Time (CTRL#72/73)

This message adjusts the rate of change in envelopes. Use Controller #72 to adjust the Release (the duration of the sound's decay), and use Controller #73 to adjust the Attack (the attack rate).

Brightness (CTRL#74)

This message adjusts tonal brightness.

Send C/D (CTRL#91/93)

This message adjusts the Send C/D level. In particular, it is used to adjust the depth of the effects. Controller #91 controls Send C, and Controller #93 controls Send D.

Effect On/Off (CTRL #92/94)

These messages switch Effect 1 (CTRL#92) and Effect 2 (CTRL#94) on and off.

Data Increment/Decrement (CTRL#96/97)

This message increases or decreases values. It is also used to edit the RPN. In particular, you can use it to edit Programs along with Exclusive data.

RPN (CTRL#100/101)

This message is used to set the tuning and bend range. After selecting parameters using the RPN, use the Data Entry or Data Increment/Decrement to change the value.

Exclusive

This message is used to transmit parameter settings. Use this when you wish to transfer Program data between the X5DR and 05R/W or X5 series, or to edit Programs from a computer.

Performance Functions

Besides selecting Programs and Combinations to play music, you can add rich expression to these sounds using various performance techniques. For example, using a pedal switch will add the effect of a damper pedal to the piano sound. For a guitar sound or brass instrument sound, you may use Pitch Bend to control pitch and to produce a vibrato effect. These techniques, which are used to add expression to your performance, are called “Performance Functions.”

Keyboard Velocity

How hard you play the keyboard (or the velocity specified on the computer or sequencer) affects the expressiveness of the sound. You can adjust the volume level setting so that playing the keyboard softly will produce a soft sound, and playing hard will produce a loud sound. In addition, you can also adjust the brightness of the sound and the envelope settings, such as the attack rate and release time. Using Velocity Switch in Combination Play mode and Multi mode, you can play different Programs by changing the keyboard velocity.

- ☛ See page 91, 93 for information on how to change the volume level and envelope using key velocity.
- ☛ See page 87, 89 for information on how to change the brightness and tonal color of the sound using key velocity.
- ☛ See page 83 for information on how to control the pitch change using key velocity.
- ☛ See page 103, 112 for information on how to play different Programs using key velocity.

Pitch Bend/Modulation Wheel

The joystick on a MIDI keyboard (pitch bend/modulation wheels) allows you to adjust the pitch or depth of modulation. You can also control these by transmitting pitch bend and modulation message from a computer/sequencer.

- The shape or operation of the controllers may vary depending on the MIDI keyboard you are using. Refer to the manual for your MIDI keyboard. You can control pitch bend and modulation simultaneously using the joystick on the X3. Moving the joystick left and right controls pitch; moving it upward (+Y) controls vibrato (pitch modulation); and downward (–Y) controls wah (VDF modulation).
- ☛ See page 98, 110 for information on how to change the pitch bend range.
- ☛ See page 98 for information on how to change the cutoff bend range.
- ☛ See page 95 for information on how to change the depth and rate of vibrato.
- ☛ See page 98 for information on how to change the depth of the wah.

Effect Dynamic Modulation

Effect Dynamic Modulation is a function that controls the effect level balance and modulation rate. Controlling the effect parameters using the Control Change messages and volume level (VDA EG) allows for real-time effect adjustment during performance.

- ☛ See page 116 for information on adjusting real-time effect parameters.

After Touch

While you play the keyboard, pressing the keys harder will control tonal brightness or modulation.

- ☛ See page 95 for information on adjusting the depth of vibrato using After Touch.
- ☛ See page 97 for information on adjusting the depth of wah using After Touch.
- ☛ See page 97 for information on adjusting the pitch using After Touch.
- ☛ See page 97 for information on adjusting the brightness of the sound using After Touch.
- ☛ See page 97 for information on adjusting the volume level using After Touch.

3. Editing

Basic Concepts

Although you can perform a wide variety of music using the preset Programs and Combinations offered by the X5DR, you should not limit your creativity by relying on the presets alone. You can modify a preset sound. (This operation is called “editing.”) You can also create sounds from scratch.

The X5DR is not only a tone generator that provides various factory-set sounds, but also a synthesizer that employs Korg’s powerful AI² Synthesis, which allows you to create new, original sounds or to edit existing sounds. Take a moment to try out the sound-editing capabilities of the X5DR.

Sound Structure

The X5DR can produce a variety of sounds, such as piano, guitar, drums, percussion, synthesizer, special effects, etc. In order to modify these sounds or to create new sounds, you need to tell the X5DR how you wish to change the sound using parameters. You can edit the sound by modifying parameters in Program Edit mode and Combination Edit mode.

For smooth editing operations, it is helpful to understand the elements of sound. Musical sound consists of three main components: pitch, tone, and volume. In a tone generator, each of these components has its own corresponding building block. In the X5DR, pitch is handled by the OSC (oscillator) block, tone by the VDF (Variable Digital Filter) block, and volume by the VDA (Variable Digital Amplifier) block. The following illustration shows the three blocks.

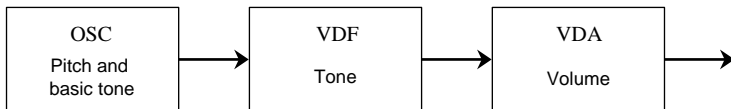

Pitch: OSC (oscillator)

The basic tonal quality of an X5DR sound is determined by the waveform (Multisound) that you assign to an oscillator. The X5DR contains a great variety of Multisounds to simulate different sounds, from piano to synth sounds. The first step in creating a new sound is to select a Multisound.

Tone: VDF (filter)

The VDF allows you to adjust the brightness of a sound. A Multisound assigned to the OSC contains various harmonics and frequency components that characterize the tonal quality of the sound (such as a piano or guitar sound). The VDF employs a low pass filter to remove high frequency components from a Multisound in order to adjust the brightness of the sound. Typically, the more frequency components that are filtered, the darker (softer) a sound will become.

Just like a real musical instrument, you can change the tonal quality of a Multisound over time. You do this by adjusting the amount of filtered components (brightness) using the VDF EG. For example, you can make a sound that is bright at the start, but gradually becomes darker over time.

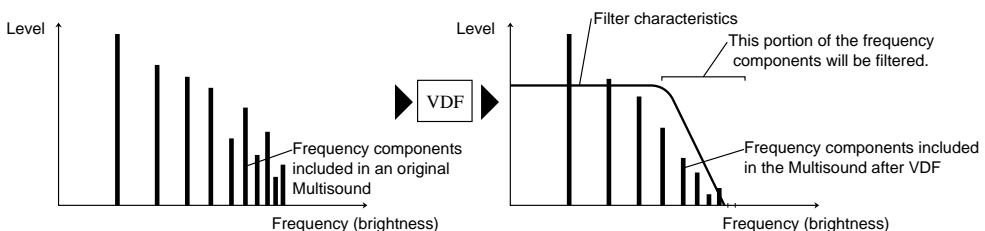

Volume: VDA (amplifier)

The VDA allows you to adjust volume. The “volume” referenced here is not the volume of the entire performance, but the volume changes within a sound. For example, the volume of the piano sound starts with a high attack level, then drops gradually. The organ sound volume does not change until you release the key, while the violin volume varies depending on performance technique. The VDA allows you to edit such changes in volume.

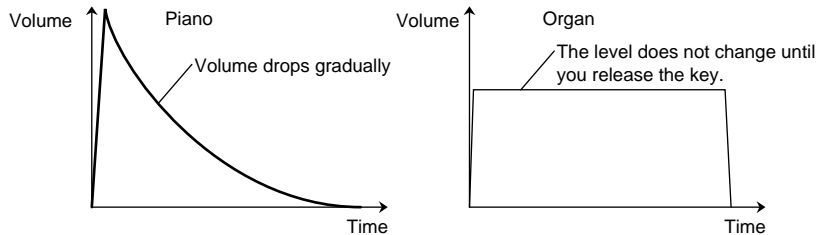

EG and MG

The X5DR provides EGs (Envelope Generator) and MGs (Modulation Generator), which are used to add changes over time (or in cycles) to the pitch, tone, and volume.

EG

This allows you to add changes over time to a sound. The X5DR has Pitch EGs, VDF EGs, and VDA EGs, which are available for editing pitch, tone, and volume, respectively. For example, adjusting the VDA involves determining how the volume changes over time by the VDA EG.

MG

This allows you to add cyclical changes to the sound. The X5DR utilizes Pitch MGs and VDF MGs, which are available for editing pitch and tone. The Pitch MG allows you to add cyclical changes in pitch (vibrato or pitch modulation); VDF MG will add cyclical changes in tone (wah or VDF Cutoff modulation).

Editing Programs

Before Editing

The X5DR offers 236 Programs in Bank A and G, and you can store edited programs in Bank A. When you select Program Edit mode, the Program is copied from Bank A or G to the edit buffer. You will edit Program data in the edit buffer.

Therefore, when you are editing a Program in Program Edit mode, the original Program stored in Bank A will not be overwritten or lost. If you wish to store the edited Program, you can write the edited Program in the edit buffer to Bank A.

- You cannot write Programs in Bank G.

When the X5DR plays back data, it uses the Programs in the edit buffer. Data in the edit buffer will be edited.

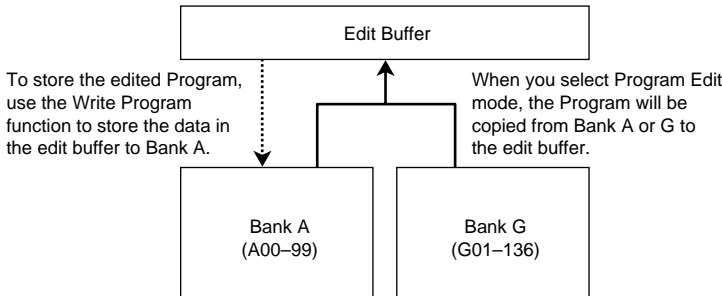

About Memory Protect

The X5DR allows you to write Programs as Bank A Programs 00-99. To avoid accidental overwriting of the data, the X5DR has a Memory Protect function in Global mode. To write an edited Program in Bank A, set the Memory Protect parameter in Global mode to OFF.

- 1 Press the [GLOBAL] button to enter Global mode.
- 2 Press the [PAGE+] or [PAGE-] button to select 3A PROTECT.
- 3 Use the [▼] button to set the PROTECT parameter to OFF.

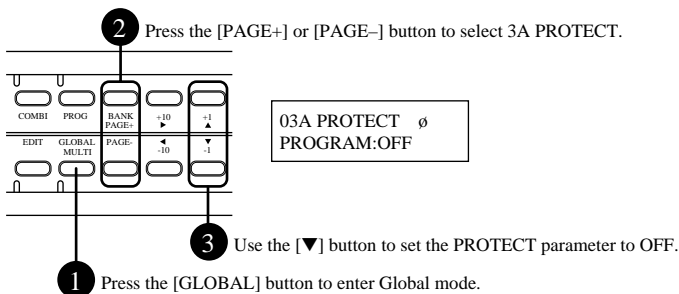

Writing Programs

To store the Program edited in Program Edit mode, you need to use the Program Write function. Follow the procedure below to write the Program in Bank A.

- 1 Press the [PAGE+] button in Program Edit mode to select 22A PROG WRITE (in Double mode) or 16A PROG WRITE (in Single and Drums mode).
 - You can write the Program as it is. However, this section explains how to name and write the Program.
- 2 Press the [Ⓜ] button to select 22B RENAME.
- 3 Use the [↖] and [Ⓜ] buttons to move the cursor (flashing line), and use the [▲] and [▼] buttons to set the Program name.
 - You can use up to 10 characters for the Program name.
- 4 Press the [↖] button to return to 22A PROG WRITE.
- 5 Move the cursor to “OK?” and press the [▲] button. The display shows “Are You Sure OK?”. Press the [▲] button again.
 - You can specify the Program number of the Write destination. If you wish to keep the original Program or if you have edited a Program in Bank G, specify the Program number (A00–99) of the Write destination.

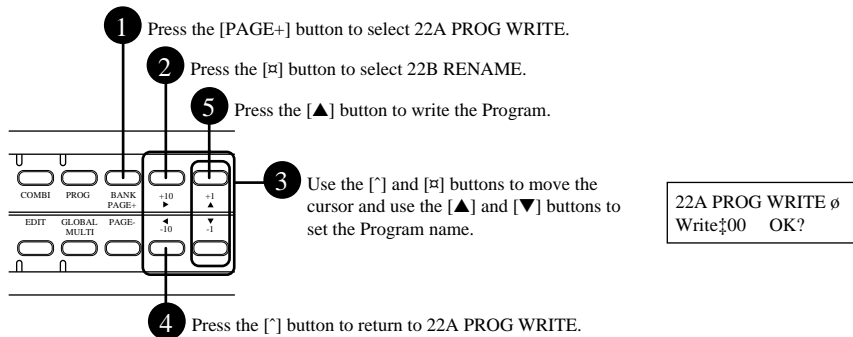

Checking the Sound While Editing

To edit Programs, you usually edit the parameters while checking the changes in tone. If you are using a MIDI keyboard, check the sound while playing the MIDI keyboard. If you are using a computer/sequencer, transmit the MIDI data on the Global MIDI Channel to check the sound. The X5DR does not receive Program Change or Bank Select messages in Program Edit mode. However, sending MIDI data will change the Programs in Program Play mode (the edit data will be lost). You may want to set the X5DR so that it will not receive Program Change or Bank Select messages while editing.

- The data edited in Program Edit mode (Program data in the edit buffer) is kept until you change Programs in Program Play mode, or until you turn off the power to the X5DR. If you wish to store an edited Program, use the Program Write function to write the data in Bank A.

<<About Preset Programs>>

The following section explains how to edit Programs using a Program in Preset a as an example. Load PRE-a before starting the procedure.

Adjusting the Attack of Programs

Let's use Program A01: X Piano to edit the speed at which the attack part of the sound reaches its peak.

Note: If Program A01 is not X Piano, a Program from Preset *b* may have been loaded. In this case, load the Program from Preset *a* before editing (page 20).

1 Select A01: X Piano in Program Play mode.

2 Press the [EDIT] button to enter Program Edit mode.

To edit a Program, first select a desired Program in Program Play mode, then select Program Edit mode.

3 Press the [PAGE+] or [PAGE-] button to select 5A VDA1 EG on the screen.

- Program A01: X Piano is a Single mode Program. If you have selected a Double mode Program, which has more display pages, select page 8A.

4 Press the [√] and [⊗] buttons to select AT. (Usually, the cursor will already be located on the AT parameter.)

- The AT parameter is used to set the attack time. (See page 90.)

5 Use the [▲] and [▼] buttons to set the AT value.

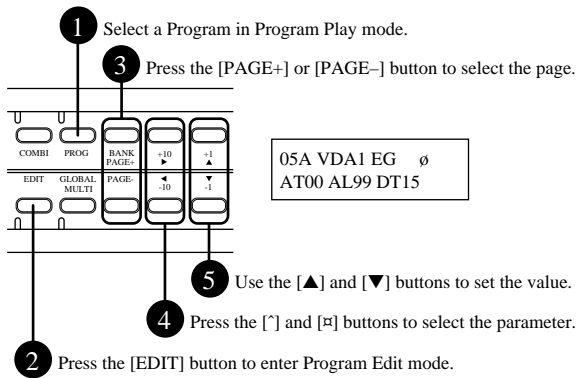

Play the keyboard and listen to the sound while changing the AT value. A higher value will produce a slower attack. When it reaches about 50, the piano Program starts to sound more like a cello. Even editing the attack time alone can change the sound characteristics.

Now set the AT parameter back to 00.

In this way, you can edit the parameters in Program Edit mode using the [PAGE+] and [PAGE-] buttons to select a page, [√] and [⊗] buttons to select a parameter, and the [▲] and [▼] buttons to set the value.

Adjusting the Decay

The volume level of Program A01: X Piano is gradually decreased even if you continue holding down the key. This decay portion is set by DT (Decay Time) on page 5A VDA1 EG, and BP (Break Point) and ST (Slope Time) on page 5B VDA1 EG.

After adjusting the attack, page 5A VDA1 EG is shown. Use the [√] and [®] buttons to select other parameters.

The following diagram shows what is specified by the VDA EG parameters.

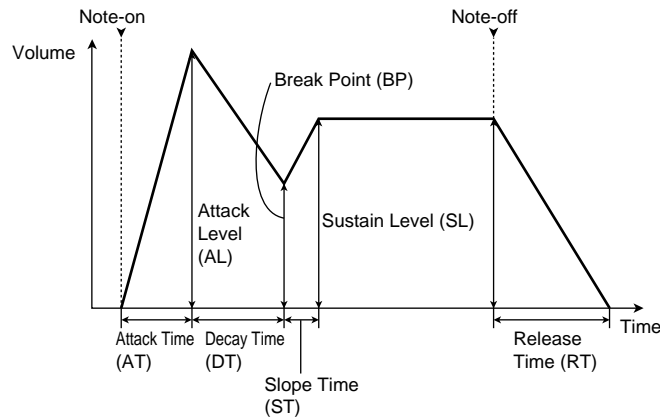

The following diagram shows the VDA EG of Program A01: X Piano.

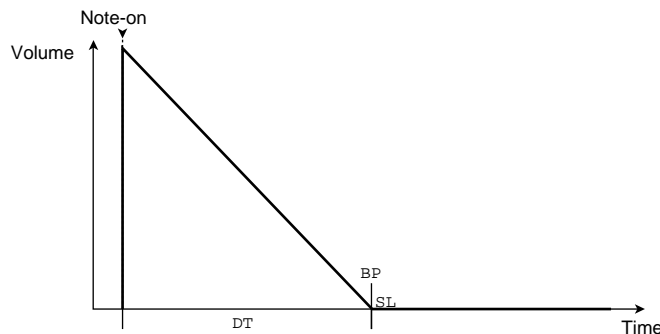

You can set the decay time using the DT (Decay Time) parameter for Program A01: X Piano. If you raise the SL (Sustain Level) from 00 (which is often used for piano sound Programs), the sound will remain at a certain level as long as you are pressing and holding down the key.

After checking the sound, reset the parameters to the default settings of the VDA1 EG as follows: AT=00, AL=99, DT=93, BP=00, ST=99, SL=00, and RT=36.

Adjusting the Release

The release part of a sound that you hear after you release the key (Note-off) will be adjusted by the RT (Release Time) parameter on page 5C VDA1 EG.

The default release time setting for Program A01: X Piano is set to 36. Change this value and listen to the sound. With a lower value, the sound will decay quickly after you release a key; with a higher value, the release will take longer.

- If you set this parameter too high, the sound will continue for a very long time. In this case, go to another mode and select Program Edit mode again.

The SL (Sustain Level) setting of the VDA EG for the current Program is set to 00. This means the sound will decay regardless of the RT setting if you continue playing the keyboard. However, if you release the keys during the DT part, you will hear the release sound defined by the RT setting.

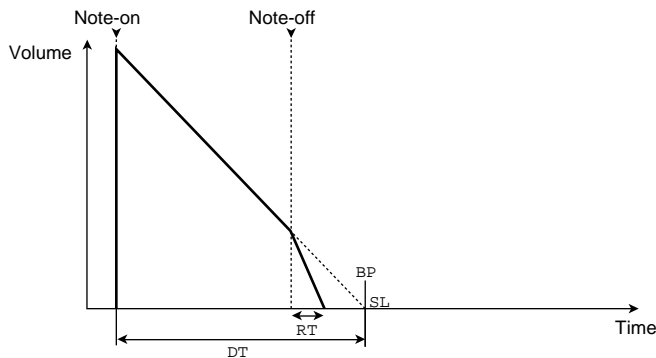

Adjusting the Tonal Brightness

You can use the VDF to adjust the tonal brightness. This technique is very useful when you want to change the nuances of a tone, or when you have noticed that a certain Program “sticks out” too much or is too quiet while you are playing multiple Programs in Combination Play mode or Multi mode, and you wish to correct this problem. Adjusting tonal brightness will allow you to layer multiple Programs evenly and to bring the ensemble together.

For example, let’s adjust the brightness of Program A71: Super BX-3. Select this Program in Program Play mode, and enter Program Edit mode.

Press the [PAGE+] or [PAGE-] button to display 3A VDF 1. Changing the Fc (cutoff frequency) will change brightness. Low Fc values makes the sound darker, while higher values make it brighter.

The Fc (cutoff frequency) sets the frequency above which frequency components will be filtered. Therefore, low Fc values cause more frequency components to be filtered, resulting in a darker sound. High Fc values cause less frequency components to be filtered, resulting in a brighter sound.

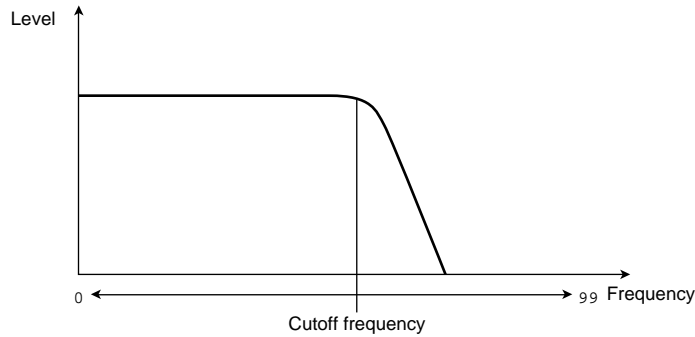

The VDF EG allows you to control brightness. The EGInt (EG Intensity) parameter on 3A VDF 1 allows you to determine how much the VDF EG will change brightness. The VDF EG does not affect the sound when the EGInt parameter is set to 00. You can check the effect of the VDF EG by changing the EGInt value. (If the Fc value is very high, you may not notice changes in tonal color produced by the VDF EG.)

Like the VDA EG, the VDF EG allows you to control how the tone of a Multisound changes over time after a note-on message is received. You can increase or decrease the level based on the current Fc (cutoff frequency) setting of 00.

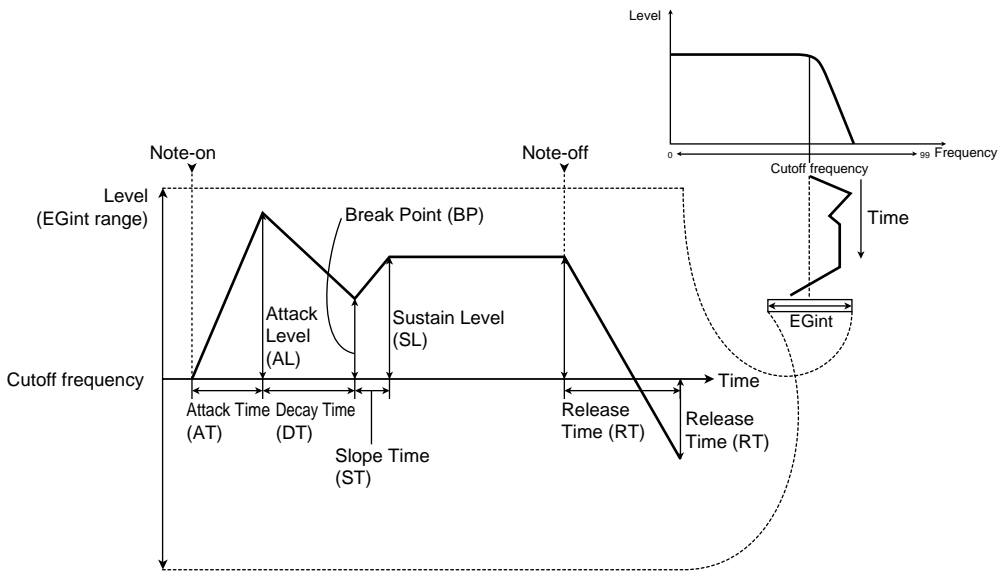

Set the 3A Fc parameter to 00 and EGInt parameter to 99, and change the parameter values (3B–3D VDF1 EG) to see how the tonal brightness changes over time.

<<VDF EG and VDA EG>>

Changes in the volume level (VDA EG) can affect the tonal color adjusted by the VDF EG. For example, a difference in attack time for tonal color and volume may give a significant variation in tonal nuance. If the attack time of VDF EG is faster, the sound becomes relatively quiet (like a strings sound); if the attack time of VDA EG volume is faster, the sound has a unique attack sound (like a brass instrument). To edit VDF EG and VDA EG, adjust them while keeping in mind how they change the sound over time.

Editing a Multisound (Basic Waveform)

Multisounds are the basic sound waveform (PCM waveform) used in Programs. The X5DR contains 430 Multisounds, including instrumental sounds such as piano and guitar, rhythm sounds such as drums and percussion, and synth sounds. Changes in Multisounds are obvious in any Program. In this tutorial, we will use Program A01: X Piano for Multisound edit.

Select Program A01: X Piano in Program Play mode, and press the [EDIT] button to enter Program Edit mode. Press the [PAGE+] or [PAGE-] button to display the 1A OSC1 SOUND screen.

This screen shows the number and name of the Multisound. Use the [▲] and [▼] buttons to change the Multisound. Then listen to the sound.

The other parameters (such as the VDF and VDA EG) are all set for the piano sound. Therefore, changing only the Multisound may produce an unnatural sound. (For example, the sound may still have a decay typical to the piano even if you select a brass instrument or organ sound for a Multisound.)

However, editing these parameters according to the selected Multisound will create a completely new sound.

<<How to make the best use of Multisounds>>

The X5DR has various built-in Multisounds with names. However, try to use them freely, without being restricted by the names. The X5DR offers very interesting synth sound waveforms in the latter half of the 430 Multisounds. You can also play drum or percussion Multisounds in a chromatic scale. Selecting a Multisound is a very important part of determining tonal character. It might be a good idea to first select a Multisound, then adjust other parameters based on the selected Multisound.

Adjusting Modulation

Vibrato (pitch modulation) and wah (VDF Cutoff modulation) are important effects that add expression to your performance. Let's change the depth, rate, and type of modulation.

Select Program A47: Woodwinds in Program Play mode, and press the [EDIT] button to enter Program Edit mode. Press the [PAGE+] or [PAGE-] button to display the 12A PITCH 1 MG screen.

Raise the Int (Intensity) value of 12A PITCH 1 MG. As you raise the value from a default setting of 12, you will notice that the vibrato effect becomes obvious even you are just playing the MIDI keyboard. The depth of vibrato is set by this parameter. Raise the Int parameter value, then change the Freq (frequency) value. The Freq parameter is used to set the rate of vibrato. A higher frequency value will make the vibrato faster. Now, move the cursor to the field that shows "TRI" as a default value for the waveform, and change this option. This parameter controls the vibrato waveform (the manner in which the pitch changes). (See page 94.)

- A47: Woodwinds is a Double mode Program. Adjust the vibrato of Oscillator 2 using page 13A PITCH 2 MG.

The Wah effect (VDF Cutoff modulation) is set by 14A VDF MG (Set 14B Oscillator Select to any value other than OFF.). As with the 12A PITCH 1 MG, change the waveform, Freq, and Int to determine the resultant effects.

- You can also set the delay time (the time taken until the vibrato or wah effect starts) and the manner in which you control the modulation: via the keyboard, After Touch, Controller #1 or #2. Refer to page 94–98 for details.

Adjusting the Panpot

You can adjust the panpot setting (the position of the stereo image) when the stereo sound is output through the L/MONO and R connectors. Change the Pan (panpot) parameter on 1C OSC1 and check to see how the position of the stereo image has shifted (see page 81). Pan settings range between A and B, with CNT as the center. With the Pan parameter set to OFF, no sound will be output to A or B. (Select OFF when you are using only outputs C and D.)

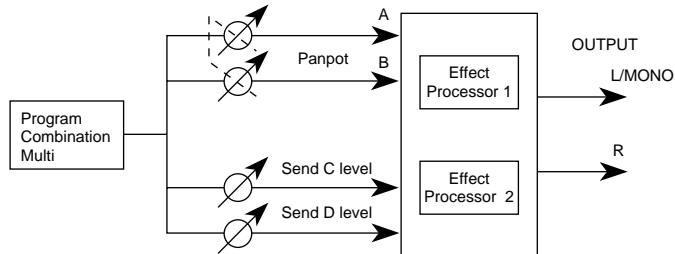

About Double Mode

Just as you can layer Programs in a Combination, you can layer Multisounds in a Program. In Program Edit mode, set the 0A OSC Mode parameter on the LCD screen to DOUBLE. Double mode allows you to combine different Multisounds in a Program (see page 79), or to produce a thick and rich sound. Most of the X5DR Programs are in fact Double mode Programs.

It is a good idea to consider the type of Multisounds that comprise a Double mode Program when you are editing sounds in Program Edit mode.

- Remember that the X5DR polyphony is reduced from 64 to 32 notes for Double mode Programs, since each Multisound uses one voice.

<<Double mode and detune>>

Double mode allows you to combine two sounds. Furthermore, on 2E OSC2 Detune, you can slightly shift the pitch of OSC1 against that of OSC2. Shifting the pitch of two oscillators thickens the sound. This is more effective and obvious for Programs that use the same type of Multisounds for OSC1 and OSC2.

<<Key velocity and expression>>

To add expression to your performance, set the velocity so that tonal color and volume level change according to the key velocity. Use the VDA Velocity Sense parameter to set the velocity for the volume level. If you are layering two sounds in Double mode, setting the VDA Velocity Sense parameter of one OSC to a negative value “-” will give you a velocity crossfade effect (a effect that changes the balance between two sounds according to key velocity).

<<Keyboard tracking>>

Keyboard tracking is a function that determines how different areas of the keyboard affect tonal color and volume level. Usually, it is used to adjust the balance between tonal color and volume level when you are playing in a wide pitch range. To layer two sounds in Double mode, set the Key parameter of OSC 1 and 2 to the same value, and set the KBD Track Intensity of OSC 1 and 2 to “+” and “-”, and you will obtain a positional crossfade effect (an effect that changes the balance between two sounds according to the key position on the keyboard).

<<Double mode and Combinations>>

There are two methods for layering multiple sounds: (1) using a Double mode Program; and (2) layering multiple Single mode Programs in Combination Edit mode. The resultant sounds are the same, but the method you choose should depend on how the sound will be used. For example, if you wish to layer completely different types of Programs—such as piano and strings—it is better

to layer the Programs in Combinations. If the piano and strings sounds are different Programs, this gives you the flexibility to combine the piano and brass sounds, or the strings and brass sounds, allowing you to make the best use of the Programs. On the other hand, layering two Multisounds in Double mode is most suitable for combining two different sounds to build one Program. For example, if you wish to layer the attack and sustain parts of the strings sound, handling these two sounds in a Double mode Program is more convenient for sophisticated sound creation.

Some Hints for Editing Programs

There are many parameters in Program Edit mode, so you can create your original sound with ease. It may be difficult to understand all the parameters' functions, but editing various sounds repeatedly will help you learn the function and effect of each parameter.

You may often modify the preset Programs or existing Programs you have created before. In any case, the key approach for a creative sound-making process is to be able to decide which parameters you need to edit in order to obtain a desired sound.

As explained in "Sound Structure" on page 36, the X5DR Programs consist of three simple main elements. You should be able to obtain your desired sound easily based on the principle that OSC is for pitch, VDF is for tone, and VDA is for volume. You should also associate cyclical changes with MG, and changes over time with EG.

Depending on the value of one parameter, the other parameters may not be effective. For example, if you set the EGint (EG Intensity: VDF EG sensitivity adjustment) to 00, changing the parameters of the VDF EG will not modify the sound. You can save time and energy and edit most efficiently by first understanding the structure of the Program.

Editing Effects

Now let's edit the effects, which are a prominent feature of the X5DR. An effects processor allows you to add various effects and acoustic ambience to a sound.

You can use effects for Programs, Combinations, and Multis. This section explains the editing of effects in a Program. The effect parameters are common among all these modes, although they appear on different pages of the LCD screen.

1 Select a Program in Program Play mode.

Program A01: X Piano is a suitable Program for assessing how effects modify a sound. Some Programs may not allow you to determine how effects modify a sound, depending on the placement of the effect. See page 117 for the effect placement.

2 Press the [EDIT] button to enter Program Edit mode.

3 Press the [PAGE+] or [PAGE-] button to display 10A EFFECT 1.

4 Move the cursor to EFFECT 1=, and use the [▲] and [▼] buttons to change the effect type.

- The effect placement of Program A01: X Piano is set to Serial. Let's listen to how a different effect type for Effect 1 will alter the sound. If you have selected a Program for which the effect placement is set to any value other than Serial, change it to Serial on 14A PLACEMENT. Set Effect 2 on page 12A EFFECT2 to "00 No Effect".
- The DRY:EFF parameter allows you to adjust the effect degree of Effect 1 on 10B. (The page varies depending on the effect type selected on 10A EFFECT 1.) Increasing the EFF portion of the effect balance will make it easier to understand the impact of the effect.
- You can check the effect of dynamic modulation by the modulation wheel when the 10C Src (Dynamic Modulation Control Source) parameter is set to JS(+Y) and the value of the I (Dynamic Modulation Intensity) parameter is raised (see page 116). Send Controller #1 (which corresponds to the joystick +Y and modulation wheel) to listen to the effect.

Effect Types

The X5DR features two built-in digital multi-effects processors. Selecting a different type of effect will create a different and versatile sound.

The effect types are divided into two main categories: the effects that create reverberation (acoustic ambience), and effects that will process sounds. Using the two built-in effect processors and the effect types that produce two effects simultaneously will allow you to both create acoustic ambience and process sounds.

This section explains the main effect types for the X5DR's 47 built-in effects. Other effect types are variations or combinations of these main effect types.

- Refer to the section starting from page 120 for information about the parameter functions and how to control each type of effect.

1) Reverberation

Sounds exhibit a wide variety of reverberations, depending on the size of the surrounding acoustic environment and the materials used in nearby walls, ceilings, etc. Reverb is used to simulate these naturally-occurring reverberations for dry sounds (dry sound refers to the original sound without any effect). The X5DR features nine types of reverb effects—from 1: Hall through 9: Spring.

Imagine listening to live music in a hall. After hearing the dry sound directly from the source, you will hear a number of sounds reflected from the walls, ceiling, floor, and any other objects with hard surfaces. These are called "early reflections". The mixture of the dry sound and reflected sounds creates spatial effects. The time between the dry sound and these early reflections is called the pre-delay time, and it will vary depending on the size of the hall, the material used in the walls,

ceiling, and other objects in the room, and the decay time of the reflections. Utilizing the effect types 1: Hall through 9: Spring allows you to simulate a variety of acoustic ambiences, and you can edit these effects in detail using the parameters provided.

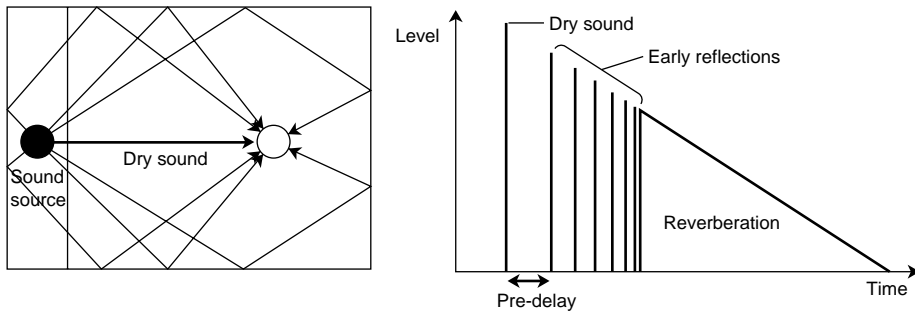

2) Early reflection

This effect produces only the early reflections of a reverb effect. Using these early reflections, you can add weight or spatial effects to a sound, such as reverberation. Without the reverberation, you can achieve a clean effect sound.

3) Delay

Delay is like an echo in a canyon, consisting of a series of distinct repeats at regular intervals. Subsequent repeats can be added by feeding the signal back into the effect. The X5DR contains six types of stereo delay, from 13: StereoDly through 18: M. TapDly. Short delay time settings will change the position of the stereo image (depth). Longer delay time settings are useful for soloing. It can also be interesting to set a much longer delay time than that which would match the song's tempo.

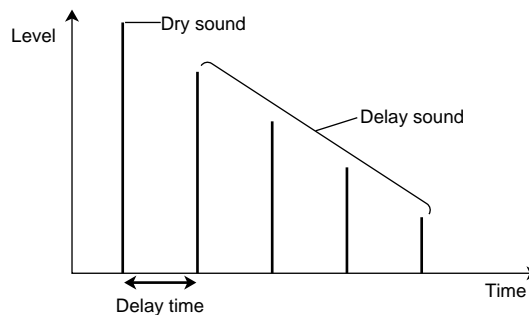

4) Chorus

Chorus effect are an effective way to add spaciousness and thickness to any type of sound. The X5DR contains six chorus effects, from 10: Chorus 1 to 24: Symp.Ens. These are ideally suited for use with electric pianos, strings, guitars, and so on. In an ensemble, pitch variations between instruments create a rich, slightly warbling sound. Essentially, this gives the impression that a number of musicians are playing together. The chorus effect simulates this. In stereo performance, the stereo image is widened, thus creating a magnificent spatial ambience.

5) Flanger

These effects add unique characteristics to a sound. The X5DR contains three flanger effects, from 25: Flanger 1 through 25: XOvrFlng. Although similar to chorus, a flanger uses a shorter delay time and feeds some of the output signal back into the effect, creating a strong swell. Flangers work very well on sounds that contain a lot of harmonics, as well as on distorted guitar sounds.

6) Exciter

The exciter effect (28: Exciter) adds new harmonics to a sound, thus producing a subjective increase in clarity and definition, which helps to make a sound's individual character stand out.

7) Enhancer

The enhancer (29: Enhancer) makes the sound clearer and more defined, giving the sound more presence and bringing it up front in the mix.

8) Distortion

The X5DR contains two kinds of distortion effects, 30: Dist and 31: OverDrv. The distortion effect simulates the distortion produced when amplifier circuits are overdriven with excessive signal and gain levels. You can use these effects not only with guitar sounds but also with rock organ sounds.

9) Phaser

The phaser effect shifts a sound's phase. The X5DR contains two phaser effects, 32: Phaser 1 and 33: Phaser 2. They are similar to the chorus and flanger effects in that both use modulation, but the manner in which the tonal quality changes is different. They are effective with electric piano, guitars, and synth sounds with a reasonable sustain.

10) Rotary speaker

This effect (34: Rot.Spk) simulates the rotating speaker effect used in some organs. It is ideal for use with organ sounds, but it will also create a unique effect with other sounds.

11) Tremolo

The tremolo effect produces regular changes in volume level. The X5DR contains two tremolo effects, 35: Auto Pan and 36: Tremolo. They create a stereo type tremolo effect suitable for use on electric pianos and vibraphones.

12) Parametric equalizer

Effect 37: Para.EQ is a three-band parametric equalizer. You can set the cutoff frequency for the low and high band filters, and center frequency and bandwidth for the mid-band filter, which allows you to modify the tonal quality of a sound in detail. This effect can be used to simulate the frequency responses unique to an instrument (resonance of guitars and other string instruments), as well as to correct the tonal quality.

Effects and Sound Level

You can use the effects in Programs, Combinations, and Multi mode setup. However, the effects are set for each sound—that is, the effects are set for each Program. Combinations use the effects that are set for each Combination (and not the effects that are set for the Programs assigned to the Timbres). Multi mode uses the effects that are set for the entire Multi mode (and not the effects set for the Programs in the tracks). Remember this when you use Programs that utilize their own effect settings in Combination Play mode and Multi mode.

- You can make a copy of the effect settings for Programs using the Copy Effect function (see page 119).

<<Effect Placement>>

The effect placement determines how the signal is routed from the OSC 1/2 output (that is, the input to the effects) to the Effects 1/2. Using this setting allows you to process various sounds. Routing the Pan A, B and Send C, D in various ways will allow you to build a complicated effect structure. Utilize the effect placement diagram for the effect settings (page 117).

<<Dynamic Modulation>>

Dynamic modulation is a powerful function that allows you to control the effect balance and parameters during performance. You can adjust the effects or obtain effects that could not be achieved through usual external effect units, using Control Change messages such as modulation, or VDA EG. The type of parameter you can control via dynamic modulation varies depending on the effect type. Refer to page 145 for details.

Editing Combinations

This section offers a tutorial for editing Combinations. If you wish to save an edited Combination, you must perform a Combination Write operation.)

- If you do not save the edited Combination, the existing Combination will not change. (Refer to page 106 for information on the Combination Write operation.)

Layering Multiple Programs

You can create a new sound by combining multiple Programs in a Combination. In the following example, we will edit Combination 58: Moon Stone.

Note: If Combination 58 is not Moon Stone, Preset b Combination may have been loaded. For this tutorial, first load Preset a Combinations to edit. (See page 20, 156.)

- 1 Select Combination 58: Moon Stone in Combination Play mode.**
- 2 Press the [EDIT] button to enter Combination Edit mode.**
Before editing a Combination in Combination Edit mode, you must select a Combination in Combination Play mode.
- 3 Press the [PAGE+] or [PAGE-] button to display the appropriate page on the LCD screen.**
 - You do not have to switch pages; you can change Programs in 0A PROGRAM 1-4 (the page for Program Timbres 1-4).
- 4 Press the [↵] and [Ⓜ] cursor buttons to select a Timbre.**
- 5 Use the [▲] and [▼] buttons to select a Program.**

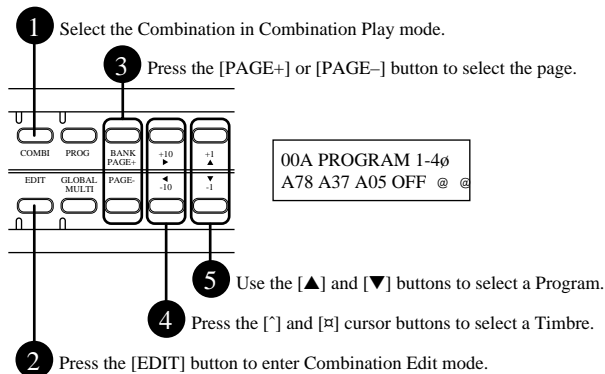

Change the Programs assigned to Timbres 1-3 and listen to how the sound changes. Combination 58: Moon Stone consists of different Programs assigned to three Timbres as illustrated below. (Timbres 4-8 are not used.)

Timbre 3	A05 : GlockBells
Timbre 2	A37 : FreshWaves
Timbre 1	A78 : Swell Pad

You can select Programs to assign to Timbres 1-8 in the 0A and 0B PROGRAM pages. If you select OFF, that Timbre will not be used.

Adjusting the Volume

You can adjust the volume level of each Timbre using the parameters on pages 1A and 1B LEVEL. The Volume balance among Timbres can affect the sound of the Combination.

These are the default settings for each Timbre’s volume level for Combination 58: Moon Stone: 106 for A78: Swell pad; 106 for A37: FreshWaves; and 067 for A05: GlockBells. Changing the level allows you to adjust the pad-type and bell-type sound balance to create a new sound.

Adjusting the Key Window

You can set the note range for each Timbre in a Combination such that each Timbre will sound only within its specified range on the keyboard. This range is called the Key Window.

The Key Window is specified by the upper and lower limits of the note range: 3A and 3B KW TOP (Key Window Top) and 3C and 3D KW BTM (Key Window Bottom). The default setting is C–1 to G9 (the entire keyboard range). However, you can specify a certain range or divide the keyboard range in two for each Timbre for use in Split mode.

For example, change the KW BTM of Timbre 1 to C4 and KW TOP of Timbre 3 to B3, and you can play bell-type Programs A37: FreshWaves and A05: GlockBells in the low range, and pad-type sound Program A78: Swell Pad in the high range.

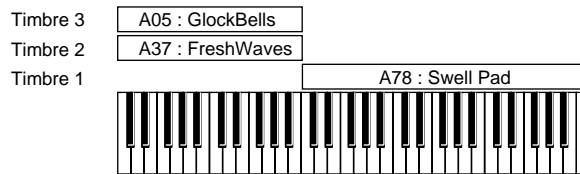

Adjusting the Velocity Window

You can also specify the note range within which a Timbre will respond based on the force with which you strike the keys (velocity range). This velocity range is called the Velocity Window.

The Velocity Window is specified by 4A, 4B VW TOP (Velocity Window Top) and 4C, 4D VW BTM (Velocity Window Bottom), which represent the upper and lower velocity limits. Velocity (how hard you strike the keys) is expressed by the numbers 001–127. The default velocity range is 001–127 (in which Timbres respond to any velocity). By changing these parameters, you can set the Timbres in such a way that different Timbres will respond to different key touches.

For example, first reset the Key Window parameters to the default setting. Then change Timbre 1 VW BTM to 64, and VW TOP of Timbres 2 and 3 also to 63. When you play the keyboard softly, only the bell-type Programs A37: FreshWaves and A05: GlockBells will sound; when you play the keyboard hard, the pad-type Program A78: Swell Pad will sound.

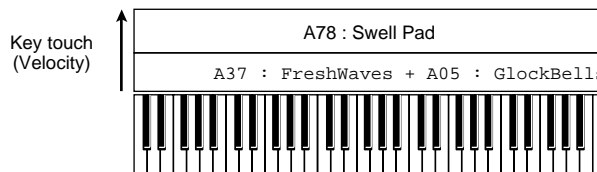

More About Combination Edit

So far we have learned how to switch Programs, adjust the volume, and set the Key Window and Velocity Window. These represent a basic use of the Combination edit functions. You can edit Combinations further by doing such things as changing the pitch for each Timbre (transposition, detune - page 103), and adjusting the pan (see page 105) and send (see page 105) settings. You may also set a different MIDI channel for each Timbre to play via multiple MIDI Channels (see page 102), or set whether or not the X5DR ignores certain MIDI data (see page 104).

Editing a Drum Kit

A Drum Kit is a set of drum sounds, each of which is assigned to a key on the keyboard. You can play a Drum Kit instead of Multisounds by selecting DRUMS for Programs. The Drum sounds on the X5DR are arranged into 8 Drum Kits in ROM and 2 Drum Kits in RAM. You can edit RAM kits in Global mode. This section explains how to edit RAM kits.

Preparing to Play a Drum Kit

To play a Drum Kit, you need to select DRUMS for 0A OSC Mode in Program Edit mode. In this mode, you can select a Drum Kit instead of Multisounds for 1A OSC1 SOUND.

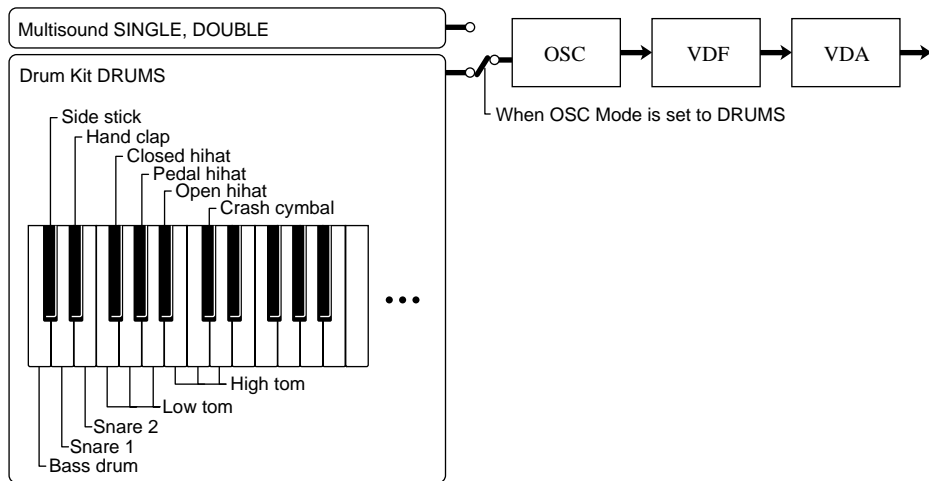

Editing a Drum Kit

Let's edit Drum Kit A19: [ComboKit], which uses one of the RAM Drum Kits (000:Drum Kit 1). If you wish to edit a ROM Drum Kit, first copy the ROM Drum Kit to one of the RAM Drum Kits using 8A Copy Drum Kit in Global mode. (See page 56)

Note: Unlike editing Programs or Combinations, editing Drum Kits will automatically change the Drum Kit settings without having to carry out the save operation. Therefore, be careful when you are creating an original Drum Kit. If you wish to restore the preset settings (Preset A or B), do so on page 5A Preset Data Load in Global mode (see page 20, 156).

<< Tips on drum editing >>

Before starting to edit a Drum Kit, we recommend that you select a Program in Program Play mode, then go to Global mode to edit it. This is because the parameter settings of the Program selected in Program Play mode are used to produce sound, and depending on the VDF, VDA, or EG settings of typical Program sounds—such as piano or strings—the drum sounds may change. For example, if a Program uses a long attack time for the VDA EG, you will not recognize the sharp attack typical of a drum sound. If you wish to reproduce the edited Drum Kit sound without any changes, first select the Program that was originally created for use with that Drum Kit. Also, it should be noted that editing a Drum Kit will change other Program sounds that use the same Drum Kit. For example, editing Drum Kit 1 will change all Program sounds that use Drum Kit 1 (the Programs for which 000: Drum Kit 1 is selected for OSC1 SOUND).

1 Select A19: [ComboKit] in Program Play mode.

- When you edit a Drum Kit in Global mode, the currently-selected Program settings (DRUMS for OSC Mode) are used to produce the sound. Make sure you select a Program that contains a Drum Kit you wish to edit.

2 Press the [GLOBAL] button to enter Global mode.

3 Press the [PAGE+] or [PAGE-] button to display 6A Drum Kit 1. (This is the edit page for Drum Kit 1.)

4 Use the [↵] and [Ⓜ] cursor buttons to select a parameter.

5 Use the [▲] and [▼] buttons to change a parameter value.

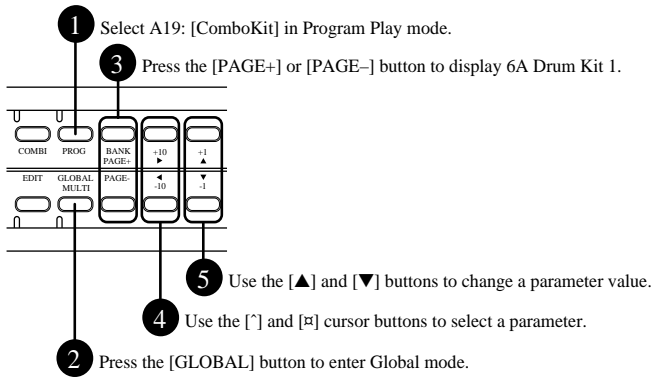

Each Drum Kit contains 60 indexes (#00–#59), with one drum sound assigned to each index. Level, tuning, and decay parameters can be set individually for each index in a kit. Each index is similar to a container that accommodates a drum sound; it appears on the LCD screen as follows:

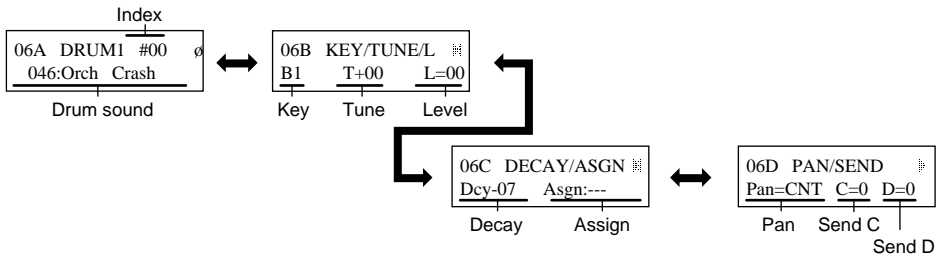

Now, we will start editing Drum Kit 1, which is used in A19: [ComboKit].

First, to select an index to edit, move the cursor to Index on page 6A DRUM 1, and select #06, which is an index for the snare assigned to the F2 key (the lowest F on the keyboard).

The parameters from Drum sound to Send shown above are used only for the index selected here. If you wish to edit an index for another key, go back to page 6A to select the desired index.

Changing Drum Sounds

As a default setting, drum sound 018: PicloSnare (the high-pitched sound of a thin-body snare) is selected. Try to select various drum sounds and listen to them. Selecting --: No Assign allows you to set an index that does not produce sound. For this example, select a powerful snare sound 022: Ambi.Snare.

Changing the Assigned Key

Page 6B KEY/TUNE/L allows you to change the key assignment. Changing the default setting F2 allows you to change the key to which an index is assigned. You can select only the keys from A#1 and lower or A6 and higher. This is because the other keys have already been assigned to indexes and you cannot assign multiple indexes to one key. (The keys not shown on the screen are already assigned indexes.) If you wish to assign an index to a particular key, edit the index of that key or change the key of the index. Avoid assigning indexes to the same key.

Altering the Tuning

You can change the pitch of drum sounds. The default value is +006, and the value can range from -120 to +120 (1=10 cents). Altering the tuning will significantly change the nuances of a drum sound. Raising or lowering the pitch radically can create special effects. Set this to about +30 to obtain a clear sound, and to about -10 to obtain a powerful sound.

Changing the Level

The Level is adjusted for each index. You can adjust the entire volume level using the OSC Level parameter in Program Edit mode or the VOLUME control on the front panel, but the volume level balance of the index's drum sound in a Drum Kit is adjusted by this parameter. The default value +51 may produce a rather loud sound for the index we are now editing. Set the parameter to about +10.

Changing the Decay

Now, go to 6C DECAY/ASGN. You can adjust the decay time (how long a sound sustains) using the decay parameter. A higher value will produce a longer sustain, based on a value of 0. Specifying a negative value will make the sound shorter. For example, adjusting the decay time is very useful for a cymbal sound. Try a value of -25 to create a tight sound.

About the other parameters

The ASGN (Exclusive Assign) allows you to set an assigned group of indexes such that they will cutoff each other's sound. For example, the open hihat sound and the closed hihat sound should not be triggered simultaneously. This parameter can be used for a whistle, guiro, shaker, or triangle.

Page 6D PAN/SEND allows you to control how the sound is output for each index. The Pan parameter determines the output balance between Output A and B, and the C and D parameters determine the output level to C and D. The panpot setting specified in Global mode is effective in Program Play mode, and each index uses its own panpot setting. If you set the panpot parameter to PRG in Combination Play mode or Multi mode, each index uses its own panpot setting. (See page 105, 109.)

Playing a Chromatic Scale Using a Single Drum Sound

As described earlier, you can assign the drum sounds in a Drum Kit to different keys. In a similar way, you can also play a chromatic scale using a single drum sound. The example described below is a bell sound.

Since the indexes of Drum Kit 1 are already assigned to the entire keyboard as a default setting, first you need to set drum sounds of indexes #50-#59 to --: No assign, and set the key of index #59 to any key other than C7. At this point, no index should be assigned to the highest octave keys on the keyboard (no sound will be produced within this range.) Set Index #40 to 137: TubulBell2, and

set the key to C7. Now you should be able to play the bell sound in a chromatic scale within the highest octave (Note numbers 84–95). The sound may become more interesting if you tune it a little lower and set the decay to –15.

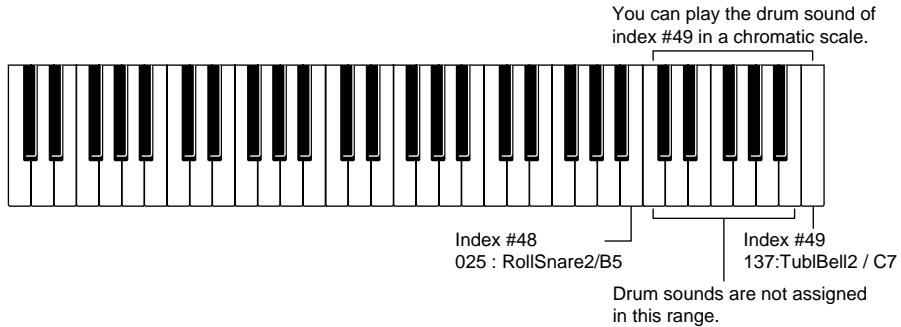

Creating a Drum Program Using a ROM Drum Kit

Follow the procedure below to create a Drum Program when you edit the ROM Drum Kits used in Programs G129–136.

- 1 **Copy a Program to Bank A.** You cannot write a Program in Bank G. Select a Program in Program Play mode, and write the Program using the 16A page in Program Edit mode.
- 2 **Check and confirm the ROM Drum Kit being used.** Check the number of the ROM Drum Kit being used in the copied Program using the 1A page in Program Edit mode.
- 3 **Copy the ROM Drum Kit being used to a RAM Drum Kit.** Use the 8A page in Global mode to copy the ROM Drum Kit that you have just checked in Step 2 onto RAM Drum Kit 1 or 2. When the copy function is carried out, the sound of the Program that previously used the RAM Drum Kit will change.
- 4 **Edit the copied RAM Drum Kit.** Edit the RAM Drum Kit in Global mode. Refer to “Editing a Drum Kit” on page 53 for the editing procedure.
- 5 **Change the Drum Kit of the copied Program to the edited RAM Drum Kit.** Go back to Program Edit mode, and change the Drum Kit selection on page 1A. Select the destination RAM Drum Kit 1 or 2 in Step 3, and perform 16A Write function.

<<Making Drum Sounds>>

Drum Kits are regarded as a sound source like a Multisound in Programs, which allows you to fine-tune the sound using the parameters available in Program Edit mode. For example, it is possible to adjust tonal brightness using the VDF, or to adjust changes in tonal color and level using the VDF EG and VDA EG respectively, to obtain special effect sounds. You can utilize effects advantageously by setting the panpot for each index, or adjusting the send C/D levels. For example, you may apply reverberation to only the snare sound, or apply the flanger effect to only the hihat sound.

4. Application Guide

This chapter explains several applications and offers helpful tips on performance, editing, and troubleshooting on the X5DR. See the reference pages for detailed explanations of functions and parameters.

General Troubleshooting

Nothing is displayed on the LCD when the power switch is turned on.

Check that the AC adapter is connected correctly. (See page 1, 9.)

The X5DR does not produce any sound.

Check the connections to your audio system, headphones, etc. (See page 1, 9.)

Ensure that the connected powered monitor or stereo amplifier is switched on, and that the volume level is raised.

Ensure that the X5DR VOLUME is sufficiently raised. (See page 3, 15)

Ensure that the connected MIDI keyboard, computer, or sequencer is switched on, and that the MIDI cables or computer interface cables are connected correctly. (See page 1, 9–13.)

When you are using a computer interface cable: Make sure that the PC I/F CLK parameter in Global mode is set correctly. (See page 14.)

When you are using a MIDI cable: Make sure that the MIDI Driver install matches the MIDI port setting. (See page 174–179.)

In Program Play mode: Make sure that the MIDI receive channel of the MIDI keyboard, computer, or sequencer matches the Global MIDI Channel in Global mode. (See page 5, 151.)

In Combination Play mode: Make sure that the MIDI receive channel of the MIDI keyboard, computer, or sequencer matches the MIDI channel of each Timbre. (See page 102.)

In Combination Play mode or Multi mode: Make sure that you play keys within the note range or velocity range specified by the Key Window and Velocity Window. (See page 102, 103, 112.)

The sound does not stop.

If the HOLD parameter is on, sound will not stop even when the X5DR receives a Note OFF message. Make sure that the HOLD parameter is not set to on. (See page 79.)

Sound also continues if you remove the MIDI cable or change the connection while the sound is being produced. (The Note Off message is ignored.) In this case, change the mode to stop the sound. If you are using a device that transmits Active Sensing, the sound will be stopped automatically whenever the MIDI connection is interrupted.

The X5DR does not respond to incoming MIDI data.

Make sure that all MIDI cables are connected correctly and that the settings on the transmission device are correct. (See page 1, 9–13.)

If the X5DR does not respond to certain messages such as Pitch Bend, Modulation, etc., the MIDI data may have been filtered out. Check the MIDI filter parameter in Global mode. (See page 151.) You can set the MIDI filter for each Timbre in Combinations and for each Track in Multi mode. (See page 104, 111.)

You cannot change Programs or Combinations.

Program Change messages are used to change Programs and Combinations. Make sure that the messages are sent from the transmission device.

In Program Play mode: Send Program Change messages on the Global MIDI Channel. If you wish to change the Bank, send a Bank Select message. (See page 22.) Also, check the MIDI Filter setting in Global mode. (See page 152.)

In Combination mode: To change the Combinations, send Program Change messages on the Global MIDI Channel. If you send Program Change messages or Bank Select messages on each Timbre's MIDI channel, the Program for the corresponding Timbre will be changed. (See page 151, 102.) Also, check the MIDI Filter setting in Global mode and in the Combinations. (See page 152, 111.)

In Multi mode: Send Program Change or Bank Select messages on each Track's MIDI channel. Also, check the MIDI Filter setting in Global mode and Multi mode. (See page 152, 111.)

The wrong sounds are produced.

You need to write the edited parameter values to memory to store the Program edited in Program Edit mode or the Combination edited in Combination Edit mode. If you select another Program or Combination without saving the edited data, the edit will be lost. (See page 39, 99, 106.) You do not need to carry out the Write function to store the edited Drum Kits.

When you are editing a Drum Kit, the parameter settings of the Program selected in Program Play mode are used to produce the sound. If you use a Drum Kit in a Program that is different from the one selected when editing, a different sound will be produced. (See page 53.) Make sure that you select the Program that was selected when you edited the Drum Kit.

Combinations remember the Program for each Timbre as a Program number, not as a sound. If you edit the Program used for the Combination or if you select a different Program for the Combination, the sound of the Combination will be also changed.

You cannot write a Program or Combination.

Check the Memory Protect setting in Global mode (see page 153.). You cannot write a Program or Combination if the Memory Protect parameter is set to ON.

You cannot select the parameter pages for OSC2 (e.g., VDF2 and VDA 2).

If the screen does not display the pages for OSC2 in Program Edit mode, check to see whether the Oscillator mode is set to DOUBLE. (See page 79.) If this mode is set to SINGLE or DRUMS, you cannot select the pages for OSC2.

The X5DR does not play the specified drum sounds.

If an incorrect drum sound is produced when the correct note messages are sent, the Transpose parameter may have been set to a number other than 0. Check whether TRANSPOSE in Global mode is set to +00. (See page 147.) Also, check to make sure that the octave setting is 8'. (See page 80.)

When you are using a computer or sequencer, check that the Transpose parameter on the transmission device is set to 0. Usually, the sequencer or sequencer software automatically sets the Transpose on MIDI channel 10 to off. However, double-check this parameter if you have sent edit commands to transpose, or if you are playing on tracks other than Track 10 in Multi mode.

The X5DR does not play GM-compatible song data correctly.

Make sure that the song data is GM-compatible.

Make sure that the Multi mode settings have been initialized for GM. (See page 28.) You can restore the initial GM settings by sending a GM System On message to the X5DR in Multi mode or by using page 23A SET TO GM.

Make sure that the settings in Global mode have been made correctly for GM songs. (See page 18.)

If you are trying to play back a GM score that uses Bank Select messages, the wrong sound may be produced (that is, a Bank A Program may be selected). In this case, restore the initial GM settings, and set the computer or sequencer so that it will not send Bank Select messages, or set the MIDI filter parameter on the X5DR so that it will not receive Bank Select messages. (See page 18, 152.)

The X5DR doesn't transmit MIDI Exclusive messages.

If the X5DR doesn't transmit a MIDI Exclusive message for Program data transfer, storage, or editing, check the setting of 2B EXT OUT SEL in Global mode. (See page 14, 152.) Set this parameter to MIDI when the data is output from the MIDI OUT connector, and to PCIF when the data is output from the TO HOST connector.

If you are sending Exclusive data to transfer Program data using 4A MIDI DUMP in Global mode, the data will be sent to the destination specified on the page 4A (MIDI or PCIF), regardless of the 2B EXT OUT SEL setting.

Performance Applications

Tuning the X5DR to Other Musical Instruments

You should first tune the X5DR if you plan to jam with other musical instruments or play along with music from CDs or tapes.

Use page 0A MASTER TUNE in Global mode to tune up. The range of the parameter is -50 (427.47Hz) to +50 (452.89Hz). (See page 147)

Changing the Key Velocity Sensitivity

You can set the key velocity sensitivity according to your personal key touch on the MIDI keyboard. A velocity curve determines the relationship between key touch and changes in volume or tonal color.

Use the Vel parameter on page 0D CURVE in Global mode to select a velocity curve. The X5DR has 8 velocity curves.

Changing the Note Range

Use 0B TRANSPOSE in Global mode to change the note range. You can shift the range in semitones: +12 to move up one octave, and -12 to move down one octave. (See page 147.)

If you wish to transpose each Timbre in a Combination individually, use page 5A and 5B TRANS of page 103. If you want to transpose each track individually, use page *C Tra. (See page 110.)

Adjusting Effects while Playing

You can adjust some effects during performance. Set the EFFECT Dynamic Modulation parameter accordingly. (See page 116.)

Changing the Sequence of Programs or Combinations

To change the sequence of Programs or Combinations, use the Program Write function (see page 99) or the Combination Write function (see page 106) to write the Programs or Combinations in the desired order. At this time, the existing destination Programs or Combinations will be lost (overwritten). If you want to keep those Programs or Combinations, first copy them to different Program or Combination numbers.

You can also change the name of Programs and Combinations. (See page 99, 106.)

Combining Multiple Programs

In order to play multiple Programs simultaneously, or play different Programs in different note ranges or with different key velocities, assign the Programs to the Timbres in Combination Edit mode and set the Key Window or Velocity Window parameters. (See page 102, 103.)

You can also combine multiple Programs in Multi mode. When you play these on the MIDI keyboard, first set the MIDI Channel of the Tracks to the MIDI transmit channel of the MIDI keyboard. (See page 113.)

You can combine up to eight Programs for a Combination, and up to 16 Programs for Multi mode setups. The X5DR stores 100 Combinations in its memory, but it does not store Multi mode setups. Therefore, you may want to store the Multi setup data in a data filer or an equivalent storage device if you are using the same Multi mode setups repeatedly.

Changing the Controller Functions in Combinations

You may occasionally want to use different settings for a controller to play Combinations that consist of multiple Programs. For example, you may want the damper pedal to affect only the piano sound if you are playing the piano sound with your right hand and the bass sound with your left, or some similar arrangement. In this case, you can set the damper filter so that particular Timbres will ignore damper operation. Set 6B DAMPER in Combination Edit mode to D (DIS) for each Timbre that you want to ignore the damper effect. (See page 104.)

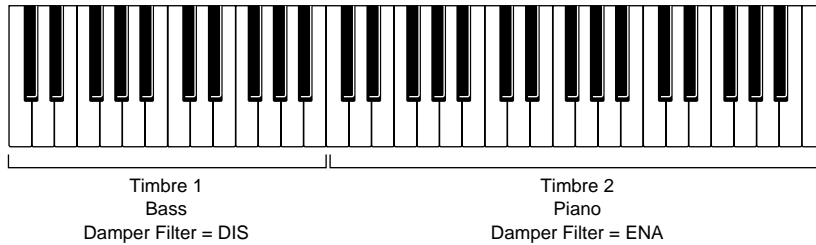

You can set the damper filter parameters for each Track in Multi mode. It is also possible to set whether or not each Timbre or Track accepts After Touch or Control Change messages.

Playing the Keyboard in Split Mode

(Playing Different Sounds With the Left and Right Hands)

If you wish to play different Programs in separate keyboard ranges, such as playing a bass sound with your left hand and a piano sound with your right, set up the Key Window of a Combination. (See page 102.) The Key Window allows you to set the note range on the keyboard for each Timbre. (See page 112.) You can also set the note range using the Key Window in Multi mode. If you wish to play Combinations or Multi mode setups in Split mode, first set the Timbre's or the Track's MIDI channel so that it will match the MIDI receive channel of the MIDI keyboard. (See page 102, 113.)

Selecting a Particular Sound Quickly

Remembering how the sounds in the X5DR are sequentially organized will help you select a desirable sound very quickly. For example, Bank G has 128 GM-compatible Programs and eight Programs that use the Drum Kits, which are each divided into groups that consist of eight sounds. Remembering the group in which a sound is located will help you select a Program very quickly. This is also helpful when comparing similar types of Program sounds.

It is very convenient to have Bank A Programs and Combinations that are divided into groups and sorted in a desirable order. The default Programs in Bank A have already been divided into groups based on the unit's digit. For example, *1 contains piano and organ sounds, and *9 contains drum and percussion sounds. You can create customized sequences and groups to facilitate operations.

Using a Different Scale

The X5DR has various scales in addition to Equal Temperament. You can also create your own scale on page 1A User Scale in Global mode. 1A Scale Type in Global mode is used to set up the main scale you usually use, and 1H Sub Scale is used to set up a sub scale. You can switch between the main scale and the sub scale by sending a MIDI Control Change message (Controller #4). In order to use two different scales by switching between the main and sub scales, first set a different scale on 1A Scale Type and 1H Sub Scale, and send Controller #4 from the MIDI keyboard, computer, or sequencer. A value of 0–63 will select the main scale, and a value of 64–127 will select the sub scale. You can switch between the main scale and the sub scale for each Timbre in Combination Play mode, and for each Track in Multi mode.

Editing Applications

Editing the Sounds

Adjust the parameters in Program Edit mode to edit a Program (see page 23, 38, 78). Adjust the parameters in Combination Edit mode to edit a Combination (see page 26, 51, 100). To edit Programs used for Combination Timbres, and Programs used for Tracks in a Multi setup, first select the Program you wish to edit in Program Play mode, then enter Program Edit mode.

Copying Effect Settings

You can copy effect settings from Programs or Combinations for use in Multi mode or to apply the effect settings of a particular Program to a Combination. Use the Copy Effect function (see page 119) to perform this operation.

Editing the Sound from a Computer

You may edit X5DR sounds from a computer using sound editing software. Be certain to use sound editing software that is compatible with the X5DR (editing involves MIDI exclusive data in the transmission of sound data). You may also use a sound editor designed for the X5 or 05R/W; their data is compatible with the X5DR, except for a few settings in Multi mode and Global mode.

Restoring the Parameter Values to the Factory Settings

To restore edited parameter values to factory default settings, load the default data on page 5A PRESET DATA in Global mode (see page 20, 156.). It should be noted that this operation will erase all existing data, such as the data of Bank A Programs, Combinations, Drum Kits, and user scales. If necessary, first save the data elsewhere. (See the following paragraph.) The X5DR has two types of preset data (PRE-a and PRE-b, for a total 200 Programs and 200 Combinations). The factory setting is PRE-a.

Saving Sound Data

Sound data and settings data can be transmitted as MIDI exclusive messages from the X5DR to an external sequencer or to a data filer that is capable of writing MIDI exclusive messages. Use page 4A MIDI DUMP for transmission (see page 154). You can also send data directly to the computer via the TO HOST connector. The X5DR is compatible with the X5 and 05R/W, except for a few parameters.

Set the EX parameter on page 2E MIDI FILTER in Global mode to “ENA” to receive MIDI exclusive messages. Otherwise, set this parameter to “DIS.” You also need to set the same Global MIDI Channel that was selected when you saved the data and switch the Memory Protect function ON. (See page 151–153.)

MIDI Applications

Playing Multiple Parts from a Sequencer

Enter Multi mode to play multiple parts using different Programs simultaneously from an external sequencer. (See page 16, 27.) Multi mode of the X5DR is used for GM data. You can also use this mode to change the MIDI Channel for each Track, or to adjust the Key Window or Velocity Window settings.

Multi mode is very handy for playing multiple parts, although the X5DR can play up to eight parts of an ensemble in Combination Play mode by changing the MIDI Channel for each Timbre. It is also possible to copy the Combination parameters into Multi mode. (See page 113.)

Creating a GM Song

When you create a GM song (performance data for a GM-compatible tone generator) using a sequencer or a computer, use only the Programs in Bank G in Multi mode, and use the default settings of the Key Window, Velocity Window, and MIDI Channels. (The default GM setting is obtained by turning the power off and on to the X5DR, or by using page 23A SET TO GM.) Performance data that uses functions unique to the X5DR (such as edits using the effects or Control Change messages) may not be reproduced correctly on a different GM tone generator.

Set and store the Program parameters and level settings on the sequencer. If you set these parameters on the X5DR, you can send the Multi setup data using 4A MIDI DUMP in Global mode to the sequencer or data filter, and send it back to the X5DR to play the data in live performance. (See page 62, 154.)

Using Two X5DR's (Using 128 Voices)

Playing two X5DR's that are connected to each other by a MIDI cable enables you to use 128 voices (twice the usual 64-voice polyphony). When you play only one X5DR, set the NoteR parameter of 2A MIDI GLOBAL in Global mode to ALL so that the X5DR will respond to all note numbers. When you play two X5DRs, set this parameter to ODD on one X5DR and EVEN on the other X5DR. This allows one X5DR to respond to the odd note numbers, and the other X5DR to respond to the even numbers. In this case, all the settings on both X5DRs should be the same, except for the Note Receive Filter parameter. (See page 151.)

Convenient Functions

The X5DR provides you with several useful tips for quicker operation and smoother editing.

Page Memory

The Page Memory function memorizes the most-recently selected page in every mode. Set the Page Memory parameter (3C PAGE MEMORY) in Global mode to ON, and the most-recently selected page in a particular mode will be displayed when you return to that mode. (See page 153.) This is useful when you wish to return to a different mode during an edit operation, or when you change modes frequently. (The factory default setting is “ON.”)

[▲]/[▼] buttons

When you are changing a parameter value in Program Edit mode or Combination Edit mode, pressing one of these buttons while pressing and holding down the other button will change the parameter value very quickly. This is a very convenient function when you wish to quickly set the parameter value of a wide range (such as Multisound assignment in Program Edit mode, or Timbre Program assignment in Combination Edit mode).

5. About MIDI

What is MIDI?

MIDI is an acronym for Musical Instrument Digital Interface, a world-wide standard that allows you to transfer performance information between electronic musical instruments and computers. The X5DR is a MIDI tone generator that does not have a keyboard. It receives MIDI data from a MIDI keyboard, computer, or sequencer to play music.

MIDI Connectors

MIDI connectors receive and transmit MIDI performance data. There are three types of MIDI connectors: MIDI IN, MIDI OUT, and MIDI THRU. You need to use MIDI cables to connect these connectors.

The MIDI IN connector receives data from an external MIDI device, and the MIDI OUT transmits data to an external MIDI device. The MIDI THRU connector transfers data received at the MIDI IN connector to the external MIDI device without alteration.

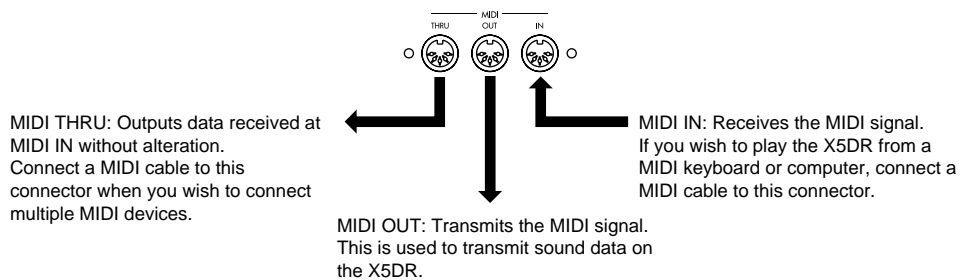

- You can connect as many MIDI devices as you want using the MIDI THRU connectors. However, to avoid a malfunction it is best to connect only up to two or three devices. If you wish to connect more devices, use a MIDI Patch Bay.

MIDI Channel

MIDI Channels are used to transfer the data of different instrumental parts (such as drums, bass, piano, etc.) through a single MIDI cable. There are 16 MIDI channels, and each channel transmits individual performance data. To playback data via MIDI, it is necessary that the receive channel and the transmit channel match, like a TV.

For example, the X5DR produces sound by receiving MIDI channel performance data set by the Global MIDI Channel in Program Play mode. The X5DR receives MIDI channel performance data set for each Timbre or Track in Combination Play mode or in Multi mode, respectively, to produce different sounds simultaneously.

MIDI Data

Various types of MIDI data are used to add versatile expressiveness to a performance, or to accomplish different types of performances. MIDI data is divided into two main categories: Channel messages that transmit performance information for each MIDI channel, and System messages that control the entire collection of MIDI settings and responses.

- In this section, the letter “H” is used for hexadecimal numbers to differentiate them from decimal numbers.

Channel Message

A Channel message controls a MIDI channel and includes the messages related to the music itself, as well as messages related to performance technique.

In the following Channel messages, “n” stands for a MIDI channel (n=0 through 15 =0 through FH corresponds to Channels 1 through 16.)

Note On/Off

Note On messages [9nH,kk,vv] (nH:MIDI Channel, kk:Note number, vv:Velocity) are used to produce sound, and Note Off messages [8nH,kk,vv] are used to stop a sound from being produced. Note numbers represent notes (keys) (Middle C=60). Note On Velocity messages represent the intensity (level) of the notes (1–127). The X5DR will ignore Note Off Velocity messages.

- In Program Play mode, the X5DR receives only Note On/Off messages on the Global MIDI Channel.
- In Combination Play mode and Multi mode, the X5DR receives only Note On/Off messages on the channels set for the Timbres and Tracks.
 - Sequencers and sequencing software use Note On messages (Note number and velocity) plus note length (Gate time or duration), instead of Note On/Off.

Program Change

Program Change messages [CnH,pp] (pp:Program number) are used to change Programs. You can select Program numbers 0 through 127. The X5DR has 236 Programs in Banks A and G. Therefore, Program Change messages alone are not enough to select a Program. To select Programs within a Bank requires Program Change messages, and switching Banks requires Bank Select messages [BnH,00H,mm] (Controller #00, mm:Upper digit of the Bank number), and [BnH, 20H,bb] (Controller #32, bb:Lower digit of the Bank number). Receiving only Bank Select messages will not change Programs. Receiving Program Change numbers following the Bank Select numbers will select the specified Program in the specified Bank.

- You need to use Bank Select messages to select Drum Programs 129 through 136 in Bank G. (See page 68 for details.)
- The manner in which you specify Program numbers varies depending on the type of sequencer or sequencing software. (For example, some use numbers 1 through 128, while others use A11 through B88). Refer to the manual that came with your sequencer or sequencing software.
- Program Change messages sent on the Global MIDI Channel switch Programs in Program Play mode. (These messages are ignored in Program Edit mode.) You can select a Bank using the Bank Select messages.
- Program Change messages sent on the Global MIDI Channel switch Combinations in Combination Play mode. Receiving Program Change and Bank Select messages on the receive channel of each Timbre will select Timbre Programs. You can set each Timbre independently such that it will receive or ignore the messages.
- Program Change and Bank Select messages sent on the receive channel of each Track in Multi mode will select the Track Programs. You can set each Track independently such that it will receive or ignore the messages.

- 2C Program Change Filter in Global mode allows you to set how the X5DR responds to Program Change messages. The options are ON (ENA), OFF (DIS), PRG (Program), and NUM (Number).

With the PRG setting, receiving Program Change messages on the Global MIDI Channel in Combination Play mode will not select a Combination. The Combinations do not change. Only the Programs of each Timbre are changed.

With the NUM setting, the X5DR ignores the Bank Select messages. This setting is used to prevent the Bank from being changed when you are playing back performance data on the X5DR, or when you are using a MIDI device that interprets the Bank Select messages in a different manner than does the X5DR.

Pitch Bend

Pitch Bend messages [EnH,bb,mm] (bb:Lower digits of the value, mm:Upper digits of the value) are used to shift pitch up or down. Note On messages determine the pitch (note or key) using the note numbers in steps of a semitone. Therefore, if you wish to shift pitch in smaller steps, or if you wish to create continuous changes in pitch, such as with trombone and guitar sounds, these messages are useful. A total of 16384 steps are available by using the upper and lower digits (bytes). The standard pitch (the pitch that exactly corresponds to the note number) is expressed by 8192 [bb,mm=00H,40H].

- How to set the Pitch Bend value varies depending on the type of sequencer or sequencing software. (For example, some use values -8192-0-8191). Refer to the manual that came with your sequencer or sequencing software.

To control the X5DR from a MIDI keyboard, you need to operate a pitch bend controller. There are many types of controllers, such as joysticks, wheels, and levers. Operating any one of these allows you to shift the pitch up and down, and releasing it causes the pitch to return to the standard level.

When you input Pitch Bend on your computer or sequencer, you can set it to any value. However, make sure that you restore the standard pitch. Otherwise, the Pitch Bend setting will affect subsequent performances.

The Joystick Pitch Bend parameter allows you to set the pitch bend range for each Program. This pitch bend range can be set for each Track by Bnd in Multi mode. In Multi mode, you can also use the RPN to set the bend range. In this case, send the RPN [BnH,65H,00H,64H,00H] (Controller #101 set to 0, and Controller #100 set to 0), then send the Data Entry messages [BnH,06H,mm] (Controller #06). “mm” represents the bend range. “0” is no pitch change, 2 is a whole step (two semitones), and 12 is one octave (12 semitones). The X5DR allows you to set a negative bend range value. (In this case, the pitch bend direction will be reversed.) However, you can set only a positive value using the RPN.

After Touch

After Touch is function that changes tonal color when you play the keys, then press them down further. After Touch messages transmit the intensity of this effect. There are two types of After Touch messages: Channel Pressure [DnH,vv] (vv:Pressure value) which applies the After Touch effect equally to all keys for each MIDI channel, and Polyphonic Key Pressure [AnH,kk,vv] (kk:Note number, vv:Pressure value) which applies the After Touch effect to each key separately. The X5DR receives only Channel Pressure messages. (In general, Polyphonic Key Pressure messages are not used.)

The After Touch messages transmit only the pressure value. The settings on the receiving device determine what type of effect is applied by the After Touch. You can set the After Touch effect in Program Edit mode on the X5DR to change tonal brightness and add modulation.

The MIDI filter in Global mode allows you to set the After Touch On/Off. You can set the After Touch On/Off for each Timbre in Combinations and for each Track in Multi mode setups.

Control Change

Control Change messages [BnH,cc,vv] (cc:Control number, vv:Value) are used to make various settings including the volume level and panpot, and transmit damper pedal information. The Controller number (cc) determines the function, and “vv” determines its value. Control numbers are divided into two categories: 0–63, and 64–119. (Numbers 120–127 are regarded as Mode messages). For numbers 0–63, a value is expressed by two bytes. You can set more detailed values by using 0–31 for an upper byte and 32 – 63 for a lower byte. The lower byte is used for the Bank Select and Data Entry messages on the X5DR.

The following section explains the Controllers that can be received on the X5DR.

Bank Select (CTRL#0/32)

Bank Select messages [BnH,00H,mm] (Controller #00, mm: Upper digits of the Bank number), [BnH,20H,bb] (Controller #32, bb: Lower digits of the Bank number) are used to change Banks. Transmit Bank Select messages to select a Bank, then transmit Program Change messages to select a Program. (Receiving only a Bank Select message will not change the Programs.)

When the PRG filter in Global mode is set to ENA or PRG, you can select a Program on the X5DR using the following methods.

- To select Programs in Bank A, transmit the Bank Select messages [BnH,00H,00H,20H,00H] (Controller #00 set to 0, Controller #32 set to 0), then transmit Program Change messages [CnH,pp] for the Program number. Program numbers 0–99 correspond to Programs A00–99, and Program numbers 100–127 correspond to Program A00–27.
- To select Programs in Bank G, transmit the Bank Select messages [BnH,00H,38H,20H,00H] (Controller #00 set to 56, Controller #32 set to 0), then transmit Program Change messages [CnH,pp] for the Program number. Program numbers 0–127 correspond to Programs G01–128.
- To select Drum Programs(G129–136) in Bank G, transmit the Bank Select messages [BnH,00H,3E,20H,00H] (Controller #00 set to 62, Controller #32 set to 0), then transmit Program Change messages [CnH,pp] for the Program number. The following list shows the relationship between the Program numbers of the Program Change messages and Drum Programs.

Program Change	Drum Program
Program Number 0–15, 56–63, 72–127.....	G129
Program Number 16–23.....	G130
Program Number 25.....	G131
Program Number 32–39.....	G132
Program Number 40–47.....	G133
Program Number 64–71.....	G134
Program Number 24, 26–31.....	G135
Program Number 48–55.....	G136

- To mute Tracks (stop the sound from being produced) on the corresponding MIDI channel, transmit the Bank Select messages [BnH,00H,3FH,20H,7FH] (Controller #00 set to 63, Controller #32 set to 127), then transmit the Program Change’s [CnH,pp] Program number (for example, 127).

Pitch MG (CTRL#1)

Pitch Modulation messages [BnH,01H,vv] (Controller #01, vv:Depth of modulation), used to adjust the depth of vibrato, are also called Modulation messages. This depth corresponds to the amount of the joystick’s upward movement (in the +Y direction) on the MIDI keyboard. Some MIDI keyboards have a wheel or lever type controller instead of a joystick.

These Pitch Modulation messages adjust only the depth of vibrato. Usually, the rate and type (waveform) of vibrato are determined by the settings on the reception device. On the X5DR, you can set the type and rate of vibrato using Pitch 1/2 MG in Program Edit mode.

VDF MG (CTRL#2)

VDF Modulation messages [BnH,02H,vv] (Controller #02, vv:Depth of modulation) are used to adjust the depth of the wah effects. This depth corresponds to the amount of the joystick's downward movement (in the -Y direction) on the MIDI keyboard. Some MIDI keyboards have a wheel or lever type controller instead of a joystick to which you assign this function.

These VDF Modulation messages adjust only the depth of wah. Usually, the rate and type (waveform) of wah are determined by the settings on the reception device. On the X5DR, you can set the type and rate of wah using VDF MG in Program Edit mode.

How to trigger VDF MG messages varies depending on the keyboard you are using. (e.x.: Breath control)

Foot Controller (CTRL#4)

Foot Controller messages [BnH,04H,vv] (Controller #04, vv:Value) are used to transmit a foot controller's movement. These messages are used to switch scales on the X5DR. When the value vv is 0–63, the Main scale is selected, and when the value vv is 64–127, the Sub scale is selected.

Data Entry (CTRL#6/38)

Data Entry messages [BnH,06H,mm] (Controller #06, mm:Upper digits of the value) [BnH,26H,vv] (Controller #38, vv: Lower digits of the value) are used to set the parameter value using the RPN. For details, refer to the section on RPN (page 71).

Volume (CTRL#7)

Volume messages [BnH,07H,vv] (Controller #07, vv:Value) are used to adjust the volume level. The range of the value "vv" is 0 through 127. Usually, these messages are used to adjust the volume level balance for multi-timbral performances.

The actual volume level is obtained by the volume value multiplied by the Expression (Controller #11) value. [Volume level = The volume setting (such as the OSC level) × (Volume/127) × (Expression/127)]

Panpot (CTRL#10)

Panpot messages [BnH,0AH,vv] (Controller #10, vv:Value) are used to adjust the panpots for stereo playback. These messages correspond to Panpot A-B on the X5DR. Refer to the chart on page 173 for the relationship between the panpot value (vv) and responses.

These messages are ignored when the Pan setting of the Timbre in Combination mode or Track in Multi mode is OFF or PRG. They are also ignored in Program mode.

Expression (CTRL#11)

Expression messages [BnH,0BH,vv] (Controller #11, vv:Value) are used to adjust the volume level. The range of value "vv" is 0 through 127. Usually, these messages are used to create crescendos and diminuendos. Usually, Volume messages (Controller #7) are used to control the level of the musical data in its entirety (i.e., the volume balance between different instruments or parts).

The actual volume level is obtained by the volume value (Controller #7) multiplied by the Expression value. [Volume level = The volume setting (such as the OSC level) × (Volume/127) × (Expression/127)]

Effect Control 1/2 (CTRL#12/13)

Effect Control 1 [BnH,0CH,vv] (Controller #12, vv:Value) and Effect Control 2 [BnH,0Dh,vv] (Controller #13, vv:Value) messages are used as modulation sources to adjust the effects. On the X5DR, Effect Control 1 corresponds to Pedal 1, and Effect Control 2 corresponds to Pedal 2.

- These messages are received only on the Global MIDI Channel.

Damper Switch (CTRL#64)

Damper Switch messages [BnH,40H,vv] (Controller #64, vv:Value) are used to transmit the movement of a damper pedal that sustains the sound. The damper switch is OFF when “vv” is set to 0–63, and the switch is ON when “vv” is set to 64–127. When you are using a damper switch connected to a MIDI keyboard, releasing the pedal turns the damper effect OFF. However, on a computer or sequencer, you need to set the damper OFF whenever you do not want the effect.

Release Time (CTRL#72)

Release Time messages [BnH,48H,vv] (Controller #72, vv:Value) are used to adjust the VDF EG and VDA EG release time. The range of value “vv” is 0 through 127. Value 64 is the center value. Larger values (65 or higher) make the release time longer, and smaller values (63 or lower) make the release time shorter. These are useful when you wish to adjust the release time in the middle of a performance.

Attack Time (CTRL#73)

Attack Time messages [BnH,49H,vv] (Controller #73, vv:Value) are used to adjust the attack time of VDA EG. The range of value “vv” is 0 through 127. Value 64 is the center value. Larger values (65 or higher) make the attack time longer, and smaller values (63 or lower) make the attack time shorter. These are useful when you wish to adjust the attack time in the middle of performance.

Brightness (CTRL#74)

Brightness messages [BnH,4A,vv] (Controller #74, vv:Value) are used to adjust the VDF Cutoff to control tonal brightness. The range of value “vv” is 0 through 127. Value 64 is the center value. Larger values (65 or higher) make the sound brighter, and smaller values (63 or lower) make the sound darker. These are useful when you wish to adjust the tonal brightness in the middle of a performance.

Reverb Level (CTRL#91)

Reverb Level messages [BnH,5BH,vv] (Controller #91, vv:Value) are used to adjust the Send C level. The range of value “vv” is 0 through 127. Refer to the chart on page 173 for the relationship between the Reverb Level value (vv) and Send C level. Typically, these messages are used to adjust the depth of reverberation.

These messages are ignored when the Send setting of the Timbre in Combination mode or Track in Multi mode is PRG. They are also ignored in Program mode.

Effect 1 On/Off (CTRL#92)

Effect 1 On/Off messages [BnH,5CH,vv] (Controller #92, vv:Value) are used to turn Effect 1 On and Off. When “vv” is 0, Effect 1 is turned Off, and when “vv” is any value between 1 and 127, Effect 1 is turned On.

- These messages are received only on the Global MIDI Channel.

Chorus Level (CTRL#93)

Chorus Level messages [BnH,5DH,vv] (Controller #93, vv:Value) are used to adjust the Send D level. The range of value “vv” is 0 through 127. Refer to the chart on page 173 for the relationship between the Chorus Level value (vv) and Send D level. In general, these messages are used to adjust the depth of chorus.

These messages are ignored when the Send setting of the Timbre in Combination mode or Track in Multi mode is PRG. They are also ignored in Program mode.

Effect 2 On/Off (CTRL#94)

Effect 2 On/Off messages [BnH,5EH,vv] (Controller #94, vv:Value) are used to turn Effect 2 On and Off. When “vv” is 0, Effect 2 is turned Off, and when “vv” is any value between 1 and 127, Effect 2 is turned On.

- These messages are received only on the Global MIDI Channel.

Data Increment/Decrement (CTRL#96/97)

Data Increment [BnH,60H,00H] (Controller #96 for 0) and Data Decrement [BnH,61H,00H] (Controller #97 for 0) messages are used to increase/decrease the parameter value specified by the RPN by steps of one. When the X5DR receives a Data Increment message, the parameter value is increased by one, and receiving a Data Decrement message decreases the value by one. Refer to the following RPN explanation for information on how to use these messages.

RPN LSB/MSB (CTRL#100/101)

RPN messages [BnH,64H,rr] (Controller #100, rr: Lower digits of the value), [BnH,65H,mm] (Controller #101, mm: Upper digits of the value) are used to select parameters. RPN is an acronym for Registered Parameter Number, which allows you to control the common parameters on various MIDI devices. Select a parameter using RPN messages, then set the parameter value using Data Entry Increment/Decrement messages.

The Pitch Bend Range, Fine Tune, and Coarse Tune parameters on the X5DR respond to these messages.

- To set the Pitch Bend Range parameter, send the RPN messages [BnH,65H,00H] (Controller #101 set to 00) and [BnH,64H,00H] (Controller #100 set to 00), followed by the Data Entry messages [BnH,06H,vv] (Controller #06, vv:Bend range) and [BnH,26H,00H] (Controller #38 set to 00). “vv” specifies the bend range in steps of one semitone. When “vv” is 00, the bend range is “0”, and when “vv” is 12, the bend range is one octave (12 semitones). These messages are received only in Multi mode for the pitch bend range adjustment.
- To set the Fine Tune parameter, send the RPN messages [BnH,65H,00H] (Controller #101 set to 00) and [BnH,64H,01H] (Controller #100 set to 01), followed by the Data Entry messages [BnH,06H,nn] (Controller #06, nn:Upper digits of the value) and [BnH,26H,nn] (Controller #38, vv:Lower digits of the value). “vv” and “nn” specify the fine tune value, and tuning will be changed as shown in the table.

Controller No.		
06	38	Pitch Bend (semitone)
00	00	0
01	00	+1
12	0	+12

These messages allow you to adjust detune values for each Track in Multi mode, and master tune value in Global mode.

- To set the Coarse Tune parameter, send the RPN messages [BnH,65H,00H] (Controller #101 set to 00) and [BnH,64H,02H] (Controller #100 set to 02), followed by the Data Entry messages [BnH,06H,vv] (Controller #06, vv:Value) and [BnH,26H,00H] (Controller #38 set to 00). “vv” specifies the coarse tune value, and transposition will be changed as shown in the next table.

These messages are received only in Multi mode to adjust transposition.

Controller No.		
06	38	Fine Tune (cent)
30	00	-50
48	00	-25
64	00	0
96	00	+50

Controller No.		
06	38	Coarse Tune (semitone)
40	00	-24
50	00	-12
60	00	0
88	00	+24

- When you are using RPN messages, be sure to send the RPN MSB (Controller #101), RPN LSB (Controller #100), Data Entry MSB (Controller #06), then Data Entry LSB (Controller #38) in this order. If you do not follow this sequence, the parameters will not be set correctly.
- After setting the parameter values using RPN messages, you can adjust the values using the Data Increment (Controller #96 set to 0) and Data Decrement (Controller #97 set to 0) messages.
- Parameter selection by means of RPN messages is memorized until the next RPN messages are sent or you turn off the power to the X5DR. Therefore, after you have set a parameter value using RPN and Data Entry messages, if you wish to adjust the value of the same parameter, you need to send only the Data Entry messages.

System Messages

These messages are related to the entire MIDI system. System messages include System Real-time messages for sync operation using a MIDI device such as a sequencer, System Common messages that transmit the position in performance such as Song Start and Song End, and System Exclusive messages that transmit information unique to certain manufacturers or models. The X5DR is able to receive and transmit System Exclusive messages.

System Exclusive messages

System Exclusive messages are used to transmit data unique to certain devices (Program data, setting data, etc.) via MIDI. The format of the X5DR System Exclusive messages is [F0H,42H,3nH,36H,ff,....,F7H] (nH:Global MIDI Channel, ff:Function code - type of message). Using these messages allows the X5DR to transmit, receive and edit bulk Program data (Data Dump).

Universal System Exclusive is a standard format and protocol used to send data back and forth between various devices from different manufacturers. The X5DR responds to some Universal Exclusive messages as well as to Korg Exclusive messages.

Universal System Exclusive

Universal System Exclusive is an industry standard protocol used to send data back and forth between various devices from different manufacturers. These messages are divided into two categories: Non-real-time Universal System Exclusive [F0H,7EH,nn,aa,....,F7H] (nn:MIDI channel, aa:ID), and Real-time Universal System Exclusive [F0H,7FH,nn,aa,....,F7H] (nn:MIDI channel, aa:ID). The X5DR responds to these messages when MIDI channel “nn” is 127 [7FH] (MIDI channel ignored), or when it matches the Global MIDI Channel.

Inquiry Message Request

This message is used to send data to find out the model and version number of a MIDI device connected to a computer. When the X5DR receives an Inquiry Message Request [F0H,7EH,nn,06H,01H,F7H] (nn:MIDI channel), it transmits the Inquiry information [F0H,7EH,nn,06H,02H, (9 bytes),F7H] that says “This is a Korg X5DR. The system version is.....” (See page 163 (1-3).)

GM System On

This message is used to initialize a GM tone generator. When the X5DR receives a GM System On message [F0H,7EH,nn,09H,01H,F7H], it enters Multi mode and initializes itself for GM use. When you create a GM song, enter this message at the beginning of the data so that the song will always be played back under the same conditions.

Master Volume

This message is used to adjust the volume level of the entire MIDI tone generator. When the X5DR receives Master Volume [F0H,7FH,nn,04H,01H,vv,mm,F7H] (vv:Lower digits of the value, mm:Upper digits of the value), the entire volume level is changed. This message allows you to adjust the entire volume level without destroying the level balance between Timbres and Tracks in Combination mode and Multi mode.

Master Balance

This message is used to adjust the volume level balance of the entire MIDI tone generator. When the X5DR receives Master Balance [F0H,7FH,nn,04H,02H,vv,mm,F7H] (vv:Lower digits of the value, mm:Upper digits of the value), the entire volume level balance is changed. A value of 8192 (vv=00H,mm=40H) specifies the initial position (stereo image currently set on the MIDI tone generator). Smaller values make the right volume level lower.

Korg Exclusive

Using Korg Exclusive messages allows you to transmit and receive sound setting data and change parameter values for sound editing on the X5DR.

Data Dump

You can send Program, Combination, Multi, Drum Kit, and Global data as Exclusive data to and from the X5DR. You can also store Exclusive data sent from the X5DR into the computer, sequencer or data filer to keep the data for Programs and various settings. Sending that data as Exclusive data from the computer, sequencer or data filer will restore the Program and other setting data on the X5DR. This is a very useful function when you wish to store the original Program data and the current setting data. The X5DR's Exclusive data is compatible with the X5 and 05R/W. Some parameters in Multi mode and Global mode are different, but the common parameters are compatible among these models.

- Use MIDI Data Dump in Global mode to transmit dump data. To do this, first select the type of data to be transmitted, and dump data will be sent to the specified destination (MIDI OUT or TO HOST terminal). You can store Program and setting data by sending and storing the Data dump into a computer, sequencer, or data filer.
- The dump data for one Program is transmitted when the X5DR changes the mode from Program Play mode to Program Edit mode.

The dump data for one Combination is transmitted when the Combinations are changed in Combination Play mode.

- The X5DR changes Programs or settings when it receives the dump data or Exclusive data for one Program.
 - Exclusive data is received and transmitted via the Global MIDI Channel. Set the Global MIDI Channel on the reception and transmission devices to the same number. When you are restoring Exclusive data stored in a computer, sequencer, or data filer back to the X5DR, use the same Global MIDI Channel you used when you transmitted data out to the storage device.
 - The X5DR transmits the dump data according to the content of the dump Request message that it received. You can send Data dumps from the X5DR by transmitting a dump request from the computer or sequencer.

Parameter Change

The X5DR can transmit and receive the bulk data of Programs and Combinations, as well as set independent parameter values. You can edit X5DR Programs by sending Parameter Change messages or Drum Kit Parameter Change messages from the computer, another X5DR, X5, or 05R/W.

- Refer to “MIDI Data Format” on page 167, 171 for the Parameter Change format.

About the MIDI Filter

The X5DR has a MIDI Filter function that cuts certain MIDI data (i.e., prevents MIDI data from being received) for various performances. You can set the MIDI filter in Global mode. You can also set the MIDI filter for each Track in Multi mode. Combinations also have a MIDI filter for each Timbre, and the X5DR stores the filter settings for each Combination.

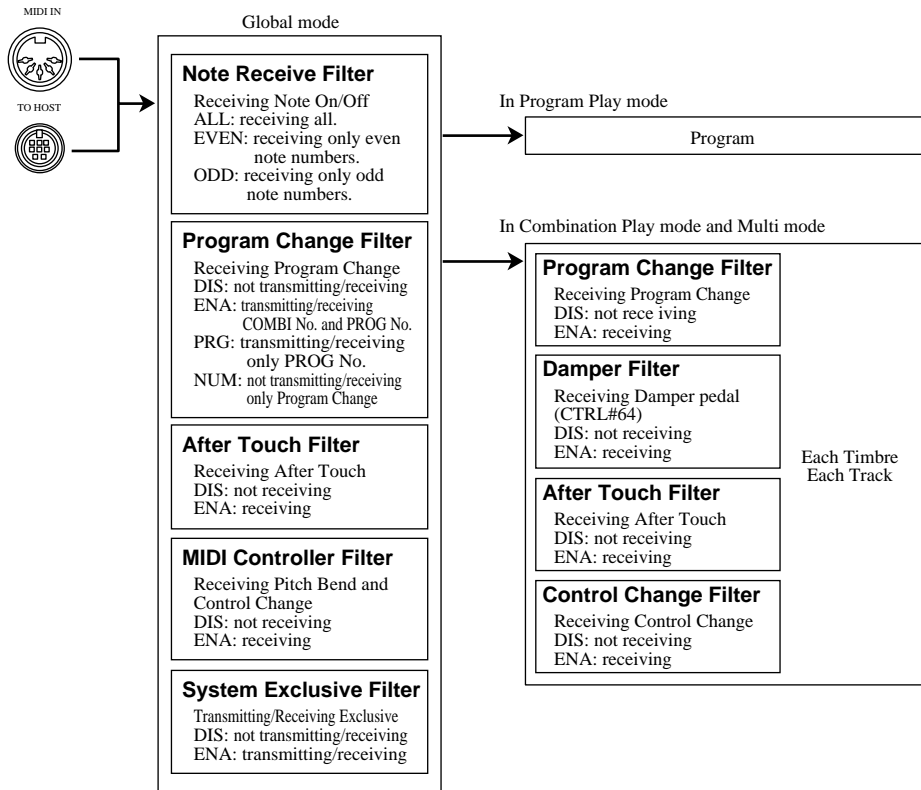

The MIDI Filter in Global mode is the setting common to all modes. If you want to set the X5DR so that it will ignore certain data for a specified Timbre or Track in Combination Play mode or Multi mode, set the MIDI Filter in the corresponding Timbre or Track.

There are four options: DIS, ENA, PRG, and NUM for the Program Change Filter in Global mode. If you want the X5DR to ignore the Program Change and Bank Select messages, set this parameter to DIS. If you want the X5DR to receive both Program Change and Bank Select messages, set this to ENA or PRG. To set the X5DR so that it will ignore only the Bank Select message (Program Change messages will be received), set this to NUM.

If you select ENA or PRG, the X5DR responds to these messages in the same way in both Program Play mode and Multi mode.

In Combination Play mode, the X5DR responds to Program Change messages sent on the same MIDI channel as the Global MIDI Channel differently with ENA and PRG settings. When ENA is selected, the Program Change messages sent on the same MIDI channel as the Global MIDI Channel will switch Combinations. When PRG is selected, the Program Change messages will switch Timbre Programs.

Set the Program Change Filter in Global mode and in Combinations depending on how you play the X5DR.

With the ENA or PRG setting, the X5DR will transmit the Program Change and Bank Select messages when you change the Program in Program Play mode. With the NUM setting, only the Program Change messages are transmitted. With the DIS setting, neither of the messages will be sent. With the ENA, PRG, or NUM setting, the X5DR will transmit the Program Change messages when you change the Combination in Combination Play mode. With the DIS setting, the Program Change messages will not be sent.

If you have selected 4A Data Dump in Global mode, the X5DR will be able to transmit and receive exclusive data when the System Exclusive Filter is set to DIS.

Reference Guide

Parameter Guide

About this chapter

The following chart shows how the explanations in this chapter are organized.

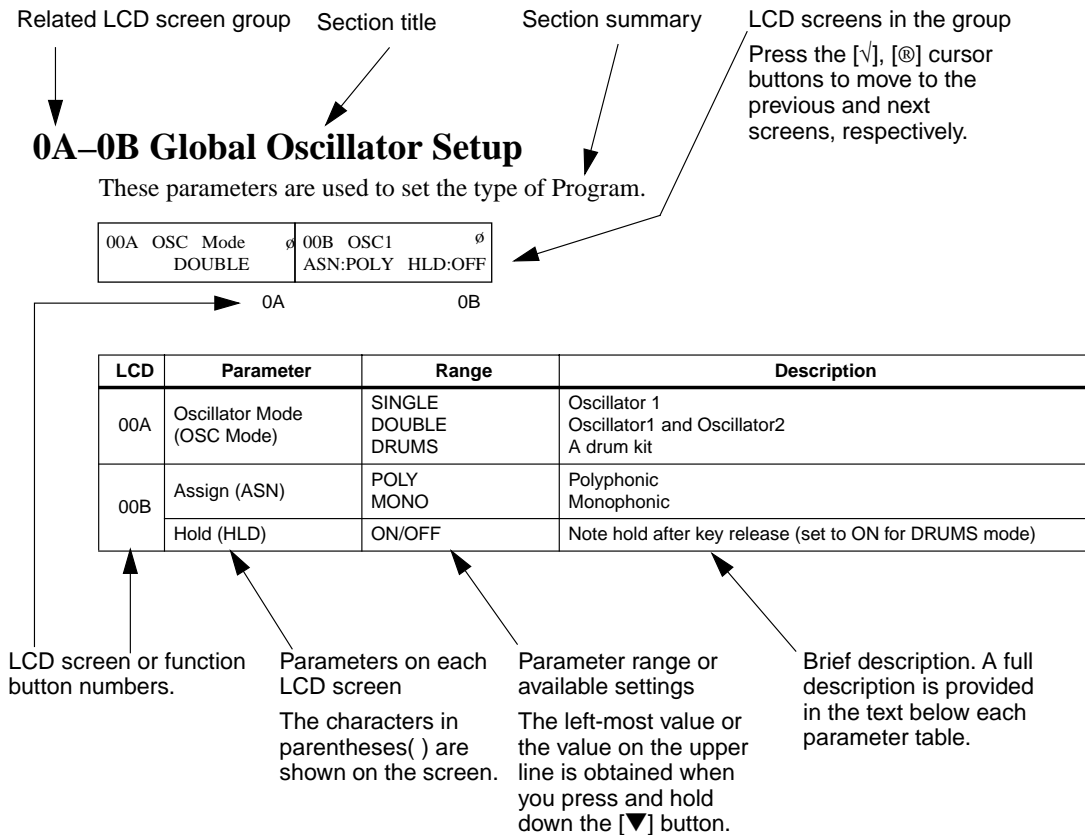

MIDI Data Values

In general, decimal values are used throughout this *Owner's Manual*. Numbers that are enclosed by square brackets are hexadecimal.

- The words “keyboard” and “joystick” used in this parameter guide refer to the keyboard and joystick on a synthesizer (such as the X3) connected to the MIDI IN terminal of the X5DR. You can send various MIDI messages to the X5DR using the keyboard and joystick. You can also obtain the same result by sending MIDI messages from a computer connected to the MIDI IN or TO HOST of the X5DR.

1. Program Parameters

Functions in Program Mode

Key operations:

Selecting a page [PAGE+] key, [PAGE-] key

Selecting a parameter [√] key, [Ⓜ] key

Setting a parameter value [▲] key, [▼] key

Page numbers shown in the upper left corner of the screens in Single or Drums mode are different from those in Double mode. This manual uses the page examples in Double mode.

Page		Function	Parameters
SINGLE, DRUMS	DOUBLE		
0A-0B	0A-0B	OSC Mode Assign/Hold	Oscillator mode Number of voices to sound, and Hold settings
1A-1D	1A-1D	OSC1 Multi Sound (Drum Kit) Level/Octave EG Intensity/Pan/Send	Oscillator 1 waveform Level, Octave Double mode only Depth of the pitch change over time, output destination
—	2A-2F	OSC2 Multi Sound Level/Octave EG Intensity/Pan/Send Interval/Detune Delay	Refer to the OSC1 parameters. Interval (by semitone) and detune (by cent) relative to OSC1 Delay in sounding OSC2 relative to OSC1
2A-2C	3A-3C	Pitch EG	Adjusts changes in pitch over time
3A-3E	4A-4E	VDF1 Cutoff EG Color	VDF1 cutoff frequency (Controls brilliance of tone) Specifies changes in cutoff frequency over time. Color (feedback effect)
4A-4E	5A-5E	VDF1 Velocity Sense Keyboard Tracking	How key velocity affects VDF1 EG cutoff frequency and time How key position affects VDF1 EG cutoff frequency and time
—	6A-6E	VDF2 Cutoff EG Color	Refer to the VDF1 parameters.
—	7A-7E	VDF2 Velocity Sense Keyboard Tracking	
5A-5C	8A-8C	VDA1 EG	Change in VDA1 level over time
6A-6E	9A-9E	VDA1 Velocity Sense Keyboard Tracking	How key velocity affects VDA1 EG cutoff frequency and time How key position affects VDA1 EG cutoff frequency and time
—	10A-10C	VDA2 EG	Refer to VDA1 parameters.
—	11A-11E	VDA2 Velocity Sense Keyboard Tracking	
7A-7E	12A-12E	Pitch1 MG	Oscillator 1 pitch MG (vibrato)
—	13A-13E	Pitch2 MG	Oscillator 2 pitch MG (vibrato)
8A-8C	14A-14C	VDF MG	VDF modulation (wah-wah effect)
9A-9D	15A-15D	After Touch Control Joy Stick Control	After Touch control Joystick control
10A-15A	16A-20A	Effect	Effect settings
16A-16B	22A-22B	Program Write Rename Program	Writes a Program Renames a Program

- For information on Effects, See “Effect Parameters” on page 115.

0A–0B Global Oscillator Setup

These parameters are used to select a basic Program type—that is, whether the Program will use a single oscillator, two oscillators, or a drum kit. In addition, you can specify whether the Program will hold notes even after Note Off messages are received, and whether it will play monophonically or polyphonically.

00A	OSC Mode	ø	00B	OSC1	ø
	DOUBLE		ASN:POLY	HLD:OFF	
		0A			0B

LCD	Parameter	Range	Description
0A	Oscillator Mode (OSC Mode)	SINGLE DOUBLE DRUMS	Oscillator1 Oscillator1 and Oscillator2 A drum kit
0B	Assign (ASN)	POLY MONO	Polyphonic Monophonic
	Hold (HLD)	ON/OFF	Note hold after key release (set to ON for DRUMS mode)

0A Oscillator mode: There are three Oscillator modes: Single, Double, and Drums. In Single mode, only Oscillator1 is used, and 64-note polyphony is available. In Double mode, Oscillator1 and Oscillator2 are used, and different Multisounds can be selected for each oscillator, each with independent VDF and VDA. Polyphony is 32 notes.

In Drum mode, a drum kit is used instead of a Multisound.

0B Assign: This parameter sets the Program to either polyphonic or monophonic. In Polyphonic mode, a number of notes up to the maximum available can be played simultaneously. In Monophonic mode, one note only can be played at a time.

Hold: This parameter determines whether or not notes continue to sound even after the corresponding MIDI Note Off message has been received. That is, even after keys are released. Typically, this parameter should be set to off, unless you want notes to drone on for eternity. However, when the Oscillator mode is set to DRUMS, this parameter should be set to ON. This will ensure that drum sounds are played in their entirety regardless of MIDI Note length or how long you hold down a key.

1A–1D Oscillator1 Setup

These parameters are used to select the waveform for Oscillator1 and to set up other parameters related to this oscillator.

01A OSC1 SOUND 000:A.Piano 1	01B OSC1 Level99 OCT 8'	01C OSC1 EGint+00 Pan=CNT	01D OSC1 C/D SEND= 5 : 5
1A	1B	1C	1D

LCD	Parameter	Range	Description
1A	Multisound (SOUND)	0–429 0–9	Multisounds (Single/Double mode) If Oscillator mode is DRUMS, select a drum kit
1B	Oscillator Level (Level)	0–99	Level
	Octave (OCT)	32' 16' 8' 4'	2 octaves down 1 octave down Normal pitch 1 octave up
1C	Pitch EG Intensity (EGint)	–99...+99	The amount of control that the Pitch EG exerts over pitch
	Pan (Pan)	OFF, A15–CNT–B15	Output pan to buses A and B (when Osc mode = Single or Double on)
1D	Send C	0–9	Output level to bus C
	Send D	0–9	Output level to bus D

- 1A Multisound:** This parameter is used to select an internal Multisound for Oscillator1. The X5 has 430 Multisounds. Multisounds are the basic sound elements that make up a Program and provide the basic characteristics of a Program.

Multisounds with NT (No Transpose) at the end of their names, for example, 187 Stadium NT, produce the same pitch regardless of what note is played.

Note: Since each Multisound has an upper limit to its pitch range, some Multisounds may not produce sound when high notes are played.

If the Oscillator mode 0A is set to DRUMS, you can select a drum kit from the following table. Drum kits are set up in Global mode. “6A–6D Drum Kit1 Setup” on page 158 and “7A–7D Drum Kit2 Setup” on page 160. There are 10 drum kits available: two internal RAM kits, and eight internal ROM kits.

Value	Drum Kit	Bank
0	Drum Kit 1	Internal RAM
1	Drum Kit 2	
2	Rom D.Kit1	ROM
:	:	
9	Rom D.Kit8	

Drum maps for drum kits 0, 1 and 2–9 are provided at the back of this Owner’s Manual.

- 1B Oscillator Level:** This parameter is used to set the volume level of Oscillator1.

Note: For some Multisounds, a high Oscillator Level may result in distortion when playing chords. If this occurs, reduce the Oscillator Level.

Octave: This parameter allows you to shift a Multisound up or down in one octave steps. If the Oscillator mode 0A is set to DRUMS, this parameter should be set to 8', otherwise some drum sounds will be moved out of their playable range. If this parameter is set to anything other than 8', take care when setting the VDA and VDF Keyboard Tracking parameters.

- 1C Pitch EG Intensity:** This parameter determines the amount of control that the Pitch EG exerts over the pitch of Oscillator1. A negative value inverts the pitch levels set for the Pitch EG (Refer to 3A–3C Pitch EG.).

Pan: This parameter is used to pan the output of Oscillator1 between buses A and B. These buses feed the effects processors. See “20A–20B Effect Placement” on page 117. When OFF is selected, no signals are sent on buses A and B. The CNT setting means center; signals of equal level are fed to buses A and B.

Note: *When the Oscillator mode 0A is set to DRUMS, the pan settings for each drum in the kit are used, and this parameter does not appear. See “6A–6D Drum Kit1 Setup” on page 158 and “7A–7D Drum Kit2 Setup” on page 160.*

Note: *Some Multisounds have their own Pan settings and will ignore the Pan settings here, indicating “Pan=---.”*

- 1D Send C, Send D:** These parameters are used to set the level of Oscillator1 signal sent to buses C and D. These buses feed the effects processors. See “20A–20B Effect Placement” on page 117.

Note: *If 0A Oscillator mode is set to DRUMS, these parameters are multiplied by the settings for each drum in the kit, then output to Send C and Send D. See “6A–6D Drum Kit1 Setup” on page 158 and “7A–7D Drum Kit2 Setup” on page 160.*

2A–2F Oscillator2 Setup

These parameters are used to select the waveform for Oscillator2 and to set up other parameters related to this oscillator. These parameters are available only when the Oscillator mode is set to DOUBLE.

02A OSC2 SOUND 000:A:Piano 1	02B OSC2 Level99 OCT16'	02C OSC2 EGint+00 Pan=CNT	02D OSC2 C/D SEND= 5 : 5	02E OSC2 SOUND Intvl+00 Detn+03
2A	2B	2C	2D	2E

02F OSC2 Delay=00
2F

LCD	Parameter	Range	Description
2A	Multisound (SOUND)	0–429	Select Multisounds
2B	Oscillator Level (Level)	0–99	Oscillator2 level
	Octave (OCT)	32' 16' 8' 4'	2 octaves down 1 octave down Normal pitch 1 octave up
2C	Pitch EG Intensity (EGint)	–99...+99	The amount of control that the Pitch EG exerts over pitch
	Pan (Pan)	OFF, A15–CNT–B15	Output pan to buses A and B
2D	Send C	0–9	Output level to bus C
	Send D	0–9	Output level to bus D
2E	Interval (Intvl)	–12...+12	Pitch shift relative to Oscillator1
	Detune (Detn)	–50...+50	Oscillator1 and Oscillator2 detune
2F	Delay Start (Delay)	0–99	Oscillator2 sound output delay relative to Oscillator1

Apart from the fact that they control Oscillator2, parameters 2A–2D work the same as they do for Oscillator1. See “1A–1D Oscillator1 Setup” on page 80. The following parameters, however, 2E and 2F, apply to Oscillator2 only.

2E Interval: This parameter pitch shifts Oscillator2 relative to Oscillator1 in semitone steps. This can be used, for example, to form simple 2-note chords.

Detune: This parameter de-tunes oscillators 1 and 2. This is useful for creating a thicker, richer sound. For a positive (+) Detune value, the pitch of Oscillator1 is lowered and the pitch of Oscillator2 is raised. For a negative (–) Detune value, the pitch of Oscillator1 is raised and the pitch of Oscillator2 is lowered. In other words, as the Detune value is increased, both oscillators are detuned by the same amount, but in opposite directions. Odd Detune values will lower and raise oscillator pitches in half cent steps.

Detune	Oscillator1	Oscillator2
+50	–25	+25
+25	–12.5	+12.5
0	0	0
–12	+6	–6
–50	+25	–25

2F Delay Start: This parameter allows you to set Oscillator2 so that it starts producing sound after Oscillator1. A setting of 0 means no delay. This is normally set to 0.

3A–3C Pitch EG

This determines how the pitches of Oscillator1 and Oscillator2 vary over time.

03A PITCH EG ϕ	03B PITCH EG ϕ	03C PTCH.EG Vel ϕ
SL+00 AT00 AL+00	DT00 RT00 RL+00	Levl=99 Tim=+00
3A	3B	3C

LCD	Parameter	Range	Description
3A	Start Level (SL)	-99...+99	Amount of pitch change when key is first pressed
	Attack Time (AT)	0-99	Time to reach Attack level pitch when key pressed
	Attack Level (AL)	-99...+99	Amount of pitch change when attack time ends
3B	Decay Time (DT)	0-99	Time to reach normal pitch once attack time ends
	Release Time (RT)	0-99	Time to reach Release level pitch when key is released
	Release Level (RL)	-99...+99	Amount of pitch change when key is released
3C	EG Level Velocity Sensitivity (Levl)	-99...+99	Pitch EG level sensitivity to keyboard velocity
	EG Time Velocity Sensitivity (Tim)	-99...+99	Pitch EG time sensitivity to keyboard velocity

The Pitch EG (Envelope Generator) can change the oscillator pitch by up to ± 1 octave. A level setting of 99 is approximately 1 octave. The extent to which the Pitch EG affects the oscillator pitch is set independently for each oscillator using the Pitch EG Intensity (EGint) parameters. See “1A–1D Oscillator1 Setup” on page 80 and “2A–2F Oscillator2 Setup” on page 82.

The main thing to remember is that the Level parameters specify the amount of pitch change, and the time parameters specify the time it takes to reach pitch changes relative to note on and note off. Negative (-) levels mean lowered pitch and positive (+) levels mean raised pitch.

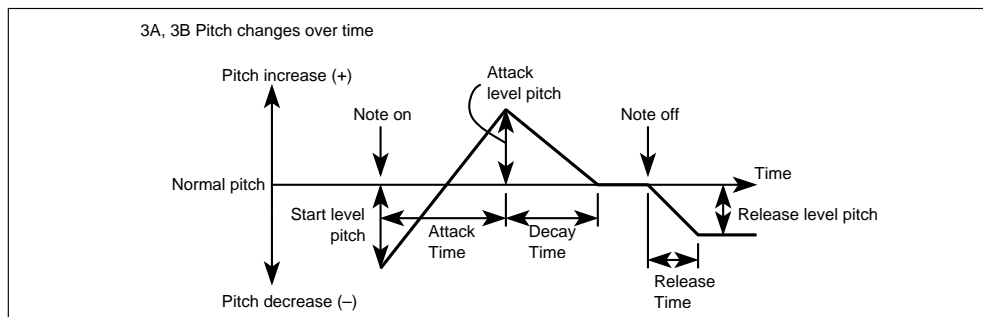

- 3C EG Level Velocity Sensitivity:** This parameter allows you to control the Pitch EG pitch levels using note velocity. For a positive value (+), the amount of pitch change will increase as note velocity increases (as you play a connected keyboard (such as the X3) more forcefully). A negative value (-) will have the opposite effect.

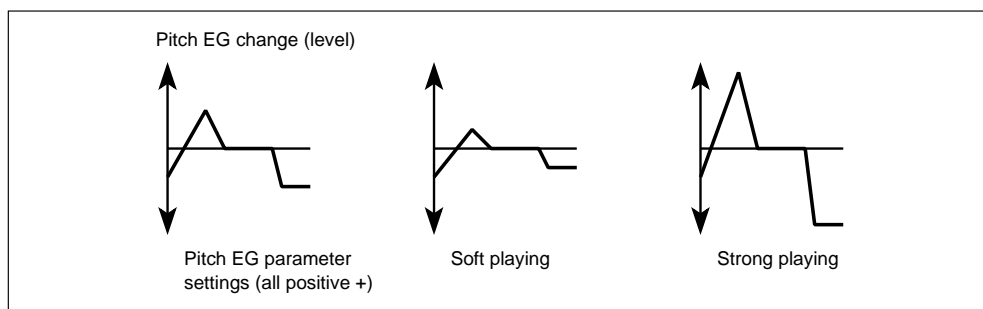

EG Time Velocity Sensitivity: This parameter allows you to control the Pitch EG Time parameters using note velocity. For a positive value (+), time parameters will become shorter as note velocity increases (as you play the keyboard more forcefully). A negative value (-) will have the opposite effect.

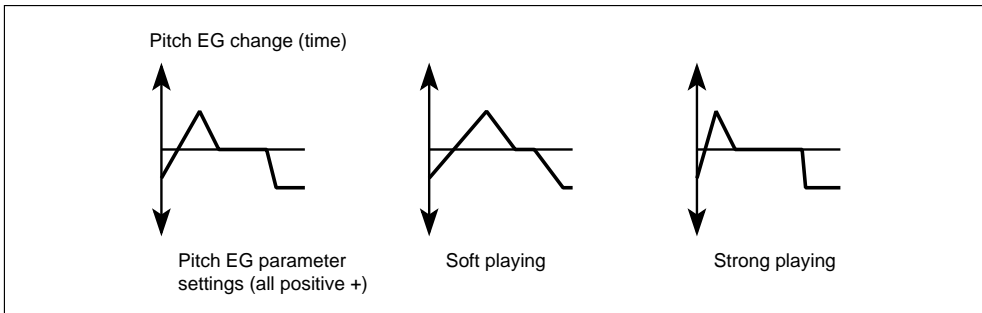

4A–4E VDF1 Cutoff, EG & Color

These parameters are used to set up the VDF (Variable Digital Filter) for Oscillator1.

04A VDF 1 Fc=19 EGint=65	04B VDF1 EG AT09 AL+08 DT00	04C VDF1 EG BP+00 ST00 SL+00	04D VDF1 EG RT00 RL+00	04E Color1 Int=00 Vel=+00
4A	4B	4C	4D	4E

LCD	Parameter	Range	Description
4A	VDF Cutoff Frequency (Fc)	0–99	Cutoff frequency
	EG Intensity (EGint)	0–99	The amount of control that the following EG parameters exert over the VDF Cutoff Frequency parameter
4B	Attack Time (AT)	0–99	Time to reach Attack Level after key pressed
	Attack Level (AL)	–99...+99	Amount of Cutoff Frequency change when Attack Time ends
	Decay Time (DT)	0–99	Time to reach Break Point once Attack Time ends
4C	Break Point (BP)	–99...+99	Amount of Cutoff Frequency change when Decay Time ends
	Slope Time (ST)	0–99	Time to reach Sustain Level once Decay Time ends
	Sustain Level (SL)	–99...+99	Amount of Cutoff Frequency change until key released
4D	Release Time (RT)	0–99	Time to reach Release Level when key released
	Release Level (RL)	–99...+99	Amount of Cutoff Frequency change once Release Time ends
4E	Color Intensity (Int)	0–99	Amount of color
	Color Velocity (Vel)	–99...+99	Color sensitivity to keyboard velocity

This VDF is basically a low-pass filter with a variable Cutoff Frequency parameter. It can be used to change the tonal quality of a Program. The VDF EG (Variable Digital Filter Envelope Generator) parameters allow you to determine how the Cutoff Frequency changes over time.

- 4A VDF Cutoff Frequency:** The Cutoff Frequency can be set from 0 to 99. As the value is reduced, high frequencies are filtered, thus producing a duller (softer) tone.

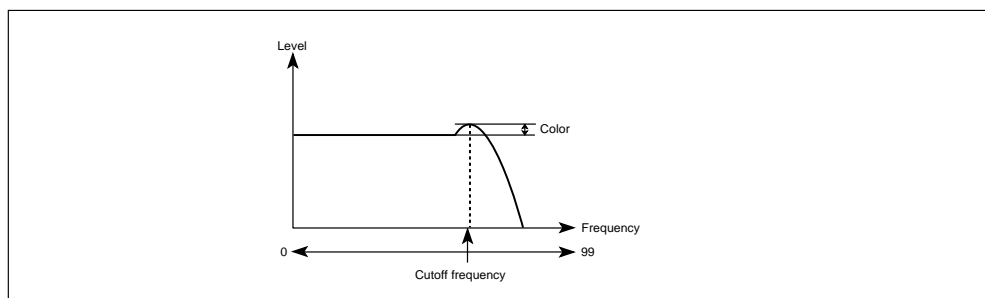

EG Intensity: This parameter determines the amount of control that the VDF EG exerts over the VDF Cutoff Frequency parameter. Basically, it sets the overall level of the VDF EG.

4B–4D VDF EG: The eight parameters on LCD screens 4B to 4D are used to set up the VDF EG. Level parameters specify the amount of VDF Cutoff Frequency change, and time parameters specify the time it takes to reach Cutoff Frequency changes relative to note on and note off. Positive values cause the Cutoff Frequency to increase, negative values cause it to decrease.

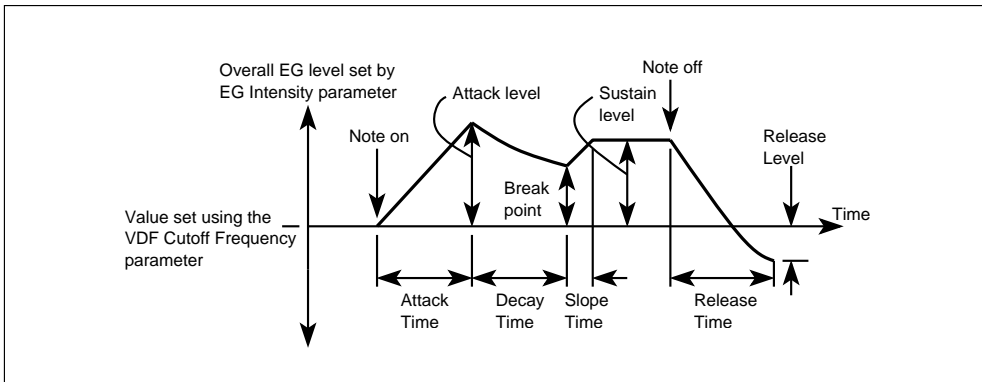

4E Color Intensity: By boosting the level around the Cutoff Frequency, the Color parameter adds character to a sound.

Color Velocity: This parameter determines how the color parameter responds to note velocity (as you play the keyboard more forcefully). For positive values, stronger playing will increase the amount of color. Negative values will have the opposite effect.

5A–5E VDF1 EG Velocity Sensitivity & Keyboard Tracking

VDF1 Velocity Sensitivity parameters determine how VDF1 EG responds to note velocity. The Keyboard Tracking parameters determine how different areas of the keyboard affect VDF1 cutoff and VDF1 EG.

05A VDF1 V.SENS ϕ EGint+77 EGtm00	05B VDF1 V.SENS ϕ AT0 DT0 ST0 RT0	05C VDF1 K.TRK ϕ KeyF#4 Mode= ALL	05D VDF1 K.TRK ϕ Int=+00 EGtm=00	05E VDF1 K.TRK ϕ AT0 DT0 ST0 RT0
5A	5B	5C	5D	5E

LCD	Parameter	Range	Description
5A	Velocity Sensitivity EG Intensity (EGint)	-99...+99	VDF1 EG Intensity parameter sensitivity to keyboard velocity
	Velocity Sensitivity EG Time (EGtm)	0-99	VDF1 EG Time parameter sensitivity to keyboard velocity
5B	Attack Time (AT)	-, 0, +	The direction in which VDF1 EG Time parameters are affected by keyboard velocity
	Decay Time (DT)	-, 0, +	
	Slope Time (ST)	-, 0, +	
	Release Time (RT)	-, 0, +	
5C	Keyboard Tracking Key (Key)	C-1 to G9	For Low and High keyboard tracking modes, the key from which keyboard tracking starts. For All mode, the key at which VDF Cutoff Frequency and VDF EG Time parameters are not affected
	Keyboard Tracking Mode (Mode)	OFF LOW HIGH ALL	No keyboard tracking Keyboard tracking below the specified key Keyboard tracking above the specified key Keyboard tracking over the entire keyboard
5D	Keyboard Tracking Intensity (Int)	-99...+99	VDF1 cutoff to keyboard tracking
	Keyboard Tracking EG Time (EGtm)	0-99	VDF1 EG Time parameter sensitivity to keyboard tracking
5E	Attack Time (AT)	-, 0, +	The direction in which VDF1 EG Time parameters are affected by keyboard tracking
	Decay Time (DT)	-, 0, +	
	Slope Time (ST)	-, 0, +	
	Release Time (RT)	-, 0, +	

- 5A Velocity Sensitivity EG Intensity:** This parameter determines how the VDF1 EG Intensity parameter is affected by note velocity. For positive values, smaller velocity value (soft playing) will reduce the value of the VDF1 EG Intensity parameter, strong playing will increase the value. Negative values will have the opposite effect.

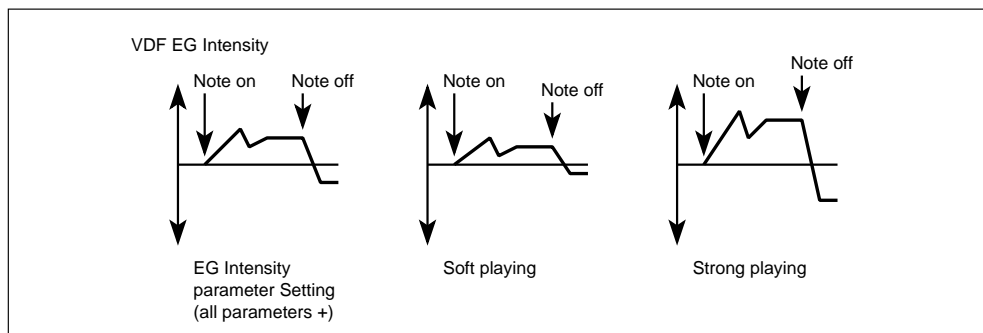

Note: This parameter does not affect the 4A VDF Cutoff Frequency parameter directly, it affects the EG Intensity parameter. So if the EG Intensity parameter, or all other VDF EG parameters are set to 0, it will have no effect.

Many acoustic instruments often produce less high-frequency energy when played softly. Soft playing produces a darker sound, while strong playing creates many high frequency harmonics that brighten the sound. This natural phenomenon can be simulated by setting the 4A VDF Cutoff Frequency parameter to a fairly low value, and the 4A VDF EG Intensity, 4C VDF EG Sustain Level, and 5A Velocity Sensitivity EG Intensity parameters to positive values.

Velocity Sensitivity EG Time: This parameter determines how the VDF1 EG Time parameters are affected by note velocity. It affects the VDF1 EG Attack, Decay, Slope, and Release Time parameters equally. Although, the direction of change can be set independently for each parameter.

5B Attack, Decay, Slope, Release Times: These parameters determine whether the VDF1 EG Time parameters are reduced or increased with changing note velocity as you play the keyboard more forcefully. For a negative (-) value, they are increased, for a positive (+) value reduced. A setting of 0 means no effect. The 5A Velocity Sence EG Time value is used for the amount of changes. In the following illustration, each parameter is set to positive.

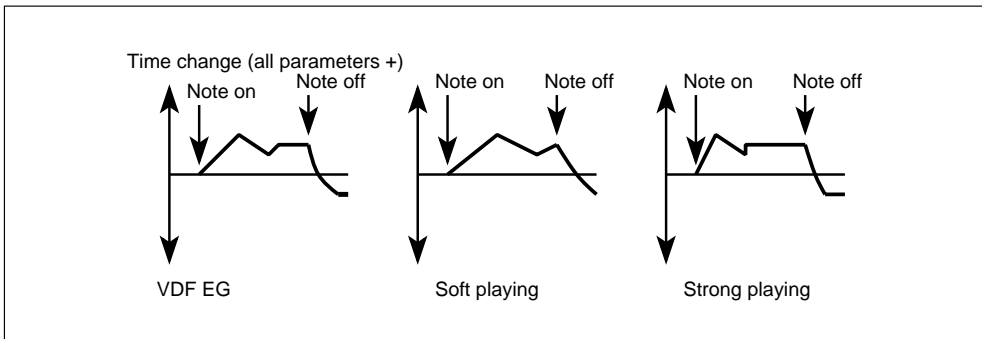

5C Keyboard Tracking Key: For Low and High keyboard tracking modes, this parameter specifies the key from which keyboard tracking starts. For All mode, it specifies the key around which keyboard tracking will take place. At the specified key, keyboard tracking will have no effect.

Keyboard Tracking Modes: Keyboard tracking determines how the VDF affects different areas of the keyboard. There are four Keyboard Tracking modes: Off, Low, High, and All. When Off is selected, there is no keyboard tracking and the Keyboard Tracking Intensity and Keyboard Tracking EG Time parameters are disabled. When Low is selected, keyboard tracking is active on keys below the specified Keyboard Tracking Key. When High is selected, keyboard tracking is active on keys above the specified Keyboard Tracking Key. When All is selected, keyboard tracking will be active across the entire keyboard.

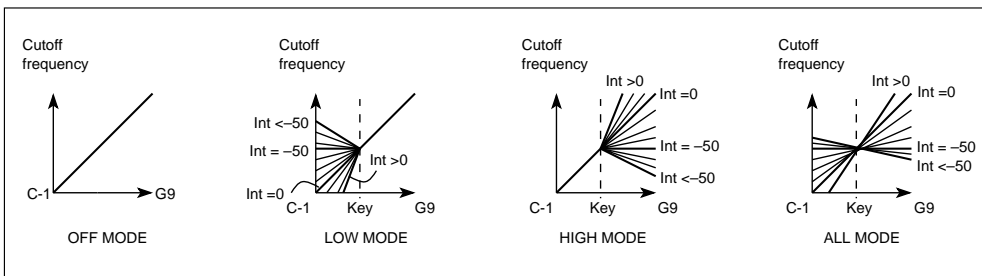

- 5D Keyboard Tracking Intensity:** This parameter determines keyboard tracking intensity for the specified keyboard area. Positive values will make high notes brighter. Negative values have the opposite effect. For a value of 0, the Cutoff Frequency changes linearly with regard to key pitch. For a value of -50 , the Cutoff Frequency is the same for all notes.

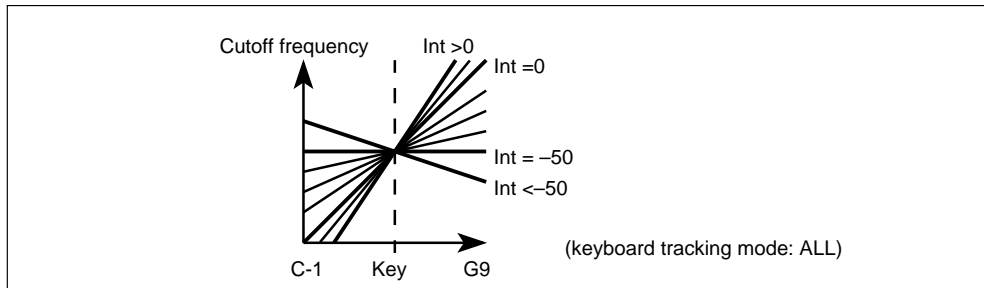

Keyboard Tracking EG Time: This parameter determines how the VDF1 EG Time parameters are affected by keyboard tracking. It affects the VDF1 EG Attack, Decay, Slope, and Release Time parameters equally. Although, the direction of change can be set independently for each parameter. The Keyboard Tracking mode and Key parameters can be used to specify the keyboard area that is affected.

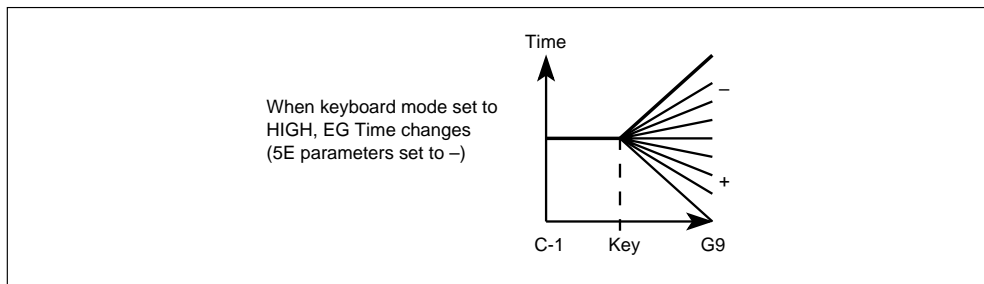

- 5E Attack, Decay, Slope, Release Times:** These parameters determine whether the VDF1 EG Time parameters are reduced or increased with keyboard tracking. For a negative ($-$) value, notes above the specified key will have their VDF EG times increased. For a positive ($+$) value, notes above the specified key will have their VDF EG times decreased. A setting of 0 means no effect.

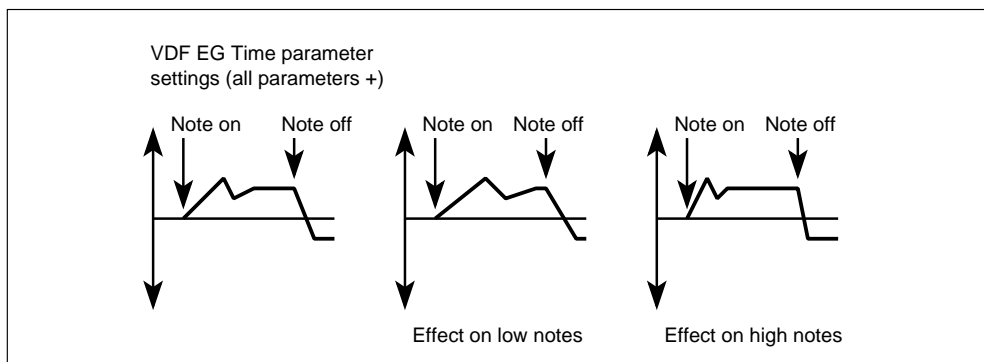

6A–6E VDF2 Cutoff, EG & Color

These parameters are used to set up the VDF (Variable Digital Filter) for Oscillator2. Operation is the same as for VDF1. See “4A–4E VDF1 Cutoff, EG & Color” on page 85.

06A VDF 2 Fc=19 EGint=65	06B VDF2 EG AT09 AL=08 DT00	06C VDF2 EG BP+00 ST00 SL+00	06D VDF2 EG RT00 RL+00	06E Color2 Int=00 Vel=+00
6A	6B	6C	6D	6E

7A–7E VDF2 Velocity Sense & Keyboard Tracking

VDF2 Velocity Sensitivity parameters determine how VDF2 EG responds to note velocity. The Keyboard Tracking parameters determine how different areas of the keyboard affect VDF2 and VDF2 EG. Operation is the same as for VDF1. See “5A–5E VDF1 EG Velocity Sensitivity & Keyboard Tracking” on page 87.

07A VDF2 V.SENS EGint+77 EGtm00	07B VDF2 V.SENS AT0 DT0 ST0 RT0	07C VDF2 K.TRK KeyF#4 Mode= ALL	07D VDF2 K.TRK Int=+00 EGtm=00	07E VDF2 K.TRK AT0 DT0 ST0 RT0
7A	7B	7C	7D	7E

8A–8C VDA1 EG

This determines how the volume of Oscillator1 varies over time.

08A VDA1 EG AT00 AL99 DT15	08B VDA1 EG BP20 ST88 SL00	08C VDA1 EG RT60
8A	8B	8C

LCD	Parameter	Range	Description
8A	Attack Time (AT)	0–99	Time to reach Attack Level after key pressed
	Attack Level (AL)	0–99	Volume level when Attack Time ends
	Decay Time (DT)	0–99	Time to reach Break Point once Attack Time ends
8B	Break Point (BP)	0–99	Volume level when Decay Time ends
	Slope Time (ST)	0–99	Time to reach Sustain Level once Decay Time ends
	Sustain Level (SL)	0–99	Volume level when Slope Time ends
8C	Release Time (RT)	0–99	Time to reach zero volume when key released

The following illustration shows how the VDA1 EG parameters affect the VDA (Variable Digital Amplifier).

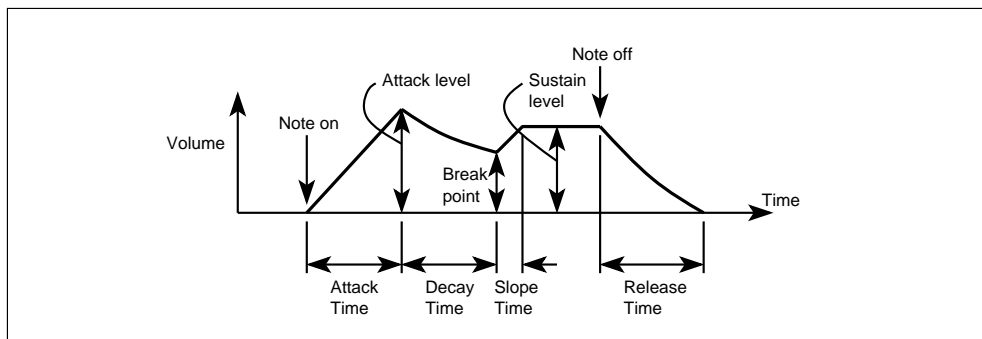

9A–9E VDA1 Velocity Sensitivity & Keyboard Tracking

VDA1 Velocity Sensitivity parameters determine how VDA1 EG responds to note velocity. The Keyboard Tracking parameters determine how different areas of the keyboard affect VDA1 and VDA1 EG.

09A VDA1 V.SENS ^ø Amp=+99 EGtm=00	09B VDA1 V.SENS ^ø AT0 DT0 ST0 RT0	09C VDA1 K.TRK ^ø KeyC#1 Mode= OFF	09D VDA1 K.TRK ^ø Amp=+00 EGtm=00	09E VDA1 K.TRK ^ø AT0 DT0 ST0 RT0
9A	9B	9C	9D	9E

LCD	Parameter	Range	Description
9A	Velocity Sensitivity Amplitude (Amp)	-99...+99	VDA1 EG sensitivity to note velocity
	Velocity Sensitivity EG Time (EGtm)	0-99	VDA1 EG Time parameter sensitivity to note velocity
9B	Attack Time (AT)	-, 0, +	The direction in which VDA1 EG Time parameters are affected by note velocity
	Decay Time (DT)	-, 0, +	
	Slope Time (ST)	-, 0, +	
	Release Time (RT)	-, 0, +	
9C	Keyboard Tracking Key (Key)	C-1 to G9	For Low and High keyboard tracking modes, the key from which keyboard tracking starts. For All mode, the key at which VDA1 EG parameters are not affected
	Keyboard Tracking Mode (Mode)	OFF LOW HIGH ALL	No keyboard tracking Keyboard tracking below the specified key Keyboard tracking above the specified key Keyboard tracking over the entire keyboard
9D	Keyboard Tracking Amplitude (Amp)	-99...+99	VDA1 EG sensitivity to keyboard tracking
	Keyboard Tracking EG Time (EGtm)	0-99	VDA1 EG Time parameter sensitivity to keyboard tracking
9E	Attack Time (AT)	-, 0, +	The direction in which VDA1 EG Time parameters are affected by keyboard tracking
	Decay Time (DT)	-, 0, +	
	Slope Time (ST)	-, 0, +	
	Release Time (RT)	-, 0, +	

9A Velocity Sensitivity Amplitude: This parameter determines how the overall level of VDA1 EG is affected by note velocity. For positive values, smaller velocity value (soft playing) will reduce the volume. For negative values it will increase the volume. In the following illustration, a positive value has been selected.

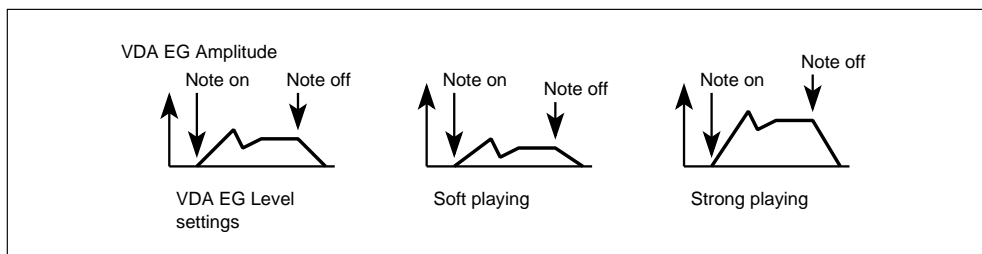

As the value approaches +99 or -99, difference between the maximum and minimum volume becomes larger.

By setting the Velocity Sensitivity Amplitude parameter for VDA1 to a positive value and the Velocity Sensitivity Amplitude parameter for VDA2 to a negative value when on oscillator mode is set to DOUBLE, a velocity crossfade effect can be achieved. This allows you to fade between two sounds as your playing changes from soft to strong and vice versa.

Velocity Sensitivity EG Time: This parameter determines how the overall level of VDA1 EG time parameters are affected by note velocity. It affects the VDA1 EG Attack, Decay, Slope, and Release Time parameters equally. Although, the direction of change can be set independently for each parameter.

9B Attack, Decay, Slope, Release Times: These parameters determine whether the VDA1 EG time parameters (9A) are reduced or increased with changing note velocity (as you play the keyboard more forcefully). For a negative (-) value, they are increased the stronger you play, for a positive (+) value they are reduced the stronger you play. In other words, for a positive setting, the stronger you play, the shorter the Attack, Decay, Slope, and Release times become. This is especially effective on string type Programs. In the following illustration, all parameters are set to positive.

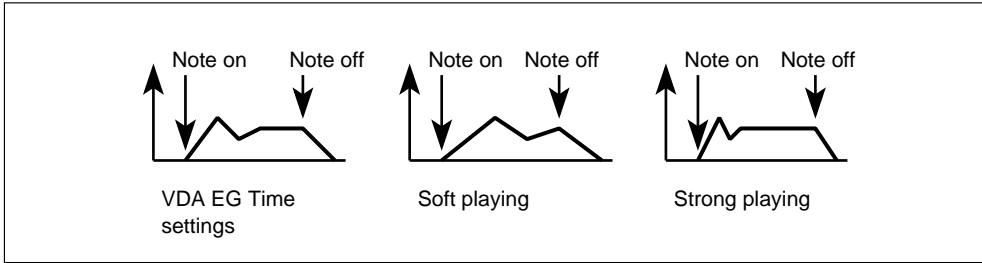

9C Keyboard Tracking Key: For Low and High keyboard tracking modes, this parameter specifies the key from which keyboard tracking starts. For All mode, it specifies the key around which keyboard tracking will take place. At the specified key, keyboard tracking will have no effect.

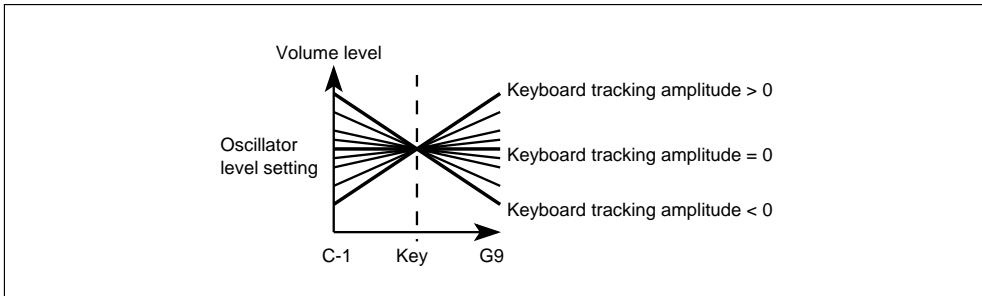

Keyboard Tracking Modes: Keyboard tracking determines how the VDA EG applies to different areas of a keyboard. There are four Keyboard Tracking modes: Off, Low, High, and All. When Off is selected, there is no keyboard tracking and the Keyboard Tracking Amplitude and Keyboard Tracking EG Time parameters are disabled. When Low is selected, keyboard tracking is active on keys below the specified Keyboard Tracking Key. When High is selected, keyboard tracking is active on keys above the specified Keyboard Tracking Key. When All is selected, keyboard tracking is active across the entire keyboard.

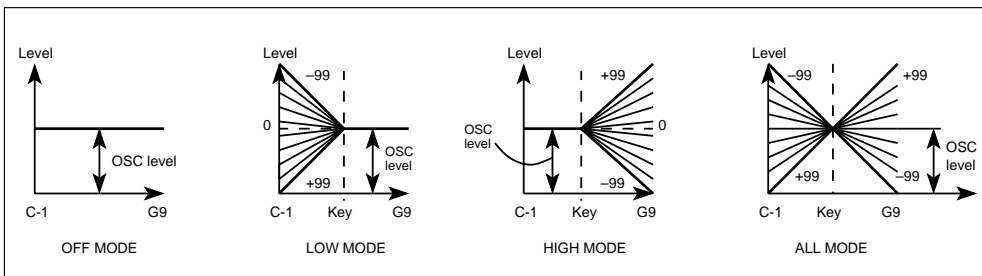

9D Keyboard Tracking Amplitude: This parameter determines keyboard tracking amplitude for the specified keyboard area. Positive values make high notes louder. Negative values have the opposite effect.

Keyboard Tracking EG Time: This parameter determines how the overall level of the VDA1 EG time parameters are affected by keyboard tracking. It affects the VDA1 EG Attack, Decay, Slope, and Release time parameters equally. Although, the direction of change can be set independently for each parameter. The Keyboard Tracking mode and Key parameters can be used to specify the keyboard area that is affected.

9E Attack, Decay, Slope, Release Times: These parameters determine whether the VDA1 EG Time parameters are reduced or increased with keyboard tracking. For a negative (-) value, notes above the specified key have their VDA EG times increased. For a positive (+) value, notes above the specified key have their VDA EG times decreased. In the following illustration, all parameters are set to positive.

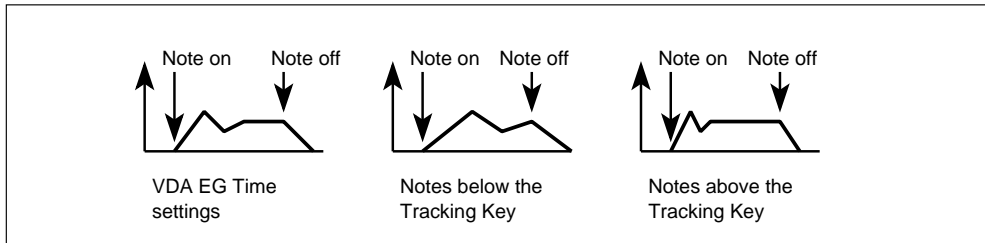

Creating a Positional Crossfade

You can specify a keyboard position at which one oscillator will fade out and the other will fade in. Set VDA1 (9C) and VDA2 (11C) to the same Keyboard Tracking Key, for example, C4, then set VDA1 (9D) to a positive Keyboard Tracking Amplitude value and VDA2 (11D) to a negative Keyboard Tracking Amplitude value. The following illustration shows this more clearly.

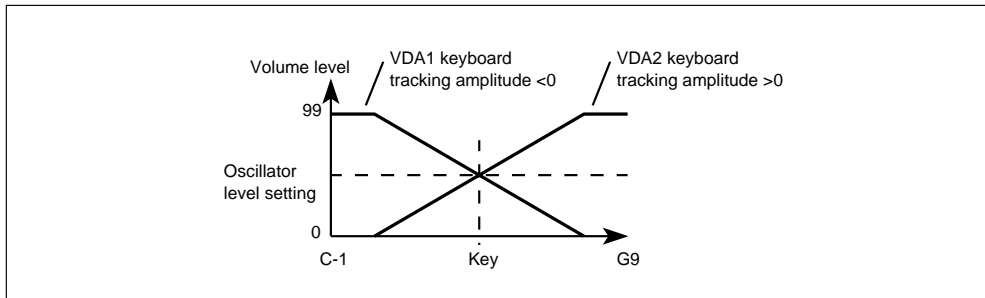

10A–10C VDA2 EG

This parameter determines how the volume of Oscillator2 varies over time. Operation is the same as for VDA1. See “8A–8C VDA1 EG” on page 90.

10A	VDA2 EG	10B	VDA2 EG	10C	VDA2 EG
AT00	AL99 DT15	BP20	ST88 SL00	RT60	
	10A		10B		10C

11A–11E VDA2 Velocity Sensitivity & Keyboard Tracking

VDA2 Velocity Sensitivity parameters determine how VDA2 EG responds to note velocity. The Keyboard Tracking parameters determine how different areas of the keyboard affect VDA2 EG. Operation is the same as for VDA1. See “9A–9E VDA1 Velocity Sensitivity & Keyboard Tracking” on page 91.

11A VDA2 V.SENS ϕ Amp=+99 EGtm=00	11B VDA2 V.SENS ϕ AT0 DT0 ST0 RT0	11C VDA2 K.TRK ϕ KeyC#1 Mode= OFF	11D VDA2 K.TRK ϕ Amp=+00 EGtm=00	11E VDA2 K.TRK ϕ AT0 DT0 ST0 RT0
11A	11B	11C	11D	11E







12A–12E Pitch1 Modulation

These parameters allow you to modulate the pitch of Oscillator1 periodically. Modulation frequency and intensity can also be controlled using After Touch and MIDI controller1.

12A PITCH 1 MG ϕ TRI Frq00 Int00	12B PITCH 1 MG ϕ Delay00 FadeIn00	12C PITCH 1 MG ϕ K.Sync:OFF	12D PMG1 FREQ ϕ K.TRK+00 A+J=0	12E PMG1 INT ϕ Aft=00 JoyUP=00
12A	12B	12C	12D	12E

LCD	Parameter	Range	Description
12A	Waveform	TRI SAW \uparrow SAW \downarrow SQR1 RAND SQR2	Triangle Sawtooth \uparrow Sawtooth \downarrow Square1 Random Square2
	Frequency (Frq)	0–99	Modulation Speed
	Intensity(Int)	0–99	Modulation Intensity
12B	Delay (Delay)	0–99	Time from key press to modulation start
	Fade In Time (FadeIn)	0–99	Rate at which modulation reaches specified Intensity
12C	Keyboard Sync (K.Sync)	OFF ON	Modulation will continue for subsequent notes Modulation will restart for each new note
12D	Frequency Keyboard Tracking (K.TRK)	–99...+99	Modulation sensitivity to keyboard tracking
	Frequency After Touch & Joystick (A+J)	0–9	Modulation frequency control by After Touch and Controller1
12E	After Touch Modulation Intensity (Aft)	0–99	Modulation intensity controlled by After Touch
	Joystick Modulation Intensity (JoyUp)	0–99	Modulation intensity controlled by the Controller1

12A Waveform: This parameter selects the type of modulation waveform.

Triangle		Square1	
Sawtooth \uparrow		Random	
Sawtooth \downarrow		Square2	

When in Square1 is selected, the pitch changes between normal pitch and high pitch. In other waveforms, it changes between high and low.

Frequency: This parameter determines the modulation frequency (speed).

Intensity: This parameter determines the modulation intensity (depth).

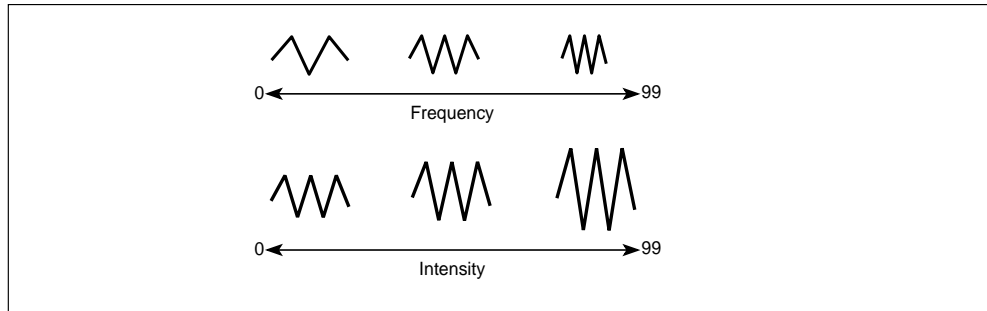

12B Delay: This parameter determines how long after a key press modulation starts.

Fade In time: This parameter specifies the time it takes modulation to reach maximum intensity.

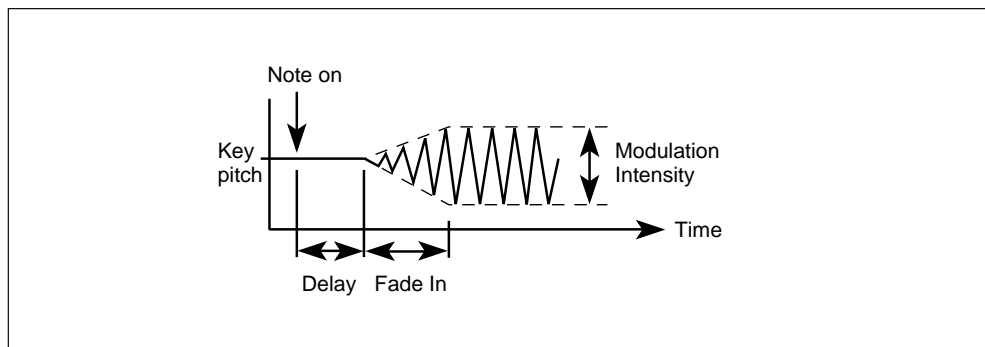

12C Keyboard Sync: Determines how subsequent notes are affected by modulation. For a setting of OFF, modulation is applied to subsequent notes in the same way that it is currently being applied to notes that are already held down. That is, subsequent notes will not be affected by the Delay and Fade In Time settings. For a setting of ON, modulation restarts for each new note.

12D Frequency Keyboard Tracking: Keyboard tracking determines how modulation affects different areas of the keyboard. For positive values, the modulation frequency will increase as higher notes are played. For negative values, the modulation frequency will decrease as higher notes are played.

When Keyboard Sync is set to OFF, the modulation speed is determined by the position of the first key pressed. When keyboard tracking is set to +99, playing a key 1 octave higher will double the modulation speed. When the oscillator Octave parameter is set to 8', key C4 is the keyboard tracking center key.

Frequency After Touch & Joystick: This parameter specifies how much the modulation frequency will be increased in response to After Touch and Pitch Modulation MIDI Controller 1.

12E After Touch Modulation Intensity: This parameter determines to what extent After Touch affects the modulation intensity.

Joystick Modulation Intensity: This parameter determines to what extent MIDI Controller 1 affects the modulation intensity. Moving the joystick on a connected keyboard such as the X3 in the direction of +Y will cause MIDI Controller #1 to be sent.

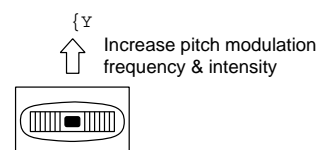

13A–13E Pitch2 Modulation

These parameters allow you to modulate the pitch of Oscillator2 periodically. Modulation frequency and intensity can also be controlled using After Touch and Pitch Modulation MIDI Controller1. Operation is the same as for Pitch1 Modulation. See “12A–12E Pitch1 Modulation” on page 94.

13A PITCH 2 MG SAW Frq00 InT00	13B PITCH 2 MG Delay00 FadeIn00	13C PITCH 2 MG K.Sync:OFF	13D PMG2 FREQ K.TRK+00 A+J=0	13E PMG2 INT Aft=00 JoyUP=00
13A	13B	13C	13D	13E

14A–14C VDF Modulation

These parameters allows you to modulate the Cutoff Frequency of VDF1, VDF2, or both.

14A VDF MG TRI Frq00 Int00	14B VDF MG Delay00 OSC= OFF	14C VDF MG K.Sync:OFF
14A	14B	14C

LCD	Parameter	Range	Description
14A	Waveform	TRI SAW↑ SAW↓ SQR1 RAND SQR2	Triangle Sawtooth ↑ Sawtooth ↓ Square1 Random Square2
	Frequency (Frq)	0–99	Modulation Speed
	Intensity (Int)	0–99	Modulation Intensity
14B	Delay	0–99	Time from note-on to modulation start
	Oscillator Select (OSC)	OFF OSC1 OSC2 BOTH	Modulation off Modulation for VDF1 Modulation for VDF2 modulation for VDF1 and VDF2
14C	Keyboard Sync (K.Sync)	OFF ON	OFF: modulation will continue for subsequent notes ON: modulation will restart for each new note

These parameters are the same as those for Pitch MG, except that the Fade In Time parameter is not included here. The fade in time changes according to the Delay setting.

14A Waveform: This parameter selects the type of modulation waveform.

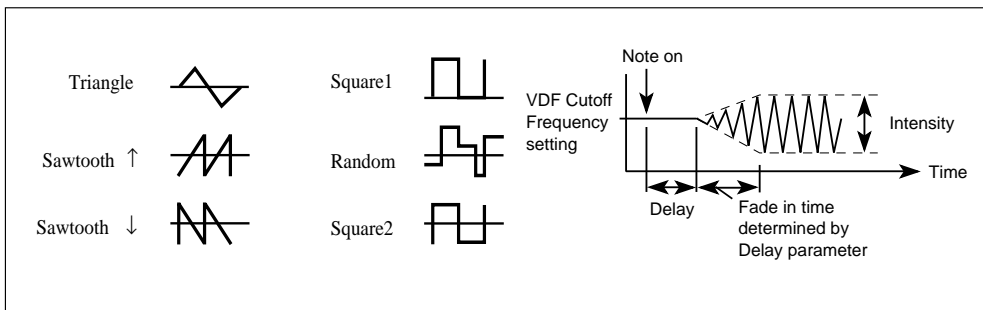

Note: When Square 1 is selected and the filter is completely open, the Cutoff Frequency does not change.

Frequency: This parameter sets the modulation speed.

Intensity: This parameter sets the modulation intensity.

14B Delay: Determines time from note-on to modulation start.

Oscillator Select: This parameter allows you to apply modulation to VDF1, VDF2, or both.

14C Keyboard Sync: Determines how subsequent notes are affected by modulation. For a setting of OFF, modulation is applied to subsequent notes in the same way it is currently being applied to notes that are already held down. That is, subsequent notes (or Note On message) will not be affected by the Delay parameter. For a setting of ON, modulation restarts for each new note.

15A–15D After Touch & Joystick Control

These parameters determine how a Program responds to After Touch, VDF Modulation MIDI Controller2 and Pitch Bender.

15A AFT CTRL P.Bend+12 Fc+00	15B AFT CTRL VDF.MG00 Amp+00	15C J.STK Down VDF.MG=99	15D BEND CTRL P.Bend+00 VDF+00
15A	15B	15C	15D

LCD	Parameter	Range	Description
15A	After Touch Pitch Bend (P.Bend)	-12...+12	After touch pitch bend range
	After Touch VDF Cutoff Frequency (Fc)	-99...+99	VDF Cutoff Frequency sensitivity to After Touch
15B	After Touch VDF MG Intensity (VDF.MG)	0-99	VDF modulation sensitivity to After Touch
	After Touch VDA Amplitude (Amp)	-99...+99	VDA1 sensitivity to After Touch
15C	Joystick VDF MG Intensity (VDF.MG)	0-99	VDF modulation sensitivity to the VDF Modulation MIDI Controller2
15D	Joystick Pitch Bend Range (P.Bend)	-12...+12	Pitch bend range and direction
	Joystick VDF Sweep Intensity (VDF)	-99...+99	VDF modulation sensitivity to the VDF Modulation MIDI Controller Pitch Bender

15A After Touch Pitch Bend: This parameter determines the After Touch pitch bend range (within ± 1 octave).

After Touch VDF Cutoff Frequency: This parameter determines how the VDF Cutoff Frequency responds to After Touch. For positive values, After Touch increases the Cutoff Frequency, thus making the sound brighter. Negative values have the opposite effect. For this parameter to have any affect, you must set the VDF Cutoff Frequency to something other than 99.

15B After Touch VDF MG Intensity: This parameter determines how VDF modulation responds to After Touch. When After Touch is applied, the VDF Cutoff Frequency is modulated. (see “14A–14C VDF Modulation” on page 96.)

After Touch VDA Amplitude: This parameter determines how the VDA responds to After Touch. In other words, how After Touch affects the volume of Oscillator1. For positive values, increasing After Touch (pressing down on a held key) increases the volume. Negative settings have the opposite effect.

15C Joystick VDF MG Intensity: This parameter determines how VDF modulation responds to the joystick (Pitch Modulation MIDI Controller2). When you pull the joystick on a keyboard (such as the X3) connected to MIDI IN in direction of $-Y$, MIDI Controller 2 is sent to the X5DR, and the VDF Cutoff Frequency on the X5DR is modulated. (see “14A–14C VDF Modulation” on page 96.)

15D Joystick Pitch Bend Range: This parameter determines the pitch bend range (± 1 octave) and pitch bend direction. For positive values, the pitch increases as you turn the joystick on a keyboard (such as the X3) connected to MIDI IN to the right. For negative values, the pitch decreases.

Joystick VDF Sweep Intensity: This parameter determines how the VDF Cutoff Frequency responds to pitch bend. For positive values, the Cutoff Frequency increases as you turn the joystick to the right. For negative values, the Cutoff Frequency decreases.

Any value other than 0

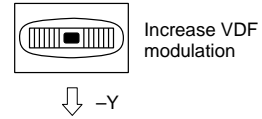

With a positive value

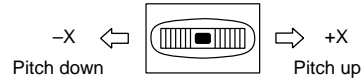

With a positive value

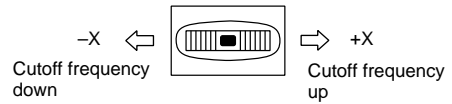

16A–21A Effects

Effects are explained fully in “Effect Parameters” on page 115.

Effects settings made in Program Edit mode only apply to Programs in Program Play mode and Program Edit mode. They do not apply when Programs are used in Combinations or in Multi setup. Effect settings for Programs used in Combinations are set in Combination Edit mode. For Programs used in Multi setup, they are set in Multi mode.

Program parameters Pan A, Pan B, Send C, and Send D are used to control the levels of the oscillator signals sent to the effects.

When you’ve edited a Program’s effect settings, always remember to write the Program. Otherwise, the settings will be lost when you select another Program.

22A–22B Program Write & Rename

When you’ve edited a Program’s effect settings, always remember to write the Program. Otherwise, the settings will be lost when you select another Program.

This function allows you to write a Program to Program bank A. This function can also be used to reorganize Program numbering by writing Programs to different destinations. You cannot write to the G bank. You can also rename Programs.

22A PROG WRITE Write: 00 OK?	22B RENAME 00:Ephemerals
---------------------------------	-----------------------------

22A

22B

LCD	Parameter	Range	Description
22A	Write→xx	00–99	Select the Program write destination
	OK to Write	OK?	Executes Program write
22B	Rename	See character table below	Rename a Program

22A Program Write:

Note: To write a Program, the Program Memory Protection function must be set to OFF. See “3A – 3C Program/Combination Memory Protect & Page Memory” on page 153.

To write a Program, specify the write destination, position the cursor on OK?, then press the [▲] button. The message “Are You Sure OK?” will appear. Press the [▲] button to write the Program, or the [▼] button to cancel. If you write the Program, the destination Program will be selected automatically. When the Write operation is completed, the screen displays “Completed.” To return to the previous screen, press the [▲] button or the [▼] button.

Note: The Program that already exists at the selected write destination will be lost when you execute the Program Write function.

22B Rename: This function allows you to rename Programs.

To rename a Program, use the [√] and [Ⓜ] cursor buttons to position the cursor, and the [▲] and [▼] buttons to select characters. Available characters are shown in the table below. Program names can be up to 10 characters.

!	"	#	\$	%	&	'	()	*	+	,	-	.	/	0	1	2	3	4	5	6	7	8	9	:	;	<	=	>	?	
@	A	B	C	D	E	F	G	H	I	J	K	L	M	N	O	P	Q	R	S	T	U	V	W	X	Y	Z	[%]	^	_
	a	b	c	d	e	f	g	h	i	j	k	l	m	n	o	p	q	r	s	t	u	v	w	x	y	z	()	‡	†	

2. COMBINATION Parameters

Functions in COMBINATION mode

Key operations:

Selecting a page [PAGE+] key, [PAGE-] key

Selecting a parameter [√] key, [Ⓜ] key

Setting a parameter value [▲] key, [▼] key

Page	Function	Parameter to EDIT
0A – 0B	Program	The Program assigned to each Timbre
1A – 1B	Level	Volume of each Timbre
2A – 2B	MIDI Channel	The MIDI receive channel of each Timbre
3A – 3D	Key Window Top Key Window Bottom	Top key of keyboard range played by each Timbre Bottom key of keyboard range played by each Timbre
4A – 4D	Vel Window Top Vel Window Bottom	Maximum value of velocity for each Timbre Minimum value of velocity for each Timbre
5A – 5D	Transpose Detune	Transpose setting of each Timbre Detune setting of each Timbre
6A – 6D	Program Change Filter Damper Switch Filter After Touch Filter Control Change Filter	Program Change message receive switch for each Timbre Damper Switch message receive switch for each Timbre Aftertouch message receive switch for each Timbre Control Change message receive switch for each Timbre
7A – 7B	Panpot	Panpot between A and B of each Timbre
8A – 8B	Send	C, D output level of each Timbre
9A – 14A		Effect settings
15A – 15B	Write Combination Rename Combination	Write a Combination into memory Rename a Combination

On pages 0 to 8, if you move to a different page while a Timbre is selected, the same Timbre will be selected again.

See “Effect Parameters” on page 115.

0A, 0B Program Select

These parameters allow you to assign Programs to Timbres.

Timbres 1–4 Timbres 5–8

00A PROGRAM 1-4 \emptyset	00B PROGRAM 5-8 \emptyset
A00 A01 A02 A03	A04 G01 G99 128
0A	0B

LCD	Parameter	Range	Description
0A	Timbre 1–4 Program Select	OFF, A00–A99	Assign a Program to a Timbre
0B	Timbre 5–8 Program Select	G01–136	

Here you can select a Program for each Timbre.

The Timbre that is set to “OFF” will not sound.

A Program must be selected from Bank A and G.

Incoming Program Change messages will select Programs for Timbres of the corresponding channel.

However, if the MIDI channel of the received Program Change is the same as the Global MIDI channel of the X5, the Combination will change.

To avoid changing the Combination via MIDI, set the 2C MIDI FILTER PRG in the Global Mode to “PRG”. To change only the number, without changing the bank, set the Program to “NUM”.

To see how the various timbres correspond to the MIDI Bank Select and Program Change functions, please refer to the related section on page 66, 68, 77, 104, 153 and 172.

Programs available

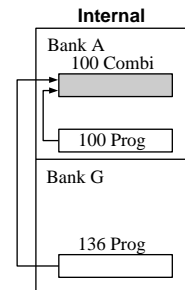

1A, 1B Level

These parameters allow you to set the volume level of each Timbre in a Combination.

Timbres 1–4 Timbres 5–8

01A LEVEL 1-4 \emptyset	01B LEVEL 5-8 \emptyset
127 099 011 127	055 127 127 127
1A	1B

LCD	Parameter	Range	Description
1A	Timbre 1–4 Level	0–127	Sets the volume level of each Timbre
1B	Timbre 5–8 Level		

With a value of 127, the volume uses the level setting of the Timbre program parameter. With a value of 0, no sound is output.

The volume level is determined by this parameter multiplied by the value set for MIDI Volume Controller No. 7, or Expression Controller No. 11.

2A, 2B MIDI Channel

These parameters allow you to set the MIDI Channel that each Timbre uses to receive MIDI data.

Timbres 1-4				Timbres 5-8			
02A	MIDI	CH	1-4 ^ø	02B	MIDI	CH	5-8 ^ø
1G	2	3	4	5	6	7	8
2A				2B			

LCD	Parameter	Range	Description
2A	Timbre 1-4 MIDI Channel	1-16	Sets the MIDI Channel that each Timbre uses to receive MIDI data
2B	Timbre 5-8 MIDI Channel		

If you want to play a Combination from the keyboard (such as the X3), you should set each Timbre's MIDI Channel on the X5 so that it matches X3's MIDI transmit Channel. If you are using a MIDI sequencer, set each Timbre's MIDI Channel so that it matches the corresponding sequencer track's MIDI channel. This allows you to use the X5 as an 8-part multitimbral tone generator.

If the selected MIDI Channel is the same as the Global MIDI Channel, a G will appear next to the selected channel number.

MIDI Program Change messages received on the corresponding MIDI channel can be used to select Programs. However, if the Timbre's MIDI Channel is the same as the Global MIDI Channel, a program change sent on it's channel will change the Combination.

If you do not wish to change the Combination, set the Global MIDI Channel to any channel that is not used for the Timbre, or set the 2C MIDI FILTER PRG parameter in Global mode to "PRG". (see page 152.)

3A-3D Key Window Top & Bottom

These parameters allow you to set the top and bottom notes for each Timbre's key window.

Timbres 1-4				Timbres 5-8				Timbres 1-4				Timbres 5-8			
03A	KW	TOP	1-4 ^ø	03B	KW	TOP	5-8 ^ø	03C	KW	BTM	1-4 ^ø	03D	KW	BTM	5-8 ^ø
G9	G9	G9	G9	B4	G9	G9	G9	C-1	C-1	C-1	C-1	C-1	C-1	C-1	C-1
3A				3B				3C				3D			

LCD	Parameter	Range	Description
3A	Timbre 1-4 Key Window Top	C-1 to G9	Specifies the top note for each Timbre's key window
3B	Timbre 5-8 Key Window Top		
3C	Timbre 1-4 Key Window Bottom		Specifies the bottom note for each Timbre's key window.
3D	Timbre 5-8 Key Window Bottom		

A key window is the range of keys (notes) that can be used to play a Timbre. Used in conjunction with the Key Window Bottom parameters, you can designate sections of a keyboard to certain Timbres. For example, you could designate the bottom half of a keyboard to a bass Timbre, and the top half to a piano Timbre. In the example shown below, Timbres 1 and 2 have been designated their own key windows, while the key window for Timbres 3 and 4 have been set the same.

You can not set the top key to lower than the bottom key. Otherwise, the bottom key will be set to the same value as the top key. The same thing applies to the bottom Key.

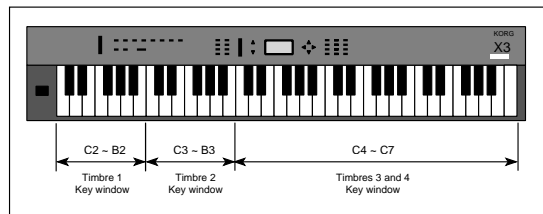

4A–4D Velocity Window Top & Bottom

These parameters allow you to set the maximum and minimum velocities for each Timbre's velocity window. This note range can be used to play according to how forcefully you play a keyboard connected to MIDI IN (such as the X3).

Timbres 1–4				Timbres 5–8				Timbres 1–4				Timbres 5–8			
04A	VW	TOP	1-4	04B	VW	TOP	5-8	04C	VW	BTM	1-4	04D	VW	BTM	5-8
127	127	127	127	127	127	127	127	001	001	001	001	001	001	001	001
4A				4B				4C				4D			

LCD	Parameter	Range	Description
4A	Timbre 1–4 Velocity Window Top	1–127	Specifies the maximum velocity for each Timbre's Velocity window
4B	Timbre 5–8 Velocity Window Top		
4C	Timbre 1–4 Velocity Window Bottom		Specifies the minimum velocity for each Timbre's Velocity window
4D	Timbre 5–8 Velocity Window Bottom		

A velocity window determines the note velocity range that can be used to play a Track. You can use the Velocity Window Top/Bottom parameters to specify a note velocity range for each Track. For example, you could set a soft strings Track to a low velocity window, and a hard strings Track to a high velocity window. Then, soft playing will play the soft strings, and stronger playing will play the hard strings. This technique is called velocity switch. You can also set the velocity windows so that their ranges overlap. This is called velocity layering.

5A–5D Transpose & Detune

These parameters allow you to transpose and detune Timbres.

Timbres 1–4				Timbres 5–8				Timbres 1–4				Timbres 5–8			
05A	TRANS	1-4	ø	05B	TRANS	5-8	ø	05C	DETUNE	1-4	ø	05D	DETUNE	5-8	ø
+00	+07	+00	+00	+00	+00	+00	+00	+00	+03	+00	+00	+00	+00	+00	+00
5A				5B				5C				5D			

LCD	Parameter	Range	Description
5A	Timbre 1–4 Transpose	–24...+24	Transpose Timbre in semitone steps
5B	Timbre 5–8 Transpose		
5C	Timbre 1-4 Detune	–50...+50	Detune each Timbre in one cent steps
5D	Timbre 5–8 Detune		

5A, 5B Transpose: It adjusts each Timbre's pitch in the range of –24...+24 in semitone steps. (12 = octave).

5C, 5D Detune: It sets each Timbre's pitch in cent steps in the range of –50...+50 (100 cents = semitone).

6A–6D MIDI Filter

These parameters allow you to control how the X5 will handle MIDI data.

Timbres 1–8			Timbres 1–8			Timbres 1–8			Timbres 1–8		
06A	PROG CHANGE	E E D D E E E E	06B	DAMPER	E E E E E E E E	06C	AFTER TOUCH	E E E E E E E E	06D	CONTROL CHG	E E E E E E E E
6A			6B			6C			6D		

LCD	Parameter	Range	Description
6A	Timbre 1–8 Program Change Filter	D: Disable E: Enable	Program Change messages ignored Program Change messages can be received and sent
6B	Timbre 1–8 Damper Pedal Filter	D: Disable E: Enable	Timbre will ignore the damper pedal Timbre will respond to the damper pedal
6C	Timbre 1–8 After Touch Filter	D: Disable E: Enable	Timbre will ignore After Touch Timbre will respond to After Touch
6D	Timbre 1–8 Control Change Filter	D: Disable E: Enable	Timbre will ignore controllers Timbre will respond to controllers

6A Program Change Filter: These parameters determine how EXT mode Timbres work with MIDI Program Change messages.

Enable: With this setting, received Program Change messages select Programs for a Timbre.

Use 2C MIDI FILTER PRG in Global mode to set the global X5DR Program Change filter. (see 2C Program Change Filter on page 152.)

Note: *If the Global mode 2C MIDI Program Change Filter1 is set to DIS (“2C MIDI FILTER PRG” on page 152), Program Change messages are completely disabled. This setting overrides the above settings. Furthermore, if the channel that matches Global mode MIDI Program Change Filter1 is set to ENA, Program Change messages received on the Global MIDI Channel will select Combinations. With the PRG setting, Combinations are not changed. Only the Programs that have Timbres with the same channel settings are changed.*

6B Damper Pedal Filter: These parameters determine how Timbres respond to damper pedal message.

Enable: With this setting, Timbres respond to damper pedal messages.

Disable: With this setting, damper pedal messages are ignored.

6C After Touch Filter: These parameters determine how Timbres respond to After Touch messages.

Enable: With this setting, Timbres respond to After Touch messages.

Disable: With this setting, After Touch message is ignored.

6D Control Change Filter: These parameters determine whether Timbres respond to MIDI Controllers.

Enable: With this setting, Timbres respond to controllers.

Disable: With this setting, controllers are ignored.

7A, 7B Panpot

These parameters allow you to pan the output of each Timbre between buses A and B. These buses feed the effects processors. See “20A–20B Effect Placement” on page 117.

Timbres 1–4				Timbres 5–8			
07A	PANPOT	1-4	ø	07B	PANPOT	5-8	ø
A12	PRG	B	9	CNT	PRG	CNT	PRG
7A				7B			

LCD	Parameter	Range	Description
7A	Timbre 1–4 Panpot	OFF, A15–CNT–B15, PRG	Pans the outputs of each Timbre between buses A and B
7B	Timbre 5–8 Panpot		

OFF: Nothing is output to buses A and B.

A15–CNT–B15: You can set different output levels for buses A and B. For a setting of A15, Timbre output is to bus A only. For a setting of B15, to bus B only. And for a setting of CNT, equally to buses A and B. The Pan setting for each Oscillator set in Program Edit mode is ignored, and both Oscillator 1 and Oscillator 2 will use the Pan setting determined here.

PRG: When this setting is selected, the pan settings that have been set for a Program in Program Edit mode are used. See “1A–1D Oscillator1 Setup” on page 80 and “2A–2F Oscillator2 Setup” on page 82.

If a Program is using a drum kit, the pan settings for each drum sound will be used when PRG is selected. See “6A–6D Drum Kit1 Setup” on page 158 and “7A–7D Drum Kit2 Setup” on page 160.

For a setting other than OFF or PRG, these parameters can be controlled using MIDI Pan Controller No. 10. See “MIDI Panpot, Send Data” on page 173 for details about the relationship between pan value and MIDI Controller value.

8A, 8B Send C & Send D

These parameters allow you to set the output level of each Timbre sent to buses C and D. These buses feed the effects processors. See “20A–20B Effect Placement” on page 117.

Timbres 1–4				Timbres 5–8			
08A	SENDCD	1-4	ø	08B	SENDCD	5-8	ø
9:0	0:9	5:5	5:5	5:5	5:5	0:0	P:P
8A				8B			

LCD	Parameter	Range	Description
8A	Timbre 1–4 Send C Timbre 1–4 Send D	0–9, P	Sets the output level of each Timbre sent to buses C and D
8B	Timbre 5–8 Send C Timbre 5–8 Send D		

0–9: When a Program is used in a Combination, its Send C and Send D parameters are ignored, and these settings are active. Oscillators 1 and 2 use the same settings. Likewise, when the Program is set to DRUM mode, the Send C and Send D settings of the individual drums within the kit are ignored, and these settings are active.

P: When this setting is selected, the Send C and Send D settings that have been set for a Program in Program Edit mode are used. See “1A–1D Oscillator1 Setup” on page 80 and “2A–2F Oscillator2 Setup” on page 82. If a Program is using a drum kit, the settings for each drum sound will be used. See “6A–6D Drum Kit1 Setup” on page 158 and “7A–7D Drum Kit2 Setup” on page 160.

For settings from 0–9, the Send C parameters can be controlled using MIDI Reverb Level Controller No. 91. MIDI Chorus Level Controller No. 93 can be used to control Send D.

See “MIDI Panpot, Send Data” on page 173 for details about the relationship between send value and MIDI Controller value.

9A–14A Effects

In a Combination the individual effect settings of each Program are ignored, and the settings for that Combination are used. If you want to use a Program’s effect settings for a Combination, use Effects Copy14A COPY EFF. See “21A Copy Effects” on page 119.

Effects are explained in 4. “Effect Parameters” on page 115.

Combination parameters Pan A, Pan B, Send C, and Send D are used to control the levels of the Timbres sent to the effects.

When you’ve edited a Combination’s effects settings, always remember to write the Combination. Otherwise, the settings will be lost when you select another Combination.

15A, 15B Combination Write & Rename

This function allows you to write a Combination to the internal memory. This function can also be used to reorganize Combination numbering by writing Combinations to different destinations. (The Combination that exists at destination will be lost when another Combination overwrites it.)

The Rename function allows you to name the Combination.

15A COMB WRITE Write: 00 OK?	15B RENAME 00:Organ
15A	15B

LCD	Parameter	Range	Description
15A	Write→xxx	00–99	Select the Combination write destination
	OK to Write	OK?	Executes write
15B	Rename	See character table below	Rename a Combination

15A Combination Write:

Note: To write a Combination, the Combination Memory Protection function must be set to OFF. See “3B Combination Memory Protect” on page 153.

To write a Combination, specify the write destination, position the cursor on OK?, then press the [▲] button. The message “Are You Sure OK?” will appear. Press the [▲] button to write the Combination, or the [▼] button to cancel. If you write the Combination, the destination Combination will be selected automatically. When the write operation is completed, the display shows “Completed.” Press the [▲] button or the [▼] button to return to the previous screen.

Note: The Combination that already exists at the selected write destination will be lost when you execute this function.

15B Rename: This function allows you to rename Combination.

Move the cursor to the desired character using the [√] and [®] buttons, and use the [▲] and [▼] buttons to enter the character. You can use the characters listed below. Up to 10 characters can be used for a Combination name.

	!	"	#	\$	%	&	'	()	*	+	,	-	.	/	0	1	2	3	4	5	6	7	8	9	:	;	<	=	>	?
@	A	B	C	D	E	F	G	H	I	J	K	L	M	N	O	P	Q	R	S	T	U	V	W	X	Y	Z	[%]	^	_
	a	b	c	d	e	f	g	h	i	j	k	l	m	n	o	p	q	r	s	t	u	v	w	x	y	z	()	‡	†	

3. Multi Setup Parameters

Multi Setup Functions

Key operations:

Selecting a page [PAGE+] key, [PAGE-] key

Selecting a parameter [√] key, [Ⓜ] key

Setting a parameter value [▲] key, [▼] key

Refer to “Effect Parameters” on page 115 for detailed information on effects.

Page		Function	Parameter to edit
0A–0G (Track 1 setting)	*A	Program	Program of each Track
	*B	Level	Volume of each Track
		Panpot	Pan setting (A/B output balance) of each Track
		Send C	Track level at output C
		Send D	Track level at output D
	*C	Transpose	Transpose setting of each Track
Detune		Detune setting of each Track	
Pitch Bend Range		Pitch bend range of each Track	
*D	Program Change Filter	Program Change messages reception switch for each Track	
	Damper Switch Filter	Damper messages reception switch for each Track	
	After Touch Filter	After Touch messages reception switch for each Track	
	Control Change Filter	Control Change messages reception switch for each Track	
*E	Key Window Top	Top key of the Track note range	
	Key Window Bottom	Bottom key of the Track note range	
15A–15G (Track 16 setting)	*F	Vel Window Top	Maximum velocity of each Track
		Vel Window Bottom	Minimum velocity of each Track
	*G	MIDI Channel	MIDI receive channel of each Track
16A–21A		Effect	Effect setting
22A		Copy from Combination	Copy from Combinations
23A		Set to GM	Initialize for GM

* 0–15 correspond to Tracks 1–16.

In Multi mode, pages 0–15 correspond to Tracks 1–16; pages 16–21 handle effect settings; page 22 enables you to copy parameters from Combinations; page 23 is used for GM settings.

When you select a different Track while editing a particular parameter (for one of the 16 Tracks in pages 0–15), the same parameter of the new Track is automatically selected.

- Multi mode settings are lost when you turn off the power to the X5DR. When you turn on the power to the X5DR, all settings in Multi mode are reset to GM-compatible data. (see page 114.)
- Save Multi mode settings to an external storage device such as a MIDI data filter using 4A MIDI DUMP in Global mode (see page 154). In Multi mode, all data is compatible between the X5DR and the X5, but only effect data is compatible between the X5DR and the 05R/W.

*A Program

This page allows you to select a Program for each Track.

00A MULTI T01 ϕ G01:Piano

*A

LCD	Parameter	Range	Description
*A	Program	*** A00–A99 G01–136	Selecting a Program.

Tracks set to “***” do not produce sound.

You may select Programs from only Bank A or Bank G.

The Track Programs of *G MIDI Channel that matches the MIDI channel of the Bank Select or Program Change messages. However, this may not apply depending on the settings of *D MIDI Filter (page 111) and 2C MIDI FILTER PRG in Global mode (see page 152).

When the power is turned on or when a GM ON message is received via MIDI, or when 23A SET TO GM is being executed, GM-compatible drum Program G129 will be automatically selected for Track 10, and Program G01 will be selected for all other Tracks.

In the GM standard, MIDI Channel 10 is used for a drum (or percussion) sound, the Instruments (percussion names) are already specified for each note number (refer to “Drum Kit Map.”). ROM Drum Kit 1 on the X5DR is the GM-compatible Drum Kit which serves as a sound source for Bank G Program 129. Use this Program for GM songs. The X5DR also provides other drum Programs 130–136 in Bank G that use ROM Drum Kits 2–8, respectively, for commercially-available non-GM song data.

As shown in the table below, incoming MIDI Program Change messages will select a corresponding drum Program, if the Bank Select messages [Bn, 00, 3E, 20, 00] (n: MIDI Channel) have already been sent. (The Bank for drum sounds has already been selected for Track 10 in Multi mode when the power was turned on to the X5DR.)

MIDI Prog Change No.	X5DR Program No.
00–15, 56–63, 72–127 (0)	G129
16–23 (16)	G130
25 (25)	G131
32–39 (32)	G132
40–47 (40)	G133
64–71 (64)	G134
24, 26–31 (24)	G135
48–55 (48)	G136

For Channels other than Channel 10, you can select any of 128 Programs (see the GM Program List) that are already assigned by GM to corresponding Program Change numbers. On the X5DR, Programs 01–128 in Bank G are available for GM songs. You can also send MIDI Bank Select messages to select a Program in Bank A, or to select a drum Program as on Channel 10.

In the same manner, you can select a non-drum Program for Channel 10 by sending the MIDI Bank Select messages. (see page 109.)

You may also select a Bank using the MIDI Bank Select messages as shown in the table on next page. These messages will change the Bank only when subsequent Program Change messages are received. You do not send MIDI Bank Select messages to switch Programs within a Bank.

Therefore, send the MIDI Bank Select messages only when you wish to change the Bank, or set 2C MIDI FILTER PRG of Global mode to “NUM” (to ignore MIDI Bank Select) after you switch the Bank by sending the MIDI Bank Select messages by sending the MIDI Bank Select messages. To receive MIDI Bank Select messages, set this value to “ENA” or “PRG.”

MIDI Bank Select (MSB) (LSB)		X5DR Bank
00	00	Bank A
38	**	Bank G (01–128)
3E	**	Bank G (129–136)
3F	**	(Timbre OFF)

** : any number

*B Level, Pan, Send

This page lets you adjust the volume level and output settings for each Track.

00B Lev Pan Senø	...
T01 100 CNT 2:2	

*B

LCD	Parameter	Range	Description
*B	Level (Lev) Panpot (Pan) Send C (Sen) Send D (Sen)	0–127 OFF, A15–CNT–B15, PRG 0–9, P 0–9, P	Volume level Panpot (between A and B) setting Level C setting Level D setting

Level: Adjusts the volume level setting for each Track.

The resultant volume level for each track is obtained by multiplying the MIDI Volume data [Bn, 07, xx] (Controller #7), MIDI Expression data [Bn, 0B, xx] (Controller #11), and the value displayed on the screen. The level parameter value is not affected by MIDI Control Change messages.

MIDI Volume data (this is not a level parameter) is set to 100 when Multi mode is entered, when 23A SET TO GM is being executed, or when a GM ON message is received. (In other mode, Volume data is set to 127.)

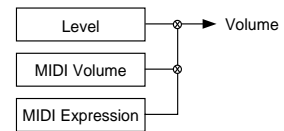

Panpot: Adjusts the A and B output balance of each Track.

Setting OFF outputs no signal at A or B. Setting A15 outputs signal only from A; setting B15 outputs signal only from B; and setting CNT (Center) outputs the same signal level from A and B.

With the PRG setting, the panpot setting of the Program selected for the Track is used. (You can specify the panpot setting for each oscillator in Program Edit mode.) With settings other than “PRG”, both Oscillator 1 and 2 of the Program use the same panpot setting.

If you have already selected a Program using a Drum Kit (OSC mode set to DRUMS) and you select “PRG” here, the panpot setting for each Instrument of the Drum kit will be used. If you set this parameter to A15 – B15, the panpot setting of each Instrument is ignored, and the parameter setting here becomes effective.

You can control the panpot setting of each Track by sending MIDI Pan Change data [Bn, 0A, xx] (Controller #10). (With a setting of OFF or PRG, the MIDI Pan Change data is ignored.) When you specify [00] for [xx], the parameter value is set to A15, and when you specify 127 [7F] for [xx], the parameter value is set to B15. You need to specify 64 [40] for the CNT setting.

Refer to “MIDI Panpot, Send Data” on page 173 for MIDI data corresponding to the panpot settings.

- When the power is turned on, when 23A SET TO GM is being executed, or when a GM ON message is received, Track 10 will use the PRG setting, and other Tracks will use the CNT setting.

Send: Sets the C and D output level of each Track.

Setting “P (Program)” selects the Send setting of the Program selected for the Track. (You can set Send for each oscillator in Program Edit mode.) Specifying a value other than “P” sets the output of Oscillator 1 and 2 to the same level.

When a Track uses a Program that uses a Drum Kit (OSC mode set to DRUMS), and you set this parameter to “P”, the Send setting of each Instrument in the Drum kit takes effect. In this case, the output level is the value of Send C and D of the Program multiplied by the Send setting value of each Index. With a value of 0 – 9, the setting of each Index is ignored, and the value specified here becomes effective.

You can also change the setting using the MIDI Effect Level messages.

Send C [Bn, 5B, xx] (Controller #91)

Send D [Bn, 5D, xx] (Controller #93)

Generally, [Bn, 5B, xx] is used to control the Reverb Depth and [Bn, 5D, xx] is used to control the Chorus Depth. Refer to “MIDI Panpot, Send Data” on page 173 for the MIDI messages corresponding to the send settings.

- When the power is turned on, when 23A SET TO GM is being executed, or when a GM ON message is received, Track 10 will use the P:0 setting, and other Tracks will use the 2:2 setting.

*C Transpose, Detune, Bend Range

This page allows you to adjust the pitch-related settings.

00C	Tra	Det	Bnd	∅	∅
T01	+00	+00	+02		

*C

LCD	Parameter	Range	Description
*C	Transpose (Tra)	-24...+24	Adjust the pitch in chromatic steps (within ±2 octaves).
	Detune (Det)	-50...+50	Adjusts the pitch in steps of 1 cent (within ±50 cents).
	Bend Range (Bnd)	-12...+12	Determines how the pitch is modified by the pitch bend wheel.

Transpose: Transpose adjusts the pitch of each Track in chromatic steps over a range of -24 to +24. (Twelve chromatic steps equal one octave).

You can also change the setting by sending MIDI Coarse Tune messages.

- When the power is turned on to the X5DR, when 23A SET TO GM is being executed, or when a GM ON message is received, this parameter is automatically reset to 00.

Detune: Detune is a fine pitch adjustment for each Track that moves in steps of one cent, over a range of -50 to +50 (100 steps equal one chromatic step).

You can also change the setting by sending MIDI Fine Tune messages.

- When the power is turned on to the X5DR, when 23A SET TO GM is being executed, or when a GM ON message is received, this parameter is automatically reset to 00.

Bend Range: The Bend Range adjusts the pitch variation amount and direction of each Track produced by the pitch bend messages in chromatic steps.

The pitch bend range specified in a Track’s Program (set on 15D in Program Edit mode) is ignored, and this setting takes effect. (The setting here does not affect the Program setting.)

A maximum of 12 chromatic steps forms a single octave. With a positive value, the farther the joystick is moved in the direction of +X (to the right), the higher the pitch. A negative value produces the opposite effect.

You can change the setting by sending MIDI Pitch Bend Range data, but the value is limited to a range of 0 – +12.

- When the power is turned on to the X5DR, when 23A SET TO GM is being executed, or when a GM ON message is received, this parameter is automatically reset to 00 for Track 10, and to +2 for other Tracks.

*D MIDI Filter

This page determines whether or not each Track will receive the MIDI Program Change and whether or not Damper message, After Touch message, and Control effect are applied.

00D Pf Df Af Cfø ...
T01 EN EN DI EN

*D

LCD	Parameter	Range	Description
*D	Program Change Filter (Pf)	DI: Disable EN: Enable	Program Change message is ignored. Program Change message is received.
	Damper Pedal Filter (Df)	DI: Disable EN: Enable	Damper Pedal message is ignored. Damper Pedal is received.
	After Touch Filter (Af)	DI: Disable EN: Enable	After Touch message is ignored. After Touch is received.
	Control Change Filter (Cf)	DI: Disable EN: Enable	MIDI Controllers are ignored. MIDI Controllers are received.

Program Change Filter: Determines whether or not each Track receives the MIDI Program Change messages.

EN: Tracks with the EN (Enable) setting receive the Program Change messages and switch the Programs. Set the overall X5DR Program Change Filter on 2C MIDI FILTER PRG in Global mode. (see “2C Program Change Filter” on page 152.)

Note: If the Global mode MIDI Program Change Filter 1 is set to “DIS”, the Program Change messages are completely disabled. Furthermore, if you set it to ENA or PRG, Bank Select and Program Change messages will select Bank and Program. If you set it to “NUM”, only the Program is changed. (see “2C Program Change Filter on page 152)

Damper Pedal Filter: Determines whether or not each Track receives the Damper Pedal On/Off messages.

EN: The Damper Pedal messages are received on the Track for which “EN (Enable)” is selected.

DI: The Damper Pedal messages are not received on the Tracks for which “DI (Disable)” is selected.

After Touch Filter: Determines whether or not each Track receives the After Touch messages.

EN: After Touch messages are received on the Track for which “EN (Enable)” is selected.

DI: After Touch messages are not applied to the Tracks for which “DI (Disable)” is selected.

Control Change Filter: Determines whether or not the controllers (e.g., pitch bend, pitch modulation, or the Volume) are received on each Track.

EN: The Controller messages are received on the Track for which “EN (Enable)” is selected.

DI: The Controller messages are ignored on the Tracks for which “DI (Disable)” is selected.

- These parameters for all the tracks are set to “EN”, when you turn the power on to the X5DR, when 23A SET TO GM is executed, or the X5DR receives the GM on message.

*E Key Window Top & Bottom

These parameters allow you to set the top note and bottom note for each Track.

00E	KWTop	KWBtm
T01	G9	C-1

*E

LCD	Parameter	Range	Description
*E	Key Window Top (KWTop)	C-1~G9	Specifies the top note for each Track's key window.
	Key Window Bottom (KWBtm)	C-1~G9	Specifies the bottom note for each Track's key window.

A key window is the range of keys (notes) that you can use to play a Track. Used in conjunction with the Key Window Bottom parameters, you can assign sections of the keyboard to specific Tracks. For example, you could designate the bottom half of the keyboard to a bass Track, and the top half to a piano Track (page 102).

You can not set the top key to lower than the bottom key. Otherwise, the bottom key will be set to the same value as the top key. The same thing applies to the bottom Key.

- When the power is turned on to the X5DR, when 23A SET TO GM is being executed, or when a GM System ON message is received, the top key of each track is set to G9, and the bottom key of each track is set to C-1.

*F Velocity Window Top & Bottom

These parameters allow you to set the maximum and minimum velocity for each Track's velocity window.

00F	VWTop	VWBtm
T01	127	001

*F

LCD	Parameter	Range	Description
*F	Velocity Window Top (VWTop)	1~127	Specifies the maximum velocity for each Track.
	Velocity Window Bottom (VWBtm)	1~127	Specifies the minimum velocity for each Track.

- When the power is turned on to the X5DR, when 23A SET TO GM is being executed, or when a GM System ON message is received, the maximum velocity of each track is set to 127, and the minimum velocity is set to 1.

*G MIDI Channel

These parameters allow you to set the MIDI Channel that each Track uses to receive MIDI data.

00G MIDI Ch	ø
T01 1G	

*G

LCD	Parameter	Range	Description
*G	MIDI Channel	1~16	Sets the MIDI Channel that each Track uses to receive MIDI data.

If you want to play a Track from the keyboard (such as the X3), you should set each Track's MIDI Channel on the X5DR so that it matches the X3's MIDI transmit channel. If you are using a sequencer, set each Track's MIDI Channel so that it matches the corresponding sequencer track's MIDI Channel.

If the selected MIDI Channel is the same as the Global MIDI Channel, a G will appear next to the selected channel number.

- When the power is turned on to the X5DR, when 23A SET TO GM is being executed, or when a GM System ON message is received, the MIDI Channel of Tracks 1–16 is set to 1–16.

16A – 21A Effect

Effects are explained in “Effect Parameters” on page 115.

The individual effect settings of each Program are ignored, and these settings are used.

If you want to use a Program's or a Combination's effect settings, use the 21A COPY EFF function to copy effects. (See “21A Copy Effects” on page 119.)

Track parameters Pan A, Pan B, Send C, and Send D are used to control the level of the Tracks sent to the effects in Multi mode.

Effects can be controlled via MIDI on the Global MIDI Channel. You can control the level of each Track to the effects using the Track parameters Pan A, Pan B, Send C, and Send D.

- When the power is turned on to the X5DR, when 23A SET TO GM is being executed, or when a GM System ON message is received, Effect 1 selects Hall, Effect 2 selects Chorus1, Placement selects Parallel3, and the effect return level is set to 4.

22A Copy from Combination

This function allows you to copy Combination Timbre settings to Tracks 1 to 8 or Tracks 9 to 16.

22A COPY COMBI
COMB 00 1-8 OK?

22A

LCD	Parameter	Range	Description
22A	Source Combination	00 ~ 99	Selects the Combination to copy.
	Destination Tracks	1–8, 9–16	Selects the eight destination tracks.
	OK to Copy from Combination	OK?	Executes Combination copy.

The following parameter settings are copied: Program, Volume, Transpose, Detune, Pan, Send C, Send D, Key Window, Velocity Window, MIDI Channel, and Filters (Program Change, Damper Pedal, After Touch, Control Change).

The Combination's effect settings are not copied. Use 21A Copy Effect to copy the effect settings. (see page 119.)

For *C Bend Range parameters that are not included in Combinations, the value of Program's Joystick Pitch Bend Range (15D in Program Edit mode) of each Track will be copied.

23A Set To GM (Initialize for GM)

This function conforms a track to the GM (General MIDI) settings. It should be used when you want to make new GM data, or when you want to play back GM song data.

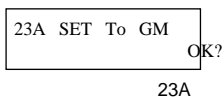

LCD	Parameter	Range	Description
23A	OK to set Track to GM Mode	OK?	Sets song to GM mode.

Each track's parameters are set as follows. Track 10 is set for drums.

Parameter	Track 1 ~ 9 & 11 ~ 16	Track 10	
Program	G01: PIANO	G129 (GM kit)	* Changeable using MIDI
Level	127	127	
Pan	CNT	PRG	* Changeable using MIDI
Send C, D	2, 2	P, 0	* Changeable using MIDI
Transpose	0	0	* Changeable using MIDI
Detune	0	0	* Changeable using MIDI
Pitch Bend Range	+2	0	* Changeable using MIDI
Program Change Filter	ENA	ENA	
Damper Pedal Filter	ENA	ENA	
After Touch Filter	ENA	ENA	
Control Change Filter	ENA	ENA	
Key Window	C-1-G9	C-1-G9	
Velocity Window	1-127	1-127	
Effect 1	—	—	Hall
Effect 2	—	—	Chorus
Effect Placement	—	—	Parallel 3
MIDI Channel	1-9, 11-16	10	

- When a GM System On message (F0, 7E, nn, 09, 01, F7) is received, Multi 1 mode is selected and these parameters are set automatically.

These parameters are also set automatically when you turn the power on to the X5DR.

4. Effect Parameters

The X5DR contains two digital multi-effects processors. Each processor can be set to produce one of 47 effects (effect types). The effects section consists of four inputs (A, B, C, D), two effects processors (Effect1, Effect2), two panpots (pan 3, 4) and two outputs (L/MONO, R). The X5DR effects processors can be assigned any one of four placements. See “20A–20B Effect Placement” on page 117. Effects 1 to 37 are single effects, 38 and 39 are serial effects, and 40 to 47 are parallel effects. The parallel type effects allow you to use up to four independent effects simultaneously.

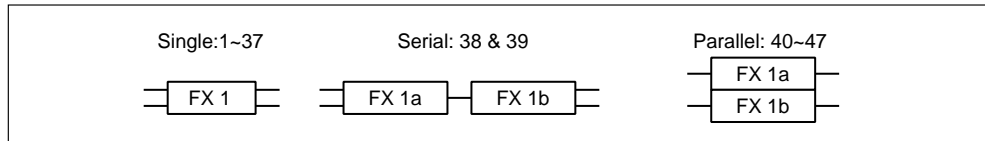

When you play a Combination, the individual effect settings for each Program in that Combination are ignored, and the effect settings for that Combination are used. Likewise, for Multi setup, the individual Program effect settings are ignored and the effect settings for that particular Multi setup are used.

Effect parameters can be edited and stored with individual Programs, and Combinations. Effect parameters for a Program should be edited in Program Edit mode, and for Combination in Combination Edit mode. The X5DR does not store Multi effect parameters.

The page which the effect setting is made, is different with each mode.

- Program Edit mode (Single, Drums) 10A–15A
- Program Edit mode (Double) 16A–21A
- Combination Edit mode 9A–14A
- Multi mode 16A–21A

In this manual, we use Program Edit mode (Double) as an example.

When a GM System On message is received, when the power is turned on, or when 23A SET TO GM is being executed, the Multi mode settings are initialized and the unit enters Multi mode. The following effect settings are made:

Placement—Parallel3.

Effect1—Hall.

Effect2—Chorus.

16A–16C Effect1 Setup

These parameters are used to set up Effect1.

16A EFFECT1=01 Hall	ø OFF	16B Hall DRY:EFF=75:25	ø I+10	16C Hall Src:JS(+Y)	ø
16A		16B		16C	

LCD	Parameter	Range	Description
16A	Effect Type (Effect1)	0–47	Select an effect type
	Switch	OFF, ON	Turn the effect on or off.
16B	Dry:Effect Balance (DRY:EFF)	DRY 99:1–1:99 FX	Dry signal only Dry:effect mix Effect signal only
16C	Dynamic Modulation Control Source (Src)	NONE JS(+Y) JS(–Y) AFTT PEDAL1 PEDAL2 VDA-EG	Dynamic modulation off Joystick +Y Joystick –Y After Touch Foot pedal1 Foot pedal2 Sum of all 64 VDA EGs
	Dynamic Modulation Intensity (I)	–15...+15	Set the depth of dynamic modulation

16A Effect type: Each time a different effect is selected, parameters that you set for the previously selected effect are reset to their initial values.

Note: When effect 24:Symphonic Ensemble is selected for one processor, certain effects cannot be selected for the other processor. See “Symphonic Ensemble” on page 129.

Switch: Is used to turn the effects processors on and off.

By sending MIDI Controller 92 for Effect1, and MIDI Controller 94 for Effect2, effects can be switched on and off by an external sequencer, or other MIDI device. Each time a Controller message is sent, the corresponding effect is switched on or off.

Note: The high and low EQ for the following effects is valid even when the effect is set to OFF: 13:Stereo Delay, 14:Cross Delay, 19:Chorus 1, 20:Chorus 2, 28:Exciter, 35:Autopan, 36:Tremolo. To bypass these effects completely select 0: No Effect.

16B Dry:Effect balance: This parameter allows you to set the level balance between the dry signal and effected signal. A setting of DRY means no affected signal. A setting of FX means all effect signal.

16C Dynamic modulation control source: Allows you to adjust certain effect parameters, such as mix balance and modulation speed, while you play. This provides greater control for musical expression during a performance. The modulation source can be set to any one of six controls, such as a joystick and foot pedal. You can control only one effect parameter using dynamic modulation, but the modulation source and intensity can be set independently for Effect1 and Effect2. See “Effects Types & Parameters” on page 120.

JS(+Y): This MIDI data [Bn, 01, xx] (Controller #1) is transmitted to apply modulation when you move the joystick on a keyboard (such as the X3) in the direction of +Y.

JS(–Y): This MIDI data [Bn, 02, xx] (Controller #2) is transmitted to apply modulation when you move the joystick on the keyboard such as X3 in the direction of –Y.

AFTT: After Touch [Dn, xx]

PEDAL1: When “effect control” is selected for the function of the assignable pedal 1 connected to a keyboard (such as the X3), using the pedal will transmit a MIDI message [Bn, 0C, xx] (Controller #12) to apply modulation.

PEDAL2: Transmitting a MIDI message [Bn, 0D, xx] (Controller #13) to apply modulation.

VDA EG: 64 voices, which is the sum of all the VDA EG levels. This is very effective when you play chords. (“n” is a MIDI channel.)

To control dynamic modulation via MIDI, set the MIDI transmit channel of the control source (such as the X3) will that of the Global MIDI Channel.

Dynamic Modulation Intensity: The dynamic modulation intensity can be set from –15 to +15. Positive values cause dynamic modulation to increase the value of the effect parameter being controlled. Negative values have the opposite effect.

17A–17D Effect1 Parameters

Effect parameters are explained in detail from page 120 onwards.

18A–18C Effect2 Setup

These parameters are used to set up Effect2. Operation is the same as for “16A–16C Effect1 Setup” on page 116.

19A–19D Effect2 Parameters

Effect parameters are explained in detail from page 120 onwards.

20A–20B Effect Placement

The X5DR effect processors can be used in any one of four placements. Placements affect the way in which the four input buses (A, B, C, D) are routed through the effects.

The Panpot, Send C Level, and Send D Level parameters are set as part of an individual Program, Combination, or Multi setup.

20A PLACEMENT \emptyset	20B EFF2 PANPOT \emptyset	20B E1/E2 LEVEL \emptyset
Serial	3= L 4= R	L=5 R=5 L=5 R=5
20A	20B	20B'

LCD	Parameter	Range	Description
20A	Effect Placement	Serial (Serial) Parallel 1 (Parallel) Parallel 2 (Paralel2) Parallel 3 (Paralel3)	Effect routing configurations
20B	Panpot 3	OFF L 99:1–1:99 R	No signal output Signal is panned hard left Panned between L and R (50:50 pan center) Signal is panned hard right (this LCD screen appears when Serial, Parallel 1, or Parallel 2 is selected)
	Panpot 4		
20B'	Level 1L (L)	0–9	Set the output level of each effect when Parallel 3 is selected. (this LCD is available only when Parallel 3 placement is selected)
	Level 1R (R)		
	Level 2L (L)		
	Level 2R (R)		

Page 20B appears when you select Serial, Parallel 1, or Parallel 2 for 20A Placement. Here, you can set the L/R output balance for Pan 3 and Pan 4. Page 20B' appears when you select Parallel 3 for the placement. In this case, Pan 3 and Pan 4 are replaced by four independent level controls.

The X5DR has two outputs (L/MONO, R).

Serial Placement

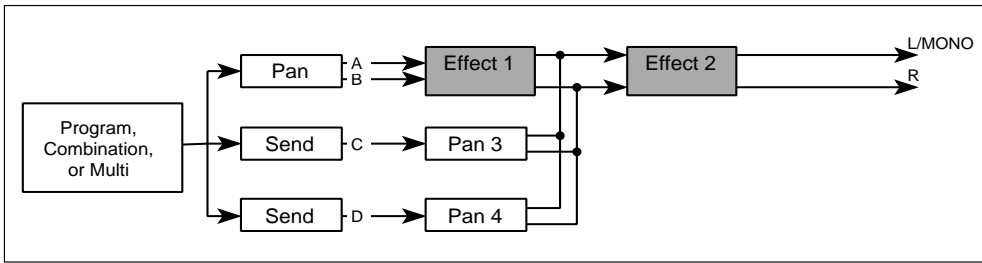

With the Serial placement, buses A and B are sent to Effect1, Effect2, then output from L/MONO and R. Buses C and D are mixed with the output of Effect1, sent to Effect2, and then output.

Buses C and D allow you to avoid applying Effect1 to a sound, or to apply Effect1 to a specific sound and then apply Effect2 to all sounds.

Parallel 1 Placement

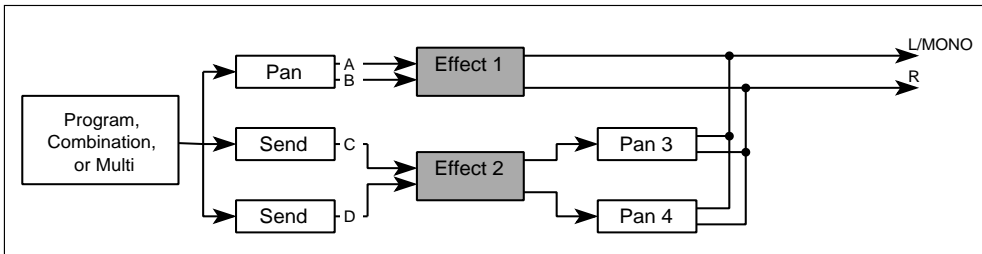

With the Parallel 1 placement, buses A and B are sent to Effect1, then output from L/MONO and R. Buses C and D are sent to Effect2, mixed with the output of Effect1, then output.

Parallel 2 Placement

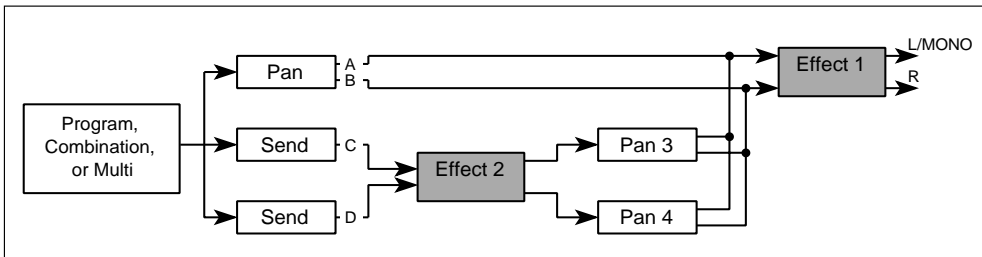

With the Parallel 2 placement, buses A and B are sent to Effect1, then output from L/MONO and R. Buses C and D are sent to Effect2, mixed with the input to Effect1, then output.

Parallel 3 Placement

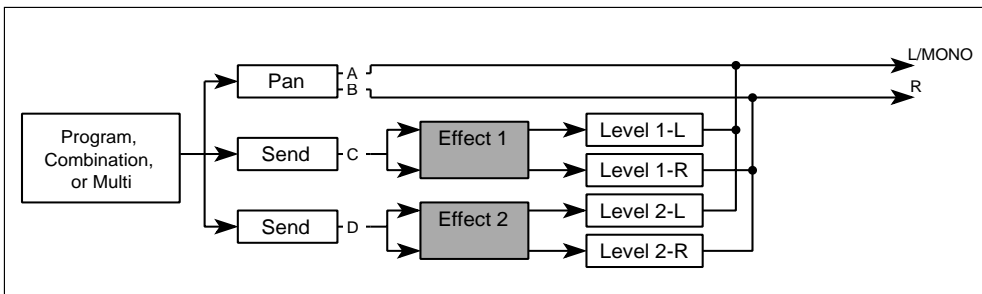

With the Parallel 3 placement, buses A and B are sent straight to the outputs. Bus C signal is sent to Effect1 and bus D signal is sent to Effect2. The effect outputs, each with independent level control, are then mixed down to the L/MONO and R outputs. This placement works well when playing GM compatible songs.

Note: For Serial, Parallel 1, and Parallel 2 placements, if Pan 3 or Pan 4 is set to off, signals sent to bus C and bus D are not output.

21A Copy Effects

This function allows you to copy the effect parameter settings from a Program, Combination, or song to the currently selected Program, Combination, or Multi setup.

```
21A COPY EFF
PROG  A00    OK?
```

21A

LCD	Parameter	Range		Description
21A	Effect Copy Source	PROG COMBI MULTI		Select the effect copy source
	Source Number	Programs	A00–A99 G01–136	Select the source number
		Combinations	00–99	
	OK to copy	OK?		Executes effect copy

To copy effect parameters, select the effect copy source and the source number using the [√] and [®] keys, position the cursor on OK?, then press the [▲] button. The message “Are You Sure OK?” appears. Press the [▲] button to continue, or the [▼] button to cancel. The effect parameters are copied to the currently selected Program, Combination, or Multi. Pan, Send C, and Send D settings, which are set for oscillators, Timbres, and tracks, are not copied.

Effects Types & Parameters

Different parameters are available for different effects. Effect 0 (No Effect) through Effect 47 (Delay/Rotary Speaker) can be selected for Effect1 and Effect2. Effect1 LCD screens are numbered 16A through 16D. Effect2 LCD screens are numbered 18A through 19D. Effect1 LCD screen numbers are used in this Reference Guide.

No Effect

0: No Effect

When NO EFFECT is selected, the effect processors are bypassed.

Effects can be turned off using “16A–16C Effect1 Setup” and “18A–18C Effect2 Setup”. However, for some effects, the high and low EQ are still active. Selecting 0:No Effect allows you to bypass these effects completely.

Reverb

These effects simulate reverberant acoustics, adding ambience to the sound.

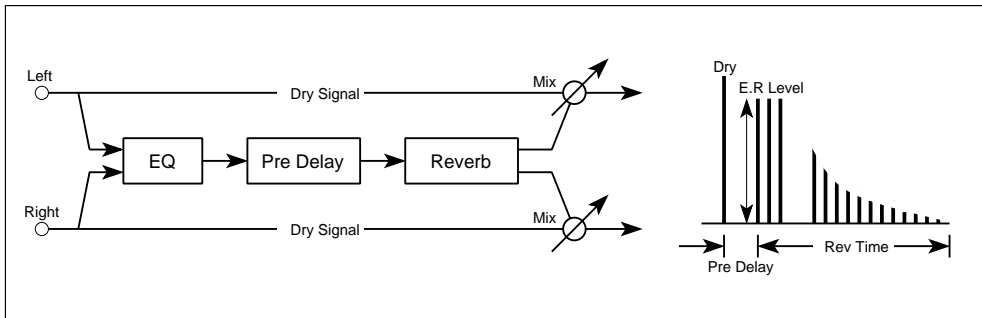

1: Hall

This effect simulates the reverb characteristics and natural ambience of a medium size hall.

2: Ensemble Hall

This effect simulates the reverb characteristics and natural ambience of an ensemble hall. Ideal for string and brass ensembles.

3: Concert Hall

This effect simulates the reverb characteristics and natural ambience of a large hall with pronounced early reflections.

4: Room

This effect simulates the reverb characteristics and natural ambience of a small room.

5: Large Room

This effect simulates the reverb characteristics and natural ambience of a large room with pronounced reverb density. Reverb time settings of about 0.5 seconds produce an effect similar to gated reverb.

6: Live Stage

This effect simulates the reverb characteristics and natural ambience of a large, live-performance space.

7: Wet Plate

This effect simulates the reverb characteristics of a steel-plate reverb, with pronounced density.

8: Dry Plate

This effect simulates the reverb characteristics of a steel-plate reverb, with a light density.

9: Spring Reverb

This effect simulates the reverb characteristics of a spring reverb.

17B Hall Time3.2	ϕ H.Dmp30	@	17B Hall P.Dly060ms	ϕ E.R62	17C Hall EQ.L+04dB	ϕ H+00dB
			17A	17B	17C	

LCD	Parameter	Range	Description
17A	Reverb Time (Time)	0.2–9.9 sec 0.2–4.9 sec 00–99 sec	The time over which the reverb effect will last Hall type Room type Plate/spring type
	High Damp (H.Dmp)	0–99%	High frequency decay 0 = bright reverb 99 = dark reverb
17B	Pre Delay (P.Dly)	0–200 ms	The delay between the original sound and the early reflections
	Early Reflection Level (E.R)	0–99 1–10	The level of the early reflections Hall/Room type Plate/spring type
17C	EQ Low (EQ.L)	–12...+12 dB	Low EQ cut and boost
	EQ High (H)	–12...+12 dB	High EQ cut and boost

For effects 1 to 9, dynamic modulation (16C) can be used to control the DRY:EFF balance.

Early Reflection

The Early Reflection effects create the early reflections that are an important element in determining the qualities of an acoustic environment. Using the Early Reflection Time parameter you can create a variety of effects, such as sound thickening and echo-like reflections.

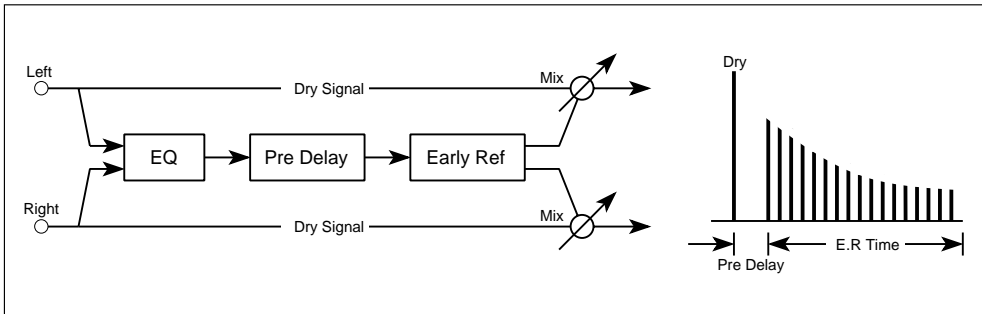

10: Early Reflection 1

Early reverb reflections are a crucial element of naturally occurring reverb. They transmit details such as room size, distance, acoustic damping, etc. This effect emphasizes the low frequency range, and is ideal for percussive sounds such as drums.

11: Early Reflection 2

This effect is similar to Early Reflection 1, although, the level of the early reflections change over time in a different way.

12: Early Reflection 3

This effect applies a reverse envelope to the early reflections. This produces an effect that is similar to playing a tape backwards, and it is ideally to sounds that have a fast attack such as crash cymbals.

17A EarlyRef1 ϕ E.R Time=220ms	17B EarlyRef1 ϕ Pre Delay= 015ms	17C EarlyRef1 ϕ EQ.L+03dB H+05dB
17A	17B	17C

LCD	Parameter	Range	Description
17A	Early Reflection Time (E.R Time)	100–800 ms	Early reflection time in 10 ms steps
17B	Pre Delay (Pre Delay)	0–200 ms	The delay between the original sound and the early reflections
17C	EQ Low (EQ.L)	–12...+12 dB	Low EQ cut and boost
	EQ High (H)	–12...+12 dB	High EQ cut and boost

For effects 10 to 12, dynamic modulation (16C) can be used to control the DRY:EFF balance.

Stereo Delay

These effects create stereo delay patterns in which you can set the left and right delay times independently. Using the High Damp parameter, you can make delays decay in a natural way.

13: Stereo Delay

This is a stereo delay effect with feedback. The delay time can be set independently for the left and right channels.

The high damp parameter can be used to produce a more natural echo effect by gradually attenuating the high frequencies of successive delay repeats.

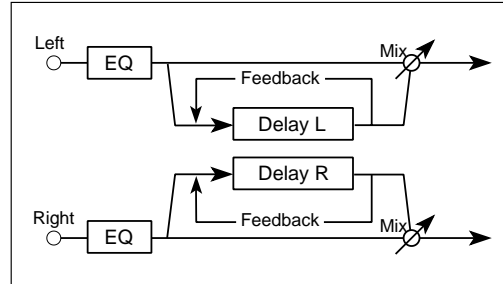

14: Cross Delay

This is a stereo delay effect with independent delay parameters for the left and right channels. The delay outputs are crossed over, and each delay receives the other delay's feedback signal. Thus, the delay repeats appear to move between the left and right outputs.

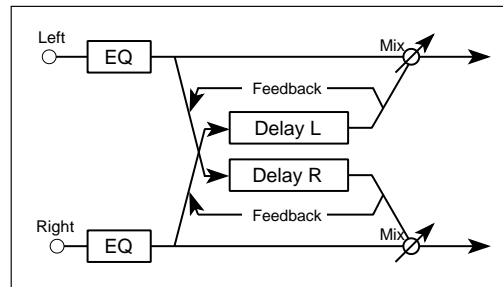

17A StereoDly ϕ D.TimeL=250 R260	17B StereoDly ϕ \downarrow FB+40 H.Dmp30	17C SterepDly ϕ EQ.L+00dB H=00dB
--	--	--

17A

17B

17C

LCD	Parameter	Range	Description
17A	Delay Time Left (D.Time L)	0–500 ms	Delay time for the left channel
	Delay Time Right (R)	0–500 ms	Delay time for the right channel
17B	Feedback (FB)	–99...+99%	The amount of delay signal that is fed back into the effect. Minus values invert the feedback signal phase
	High Damp (H.Dmp)	0–99%	High frequency decay 0 = bright delay 99 = dark delay
17C	EQ Low (EQ.L)	–12...+12 dB	Low EQ cut and boost
	EQ High (H)	–12...+12 dB	High EQ cut and boost

For effects 13 and 14, dynamic modulation (16C) can be used to control the DRY:EFF balance.

The EQ part of these effects is active even when the Effect is switched off (16A). To bypass these effects completely, select 0:No Effect.

Dual Mono Delay

15: Dual Mono Delay

This effect consists of two mono delays with independent delay time, feedback, and high damp parameters for each channel.

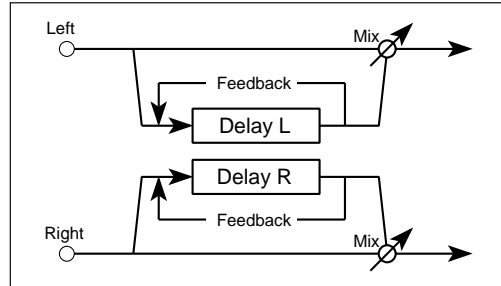

17A	D.M	Dly(L)	φ	17B	D.M	Dly(L)	φ	17C	D.M	Dly(R)	φ	17D	D.M	Dly(R)	φ
D.Time=250ms				FB+50 H.Dmp10				D.Time=250ms				FB+50 H.Dmp10			
17A				17B				17C				17D			

LCD	Parameter	Range	Description
17A	Delay Time Left (D.Time)	0–500 ms	Delay time for the left channel
17B	Feedback Left (FB)	–99...+99%	The amount of delay signal that is fed back into the left channel effect. Minus values invert the feedback signal phase
	High Damp Left (H.Dmp)	0–99%	High frequency damping for the left channel
17C	Delay Time Right (D.Time)	0–500 ms	Delay time for the right channel
17D	Feedback Right (FB)	–99...+99%	The amount of delay signal that is fed back into the left channel effect. Minus values invert the feedback signal phase
	High Damp Right (H.Dmp)	0–99%	High frequency damping for the right channel

For effect 15, dynamic modulation (16C) can be used to control the DRY:EFF balance.

Multi-Tap Delay

In these effects, an equalizer is applied to each effect input, then the signals are fed to two independent series-connected delays. The output of one delay is fed back to the input.

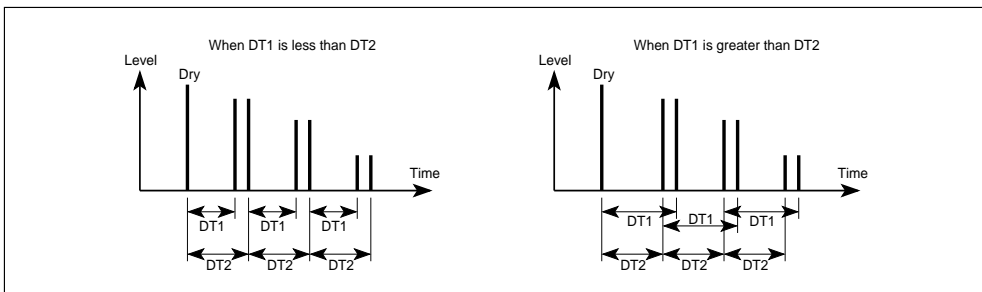

16: Multi-Tap Delay 1

This is a two-channel multi-repeat delay. It consists of two parallel delays for each channel. The delay time for each delay can be set independently. The output of delay 2 is fed back to the inputs of delay 1 and delay 2.

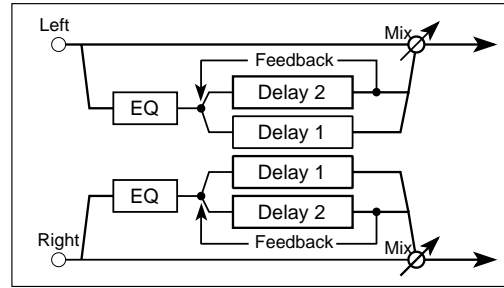

17: Multi-Tap Delay 2

This is a two-channel multi-repeat delay with cross panning. The output of delay 2 is fed back to the inputs of delay 1 and delay 2.

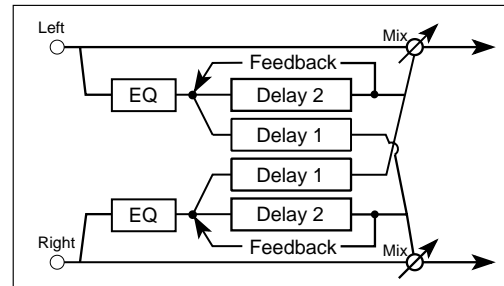

18: Multi-Tap Delay 3

This is a two-channel multi-repeat delay with crossed feedback. The output of delay 2 is fed back to the inputs of delay 1 and delay 2.

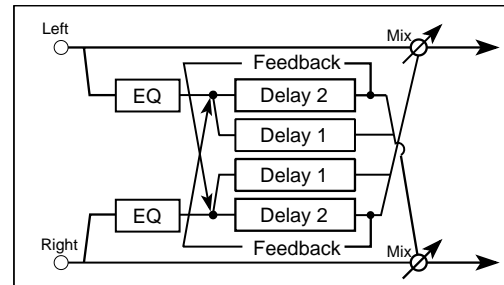

17A	M.TapDly1	φ	17B	M.TapDly1	φ	17C	M.TapDly1	φ
D1T300	D2T400		FB+50			EQ.L+00dB	H+00dB	
17A		17B		17C				

LCD	Parameter	Range	Description
17A	Delay Time 1 (D1T)	0–500 ms	Delay time for delay 1
	Delay Time 2 (D2T)	0–500 ms	Delay time for delay 2
17B	Feedback (FB)	–99...+99%	The amount of delay signal that is fed back into the effect. Minus values invert the feedback signal phase
17C	EQ Low (EQ.L)	–12...+12 dB	Low EQ cut and boost
	EQ High (H)	–12...+12 dB	High EQ cut and boost

For effects 16, 17, and 18, dynamic modulation (16C) can be used to control the DRY:EFF balance.

Chorus

These are stereo-type effects that use two chorus units. They're an effective way to add spaciousness and depth to any type of sound: piano, strings, brass, etc.

19: Chorus 1

In this chorus effect, the left channel modulation signal is out of phase with the right channel modulation signal. This produces a wide stereo chorus effect.

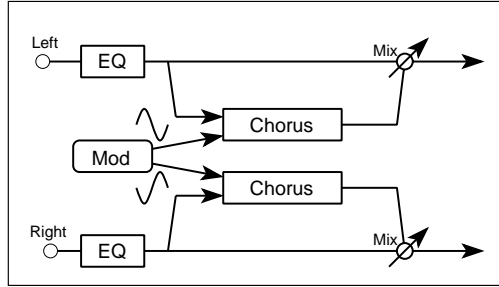

20: Chorus 2

In this chorus effect, left and right channel modulation signals are in phase.

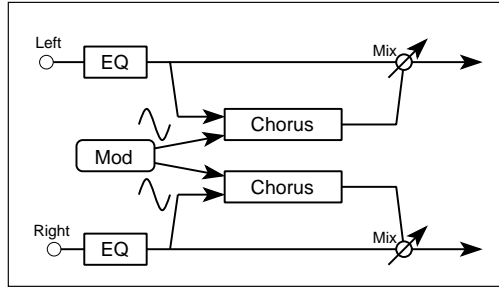

17A Chorus 1 ϕ D.Time=010ms TRI	17B Chorus 1 ϕ \ddagger Mod60 M.SP0.30Hz	17C Chorus 1 ϕ EQ.L+00dB H+00dB
17A	17B	17C

LCD	Parameter	Range	Description
17A	Delay Time (D.Time)	0–200 ms	Delay time
	Mod Waveform	Sine (SIN) Triangle (TRI)	Modulation waveform type
17B	Mod Depth (Mod)	0–99	Modulation intensity
	Mod Speed (M.SP)	0.03–30 Hz	Modulation speed
17C	EQ Low (EQ.L)	–12...+12 dB	Low EQ cut and boost
	EQ High (H)	–12...+12 dB	High EQ cut and boost

For effects 19 and 20, dynamic modulation (16C) can be used to control the DRY:EFF balance. The EQ part of these effects is active even when the Effect is switched off (16A). To bypass these effects completely, select 0:No Effect.

21: Quadrature Chorus

The modulation signals fed to each channel of this stereo chorus effect are 90 degrees out of phase with each other.

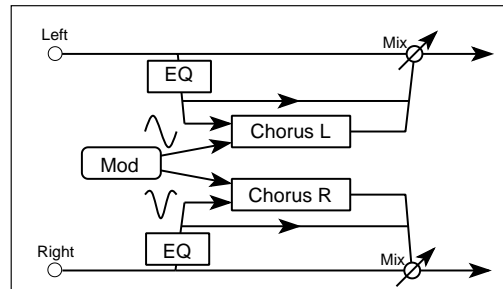

22: Crossover Chorus

The modulation signals fed to each channel of this stereo chorus effect are 90 degrees out of phase with each other. The chorused signals are mixed with the other channels output.

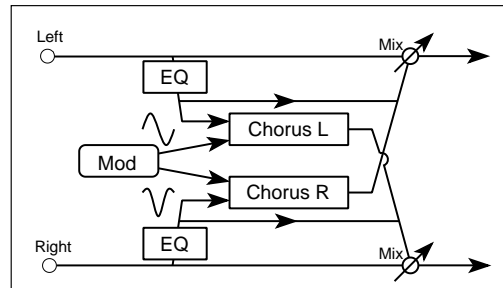

17A Quad.Cho D.Time L011 R023	17B Quad.Cho Mod50 ModSP=33	17C Quad.Cho ModShape=T+00	17D Quad.Cho EQ.L+00dB H+00dB
17A	17B	17C	17D

LCD	Parameter	Range	Description
17A	Delay Time L (D.TimeL)	0–250 ms	Left channel delay time
	Delay Time R (R)	0–250 ms	Right channel delay time
17B	Mod Depth (Mod)	0–99	Modulation depth
	Mod Speed (ModSP)	1–99	Modulation speed
17C	Mod Shape (ModShape)	T+10...T–10, S–10...S+10	Modulation waveform shape. T–Triangle, S–Sine. The range from +10 to –10 effects the waveform symmetry
17D	EQ Low (EQ.L)	–12...+12 dB	Low EQ cut and boost
	EQ High (H)	–12...+12 dB	High EQ cut and boost

For effects 21 and 22, dynamic modulation (16C) can be used to control the Mod Speed.

23: Harmonic Chorus

This effect splits the signal into two bands: HF (high frequency) and LF (low frequency). The HF band is then fed to the quadrature type chorus, and the LF band is fed directly to the output. This effect is useful for low frequency instruments such as bass.

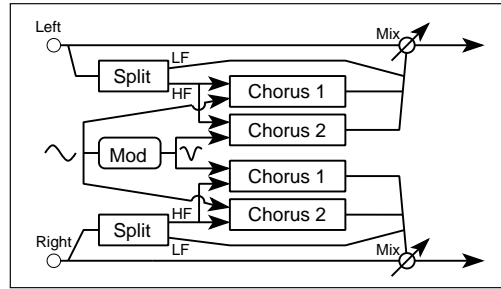

17A Harmo.Cho ϕ D1T004 D2T012	17B Harmo.Cho ϕ Mod99 ModeSP=35	17C Harmo.Cho ϕ F.Split Point=01
17A	17B	17C

LCD	Parameter	Range	Description
17A	Delay Time1 (D1T)	0–500 ms	Channel 1 delay time
	Delay Time 2 (D2T)	0–500 ms	Channel 2 delay time
17B	Mod Depth (Mod)	0–99	Modulation depth
	Mod Speed (ModSP)	1–99	Modulation speed
17C	Frequency Split Point (F.Split Point)	0–18	The frequency at which the input signal is split into HF and LF bands

For effect 23, dynamic modulation (16C) can be used to control the Mod Speed.

Symphonic Ensemble

24: Symphonic Ensemble

This effect is basically a multiple chorus type effect. It produces a rich, thickening effect, ideal for strings.

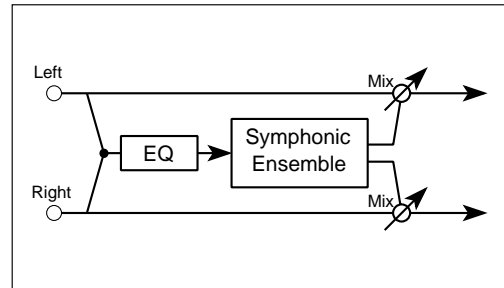

17A Symp.Ens. ϕ Mod80	17B Symp.Ens. ϕ EQ.L+00dB H=00db
-------------------------------	--

17A

17B

LCD	Parameter	Range	Description
17A	Mod Depth (Mod)	0–99	Modulation depth
17B	EQ Low (EQ.L)	–12...+12 dB	Low EQ cut and boost
	EQ High (H)	–12...+12 dB	High EQ cut and boost

For effect 24, dynamic modulation (16C) can be used to control the DRY:EFF balance.

Note: When this effect is selected, the following effect types cannot be selected for the other effect: Choruses 19–23, Symphonic Ensemble 24, Flangers 25–27, Phasers 32–33, Rotary Speaker 34, Tremolos 35–36, Chorus Flanger/Delay 38–39, Delay/Chorus 42, Delay/Flanger 43, Delay/Phaser 46, and Delay/Rotary Speaker 47.

Flanger

These effects add feedback to a chorus effect. When used on sounds that contain a lot of high-frequency energy, such as cymbals, they not only create modulation effects, they add a sense of pitch to non-pitched sounds, too.

25: Flanger 1

In this effect, in phase modulation is fed to both flanger channels.

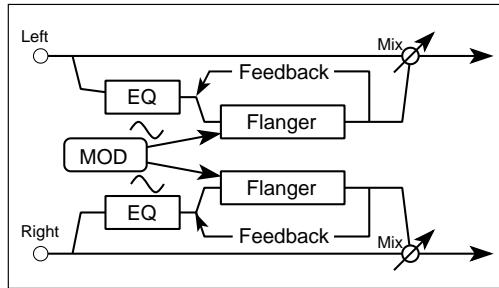

26: Flanger 2

In this effect, the left channel modulation signal is in phase and the right channel modulation signal is out of phase. This produces a wide, stereo flange effect.

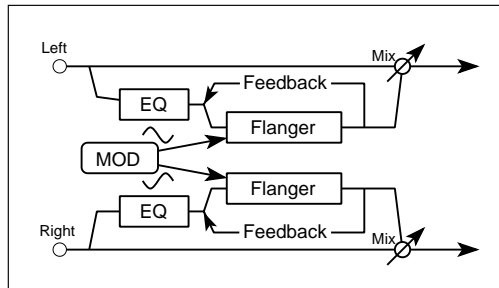

27: Crossover Flanger

In this effect, two flangers are modulated out of phase. The flanged output signals are mixed with the other channels output.

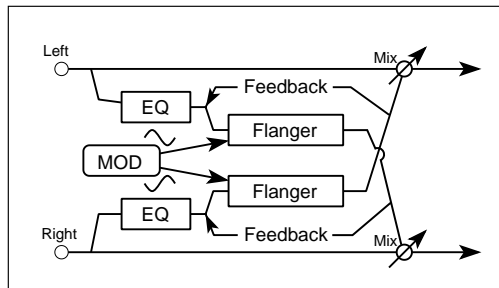

17A Flanger1	φ	17B Flanger1	φ	17C Flanger1	φ
D.Time005	Res+85	Mod99	ModSP=20	EQ.L+00dB	H+00dB
17A		17B		17C	

LCD	Parameter	Range	Description
17A	Delay Time (D.Time)	0–200 ms	Delay time
	Resonance (Res)	–99...+99	Amount of output signal fed back to the input (feedback)
17B	Mod Depth (Mod)	0–99	Modulation depth
	Mod Speed (ModSP)	1–99	Modulation speed
17C	EQ Low (EQ.L)	–12...+12 dB	Low EQ cut and boost
	EQ High (H)	–12...+12 dB	High EQ cut and boost

For effects 25 to 27, dynamic modulation (16C) can be used to control the Mod Speed.

Exciter

28: Exciter

This effect increases the clarity of a sound and gives it greater definition.

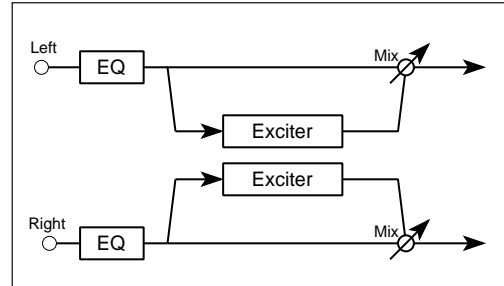

17A Exciter Blend=+50	ϕ	17B Exciter Emph Point=05	ϕ	17C Exciter EQ.L+04dB H=00dB	ϕ
17A		17B		17C	

LCD	Parameter	Range	Description
17A	Blend (Blend)	-99...+99	Mix of dry and effected signal
17B	Emphatic Point (Emph Point)	1-10	The central frequency around which sounds are excited
17C	EQ Low (EQ.L)	-12...+12 dB	Low EQ cut and boost
	EQ High (H)	-12...+12 dB	High EQ cut and boost

For effect 28, dynamic modulation (16C) can be used to control the DRY:EFF mix level.

The EQ sections of this effect are active even when the effect is switched OFF. To bypass this effect completely, select 0:No Effect.

Enhancer

29: Enhancer

This is a two-channel enhancer that includes a delay to give a sound more spaciousness. An enhancer makes the sound clearer and more defined, giving the sound more presence and bringing it up front in the mix.

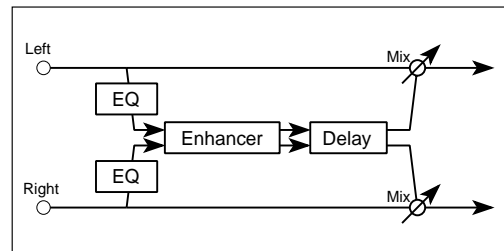

17A Enhancer Harm Density=80	ϕ	17B Enhancer Hot Spot=01	ϕ	17C Enhancer S.W=50 D.Time=25	ϕ	17D Enhancer EQ.L+01dB H+01dB	ϕ
17A		17B		17C		17D	

LCD	Parameter	Range	Description
17A	Harmonic Density	1-99	Level of the enhanced signal
17B	Hot Spot	1-20	The central frequency around which sounds are enhanced
17C	Stereo Width (S.W)	0-99	The width of the stereo image that is opened up by the delay
	Delay Time (D.Time)	1-99	Delay time
17D	EQ Low (EQ.L)	-12...+12 dB	Low EQ cut and boost
	EQ High (H)	-12...+12 dB	High EQ cut and boost

For effect 29, dynamic modulation (16C) can be used to control the DRY:EFF balance.

Distortion

30: Distortion

This effect can provide everything from subtle distortion through to mega-power distortion—ideal for ripping solos. The Hot Spot and Resonance parameters allow you to tune in for a wah type effect, and the Hot Spot parameter can be controlled in real time using dynamic modulation.

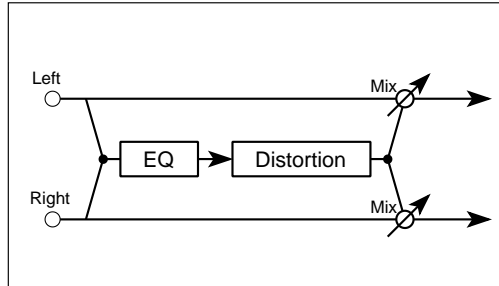

31: Overdrive

This effect produces a smooth overdrive. As with the previous distortion effect, dynamic modulation allows real-time control of the wah filter's Hot Spot parameter.

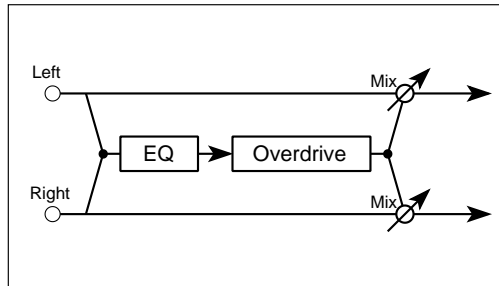

17A Dist Drive=111 Res=00	17B Dist H.Spot05 Level10	17C Dist EQ.L+02dB H+12dB
17A	17B	17C

LCD	Parameter	Range	Description
17A	Drive (Drive)	1–111	Distortion/Overdrive level
	Resonance (Res)	0–99	Gain of the resonant wah filter
17B	Hot Spot (H.Spot)	0–99	Wah filter centre frequency
	Out Level (Level)	0–99	Distortion output level
17C	EQ Low (EQ.L)	–12...+12 dB	Low EQ cut and boost
	EQ High (H)	–12...+12 dB	High EQ cut and boost

For effects 30 and 31, dynamic modulation (16C) can be used to control the Hot Spot parameter. This is useful for creating a wah-wah type effect.

Phaser

These are two-channel stereo phase shifters. Using delay and phase changes, they produce a modulation effect that is clearer than chorus or flanger. These effects are especially suitable for electric piano and guitar. Chorus and flanger produce their effects by modulating the delay time. However, phasers, modulate the phase of the input signal, creating an effect that has a different character to that of chorus or flanger.

32: Stereo Phaser 1

In Phaser 1, the left channel modulation signal is in phase and the right channel modulation signal is out of phase. This produces a wide stereo phaser effect.

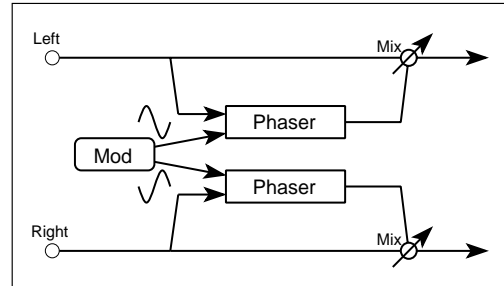

33: Stereo Phaser 2

This stereo effect contains two phasers. In-phase modulation is fed to both channels.

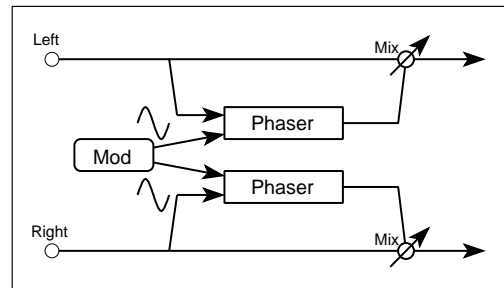

17A Phaser 1 Manual=99	17B Phaser 1 Mod60 M.SP0.69Hz	17C Phaser 1 FB+75 SIN
17A	17B	17C

LCD	Parameter	Range	Description
17A	Manual (Manual)	0–99	The central frequency around which phase shifting is concentrated
17B	Mod Depth (Mod)	0–99	Modulation depth
	Mod Speed (M.SPO.)	0.03–30 Hz	Modulation speed
17C	Feedback (FB)	–99...+99%	The amount of phased signal that is fed back into the effect. Minus values invert the feedback signal phase
	Mod Waveform	Sine (SIN) Triangle (TRI)	Modulation waveform

For effects 32 and 33, dynamic modulation (16C) can be used to control the Mod Speed.

Rotary Speaker

This effect simulates the rotary speaker effect that is popular for organs.

34: Rotary Speaker

The effect is popular with organ type sounds. The rotation speed continuously cycles between the two speed settings at a rate determined by the Acceleration parameter.

Dynamic modulation can be used to switch from slow to fast speed. The rotor speed will change at a rate specified by the Acceleration parameter regardless of how rapidly you move the dynamic modulation controller.

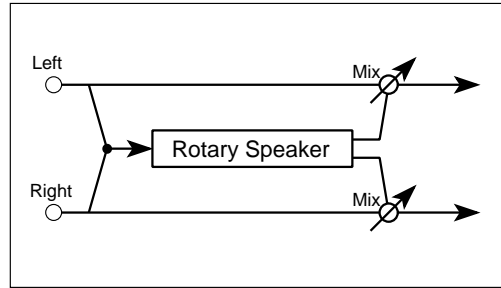

17A Rot.Spkr Vibrato Depth=09	17B Rot.Spkr Acceleration=04	17C Rot.Spkr Speed S=25 F=70
17A	17B	17C

LCD	Parameter	Range	Description
17A	Vibrato Depth (Vibrato Depth)	0-15	Effect depth
17B	Acceleration (Acceleration)	1-15	Time taken to change from one speed to the other
17C	Slow Speed (S)	1-99	Slow rotation speed
	Fast Speed (F)	1-99	Fast rotation speed

For effect 34, dynamic modulation (16C) can be used to switch from slow to fast speed.

Tremolo

This effect cyclically varies the volume.

35: Auto Pan

This effect pans the signal continuously across the stereo image. The speed of panning (Mod Speed) can be set relative to song tempo, or left to produce a natural drift across the stereo image.

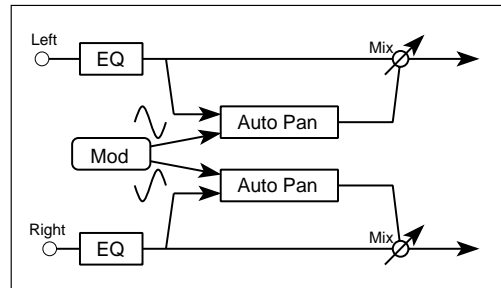

36: Tremolo

The tremolo effect modulates the signal amplitude to produce regular variations in volume level.

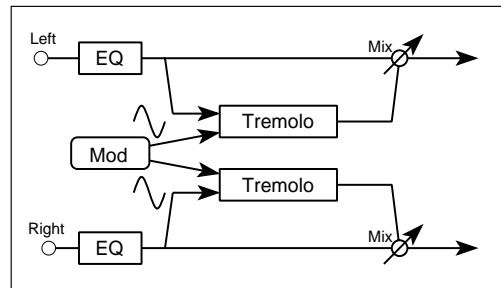

17A Auto Pan ϕ	17B Auto Pan ϕ	17C Auto Pan ϕ
SIN NodShape+99	Mod80 M.SP1.59Hz	EQ.L+00dB H+00dB
17A	17B	17C

LCD	Parameter	Range	Description
17A	Mod Waveform	Sine (SIN) Triangle (TRI)	Modulation waveform
	Mod Shape (Mod Shape)	-99...+99	
17B	Mod Depth (Mod)	0-99	Modulation depth
	Mod Speed (M.SP)	0.03-30 Hz	Modulation speed
17C	EQ Low (EQ.L)	-12...+12 dB	Low EQ cut and boost
	EQ High (H)	-12...+12 dB	High EQ cut and boost

For effects 35 and 36, dynamic modulation (16C) can be used to control the DRY:EFF balance.

The EQ sections of this effect are active even when the effect is switched OFF. To bypass this effect completely, select 0:No Effect.

Parametric EQ

37: Parametric EQ

This is a 3-band parametric equalizer, with independent gain and frequency controls for each band. The width of the mid-frequency band is variable.

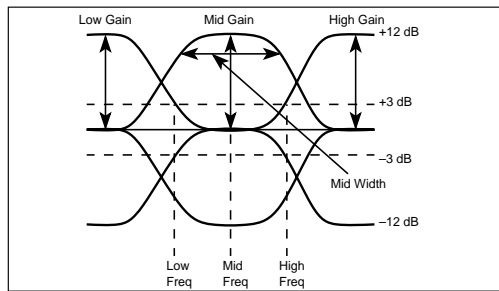
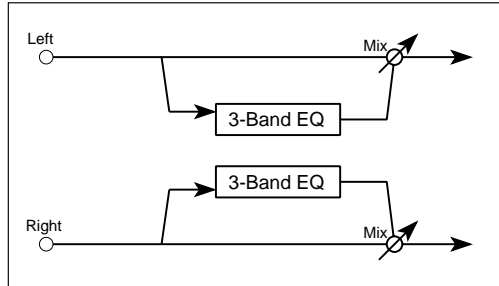

17A Para. EQ ϕ LowFrq12 Gain+12	17B Para. EQ ϕ MidFrq08 Gain+12	17C Para. EQ ϕ MidWidth=58	17D Para. EQ ϕ Hi Frq20 Gain+12
17A	17B	17C	17D

LCD	Parameter	Range	Description
17A	Low Freq (LowFrq)	0-29	Low cutoff frequency
	Low Gain (Gain)	-12...+12 dB	Low EQ cut and boost
17B	Mid Freq (MidFrq)	0-99	Mid center frequency
	Mid Gain (Gain)	-12...+12 dB	Mid EQ cut and boost
17C	Mid Width (MidWidth)	0-99	Mid band width
17D	High Freq (Hi Frq)	0-29	High cutoff frequency
	High Gain (Gain)	-12...+12 dB	High EQ cut and boost

For effect 37, dynamic modulation (16C) can be used to control the Mid Freq parameter. This is useful for creating a wah type effect.

Combination Effects: Serial

Effects 38 and 39 use mono input–stereo output chorus/flangers in series with stereo delays.

38: Chorus–Delay

This effect consists of a chorus and delay in series. The input signals are summed, then fed to two chorus units. The modulation signals fed to each chorus are 90 degrees out of phase with each other. Feedback parameters are available for both chorus and delay.

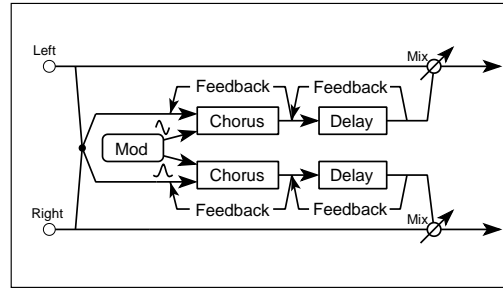

39: Flanger–Delay

This effect consists of a flanger and delay in series. The input signals are summed, then fed to two flanger units. The modulation signals fed to each flanger are 90 degrees out of phase with each other. Feedback parameters are available for both flanger and delay.

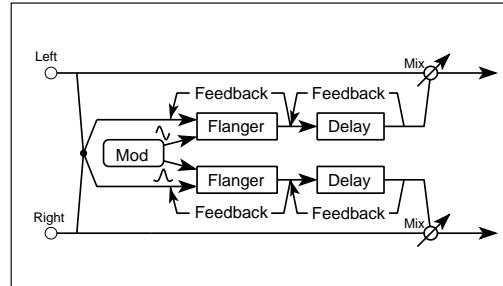

17A Chor-Dly Cho.DT11ms	ϕ FB+10	17B Chor-Dly Cho.Mod50	ϕ M.SP30	17C Chor-Dly Dly.DT110	ϕ FB-10
17A		17B		17C	

Chorus, Flanger

LCD	Parameter	Range	Description
17A	Delay Time (Cho.DT)	0–50 ms	Chorus/Flanger delay time
	Feedback (FB)	–99...+99%	The amount of effected signal that is fed back into the effect. Minus values invert the feedback signal phase
17B	Mod Depth (Cho.Mod)	0–99	Modulation depth
	Mod Speed (M.SP)	1–99	Modulation speed

Delay

LCD	Parameter	Range	Description
17C	Delay Time (Dly.DT)	0–450 ms	Delay time (set in 2 ms steps)
	Delay Feedback (FB)	–99...+99%	The amount of delay signal that is fed back into the effect. Minus values invert the feedback signal phase

For effects 38 and 39, dynamic modulation (16C) can be used to control the DRY:EFF balance.

Combined Effects: Parallel

Effects 40 to 47 are arranged in parallel. This means that two signals can be fed independently to two separate effects. For Example, with effect 40 (Delay/Hall Reverb), the left channel feeds a delay, while the right channel feeds a hall reverb.

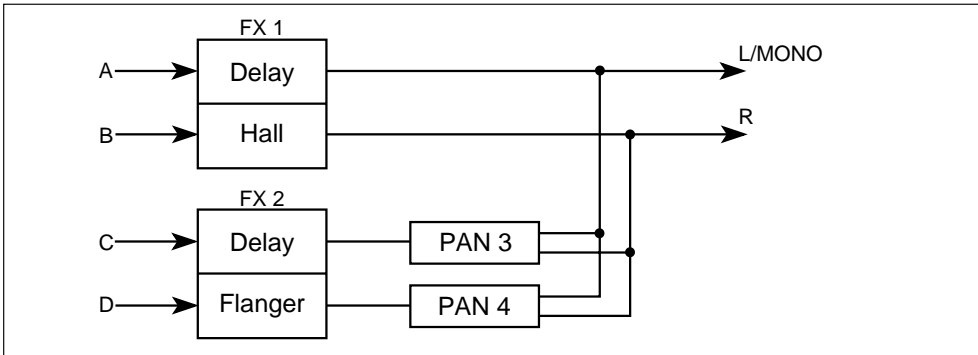

For details about the individual effects used in these combined effects, refer to the descriptions for effects 1 to 34.

Mono Delay/Reverb

40: Delay/Hall Reverb

This effect consists of two independent effects: delay on the left channel and hall type reverb on the right.

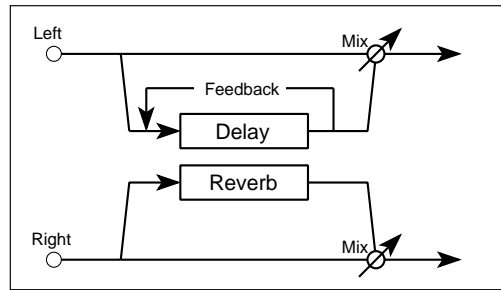

41: Delay/Room Reverb

This effect consists of two independent effects: delay on the left channel and room type reverb on the right.

17A Delay(L)	φ	17B Delay(L)	φ	17C Hall(R)	φ	17D Hall(R)	φ
Time250ms	FB+50	H.Dmp10		Time3.5s	H.Dmp40	P.Dly055ms	
17A		17B		17C		17D	

Mono Delay/Modulated Delay

42: Delay/Chorus

This effect consists of two independent effects: delay on the left channel and chorus on the right.

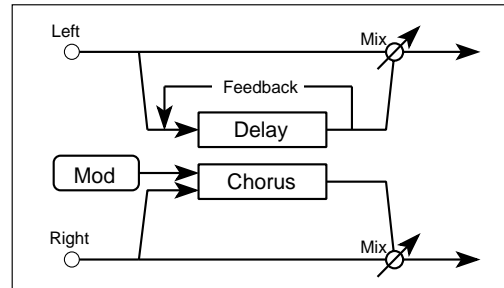

17A Delay(L) ϕ	17B Delay(L) ϕ	17C Chorus(R) ϕ	17D Chorus(R) ϕ
Time250ms FB+50	H.Dmp10	Mod60 M.SP0.30Hz	TRI
17A	17B	17C	17D

43: Delay/Flanger

This effect consists of two effects: delay on the left channel and flanger on the right.

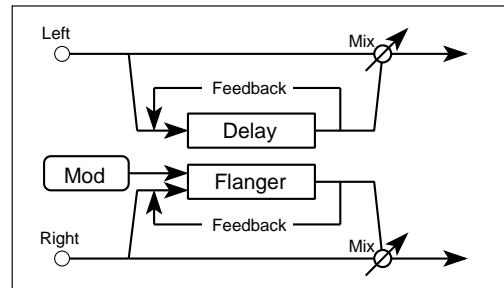

17A Delay(L) ϕ	17B Delay(L) ϕ	17C Flanger(R) ϕ	17D Flanger(R) ϕ
Time250ms FB+50	H.Dmp10	Mod70 M.SP0.18Hz	FB-75
17A	17B	17C	17D

Mono Delay/Phaser

46: Delay/Phaser

This effect consists of two effects: delay on the left channel and phaser on the right.

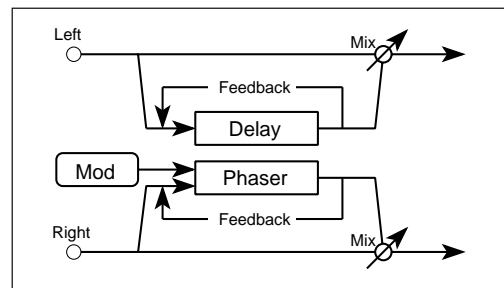

17A Delay(L) ϕ	17B Delay(L) ϕ	17C Phaser(R) ϕ	17D Phaser(R) ϕ
Time250ms FB+50	H.Dmp10	Mod60 M.SP0.69Hz	FB-75
17A	17B	17C	17D

Delay

LCD	Parameter	Range	Description
17A	Delay Time (Time)	0–500 ms	Delay time
	Feedback (FB)	–99...+99%	The amount of delay signal that is fed back into the effect. Minus values invert the feedback signal phase
17B	High Damp (H.Dmp)	0–99%	High frequency decay

Hall, Room

LCD	Parameter	Range	Description
17C	Reverb Time (Time)	0.2–9.9 sec (Hall)	The time over which the reverb effect will last
		0.2–4.9 sec (Room)	
	High Damp (H.Dmp)	0–99%	High frequency decay 0 = bright reverb 99 = dark reverb
17D	Pre Delay (P.Dly)	0–150 ms	The delay between the original sound and the early reflections

Chorus

LCD	Parameter	Range	Description
17C	Mod Depth (Mod)	0–99%	Modulation depth
	Mod Speed (M.SP)	0.03–30 Hz	Modulation speed
17D	Mod Waveform	Sine (SIN) Triangle (TRI)	Modulation waveform

Flanger

LCD	Parameter	Range	Description
17C	Mod Depth (Mod)	0–99%	Modulation depth
	Mod Speed (M.SP)	0.03–30 Hz	Modulation speed
17D	Feedback (FB)	–99...+99%	The amount of effected signal that is fed back into the effect. Minus values invert the feedback signal phase

Phaser

LCD	Parameter	Range	Description
17C	Mod Depth (Mod)	0–99%	Modulation depth
	Mod Speed (M.SP)	0.03–30 Hz	Modulation speed
17D	Feedback (FB)	–99...+99%	The amount of phased signal that is fed back into the effect. Minus values invert the feedback signal phase

For effects 40, 41, 42, 43 and 46, dynamic modulation (16C) can be used to control the DRY:EFF balance.

Mono Delay/Distortion, Overdrive

44: Delay/Distortion

This effect consists of two effects: delay on the left channel and distortion on the right channel.

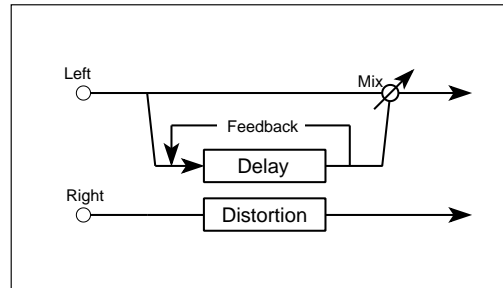

45: Delay/Overdrive

This effect consists of two effects: delay on the left channel and overdrive on the right channel.

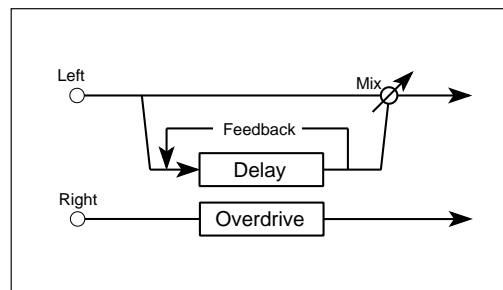

17A Delay(L) Time250ms	ϕ FB+40	17B Dist(R) Drive=111 Res=75	ϕ	17C Dist(R) H.Spot50 Level05	ϕ
17A		17B		17C	

Mono Delay/Rotary

47: Delay/Rotary Speaker

This effect consists of two effects: delay on the left channel and rotary speaker on the right channel.

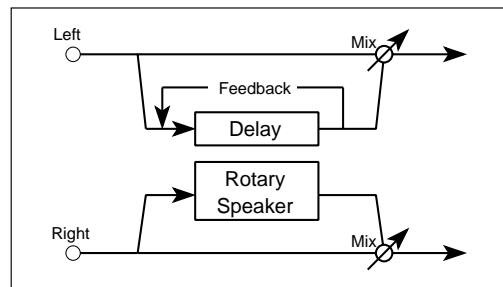

17A Delay(L) Time250ms	ϕ FB+40	17B Rot.SP(L) Acceleration=04	ϕ	17C Rot.SP(R) Speed S=25 F=70	ϕ
17A		17B		17C	

Delay

LCD	Parameter	Range	Description
17A	Delay Time (Time)	0–500 ms	Delay time
	Feedback (FB)	–99...+99%	The amount of delay signal that is fed back into the effect. Minus values invert the feedback signal phase

Distortion, Overdrive

LCD	Parameter	Range	Description
17B	Drive (Drive)	1-111	Distortion/Overdrive level
	Resonance (Res)	0-99	Gain of the resonant wah filter
17C	Hot Spot (H.Spot)	1-99	The wah filter frequency where it all happens
	Level (Level)	1-99	Distortion output level

Rotary Speaker

LCD	Parameter	Range	Description
17B	Acceleration (Acceleration)	1-15	Time taken to change from one speed to the other
17C	Slow Speed (S)	1-99	Slow rotation speed
	Fast Speed (F)	1-99	Fast rotation speed

For effect 47, dynamic modulation (16C) can be used to switch the speed change direction.

Effect Parameter Table

		Reverb Time		Pre Delay		E.R Level		High Damp	
1	Hall	0.2–9.9 sec (2.3)		0–200 ms (60)		0–99 (62)		0–99% (31)	
2	Ensemble Hall	0.2–9.9 sec (3.1)		0–200 ms (15)		0–99 (23)		0–99% (32)	
3	Concert Hall	0.2–9.9 sec (3.3)		0–200 ms (80)		0–99 (46)		0–99% (41)	
4	Room	0.2–4.9 sec (1.3)		0–200 ms (8)		0–99 (68)		0–99% (36)	
5	Large Room	0.2–4.9 sec (2.4)		0–200 ms (25)		0–99 (51)		0–99% (32)	
6	Live Stage	0.2–4.9 sec (2.2)		0–200 ms (12)		0–99 (81)		0–99% (36)	
7	Wet Plate	0–99 (59)		0–200 ms (29)		1–10 (7)		0–99% (51)	
8	Dry Plate	0–99 (30)		0–200 ms (26)		1–10 (5)		0–99% (47)	
9	Spring Reverb	0–99 (25)		0–200 ms (0)		1–10 (9)		0–99% (30)	
		E.R Time				Pre Delay			
10	Early Reflection 1	100–800 ms (220)				0–200 ms (0)			
11	Early Reflection 2	100–800 ms (180)				0–200 ms (30)			
12	Early Reflection 3	100–800 ms (300)				0–200 ms (90)			
		Delay Time L		Delay Time R		Feedback		High Damp	
13	Stereo Delay	0–500 ms (185)		0–500 ms (370)		–99...+99% (–40)		0–99% (10)	
14	Cross Delay	0–500 ms (190)		0–500 ms (380)		–99...+99% (+40)		0–99% (10)	
		Delay Time L		Feedback L		High Damp L		Dry:Effect Mix L	
15	Dual Mono Delay	0–500 ms (20)		–99...+99% (0)		0–99% (0)		Dry–Effect (50:50)	
		Delay Time 1		Delay Time 2		Feedback			
16	Multi-Tap Delay 1	0–500 ms (175)		0–500 ms (350)				–99...+99% (+30)	
17	Multi-Tap Delay 2	0–500 ms (200)		0–500 ms (400)				–99...+99% (0)	
18	Multi-Tap Delay 3	0–500 ms (250)		0–500 ms (500)				–99...+99% (+20)	
		Delay Time		Mod Speed		Mod Depth		Mod Waveform	
19	Chorus 1	0–200 ms (3)		0.03–30 Hz (0.33)		0–99 (99)		SIN, TRI (TRI)	
20	Chorus 2	0–200 ms (2)		0.03–30 Hz (0.42)		0–99 (84)		SIN, TRI (TRI)	
		Delay Time L		Delay Time R		Mod Speed		Mod Depth	
21	Quadrature Chorus	0–250 ms (24)		0–250 ms (12)		● 1–99 (30)		0–99 (50)	
22	Crossover Chorus	0–250 ms (2)		0–250 ms (24)		● 1–99 (16)		0–99 (99)	
		Delay Time L		Delay Time R				Mod Speed	
23	Harmonic Chorus	0–500 ms (4)		0–500 ms (12)				● 1–99 (36)	
		Mod Depth							
24	Symphonic Ensemble	0–99 (92)							
		Delay Time		Mod Depth		Mod Speed			
25	Flanger 1	0–200 ms (5)		0–99 (50)		● 1–99 (20)			
26	Flanger 2	0–200 ms (24)		0–99 (99)		● 1–99 (42)			
27	Crossover Flanger	0–200 ms (1)		0–99 (60)		● 1–99 (22)			
		Blend				Emphatic Point			
28	Exciter	–99...+99 (+60)				1–10 (1)			
		Harmonic Density		Hot Spot		Stereo Width		Delay Time	
29	Enhancer	1–99 (28)		1–20 (3)		0–99 (85)		1–99 (25)	
		Drive		Hot Spot		Resonance		EQ Low	
30	Distortion	1–111 (107)		● 0–99 (99)		0–99 (7)		–12...+12 dB (0)	
31	Overdrive	1–111 (85)		● 0–99 (70)		0–99 (63)		–12...+12 dB (0)	
		Manual		Mod Speed		Mod Depth		Feedback	
32	Stereo Phaser 1	0–99 (98)		● 0.03–30 Hz (0.24)		0–99 (90)		–99...+99% (+96)	
33	Stereo Phaser 2	0–99 (96)		● 0.03–30 Hz (0.24)		0–99 (90)		–99...+99% (+90)	
		Vibrato Depth				Acceleration		Slow Speed	
34	Rotary Speaker ✱	0–15 (2)				1–15 (12)		1–99 (25)	
		Mod Waveform		Mod Wave Shape		Mod Speed		Mod Depth	
35	Auto Pan	SIN, TRI (TRI)		–99...+99 (+96)		0.03–30 Hz (0.21)		0–99 (96)	
36	Tremolo	SIN, TRI (TRI)		–99...+99 (–99)		0.03–30 Hz (3.9)		0–99 (99)	
		Low Freq		Low Gain		Mid Freq		Mid Gain	
37	Parametric EQ	0–29 (15)		–12...+12 dB (+6)		● 0–99 (50)		–12...+12 dB (+6)	
		Fig/Cho Delay		Fig/Cho Feedback		Mod Speed		Mod Depth	
38	Chorus–Delay	0–50 ms (24)		–99...+99% (+24)		1–99 (12)		0–99 (75)	
39	Flanger–Delay	0–50 ms (1)		–99...+99% (+80)		1–99 (4)		0–99 (99)	
		Delay Time		Feedback		High Damp		Dry:Effect Mix	
40	Delay/Hall Reverb	0–500 ms (30)		–99...+99% (0)		0–99% (0)		● Dry–Effect (FX)	
41	Delay/Room Reverb	0–500 ms (20)		–99...+99% (0)		0–99% (0)		● Dry–Effect (FX)	
		Delay Time		Feedback		High Damp		Dry:Effect Mix	
42	Delay/Chorus	0–500 ms (220)		–99...+99% (+15)		0–99% (50)		● Dry–Effect (70:30)	
		Delay Time		Feedback		High Damp		Dry:Effect Mix	
43	Delay/Flanger	0–500 ms (400)		–99...+99% (+20)		0–99% (60)		● Dry–Effect (70:30)	
		Delay Time		Feedback				Dry:Effect Mix	
44	Delay/Distortion	0–500 ms (250)		–99...+99% (+40)				● Dry–Effect (79:21)	
45	Delay/Overdrive	0–500 ms (350)		–99...+99% (+50)				● Dry–Effect (75:25)	
		Delay Time		Feedback		High Damp		Dry:Effect Mix	
46	Delay/Phaser	0–500 ms (300)		–99...+99% (+15)		0–99% (60)		● Dry–Effect (60:40)	
		Delay Time		Feedback				Dry:Effect Mix	
47	Delay/Rotary Speaker ✱	0–500 ms (280)		–99...+99% (+15)				Dry–Effect (70:30)	

	EQ Low	EQ High	Dry:Effect Mix
	-12...+12 dB (-3)	-12...+12 dB (-1)	● Dry-Effect (80:20)
	-12...+12 dB (-1)	-12...+12 dB (-3)	● Dry-Effect (80:20)
	-12...+12 dB (-2)	-12...+12 dB (-4)	● Dry-Effect (80:20)
	-12...+12 dB (+1)	-12...+12 dB (+2)	● Dry-Effect (78:22)
	-12...+12 dB (-1)	-12...+12 dB (+2)	● Dry-Effect (78:22)
	-12...+12 dB (-5)	-12...+12 dB (-4)	● Dry-Effect (75:25)
	-12...+12 dB (0)	-12...+12 dB (-4)	● Dry-Effect (80:20)
	-12...+12 dB (+2)	-12...+12 dB (+2)	● Dry-Effect (80:20)
	-12...+12 dB (+2)	-12...+12 dB (-4)	● Dry-Effect (78:22)
	EQ Low	EQ High	Dry:Effect Mix
	-12...+12 dB (-4)	-12...+12 dB (-4)	● Dry-Effect (68:32)
	-12...+12 dB (+1)	-12...+12 dB (0)	● Dry-Effect (65:35)
	-12...+12 dB (0)	-12...+12 dB (0)	● Dry-Effect (75:25)
	EQ Low	EQ High	Dry:Effect Mix
	-12...+12 dB (0)	-12...+12 dB (0)	● Dry-Effect (80:20)
	-12...+12 dB (0)	-12...+12 dB (0)	● Dry-Effect (80:20)
Delay Time R	Feedback R	High Damp R	Dry:Effect Mix R
0-500 ms (40)	-99...+99% (0)	0-99% (0)	● Dry-Effect (50:50)
	EQ Low	EQ High	Dry:Effect Mix
	-12...+12 dB (0)	-12...+12 dB (0)	● Dry-Effect (80:20)
	-12...+12 dB (0)	-12...+12 dB (0)	● Dry-Effect (70:30)
	-12...+12 dB (0)	-12...+12 dB (0)	● Dry-Effect (75:25)
	EQ Low	EQ High	Dry:Effect Mix
	-12...+12 dB (+4)	-12...+12 dB (+4)	● Dry-Effect (50:50)
	-12...+12 dB (+3)	-12...+12 dB (+4)	● Dry-Effect (60:40)
Mod Waveform	EQ Low	EQ High	Dry:Effect Mix
T+10...S+10 (T+00)	-12...+12 dB (0)	-12...+12 dB (0)	Dry-Effect (50:50)
T+10...S+10 (T+00)	-12...+12 dB (0)	-12...+12 dB (0)	Dry-Effect (50:50)
Mod Depth	Split Point		Dry:Effect Mix
0-99 (99)	0-18 (3)		Dry-Effect (25:75)
	EQ Low	EQ High	Dry:Effect Mix
	-12...+12 dB (0)	-12...+12 dB (0)	● Dry-Effect (67:33)
Resonance	EQ Low	EQ High	Dry:Effect Mix
-99...+99% (+80)	-12...+12 dB (0)	-12...+12 dB (0)	Dry-Effect (50:50)
-99...+99% (+36)	-12...+12 dB (0)	-12...+12 dB (0)	Dry-Effect (50:50)
-99...+99% (+80)	-12...+12 dB (0)	-12...+12 dB (0)	Dry-Effect (50:50)
	EQ Low	EQ High	Dry:Effect Mix
	-12...+12 dB (+3)	-12...+12 dB (+3)	● Dry-Effect (50:50)
	EQ Low	EQ High	Dry:Effect Mix
	-12...+12 dB (0)	-12...+12 dB (0)	● Dry-Effect (50:50)
EQ High	Output Level		Dry:Effect Mix
-12...+12 dB (0)	0-99 (6)		Dry-Effect (50:50)
-12...+12 dB (0)	0-99 (8)		Dry-Effect (50:50)
Mod waveform			Dry:Effect Mix
SIN, TRI (TRI)			Dry-Effect (50:50)
SIN, TRI (SIN)			Dry-Effect (50:50)
Fast Speed			Dry:Effect Mix
1-99 (69)			Dry-Effect (34:66)
	EQ Low	EQ High	Dry:Effect Mix
	-12...+12 dB (0)	-12...+12 dB (0)	● Dry-Effect (20:80)
	-12...+12 dB (0)	-12...+12 dB (0)	● Dry-Effect (50:50)
Mid Width	High Freq	High Gain	Dry:Effect Mix
0-99 (50)	0-29 (12)	-12...+12 dB (+6)	Dry-Effect (50:50)
Delay Time	Feedback		Dry:Effect Mix
0-450 ms (120)	-99...+99% (+16)		● Dry-Effect (60:40)
0-450 ms (300)	-99...+99% (+30)		● Dry-Effect (50:50)
Reverb Time	Pre Delay	High Damp	Dry:Effect Mix
0.2-9.9 sec (3.0)	0-150 ms (68)	0-99% (34)	● Dry-Effect (70:30)
0.2-4.9 sec (1.1)	0-150 ms (0)	0-99% (28)	● Dry-Effect (65:35)
Mod Speed	Mod Depth	Mod Waveform	Dry:Effect Mix
0.03-30 Hz (0.39)	0-99 (99)	SIN, TRI (TRI)	● Dry-Effect (50:50)
Mod Speed	Mod Depth	Feedback	Dry:Effect Mix
0.03-30 Hz (0.21)	0-99 (96)	-99...+99% (-75)	● Dry-Effect (50:50)
Drive	Hot Spot	Resonance	Output Level
1-111 (105)	1-99 (99)	0-99 (7)	1-99 (10)
1-111 (65)	1-99 (90)	0-99 (63)	1-99 (20)
Mod Speed	Mod Depth	Feedback	Dry:Effect Mix
0.03-30 Hz (0.69)	0-99 (90)	-99...+99% (+99)	● Dry-Effect (25:75)
Acceleration	Slow Speed	Fast Speed	Dry:Effect Mix
1-15 (10)	1-99 (25)	1-99 (69)	● Dry-Effect (30:70)

5. Global Parameters

- Settings made in this mode are memorized even when the power is turned off. It is not necessary to write these settings into memory.

Functions in Global Mode

Key operations:

Selecting a page [PAGE+] key, [PAGE-] key

Selecting a parameter [√] key, [Ⓜ] key

Setting a parameter value [▲] key, [▼] key.

LCD	Parameters	Description
0A	Master Tune	Overall pitch adjustment
0B	Transpose	Overall transposition
0C	Velocity Curve, After Touch Curve	Velocity curve and After Touch curve settings
0D	Computer Select	Sets PC I/F clock.
1A–1G	Scale Type/User Scale	Sets the scale type and the user scale
1H, 1I	Sub Scale	Sets the sub scale
2A	Global MIDI Channel	Specifies MIDI Global Channel, and filters note data
2B	External Out Select	Selects MIDI OUT or TO HOST for data transmission.
2C, 2D	MIDI Filter	Transmission/reception switches for MIDI messages
3A, 3B	Prog.Protect, Combi. Protect	Memory protect (Program, Combination)
3C	Page Memory	Sets the page memory function
4A	MIDI Data Dump	Transmits various parameters as MIDI exclusive messages
5A	Preset Data Load	Loads preset data
6A–6D	Drum Kit 1	Assign drum sounds
7A–7D	Drum Kit 2	Assign drum sounds
8A	Copy Drum Kit	Copy Drum Kit data

Saving Global Setup Data

All global settings are stored when the X5DR is powered off. You do not need to use the Write function to save them.

0A – 0E Master Tune/Transpose/Velocity Curve/After Touch Curve/Computer Select

Here, you can tune the X5DR, and set the responses and baud rate for communication with a computer.

00A MASTERTUNE Tune+00:440.00Hz	00B TRANPOSE Trans+00	00C CURVE Vel=3 Aft=3	00D PC I/F CLK 31.25kBPS
0A	0B	0C	0D

LCD	Parameter	Range	Description
0A	Master Tune (Tune)	-50 ... +50	Used to tune the X5DR in cent steps.
0B	Transpose (Trans)	-12 ... +12	Used to transpose the X5DR in semitone steps.
0C	Velocity curve (Vel)	1-8	Velocity response curve
	After Touch curve (Aft)	1-8	After Touch response curve
0D	Computer Select	31.25 kBPS 38.4 kBPS	Baud rate setting for communication with a computer

0A Master Tune: This function allows you to tune the X5DR. The selected tuning is indicated in steps and Hz. 0 cents is equal to 440Hz (A4).

The X5DR can also be tuned from external MIDI devices that can output MIDI RPN Fine Tune messages (the X5DR cannot output these messages). In Multi mode, these messages are received on the MIDI Channels specified for each track and control the Detune parameters. In all other modes, they are received on the Global MIDI Channel and control the Master Tune function. Refer to page 71 for MIDI RPN Fine Tune messages.

0B Transpose: This function allows you to transpose the X5DR in semitone steps. This is useful when you want to play a song in a different key.

0C Velocity Curve: This parameter allows you to adjust the velocity response. A low setting requires strong playing to achieve the maximum value (insensitive). A high setting will achieve the maximum value with soft playing (sensitive). Select one of the eight curves to suit your playing style.

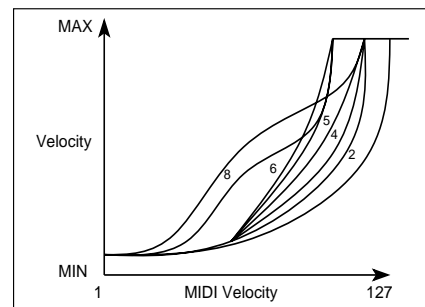

Curves 7 and 8 are suitable when you do not need velocity, or when you wish to make the intensity of the sound even, since changes are not obvious when playing moderately. However, Curves 7 and 8 are difficult to control, because even soft playing will generate significant changes.

Vel. Curve

1. Strong playing produces an obvious effect.
2. ?
3. Standard curve
4. ?
5. ?
6. Moderate playing produces an obvious effect.
7. Small changes and a constant effect with moderate playing
8. Similar to Curve 7, but slightly flatter.

After Touch Curve: This parameter allows you to adjust the response of After Touch (how forcefully you press down the keys) applied by a keyboard connected to X5DR's MIDI IN (such as the X3) or sent from a sequencer. Select one of the eight curves.

This function affects data generated by the tone generator and data received at MIDI OUT/TO HOST. It does not affect output data.

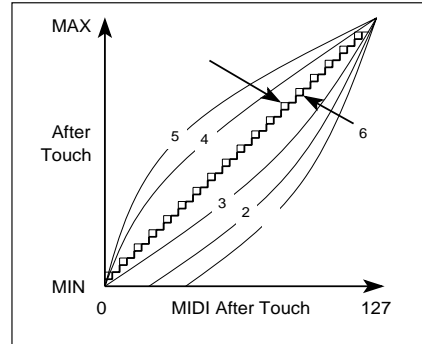

Curves 6 and 7 change in steps of 24 and 12, respectively. Curve 7 changes in steps of 12, and allows the pitch to change in semitones when pitch shift width for After Touch is set to one octave. Curve 8 is random. You can use this when you wish to achieve a special effect or give an irregular pitch shift through After Touch.

After Touch Curve

1. Strong playing produces an obvious effect.
2. \curvearrowright
3. Standard curve
4. \curvearrowleft
5. Moderate playing produces an obvious effect.
6. A little bit coarse (24 steps)
7. More coarse (12 steps)
8. Random

0D Computer Select: This parameter allows you to set the baud rate for communication with a personal computer connected to the TO HOST connector on the rear panel.

- IBM PC compatible computers 38.4 kBPS
- Apple Macintosh series computers 31.25 kBPS

1A – 1I Keyboard Scale

This function allows you to select scales. You can also create your own scale.

01A SCALE TYPE User Scale	01B SCALE KEY Key=C	01C User Scale ϕ C+00 C#+00 D+00	01D User Scale ϕ D#+00 E+00 F+00	01E User Scale ϕ F#+00 G+00 G#+00
1A	1B	1C	1D	1E
01F User Scale ϕ A+00 A#+00 B+00	01G Copy SCALE ϕ Slendro OK?	01H SUB SCALE Equal Temp	01I SUB KEY ϕ Key=C	
1F	1G	1H	1I	

LCD	Parameter	Range	Description	
1A	Scale Type	Equal Temperament	Most commonly used equal temperament scale. Songs can easily be transposed into different keys.	
		Equal Temperament2	Like equal temperament, but with slight random pitch variations between subsequent key presses. This is useful for simulating the unstable pitch of an acoustic instrument.	
		Pure Major	Intervals such as third and fifth are perfectly in tune. Other intervals will correspondingly be out of tune, so you must specify a key. See LCD screen 1B.	
		Pure Minor	Like the pure major scale, but minor.	
		Arabic (quarter tone scales often used in Arabic music)	Scale	Key
			RAST DO / BAYATI RE	C
			RAST FA / BAYATI SOL	F
			RAST SOL / BAYATI LA	G
			RAST RE / BAYATI MI	D
		RAST SI / BAYATI DO	A \sharp (B \flat)	
		Pythagorean	Ancient Greek tuning, useful when playing melodies	
		Werkmeister	Equal temperament style that was used in the latter part of the baroque period.	
		Kirnberger	Developed in the 18th Century, used mainly for harpsichord.	
Slendro	Indonesian gamelan tuning with 5 notes per octave. When key is set to C, notes C, D, F, G, A are used. Other notes are set to equal temperament.			
Pelog	Like the slendro scale, but with 7 notes per octave. When key is set to C, notes C, D, E, F, G, A, B are used.			
User Scale	This allows you to create your own tuning, and is set up using LCD screens 1C to 1F.			
1B	Scale Key	C–B	Specifies the tonic (key note) of the scale.	
1C	User Scale	C C# D	–99...+99	Used to tune the individual notes for the user scale in 1 cent steps
1D		D# E F		
1E		F# G G#		
1F		A A# B		
1G		Copy Scale		
	OK to Copy	OK?	Executes scale copy	
1H	Sub Scale Type	Same as 1A	See 1A descriptions	
1I	Sub Scale Key (Key)	C–B	Specifies the tonic (key note) of the sub scale	

1A Scale Type: In addition to the usual equal temperament scale, 11 other scales, including a user-definable scale, are available.

1B,1I Scale Key: In this case, specify a Scale key (C-B) except Equal Temperament.

When Arabic is used and the Scale Key is “C,” the notes E and B are lowered by 52 cents (RAST DO/BAYATI RE). Changing the Scale Key allows you to select other scales. The following table shows the scales and keys frequently used in Arabic music.

Scale	Key
RAST DO/BAYATI RE	C
RAST FA/BAYATI SOL	F
RAST SOL/BAYATI LA	G
RAST RE/BAYATI MI	D
RAST SI ^b /BAYATI DO	A # (B ^b)

1C–1F User Scale: This scale allows you to define your own personal tuning scale. The tuning of each keyboard note can be adjusted ± 99 cents on LCD screens 1C to 1F. To edit one of the preset scales, first copy it (1G), then edit it as a user scale.

The User Scale settings are used by both the main and the sub.

1G Copy Scale: This is used to create your own scale based on one of the preset scales. The scale selected here is copied to the user scale to enable you to edit it using pages 1C–1F.

1H Sub Scale: It is possible to switch between two scales, main and sub, using a pedal switch connected to a keyboard such as the X3.

If MIDI message [Bn, 04, 00–3F] (Controller #04 is set to 0–63) is received, the main scale is selected. If the MIDI message [Bn, 04, 40–7F] (controller #04 is set to 64–127) is received, the sub scale is selected. In Combination mode, scales can be selected by any Timbre. In Multi mode, they can be selected by any Track. So, for example, you could have one Timbre playing the melody with the Arabic scale, and another Timbre playing the backing with an Equal Temperament scale.

- User scale settings are shared by the main scale and sub scale.

2A – 2D Global MIDI Channel, Note Receive Filter, External Out Select & MIDI Filter

These pages allow you to set the parameters related to MIDI transmission and reception.

02A MIDI GLOBAL CH= 1 NoteR:ALL	02B EXT OUT SEL: MIDI	02C MIDI FILTER PRG:ENA AFT:ENA	02D MIDI FILTER CTRL:ENA EX:DIS
2A	2B	2C	2D

LCD	Parameter	Range	Description
2A	Global MIDI Channel (CH)	1–16	Sets the Global MIDI Channel.
	Note Receive Filter (Note R)	EVEN ODD ALL	Responds to even notes only. Responds to odd notes only. Responds to all notes.
2B	External Out Select	MIDI PCIF	X5DR data is output via MIDI OUT X5DR data is output via TO HOST
2C	Program Change Filter (PRG)	DIS ENA PRG NUM	Program Change operation disabled Program Change messages select Combinations and Programs Program Change messages select only Programs (not Combinations) MIDI Bank Select messages are not sent or received; only Program Change messages are received and sent.
	After Touch Filter (AFT)	DIS ENA	After Touch receive disabled After Touch receive enabled
2D	MIDI Controller Filter (CTRL)	DIS ENA	MIDI Controller receive disabled MIDI Controllers receive
	System Exclusive Filter (EX)	DIS ENA	System Exclusive operation disabled System Exclusive data sent and received

- 2A Global MIDI Channel:** The Global MIDI Channel is used as follows: to receive MIDI data in Program mode, to select Combinations in Combination mode (when MIDI Filter PRG is set to ENA or NUM), to control effects, and to send System exclusive messages.

All MIDI data on the X5DR is transmitted on the Global MIDI Channel.

MIDI data for individual Timbres in a Combination and tracks in a song is received on the MIDI Channels specified in Combination Edit mode (Timbres) and Multi mode (tracks), respectively.

In Combination mode, when a Program Change message is received on the Global MIDI Channel, a Combination is selected. So, to play a Combination from an external MIDI device, set the Global MIDI Channel and the Timbre MIDI Channels differently.

MIDI data on the Global MIDI channel is used to control the effects (ON/OFF and Dynamic Modulation).

Note Receive Filter: The filter is applied to the received note numbers. Normally, this should be set to ALL. However, if you want to increase the number of available notes by using another X5DR, X5 or tone generator simultaneously, feed data to both tone generators, and set one to ODD and the other to EVEN.

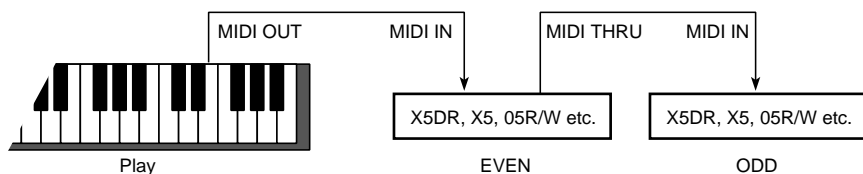

2B External Out Select: This parameter determines whether the X5DR data (output when you operate the controls on the panel) is transmitted from MIDI OUT or TO HOST connector.

Select "MIDI" to transmit the X5DR data to an external MIDI device with its MIDI IN connected to the MIDI OUT connector on the X5DR. Select "PCIF" to output data to a computer connected to the TO HOST connector on the X5DR.

The X5DR receives data input at MIDI IN or TO HOST regardless of this parameter setting.

2C Program Change Filter:

When DIS is selected, MIDI Program Change messages are neither sent nor received.

When ENA is selected, MIDI Program Change messages received on the Global MIDI Channel select Programs in Program mode, and Combinations in Combination mode. MIDI Bank Select messages select banks in the selected mode. In Combination mode, MIDI Program Change messages received on other channels select Programs for corresponding Timbres. If the Global MIDI Channel and a Timbre's MIDI Channel are set the same, the Global MIDI Channel has priority and a Combination will be selected. In Multi mode, MIDI Program Change messages select Programs on tracks set to the corresponding MIDI Channel.

When PRG is selected, MIDI Program Change messages received on the Global MIDI Channel select Programs in Program mode, but in Combination mode they select Timbre Programs. MIDI Bank Select messages select banks in the selected mode.

When NUM is selected, operation is basically the same as for ENA except that MIDI Bank Select messages are ignored.

The following table shows the Program Change and Bank Select receive conditions.

Mode		DIS	ENA	PRG	NUM
Program Play	Program No.	X	O	O	q
Combination Play	Combination No.	X	q	X	q
Combination Play	Timbre Program No.	X	O	O	q
MULTI	Track Program No.	X	O	O	q

- X — Not received
- q — Program Change received only
- O — Program Change and Bank Select received

With the ENA or PRG setting, changing Programs in Program play mode will cause Program Change and Bank Select messages to be transmitted. Changing Combinations in Combination Play mode will cause only Program Change messages to be transmitted.

After Touch Filter: When this is set to DIS, After Touch messages are not received. The X5DR uses Channel After Touch only, not Polyphonic After Touch.

2D MIDI Controller filter: When the MIDI Controller filter is set to DIS, MIDI Controller messages such as Pitch Bend, Pitch modulation, and Volume are not received by the X5DR.

MIDI System Exclusive Filter: When the MIDI System Exclusive Filter is set to DIS, System Exclusive data for parameter editing is neither sent nor received by the X5DR. Normally, this should be set to DIS, however, when using an X5DR editing program on a personal computer, set it to ENA.

By connecting the MIDI OUT of one X5DR to the MIDI IN of another X5DR, and setting both System Exclusive filters to ENA, both X5DR's can be edited simultaneously.

Set this parameter to ENA so that the X5DR will receive the dump data. However, if 4A MIDI DUMP is selected and shown on the screen, the X5DR receives MIDI Dump data through MIDI System Exclusive messages even with this parameter set to "DIS."

3A – 3C Program/Combination Memory Protect & Page Memory

The Memory Protect functions allow you to protect Programs and Combinations, and the Page Memory function remembers the current LCD screen when you exit a mode.

03A PROTECT PROGRAM:OFF	03B PROTECT COMBINATION:OFF	03C PAGE MEMORY OFF
3A	3B	3C

LCD	Parameter	Range	Description
3A	Program Protect (PROGRAM)	OFF ON	Program memory is not protected. Program memory is protected.
3B	Combination Protect (COMBINATION)	OFF ON	Combination memory is not protected. Combination memory is protected.
3C	Page Memory	OFF ON	Page Memory function off Page Memory function on

- 3A Program Memory Protect:** When this parameter is set to on, you cannot write Programs to Bank A. Set this OFF before you write the edited data, before you load preset data, or before the X5DR receives MIDI Dump data.
- 3B Combination Memory Protect:** When this parameter is set to on, you cannot write Combinations on the X5DR. Set this OFF before you write the edited data, before you load preset data, or before the X5DR receives MIDI Dump data.
- 3C Page Memory:** The Page Memory function remembers the current LCD screen when you exit a mode. The next time you enter that particular mode, the same LCD screen is selected automatically.

In Multi mode, however, this function will not take you to the following parameter pages: Damper Pedal Filter, After Touch Filter, Control Change Filter, Key Window Bottom, and Velocity Window Bottom. Instead, a parameter page preceding these pages will be selected.

4A MIDI Data Dump

This page allows you to transmit X5DR data via Exclusive data to an external MIDI device, such as a MIDI data filer, computer, Korg 05R/W, or another X5DR.

When screen 4A is selected, MIDI Dump data can be sent and received even when the MIDI System Exclusive filter on 2D MIDI Filter is set to DIS.

04A MIDI DUMP PROG ↕MIDI OK?

4A

LCD	Parameter	Range	Description
4A	Dump Data	PROG COMBI MULTI GLOBAL D.KIT ALL	Dump 100 Programs in bank A Dump 100 Combinations Dump Multi setup data Dump Global setup data(0A-11) Dump 2 drum kits Dump all the above data
	External Out Dump Select	MIDI PCIF	Exclusive data is transmitted from MIDI OUT. Exclusive data is transmitted from TO HOST.
	OK to Data Dump	OK?	Executes Data Dump

Saving Data with MIDI Data Dump

- 1) To save X5DR data using MIDI Data Dump, you must connect a MIDI device capable of receiving MIDI Data Dump to the X5DR MIDI OUT, or connect a computer’s serial port to the X5DR’s TO HOST. If you are saving the data to a MIDI data filer, you do not need to set the MIDI Channels. However, if you are transferring the data to an X5DR, X5 or 05R/W, the Global MIDI Channel on both devices should be set the same.
- 2) Specify the X5DR data that you want to save.
- 3) “External Out Dump Select” on this page determines whether data is transmitted through MIDI OUT or through TO HOST. Set this to MIDI for transmission through MIDI OUT, and set it to PCIF through TO HOST. In this case, the setting of 2B External Out Select does not affect data transmission.
- 4) Position the cursor on OK?, then press the [▲] button to dump

When transmission is completed, “Completed” appears on the screen. Press the [▲] or [▼] button to return to the previous screen.

Note: While dumping, do not press any buttons.

The following table lists the data size and dump time for each Data Dump.

Type of Data Dump	Approx. Data Size	Approx. Dump Time (Seconds)
Program	18.7KByte	6.0
Combination	15.5KByte	5.0
Global setup	39Byte	0.1
Drum kit	1.0KByte	0.3
Multi	0.3KByte	0.1
All data	35.5KByte	11.4

If Multi or All data is selected for data dump, each data dump operation transmits dump data, followed by “Multi Setup Data (exp),” and two types of data is sent to the data filer.

You need to send these two types of data to set the parameters in Multi mode.

MULTI SETUP DATA (exp) is setup data for a Track except for the effect setting data in Multi mode. If Multi or ALL data is selected for data dump, only the effect settings in Multi mode are sent.

When you switch from Program Play mode to Program Edit mode while 2D MIDI System Exclusive is set to ENA, the parameters of the Program selected in Program Play mode are transmitted. If you select a Combination in Combination Play mode, the parameters of that Combination are transmitted (to the destination set in 2B).

Loading Data with MIDI Data Dump

- 1) To load the MIDI data back into the X5DR, connect the external MIDI device to the X5DRDR MIDI IN or a computer's serial port to the X5DR's TO HOST, and make sure that the external devices MIDI Channel matches the X5DR Global MIDI Channel.
- 2) If you are loading Program or Combination data, make sure that the respective memory protect function is set to off. See "3A – 3C Program/Combination Memory Protect & Page Memory" on page 153.
- 3) To transfer data, make sure that the channel on the transmit device is set to the Global MIDI Channel (If you send data saved in the data filer, set the Global MIDI Channel to the Global MIDI Channel on the transmit device that was selected when you saved the data.). See "MIDI Data Format" on page 163.

Dump Data Compatibility

Dump data is compatible between the X5DR and X5, although the following parameters are incompatible since the X5DR does not have a keyboard: Global mode parameters for the X5 keyboard (Local Control, Damper Pedal Polarity, Pedal Assign).

Dump data is compatible between the X5DR and 05R/W, although all the parameters in Multi mode except for the effect settings are incompatible.

When you send any of Programs that use Multisounds 340-429, and Drum Kits that use drum sounds 164-214 from the X5DR to the X5 or 05R/W, they are not assigned to Programs, or Drum Kits on the X5 or 05R/W. Therefore, no sound is produced.

Note: *Do not touch any switches on the X5DR during the data dump operation. If you wish to transmit multiple MIDI dump data files to the X5DR, send them one at a time. Do not try to send them all at once.*

5A Preset Data Load

These parameters allow you to load 100 Combinations, 100 Programs, two Drum Kits of Preset a or b, preset Multi Setup data, and preset Global data into the internal memory.

05A PRESET DATA
ALL PRE-b OK?

5A

LCD	Parameter	Range	Description
5A	Preset Data Load Source	ALL Combination (CMB) Program (PRG) Drum Kit (KIT)	Select a preset data source to load. Loads all data of Preset a or b, Multi data, and Global data. Loads one Combination of Preset a or b. Loads one Program of Preset a or b. Loads one Drum Kit of Preset a or b.
	Source ALL	PER-a, PER-b	(When ALL is selected:) Loads either Preset a or b, Multi Setup data, and Global data.
	Source PRG/CMB	a, b	(When CMB or PRG is selected:) Selects Preset a or b as a source.
	Source No. PRG/CMB	00–99	(When CMB or PRG is selected:) Selects a source Program/Combination number.
	Destination No. PRG/CMB	00–99	(When CMB or PRG is selected:) Selects a destination Program/Combination number.
	Source KIT	a, b	(When KIT is selected:) Selects Preset a or b as a source.
	Source No. KIT	K1, K2	(When KIT is selected:) Selects a source Drum Kit number.
	Destination No. KIT	K1, K2	(When KIT is selected:) Selects a destination Drum Kit number.
	OK to Load	OK?	Executes the Preset Data Load operation.

Use the [√], [Ⓜ], [▲], and [▼] keys to select data to load, move the cursor to “OK?”, and press the [▲] key to load. (The existing data in the internal memory will be overwritten and lost.)

The following data can be loaded:

Preset a:

- 100 Programs of Preset a
- 100 Combinations of Preset a
- Drum Kits 1, 2 of Preset a

Preset b:

- 100 Programs of Preset b
- 100 Combinations of Preset b
- Drum Kits 1, 2 of Preset b

Multi Setup data:

Default settings when the power is turned on (see page 114)

Global data:

- Master tune 0
- Transpose 0
- Velocity Curve 3
- After Touch Curve 3
- Scale Type Equal Temp
- Scale Key C
- User Scale –52 for E and B, 0 for others
- Sub Scale Type User Scale
- Sub Scale Key C
- MIDI Global channel 1
- Note Receive ALL
- External Out Select MIDI
- MIDI Filter NUM for PRG, DIS for EX, ENA for others

- Note that the Global Channel and MIDI filter are also initialized. PC/IF CLK and Page Memory are not initialized.
- Source ALL : This allows all the data in PRE-a or PRE-b, Multi Setup data, and Global data to be loaded.
- Source CMB : This allows one of 100 Combinations of Preset a or b to be loaded into a specified Combination number in the internal memory.
- Source PRG : This allows one of 100 Programs of Preset a or b to be loaded into a specified Program number in the internal memory.
- Source KIT : This allows one of Drum Kits 1 and 2 of Preset a or b to be loaded to Drum Kit 1 or 2 in the internal memory.
- If memory-protect is on for the Combinations, Programs, or Drum Kits, you cannot load the corresponding data. Turn memory-protect off on page 3A and 3B.
 - Preset b data is the same as the sound data of X5 and 05R/W.
 - When you load data using Source CMB, Source PRG, or Source KIT, the X5DR may produce Program sound that is different from the sound of Programs loaded using Source ALL. This happens when the same Preset a or b data is not used for the Combination and its Timbre's Programs (and the Drum Kit if a Drum Program is being used), or when the load destination Program number does not match the Timbre's number. This also happens when a different Drum Kit is used for the Drum Program Oscillator. Pay attention when you are loading sounds individually.

6A–6D Drum Kit1 Setup

These parameters allow you to set up Drum kit1.

Before editing a drum kit, you must select a Program in Program Play mode that is using that drum kit (that is, a Program whose oscillator mode is set to DRUMS). Drum Kits are affected by the VDF, VDA, and effect settings like Multisounds in a Program, because they use the parameter settings of the Program selected in Program Play mode.

After editing a drum kit, select a Drum Kit for a Program to be used in Program Edit mode Page 1A, and write the edit on page 16A.

Internal RAM has two Drum kits. You cannot edit the Drum kits in the ROM. To edit them, first copy them into RAM. (see “8A Drum Kit Copy” on page 160)

06A DRUM1 #01 105:Guiro S	06B KEY/TUNE/L D#4 T+019 L+65	06C DECAY/ASGN Dcy+00 Asgn:EX1	06D PAN/SEND Pan=CNT C=0 D=0
6A	6B	6C	6D

LCD	Parameter	Range	Description
6A	Index (#)	0–59	Select an index
	Drum Sound	---, 000–163–214	Select a drum sound for an index
6B	Key	C0–G8	Select a key (note) for an index
	Tune (T)	–120...+120	Tune an index (1 = 10 cents)
	Level (L)	–99...+99	Set the index volume level
6C	Decay (Dcy)	–99...+99	Set the index decay
	Group Assign (Asgn)	---, EX1...EX6, SLF	Assign an index to an exclusive group
6D	Pan (Pan)	OFF, A15–CNT–B15	Output pan to buses A and B
	Send C (C)	0–9	Output level to bus C
	Send D (D)	0–9	Output level to bus D

- 6A Index:** X5DR drum kits consist of indexes. Think of an index as an empty drum case, into which you put a drum sound, select a keyboard note, set a volume level, and pan. Parameters 6A to 6D affect the selected index.

Indexes that have not been assigned a drum sound display the message “No Assign” when selected.

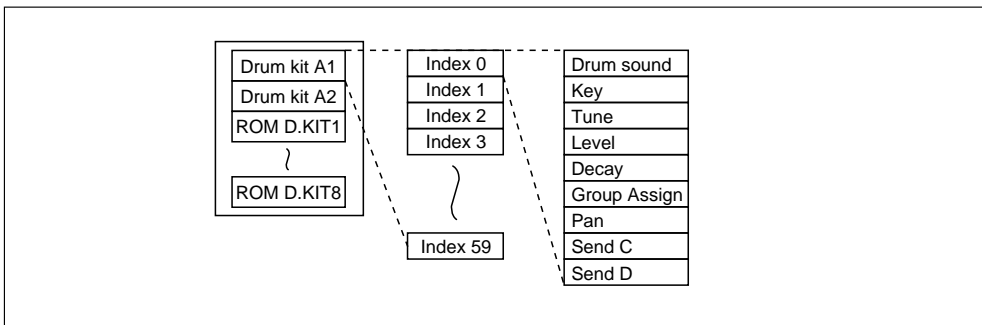

Drum Sound: this parameter allows you to select a drum sound for the currently selected index. A setting of --- means that no drum sound is selected. See “Voice Name List” for available drum sounds.

- 6B Key:** this parameter allows you to select the note that will trigger the index. It is not possible to select the same key for two indexes. So, if you want to select a key that is being used by another index, set the other index to a different key first.

If a key is selected for an index, but no drum sound is assigned to that index, the drum sound assigned to the next key up plays when that key is pressed. The pitch of the drum sound is lowered one semitone. This can be corrected using the Tune parameter.

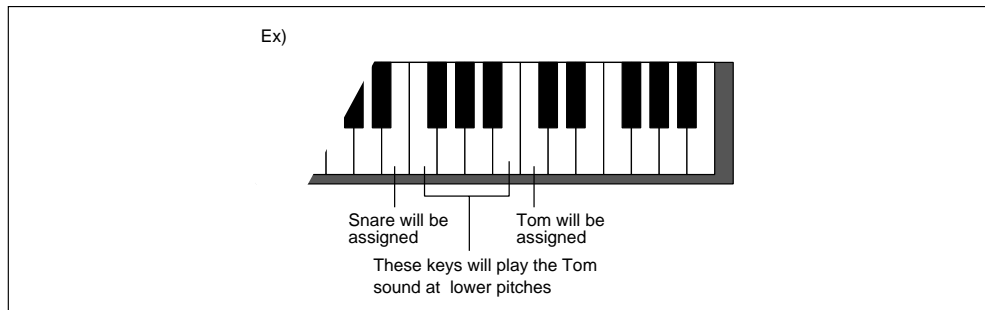

Tune: This parameter allows you to tune individual indexes ± 120 (10 = 1 semitone, 120 = 1 octave). For example, you may use the same snare drum sound for two indexes, but tune them differently. Use this parameter to make hi, mid, and low tom-toms from one tom drum sound.

Level: This parameter allows you to set the level of individual indexes. You can use this parameter to set up your drum mix. The overall volume level is determined by the current Program's Oscillator Level parameter.

- 6C Decay:** This parameter allows you to set the decay time of individual indexes. This parameter works in conjunction with the Program's VDA EG Decay Time parameter. So, depending on that parameter setting, you may find that increasing or decreasing this value has little or no affect.

Group Assign: This parameter determines how an index is played in relation to other indexes. In an exclusive group (EX1 to EX6), only one index can play at a time (monophonic). If, while an index is playing, another index in that group is triggered, the first index stops and the new index plays. This is useful for creating realistic hi-hats. By assigning an open hi-hat and a closed hi-hat to the same exclusive group, the sound of the open hi-hat can be cut short by triggering the closed hi-hat. Just like pressing a real hi-hat pedal.

When SLF is selected, the index will be monophonic. In other words, while a long drum sound such as a crash cymbal is playing, if it is re-triggered, the drum sound plays again from the beginning.

- 6D Pan:** This parameter is used to pan the index between buses A and B. These buses feed the effects processors. See "20A–20B Effect Placement" on page 117.

When OFF is selected, no signal is sent on buses A and B. The CNT setting means center: signals of equal level are fed buses A and B. This parameter can be used to simulate the stereo spread of a real drum kit with, for example, tom toms panned between the stereo outputs.

Pan function is slightly different between Program Play mode and Combination Play mode or Multi mode as follows:

Note: *The Program's Pan parameter is ignored when its Oscillator mode is set to DRUMS. In this case, the drum kit Pan parameter specified on LCD screen 6D is used.*

Send C, Send D: These parameters are used to set the level of the index sent to buses C and D. These buses feed the effects processors. See "20A–20B Effect Placement" on page 117.

Send function is slightly different between Program Play mode and Combination Play mode or Multi mode as follows:

Program mode: The panpot setting in Global mode is used. (You cannot set the panpot in Program Edit mode.) The send value set in Program Edit mode is applied to the send value for each index in Global mode before outputs C and D. That is, the balance of the send level between indexes is not changed, but the entire send level is changed. You can edit the send value set in Program Edit mode via MIDI.

Combination/Multi mode: With a setting of “PRG (Program)”, the panpot setting in Global mode is used (like in Program Play mode). With other settings, the value of all the indexes are summarized.

With a setting of “P”, the send function in Program Play mode is applied here. With another setting, the value of all indexes is summarized.

In general, you should set the panpot to “PRG” and send to “P.” You can edit the panpot setting via MIDI when “PRG” or “OFF” is not selected. (The value changes in Combination Edit mode and Multi mode.) You can also edit the send setting via MIDI. In this case, with a setting of “P”, the send function in Program Play mode is added here. (The send balance between indexes remains the same.) With a different setting, the values of all the indexes are summarized.

7A–7D Drum Kit2 Setup

These parameters allow you to set up Drum kit2. Operation is the same as for “6A–6D Drum Kit1 Setup” on page 158.

07A DRUM2 #01 152:Timpani	07B KEY/TUNE/L D#4 T+019 L+65	07C DECAY/ASGN Dcy+00 Asgn:EX1	07D PAN/SEND Pan=CNT C=0 D=0
7A	7B	7C	7D

8A Drum Kit Copy

This function allows you to copy a drum kit to the internal Drum Kit 1 or 2.

08A COPY D.KIT A1 ↕ A2 OK?
8A

LCD	Parameter	Range	Description
8A	Source Drum Kit	A1, A2, ROM 1–8	Select the source drum kit
	Destination Drum Kit	A1, A2	Select the destination drum kit
	OK to Copy	OK?	Executes the copy

To copy a drum kit, select the source and destination, position the cursor on OK?, then press the [▲] button. The message “Are You Sure OK?” will appear. (A1: Drum Kit1, A2: Drum Kit2) Press the [▲] button to copy, or the [▼] button to cancel.

Note: The drum kit at the specified destination is overwritten when this function is executed. So be careful that you don’t overwrite (lose) a valuable drum kit.

Appendix

General Error Messages

Error Message	Meaning
Battery Low (Internal)	The voltage of the internal battery is low. Please contact your Korg dealer to have the battery replaced. Do not attempt to replace the battery yourself.

Program Edit Mode & Combination Edit Mode Error Messages

Error Message	Meaning
Memory Protected	The Program or Combination memory into which you are trying to write data is protected.

Specifications

	X5DR
Tone Generation System	AI ² (Advanced Integrated) Synthesis
Tone Generator	Single mode: 64 voice, 64 oscillators Double mode: 32 voice, 64 oscillators
PCM Waveform Memory	PCM 8MB
Effects	Two digital multi-effects processors, 47 effects
Programs	236 (100 internal RAM, 136 internal ROM)
Combinations	100 internal RAM,
Outputs	L/MONO, R, PHONES (stereo mini jack)
MIDI Connections	IN, OUT, THRU
Communication port	TO HOST
LCD	16 x 2 LCD with backlight
Power Supply	DC 12V
Current Consumption	700mA
Dimensions (W x D x H)	218 (W) x 241.5 (D) x 45 (H) mm
Weight	1.3kg
Accessory	AC adapter, MIDI cable

Appearance and specifications subject to change without notice.

Options

AG-001 IBM-PC connection kit (Cable, "KORG MIDI Driver" software)

AG-002 Macintosh connection kit (Cable, "KORG MIDI Driver" software)

AG-004 9-pin/25-pin adapter for IBM-PC

Using MIDI exclusive messages

Each manufacturer is free to use exclusive messages in whatever way they desire, unlike other types of MIDI messages, in which the function of each message is fixed by the MIDI specification. Exclusive messages are used mainly to transmit patch data.

Although the format of exclusive messages is different for each manufacturer, the format of Korg exclusive messages is shown below.

STRUCTURE OF KORG X5DR SYSTEM EXCLUSIVE MESSAGES

1st Byte = 1111 0000 (F0):	Exclusive Status	
2nd Byte = 0100 0010 (42):	KORG ID	
3rd Byte = 0011 gggg (3g):	Format ID	g: Global ch. EX. Header
4th Byte = 0011 0101 (36):	X5 series ID	
5th Byte = 0fff ffff (ff):	Function Code (See Func Code List)	
6th Byte = 0ddd dddd (dd):	Data	
⋮	⋮	
⋮	⋮	
LastByte = 1111 0111 (F7):	End of Exclusive EOX

The fifth byte (the function ID) determines what the exclusive message will do. For the various types, refer to the function code list (1-4, 2-5).

The action of sending a set of sound data, etc., is called Data Dump. This can be initiated in the Data Dump page of GLOBAL mode, or by receiving an appropriate dump request message.

Since the model ID of the X5DR is the same as that of the 05R/W and X5 the X5DR is able to exchange exclusive data with the 05R/W and X5. However, it should be noted that part of Multi Setup data and Global data are not compatible,

Notes on each type of message

- No.11 Program Write Request
This message allows you write the Program in the Edit Buffer to the internal memory.
When you enter Program Edit mode, the data of that program will be written into the Edit Buffer (the write source), so writing should be done in Program Edit mode. It is possible to write while in Program Play mode, but in this case, after selecting a program, you must go through Program Edit mode once in order for writing to take place correctly.
- No.41 Parameter Change, No.53 Drum Parameter Change, No.4E Mode Change
Control Change #06, 26, Data Entry, #60, 61 Data Increment, Decrement
When you change modes from the X5DR front panel, a 'Mode Change' will be transmitted, and each time you select a parameter in Program Edit, Combination Edit or Multi modes, a 'Parameter Change' will be transmitted. When you move the slider, 'Data Entry' will be transmitted. When you press [▲] or [▼] to change the value, 'Data Increment' or 'Data Decrement' will be sent.
Increasing or decreasing the value in steps of 1 will cause "DATA ENTRY" to be transmitted.
By sending these messages to the X5DR, the X5DR's parameters can be edited individually, but messages must be transmitted in succession starting with the first 'Mode Change.' Even if the appropriate messages have been transmitted to edit via MIDI, once the panel keys have been operated, editing via MIDI will no longer be possible. In this case, you must once again begin transmitting from the 'Mode Change' (refer to Tables 7--10).
- Some of the parameters in Multi mode (listed below) do not respond to 'Parameter Change' messages. To edit these, you must use 'Multi Data Dump (exp).'
The various MIDI data filters (except Program) for each track
Key Window Bottom for each track
Velocity Window Bottom for each track
MIDI channel for each track
In Global mode, individual editing is possible only for drum kit parameters, and for this type of editing you will use 'Drum Parameter Change' messages. The procedure is the same as for 'Parameter Change' messages.
- No.51 Global Data Dump parameters include some that are not found on the X5DR (listed below). Since these parameters are transmitted using unused areas of X5DR data format, they can be transmitted and received between two X5DR units. When this data is transmitted from an X5 to an X5DR, it will be ignored, and when transmitted from an 05R/W, the data will have values of 0.
Damper polarity
Assignable pedal assign
Assignable switch assign
- No.68 Multi Setup Data (expansion) Dump is used to transmit settings for each track. No.55 Multi Setup Data Dump is used to transmit effect unit settings of the multi. By using these two messages, you can transmit Multi mode settings. The Multi Data dump operation in Global mode transmits these two types of data in a single operation. The All Data dump operation also transmits No.68 immediately following No.50 All Data Dump. However each type of data will be transmitted independently when the corresponding dump request is received. The X5 and X5DR respond to both messages. The 05R/W uses only No.55.
- When exclusive data is received and processing has been completed, it will transmit a 'Data Load Completed' (ACK) message. However if the format of the received data was incorrect a message of 'Format Error' will be transmitted, and if the receiving X5DR was not set appropriately (e.g., if memory protect was turned on) a message of 'Load Error' (NAC) will be transmitted.
Although not an exclusive message, when a Program Change is received while the Exclusive Filter is set to ENA, a message of 'Data Load Completed' will be transmitted after processing is finished.
- Data sent through the TO HOST connector is in the same format as MIDI. Therefore, most items described here apply to communication through the TO HOST connector.
- You can select either the MIDI connector or TO HOST connector in Global mode for normal transmission. Furthermore, you can select which connector is used for data transmission using the page "DATA DUMP." When the X5DR receives Data Dump Requests, it transmits the dump data to the connector through which the corresponding request was sent.
- While communicating with a personal computer etc. via the PC interface, MIDI transmission and reception is disabled. The opposite also applies.

Installing and Setting Up the KORG MIDI Driver

- KORG MIDI Driver is included in the disk that comes with AG-001.

Installing the KORG MIDI Driver in MS Windows

If the application (sequencer, etc.) being used supports Windows MME (Multimedia Extensions), the KORG MIDI Driver program, provided as an accessory, can be used to drive the X5DR connected to the serial port (COM port) as a MIDI device.

- MIDI In data may not be received correctly if the processing speed of your computer is inadequate.

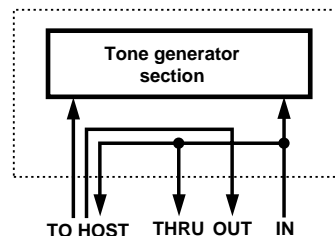

1. Double-click on the Driver icon in the Control Panel.

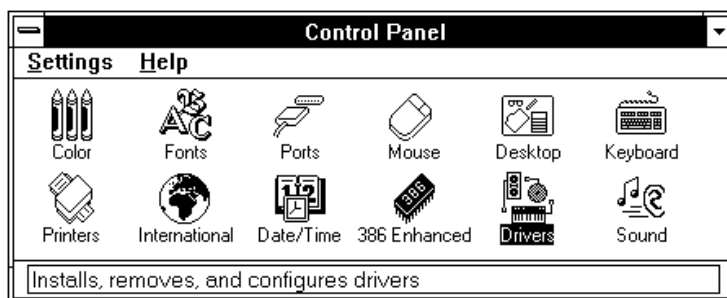

2. Select "Add".

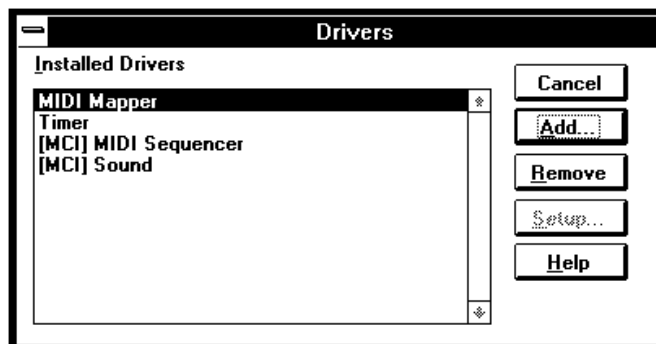

3. On the "List Drivers" menu, select "Unlisted or Driver", and click on "OK".

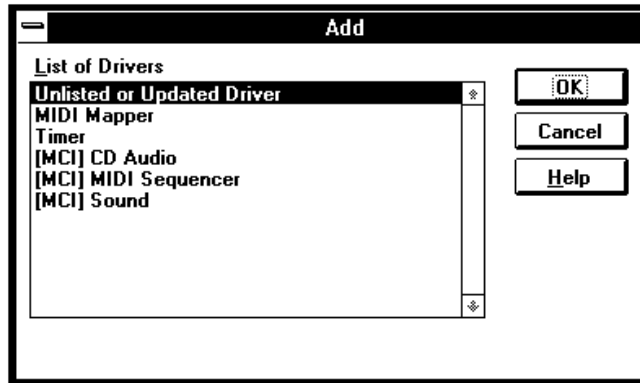

4. If a floppy disk containing the Driver program has been inserted in Drive A, type "A:\\" (if the disk is in Drive B, type "B:\"). Then click on "OK".

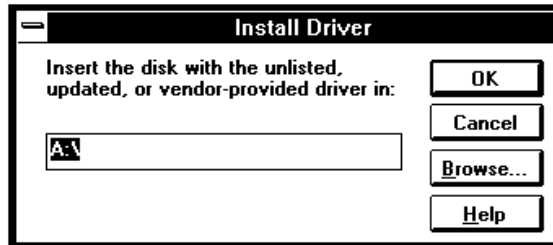

5. Select "Korg PC I/F Driver", and click on "OK". The setup screen appears. Follow the instructions listed under "Setting Up the KORG MIDI Driver (Windows)" on page 165

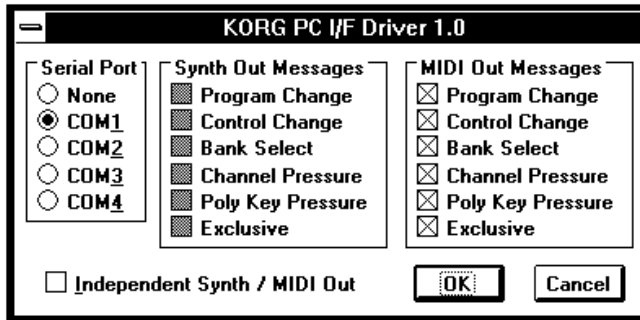

6. To make the Driver effective, eject the disk and select "Restart".

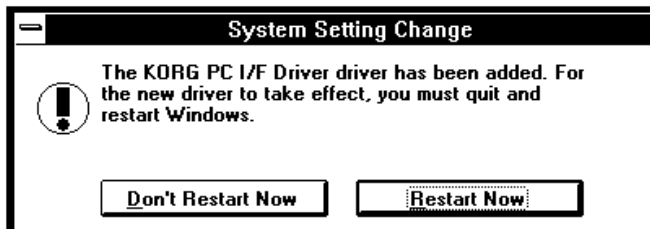

Setting Up the KORG MIDI Driver (Windows)

1. Double-click on the Driver icon in the Control Panel, and select “KORG PC I/F Driver”. Then click on the specified button to display the setup screen.
2. Under “Serial Port”, select the serial port to which the X5DR is connected (COM1 to COM4).
If you wish to use the serial port for another purpose after you have already installed the KORG MIDI Driver, Remove the Driver or turn the Driver off by selecting “None”.
3. When the “Independent Synth/MIDI Out” box is checked, data output to the Synth Out port will produce sound from the tone generator of the X5DR, while data output to the MIDI Out port of the X5 will be output as MIDI data from the X5DR.
If the “Independent Synth/MIDI Out” box is not checked, data output to the MIDI Out port will be sent to both the tone generator of the X5DR and the MIDI Out port.
4. The items listed under “Synth Out Messages” can be used to select messages to be sent to the X5DR. The items listed under “MIDI Out Messages” can be used to select messages to be output from the MIDI Out port on the X5DR. If the check mark in the box next to “Independent Synth/MIDI Out” is erased, the same messages will be sent to the X5DR and output from the MIDI Out port of the X5DR.
5. When all of the selections have been completed, click on “OK”. To cancel the selections without changing anything, click on “Cancel”.
 - When playing back MS Extended MIDI data, either mute channels 13–16 on the sequencer or whatever instrument is being used, or use the MIDI Mapper provided with the Windows MME program to enter the settings for the Extended MIDI application.

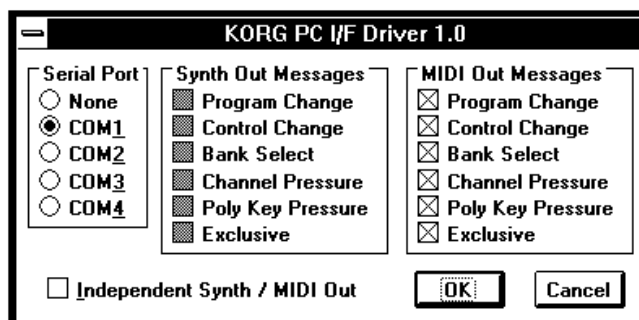

Installing the KORG MIDI Driver on a Macintosh Computer

- KORG MIDI Driver is included in the disk that comes with AG-002.

If the application (sequencer) being used supports the Apple MIDI Manager, the KORG MIDI Driver can be used to provide separate MIDI output for the X5DR tone generator and the MIDI Out port.

- When the KORG MIDI Driver is not used
- When the KORG MIDI Driver is used

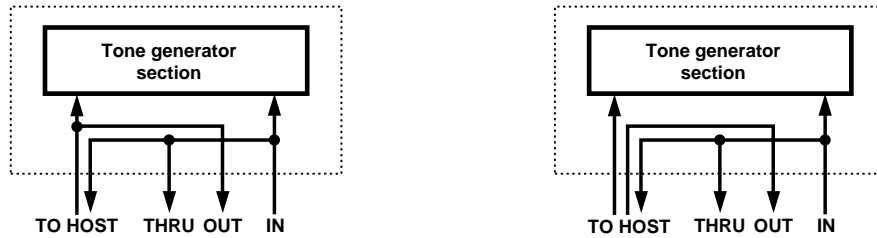

- In order to use the KORG MIDI Driver, the Apple MIDI Manager and PatchBay must be installed.

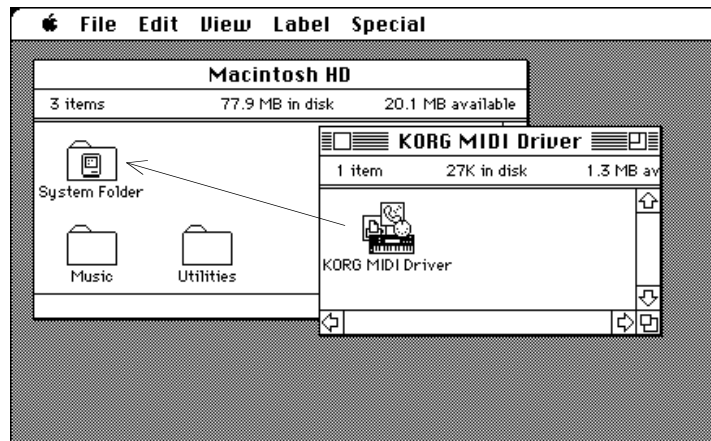

1. Copy the KORG MIDI Driver on the accessory disk into the System Folder on the startup disk.
2. If the Apple MIDI Driver is already in the System Folder, either erase it or move it into another folder. The KORG MIDI Driver includes the functions of the Apple MIDI Driver. Be careful not to erase or move the Apple MIDI Manager.

Setting Up the KORG MIDI Driver for the Macintosh

1. Start up the PatchBay program.
If the program has been installed correctly, the KORG MIDI Driver icon will be displayed inside the PatchBay window.
2. Double-click on the KORG MIDI Driver icon. The setup dialog box is displayed.
When "KORG PC IF" is selected as the Interface Type, data sent to the Synth Out Port will produce sound from the X5DR tone generator, while data sent to the MIDI Out Port will be sent out through the MIDI Out jack on the back panel of the X5DR.
If "1MHz" is selected as the Interface Type, the Synth Out Port will disappear. Messages sent to the MIDI Out Port will produce sound from the X5DR tone generator and also be sent to the MIDI Out Jack on the back panel of the X5DR.
3. Set the "Interface Type" for the port to which the X5DR is connected to "KORG PCIF" (or to "1MHz"). If the X5DR is connected to an ordinary MIDI interface, select a clock rate that matches the interface (usually this will be 1 MHz).
4. In order to use the Modem or Printer ports, the Corresponding "Port Enabled" box(s) must be checked. The "Synth Out Port" is available only if "KORG PCIF" has been selected for the interface type.
5. Pressing the "Out Port Setting" button displays the MIDI Channel dialog box. In this box, you can select the MIDI channels/messages to be output to each of the ports.
Only channels/messages which have been checked will be output.
6. Drag the mouse from the arrow on the Out Port of the MIDI application (sequencer, etc.) and connect it to the "Synth Out Port" of the Korg MIDI Driver. Other ports can be connected in the same way if necessary.
 - For information on using the PatchBay program, please refer to the application instruction manual included with the PatchBay program, or see the description under "About PatchBay..." in the Apple menu.

MIDI File Translator

MIDI File Translator is an Apple File Exchange translation program that allows Macintosh MIDI application programs to recognize an MS-DOS standard MIDI file as an SMF (Standard MIDI File).

- You do not need this application program to operate the KORG MIDI Driver.

Make a copy of MIDI file translator in the folder that contains Apple File Exchange. Select "MIDI File Translation" in the "MS-DOS → Mac" menu that is displayed when you activate Apple File Exchange and insert an MS-DOS disk. If "MIDI File Translation" is not displayed, first select "Other Conversion Program," then add "MIDI File Translation".

- For details, see the Apple File Exchange documentation in your Apple manual.

INDEX**A**

About this manual	xi
AC adaptor	v, 1, 9
After Touch	2, 33, 35, 67
Curve	148
Modulation Intensity	95
Pitch Bend	97
VDA Amplitude	97
VDF MG Intensity	97
VDF Cutoff Frequency	97
After Touch Filter	
Combination	104
Global	152
Multi	111
AI ² Synthesis System	i
amplifier	37
Apple Macintosh	13, 177
Assign, OSC	79

B

[BANK] button	4, 21
Bank	4, 21
Bank Select	17, 18, 22, 33, 68, 108, 152
Battery Low	161
Brightness	70

C

Chorus	48, 126
Chorus Level	70
Coarse Tune	71
Combination	7, 24
Combination Edit Mode	26, 51
Combination name	7
Combination number	7, 24
Combination Paramaters	100–106
Combination Play Mode	7, 24
Combination Types	25
Computer Select	14, 148
Control Change	68
Control Change Filter	
Combination	104
Global	152
Multi	111
Copy	
Combination	113
Drum Kit	160
Effects	119
Scale	150
Color Intensity	86, 90
Color Velocity	86, 90
Cursol	iii, 23, 26, 27, 29
Cutoff	42

D

Damper Pedal	1
Damper Pedal Filter	
Combination	104
Multi	111
Data Dump	74, 154
Delay Start, OSC2	82
Demo Song	3, 15
Detune	
Combination	103
Multi	110
Program	82
Distortion, Effect	49, 132
DOUBLE, OSC	45, 79
Drum Kit	53, 158–160
Index	158
Copy	160
Drum Program	17, 22, 68
DRUMS, OSC	79
Drum Sound	55, 158
Dynamic modulation control source	116

E

Early Reflection, Effect	48, 122
Edit Buffer	38
Editing	36
Combination	51
Drum Kit	53
Effect	47
Program	38
Effect Control	69
Effect Copy	119
Effect On/Off	71
Effect Placement	117
Effects Types	120–142
Effect Paramaters	115–145
Effects	
Combination	106
Multi	113
Program	99
EG (Envelope Generater)	37
Enhancer, Effect	49, 131
Error Messages	161
Exciter, Effect	49, 131
Exclusive	73, 74, 152, 154
Expression	69
External Out Select	14, 151

F

filter	36
Fine Tune	71
Flanger, Effect	48, 130
Foot Controller	69

G

Global Mode	29, 75
Global Parameters	146–160
GM (General MIDI System Level 1)	ii, 16
GM Score	16, 63
GM System On	18, 73, 114
Group Assign, Drum Kit	159

H

Hold, OSC	79
-----------	----

I

IBM PC (Compatible)	12
Index, Drum Kit	158
Interval, OSC2	82
Inquiry Message Request	73

J

Joystick	
Modulation Intensity	95
VDF MG Intensity	98
VDF Sweep Intensity	98
Pitch Bend Range	98

K

Keyboard Sync	
VDF Modulation	97
Pitch1 Modulation	95
Keyboard Tracking	
Amplitude	92, 94
EG Time, VDF	89, 90
EG Time, VDA	93, 94
Intensity, VDF	89, 90
Key, VDA	92, 94
Key, VDF	88, 90
Modes, VDA	92, 94
Modes, VDF	88, 90
Keyboard Velocity	34
Key Window Top & Bottom	
Combination	52, 102
Multi	112
KORG MIDI Driver	31, 174–179
KORG PC I/F MIDI Port	30
KORG PC I/F Synth Port	30

L

Layer	25
LCD display	iv
Level	
Combination	101
Drum Kit	159
Multi	109
OSC	80, 82
LSB	71

M

Main Scale	61
Master Balance	73
Master Tune	71, 147
Master Volume	73
Memory Protect	153
MG	37
MIDI	28, 30, 32, 65
MIDI Controller Filter	151
MIDI Connectors	30, 65
MIDI Channel	
Global	31, 151
Combination	31, 102
Multi	17, 32, 113
Program	2, 21, 31
MIDI Data Format	163
MIDI Filter	75
Global	151
Combination	104
Multi	111
MIDI Implementation Chart	180
MIDI Interface	11
MIDI File Translator	179
MIDI System Exclusive Filter	152
Mono Delay	48, 124
MSB	71
Multi Mode	16, 27
MULTI Setup Parameters	107–114
Multisound	i, 44, 80, 82
Multi-Tap Delay, Effect	124
multi-timbre	16, 27

N

No Effect	120
Note On/Off	66
Note Receive Filter	151
NT (No Transpose), OSC	80

O

Octave, OSC	80
Options	161
OSC (Oscillator)	36, 79
OSC level	80
Oscillator mode	79

P

Page	iii, 23, 26, 27, 29
Page Memory	64, 153
Pan (Panpot)	45
Combination	105
Drum Kit	159
Effect	117
Multi	109
Program	81, 82
Pan 3/4, Effect	117

Parallel 1/2/3 Placement118
 Parametric EQ, Effect49, 136
 PC Interface172
 Performance Technique30
 Phaser49, 133
 Pitch Bend2, 67
 Wheel34
 Program2, 97
 Range, Multi.71, 110
 Pitch EG83
 Pitch MG68
 Pitch Modulation94, 96
 Placement117
 Positional Crossfade93
 Preset a/b20, 156
 Preset Data Load20, 156
 Program Bank4, 17
 Program Change17, 22, 66
 Program Change Filter75
 Combination104
 Global152
 Multi111
 Program Edit Mode23, 38
 Program Name4
 Program Number4
 Program Play Mode4, 21
 Program Parameters78–99
 Program Select, Combination101
 Program write39, 99

R

Release Time70
 Rename
 Combination106
 Program99
 Reverb47, 120
 Reverb Level70
 Rotary Speaker, Effect49, 134
 RPN71

S

Scale69, 149
 copy149
 Key149
 Main Scale69, 149
 Sub Scale69, 149
 Type149
 User Scale149
 Send C/D45, 70
 Combination105
 Drum Kit159
 Multi109
 Program81, 82
 Serial Placement118
 SINGLE, OSC79
 Specifications161

Stereo Delay, Effect48, 123
 Split25, 61
 Symphonic Ensemble, Effect129

T

Timber7, 24, 31
 TO HOST12, 13, 30
 Track16, 27, 32, 107
 Transpose
 Combination103
 Global147
 Multi110
 Tremolo, Effect49, 135
 Troubleshooting57
 Tune54, 159
 Tuning60, 147

U

User Scale150
 Universal System Exclusive73

V

VDA (amplifier)37
 VDA EG43
 VDA Velocity Sensitivity91, 94
 VDF (filter)36
 VDF MG69
 VDF Cutoff Frequency85, 90
 VDF Velocity Sensitivity87, 90
 VDF Cutoff85
 VDF EG43, 86
 Velocity Curve147
 Velocity Sensitivity Amplitude91, 94
 Velocity Sensitivity EG Intensity87, 90
 Velocity Sensitivity EG Time88, 92
 Velocity Switch26
 Velocity Window Top & Bottom
 Combination103
 Multi112
 Vibrato34
 Volume69
 Volume Pedal1

W

Wah34
 Write
 Combination106
 Global147
 Program39, 99

X

X562, 154

0

05R/W62, 154