

# KORG

RHYTHM WORKSTATION

# SR3

## OWNER'S MANUAL

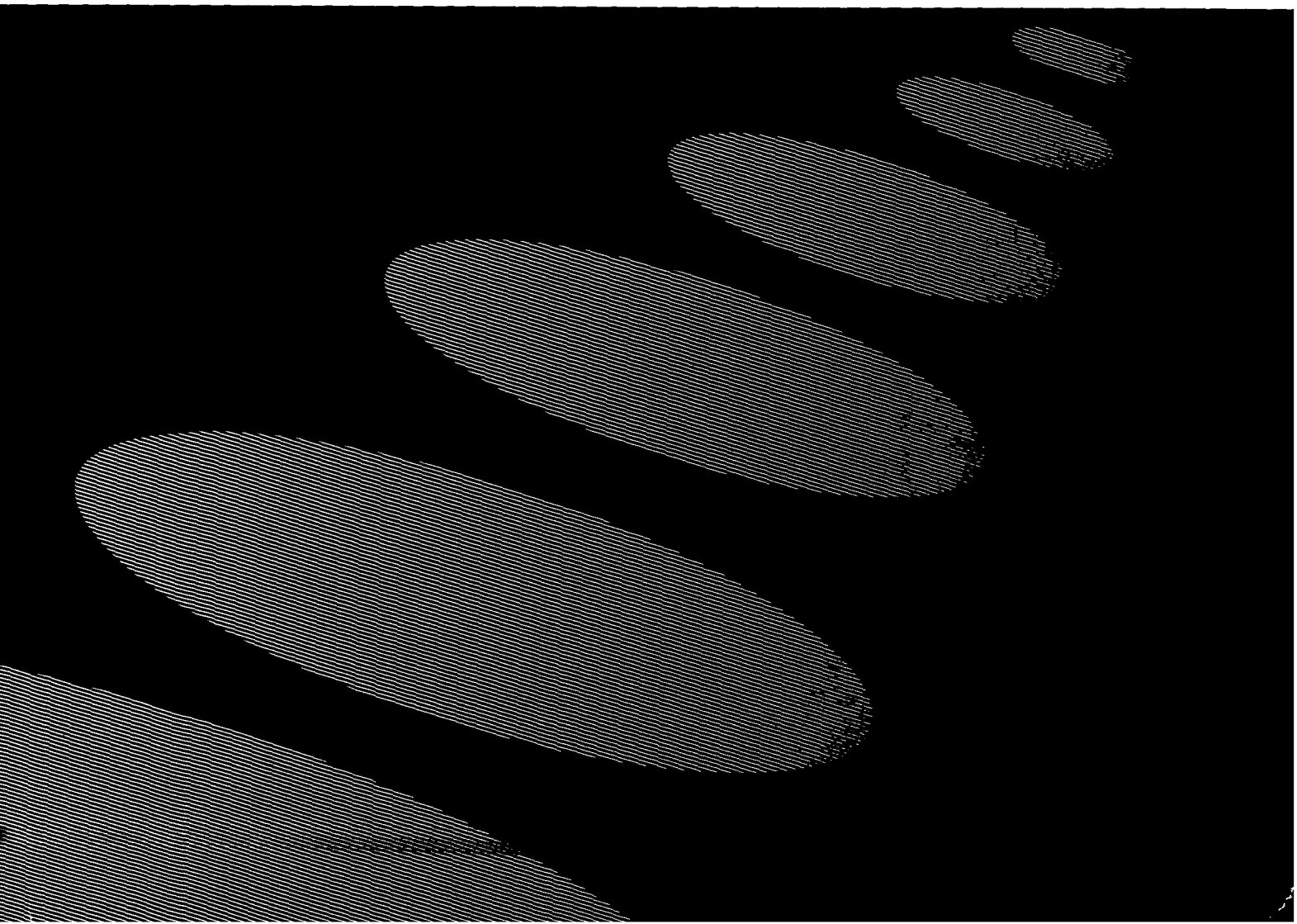

# Table of Contents

Introduction .....	1
--------------------	---

## Chapter 1 Before You Begin

<b>1.1 Features</b> .....	2
<b>1.2 Front Panel</b> .....	3
1.2.1 Menu System .....	4
1.2.2 Menu Keys .....	4
1.2.3 Value Entry Controls .....	5
1.2.4 Transport Keys .....	6
1.2.5 Mode Keys .....	7
1.2.6 Touchpads .....	8
1.2.7 VOLUME Slider .....	8
1.2.8 LEDs .....	8
<b>1.3 Rear Panel</b> .....	9
1.3.1 Signal Output Jacks .....	9
1.3.2 Foot Switch Jacks .....	9
1.3.3 Timing Signal Jacks .....	9
1.3.4 MIDI Jacks .....	10
1.3.5 Card Slots .....	10
1.3.6 Power Supply .....	10
<b>1.4 Bottom Panel</b> .....	10
1.4.1 LCD Contrast Control .....	10
<b>1.5 Setting Up</b> .....	11
<b>1.6 Organization</b> .....	11
1.6.1 Patterns and Songs .....	11
1.6.2 Tracks and Drum Kits .....	12
1.6.3 Kits and Timbres .....	12
1.6.4 Recording Tracks .....	13
1.6.5 PATTERN PLAY/REC (PP) Mode .....	15
1.6.6 PATTERN EDIT (PE) Mode .....	15
1.6.7 SONG PLAY/REC (SP) Mode .....	16
1.6.8 SONG EDIT (SE) Mode .....	17
1.6.9 TIMBRE (T) Mode .....	17
1.6.10 KIT (K) Mode .....	18
1.6.11 MIDI (M) Mode .....	19
1.6.12 SYSTEM (S) Mode .....	20

## Chapter 2 Basic Operation

<b>2.1 Playing Manually</b> .....	21
2.1.1 Changing Drum Kit Assignments .....	22
2.1.2 Adding an Effect .....	22
<b>2.2 Playing Demo Songs</b> .....	23
<b>2.3 All System Initialize</b> .....	23
<b>2.4 Recording Patterns</b> .....	24
2.4.1 Real-Time Recording .....	25
2.4.2 Step Recording .....	28
2.4.3 Next Pattern Play .....	30

# Table of Contents

<b>2.5 Arranging Patterns into a Song</b> .....	30
2.5.1 Basic Procedure .....	30
2.5.2 Correcting Mistakes .....	33
2.5.3 Inserting a Pattern (*Ins) .....	33
2.5.4 Deleting a Pattern (*Del) .....	34
2.5.5 Using Repeats .....	35
2.5.6 Changing Drum Kits .....	36
<b>2.6 Real-Time Song Recording</b> .....	37
2.6.1 Overdubbing a Song .....	38
2.6.2 PUNCH IN Recording .....	39

## Chapter 3 PATTERN and SONG Modes

<b>3.1 PATTERN PLAY/REC Mode</b> .....	41
3.1.1 PATTERN SELECT (PP1) Page .....	41
3.1.2 MONITOR (PP2) Page .....	42
3.1.3 REC LEAD IN (PP3) Page .....	44
3.1.4 RANGE (PP4) Page .....	44
3.1.5 PATTERN ERASE (PP5) Page .....	45
3.1.6 PATTERN CLEAR (PP6) Page .....	45
<b>3.2 PATTERN EDIT Mode</b> .....	45
3.2.1 PATTERN SELECT (PE1) Page .....	45
3.2.2 RANGE (PE2) Page .....	45
3.2.3 TRANSPOSE (PE3) Page .....	45
3.2.4 VELOCITY EDIT (PE4) Page .....	46
3.2.5 QUANTIZE (PE5) Page .....	51
3.2.6 SWING (PE6) Page .....	52
3.2.7 BLANK INSERT (PE7) Page .....	53
3.2.8 TRACK COPY/BOUNCE (PE8) Page .....	54
3.2.9 PATTERN COPY (PE9) Page .....	56
3.2.10 PATTERN APPEND (PE10) Page .....	57
3.2.11 PATTERN DELETE (PE11) Page .....	58
3.2.12 PATTERN ERASE (PE12) Page .....	59
3.2.13 PATTERN CLEAR (PE13) Page .....	60
<b>3.3 SONG PLAY/REC Mode</b> .....	60
3.3.1 SONG SELECT (SP1) Page .....	60
3.3.2 SONG SETTING (SP2) Page .....	61
3.3.3 ARRANGE (SP3) Page .....	65
3.3.4 TRACK STATUS (SP4) Page .....	67
3.3.5 REC MODE (SP5) Page .....	68
3.3.6 REC LEAD IN (SP6) Page .....	68
3.3.7 SONG COPY (SP7) Page .....	68
3.3.8 SONG CLEAR (SP8) Page .....	69
<b>3.4 SONG EDIT Mode</b> .....	69
3.4.1 SONG SELECT (SE1) Page .....	69
3.4.2 RANGE (SE2) Page .....	70
3.4.3 TRANSPOSE (SE3) Page .....	70
3.4.4 VELOCITY EDIT (SE4) Page .....	71
3.4.5 QUANTIZE (SE5) Page .....	74
3.4.6 TRACK EDIT (SE6) Page .....	77
3.4.7 TACK ERASE (SE7) Page .....	79
3.4.8 TRACK PASTE (SE8) Page .....	80

# Table of Contents

3.4.9 SONG CLEAR (SE9) Page.....	84
----------------------------------	----

## Chapter 4 Instrument Modes

<b>4.1 TIMBRE Mode</b> .....	85
4.1.1 TIMBRE SELECT (T1) Page .....	85
4.1.2 WAVEFORM ASSIGN (T2) Page.....	86
4.1.3 ENVELOPE (T3) Page.....	87
4.1.4 AUTO BEND (T4) Page .....	90
4.1.5 MODULATION (T5) Page .....	90
4.1.6 MONITOR (T6) Page .....	92
4.1.7 TIMBRE COPY (T7) Page .....	93
<b>4.2 KIT Mode</b> .....	93
4.2.1 KIT SELECT (K1) Page .....	93
4.2.1.1 PAD Submode .....	94
4.2.1.1.1 PAD NAME (P1) Page.....	94
4.2.1.1.2 TIMBRE SETUP (P2) Page.....	95
4.2.1.1.3 PAD EDIT (P3) Page .....	95
4.2.2 PAD ARRANGE (K2) Page .....	102
4.2.3 PAD MODE (K3) Page.....	103
4.2.4 PAD LEVEL (K4) Page.....	103
4.2.5 NOTE ASSIGN (K5) Page .....	104
4.2.6 MONTIOR (K6) Page.....	105
4.2.7 KIT COPY (K7) Page .....	105

## Chapter 5 Effects

<b>5.1 Overview of the S3's Effect Configuration</b> .....	106
5.1.1 Effect Program .....	106
5.1.2 Placement .....	107
5.1.2.1 Placement 1 (P1).....	107
5.1.2.2 Placement 2 (P2).....	107
5.1.3 Effect Types .....	108
5.1.4 Examples of Effect Programs .....	108
<b>5.2 EFFECT (S3) Page</b> .....	110
5.2.1 Editing and Effect Program .....	110
5.2.2 SET Submenu.....	111
5.2.3 COPY Submenu.....	111
<b>5.3 Editing an Effect</b> .....	112
<b>5.4 Stereo Effects (01 ~ 14)</b> .....	113
5.4.1 HALL/ROOM (01 ~ 06) .....	113
5.4.2 EARLY REFLECTION (07 ~ 09) .....	113
5.4.3 STEREO DELAY (10) .....	114
5.4.4 STEREO CHORUS (11) .....	114
5.4.5 STEREO FLANGER (12).....	114
5.4.6 STEREO PHASER (13) .....	115
5.4.7 STEREO TREMOLO (14).....	115
<b>5.5 Compound Effects (15 ~ 28)</b> .....	115
5.5.1 DUAL EQUALIZER (15).....	115
5.5.2 DUAL EXCITER (16).....	115

# Table of Contents

5.5.3 D/HALL (17).....	116
5.5.4 D/ROOM (18) .....	116
5.5.5 D/EREF (19).....	116
5.5.6 D/DLY (20).....	116
5.5.7 D/CHOR (21).....	117
5.5.8 D/FLAN (22) .....	117
5.5.9 D/PHAS (23).....	117
5.5.10 D/TREM (24) .....	117
5.5.11 E/DLY (25) .....	118
5.5.12 E/CHOR (26) .....	118
5.5.13 E/FLAN (27).....	118
5.5.14 E/TREM (28).....	118

## Chapter 6 MIDI

<b>6.1 Background</b> .....	119
6.1.1 What is MIDI? .....	119
6.1.2 Channel Messages.....	120
6.1.3 System Messages .....	120
<b>6.2 MIDI Mode</b> .....	121
6.2.1 REC CHANNEL SELECT (M1) Page.....	121
6.2.2 REC MESSAGE FILTER (M2) Page .....	122
6.2.3 RECEIVE FILTER (M3) Page.....	122
6.2.4 MIDI OUTPUT (M4) Page .....	123
6.2.5 GLOBAL CHANNEL (M5) Page .....	123
<b>6.3 MIDI Applications</b> .....	123
6.3.1 S3 under External Control .....	124
6.3.2 S3 as MIDI Master Controller .....	127
6.3.3 S3 as Multichannel Sequencer .....	129
6.3.4 S3 as Sound Source .....	131
<b>6.4 Synchronizing MIDI Devices</b> .....	133
6.4.1 S3 as Master .....	133
6.4.2 S3 as Slave .....	134

## Chapter 7 SMPTE Synchronization

<b>7.1 Background</b> .....	136
7.1.1 What is SMPTE? .....	136
7.1.2 Frame Rates.....	136
<b>7.2 Synchronizing with SMPTE Signals</b> .....	136
7.2.1 Connections.....	137
7.2.2 CLOCK (S1) Page.....	137
7.2.3 TIME CODE GENERATE (S11) Page.....	138
7.2.4 Synchronized Playback .....	138

## Chapter 8 Data Dump Facilities

<b>8.1 Storing Data on Cards</b> .....	140
8.1.1 CARD (S12) Page.....	141
8.1.2 Saving Data to a Card .....	142
8.1.3 Loading Data from a Card .....	143

# Table of Contents

<b>8.2 Exchanging Data via MIDI</b> .....	144
8.2.1 SYSTEM EXCLUSIVE (S9) Page .....	144
8.2.2 MIDI DUMP (Dump) Submenu (Transmitting Data) .....	144
8.2.3 COMMUNICATION Mode (Comm) (Receiving Data) .....	145

## Chapter 9 SYSTEM Mode

9.0.1 CLOCK (S1) Page .....	147
9.0.2 TUNE (S2) Page .....	147
9.0.3 EFFECT (S3) Page .....	147
9.0.4 METRONOME (S4) Page .....	147
9.0.5 ROLL/FLAM (S5) Page .....	148
9.0.6 PAD MODE (S6) Page .....	148
9.0.7 PAD SENSITIVITY (S7) Page .....	151
9.0.8 FOOT SWITCH (S8) Page .....	152
9.0.9 SYSTEM EXCLUSIVE (S9) Page .....	152
9.0.10 TIME CODE GENERATE (S10) Page .....	152
9.0.11 FREE MEMORY (S11) Page .....	152
9.0.12 CARD (12) Page .....	153

## Appendix A: Error and Warning Messages .....

154

A.1 All Modes .....	154
A.2 Pattern and Song Modes .....	154
A.3 Instrument Mode .....	156
A.4 System Mode .....	156

## Appendix B: TroubleShooting .....

158

## Appendix C: RAM Cards .....

161

C.1 Inserting a Battery .....	161
C.2 Write Protect Switch .....	161
C.3 Changing a Battery .....	162

## Appendix D: MIDI Implementation .....

163

## Specifications .....

175

# Introduction

*Congratulations and thank you for purchasing the Korg S3 Rhythm Workstation. The S3 will certainly open up whole new worlds of musical expression as well as the ability to effectively communicate with all your MIDI devices. This manual has been written to increase your understanding of the S3 and ensure your continued enjoyment for many years to come.*

## Safety and Precautions

Please read all the instructions carefully before using this product. Make sure to pay special attention to the following:

**Location:** To prevent damage to the unit's electronics never expose it to direct sunlight, dusty air, extreme temperatures, excessive humidity or excessive vibration.

**Power supply:** Use only the AC adaptor included with the unit. Use only electrical outlets matching the specifications on the name plate of the adapter. Using the wrong polarity or voltage can irreparably damage the unit. Moreover, avoid connecting the unit to the same electrical circuit as motors and other heavy loads.

**Interference:** Keep the unit away from fluorescent light fixtures and other sources of radio-frequency noise. Never use the unit in the immediate vicinity of a radio, television set or similar equipment as the equipment may pick up radio-frequency noise from the microprocessor at the core of the unit.

**Handling:** Never apply excessive force to keys, switches, terminals and other components. Avoid dropping the unit or subjecting it to sudden impact.

**Cleaning:** Wipe the unit with a clean, dry cloth. Never use harsh cleansers, organic solvents or flammable polishes.

**Warranty:** Have your warranty certificate validated by the vendor and keep it in a safe place.

**Manual:** This manual is your guide to using the unit properly and effectively. Keep it in a safe place.

Refer servicing to a qualified Korg Service Center when:

- The power cord is damaged.
- Liquid has been spilled into the unit.
- The S3 does not appear to operate normally.
- If the S3 has been dropped or the outside case has been damaged.

## Limited Warranty

All Korg products are warranted by Korg, U.S.A., Inc. to the first consumer-purchaser to be free from defects in material or workmanship for a period of one (1) year from the date of purchase. Please see the enclosed warranty card for items not covered under the limited warranty and for additional information.

# Chapter 1 Before You Begin

## 1.1 Features

The Korg S3 rhythm workstation is not just another drum machine, but a total production workstation that incorporates many key components used by all MIDI systems: Korg Sonic Integrity (SI) sound sources featuring the latest in 16-bit PCM sound synthesis technology, two built-in digital effects and a sequencer that functions as a multitrack recorder. This recorder may be synchronized with either a clock signal from other MIDI equipment or Society of Motion Picture and Television Engineers (SMPTE) timing signals from film and video equipment.

**PCM sound sources:** The built-in sound sources use the Korg Sonic Integrity (SI) sound synthesis system, which combines the latest in 16-bit PCM sampling technology with the same advanced editing capabilities found on samplers and synthesizers. These fully programmable sound sources may be played from a synthesizer, sequencer or other external MIDI device.

**Multitrack recording:** The built-in sequencer has a total of eight tracks: four for recording basic patterns and four for combining them into songs and adding real-time recording. Song tracks are normally paired with the corresponding pattern tracks, but changing these connections so that the pattern tracks use internal sound sources and the song tracks use external ones permits full 8-track operation.

**Multi-timbre sound module:** Assigning different MIDI input channels to tracks 1 ~ 4 turns the S3 into a multi-timbre sound module capable of simultaneously sounding four different percussion kits.

**Sequencer:** The sequencer is not just for recording rhythms played on the touchpads and playing them back using the built-in sound sources. The MIDI interface also allows recording of notes from a keyboard or other MIDI instrument as well as playback to external sound sources.

**Drum kits:** Each track contains a rhythm pattern for a single drum kit, a particular set of percussion instruments. Varying the drum kit assignments for the individual tracks produces a whole new range of sound variations in a basic pattern.

**SMPTE timing signals:** The S3 generates and understands SMPTE timing signals, so working with material recorded on SMPTE-standard film and video equipment does not require the addition of a synchronizer. The S3 automatically synchronizes—even when you start in the middle of a selection.

**Two MIDI outputs:** The S3 has two independent MIDI OUT ports instead of the usual one. These give the flexibility to, for example, transmit the MIDI timing clock over one cable and the note data over another.

**Digital effects:** Two built-in digital stereo effects eliminate the need for external effect devices.

**Multichannel output:** The S3 simultaneously offers two types of output: two-channel stereo output for speaker systems and four channel output for use with multitrack recording systems and mixers.



# Before You Begin

## 1.2 Front Panel

The front panel contains a two-line LCD screen, six groups of controls and two LEDs:

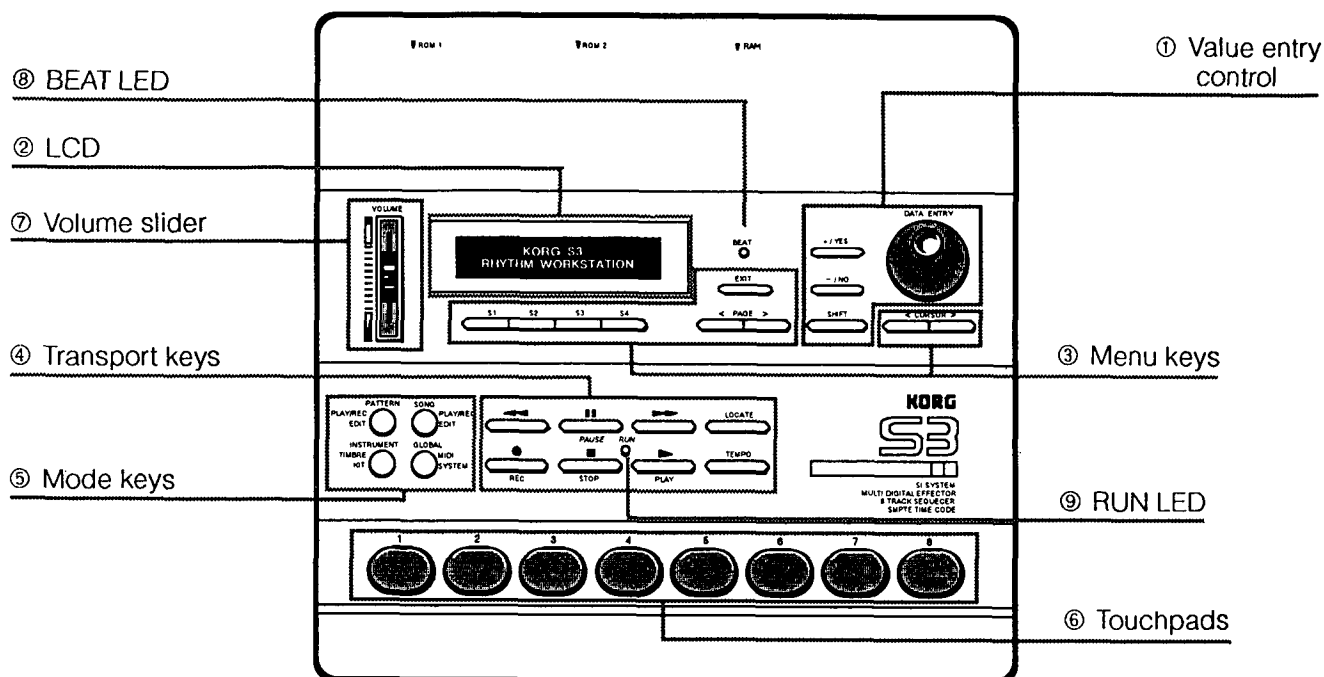

### LCD Screen

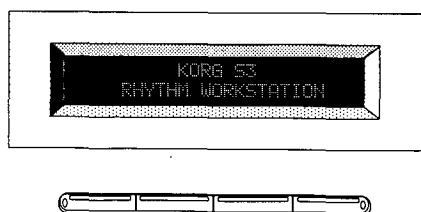

⑤ **Mode keys:** These four keys provide access to two modes each. The mode in use depends on the color of the LED in the key. The current mode also appears as a two-letter abbreviation or label in the upper left corner of the display on the LCD screen—PP for PATTERN PLAY, for example.

⑥ **Touchpads:** The primary use of these eight large keys is to sound 16 percussion instruments arranged in two banks of eight instruments each. Built-in velocity sensors link instrument volume to the key velocity (striking force on the pad). The touchpads are also used to select cue points within songs.

⑦ **VOLUME slider:** This controls the level of the stereo outputs as well as the stereo headphones jack.

⑧ **BEAT LED:** This LED blinks red to the chosen beat increment while playback or recording is in operation.

⑨ **RUN LED:** This LED changes color and blinks to inform you of the sequencer action. (See 1.2.8 LEDs.)

① **Value entry controls:** The three keys in this column and the dial next to them change the value of the current data field on the LCD screen.

② **LCD screen:** This two-line screen is your window into the S3 menu system. (See 1.2.1 Menu System.)

③ **Menu keys:** The nine keys in this row and the [EXIT] key select pages and fields from the menu system on the LCD screen. (See 1.2.1 Menu System.)

④ **Transport keys:** The left six of these eight keys correspond to the tape transport control buttons on a tape recorder. The RUN LED in the center gives the sequencer's record/playback status. The last two add three convenient functions: Locate, Tempo adjustment and Pad Bank selection.

# Before You Begin

## 1.2.1 Menu System

On the front panel is a two-line screen—your window into the S3 menu system. The S3 uses a system of pages to help you control its functions. The top line of a page gives a label for the page plus other reference information. The bottom line represents a menu with, depending on the page, between one to four fields or choices. When making a selection on the S3, you push the button under your choice immediately below the LCD screen.

*Note: The cursor soft keys may also be used, but only for data entry fields. (See 1.2.2 Menu Keys.)*

*Note: Some pages—the SONG PLAY ARRANGE (SP3) page, for example—have menu fields on the upper line as well.*

These menu fields, which are roughly aligned with the four keys (S1-S4), fall into the following broad categories:

**Number field:** A data field consisting of a numerical value optionally preceded by a label—00 (digit zero), Tr01 (Track 1) or Length=1, for example. Rotating the [DATA ENTRY] dial sweeps the numerical part of the field through all values allowed for that field.

**Enumerated field:** A data field that asks the user to choose from a fixed list of values. Rotating the [DATA ENTRY] dial sweeps the field value through the list of possibilities—ON or OFF to control a switch, for example.

**YES/NO field:** A data field that offers only two choices: YES or NO.

**Text field:** A "fill in the blanks" data field for labeling data. Rotating the [DATA ENTRY] dial changes only one character in the field at a time. Combining either the [DATA ENTRY] dial or the [+YES] and [-/NO] keys with the [SHIFT] key accesses lower case and special characters. This type of field is always enclosed in square brackets—[\*Empty\* ], [IntroBt ] or [Reggae1 ] for example.

**Command:** Not a data input field, but a selection that produces an immediate action. This type of field is always preceded with an asterisk—\*Exec, for example.

**Submenu:** A selection that produces another page with additional menu fields and, in the upper right corner of the display, a triangle pointing upward to remind you that you are working at a lower (sub) level. This type of field is always enclosed in angle brackets—<Set>, for example.

*Note: Sometimes there are even lower levels (sub-submenus) — in the PAD EDIT page, for example.*

*Note: Pressing the [EXIT] key returns to the previous menu.*

## 1.2.2 Menu keys

These controls are for navigating about the S3 menu system, selecting pages and fields within the pages.

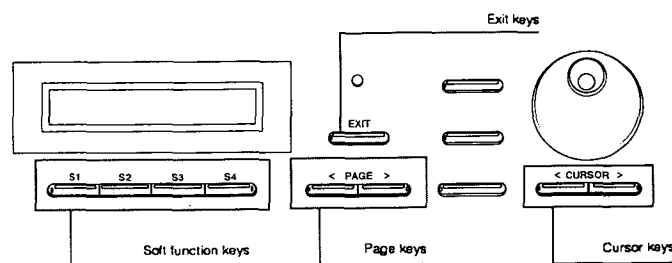

**Soft function keys, [S1]-[S4]:** These keys select the menu fields immediately above them on the lower line of the page on the LCD screen. The results depend on the field type:

**Data entry field:** The flashing block cursor jumps to the corresponding field on the screen. If that field is a text field, the cursor changes to the text cursor, a non-flashing underline under the first character in the field. To reach the other characters in the field, use the cursor keys (described below).

**Blank field:** The cursor does not move.

**Submenu or command field:** When the field is a submenu (noted by <Submenu name>), pressing the soft function key moves you to the new submenu. When the field is a command (noted by \*command), pressing the soft key executes the command directly or asks for re-confirmation (Sure? (Y/N)).

# Before You Begin

**2 Cursor keys, [**<CURSOR**] and [**CURSOR>**]:** These keys also shift the cursor across the page in the LCD screen, but there are important differences from the soft function keys:

- These keys select only data entry fields—that is, the cursor skips command and submenu fields.
- These keys select data entry fields sequentially—in the direction indicated by the arrow next to the key—not by position on the screen
- Coverage extends to any data fields that may be present on the upper line of the display.
- The cursor scans the individual characters of a text field as well. When the cursor hits a text field and changes into the text cursor, pressing [**CURSOR>**] shifts to the next character in the field and pressing [**<CURSOR**] shifts it back.

*Note: Combining [**SHIFT**] with [**CURSOR<**] sends the cursor directly to the far left of the field. This operation works conversely for [**SHIFT**] [**CURSOR>**].*

**Page keys, [**<PAGE**] and [**PAGE>**]:** These keys shift the LCD screen through the current mode's numbered pages in increasing and decreasing order, respectively. These numbers appear in the upper left corner of the page after the two-letter label for the mode. Combining these keys with the [**SHIFT**] key produces the first and last page in the set, respectively.

**EXIT key, [**EXIT**]:** This key returns the screen to a previous page. Typical uses include:

- From a submenu page (look for an upwardly pointing triangle at the end of the upper line and, normally, a name in square brackets at the beginning) to its parent, the menu page that originally produced the submenu.
- From a numbered page to the first page in the series (equivalent to [**SHIFT**]+[**<PAGE**]).
- From a page with a Y/N? or Press Any Key prompt to the page containing the command (most often \*Exec) that originally produced the prompt display. In this case, the key serves as a "cancel" key. In all others, the current page is exited, with all pre-exit changes still in effect.

## 1.2.3 Value Entry Controls

These controls are for changing the value in the current data field as indicated by the cursor on the lower line of the page in the LCD screen.

*Note: The cursor can have one of two shapes: the text cursor, a non-flashing underline ( \_ ) under a single character in a text field or a flashing block cursor ( ▣ ) immediately to the left of a menu field that is not a text field. (See 1.2.2 Menu Keys.)*

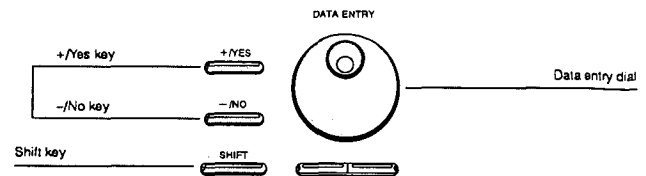

**Increment keys, [**+ /YES**] and [**- /NO**]:** Pressing either of these two keys normally single-steps through the values available for the data field. The [**+ /YES**] key moves to the next value, while the [**- /NO**] key moves to the previous value. Holding these keys down allows continuous scrolling through the values. For a YES/NO field, these two keys always produce YES and NO, respectively. There is no cyclic effect.

**Data entry dial, [**DATA ENTRY**]:** Like a volume control dial on a stereo this dial duplicates the function of the [**+ /YES**] and [**- /NO**] keys except that it allows more rapid changes. Clockwise rotations correspond to the [**+ /YES**] key; counterclockwise ones, to the [**- /NO**] key.

**Shift key, [**SHIFT**]:** Simultaneously holding down this key while using the other controls in this group produces much faster changes in the value. If the data field is a number, using the [**SHIFT**] key with the [**+ /YES**], [**- /NO**] and [**DATA ENTRY**] keys changes the value in steps of 10.

*Note: Combining this key with a soft function key (S1-S4) has no effect except on the ARRANGE PATTERN (SP3) and EFFECT (S3) pages. On the SP3 page, holding down the [**SHIFT**] key while pressing the [**S4**] soft key cycles you through the edit options. On the S3 page, combining the [**SHIFT**] key with the [**S3**] or [**S4**] soft keys accesses the effect parameter edit submenus. (See 5.3 Editing an Effect Type.)*

# Before You Begin

## 1.2.4 Transport Keys

The left six of these eight keys correspond to the tape transport control buttons on a tape recorder. If you are familiar with tape deck or video cassette recorder operation, you will have no trouble using the transport keys.

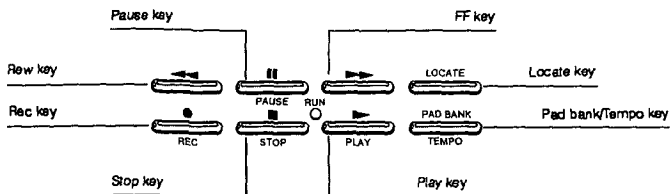

**PLAY key, [PLAY]:** This key starts sequencer playback or recording (after the [REC] key has engaged record ready). The [RUN] LED flashes green during playback.

### PTN PLAY display

```
PTN PLAY▶ I00 1: 1:191
*Roll *Flam K=I1/A
```

### SNG PLAY display

```
SNG PLAY I00 1: 1:191
*Roll *Flam K=I3/B
```

**STOP key, [STOP]:** This key terminates sequencer recording or playback.

**RECORD key, [REC]:** This key activates the recording function and places the sequencer in record ready mode. The [RUN] LED flashes red when the S3 is ready to record. Pressing the [PLAY] key starts actual recording.

### PATTERN PLAY/REC mode's REC READY display

```
REC READY TimSig Bars
▶Tr1 1/16 04/04 04
```

**PAUSE key, [PAUSE]:** During playback, this key functions identically to the PAUSE button on a tape recorder. After pressing [PAUSE], press [PLAY] to resume playback. During recording or REC READY in the PATTERN PLAY/REC mode, however, it switches from real-time recording to step recording.

**FAST FORWARD key, [FF]:** Holding down this key rapidly advances the sequencer position. When the desired position is reached, press [PLAY] to resume listening. While step recording, use [FF] to move the sequencer position ahead step by step. When in the Map Edit subsubmenu of the SP2 Song Setting page, use this key to move ahead to the next tempo change point.

```
[ >> ] I00 99: 4:191
*Roll *Flam K=I3/B
```

**REWIND key, [REW]:** Holding down this key rapidly reverses the sequencer position. When the desired position is reached, press [PLAY] to resume listening. While step recording, use [REW] to move the sequencer position back step by step. When in the Map Edit subsubmenu of the SP2 Song Setting page, use this key to move back to the previous tempo change point.

```
[ << ] I00 100: 1: 1
*Roll *Flam K=I3/B
```

*Note: During playback, the sequencer is placed in pause mode at the new position where the [FF] and [REW] keys are released.*

*Note: The upper line in the page may differ substantially from the examples above because the S3 offers a choice of four different ways to display position—in terms of beats or elapsed time, for example.*

The remaining two keys provide additional S3-specific functions:

**LOCATE function, [LOCATE]:** This function allows the user to set cue points or markers within a song and then jump to them by pressing the corresponding touchpad. Cue points can either be set while the song is playing or when [PAUSE] is in effect. To set a cue point, hold down the [SHIFT] key and press the [LOCATE] key to switch the screen to the CUE POINT SET display.

### CUE POINT SET Display

```
[ SET I00 1: 1: 0 ]
[ Point=2 [ 1: 1: 0 ] ]
```

# Before You Begin

Press a touchpad between 2 and 7. (The sequencer reserves touchpads 1 and 8 for use in jumping to the beginning and end of the song, respectively.)

To jump to a cue point, press the [LOCATE] key to switch the screen to the CUE POINT SELECT display.

## CUE POINT SELECT Display

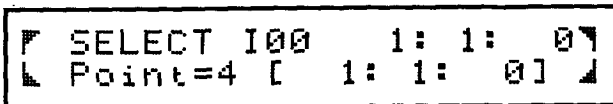

Press a touchpad between 1 and 8.

*Note: These cue points also serve as PUNCH IN and PUNCH OUT points for PUNCH IN recording. (See 2.6.2 PUNCH IN Recording)*

### PAD BANK function, [PAD BANK/TEMPO]:

This key switches the eight touchpads between two banks, Bank A and Bank B, of percussion instruments.

## PAD BANK Display

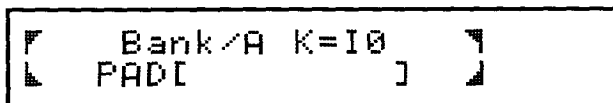

To view the new bank and kit number, press and hold down the PAD BANK key. If you press a touchpad while holding down the PAD BANK key, the touchpad's name will be displayed. Release the PAD BANK key to remain in the new pad bank and return to the previous display.

### TEMPO function, [SHIFT]+[PAD BANK/TEMPO]:

This key combination displays the current tempo on the LCD screen for editing with the [DATA ENTRY] dial or [+ / YES] and [- / NO] keys. Use the cursor keys to switch between the tempo values before and after the decimal point.

## TEMPO Display

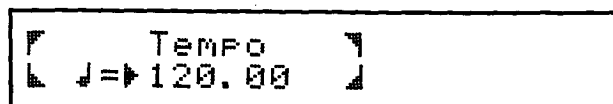

## 1.2.5 Mode Keys



These four keys provide access to a total of eight operation modes. (See *Mode Keys* below.) Next to each key is a pair of labels indicating the two modes assigned to the key. The LED in the key changes color to indicate the mode in effect—green for the upper member of the pair and red for the lower. (The mode also appears as a two-letter abbreviation in the upper left corner of the page in the LCD screen—PP for PATTERN PLAY, for example.) To change modes, simply press the corresponding key. Pressing the same key twice in a row alternates between the upper and lower members of the pair.

### Mode Keys

Function key	Green LED	Red LED
PATTERN	PLAY/REC (PP)	EDIT (PE)
SONG	PLAY/REC (SP)	EDIT (SE)
INSTRUMENT	TIMBRE (T)	KIT (K)
GLOBAL	MIDI (M)	SYSTEM (S)

**PATTERN key:** This key provides access to the PATTERN PLAY/REC and PATTERN EDIT modes. The green LED indicates the PATTERN PLAY/REC mode; the red one, the PATTERN EDIT mode.

**SONG key:** This key provides access to the SONG PLAY/REC and SONG EDIT modes. The green LED indicates the SONG PLAY/REC mode; the red one, the SONG EDIT mode.

**INSTRUMENT key:** This key provides access to the TIMBRE and KIT modes. The green LED indicates the TIMBRE mode; the red one, the KIT mode.

**GLOBAL key:** This key provides access to the MIDI and SYSTEM modes. The green LED indicates the MIDI mode; the red one, the SYSTEM mode.

# Before You Begin

## 1.2.6 Touchpads

These eight touch-sensitive keys sound percussion instruments. Built-in velocity sensors link instrument volume to the striking force on the pad. In all, 16 instruments are available for each drum kit. To access the other eight instruments, use the [PAD BANK/TEMPO] key to switch between Banks A and B. These keys are also used to select cue points within songs.



## 1.2.7 VOLUME Slider

This sliding volume control determines the output level for the stereo jacks at the rear of the S3 as well as the headphone volume.

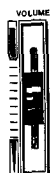

## 1.2.8 LEDs

The RUN LED gives the sequencer's recording/playback status.

The red BEAT LED flashes during recording and playback to give the beat and tempo.

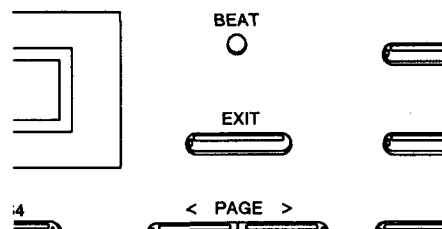
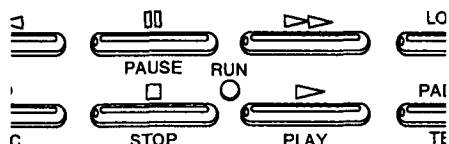

### Color and Status of RUN LED

Color	Status
Steady green	Playback
Flashing green	Pause
Flashing red	Recording ready
Steady red	Recording
Steady orange	Step and Punch in recording
Flashing orange	Punch in recording ready

# Before You Begin

## 1.3 Rear Panel

The rear panel contains the power switch, slots for IC cards and jacks for connecting the S3 to other equipment.

### 1.3.1 Signal Output Jacks

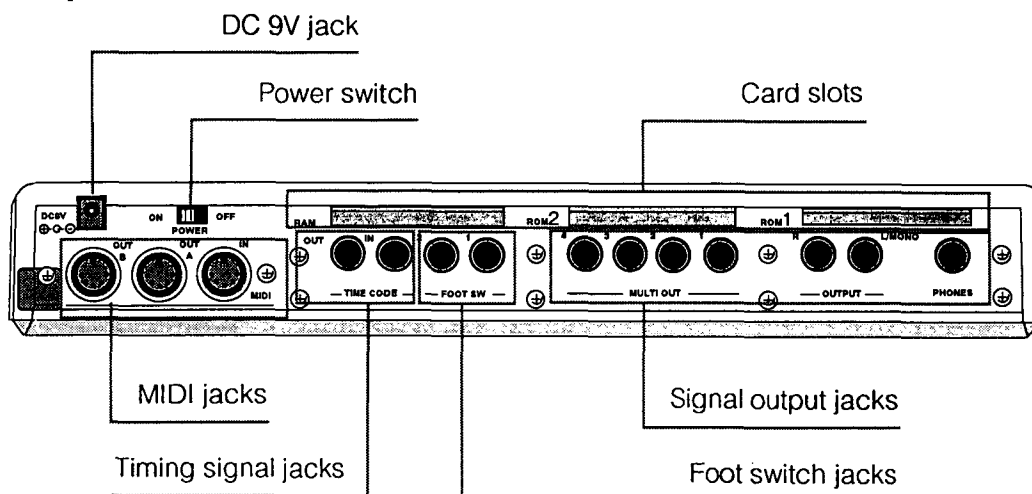

These jacks provide outputs for headphones, amplifiers, mixers and other audio equipment.

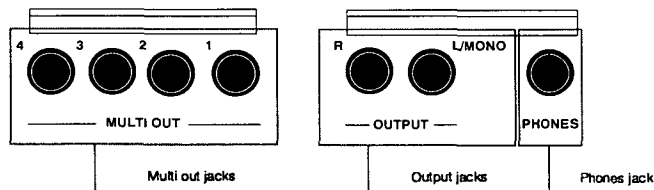

**PHONES jack:** This jack is for monitoring the S3 output with a pair of stereo headphones.

**OUTPUT jacks:** This pair of jacks provide stereo output for amplifiers, mixers and other audio equipment. The L/MONO jack, when used alone, provides mixed output for monaural equipment.

*Note: The stereo separation depends on the output channels and effects assigned with the MONITOR (PP2), SONG SETTING (SP2), TRACK STATUS (SP4), MONITOR (T6), PAD EDIT (P3), EFFECT (S3) and METRONOME (S4) pages.*

**MULTI OUT jacks:** These four jacks provide four-channel output for mixers and other multitrack equipment. One possible application would be to route a particular instrument channel through an external effect.

*Note: These channels are also assigned with the MONITOR (PP2), SONG SETTING (SP2), TRACK STATUS (SP4), MONITOR (T6), PAD EDIT (P3), EFFECT (S3) and METRONOME (S4) pages.*

### 1.3.2 Foot Switch Jacks

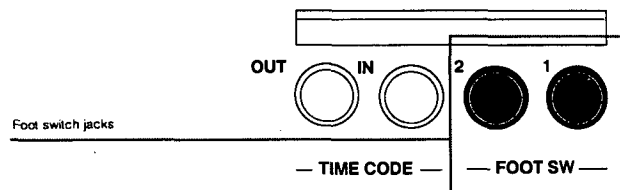

These two jacks are for connecting foot switches to the S3. The settings on the SYSTEM mode's FOOT SWITCH (S8) page determine the function that is assigned to the connected foot switches.

### 1.3.3 Timing Signal Jacks

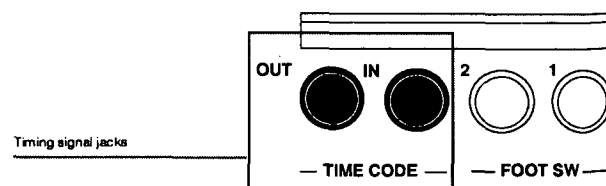

These two jacks are for synchronizing the S3 with SMPTE timing signals instead of the MIDI clock.

**IN jack:** This jack accepts the timing signals from a tape recorder or other synchronizing device.

**OUT jack:** This jack provides timing signals for recording on tape.

# Before You Begin

## 1.3.4 MIDI Jacks

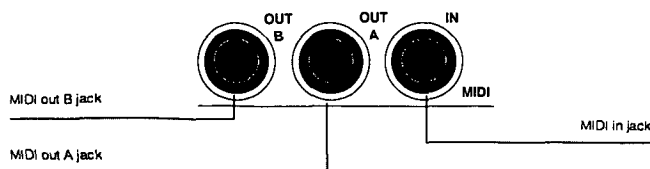

These three DIN jacks allow the S3 to communicate with other MIDI devices.

**MIDI IN jack:** This jack accepts the MIDI messages from keyboards and other MIDI devices.

**MIDI OUT jacks A and B:** These two jacks offer extra flexibility, providing two independent routes for transmitting note data, the MIDI clock and other MIDI messages.

*Note: If desired, each can also simultaneously function as both a MIDI OUT and MIDI THRU jack.*

## 1.3.5 Card Slots

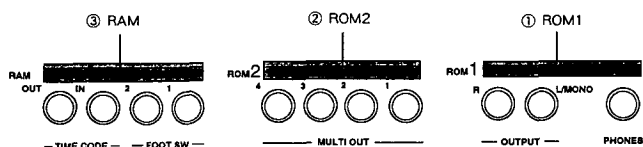

These three slots accept optional IC cards that add extra data storage capacity to the S3. Each slot is for use with either a read-only memory (ROM) card or random access memory (RAM) card.

**ROM card slots 1 and 2:** These two slots accept cards with wave data for up to 40 additional PCM sound sources per card.

**RAM card slot:** This slot accepts cards for storing not just sequencer data (patterns and songs), but also timbres, drum kit configurations and other types of data as well. (See Chapter 8 *Data Dump Facilities*.)

*Note: \*\* Do not insert a ROM card in the RAM card slot or vice versa. \*\**

## 1.3.6 Power Supply

The upper left corner of the rear panel contains the power switch and the jack for the AC adaptor.

**POWER switch:** This switch turns the S3 on and off. Always make sure that this switch is in the OFF position before connecting or disconnecting the AC adaptor either to the S3 or an electrical outlet.

**DC9V jack:** This jack accepts the round plug at the end of the lead on the 9-volt AC adaptor.

**\*\* Use only the AC adaptor supplied with the S3. \*\***



## 1.4 Bottom Panel

### 1.4.1 LCD Contrast Control

The contrast of the LCD screen can be adjusted with a small screwdriver by turning the screw located in the lower right corner of the bottom panel.





# Before You Begin

## 1.5 Setting Up

Connecting the S3 to External Devices

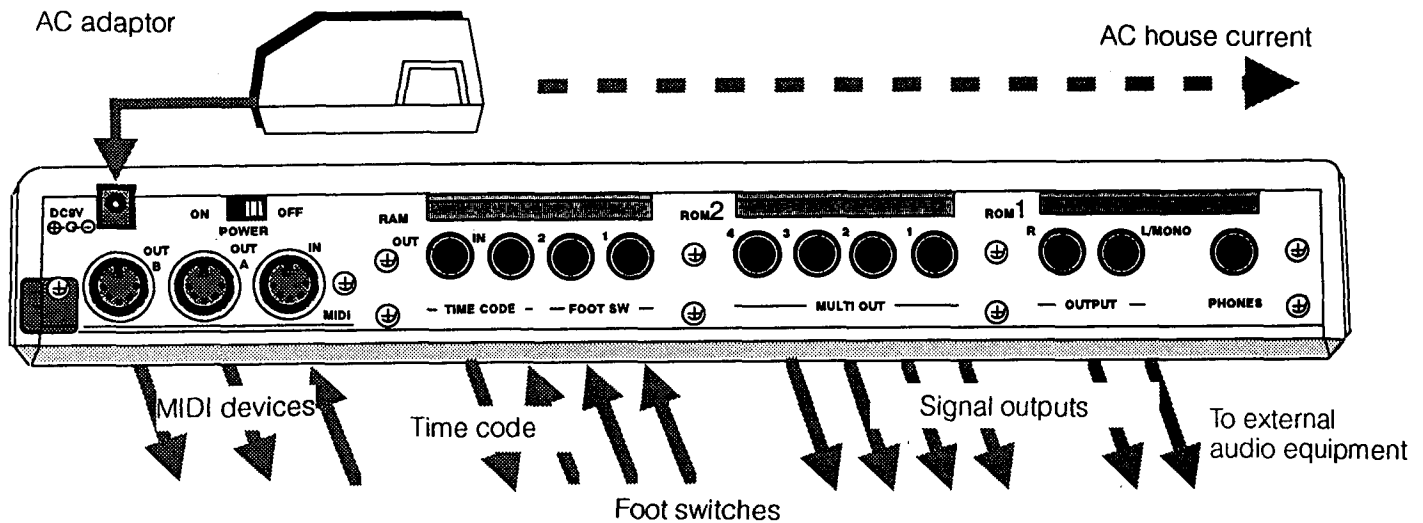

1. Turn the volume controls on all equipment—including the S3—down as far as they will go.
2. Turn all equipment off.
3. Plug the lead on the AC adaptor into the jack at the rear of the S3.
4. Plug the AC adaptor into the power outlet.
5. Turn on the S3.
6. Carefully raise the volume on the S3 and all other equipment to appropriate levels.

course of a musical selection as a song may use the same pattern again and again.

*Note: Although the basic unit is the pattern, it is also possible to play, record and edit a smaller unit consisting of a specific range of bars within the pattern with the RANGE (PP2) page.*

*Note: Each pattern has four tracks for recording up to four different instrument parts. (See 1.6.4 Recording Tracks)*

### Song Construction

Pattern 1	Pattern 2	Pattern 3	Pattern 4
Patterns and other elements joined together to form a song. (Limit: 251 elements)			

2. Arrange these patterns into a song with the ARRANGE (SP3) page.
3. Add four tracks of real-time data.

Unlike regular drum machines, the revolutionary S3 rhythm workstation's playback capabilities do not stop at mechanical repetition of a sequence of patterns. The workstation allows you, the musician to overdub this basic rhythm accompaniment with real-time recordings of drum solos, fill-ins and other variations on up to four separate tracks. To this basic recording/playback capability, the S3 adds complete editing capabilities, two programmable effects, full MIDI support, SMPTE synchronization and other advanced features that make it a powerful addition to any MIDI system.

## 1.6 Organization

### 1.6.1 Patterns and Songs

#### Pattern Construction

Pattern
Variable length (Limit: 99 bars)

Song recording on the S3 is normally a three-step process:

1. Create patterns, the basic unit for constructing songs.

A pattern may consist of one bar or several. The most effective use of patterns is for drum parts, percussion accompaniments and riffs that are repeated in the

# Before You Begin

## 1.6.2 Tracks and Drum Kits

There are two pages for assigning drum kits to tracks: the PATTERN PLAY/REC mode's MONITOR (PP2) page and the SONG PLAY/REC mode's SONG SETTING (SP2) page. The former method, as the name suggests, assigns drum kits for monitoring purposes on a temporary basis and does not store the assignments with the pattern data. The latter, however, stores the assignments with the song data.

## 1.6.3 Kits and Timbres

The sound sources inside the S3 use the Korg Sonic Integrity (SI) sound synthesis system. This system combines the latest in 16-bit PCM sampling technology with the same advanced editing capabilities found on samplers and synthesizers. It synthesizes sounds from two parts: the attack and the decay. On a tom tom, for example, these two parts correspond to the sound of the drumstick hitting the head and the following decay tone.

Built into the S3 are almost 80 waveforms covering everything from drums, cymbals and other percussion instruments to synthesized bass and other instruments normally available only on a synthesizer. These waveforms serve as the starting points for constructing timbres and drum kits.

And because the S3 is a MIDI device, these fully programmable sound sources may be played not only from the S3 touchpads, but also from a synthesizer, sequencer or other external MIDI device.

*Note: Some waveforms cover only part of the total waveform for a particular instrument. Drum sounds, for example, are divided into the initial sound of the stick hitting the head and the subsequent decay inside the drum.*

## Timbres

### Timbre Components

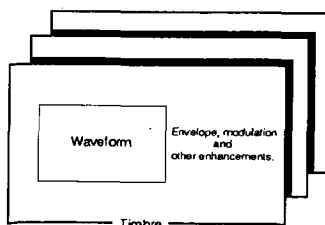

A timbre closely resembles a synthesizer sound source because it contains similar components: a basic waveform plus an envelope, auto bender, modulation and other enhancements to the basic sound of the waveform. The S3 provides two banks of 80 timbres each. One bank is factory preset and cannot be edited. The

other is for storing user-defined timbres. These timbre edits may be copied to and from a RAM card, which can hold up to two such banks.

## Drum kits

### Drum Kit Components

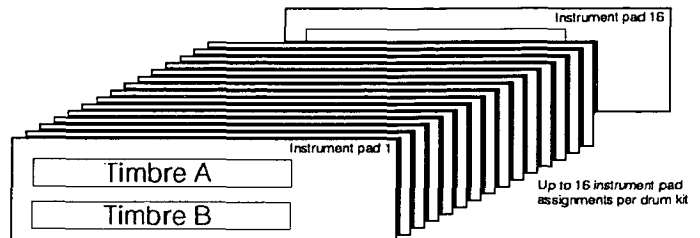

A drum kit is a set of instruments that may be played by striking the touchpads, playing back sequencer data or sending appropriate messages from an external MIDI device. Each kit consists of a name (for reference purposes only, "RockKit", for example) and up to 16 percussion instruments assigned to the touchpads on the front panel in two banks of eight each.

### Instrument Pad Components

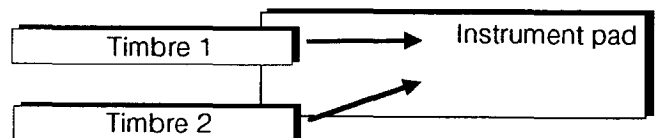

Each instrument pad's sound contains one or two timbres, each with its own pitch, touch response, note range and output assignments. Using two timbres instead of just one allows the possibility to detune the decay portion of a snare, for example, without changing the attack portion. This also means that the velocity response curve for the two timbres can be adjusted independently of each other. A BASS DRUM instrument pad, for example, could combine the BASS DRUM HEAD and BASS DRUM SHELL timbres in such a way that changing the force on the pad alters the relative loudness and produces a more natural sound.

The S3 has two banks of ten drum kits each. One bank (Pre) is factory programmed and cannot be changed. The other (Int) is for storing user-defined drum kits. The Int bank edits may be copied to and from a RAM card, which can hold up to two such banks.

# Before You Begin

## 1.6.4 Recording Tracks

The S3 divides its eight recording tracks into two sets with four tracks each—pattern tracks (1-4) and song tracks (5-8). The standard configuration assigns drum kits to track pairs—Track 1 and Track 5, Track 2 and Track 6, etc.—so that each song track records and plays the same drum kit as the corresponding pattern track. The song tracks may, however, be disconnected from the internal drum kits and assigned different MIDI channels for playing back external sound sources.

### Track Assignments

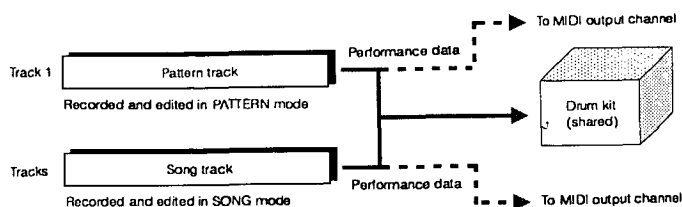

### Pattern tracks

Tracks 1-4, the pattern tracks, correspond to the tracks on a standard rhythm machine. The important thing to remember is that they normally act as a group. It is not possible to assign different numbers of bars and beats to the tracks. They must all be the same length. These tracks are, however, independent with regard to MIDI channel numbers and drum kits. Each pattern is therefore capable of sounding four different kits on four different tracks simultaneously.

### Pattern Composition

Track 1: MIDI and drum kit data for Part 1
Track 2: MIDI and drum kit data for Part 2
Track 3: MIDI and drum kit data for Part 3
Track 4: MIDI and drum kit data for Part 4

..... 1 Pattern .....

## Song tracks

Tracks 5-8 are for recording songs. The standard procedure is to lay a selection of basic rhythm patterns from the pattern tracks end to end to form the background and then overdub. For example, the background instruments might be the bass drum, snare drum and high hat; the overdubbed instruments, the toms and cymbals.

*Note: Here the term "background" refers to regularly repeating sequences. It is more efficient to record such sequences as individual patterns on the pattern tracks because you can then refer to these patterns by number as often as necessary in the song instead of having to play them over and over again yourself. (The more complex the pattern, the more chance of making a mistake.) It is even possible to overdub with the same instruments—to add variations, for example.*

*Note: For recording purposes, the song tracks are identical to tape recorder tracks in that there is only real-time recording (normal or PUNCH IN) and no step recording. Although the standard configuration assigns drum kits to track pairs—Track 1 and Track 5, Track 2 and Track 6, etc.—so that each song track plays the same drum kit as the corresponding pattern track, the TRACK STATUS (SP4) page offers the option of breaking these connections so that the pattern tracks play the internal drum kits and the song tracks play external sound sources—for full 8-track operation.*

# Before You Begin

## Pattern and Song Tracks

The following figure outlines the functional blocks within the S3.

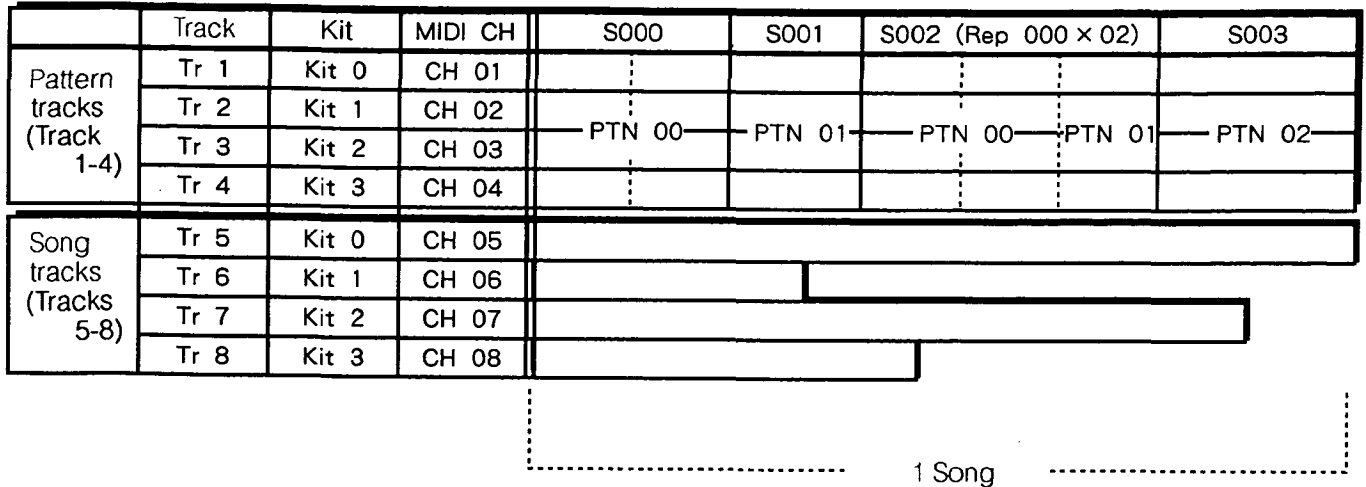

## Block Diagram of the S3

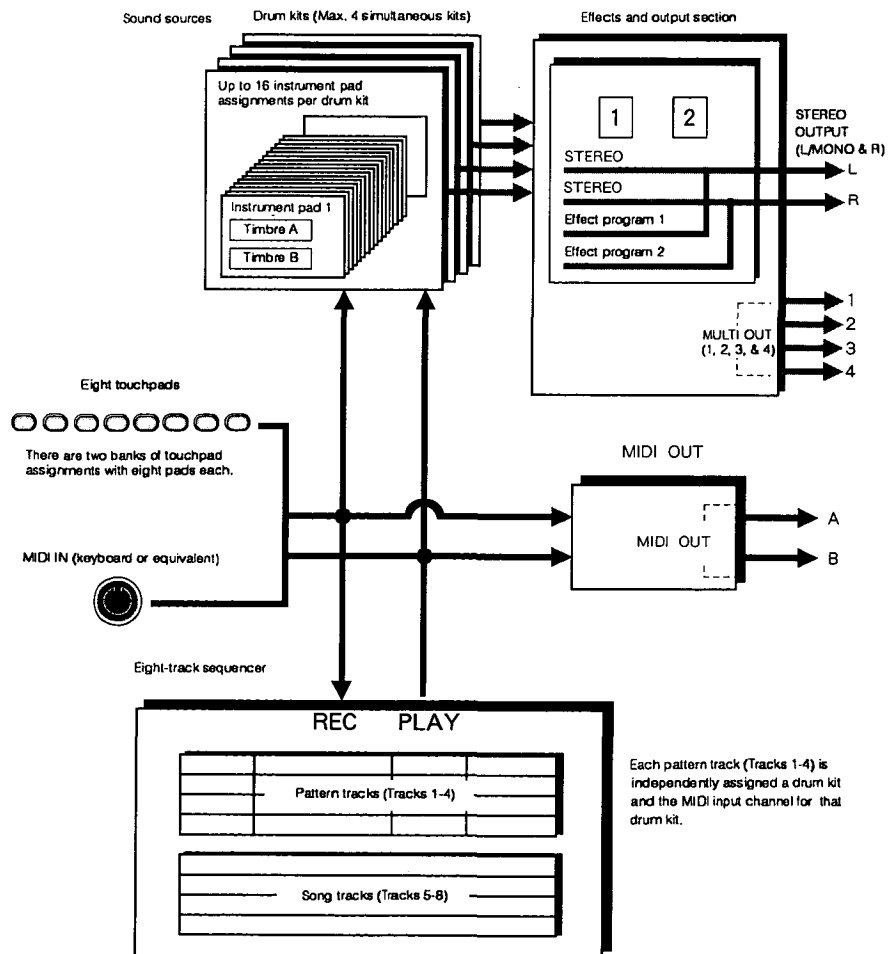

Note: The limits are four polyphonic voices per effect (E1, E2) and eight polyphonic voices for the MULTI OUT jacks.

Note: The MULTI OUT channels bypass the effect. The effects apply only to the stereo output channels.

The four mode keys provide access to eight modes for controlling these blocks. (See Table 1.2.5 Mode Keys)

# Before You Begin

## 1.6.5 PATTERN PLAY/REC (PP) Mode

This mode is for recording and playing back patterns.

Page No.	Page Name	Description	Submenu	Description	Subsubmenu	Description
PP1	PATTERN SELECT	This page is for selecting the pattern to be recorded, played back or edited. It is also for editing the name of the pattern.				
PP2	MONITOR	This page assigns drum kits, effect programs, MIDI ports and MIDI channels to pattern tracks.	KIT/EFFECT	This page assigns drum kits and effect programs.		
			MIDI	This page assigns MIDI ports and MIDI channels.		
PP3	REC LEAD IN	This page is for providing 0-8 bars of metronome ticks in advance of the start of actual recording.				
PP4	RANGE	This page is for limiting recording, playback and editing to a specific set of bars within the pattern.				
PP5	PATTERN ERASE	This page is for erasing a specific type of track data from the current pattern or range.				
PP6	PATTERN CLEAR	This page is for clearing either the current pattern or all recorded patterns from the memory.				

## 1.6.6 PATTERN EDIT (PE) Mode

This mode provides a wide range of functions for editing pattern tracks.

Page No.	Page Name	Description	Submenu	Description	Subsubmenu	Description
PE1	PATTERN SELECT	This page is for selecting the pattern to be played back or edited. It is also for editing the name of the pattern.				
PE2	RANGE	This page is for limiting playback and editing to a specific set of bars within the pattern.				
PE3	TRANSPOSE	This page is for shifting track data up or down by a fixed amount.				
PE4	VELOCITY EDIT	This page provides access to three submenus for adjusting track key velocities.	SHIFT	This page is for shifting the velocities up or down by a fixed amount.		
			COMPRESSION	This page is for rescaling the velocities to reduce their differences.		
			EXPANSION	This page is for rescaling the velocities to accentuate their differences.		
PE5	QUANTIZE	This page is for shifting track data to align it with a particular timing resolution.	SET	This page controls the operation of the QUANTIZE function.		
PE6	SWING	This page is for adding a swing feel.	SET	This page controls the operation of the SWING function.		
PE7	BLANK INSERT	This page is for inserting one or more empty bars into the pattern to make it longer.				
PE8	TRACK COPY/BOUNCE	This page is for replacing or overdubbing data from one pattern track with data from another.				
PE9	PATTERN COPY	This page is for copying tracks from one pattern to another.				
PE10	PATTERN APPEND	This page is for adding the contents of one pattern track to the end of another.				
PE11	PATTERN DELETE	This page is for deleting the current range of bars from the current pattern range.				
PE12	PATTERN ERASE	This page is for erasing a specific type of track data from the current pattern or range.				
PE13	PATTERN CLEAR	This page is for clearing either the current pattern or all patterns from the memory.				

# Before You Begin

## 1.6.7 SONG PLAY/REC (SP) Mode

This mode is for joining patterns, drum kit changes and repeat commands together into songs and then recording real-time tracks to add extra depth and human touches.

Page No.	Page Name	Description	Submenu	Description	Subsubmenu	Description
SP1	SONG SELECT	This page is for selecting the song to be assembled, recorded and played back. It is also for editing the name of the song.				
SP2	SONG SETTING	This page provides access to submenus for setting basic song parameters.	SONG START TIME	This page is for specifying the starting time for a song relative to an external SMPTE timing signal.	NEXT SONG SELECT	This page is for chaining from the current song to another.
			INITIAL TEMPO	This page is for specifying the song's initial tempo, total playing time and any tempo changes during the song.	MAP EDIT	Use this submenu to change the tempo during the song.
			INITIAL KIT	This page is for specifying the initial drum kit assignments for the four track pairs.	SONG TOTAL TIME	Use this submenu to change the song's total time.
			EFFECT ASSIGN	This page is for specifying the song's initial effect program.		
SP3	ARRANGE	This page and its variants are for building a song.				
SP4	TRACK STATUS	This page is for redirecting track outputs to the internal drum kits, MIDI ports and other output jacks.	MIDI	This page controls the MIDI output port connections and channels.		
SP5	REC MODE	This page is for switching between regular recording and PUNCH IN/PUNCH OUT recording.				
SP6	REC LEAD IN	This page is for providing 0 – 16 beats of metronome ticks in advance of the start of actual recording.				
SP7	SONG COPY	This page is for copying all the data in the tracks from the current song to another.				
SP8	SONG CLEAR	This page is for clearing either the current song or all songs from the memory.				

# Before You Begin

## 1.6.8 SONG EDIT (SE) Mode

This mode provides most of the same track editing functions for song tracks that the PATTERN EDIT mode provides for pattern tracks.

Page No.	Page Name	Description	Submenu	Description	Subsubmenu	Description
SE1	SONG SELECT	This page is for selecting the song to be edited and played back. It is also for editing the name of the song.				
SE2	RANGE	This page is for limiting editing to a specific set of bars within the song.				
SE3	TRANSPOSE	This page is for shifting track pitch up or down by a fixed amount.				
SE4	VELOCITY EDIT	This page provides access to three submenus for adjusting track key velocities.	SHIFT	This page is for shifting the velocities up or down by a fixed amount.		
			COMPRESSION	This page is for rescaling the velocities to reduce their differences.		
			EXPANSION	This page is for rescaling the velocities to accentuate their differences.		
SE5	QUANTIZE	This page is for shifting track data to align it with a particular timing resolution.				
SE6	TRACK EDIT	This page is for inserting or deleting track data.				
SE7	TRACK ERASE	This page is for erasing some or all track data.				
SE8	TRACK PASTE	This page is for copying data (bouncing, copying or inserting) from one song track to a point in another.	PASTE	This page is for specifying the position at which to insert the data in the destination track.		
SE9	SONG CLEAR	This page is for clearing either the current song or all songs from the memory.				

## 1.6.9 TIMBRE (T) Mode

This mode is for assigning waveforms to timbres and saving edits to the ENVELOPE, MODULATION and AUTO BEND parameters.

Page No.	Page Name	Description	Submenu	Description	Subsubmenu	Description
T1	TIMBRE SELECT	This page is for selecting the timbre to be edited. It is also for editing the name of the timbre.				
T2	WAVE FORM ASSIGN	This page is for selecting the waveform used in the timbre.				
T3	ENVELOPE	This page allows setting the envelope sustain function on or off.	SET	This page is for setting envelope data points.		
T4	AUTO BEND	This page controls the amount of AUTO BEND added to the timbre.				
T5	MODULATION	This page controls the type and amount of modulation added to the timbre.				
T6	MONITOR	This page controls the tuning and output level of the timbre monitor.	TUNE	This page is for tuning the timbre output.		
			OUT	This page is for specifying the output jacks, levels and stereo balance for the timbre.		
T7	TIMBRE COPY	This page is for copying a timbre from one location to another.				

# Before You Begin

## 1.6.10 KIT (K) Mode

This mode is for editing drum kits, the timbre combinations that the S3 uses to produce notes from touchpad strokes from sequencer playback or MIDI messages. It also contains a submode, the PAD (P) Submode. This submode is for assigning timbres to pads and

making edits to relative tuning, levels, response curves and output routings in the current drum kit. The entrance to the PAD submode appears as a submenu in the KIT SELECT (K1) page.

Page No.	Page Name	Description	Submode	Description	Submenu	Description
K1	KIT SELECT	This page is for selecting the drum kit to be edited. It is also for editing the name of the drum kit.	P1 PAD NAME	This page is for editing the name assigned to the instrument pad.		
			P2 TIMBRE SETUP	This page is for assigning one, two or no timbres to the instrument pad's two timbre slots.		
			P3 PAD EDIT	This page provides access to submenus for editing instrument pad characteristics.	TUNE	This submenu is really two pages: one (Main) for tuning the combined output of the two timbre slots and another (A/B) for tuning the timbres relative to each other.
					BALANCE	This page is for adjusting the relative loudness between the two timbre slots.
			RESPONSE	These two pages are for adjusting the velocity response curves for the two timbre slots (TimA and TimB).		
				OUT	This page is for routing the individual timbres to outputs.	
K2	PAD ARRANGE	This page is for assigning an instrument pad from an existing drum kit to an instrument pad in the current drum kit.				
K3	PAD MODE	This page is for specifying instrument pad voice parameters.				
K4	PAD LEVEL	This page is for setting instrument pad output levels.				
K5	NOTE ASSIGN	This page is for assigning MIDI note numbers to instrument pads.				
K6	MONITOR	This page is for assigning an effect program to the drum kit monitor.				
K7	KIT COPY	This page is for copying the current drum kit.				



# Before You Begin

## 1.6.11 MIDI (M) Mode

This mode provides functions for controlling the MIDI interface.

Page No.	Page Name	Description	Submenu	Description	Subsubmenu	Description
M1	REC CHANNEL SELECT	This page is for telling the S3 whether to record data from a single MIDI input channel or from all channels.				
M2	REC MESSAGE FILTER	This page is for filtering unwanted types of MIDI messages during recording.				
M3	RECEIVE FILTER	This page is for filtering unwanted MIDI messages during playback, recording and when the S3 is used as a MIDI sound source by an external MIDI device.				
M4	MIDI OUTPUT	This page is for configuring the two MIDI OUT ports.				
M5	GLOBAL CHANNEL	This page is for selecting the MIDI channel on which the S3's internal effects receives program change messages from external MIDI devices. This is also the channel that would be used to send/receive system exclusive messages.				

# Before You Begin

## 1.6.12 SYSTEM (S) Mode

This mode controls synchronization, effects, IC cards and other aspects of overall operation.

Page No.	Page Name	Description	Submenu	Description	Subsubmenu	Description
S1	CLOCK	This page is for selecting the type of synchronization, the frame rate for SMPTE synchronization and the response to certain MIDI system real-time messages.				
S2	TUNE	This page is for global transposing and tuning of the S3.				
S3	EFFECT	This page is the starting point for all effect editing operations.	SET	This page is for selecting the placement and pan settings for the current effect program.	COPY	This page is for copying the current effect program number to another effect program number.
			Parameter displays	These pages are for editing the current effect program parameters.		
S4	METRONOME	This page controls the built-in metronome.	OUT	This page is for selecting the metronome's output channel, level and stereo balance.		
S5	ROLL/FLAM	This page controls rolls and flams.				
S6	PAD MODE	This page is for assigning a scale to the touchpads.	USER	This page is for assigning a user-defined scale to the touchpads.		
S7	PAD SENSITIVITY	This page controls touchpad sensitivity.	SET	This page is for specifying touchpad volume-velocity response curves.		
S8	FOOT SWITCH	This page is for specifying the control functions assigned to the two foot switch input jacks.				
S9	SYSTEM EXCLUSIVE	This page controls the transmission of programming data using MIDI SYSTEM EXCLUSIVE messages.	MIDI DUMP	Use this submenu to transmit timbres, drum kits, sequencer data, etc. to a compatible external MIDI device.		
			COMMUNICATION Mode	Use this submenu to receive timbres, drum kits, sequencer data, etc. from a compatible external MIDI device.		
S10	TIME CODE GENERATE	This page controls the generation of SMPTE timing signals.				
S11	FREE MEMORY	This page tells how much space remains available on the RAM card and in the internal bank.				
S12	CARD	This page controls the transmission of S3 programming data between the S3 internal bank and a RAM card. It also provides facilities for formatting (initializing) cards for use with the S3.	CARD BANK	This page is for switching, creating and deleting banks.		
			TRANSFER	This page is for transferring data to and from cards.		
			FORMAT	This page is for initializing a new card for use with the S3.		

# Chapter 2 Basic Operation

## 2.1 Playing Manually

Use the following procedure to try out some of the S3's basic capabilities as a rhythm machine:

### Sample Touchpad Assignments

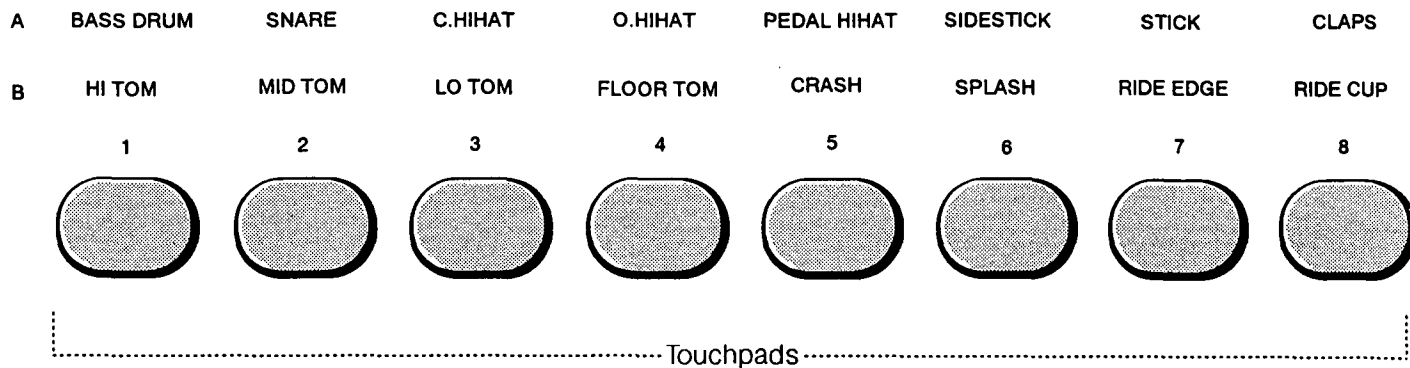

1. Turn off the power to all equipment before connecting or disconnecting any equipment.
2. Connect a speaker system or a pair of headphones to the S3.
3. Turn on the S3.
4. Strike the eight touchpads in any order to see what instruments they produce.
5. Strike the same touchpad with different amounts of force to see how velocity (the force which you strike the touchpad) affects the output.
6. Press the [PAD BANK/TEMPO] key, hold it down and read the screen to see the new bank, kit number and pad name. Pressing the [PAD BANK/TEMPO] key switches you between pad banks A and B.

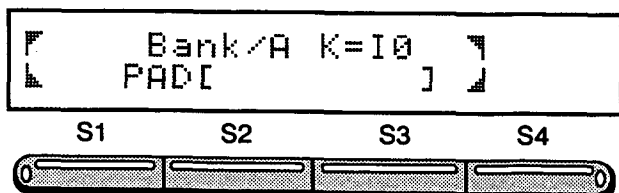

7. Experiment with the touchpads and the new bank.
8. Press the [PLAY] key to play back the factory programmed 00 pattern.

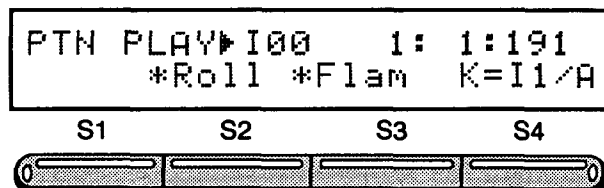

*Note: When the power is first applied, the current pattern is always 00.*

9. Change the pattern number.  
Use the [S2] soft key or the [<CURSOR] and [CURSOR>] keys to select the second menu item.  
Use the [+ / YES] and [- / NO] keys or the [DATA ENTRY] dial to change the field value.
10. Repeat the above two steps to hear all patterns available in the internal memory bank.

# Basic Operation

## 2.1.1 Changing Drum Kit Assignments

Use the following procedure to change the drum kits assigned to the current pattern's four pattern tracks:

1. Switch the screen to the MONITOR (PP2) page.

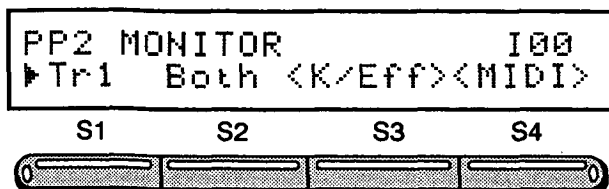

- a. Press the PATTERN key until the LED inside it turns green.
  - b. If necessary, press the [EXIT] key until the abbreviation PP1 appears in the upper left corner of the display.
  - c. Use the [<PAGE] and [PAGE>] keys to reach the MONITOR (PP2) page.
2. (Optional) Change the track (1-4).

Use the [S1] soft key or the [<CURSOR] and [CURSOR>] keys to select the first menu item.

Use the [+ / YES] and [- / NO] keys or the [DATA ENTRY] dial to change the field value.

5. Change the drum kit assignment.

Use the [S3] soft key or the [<CURSOR] and [CURSOR>] keys to select the third menu item.

Use the [+ / YES] and [- / NO] keys or the [DATA ENTRY] dial to change the field value.

6. Press the [EXIT] key to return to the PP2 page

7. Press the [PLAY] key to hear the same rhythm pattern with the new drum kit.

## 2.1.2 Adding an Effect

The KIT/EFFECT submenu also allows you to add or change the effects assigned to the current pattern's four pattern tracks:

1. Switch to the KIT/EFFECT page.  
(See procedure above.)

2. Change the effect assignment.

Use the [S4] soft key or the [<CURSOR] and [CURSOR>] keys to select the fourth menu item.

Use the [+ / YES] and [- / NO] keys or the [DATA ENTRY] dial to change the field value. See Chapter 5 *Effects* for a full discussion of effects and effect editing procedures.

3. Switch to the KIT/EFFECT submenu.

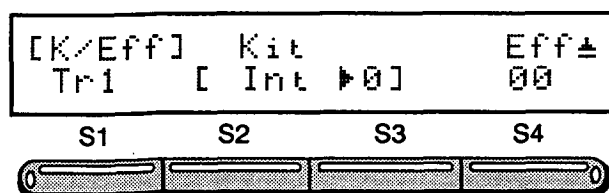

Use the [S3] soft key to display the submenu.

4. (Optional) Change drum kit banks (internal, card or preset).

Use the [S2] soft key or the [<CURSOR] and [CURSOR>] keys to select the second menu item.

Use the [+ / YES] and [- / NO] keys or the [DATA ENTRY] dial to change the field value.

## 2.2 Playing Demo Songs

The S3 comes with three preprogrammed demonstration songs.

- Song 00 "Sonic Boom" composed by John Lehmkuhl
- Song 01 "Norb Demo" composed by Norbert Goldberg
- Song 02 "Akira" composed by Akira Ishiguro

Use the following procedure to play them back:

1. Switch the screen to the SONG PLAY/REC mode's SONG SELECT (SP1) page.

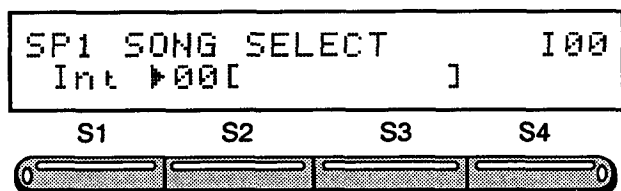

- a. Press the SONG key until the LED inside it turns green.
  - b. If necessary, press the [EXIT] key until the abbreviation SP1 appears in the upper left corner of the display.
2. If necessary, change to the Int (Internal) song bank.

Use the [S1] soft key or the [<CURSOR] and [CURSOR>] keys to select the first menu item.

Use the [+ / YES] and [- / NO] keys or the [DATA ENTRY] dial to change the field value.

3. Select the song.

Use the [S2] soft key or the [<CURSOR] and [CURSOR>] keys to select the second menu item.

Use the [+ / YES] and [- / NO] keys or the [DATA ENTRY] dial to change the field value.

4. Press the [PLAY] key to hear the song.

5. Press the [PAUSE] and [PLAY] keys to interrupt playback and then resume it from the same point.
6. Press the [STOP] and [PLAY] keys to interrupt playback and then restart the song from the beginning.

## 2.3 All System Initialize

This function wipes out the data in the user area of the S3 (RAM), returning the S3 to its original factory setting.

Upon leaving the Korg factory, the S3 had three demo songs recorded into the internal memory user area. Because these songs are useful as learning tools, they have been permanently recorded in the internal ROM. When you first turn on the S3 or do an All System Initialize, the demo songs are copied from the ROM area to the internal bank of the RAM user area. So even if you erase the demo patterns and songs, they can always be retrieved by doing an All System Initialize.

*Note: Because an All System Initialize wipes out all the data in the RAM user area, it is a good idea to make a "back-up" copy of the RAM user area by saving (transferring) the kit data, pattern data, etc. to an external RAM card. See Chapter 8 Data Dump Facilities.*

Procedure:

1. Turn off the power.
2. While holding down simultaneously the STOP and [S1] soft keys, turn on the power.

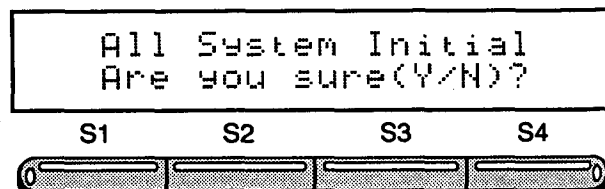

3. Answer the question Are you sure (Y/N)? with either the [+ / YES] key to proceed or the [- / NO] key to cancel. You may also use the [EXIT] key to cancel.

Upon answering the question, the S3 resumes operation to the Pattern Mode's PATTERN SELECT (PP1) Page.

# Basic Operation

## 2.4 Recording Patterns

### A Pattern in Musical Notation

Use the procedures in this section to record patterns, the basic units for songs.

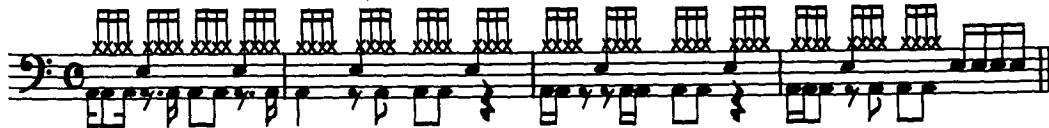

The starting point for these procedures is always the PATTERN PLAY/REC mode. If you are in a different mode, press the [PATTERN] key until the LED inside it

turns green and then press the [EXIT] key until the abbreviation PP1 appears in the upper left corner of the display.

### Recording a Pattern

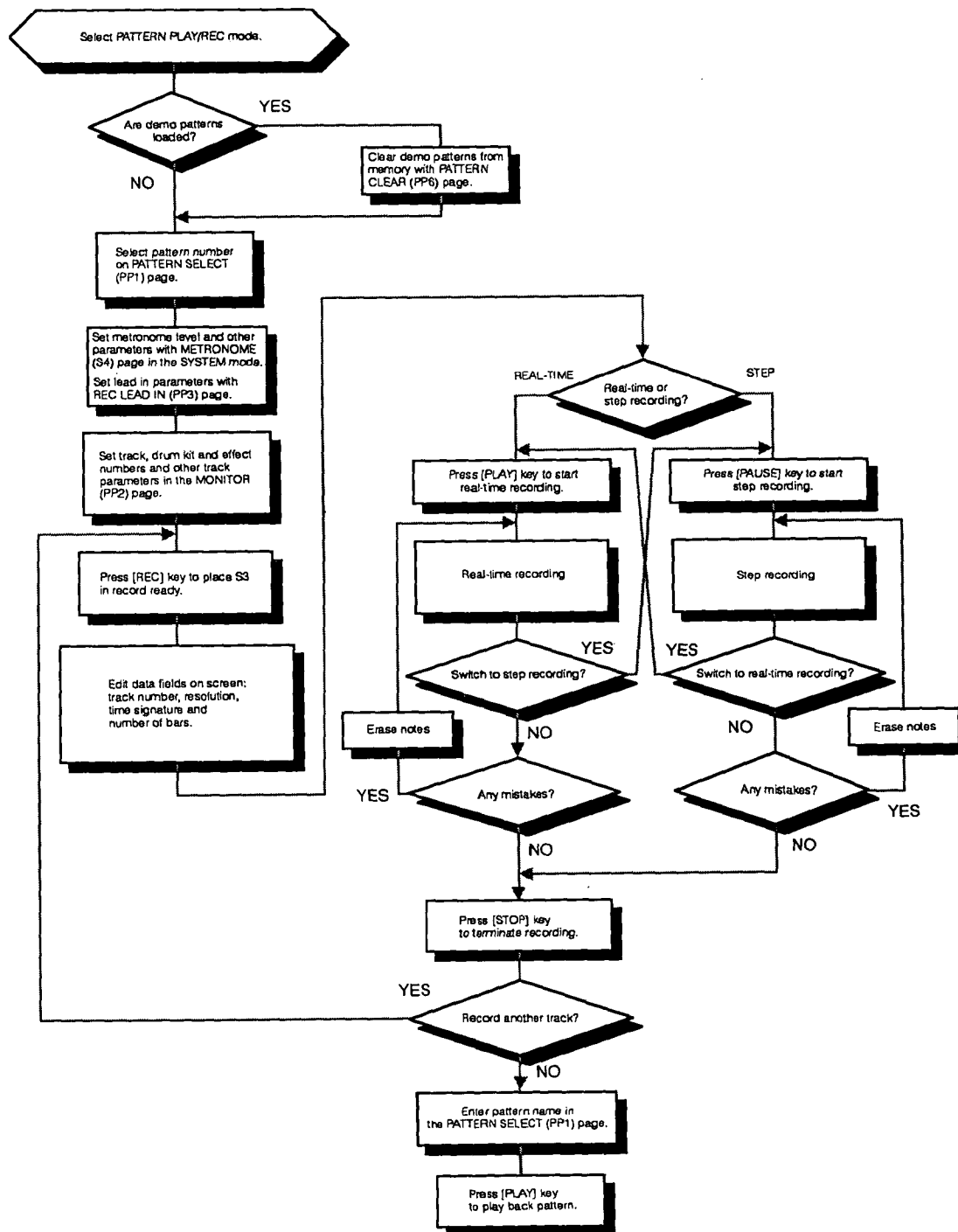

# Basic Operation

## 2.4.1 Real-Time Recording

1. Select the PATTERN PLAY/REC mode.
2. Clear the demo patterns from memory in the PATTERN CLEAR (PP6) page.
  - a. Use the [<PAGE] and [PAGE>] keys to reach the PATTERN CLEAR (PP6) page.

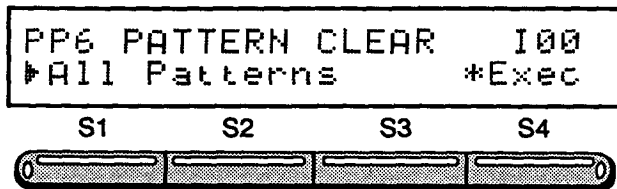

- b. Use the [+YES] and [-NO] keys or the [DATA ENTRY] dial until the first data field reads All Patterns.
  - c. Execute the erase by pressing the [S4] soft key.
  - d. Press the [+Yes] key to erase the patterns.
3. Select the pattern number on the PATTERN SELECT (PP1) page.

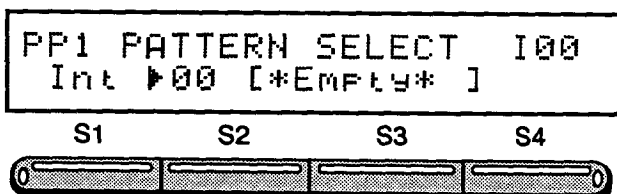

- a. Select the PATTERN SELECT (PP1) page with the [EXIT] key, the [SHIFT]+[<PAGE] combination or repeated presses of the [<PAGE] key.
- b. Use the [S2] soft key or the [<CURSOR] and [CURSOR>] keys to select the second menu item.

Use the [+YES] and [-NO] keys or the [DATA ENTRY] dial to change the field value.

*Note: The text field over the [S3] soft key, the pattern name, automatically changes with the pattern number, but these changes are not apparent if all patterns are empty and thus have the same name, \*Empty\*.*

- c. Press the [S3] soft key to shift the cursor to the pattern name field.

- d. Edit the pattern name. (See 3.1.1 PATTERN SELECT (PP1) Page.) If the pattern is empty, the name field is not accessible because a pattern without data cannot be named.

4. Set the metronome parameters in the METRONOME (S4) page, the page which controls the metronome's output assignment, volume and resolution.

- a. Press the GLOBAL key until the LED inside it turns red.

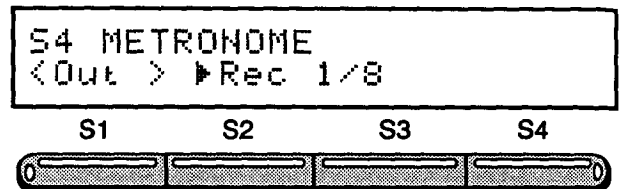

- b. Use the [<PAGE] and [PAGE>] keys to reach the METRONOME (S4) page.
- c. Set the switch to Rec so that the metronome sounds only during recording.

Use the [S2] soft key or the [<CURSOR] and [CURSOR>] keys to select the second menu item.

Use the [+YES] and [-NO] keys or the [DATA ENTRY] dial to change the field value.

- d. Set the resolution to 1/8—one tick for every eighth note.

Use the [S3] soft key or the [<CURSOR] and [CURSOR>] keys to select the third menu item.

Use the [+YES] and [-NO] keys or the [DATA ENTRY] dial to change the field value.

# Basic Operation

5. Use the REC LEAD IN (PP3) page to add a one-bar lead in of metronome ticks before recording actually starts.

a. Press the PATTERN key until the LED inside it turns green.

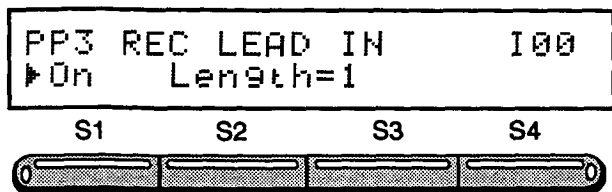

b. Use the [<PAGE] and [PAGE>] keys to reach the REC LEAD IN (PP3) page.

c. Turn the lead in function ON.

Use the [S1] soft key or the [<CURSOR] and [CURSOR>] keys to select the first menu item.

Use the [+ / YES] and [- / NO] keys or the [DATA ENTRY] dial to change the field value.

d. Set the lead in length to 1.

Use the [S2] soft key or the [<CURSOR] and [CURSOR>] keys to select the second menu item.

Use the [+ / YES] and [- / NO] keys or the [DATA ENTRY] dial to change the field value.

*Note: This setting is not stored with the pattern data. It remains in effect only in the PATTERN record mode.*

6. Use the MONITOR (PP2) page to assign drum kits, effects and MIDI output channels to the pattern tracks. (These drum kit assignments, per track, are saved globally in the PATTERN mode. The effect program is the same for all four tracks.)

For recording it is necessary to select the track to record on in the REC READY display, but the actual drum kit assignments per track and effect setting is done in the MONITOR (PP2) page.

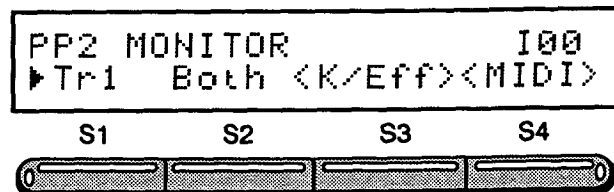

a. Use the [<PAGE] and [PAGE>] keys to reach the MONITOR (PP2) page.

b. Use the same procedures as used in 2.1 "Playing Manually" to modify the values.

*Note: These kit and effect settings are not stored with the individual pattern data. They are stored globally in the PATTERN mode.*

7. Press the [REC] key to switch to the REC READY display. The RUN LED flashes to indicate that the S3 is ready to record.

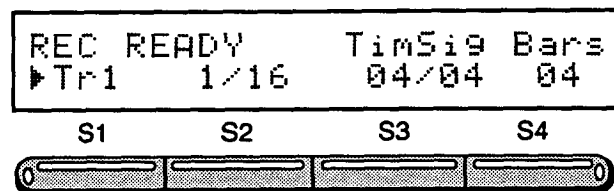

8. Edit the data fields on screen: track number, resolution, time signature and number of bars.

*Note: Once the pattern has data, the last two fields, time signature and number of bars, cannot be changed.*

*Note: The second field offers a choice of eight resolutions: 1/4, 1/4T, 1/8, 1/8T, 1/16, 1/16T, 1/32, 1/32T. The ones ending with "T" denote triplets. The selection High disables the quantizing function. (See 3.2.5 QUANTIZE for an explanation of quantization.)*

*Note: Use the [<CURSOR] and [CURSOR>] keys to move between the two parts of the time signature. The first part may be any number between 1 and 8 (64). The second part is limited to 4, 8, 16 and 32.*

*Note: When recording from an external MIDI device, the High quantize selection must be used. When recording, if a lower quantization rate is selected, only note data can be recorded—all other data including pitch bend and control changes will not be recorded.*



# Basic Operation

## 9. Select the tempo.

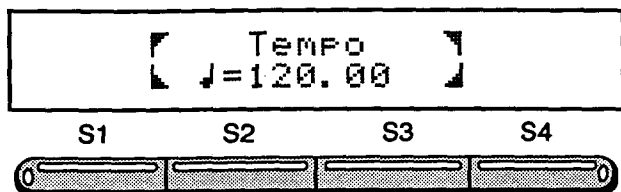

- Hold down the [SHIFT] key and press the [PAD BANK/TEMPO] key to switch the screen to the TEMPO display.
- Use the [+ / YES] and [- / NO] keys or the [DATA ENTRY] dial to change the field value. Use the cursor keys to switch between the tempo values before and after the decimal point.
- Press any key except the [SHIFT], [<CURSOR] and [CURSOR>], [+ / YES] and [- / NO] or mode keys to return to the REC READY display.

*Note: For your convenience, the tempo may also be changed during recording.*

## 10. Press the [PLAY] key to start the lead in and recording and switch the screen to the PTN REC display.

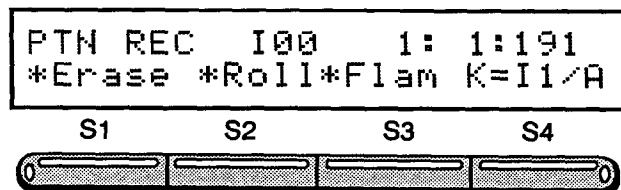

While recording the RUN LED stays on. The upper line of the PTN REC display gives the current pattern number (I00) and the current position (1:1:191) in bars, beats and ticks. The lower line provides commands for erasing notes and adding drum rolls and flams and gives the current drum kit and touchpad bank (K=I01/A). The drum roll and flam timings are set in the SYSTEM mode's ROLL/FLAM (S5) page. (See 9.05 ROLL/FLAM (S5) Page.)

## 11. Record a pattern.

The sequencer records not only the notes corresponding to the touchpad strokes, but also their velocity—that is, the force with which the notes are pressed.

Since the S3 sequencer supports overdubbing, there is no need to record the entire pattern at once. When the sequencer reaches the end of the pattern, it automatically restarts from the beginning and plays back the current contents even as new notes are added. It is therefore possible to create quite complex patterns by recording a single percussion instrument on each pass through the pattern.

You may also switch between touchpad banks at any time.

## 12. Erase mistakes.

This function lets you easily erase unwanted notes. The erase function does not require that you stop recording before you can erase. In fact, you may switch between recording and erasing as often as you wish.

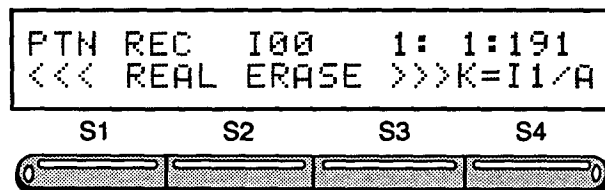

- Hold down the [S1] soft key to switch to the Real Time Erase display (while in Pattern Record).
- To erase one note, simply press the corresponding touchpad at the corresponding point in the pattern. The S3 then removes that note. If you hold down a touchpad, the S3 erases all the recorded notes for that corresponding instrument during the interval.
- Release the [S1] soft key to return to recording.

## 13. Press the [STOP] key to terminate recording and return to the display that was on the screen when the [REC] key was pressed.

# Basic Operation

14. Switch tracks and repeat.
  - a. Press the [REC] key to switch to the REC READY display.
  - b. Select the new track with the first field.
  - c. If necessary, use the MONITOR (PP2) page to change the drum kit, effect and MIDI channel assignments for the new track.
  - d. Press the [PLAY] key and record using the procedures above.
- Note: A pattern may use up to four tracks, but you cannot change their time signatures and lengths during recording.*
- Note: The S3's sequencer has a maximum capacity of 32 simultaneously played notes for all tracks combined (excepting muted tracks). When recording, if more than 32 polyphonic notes are played, a warning message is displayed. The same warning occurs if a pattern which has more than 32 polyphonic notes is played.*
15. Press the [PLAY] key to play back the completed pattern.
16. Press the [STOP] key to terminate playback.
17. If the pattern is incomplete, go back and continue recording. If the pattern contains mistakes, you can go back to the Real Time Erase function, edit the data in the PATTERN EDIT mode (see Chapter 3 *PATTERN and SONG Modes*) or clear the pattern with the PATTERN CLEAR (PP6) page (see 3.2.13 *PATTERN CLEAR (PE13) Page*) and start again.
18. Use the [<PAGE] and [PAGE>] keys to reach the PATTERN SELECT (PP1) page.
19. Give the pattern a name.
 

Use the [S3] soft key or the [<CURSOR] and [CURSOR>] keys to select the third menu item.

Use the [<CURSOR] and [CURSOR>] keys, the [+ / YES] and [- / NO] keys and the [DATA ENTRY] dial to edit the text field.
20. Repeat the above procedures for other patterns.

## 2.4.2 Step Recording

Step recording gives you, the musician, complete freedom to record any type of note or note sequence at any point in the pattern. This note-by-note approach can, however, be a lot more time-consuming than real-time recording.

Step recording as its name implies allows recording only in fixed steps or increments. Instead of using notes, the S3 measures step size in ticks. A tick is defined as 1/192 of a quarter note. (See chart below.) The S3 offers eight step sizes—1/4, 1/4T, 1/8, 1/8T,

1/16, 1/16T, 1/32 and 1/32T—plus High for the ultimate in precision, a tick at a time.

To change the step size, switch to the second field, recording resolution, in the REC READY display (see 2.4.1 *Real-Time Recording*).

*Note: When recording from an external MIDI device, the High quantize selection must be used. When recording, if a lower quantization rate is selected, only note data can be recorded—all other data including pitch bend and control changes will not be recorded.*

### Step Size vs. Recording Resolution

Recording resolution	Step size (ticks)	Tick field values										
1/4	Quarter note (192)	0 191										
1/4T	Quarter note triplets (128)	0 127 128										
1/8	Eighth note (96)	0 95 96 191										
1/8T	Eighth note triplets (64)	0 63 64 127 128 191										
1/16	Sixteenth note	0 47 48 95 96 143 144 191										
1/16T	Sixteenth note triplets (32)	0 31 32 63 64 95 96 127 128 159 160 191										
1/32	32nd note (24)	0 23 24 47 48 71 72 95 96 119 120 143 144 167 168 191										
1/32T	32nd note triplets (16)	0 16 32 48 64 80 96 112 128 144 160 176										

# Basic Operation

Procedure:

1. Use the real-time recording procedures outlined above in 2.4.1 *Real-Time Recording* up to step 10.
2. Press the [PAUSE] key to switch to the STEP REC display. The RUN LED turns orange with the STEP REC display. (Step recording can be started on the REC READY display or during actual real-time recording, on the PTN REC display.)

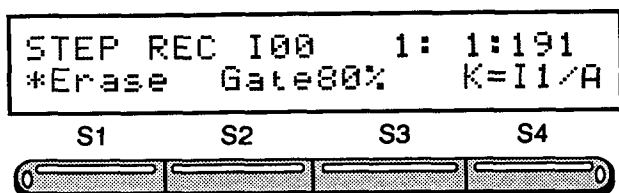

This page resembles the PTN REC display with the only difference being the gate timing field in the middle of the lower line.

The gate timing field specifies note length relative to the current step length. The default gate time is 80%. This capability is especially effective for controlling the articulation—that is, legato and staccato effects—of synthesizers and other external MIDI sound sources. Internally, it only applies to instruments for which the SUSTAIN switch in the TIMBRE mode's ENVELOPE (T3) page is ON. Such instrument's notes can be lengthened a desired number of steps by holding down the pad while moving the sequencer position ahead with the [FF] key.

3. Set the gate time. (50, 80 or 100% of step length)

Use the [S2] or [S3] soft keys to cycle through the three possible values.

4. Use the touchpads to record individual notes.

- a. Use the [FF] and [REW] keys to move to the desired position in the pattern.

*Note: Each keystroke changes the position counter by the number of ticks corresponding to the current recording resolution, which appears in the second field in the REC READY display. If the current resolution is 1/4 (quarter notes), for example, pressing the [FF] key advances the counter by 192 ticks or one beat.*

- b. Press the touchpad for the desired instrument. It is also possible to simultaneously record multiple instruments. Either strike all touchpads simultaneously or hold down one as you strike the rest.

- c. Release the touchpad to store the note and advance the counter. If you press more than one touchpad, the counter only advances when you have released the last one.

5. Erase mistakes.

- a. Use the [FF] and [REW] keys to move to the desired position in the pattern.

- b. Hold down the [S1] soft key to switch to the STEP ERASE display.

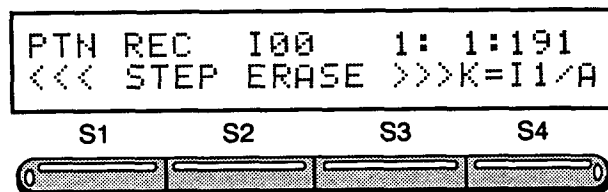

- c. To erase a note, simply press the corresponding touchpad at the corresponding point in the pattern. You may simultaneously erase notes for more than one touchpad. When you release the touchpad, the S3 automatically advances the counter.

- d. Release the [S1] soft key to return to recording.

6. Press the [STOP] key to terminate recording and return to the display that was on the screen when the [REC] key was pressed.

*Note: The S3's sequencer has a maximum capacity of 32 simultaneously played notes for all tracks combined (excepting muted tracks). When recording, if more than 32 polyphonic notes are played, a warning message is displayed. The same warning occurs if a pattern which has more than 32 polyphonic notes is played.*

# Basic Operation

## 2.4.3 Next Pattern Play

Up until now, you've learned how to create patterns, edit them and play them back. The next step is to arrange these patterns into a song. When making a song it is very useful to be able to compare patterns by playing them one after another. The Next Pattern Play function allows you to play any recorded pattern one after another from any bank without stopping the sequencer.

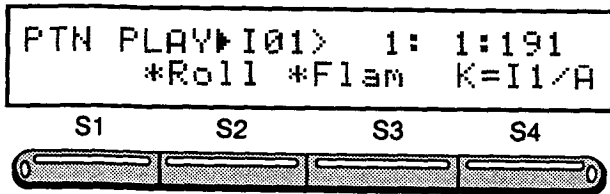

When the [PLAY] key is pushed, the current pattern begins playing. To choose another pattern just use the [+ / YES] and [- / NO] keys or the [DATA ENTRY] dial to change the pattern number.

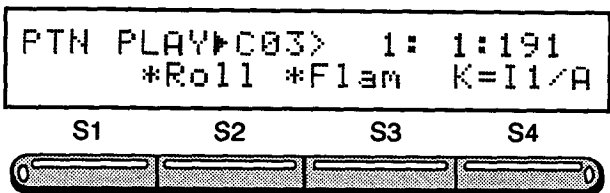

Use the [<CURSOR] and [CURSOR>] keys to switch between bank and pattern number selection.

If the > mark appears to the right of the pattern number, the desired pattern hasn't started playing yet. This is because the S3 waits for the previous pattern to finish playing before starting the new pattern. As soon as the old pattern has finished, the > mark disappears. The E mark is displayed for all empty (unrecorded patterns). Since these patterns cannot be played, the sequencer automatically repeats the recorded pattern.

## 2.5 Arranging Patterns into a Song

This Section illustrates the procedures used to link patterns to form a song.

### 2.5.1 Basic Procedure

1. Select the song number.

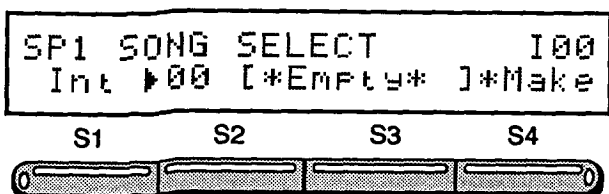

- a. Press the SONG key until the LED inside turns green.
- b. Use the [<PAGE] and [PAGE>] keys to reach the SONG SELECT (SP1) page.

- c. Select the song bank.

Use the [S1] soft key or the [<CURSOR] and [CURSOR>] keys to select the first menu item.

Use the [+ / YES] and [- / NO] keys or the [DATA ENTRY] dial to change the field value.

- d. Select the song number.

Use the [S2] soft key or the [<CURSOR] and [CURSOR>] keys to select the second menu item.

Use the [+ / YES] and [- / NO] keys or the [DATA ENTRY] dial to change the field value.

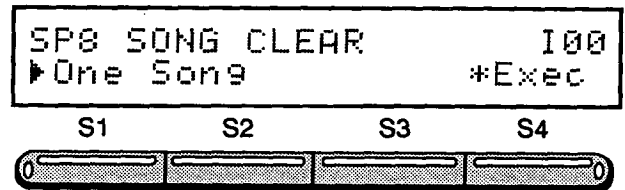

- e. If the song already contains data, use the SONG CLEAR (SP8) page to delete the data. This display offers a choice of clearing either just the current song or all songs. Use [+ / YES] and [- / NO] keys or the [DATA ENTRY] dial to specify which and then press the [S4] soft key (\*Exec) to delete the data. Answer the question Sure? (Y/N) with either the [+ / YES] key to proceed or the [- / NO] key to cancel. You may also use the [EXIT] key to cancel.

- f. If the song is currently empty, you must create (\*Make) it.

Use the [S4] soft key to execute the command.

*Note: The word \*Empty\* in the third menu field indicates that there is currently no song assigned to that number. The MAKE command changes it to [- - - - -], which indicates that the song exists, but is empty.*

# Basic Operation

g. Edit the name of the song.

Use the [S3] soft key or the [<CURSOR] and [CURSOR>] keys to select the third menu item.

Use the [<CURSOR] and [CURSOR>] keys, the [+ / YES] and [- / NO] keys and the [DATA ENTRY] dial to edit the text field.

2. Use the SONG SETTING (SP2) page and its submenus to specify the song's initial tempo, drum kit and effect assignments for each track and other starting settings. This display provides access to four submenus. To switch to a submenu display, press the corresponding soft key ([S1] – [S4]) under the label. Press the [EXIT] key to return to this page. All changes to these settings are stored with the song data.

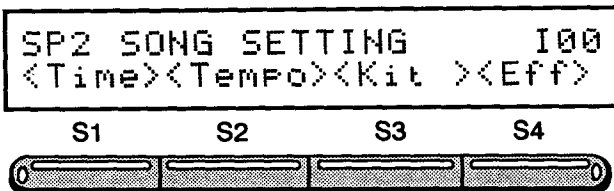

a. (Optional) Use the SONG START TIME submenu to specify the starting time for the song. This advanced feature is for synchronizing playback with an SMPTE timing signals from a tape recorder. (See Chapter 7 *SMPTE Synchronization*.)

b. Switch to the INITIAL TEMPO submenu. See 3.3.2 *SONG SETTING (SP2) Page* for instructions.

c. Press the [EXIT] key to return to the original display.

d. Switch to the INITIAL KIT submenu.

Use the [S3] soft key to display the submenu.

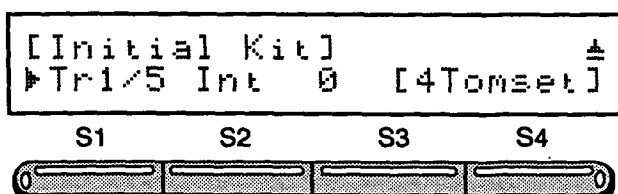

e. Select a track pair.

Use the [S1] soft key or the [<CURSOR] and [CURSOR>] keys to select the first menu item.

Use the [+ / YES] and [- / NO] keys or the [DATA ENTRY] dial to change the field value.

f. Select the drum kit bank.

Use the [S2] soft key or the [<CURSOR] and [CURSOR>] keys to select the second menu item.

Use the [+ / YES] and [- / NO] keys or the [DATA ENTRY] dial to change the field value.

g. Select the drum kit number.

Use the [S3] soft key or the [<CURSOR] and [CURSOR>] keys to select the third menu item.

Use the [+ / YES] and [- / NO] keys or the [DATA ENTRY] dial to change the field value. The drum kit's name automatically appears to the right of the number.

h. Repeat the above three steps for the other track pairs.

i. Press the [EXIT] key to return to the SP2 page.

j. Switch to the EFFECT ASSIGN submenu.

Use the [S4] soft key to display the submenu.

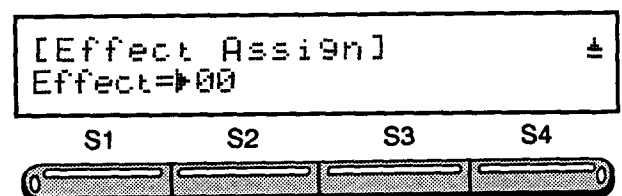

k. Select the effect program for the song.

Use the [+ / YES] and [- / NO] keys or the [DATA ENTRY] dial to change the field value.

l. Press the [EXIT] key to return to the SP2 page.

3. Use the ARRANGE (SP3) page to link patterns together to form songs. This page is the primary one for building a song from three types of structural elements: *patterns*, *drum kit changes* and *repeat commands*.

# Basic Operation

Instead of using submenus, this page provides an element selection field on the first line. Moving the cursor to this field and changing its value produces slight changes in the contents of the page. One part of the display common to all three is the three digit sequence number in the lower left corner. This field keeps track of the position in the sequence in terms of the number of elements—a kind of log of the steps that make your song. Adding a pattern, drum kit change or repeat command raises this number by one.

This page also allows the user to add such elements anywhere in the sequence—not just at the end—to overwrite already input elements and to delete them if they are no longer desired.

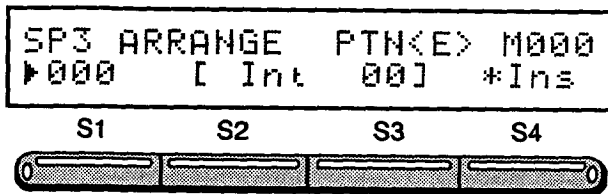

The upper line of this page provides two pieces of information: the current type of song element (PTN = pattern) and the total number of measures (bars) in the song. If the sequencer is at the end of the song, the marker appears next to this number. The lower line contains the current sequence number, two input fields and the \*Ins/\*Del/\*OvrWrt command, the command for inserting/deleting/overwriting the current type of structural element to the song.

*Note: A maximum of 251 elements or 999 measures can be used to construct a song.*

a. If the sequence number is not zero, select another song or use the SONG CLEAR (SP8) page to clear all data from the song.

b. If the current structural element which appears on the upper line above the [S3] soft key, is not PTN, use the [<CURSOR] and [CURSOR>] keys to move to that field and then rotate the [DATA ENTRY] dial to change the element type.

c. Select the pattern bank.

Use the [S2] soft key or the [<CURSOR] and [CURSOR>] keys to select the second menu item.

Use the [+ / YES] and [- / NO] keys or the [DATA ENTRY] dial to change the field value.

d. Select the pattern number.

Use the [S3] soft key or the [<CURSOR] and [CURSOR>] keys to select the third menu item.

Use the [+ / YES] and [- / NO] keys or the [DATA ENTRY] dial to change the field value.

e. Insert the pattern into the song.

Use the [S4] soft key (\*Ins) to execute the command.

After adding the pattern to the song, the sequence number automatically goes up by 1.

f. Repeat the above three steps for the other patterns in the song.

Example

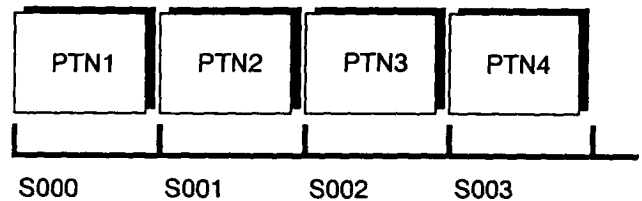

*Note: If Card is selected as the bank location while any of the following situations is present, an error will occur:*

1. No card has been inserted.
2. A card not containing pattern information has been inserted.
3. An unrecorded internal pattern has been selected.

4. Use the TRACK STATUS (SP4) page to set the MIDI output jacks and MIDI channel for each track. These settings are stored with the song data.

To route track output to an external MIDI device, set the second field to either Ext (MIDI device only) or Both (S3 and MIDI device) and then use the MIDI submenu to specify the MIDI OUT port and MIDI output channel.

5. Press the [PLAY] key to play back the song.

Playback automatically stops when the sequencer reaches the end of the last pattern.

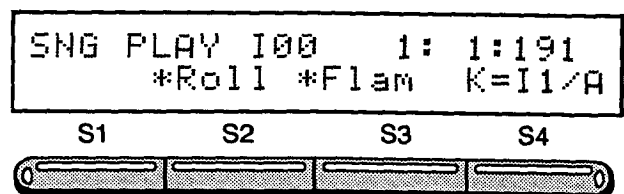

# Basic Operation

Pressing the [S4] soft key changing the format of the time (or position) display in the upper right corner of the SNG PLAY display. (See Chart.)

## SMPTE Chart

Display format	Contents
1:1:191	Bars, beats and ticks
1234	Song position pointer
Abs>00:00:00:00	Absolute SMPTE time codes
Rel1>00:00:00:00	Relative SMPTE time codes

The absolute SMPTE format measures time relative to the beginning of the song; the relative SMPTE format, relative to an arbitrary starting point.

## 2.5.2 Correcting Mistakes

The following procedure is for editing elements at a particular point in the song — the S3 calls this "overwriting." It applies not only to patterns, but to the other structural elements (drum kit changes and repeat commands) as well. The procedures for inserting and deleting structural elements appear after the description of the overwrite procedure.

Start from the ARRANGE (SP3) page:

1. Press the [SHIFT]+[S4] combination until the command field reads \*OvrWrt.

2. Select the sequence number.

Use the [S1] soft key or the [<CURSOR] and [CURSOR>] keys to select the first menu item.

Use the [+ /YES] and [- /NO] keys or the [DATA ENTRY] dial to change the field value.

3. Select the correct pattern bank and pattern number.

Use the [S2] soft key or the [<CURSOR] and [CURSOR>] keys to select the second menu item.

Use the [+ /YES] and [- /NO] keys or the [DATA ENTRY] dial to change the field value.

Use the [S3] soft key or the [<CURSOR] and [CURSOR>] keys to select the third menu item.

Use the [+ /YES] and [- /NO] keys or the [DATA ENTRY] dial to change the field value.

4. Overwrite the old pattern with the new.

Use the [S4] soft key (\*OvrWrt) to execute the command.

The sequence number automatically advances to the next structural element in the song.

## Example of an Overwrite

Before

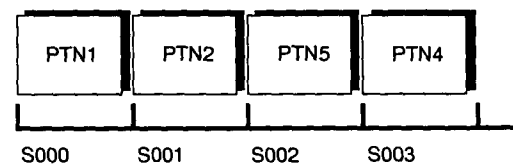

After

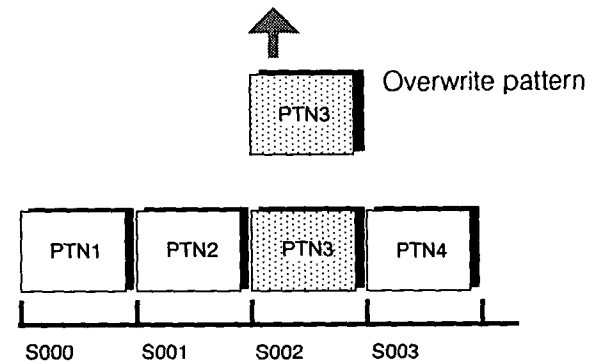

## 2.5.3 Inserting a Pattern (\*Ins)

The ARRANGE (SP3) page also provides facilities for inserting (adding) and deleting (removing) structural elements (patterns, drum kit changes and repeat commands) at any point in the song. The key step is using the [SHIFT]+[S4] combination to change the command in the lower right corner.

Start from the ARRANGE (SP3) page:

1. Press the [SHIFT]+[S4] combination until the command field reads \*Ins.

2. Select the sequence number for the new pattern.

Use the [S1] soft key or the [<CURSOR] and [CURSOR>] keys to select the first menu item.

Use the [+ /YES] and [- /NO] keys or the [DATA ENTRY] dial to change the field value.

# Basic Operation

### 3. Select the pattern bank.

Use the [S2] soft key or the [<CURSOR] and [CURSOR>] keys to select the second menu item.

Use the [S2] soft key, [+ /YES] and [- /NO] keys or the [DATA ENTRY] dial to change the field value.

### 4. Select the pattern number.

Use the [S3] soft key or the [<CURSOR] and [CURSOR>] keys to select the third menu item.

Use the [+ /YES] and [- /NO] keys or the [DATA ENTRY] dial to change the field value.

### 5. Insert the new pattern.

Use the [S4] soft key (\*Ins) to execute the command.

The sequence number automatically advances to the next structural element in the song.

BEFORE

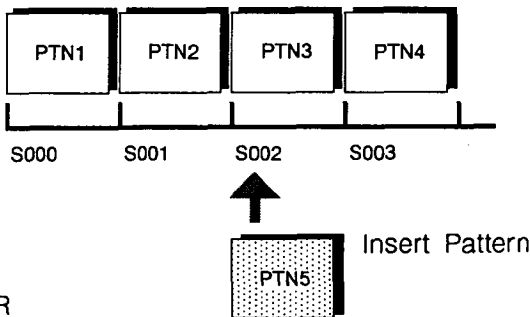

AFTER

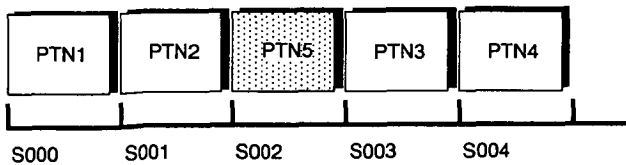

### 2.5.4 Deleting a Pattern (\*Del)

The procedure for deleting an undesired structural element (patterns, drum kit changes and repeat commands) is similar to the one for inserting a new one.

Start from the ARRANGE (SP3) page:

1. Press the [SHIFT]+[S4] combination until the command field reads \*Del.

2. Select the sequence number for the new pattern.

Use the [S1] soft key or the [<CURSOR] and [CURSOR>] keys to select the first menu item.

Use the [+ /YES] and [- /NO] keys or the [DATA ENTRY] dial to change the field value.

3. Delete the pattern.

Use the [S4] soft key (\*Del) to execute the command.

The sequence number remains unchanged, but all subsequent structural elements in the song automatically move up to close the gap.

BEFORE

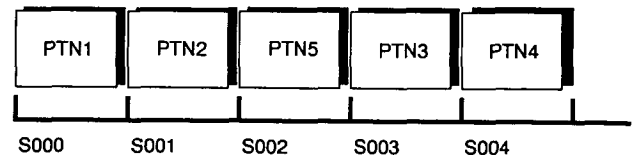

Element to delete (S002)

AFTER

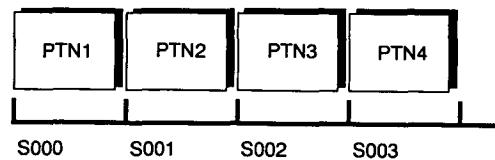



# Basic Operation

## 2.5.5 Using Repeats

The ARRANGE (SP3) page also provides facilities for repeating arbitrary sequences within the song. The procedure below shows how to do this for the following sample:

### Example of a 4 Pattern Block Repeated 4 Times

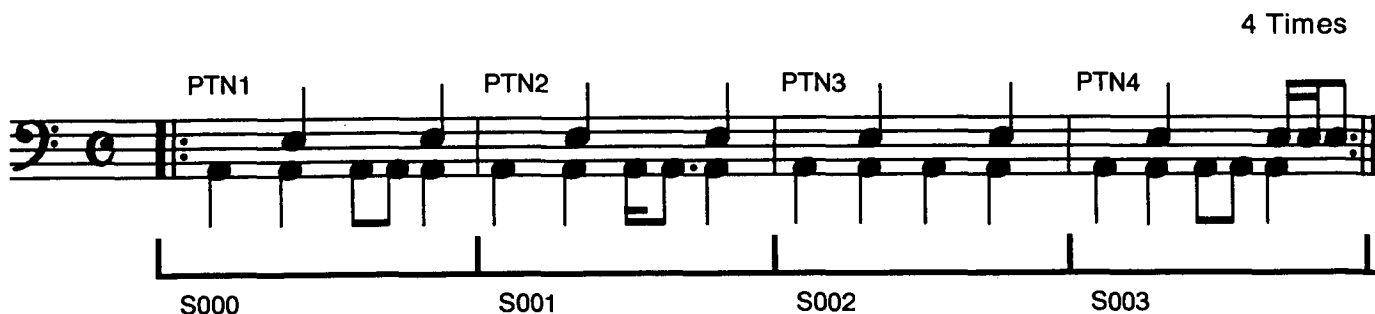

*Note: The following example adds a repeat command to the end of the song, but the insertion procedure described above is also available for inserting it in the middle of a song. The deletion procedure also applies similarly.*

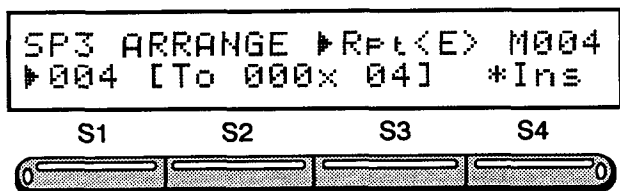

Start from the ARRANGE (SP3) page:

1. Select the sequence number of the structural element immediately following the last element to be repeated—004, for example.

Use the [S1] soft key or the [<CURSOR] and [CURSOR>] keys to select the first menu item.

Use the [+ / YES] and [- / NO] keys or the [DATA ENTRY] dial to change the field value.

2. If the current structural element type, which appears on the upper line above the [S3] soft key, is not Rpt, use the [<CURSOR] and [CURSOR>] keys to move to that field and then rotate the [DATA ENTRY] dial to change the element type.

3. Select the sequence number of the first structural element in the sequence to be repeated—000, for example.

Use the [S2] soft key or the [<CURSOR] and [CURSOR>] keys to select the second menu item.

Use the [+ / YES] and [- / NO] keys or the [DATA ENTRY] dial to change the field value.

4. Select the number of repetitions—04, for example.

Use the [S3] soft key or the [<CURSOR] and [CURSOR>] keys to select the third menu item.

Use the [+ / YES] and [- / NO] keys or the [DATA ENTRY] dial to change the field value.

5. Insert the repeat command.

Use the [S4] soft key (\*Ins) to execute the command.

The sequence number automatically advances to the next structural element in the song. The total measure field in the upper right corner automatically changes to give the new song length.

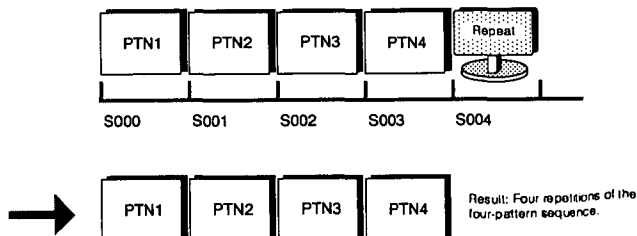

# Basic Operation

## 2.5.6 Changing Drum Kits

The ARRANGE (SP3) page also provides facilities for changing drum kit assignments for tracks in the middle of the song. Typical applications include making more efficient use of the available tracks and adding variations. The procedure below shows how to insert such a change between the fourth and fifth patterns in a song.

*Note: The deletion procedure described above is also available.*

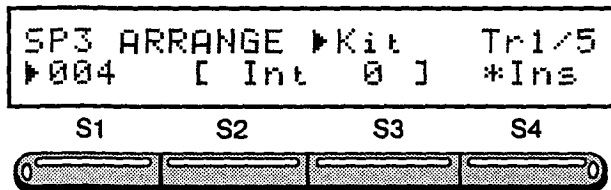

1. Press the [SHIFT]+[S4] combination until the command field reads \*Ins.

If you leave this field set to \*OvrWrt, the S3 rewrites over the structural element at the current sequencer position with the new drum kit change.

2. Select the sequence number of the first structural element to follow the drum kit change—004, for example.

Use the [S1] soft key or the [<CURSOR] and [CURSOR>] keys to select the first menu item.

Use the [+ /YES] and [- /NO] keys or the [DATA ENTRY] dial to change the field value.

3. If the current structural element type, which appears on the upper line above the [S3] soft key, is not Kit, use the [<CURSOR] and [CURSOR>] keys to move to that field and then rotate the [DATA ENTRY] dial to change the element type.

4. Select the track number—Tr01 for example.

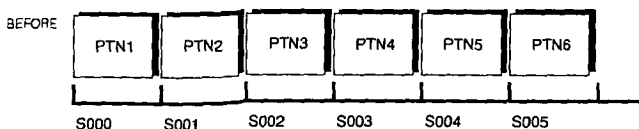

Insert drum kit change at sequence number 004—that is, before pattern 5.

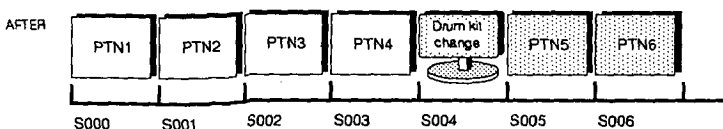

From pattern 5 onward, track 1 uses a different drum kit.

Use the [<CURSOR] and [CURSOR>] keys to move to the track field in the upper right corner and then rotate the [DATA ENTRY] dial.

*Note: The current drum kit assignment automatically appears in the middle of the lower line.*

5. Select the drum kit bank—Int, for example.

Use the [S2] soft key or the [<CURSOR] and [CURSOR>] keys to select the second menu item.

Use the [+ /YES] and [- /NO] keys or the [DATA ENTRY] dial to change the field value.

6. Select the drum kit number—1, for example.

Use the [S3] soft key or the [<CURSOR] and [CURSOR>] keys to select the third menu item.

Use the [+ /YES] and [- /NO] keys or the [DATA ENTRY] dial to change the field value.

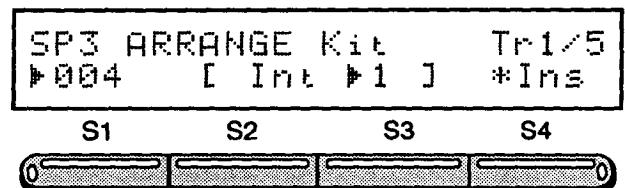

7. Insert the drum kit change.

Use the [S4] soft key (\*Ins) to execute the command.

The sequence number automatically advances to the next structural element in the song.

8. Repeat the above procedure, as necessary, for the other tracks.

*Note: Since a drum kit change applies to only a single track pair, each track pair requires a separate change.*

# Basic Operation

## 2.6 Real-Time Song Recording

A song can mix two types of data: patterns linked together and data recorded in real-time.

### General Procedure for Recording a Song in Real-Time

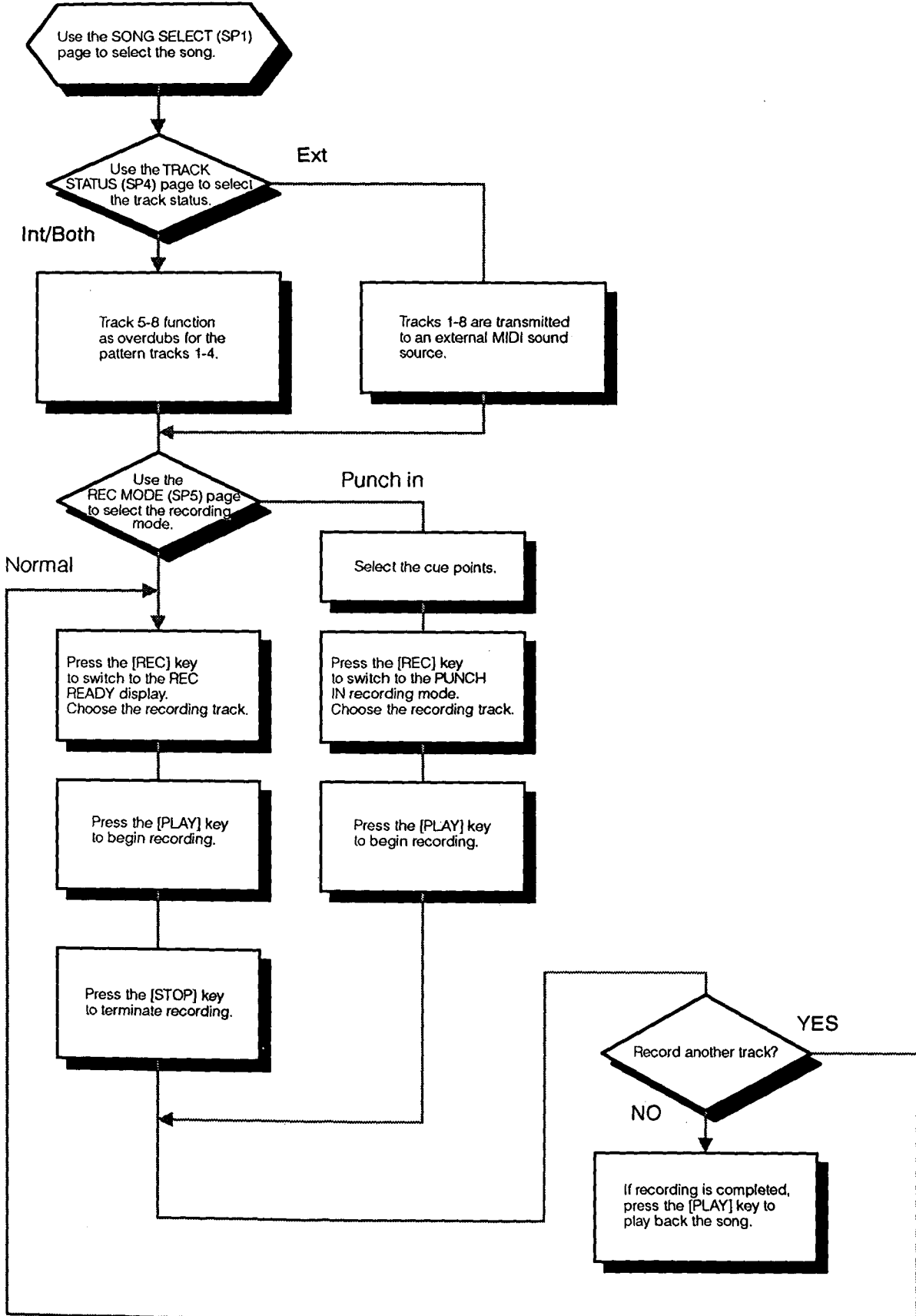

# Basic Operation

## 2.6.1 Overdubbing a Song

This section describes the procedure for adding real-time data to a song constructed in the ARRANGE (SP3) and SONG SETTING (SP2) pages. It assumes that the song has already been selected in the SONG SELECT (SP1) page.

1. Use the [<PAGE] and [PAGE>] keys to reach the TRACK STATUS (SP4) page.

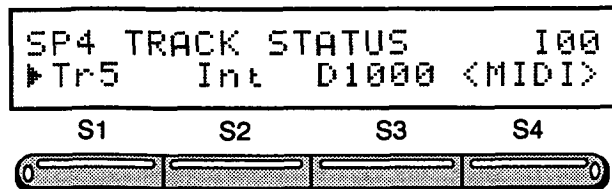

2. Select the song track.

Use the [S1] soft key or the [<CURSOR] and [CURSOR>] keys to select the first menu item.

Use the [+ / YES] and [- / NO] keys or the [DATA ENTRY] dial to change the field value.

3. Select the output destination for the track.

Use the [S2] soft key or the [<CURSOR] and [CURSOR>] keys to select the second menu item.

Use the [+ / YES] and [- / NO] keys or the [DATA ENTRY] dial to change the field value.

*Note: This example uses Int so that the song tracks overdub their pattern track counterparts—that is, Track 5 uses the same drum kit as Track 1, etc. (Both share this effect.)*

4. Repeat the above two steps for the other three song tracks.

5. (Optional) Switch to MIDI submenu and assign MIDI output channels to the song tracks.

Use the [S4] soft key to display the submenu.

*Note: The MIDI output channel settings apply only for the Ext and Both settings. For further details, see 3.3.4 TRACK STATUS (SP4) Page.*

6. Use the REC MODE (SP5) page to set the recording mode to Normal.

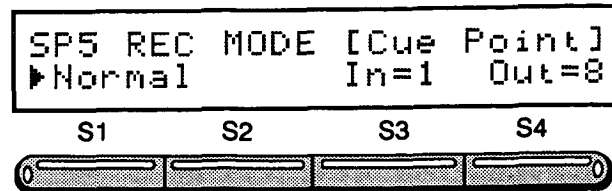

*Note: The other setting, Punch In, is for recording subsections of the song. For further details, see 2.6.2 PUNCH IN Recording below.*

7. (Optional) Press the [PLAY] key to play back the current song contents and rehearse on the touchpads.

8. (Optional) Use the METRONOME (S4) and REC LEAD IN (SP6) pages to set up the metronome and add a lead in.

9. Press the [REC] key to switch to the REC READY display.

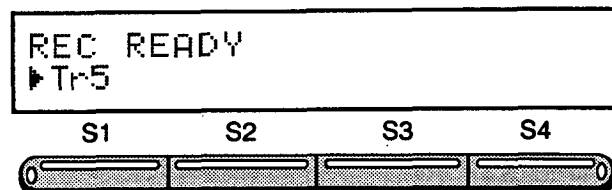

10. Select the track.

Use the [+ / YES] and [- / NO] keys or the [DATA ENTRY] dial to change the field value.

11. Press the [PLAY] key to switch to the SNG REC display.

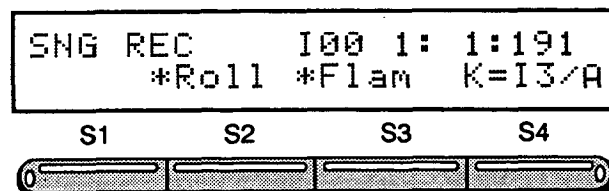

12. Start recording after the lead in.

*Note: Holding down the [S2] or [S3] soft keys converts subsequent touchpad notes into drum rolls and flams, respectively.*

13. Press the [STOP] key to terminate recording.

The sequencer automatically stops at the end of the pattern data sequence.

# Basic Operation

14. Repeat the above procedure for the other tracks.

15. Press the [PLAY] key to play back the song.

*Note: The sequencer automatically stops at the end of all data.*

16. Edit the real-time recording with the SONG EDIT mode. (See 3.4 SONG EDIT Mode.)

*Note: The S3's sequencer has a maximum capacity of 32 simultaneously played notes for all tracks combined (excepting muted tracks). When recording, if more than 32 polyphonic notes are played, a warning message is displayed. The same warning occurs if a song which has more than 32 polyphonic notes is played.*

## 2.6.2 PUNCH IN Recording

Punch in recording is a special mode for recording only a subsection of a song between two cue points. It is especially useful for adding accents and making spot modifications to songs. Cue points are markers inserted in the song as reference points for the LOCATE function. (See 1.2.4 Transport Keys.) Cue points 1 and 8 always refer to the beginning and end of the song. There can be up to six cue points in between (points 2-7). The PUNCH IN function, however, uses only two, the PUNCH IN and PUNCH OUT points.

*Note: Make sure that the punch in point precedes the punch out point or else an error will occur.*

1. Use the REC MODE (SP5) page to switch the recording mode from Normal to Punch in.

Use the [S1] soft key or the [<CURSOR] and [CURSOR>] keys to select the first menu item.

Use the [+ / YES] and [- / NO] keys or the [DATA ENTRY] dial to change the field value.

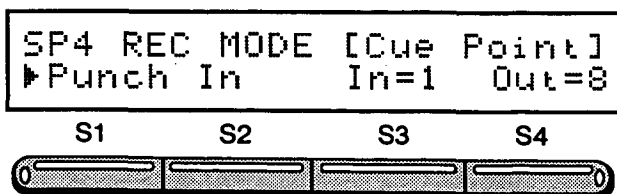

2. Set two cue points for use as the PUNCH IN and PUNCH OUT points.

- a. (Optional) Reduce the tempo to increase accuracy.
- b. Use the [FF] and [REW] KEYS to shift the song position counter a little before the desired position.

- c. Press the [PLAY] key to start playback.

- d. Hold down the [SHIFT] key and press the [LOCATE] key to activate the cue point registration function.

- e. At the desired point in the song, press a touchpad between 2 and 7 to register the cue point—cue point 2 at the fourth beat of the fifth bar, for example.

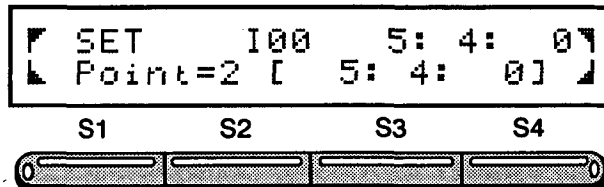

- f. Repeat the above procedure for the PUNCH OUT point—cue point 3 at the first beat of the eighth bar, for example.

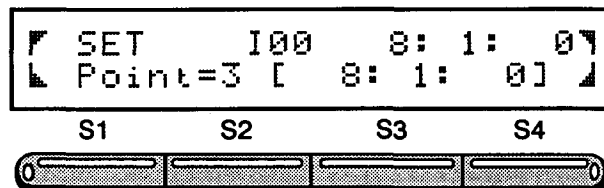

(At this point, it might be a good idea to define a third cue point a little before the PUNCH IN point for use in cueing the sequencer before and after the recording. Cue point 4 at the first beat of the fourth bar, for example.) Return to the REC MODE (SP5) page.

3. Select the PUNCH IN point.

Change the punch in point to 2

Use the [S3] soft key or the [<CURSOR] and [CURSOR>] keys to select the third menu item.

Use the [+ / YES] and [- / NO] keys or the [DATA ENTRY] dial to change the field value.

4. Select the PUNCH OUT point.

Change the punch out point to 3

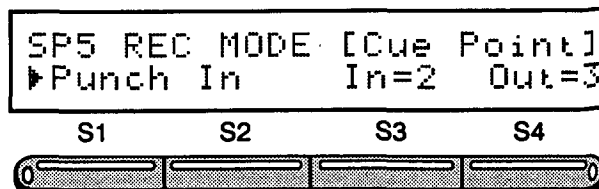

# Basic Operation

Use the [S4] soft key or the [<CURSOR] and [CURSOR>] keys to select the fourth menu item.

Use the [+ / YES] and [- / NO] keys or the [DATA ENTRY] dial to change the field value.

5. Press the [REC] key to switch to the REC READY display.

6. Choose the track number.

7. (Optional) Press the [LOCATE] key and a touchpad to position the sequencer at the last cue point before the PUNCH IN point, cue point 4, for example.

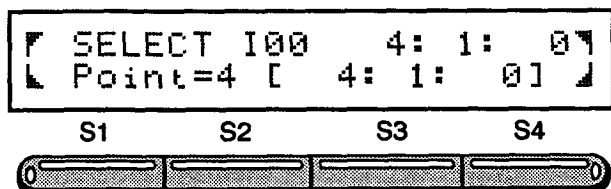

Alternately, you can press [STOP] to stop the sequencer, press [PAUSE] to place the sequencer on standby and then use the [FF] and [RR] keys to choose a starting point. After selecting the point, place the sequencer back in the REC READY mode by pushing the [REC] key.

*Note: Skipping this step causes the sequencer to start playback at the beginning of the song, not at the cue point.*

8. Press the [PLAY] key to start playback at the current position.

9. Start recording when the song counter hits the PUNCH IN point and the LED turns orange.

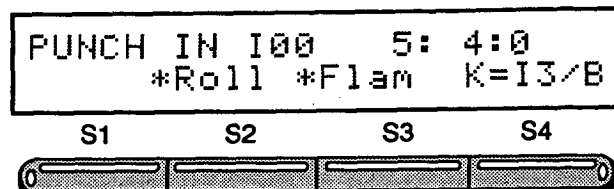

10. (Optional) Press the [STOP] key to terminate recording before the PUNCH OUT point. The sequencer automatically stops recording at the PUNCH OUT point.

11. Press the [LOCATE] key and the appropriate touchpad to position the sequencer at the last cue point before the PUNCH IN point. Alternatively, use the touchpad for the PUNCH IN point and then use the [REW] key to shift the position backward.

12. To listen to the newly punched in changes, press the [PLAY] key to play back the song from the current position.

*Note: The S3's sequencer has a maximum capacity of 32 simultaneously played notes for all tracks combined (excepting muted tracks). When recording, if more than 32 polyphonic notes are played, a warning message is displayed. The same warning occurs if a song which has more than 32 polyphonic notes is played.*

# Chapter 3 PATTERN and SONG Modes

This Chapter provides detailed descriptions of the displays for four PATTERN and SONG modes:

- PATTERN PLAY/REC
- PATTERN EDIT
- SONG PLAY/REC
- SONG EDIT

This Chapter assumes familiarity with the basic procedures of Chapter 2 *Basic Operations* and discusses the displays in the order in which they appear on the screen.

*Note: The abbreviation in parentheses after the function name is the page number that appears in the upper left corner when the corresponding display is on the LCD screen.*

## 3.1 PATTERN PLAY/REC Mode

This mode is for recording and playing back patterns.

### 3.1.1 PATTERN SELECT (PP1) Page

This display is for selecting a pattern to be recorded, played back or edited within the PATTERN PLAY/REC mode.

*Note: This selection remains valid through all pages in the PATTERN PLAY/REC and PATTERN EDIT modes.*

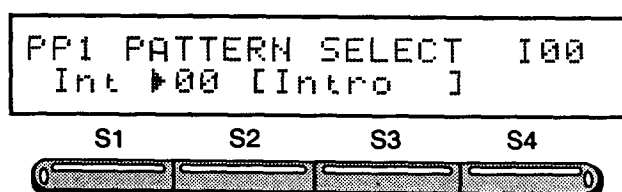

Menu Key	Field	Field Type & Possible Settings	Description
S1	Bank	Int /Card	Location of the pattern: Int for internal memory or Card for a RAM card.
S2	Pattern number	00 -99	Number of the pattern to be recorded or played back.
S3	Pattern name	[ ]	Name associated with the pattern. This changes automatically with the number, but may also be edited.

The first two fields determine the three-character designation for the pattern. This designation, which appears in the upper right corner of every display in the PATTERN PLAY/REC and PATTERN EDIT modes, consists of a single letter (I or C) for the bank plus a two-digit number (00 ~ 99).

*Note: If the RANGE function (PP4 or PE2) is in effect, the symbol  $\blacktriangleright$  appears to the right of this abbreviation.*

The third field is for the pattern's name.

*Note: This name appears only on the PATTERN SELECT pages in the PATTERN PLAY/REC and PATTERN EDIT modes.*

Procedure:

1. Select the bank.

Use the [S1] soft key or the [<CURSOR] and [CURSOR>] keys to select the first menu item.

Use the [+YES] and [-/NO] keys or the [DATA ENTRY] dial to change the bank.

*Note: A pattern on a RAM card may be played and edited, but not recorded.*

2. Select the pattern number.

Use the [S2] soft key or the [<CURSOR] and [CURSOR>] keys to select the second menu item.

Use the [+YES] and [-/NO] keys or the [DATA ENTRY] dial to change the pattern number.

*Note: The third menu field, the pattern name, automatically changes with the pattern number.*

*Note: There are two special pattern name designations: \*Empty\* denotes an unused pattern; ----- denotes a defined pattern without a name.*

3. Edit the name. (This step is optional, however it is a good idea to label your patterns to facilitate identification.)

Use the [S3] soft key or the [<CURSOR] and [CURSOR>] keys to select the third menu item.

Use the [<CURSOR] and [CURSOR>] keys, the [+YES] and [-/NO] keys and the [DATA ENTRY] dial to edit the text field.

# PATTERN and SONG Modes

Use the cursor keys to move the underline cursor.

Use the [+ / YES] and [- / NO] keys and the [DATA ENTRY] dial to change the character above the underline cursor.

*Note: Holding down the [SHIFT] key while using the above keys produces an alternate set of characters: lower case letters and additional symbols.*

## Character List

Without [SHIFT]	..	:-*~ABCDEFGHIJKLMN O PQRSTU VWX YZ 0123456789
With [SHIFT]	.....	<=>abcdefghijklmnopqrstuvwxyz !@#%&+?/`#

### 3.1.2 MONITOR (PP2) Page

This page controls the use of drum kits, effects and MIDI ports for each pattern track.

*Note: These settings are not stored with the pattern. They remain in effect only in the PATTERN PLAY/REC and PATTERN EDIT modes and are overridden in the SONG PLAY/REC and SONG EDIT modes by the settings in the SONG SETTING (SP2) and TRACK STATUS (SP4) pages.*

```

PP2 MONITOR           I00
▶Tr1 Both<K/Eff><MIDI>
    
```



Menu Key	Field	Field Type & Possible Settings	Description
S1	Track number	Tr1 -4	Number of the current pattern track.
S2	Track output status	Mute / Int / Ext / Both	Track output status—i.e., whether data is transmitted to a drum kit, a MIDI output channel, both or neither: Mute: No data transmitted to drum kit or MIDI interface. Int: Track play data transmitted to drum kit. (This is the normal mode.) Ext: Track play data transmitted to the MIDI interface. In this mode the S3 functions as a sequencer for an external MIDI sound source. Both: Data transmitted to both drum kit and MIDI interface.
S3	KIT/EFFECT submenu	<K/Eff>	Submenu for assigning drum kits to individual pattern tracks and one effect program for all four tracks.
S4	MIDI submenu	<MIDI>	Submenu for assigning MIDI output channels to individual pattern tracks.



# PATTERN and SONG Modes

## KIT/EFFECT (K/Eff) Submenu

Pressing the [S3] soft key switches from the MONITOR (PP2) page to the KIT/EFFECT submenu.

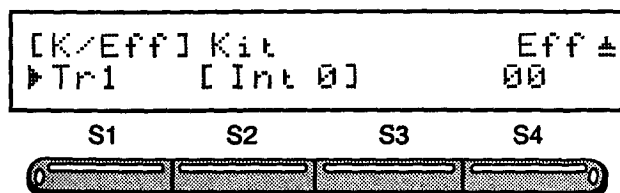

Menu Key	Field	Field Type & Possible Settings	Description
S1	Track number	Tr1 -4	Current track number.
S2	Bank	Pre / Int / Card	Location of the kit: Pre (pre-programmed drum kits), Int (internal bank) or Card (ROM or RAM card).
S3	Kit number	0-9	Number of the kit.
S4	Effect	00-15	Number of the effect.

The first field on this page gives the current track. The remaining three fields determine the drum kit and effect for that track.

*Note: The effect setting is not stored with the pattern. It applies only to the PATTERN PLAY/REC and PATTERN EDIT modes.*

Procedure:

1. Use the standard menu procedures to choose the KIT and EFFECT.
2. Press the [EXIT] key to return to the PP2 page.

## MIDI Submenu

Pressing the [S3] soft key switches from the MONITOR (PP2) page to the MIDI submenu.

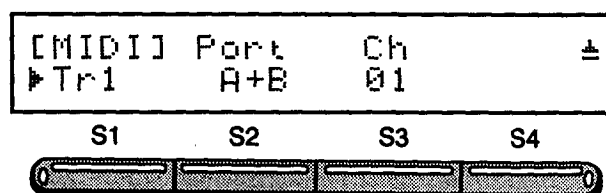

Menu Key	Field	Field Type & Possible Settings	Description
S1	Track number	Tr1 -4	Current track number.
S2	MIDI port(s)	0ff / A / B / A+B	Connections to MIDI ports A and B: A, B, A+B (both) or 0ff (neither).
S3	MIDI channel	01 -16	MIDI transmission channel for the track.

The first field in this page gives the current track. The remaining two fields determine the MIDI output port connections and the MIDI output channel for that track.

*Note: The track status setting, the second field on the MONITOR (PP2) menu, takes precedence and must be Ext or Both to produce actual output.*

Procedure:

1. Use the standard menu procedures to choose MIDI connections and channels.
2. Press the [EXIT] key to return to the PP2 page.

# PATTERN and SONG Modes

## 3.1.3 REC LEAD IN (PP3) Page

This display is for providing 1-8 bars of metronome ticks in advance of the start of actual recording.

*Note: The time signature for these bars is the same as that for the first bar of the pattern.*

*Note: This setting is not stored with the pattern. It remains in effect only in the PATTERN PLAY/REC mode.*

```

PP3 REC LEAD IN      I00
▶Off Length=1
    
```



Menu Key	Field	Field Type & Possible Settings	Description
S1	ON/OFF switch	On / Off	Current state (ON/OFF) of the REC LEAD IN function.
S2 S3	Length	Length= 1-8	Length, in bars, of the lead in.

Procedure:

The procedure is essentially the same as for the RANGE (PP4) page below.

1. Switch the REC LEAD IN function ON or OFF.
2. Select the length.

## 3.1.4 RANGE (PP4) Page

This display controls the RANGE function, which, when activated (ON), limits recording, playback and editing to a specific set of bars within the pattern instead of the entire pattern.

*Note: When the RANGE function (PP2 or PE2) is in effect, the symbol **■** appears to the right of the three-character pattern number designation in the upper right corner of every display in the PATTERN PLAY/REC and PATTERN EDIT modes. (See the description for the PATTERN SELECT (PP1) display above.)*

*Note: These settings are not stored with the pattern data. Changing patterns automatically deactivates the RANGE function.*

*Note: This page cannot be accessed with an unused pattern.*

```

PP4 RANGE      I00■
▶On Bar=01 Length=01
    
```



Menu Key	Field	Field Type & Possible Settings	Description
S1	ON/OFF switch	On / Off	Current state (ON/OFF) of the RANGE function.
S2	Starting bar	Bar=01 -99	Bar number for the first bar in the range.
S3 S4	Length	Length=01 -99	Length, in bars, of the range.

Procedure:

1. Switch the RANGE function ON or OFF.

Use the [S1] soft key or the [<CURSOR] and [CURSOR>] keys to select the first menu item.

Use the [+ / YES] and [- / NO] keys or the [DATA ENTRY] dial to switch between ON and OFF.

2. Select the starting bar.

Use the [S2] soft key or the [<CURSOR] and [CURSOR>] keys to select the second menu item.

Use the [+ / YES] and [- / NO] keys or the [DATA ENTRY] dial to change the starting bar.

3. Select the length.

Use the [S3] soft key or the [<CURSOR] and [CURSOR>] keys to select the third menu item.

Use the [+ / YES] and [- / NO] keys or the [DATA ENTRY] dial to change the length.

# PATTERN and SONG Modes

## 3.1.5 PATTERN ERASE (PP5) Page

This page is for erasing a specific type of data—notes or program changes, for example—from a particular track for the current pattern or range.

*Note: This page is identical to the PATTERN EDIT PATTERN ERASE (PE12) page described in 3.2.12.*

*Note: This page cannot be accessed with an unused pattern.*

## 3.1.6 PATTERN CLEAR (PP6) Page

This page is for clearing either the current pattern or all recorded patterns from the memory in preparation for recording a completely new song.

*Note: This page is identical to the PATTERN EDIT mode's PATTERN CLEAR (PE13) page described in 3.2.13*

*Note: This page cannot be accessed with an unused pattern.*

## 3.2 PATTERN EDIT Mode

This mode is for editing patterns. Pages after PE1 cannot be accessed if the currently selected pattern is unused.

### 3.2.1 PATTERN SELECT (PE1) Page

This page is for selecting a pattern to be played back or edited with the PATTERN EDIT modes.

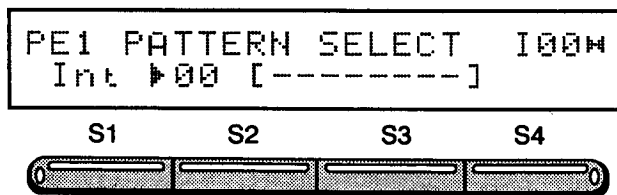

Menu Key	Field	Field Type & Possible Settings	Description
S1	Bank	Int / Card	Location of the pattern: Int for internal memory or Card for a RAM card.
S2	Pattern number	00 -99	Number of the pattern to be edited or played back.
S3	Pattern name	[ ]	Name associated with the pattern. This changes automatically with the number, but may also be edited.

Procedure:

See the description for the PATTERN PLAY/REC mode's PATTERN SELECT (PP1) page in 3.1.1.

### 3.2.2 RANGE (PE2) Page

This page controls the RANGE function, which, when activated, limits playback and editing to a specific set of bars within the pattern instead of the entire pattern.

*Note: This page is identical to the PATTERN PLAY/REC RANGE (PP4) page described in 3.1.4.*

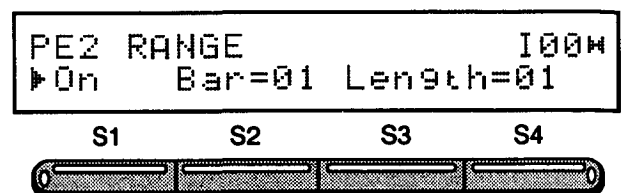

Menu Key	Field	Field Type & Possible Settings	Description
S1	ON/OFF switch	On / Off	Current state (ON/OFF) of the RANGE function.
S2	Starting bar	Bar=01 -99	Bar number for the first bar in the range.
S3 S4	Length	Length=01 -99	Length, in bars, of the range.

Procedure:

This procedure is identical to the procedure in 3.1.4 RANGE.

### 3.2.3 TRANSPOSE (PE3) Page

This page is for shifting all pitches on a particular track, all tracks or a particular range of tracks up or down by a fixed number of semitones up to two octaves (24 semitones) on either side (+/-).

*Note: The transpose function permanently alters data, so it is a good idea to use the PE9 PATTERN COPY page described in 3.2.9 to make a back-up in case of error.*

*Note: Drum and percussion instrument data assigned to drum kits is also altered with the transpose function. Because the sounds are nonchromatic, they are altered in an irregular fashion. For more precise control of the percussive sounds, use the pad submode's PAD EDIT (P3) page's TUNE submenu and the kit mode's NOTE ASSIGN (K5) page. See Chapter 4 Instrument Modes.*

# PATTERN and SONG Modes

```
PE3 TRANSPOSE      I00
▶Tr1      0      *Exec
```



Menu Key	Field	Field Type & Possible Settings	Description
S1	Track number	Tr1 -4/T1-4	The track to edit. <i>(Note: The setting T1-4 selects all four pattern tracks.)</i>
S2	Transposition value	-24 +24	Size, in semitones and direction (+/-) of the transposition. <i>(Note: The limit is 24 semitones or two octaves in either direction.)</i>
S4	EXECUTE command	*Exec	Command to make the change.

Answer the question Sure? (Y/N) with either the [+YES] key to proceed or the [-/NO] key to cancel. You may also use the [EXIT] key to cancel.

## 3.2.4 VELOCITY EDIT (PE4) Page

This page provides access to three submenus for adjusting all key velocities on a particular track, all tracks or a particular range of tracks.

*Note: If the result of an adjustment falls outside the range 2~ 126, it is automatically replaced with the nearest endpoint—that is, 2 or 126, respectively.*

```
PE4 VELOCITY EDIT      I00
<Shft><Cmp ><Exp >
```



Menu Key	Field	Field Type & Possible Settings	Description
S1	SHIFT submenu	<Shft>	Submenu for shifting the velocities up or down by a fixed amount
S2	COMPRESSION submenu	<Cmp >	Submenu for rescaling the velocities to reduce their difference from a reference point called the threshold.
S3	EXPANSION submenu	<Exp >	Submenu for rescaling the velocities to magnify their difference from the threshold.

Procedure:

1. (Optional) Use the RANGE (PE2) page to set the range.

2. Select the track or tracks.

Use the [S1] soft key or the [<CURSOR] and [CURSOR>] keys to select the first menu item.

Use the [+YES] and [-/NO] keys or the [DATA ENTRY] dial to change the track selection.

*Note: There are five choices: one each for the individual tracks and T1-4 for all four.*

3. Select the transposition value.

Use the [S2] soft key or the [<CURSOR] and [CURSOR>] keys to select the second menu item.

Use the [+YES] and [-/NO] keys or the [DATA ENTRY] dial to change the transposition in semitones.

4. Transpose.

Use the [S4] soft key (\*Exec) to transpose.

Procedure:

1. (Optional). Use the RANGE (PE2) page to set the range.

2. Press the corresponding menu key to select the desired submenu.

# PATTERN and SONG Modes

## SHIFT (Shft) Submenu

This page is for shifting the velocities up or down by a fixed amount, called the bias. For example, a bias of +6 shifts all velocities up six units and a setting of -6 shifts them down six units.

*Note: The velocity shift function permanently alters data, so it is a good idea to use the PE9 PATTERN COPY page described in 3.2.9 to make a back-up in case of error.*

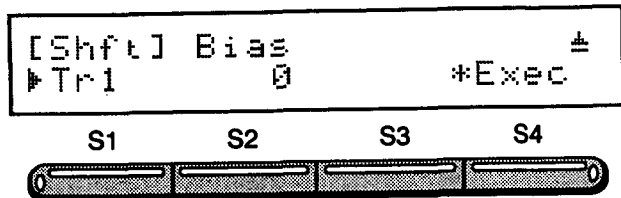

Menu Key	Field	Field Type & Possible Settings	Description
S1	Track number	Tr1 -4/T1-4	The track to edit. <i>(Note: The setting T1-4 selects all four pattern tracks.)</i>
S2	Bias	-126 -+126	Size and direction (+/-) of the velocity shift.
S4	EXECUTE command	*Exec	Command to make the change.

Procedure:

1. Select the track or tracks.

Use the [S1] soft key or the [<CURSOR] and [CURSOR>] keys to select the first menu item.

Use the [+ / YES] and [- / NO] keys or the [DATA ENTRY] dial to change the track selection.

*Note: There are five choices: one each for the individual tracks and T1-4 for all four.*

2. Select the bias.

Use the [S2] soft key or the [<CURSOR] and [CURSOR>] keys to select the second menu item.

Use the [+ / YES] and [- / NO] keys or the [DATA ENTRY] dial to change the bias.

3. Change the velocities.

Use the [S4] soft key (\*Exec) to shift the velocities.

Answer the question Sure? (Y/N) with either the [+ / YES] key to proceed or the [- / NO] key to cancel. You may also use the [EXIT] key to cancel.

4. Press the [EXIT] key to return to the PE4 page.

# PATTERN and SONG Modes

## Example of a Velocity Shift

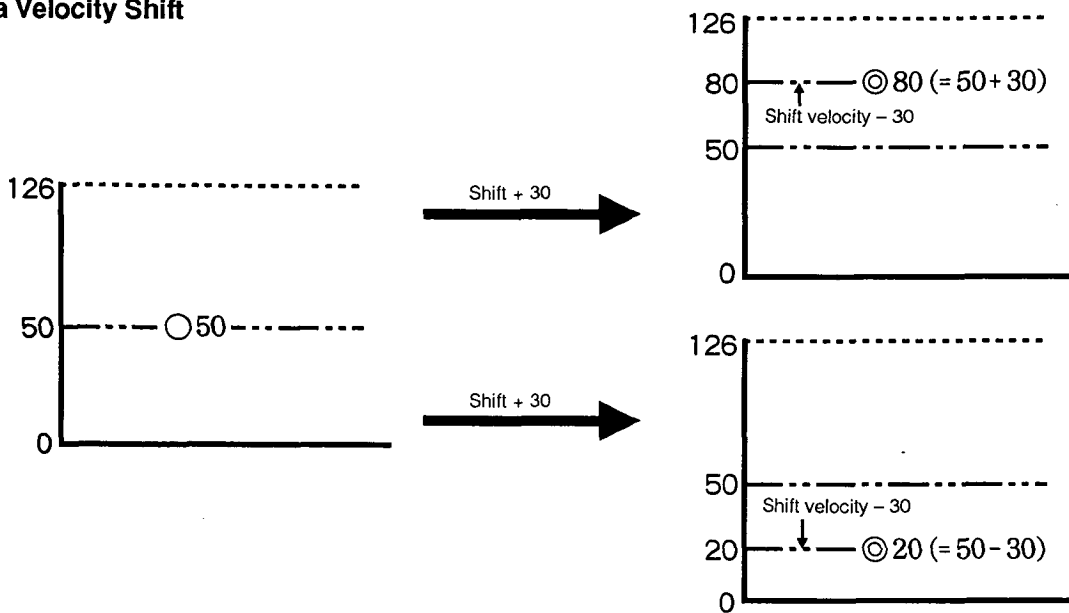

## COMPRESSION (Cmp) Submenu

This page is for rescaling the velocities to compress their dynamic range—that is, limit the contrast between loud and soft—by reducing their differences from a reference point called the threshold.

*Note: The velocity compression function permanently alters data, so it is a good idea to use the PE9 PATTERN COPY page described in 3.2.9.*

```
[Cmp] Thrsh Amount
▶ Tr1 64 50% *Exec
```



Menu Key	Field	Field Type & Possible Settings	Description
S1	Track number	Tr1 -4 / T1-4	The track to edit. (Note: The setting T1-4 selects all four pattern tracks.)
S2	Threshold	2-126	Reference point for calculating relative velocity.
S3	Amount	1-100%	Scaling factor for the velocity shift. The larger this percentage, the greater the amount of rescaling—that is, the closer the velocities move toward the threshold.
S4	EXECUTE command	*Exec	Command to make the change.

## Procedure:

1. Select the track or tracks.

Use the [S1] soft key or the [<CURSOR] and [CURSOR>] keys to select the first menu item.

Use the [+ / YES] and [- / NO] keys or the [DATA ENTRY] dial to change the track selection.

*Note: There are five choices: one each for the individual tracks and T1-4 for all four.*

2. Select the threshold.

Use the [S2] soft key or the [<CURSOR] and [CURSOR>] keys to select the second menu item.

Use the [+ / YES] and [- / NO] keys or the [DATA ENTRY] dial to change the threshold.

3. Select the scaling factor.

Use the [S3] soft key or the [<CURSOR] and [CURSOR>] keys to select the third menu item.

Use the [+ / YES] and [- / NO] keys or the [DATA ENTRY] dial to change the compression percentage.

# PATTERN and SONG Modes

4. Change the velocities.

Use the [S4] soft key (\*Exec) to execute the command.

Answer the question Sure? (Y/N) with either the [+ / YES] key to proceed or the [- / NO] key to cancel. You may also use the [EXIT] key to cancel.

5. Press the [EXIT] key to return to the PE4 page.

## Example of a Velocity Compression

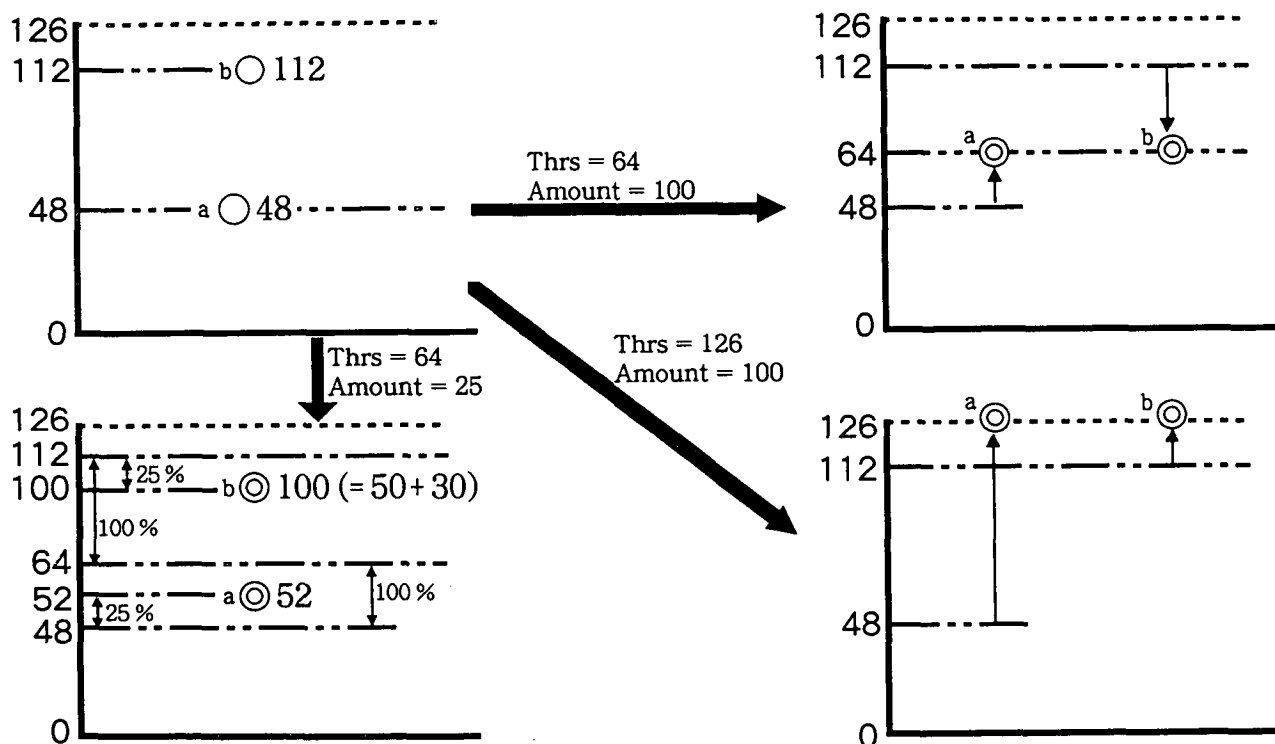

# PATTERN and SONG Modes

## 64 EXPANSION (Exp) Submenu

This page is for rescaling the velocities to expand their dynamic range—that is, enhance the contrast between loud and soft—by magnifying their differences from a reference point called the threshold.

*Note: The velocity expansion function permanently alters data, so it is a good idea to use the PE9 PATTERN COPY page described in 3.2.9.*

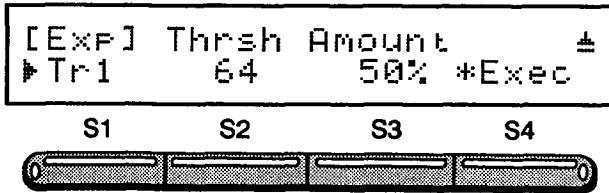

Menu Key	Field	Field Type & Possible Settings	Description
S1	Track number	Tr1 -4 / T1-4	The track to edit. (Note: The setting T1-4 selects all four pattern tracks.)
S2	Threshold	2-126	Reference point for calculating relative velocity.
S3	Amount	1-100%	Scaling factor for the velocity shift. The larger this percentage, the greater the amount of rescaling—that is, the farther the velocities move away from the threshold.
S4	EXECUTE command	*Exec	Command to make the change.

Procedure:

This procedure is identical to the procedure for the COMPRESSION Submenu above.

## Example of a Velocity Expansion

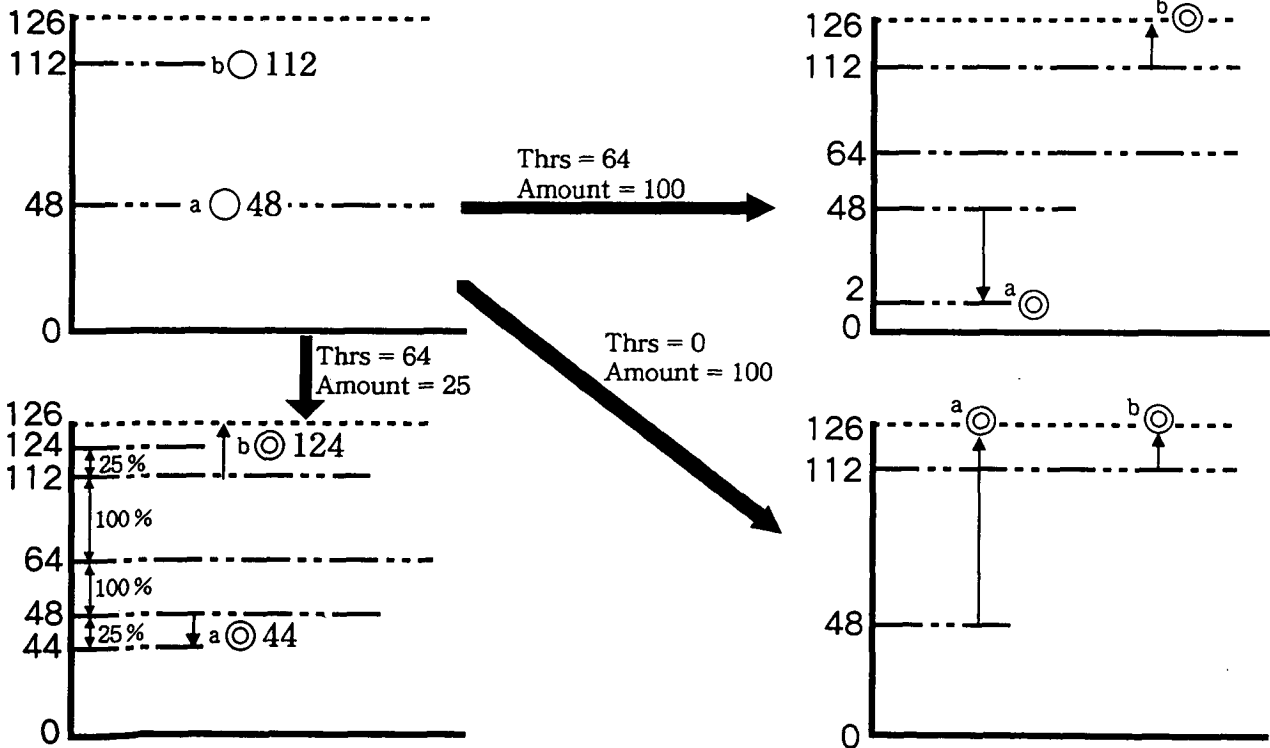



# PATTERN and SONG Modes

## 3.2.5 QUANTIZE (PE5) Page

The PE5 page is for shifting data to align it closer to a particular timing scale—sixteenth notes, for example. This alignment, called quantization, is useful for correcting small timing errors. A submenu offers the choice of 100% quantization, which yields absolute correction or only partial quantization, which preserves a certain amount of the original fluctuation—for a more natural-sounding, “human” result.

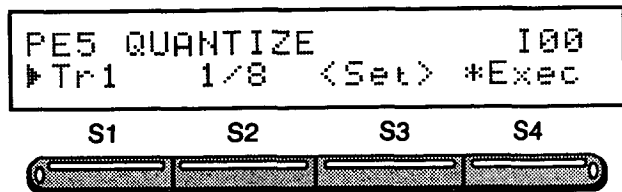

Menu Key	Field	Field Type & Possible Settings	Description
S1	Track number	Tr1 -4/T1-4	The track to edit. (Note: The setting T1-4 selects all four pattern tracks.)
S2	Resolution	1/4 -1/32T	Timing interval for aligning the data. The letter “T” after a selection denotes triplets. The selections range from quarter notes to 32nd note triplets.
S3	SET submenu	<Set>	Submenu for setting additional parameters.
S4	EXECUTE command	*Exec	Command to make the change.

### SET Submenu

This page controls the operation of the QUANTIZE function.

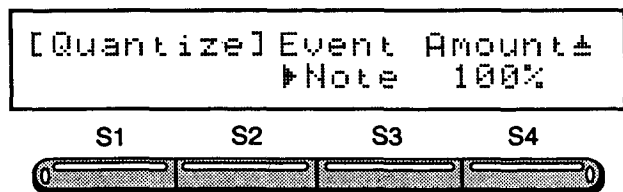

Menu Key	Field	Field Type & Possible Settings	Description
S3	Event	Note /All	Type of data to be edited: all MIDI events (All ) or just the notes (Note ).
S4	Amount	25 -100%	Scaling factor for the QUANTIZE function. The smaller this percentage, the greater the amount of natural-sounding fluctuation that remains. One application is to use weak quantization with a triplet resolution to create a swing effect.

*Note: Before starting, make a backup copy of the pattern with the PATTERN COPY (PE9) page. The quantization changes are irreversible, so it is always a good idea to have a spare copy “just in case”—especially for partial quantization, where achieving the right balance between correction and naturalness can take several tries.*

Procedure:

1. Use the PATTERN SELECT (PE1) page to select the pattern.
2. Use the [PAGE>] key to select the QUANTIZE (PE5) page.
3. Select the track or tracks.

Use the [S1] soft key or the [<CURSOR] and [CURSOR>] keys to select the first menu item.

Use the [+ /YES] and [- /NO] keys or the [DATA ENTRY] dial to change the track selection.

There are five choices: one each for the individual tracks and T1-4 for all four.

4. Select the resolution.

Usually a relatively fine resolution—sixteenth or 32nd notes—gives the best results.

Use the [S2] soft key or the [<CURSOR] and [CURSOR>] keys to select the second menu item.

Use the [S2] soft key, [+ /YES] and [- /NO] keys or the [DATA ENTRY] dial to change the time increment.

# PATTERN and SONG Modes

5. Switch to the SET submenu.

Use the [S3] soft key to display the submenu.

6. Select the type of data—usually Note.

Use the [S3] soft key or the [<CURSOR] and [CURSOR>] keys to elect the first menu item.

Use the [+ / YES] and [- / NO] keys or the [DATA ENTRY] dial to switch between All or Note.

7. Select the scaling factor. Although the normal choice is 100%, weak quantization in the 25% to 40% range sometimes provides correction while still leaving natural-sounding timing variations.

Use the [S4] soft key or the [<CURSOR] and [CURSOR>] keys to select the second menu item.

Use the [+ / YES] and [- / NO] keys or the [DATA ENTRY] dial to change the quantization percentage.

8. Press the [EXIT] key to return to the PE5 page.

9. Quantize.

Use the [S4] soft key (\*Exec) to quantize.

Answer the question Sure? (Y/N) with either the [+ / YES] key to proceed or the [- / NO] key to cancel. You may also use the [EXIT] key to cancel.

## 3.2.6 SWING (PE6) Page

This page is for adding a swing triplet effect—an effect that is very difficult to create directly while recording.

The swing effect divides each beat in two and re-scales the two halves by shifting their boundary to a different point, given as a percentage, in the bar.

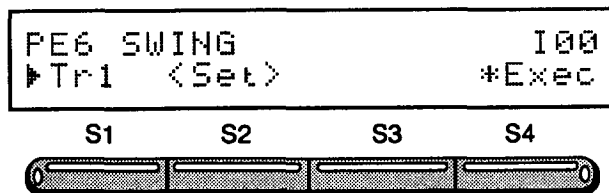

Menu Key	Field	Field Type & Possible Settings	Description
S1	Track number	Tr1 -4 / T1-4	The track to edit. (Note: The setting T1-4 selects all four pattern tracks.)
S2	SET submenu	<Set>	Submenu for setting additional parameters.
S4	EXECUTE command	*Exec	Command to make the change.

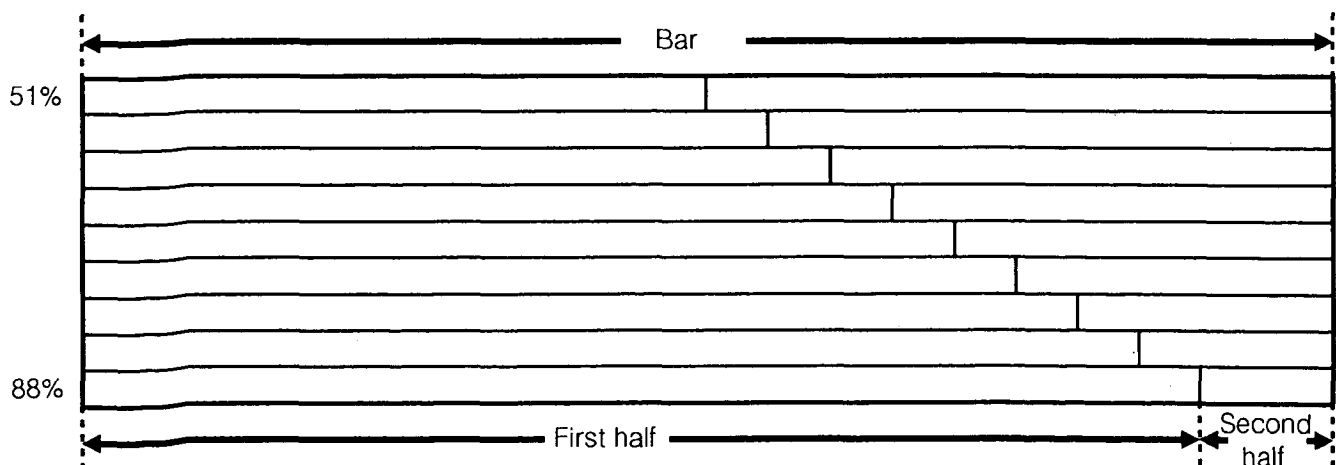

# PATTERN and SONG Modes

## SET Submenu

This page controls the operation of the SWING function.

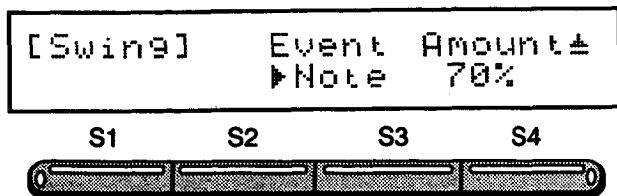

Menu Key	Field	Field Type & Possible Settings	Description
S3	Event	Note /All	Type of data to be edited: all MIDI events (All) or just the notes (Note).
S4	Amount	51-88%	Scaling factor for the SWING function: 51-88%.

*Note: Before starting, make a backup copy of the pattern in the PATTERN COPY (PE9) page. The swing effect changes are irreversible, so it is always a good idea to have a spare copy "just in case"—especially since achieving the right effect can take several tries.*

Procedure:

1. Use the PATTERN SELECT (PE1) page to select the pattern.
2. Use the [PAGE>] key to select the SWING (PE6) page.
3. Select the track or tracks.

Use the [S1] soft key or the [<CURSOR] and [CURSOR>] keys to select the first menu item.

Use the [+ /YES] and [- /NO] keys or the [DATA ENTRY] dial to change the track selection.

*Note: There are five choices: one each for the individual tracks and T1-4 for all four.*

4. Switch to the SET submenu.

Use the [S2] soft key to display the submenu.

5. Select the type of data—usually Note.

Use the [S3] soft key or the [<CURSOR] and [CURSOR>] keys to select the first menu item.

Use the [+ /YES] and [- /NO] keys or the [DATA ENTRY] dial to switch between All and Note.

6. Select the scaling factor.

Use the [S4] soft key or the [<CURSOR] and [CURSOR>] keys to select the second menu item.

Use the [+ /YES] and [- /NO] keys or the [DATA ENTRY] dial to change the percentage.

7. Press the [EXIT] key to return to the PE6 page.

8. Add swing.

Use the [S4] soft key (\*Exec) to add swing.

Answer the question Sure? (Y/N) with either the [+ /YES] key to proceed or the [- /NO] key to cancel. You may also use the [EXIT] key to cancel.

## 3.2.7 BLANK INSERT (PE7) Page

This page is for inserting one or more empty bars into all four tracks of the pattern to make it longer.

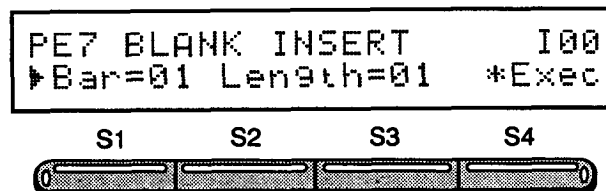

Menu Key	Field	Field Type & Possible Settings	Description
S1	Starting bar	Bar=01 -99	Bar number for the first new bar.
S2 S3	Length	Length=01 -98	Length, in bars, of the insert.
S4	EXECUTE command	*Exec	Command to make the change.

Procedure:

1. Choose the starting bar.

Use the [S1] soft key or the [<CURSOR] and [CURSOR>] keys to select the first menu item.

Use the [+ /YES] and [- /NO] keys or the [DATA ENTRY] dial to change the starting bar.

# PATTERN and SONG Modes

2. Choose the length.

Use the [S2] soft key or the [<CURSOR] and [CURSOR>] keys to select the second menu item.

Use the [+ / YES] and [- / NO] keys or the [DATA ENTRY] dial to change the length in bars.

3. Insert bars.

Use the [S4] soft key (\*Exec) to insert bars.

Answer the question Sure? (Y/N) with either the [+ / YES] key to proceed or the [- / NO] key to cancel. You may also use the [EXIT] key to cancel.

## Example 1 — Putting Two Bars at the Beginning of a Pattern

```
PE7 BLANK INSERT      I00
▶Bar=01 Length=02 *Exec
```

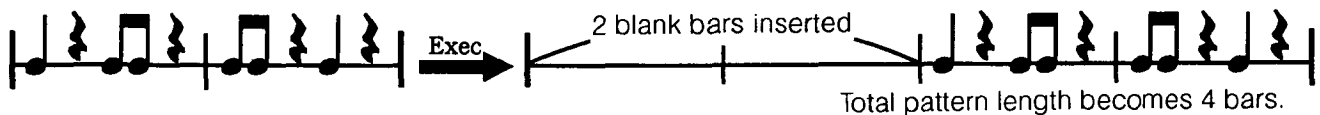

## Example 2 — Inserting Two Bars in the Middle of a Pattern

```
PE7 BLANK INSERT      I00
▶Bar=02 Length=02 *Exec
```



## 3.2.8 TRACK COPY/BOUNCE (PE8) Page

This page is for copying data from the source track to another destination. It offers a choice of overwriting the data at the destination with the data from the source (Copy) or merging the two (Boun).

*Note: Be careful about differences between source and destination tracks' kit assignments. This command replaces the source track's sequencer data (copy) or merges the source track's sequencer data (bounce) with the destination track's sequencer data. If the source track's kit is different from the destination's, the source track's sequencer information will trigger the destination kit's pad assignments, sometimes making for some interesting sounds, but most oftentimes not.*

```
PE8 TR COPY/BOUNCE   I00
▶Tr1 -> Tr2 Copy *Exec
```

S1            S2            S3            S4



Menu Key	Field	Field Type & Possible Settings	Description
S1	Source track	Tr1 -4	Number of the track with the data to be copied (source).
S2	Destination track	Tr1 -4	Number of the track to receive the data (destination).
S3	Copy type	Copy / Boun	Choice of overwrite (Copy) or merge (Boun) operation.
S4	EXECUTE command	*Exec	Command to make the change.

# PATTERN and SONG Modes

Procedure:

1. Choose between overwrite (Copy) or merge (Boun) operation.

Use the [S3] soft key or the [<CURSOR] and [CURSOR>] keys to select the third menu item.

Use the [+ / YES] and [- / NO] keys or the [DATA ENTRY] dial to switch between Copy and Boun.

2. Select the source track.

Use the [S1] soft key or the [<CURSOR] and [CURSOR>] keys to select the first menu item.

Use the [+ / YES] and [- / NO] keys or the [DATA ENTRY] dial to change the track selection.

3. Select the destination track.

Use the [S2] soft key or the [<CURSOR] and [CURSOR>] keys to select the second menu item.

Use the [+ / YES] and [- / NO] keys or the [DATA ENTRY] dial to change the track selection.

4. Copy data.

Use the [S4] soft key (\*Exec) to copy.

Answer the question Sure? (Y/N) with either the [+ / YES] key to proceed or the [- / NO] key to cancel. You may also use the [EXIT] key to cancel.

## Comparison of Copy and Bounce

### Copy

```

PE8 TR COPY/BOUNCE  I00
▶Tr1 -> Tr2  Copy  *Exec
    
```

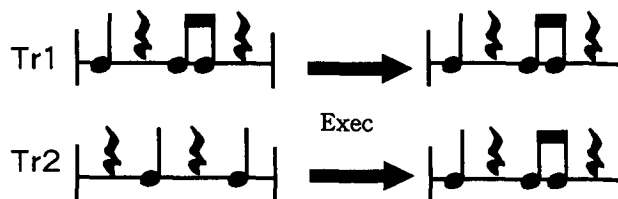

The copy operation takes the source track's sequencer data (track 1) and overwrites it to the destination track (track 2).

### Bounce

```

PE8 TR COPY/BOUNCE  I00
▶Tr1 -> Tr2  Boun  *Exec
    
```

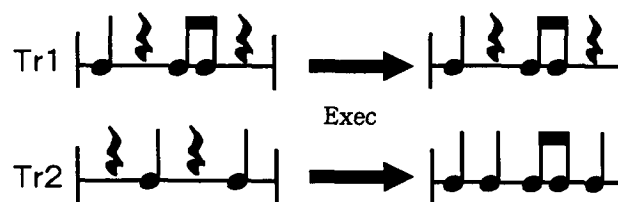

The bounce operation takes the source track's sequencer data (track 1) and merges it with the destination track's sequencer data (track 2).

# PATTERN and SONG Modes

## 3.2.9 PATTERN COPY (PE9) Page

This page is for copying the current pattern, the source, to another, the destination. It automatically copies the pattern name. With the range function, a limited part of a pattern can be copied.

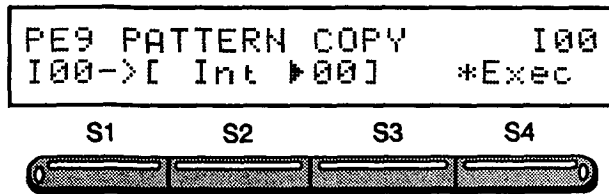

Menu Key	Field	Field Type & Possible Settings	Description
	Current pattern (Source)	I00 ~99 / C00 ~99	Three-character designation for the pattern with the data to be copied. (Note: This field is for display purposes only.)
S2	Bank	Int / Card	Location of the pattern to receive the data.
S3	Destination pattern	00 ~99	Number of the pattern to receive the data.
S4	EXECUTE command	*Exec	Command to make the change.

Procedure:

1. Use the PATTERN SELECT (PE1) page to select the source pattern.

2. Use the [PAGE>] key to select the PATTERN COPY (PE9) page.

3. Select the bank of the destination.

Use the [S2] soft key or the [<CURSOR] and [CURSOR>] keys to select the second menu item.

Use the [+ / YES] and [- / NO] keys or the [DATA ENTRY] dial to change the bank.

4. Select the pattern number of the destination.

Use the [S3] soft key or the [<CURSOR] and [CURSOR>] keys to select the third menu item.

Use the [+ / YES] and [- / NO] keys or the [DATA ENTRY] dial to change the pattern number.

5. Copy the pattern.

Use the [S4] soft key (\*Exec) to copy the pattern.

Answer the question Sure? (Y/N) with either the [+ / YES] key to proceed or the [- / NO] key to cancel. You may also use the [EXIT] key to cancel.

*Note: If the destination pattern is not empty, the S3 asks Over Write?.*

## Example of a Pattern Copy with the Range Function On

An important special case of pattern copy is copying all or part of the current pattern to itself. First use the RANGE (PE2) page to set the desired range. Then use the PATTERN COPY (PE9) page to set the destination pattern to the source pattern.

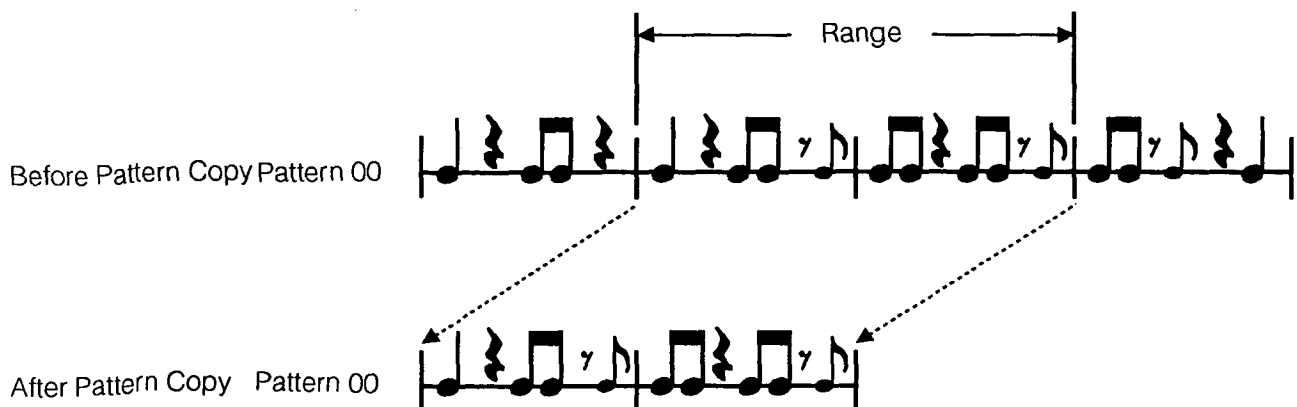

Pattern 00 has been shortened to only the contents of the range function.

# PATTERN and SONG Modes

## 3.2.10 PATTERN APPEND (PE10) Page

This page is for adding the contents of the source to the end of the current pattern, the destination.

```
PE10 PATTERN APPEND I00
I00<-[ Int ▶00] *Exec
```



Menu Key	Field	Field Type & Possible Settings	Description
	Current pattern (Destination)	I00 -99 / C00 -99	Three-character designation for the pattern to receive the data. (Note: This field is for display purposes only.)
S2	Bank	Int / Card	Location of the pattern with the source data.
S3	Source pattern	00 -99	Number of the pattern with the source data.
S4	EXECUTE command	*Exec	Command to make the change.

Procedure:

1. Use the PATTERN SELECT (PE1) page to select the source pattern.

2. Use the [PAGE>] key to select the PATTERN APPEND (PE10) page.

3. Select the source bank.

Use the [S2] soft key or the [<CURSOR] and [CURSOR>] keys to select the second menu item.

Use the [+ / YES] and [- / NO] keys or the [DATA ENTRY] dial to change the bank.

4. Select the source pattern number.

Use the [S3] soft key or the [<CURSOR] and [CURSOR>] keys to select the third menu item.

Use the [+ / YES] and [- / NO] keys or the [DATA ENTRY] dial to change the pattern number.

5. Append data.

Use the [S4] soft key (\*Exec) to append data.

Answer the question Sure? (Y/N) with either the [+ / YES] key to proceed or the [- / NO] key to cancel. You may also use the [EXIT] key to cancel.

### Example 1: Appending Pattern I20 to Pattern I01 to Create a Longer Pattern I01.

(The source pattern, I20, remains unchanged.)

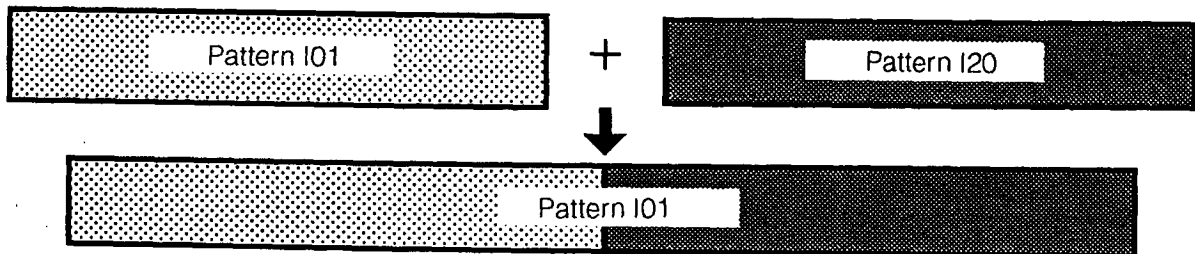

# PATTERN and SONG Modes

## Example 2: Appending a Pattern (I01) to Itself

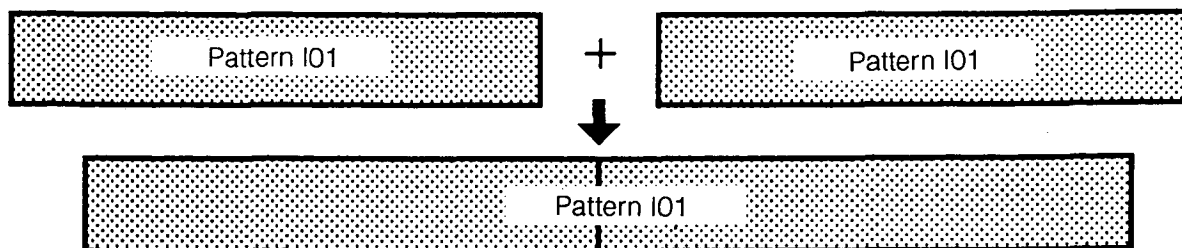

### Applications

- Saving space: Grouping single-bar patterns into larger ones with, for example, four or eight bars, makes it much easier to arrange the patterns into a song.
- Rhythm variations: One way to create a rhythm variation is to append the basic pattern onto itself and then edit the appended portion.

### 3.2.11 PATTERN DELETE (PE11) Page

This page is for deleting the current range of bars from the current pattern. If the RANGE function is off, the current range covers the entire pattern.

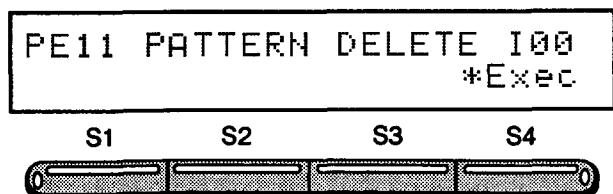

2. Use the [PAGE>] key to select the PATTERN DELETE (PE11) page.

3. Delete data.

Use the [S4] soft key (\*Exec) to delete data.

Answer the question Sure? (Y/N) with either the [+ / YES] key to proceed or the [- / NO] key to cancel. You may also use the [EXIT] key to cancel.

Procedure:

Menu Key	Field	Field Type & Possible Settings	Description
S4	EXECUT command	*Exec	Command to make the change.

1. Use the RANGE (PE2) page to activate the RANGE function and select the range.

*Note: If the RANGE function is off, the current range covers the entire pattern and the PATTERN DELETE function deletes the entire pattern.*



# PATTERN and SONG Modes

## 3.2.12 PATTERN ERASE (PE12) Page

This page is for erasing specific types of data—notes or program changes, for example—from a particular track, all tracks or a particular range of tracks. Unlike the PATTERN DELETE (PE11) page and the PATTERN CLEAR (PE13) page, this page always leaves the bars in the pattern—even if they are empty.

```
PE12 PATTERN ERASE 100
▶Tr1  Note          *Exec
```

S1            S2            S3            S4



Menu Key	Field	Field Type & Possible Settings	Description
S1	Track number	Tr1 -4/T1-4	The track to edit. ( <i>Note</i> : The setting T1-4 selects all four pattern tracks.)
S2 S3	Data type	Note /AllNote/ P-Change/ C-Change/ Pres/ Bender/ AllData	Type of data to erase: <i>Note</i> : All occurrences of a particular MIDI note number—that is, touchpad or keyboard key—in the range. <i>AllNote</i> : All note data in the range. <i>C-Change</i> : All control data in the range. <i>P-Change</i> : All program change data in the range. <i>Bender</i> : All pitch bend data in the range. <i>Pres</i> : All aftertouch data (channel pressure and polyphonic key pressure) in the range. <i>AllData</i> : All data in the range.
S4	EXECUTE command	*Exec	Command to make the change.

Procedure:

1. Select the track.

Use the [S1] soft key or the [<CURSOR] and [CURSOR>] keys to select the first menu item.

Use the [+ /YES] and [- /NO] keys or the [DATA ENTRY] dial to change the track selection.

2. Select the data type—for example, All Data, which erases all data.

Use the [S2] soft key or the [<CURSOR] and [CURSOR>] keys to select the second menu item.

Use the [+ /YES] and [- /NO] keys or the [DATA ENTRY] dial to change the type of data.

3. Erase data.

Use the [S4] soft key (\*Exec) to erase data.

Answer the question Sure? (Y/N) with either the [+ /YES] key to proceed or the [- /NO] key to cancel. You may also use the [EXIT] key to cancel.

*Note: For data type Note, there is an intervening step—namely, specifying the note or notes to erase. If there is more than one, hold down the corresponding key or touchpad for one note and press the keys and touchpads for the others. The confirmation page appears when the last key or touchpad is released.*

# PATTERN and SONG Modes

## 3.2.13 PATTERN CLEAR (PE13) Page

This page is for clearing either the current pattern or all patterns from the memory.

*Note: This page automatically resets the pattern name(s) to \*Empty\*.*

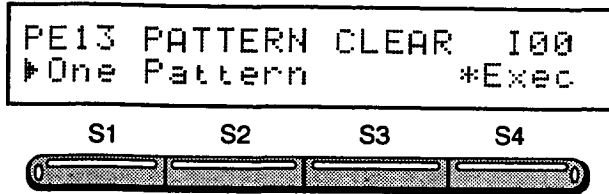

Menu Key	Field	Field Type & Possible Settings	Description
	Selection	One Pattern/ All Patterns	Choice of current pattern or all patterns.
S4	EXECUTE command	*Exec	Command to make the change.

Procedure:

1. Select either the current pattern or all patterns.

Use the [+ / YES] and [- / NO] keys or the [DATA ENTRY] dial to switch between One (the current pattern) or All (all patterns in the bank).

2. Clear pattern(s).

Use the [S4] soft key (\*Exec) to clear the pattern(s).

Answer the question Sure? (Y/N) with either the [+ / YES] key to proceed or the [- / NO] key to cancel. You may also use the [EXIT] key to cancel.

*Note: The screen automatically returns to the PATTERN SELECT (PE1) page.*

## 3.3 SONG PLAY/REC Mode

This mode is for joining patterns together into songs. To add extra depth, there are also facilities for changing drum kits, adding effects and recording real-time tracks for use alongside song tracks built up from patterns.

### 3.3.1 SONG SELECT (SP1) Page

This page is for selecting a song for recording, arranging and playback with the SONG PLAY/REC and SONG EDIT modes.

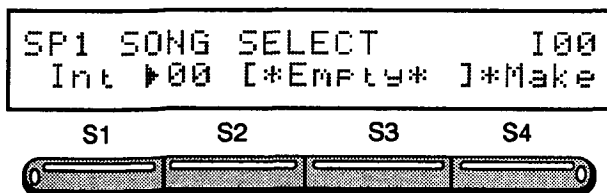

Menu Key	Field	Field Type & Possible Settings	Destination
S1	Bank	Int / Card	Location of the song: Int for internal memory or Card for a RAM card.
S2	Song number	00 - 29	Number of the song to be recorded, arranged or played back.
S3	Song name	[ ]	Name associated with the song. This changes automatically with the number, but may also be edited.
S4	MAKE command	*Make	Command to create a new song.

The first two fields determine the three-character designation for the song. This designation, which appears in the upper right corner of every page in the SONG PLAY/REC and SONG EDIT modes, consists of a single letter (I or C) for the bank plus a two-digit number (00 ~ 99).

The third field is for giving the song a descriptive name.

*Note: This name appears only on the SONG PLAY/REC and SONG EDIT modes' SONG SELECT pages and the SONG SETTING page's NEXT submenu.*

*Note: There are two special song name designations: \*Empty\* denotes a cleared song; - - - - - denotes a defined song without a name. The MAKE command starts the SONG PLAY/REC mode by allowing you to choose a song name.*

# PATTERN and SONG Modes

Procedure:

Use the standard menu procedures. See 3.1.1 *PATTERN SELECT (PP1) Page*.

*Note: Before a song can be recorded, arranged or played back, it must first be created with the MAKE command.*

*Note: Songs cannot be made (MAKE) when Card is chosen as the bank. The Card bank is used for back-up storage of songs, patterns, kits, etc. For a more complete discussion of card usage, see Chapter 8 Data Dump Facilities.*

*Note: Making a song is the most efficient way to use the S3's internal memory. When memory starts to become used up, it is best to save unneeded songs to RAM cards and then clear their contents in the internal memory with the SONG CLEAR (SP8) page.*

*Note: Pages after SP1 cannot be accessed with an un-made song.*

## SONG START TIME (Time) Submenu

This page is for specifying the absolute starting time for a song relative to an external SMPTE signal. For example, if the starting time is five minutes, the sequencer waits for the five-minute signal from the equipment providing the SMPTE synchronization signals.

*Note: For all other synchronization modes, there is no delay. Pressing the [PLAY] key automatically starts recording or playback.*

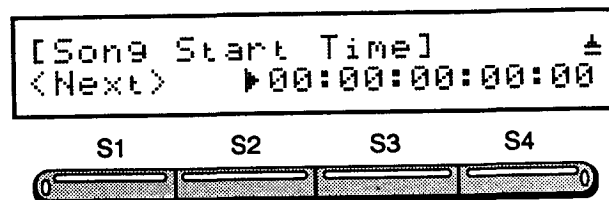

Procedure:

1. Select the starting time in SMPTE format: hours, minutes, seconds, frames and bits (1/80 frame).

Use the [<CURSOR] and [CURSOR>] keys to move between the time increments.

Use the [+ / YES] and [- / NO] keys or the [DATA ENTRY] dial to change the starting time.

2. (Optional) Switch to the NEXT SONG SELECT submenu.

Use the [S1] soft key to display the submenu.

3. Press the [EXIT] key to return to the Song Start Time page.

## 3.3.2 SONG SETTING (SP2) Page

This page provides access to four submenus for setting such parameters as starting time (for SMPTE synchronization only), initial tempo, initial kit and initial effect. These settings are stored as part of the song data.

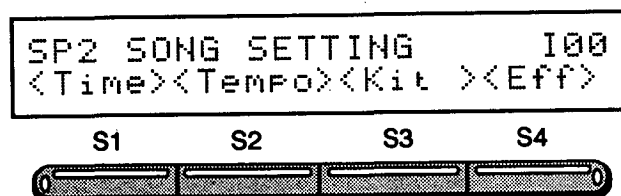

Menu Key	Field	Field Type & Possible Settings	Destination
S1	SONG START TIME Submenu	<Time>	Submenu for setting starting time (for SMPTE synchronization only).
S2	INITIAL TEMPO Submenu	<Tempo>	Submenu for setting initial tempo.
S3	INITIAL KIT Submenu	<Kit >	Submenu for setting initial kit.
S4	EFFECT ASSIGN Submenu	<Eff>	Submenu for setting initial effect.

# PATTERN and SONG Modes

## NEXT SONG SELECT (Next) Submenu

This page is for chaining from the current song to another. Chaining means to start one song immediately when another finishes. This process may be repeated as often as desired to create a medley of any length. (See *Chaining Three Songs* below) In actuality, there is a very brief pause between songs.

*Note: When doing Sync operations in the SMPTE mode, note that the Song Start Time set for the following song is ignored.*

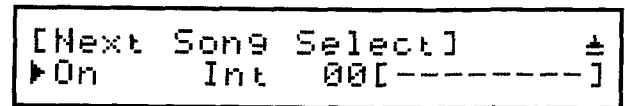

Menu Key	Field	Field Type & Possible Settings	Destination
S1	ON/OFF switch	On / Off	A switch that controls the chaining function.
S2	Bank	Int / Card	Location of the next song.
S3 S4	Song number	00-29	Number of the next song.
	Song name	[ ]	Name assigned to the song. (Note: This field is for display purposes only. It cannot be edited.)

### Example: Chaining Three Songs

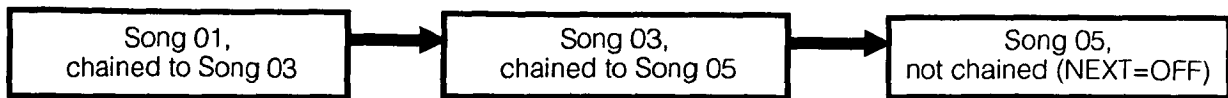

Procedure:

1. Use the SONG SELECT (SP1) page to select the starting song.

Use the [S3] soft key or the [<CURSOR] and [CURSOR>] keys to select the third menu item.

2. Switch to the SONG SETTING (SP2) page and select the NEXT SONG SELECT submenu on the Song Start Time submenu.

Use the [+ / YES] and [- / NO] keys or the [DATA ENTRY] dial to change the song number.

Use the [S1] soft key to display the SONG START TIME submenu.

5. Set the chain function switch.

Use the [S1] soft key to display the NEXT SONG SELECT submenu.

Use the [S1] soft key or the [<CURSOR] and [CURSOR>] keys to select the first menu item.

3. Select the bank for the next song.

Use the [+ / YES] and [- / NO] keys or the [DATA ENTRY] dial to change the field value.

Use the [S2] soft key or the [<CURSOR] and [CURSOR>] keys to select the second menu item.

*Note: To add a song, select ON and proceed to the next step. To terminate the chain, select OFF and press the [EXIT] key to return to the Song Start Time page.*

Use the [+ / YES] and [- / NO] keys or the [DATA ENTRY] dial to change the bank.

6. Press the [EXIT] key to return to the SP2 page.

4. Select the song number.

7. Repeat the above procedure as often as desired.

# PATTERN and SONG Modes

## INITIAL TEMPO (Tempo) Submenu

This page is for specifying the song's initial tempo. It automatically displays the time required to play the song at the initial tempo. It is also possible to reverse the calculation: changing the total time field automatically updates the tempo. The MAP submenu allows tempo changes from within the song.



Menu Key	Field	Field Type & Possible Settings	Destination
	Tempo	40.00 -250.00	Base tempo for the entire song.
S3	MAP EDIT submenu	<Map>	Use this submenu to change the tempo during the song.
S4	SONG TOTAL TIME submenu	<Time>	Use this submenu to change the song's total time.

Two Possible Procedures:

*Note: Since the song's total time and initial tempo are linked, it is only necessary to edit one of them. The S3 automatically updates the other.*

1. Change the tempo.

Use the [+ / YES] and [- / NO] keys or the [DATA ENTRY] dial to change the tempo.

2. Press the [EXIT] key to return to the SP2 page.

*Note: To edit the number to the right of the decimal point, use the [CURSOR>] key.*

OR

1. Change the total time in SMPTE format: hours, minutes, seconds, frames and bits (1/80 frame).

a. Use the [S4] soft key to select the SONG TOTAL TIME submenu.

b. Use the [+ / YES] and [- / NO] keys or the [DATA ENTRY] dial to change the total time.

Use the [<CURSOR] and [CURSOR>] keys to move between the time increments.

- c. Use the [S1] soft key (\*Exec) to select the new song total time.

Answer the question Sure? (Y/N) with either the [+ / YES] key to proceed or the [- / NO] key to cancel. You may also use the [EXIT] key to cancel.

- d. Use the [EXIT] key to return to the INITIAL TEMPO submenu.

2. Press the [EXIT] key to return to the SP2 page.

## MAP EDIT (Map) Subsubmenu

The MAP EDIT subsubmenu allows insertion and deletion of individual tempo changes within a song as well as a total clear of all tempo changes within a song.

*Note: The initial tempo, the tempo defined at [ 1 : 1 : 0 ], cannot be changed with the MAP EDIT subsubmenu. Use the INITIAL TEMPO submenu to change the initial tempo.*

*Note: The S3 allows a maximum of 100 tempo map edits, including the initial tempo.*

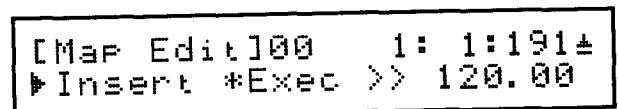

Menu Key	Field	Field Type & Possible Settings	Destination
S1	Function	Insert/ Delete/ Clear	Map Edit's function
S2	EXECUTE command	*Exec	Command to make the change.
S3	Tempo change point	1:1:191	Location where new tempo takes effect. The smallest increment is not one tick; the location can be specified to only a minimum of eight tick units.
S4	Tempo	40.00 -250.00	New tempo's value

# PATTERN and SONG Modes

## Procedure for Inserting a Tempo Change:

1. Set the tempo change location: bar, beat and tick.

Use the [S3] soft key or the [<CURSOR] and [CURSOR>] keys to select the third menu item.

Use the [<CURSOR] and [CURSOR>] keys to move between the time fields.

Use the [+ / YES] and [- / NO] keys or the [DATA ENTRY] dial to change the location point.

*Note: The >> mark signals that the currently selected point has an inserted tempo change. By using the [FF] and [REW] keys, subsequent and preceding tempo change points respectively can be quickly located.*

2. Choose the Insert function.

Use the [S1] soft key or the [<CURSOR] and [CURSOR>] keys to select the first menu item.

Use the [+ / YES] and [- / NO] keys or the [DATA ENTRY] dial to change to Insert.

3. Choose the tempo value.

Use the [S4] soft key or the [<CURSOR] and [CURSOR>] keys to select the fourth menu item.

Use the [+ / YES] and [- / NO] keys or the [DATA ENTRY] dial to change the tempo.

*Note: To edit the number to the right of the decimal point, use the [<CURSOR] and [CURSOR>] keys.*

4. Insert the tempo change.

Use the [S2] soft key (\*Exec) to insert the tempo change.

*Note: The Insert function automatically overwrites the current location's tempo, so it is not necessary to Delete the tempo change first.*

## Procedure for Deleting a Tempo Change:

1. Find the previously defined tempo change location

Use the [FF] and [REW] keys to locate the desired tempo change point (indicated by the >> mark).

2. Choose the Delete function.

Use the [S1] soft key or the [<CURSOR] and [CURSOR>] keys to select the first menu item.

Use the [+ / YES] and [- / NO] keys or the [DATA ENTRY] dial to change to Delete.

3. Delete the tempo change.

Use the [S2] soft key (\*Exec) to delete the tempo change.

## Procedure for Clearing all Tempo Changes:

1. Choose the Clear function.

Use the [S1] soft key or the [<CURSOR] and [CURSOR>] keys to select the first menu item.

Use the [+ / YES] and [- / NO] keys or the [DATA ENTRY] dial to change to Clear.

2. Clear all the tempo changes.

Use the [S2] soft key (\*Exec) to delete the tempo change.

Answer the question Sure? (Y/N) with either the [+ / YES] key to proceed or the [- / NO] key to cancel. You may also use the [EXIT] key to cancel.

## SONG TOTAL TIME (Time) Subsubmenu

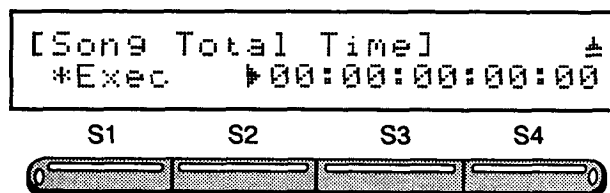

Menu Key	Field	Field Type & Possible Settings	Destination
S1	EXECUTE command	*Exec	Command to make the change.
	Total time	Hours: 00-23 Minutes: 00-59 Seconds: 00-59 Frames: 00-23 / 24 / 29 Bits: 00-79	The song's total time in SMPTE format.

Procedure:

See the INITIAL TEMPO submenu.

# PATTERN and SONG Modes

## INITIAL KIT (Kit) Submenu

This page is for specifying the initial drum kit assignments for the four pairs of song and pattern tracks. It automatically displays the current assignments by both number and name.

*Note: This page controls the drum kits assigned to individual tracks, but the TRACK STATUS (SP4) page determines whether or not they actually produce output.*

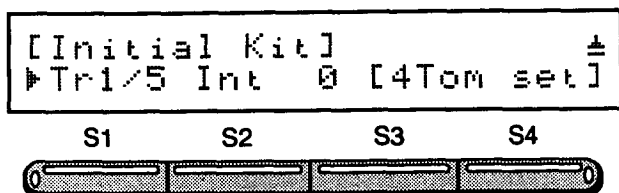

Menu Key	Field	Field Type & Possible Settings	Destination
S1	Track pair	Tr1/5/Tr2/6/ Tr3/7/Tr4/8	Current track pair numbers.
S2	Bank	Pre / Int / Card	Location of the kit: Pre (preset drum kits), Int (internal bank) or Card (IC card).
S3	Kit	0-9	Number of the kit.

Procedure:

1. Use the standard menu procedures.
2. Press the [EXIT] key to return to the SP2 page.

## EFFECT ASSIGN (Eff) Submenu

This page is for specifying the song's initial effect assignment.

*Note: For complete details on the individual effects, see Chapter 5 Effects.*

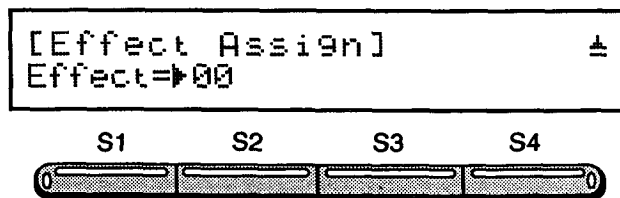

Menu Key	Field	Field Type & Possible Settings	Destination
	Effect number	00-15	Number of the effect.

Procedure:

1. Use [+ / YES] and [- / NO] keys or the [DATA ENTRY] dial to change the effect number.
2. Press the [EXIT] key to return to the SP2 page.

## 3.3.3 ARRANGE (SP3) Page

This page is the primary area for building a song from three types of structural elements: patterns, drum kit changes and repeat commands. Instead of using sub-menus, this page provides an element selection field on the first line. Moving the cursor to this field and changing its value produces slight changes in the contents of the page.

One part of the page common to all three is the three digit sequence number in the lower left corner. This field keeps track of the position in the sequence in terms of the number of elements. Adding a pattern, drum kit change or repeat command raises this number by one. This page also allows the user to add such elements anywhere in the sequence—not just at the end—and to delete them if they are no longer desired.

## PATTERN (PTN) Submenu

This page is for adding, inserting (Ins), deleting (Del) or overwriting (OvrWrt) patterns.

*Note: The upper right corner of the display gives the current length of the song in bars or measures, not structure elements. If the current structure element is the final element in the song, the symbol <E> (for "End") appears to the left of this count.*

# PATTERN and SONG Modes

```

SP3 ARRANGE PTN M002
▶000 [ Int 00] *Ins
    
```



Menu Key	Field	Field Type & Possible Settings	Destination
S1	Sequence number	000 -250	Element position in the song.
S2	Bank	Int /Card	Location of the pattern.
S3	Pattern number	00 -99	Number of the pattern.
S4	Command selection field	*OvrWrt/*Ins/*Del	Command to execute at the current position. (Note: To change commands, press the [SHIFT] and soft keys.)

Note: When a card hasn't been inserted or a card without pattern information has been inserted and Card has been selected as the bank location, a ? error occurs.

Note: A maximum of 999 measures can be used to construct a song. If this maximum is surpassed, an error message is displayed and the song cannot be played. The error can be fixed by reducing the number of measures in certain patterns or by shortening the song's total measure length by changing the arrangement.

## KIT (Kit) Submenu

This page is for adding, inserting (Ins), deleting (Del) or overwriting (OvrWrt) drum kit changes.

Note: The upper right corner of the display contains a field for specifying the track number. Use the [<CURSOR] and [CURSOR>] keys to select the field and the [+ /YES] and [- /NO] keys or [DATA ENTRY] dial to change the track.

Note: This page controls the drum kits assigned to individual tracks, but the TRACK STATUS (SP4) page determines whether or not they actually produce output.

```

SP3 ARRANGE ▶Kit Tr1/5
001 [ Int 00] *Ins
    
```



Menu Key	Field	Field Type & Possible Settings	Destination
S1	Sequence number	000 -250	Element position in the song.
S2	Bank	Pre /Int /Card	Location of the drum kit.
S3	Drum kit number	0 -9	Number of the drum kit.
S4	Command selection field	*OvrWrt/*Ins/*Del	Command to execute at the current position. (Note: To change commands, press the [SHIFT] and soft keys.)

Note: When a card hasn't been inserted or a card without kit information has been inserted and Card has been selected as the bank location, a ? error occurs.

## REPEAT (Rpt) Submenu

This page is for adding, inserting (Ins), deleting (Del) or overwriting (OvrWrt) repeat commands.

Note: The upper right corner of the display gives the current length of the song in bars or measures, not elements. If the current element is the final element in the song, the symbol <E> (for "End") appears to the left of this count.

```

SP3 ARRANGE ▶Rpt<E> M002
002 [To 000x 02] *Ins
    
```



Menu Key	Field	Field Type & Possible Settings	Destination
S1	Sequence number	000 -250	Element position in the song.
S2	Starting point Number of repeats	To 000 -249	Element from which to start repeating.
S3	Number of repeats.	2 -99	Number of repeats.
S4	Command selection field	*OvrWrt/*Ins/*Del	Command to execute at the current position. (Note: To change commands, press the [SHIFT] and soft keys.)

Note: Be careful when using the Repeat function because a maximum of 999 measures can be used to construct a song.



# PATTERN and SONG Modes

## 3.3.4 TRACK STATUS (SP4) Page

This page controls the use of drum kits and MIDI ports for all eight tracks. These settings are stored with the sequencer data and cover both pattern and song tracks.

```
SP4 TRACK STATUS      I00
▶Tr1  Both 01000 <MIDI>
```



## MIDI Submenu

The first field in this page gives the current track. The remaining two fields control the MIDI output port connections and the MIDI output channel for that track. It's important to note that the track status setting, the second field on the TRACK STATUS (SP4) menu, takes precedence and must be Ext or Both to produce actual MIDI output.

```
[MIDI] Port  Ch  ±
▶Tr1  ▶A+B  01
```



Menu Key	Field	Field Type & Possible Settings	Destination
S1	Track number	Tr1 -8	Track selection field.
S2	Track output status	Mute / Int / Ext / Both	Track output status—i.e., whether data is transmitted to a drum kit, a MIDI output channel, both or neither. <b>Mute:</b> No data transmitted to drum kit or MIDI interface. <b>Int:</b> Data only transmitted to the current drum kit for the track. The initial drum kit appears on the SONG SETTING (SP2) KIT submenu, but this may change as the result of a drum kit change added in the KIT ARRANGE (SP3) page. <b>Ext:</b> Data transmitted to the MIDI interface. <b>Both:</b> Data transmitted to both the drum kit and MIDI interface. (Same as Int + Ext.)
S3	Track delay	000 -192	Delay relative to the tracks. The time unit is a tick, 1/192 of a quarter note. Such delays, which can be up to a quarter note in length, add subtle shifts that make the output sound more natural.
S4	MIDI submenu	<MIDI>	Submenu for assigning MIDI output channels to individual tracks.

Menu Key	Field	Field Type & Possible Settings	Destination
S1	Track number	Tr1 -8	Track number selection.
S2	MIDI port(s)	Off / A/B / A+B	Connections to MIDI ports A and B: A, B, both or neither (Off).
S3	MIDI channel	01 -16	MIDI transmission channel for the track.

Procedure:

1. Use the standard menu procedures.
2. Press the [EXIT] key to return to the SP4 page.

# PATTERN and SONG Modes

## 3.3.5 REC MODE (SP5) Page

This page is for switching between regular and PUNCH IN/PUNCH OUT recording. When you choose PUNCH IN/PUNCH OUT recording, the SP5 page lets you set the punch in and punch out points.

```
SP5 REC MODE [Cue Point]
▶Normal      In=1 Out=8
```



Menu Key	Field	Field Type & Possible Settings	Destination
S1 S2	Recording mode	Normal/ PunchIn	Choice of Normal or Punch In recording.
S3	PUNCH IN point	In=1 ~7	Cue point at which to start PUNCH IN/PUNCH OUT recording.
S4	PUNCH OUT point	Out=2 ~8	Cue point at which to end PUNCH IN/PUNCH OUT recording.

## 3.3.6 REC LEAD IN (SP6) Page

This page is for providing 0 ~ 16 metronome ticks in advance of the start of actual recording.

This lead in function, unlike the REC LEAD IN (PP3) page, counts beats instead of bars. These settings are for recording purposes only and are not stored with the song.

```
SP6 REC LEAD IN      I00
▶Off  Beat=01
```



Menu Key	Field	Field Type & Possible Settings	Destination
S1	ON/OFF switch	On / Off	Current state (ON/OFF) of the REC LEAD IN function.
S2 S3	Length	01 ~16	Length, in beats, of the lead in—4 beats, for example, if the song uses 4/4 time.

## 3.3.7 SONG COPY (SP7) Page

This page is for copying all the data in the tracks from the current song to another.

```
SP7 SONG COPY      I00
I00->[ Int ▶00]   *Exec
```



Menu Key	Field	Field Type & Possible Settings	Destination
	Current song (Source)	I00 ~29 / C00 ~29	Three-character designation for the song with the data to be copied. (Note: This field is for display purposes only.)
S2	Bank	Int / Card	Location of the song to receive the data.
S3	Destination song	00 ~29	Number of the song to receive the data.
S4	EXECUTE command	*Exec	Command to copy the song.

Procedure:

1. Use the SONG SELECT (SP1) page to select the source song.
2. Use the [PAGE>] key to select the SONG COPY (SP7) page.
3. Select the bank of the destination.

Use the [S2] soft key or the [<CURSOR] and [CURSOR>] keys to select the second menu item.

Use the [+ / YES] and [- / NO] keys or the [DATA ENTRY] dial to change the bank.

4. Select the song number of the destination.

Use the [S3] soft key or the [<CURSOR] and [CURSOR>] keys to select the third menu item.

Use the [+ / YES] and [- / NO] keys or the [DATA ENTRY] dial to change the song number.

# PATTERN and SONG Modes

5. Copy the song.

Use the [S4] soft key (\*Exec) to copy the song. Answer the question Sure? (Y/N) with either the [+YES] key to proceed or the [-/NO] key to cancel. You may also use the [EXIT] key to cancel.

*Note: If the destination song is not empty, the S3 asks Over Write?.*

## 3.3.8 SONG CLEAR (SP8) Page

This page is for clearing either the current song or all songs from the memory.

```

SP8 SONG CLEAR          I00
▶OneSong                *Exec
    
```

S1            S2            S3            S4



Menu Key	Field	Field Type & Possible Settings	Destination
	Song selection field	OneSong/ AllSongs	Choice of songs to clear.
S4	EXECUTE command	*Exec	Command to make the change.

Procedure:

1. If deleting one song, use the SONG SELECT (SP1) page to select the song and then use the [PAGE>] key to select the SONG CLEAR (SP8) page.
2. Specify the current song (One Song) or All Songs.

Use the [+YES] and [-/NO] keys or the [DATA ENTRY] dial to change the field value.

3. Clear.

Use the [S4] soft key (\*Exec) to clear the song(s).

Answer the question Sure? (Y/N) with either the [+YES] key to proceed or the [-/NO] key to cancel. You may also use the [EXIT] key to cancel.

## 3.4 SONG EDIT Mode

This mode provides most of the same track editing functions for song tracks that the PATTERN EDIT mode provides for pattern tracks. These tracks may be edited individually or together as a group. There is also a RANGE function for editing a particular range within the song. The range can be as wide as the whole song (many bars) or as narrow as a few ticks.

*Note: Pages after SE2 cannot be accessed if the currently selected one has not yet been created. Also when the song is edited such that the song track becomes longer than the pattern track, the longer part cannot be edited.*

### 3.4.1 SONG SELECT (SE1) Page

This page is for selecting a song for recording, arranging and playback with the SONG PLAY/REC and SONG EDIT modes.

```

SE1 SONG SELECT          I00
Int ▶00 [*Empty* ]
    
```

S1            S2            S3            S4



Menu Key	Field	Field Type & Possible Settings	Destination
S1	Bank	Int /Card	Location of the song: Int for internal memory or Card for a RAM card.
S2	Song number	00 -29	Number of the song to be edited or played back.
S3	Song name	[            ]	Name associated with the song. This changes automatically with the number, but may also be edited.

Procedure:

Use the standard menu procedures.

# PATTERN and SONG Modes

## 3.4.2 RANGE (SE2) Page

This page is for limiting editing to a specific part of the song. An important difference from the PATTERN RANGE (PP2 and PE2) pages is its higher resolution. Whereas a pattern range must cover complete bars, the SE2 page allows the range to start and end at any particular tick—the same resolution as the cue point function.

When the RANGE function (SE2) is in effect, the symbol  appears to the right of the three-character song designation in the upper right corner of every page in the SONG EDIT mode.

*Note: The RANGE function in the song mode functions differently from the pattern modes in that it defines a range for editing only and does not affect song playback.*

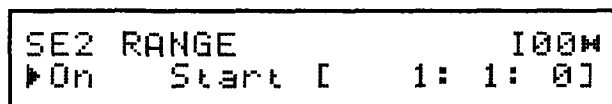

S1            S2            S3            S4



Menu Key	Field	Field Type & Possible Settings	Destination
S1	ON/OFF switch	On / Off	Current state (ON/OFF) of the RANGE function.
S2	Marker selection field	Start / End	Choice of markers.
S3 S4	Song position	[ : : ]	Song position in bars, beats and ticks.

Procedure:

1. Switch the RANGE function ON or OFF.

Use the [S1] soft key or the [<CURSOR] and [CURSOR>] keys to select the first menu item.

Use the [+ / YES] and [- / NO] keys or the [DATA ENTRY] dial to change the field value.

2. Specify the starting marker (Start).

Use the [S2] soft key or the [<CURSOR] and [CURSOR>] keys to select the second menu item.

Use the [+ / YES] and [- / NO] keys or the [DATA ENTRY] dial to change the field value.

3. Specify the song position (bar:note:tick).

Use the [S3] soft key or the [<CURSOR] and [CURSOR>] keys to select the third menu item.

Use the [+ / YES] and [- / NO] keys or the [DATA ENTRY] dial to change the field value.

Use the [<CURSOR] and [CURSOR>] keys to move between subfields.

4. Specify the end marker (End).

Use the [S2] soft key or the [<CURSOR] and [CURSOR>] keys to select the second menu item.

Use the [+ / YES] and [- / NO] keys or the [DATA ENTRY] dial to change the field value.

5. Specify the song position (bar:note:tick).

Use the [S3] soft key or the [<CURSOR] and [CURSOR>] keys to select the third menu item.

Use the [+ / YES] and [- / NO] keys or the [DATA ENTRY] dial to change the field value.

Use the [<CURSOR] and [CURSOR>] keys to move between subfields.

## 3.4.3 TRANSPOSE (SE3) Page

This page is for shifting all pitches on a particular song track, all song tracks or a particular range of song tracks up or down by a fixed number of semitones up to a maximum of two octaves (24 semitones) on either side. To transpose particular pattern tracks, see 3.2.3 TRANSPOSE (PE3).

*Note: The transpose function permanently alters data, so it is a good idea to use the SP7 SONG COPY page described in 3.3.7 to make a back-up in case of error.*

*Note: Drum and percussion instrument data assigned to drum kits is also altered with the transpose function. Because the sounds are nonchromatic, they are altered in an irregular fashion. For more precise control of the percussive sounds use the pad submode's PAD EDIT (P3) page's TUNE submenu and the kit mode's NOTE ASSIGN (K5) page. See Chapter 4 Instrument Modes.*

# PATTERN and SONG Modes

```
SE3 TRANSPOSE          I00
▶Tr5      0             *Exec
```



Menu Key	Field	Field Type & Possible Settings	Destination
S1	Track number	Tr5 -8/T5-8	The track to edit. (Note: The setting T5-8 selects all four song tracks.)
S2	Transposition value	-24 →+24	Size, in semitones and direction (+/-) of the transposition.
S4	EXECUTE command	*Exec	Command to make the change.

Procedure:

1. Select the track or tracks.

Use the [S1] soft key or the [<CURSOR] and [CURSOR>] keys to select the first menu item.

Use the [+YES] and [-/NO] keys or the [DATA ENTRY] dial to change the field value.

2. Select the transposition value.

Use the [S2] soft key or the [<CURSOR] and [CURSOR>] keys to select the second menu item.

Use the [+YES] and [-/NO] keys or the [DATA ENTRY] dial to change the field value.

3. Transpose.

Use the [S4] soft key (\*Exec) to execute the command.

Answer the question Sure? (Y/N) with either the [+YES] key to proceed or the [-/NO] key to cancel. You may also use the [EXIT] key to cancel.

## 3.4.4 VELOCITY EDIT (SE4) Page

This page provides access to three submenus for adjusting all key velocities on a particular track, all tracks or a particular range of tracks.

*Note: If the result of an adjustment falls outside the range 2 ~ 126, it is automatically replaced with the nearest endpoint—that is, 2 or 126, respectively.*

*Note: All three submenus in the VELOCITY EDIT (SE4) page permanently alter data, so it is a good idea to use the SP7 SONG COPY page described in 3.3.7 to make a back-up in case of error.*

```
SE4 VELOCITY EDIT      I00
<Shft><Cmp ><Exp >
```



Menu Key	Field	Field Type & Possible Settings	Destination
S1	SHIFT submenu	<Shft>	Submenu for shifting the velocities up or down by a fixed amount
S2	COMPRESSION submenu	<Cmp >	Submenu for rescaling the velocities to reduce their difference from a reference point called the threshold.
S3	EXPANSION submenu	<Exp >	Submenu for rescaling the velocities to magnify their difference from the threshold.

Procedure:

Press the corresponding menu key to select the desired submenu.

# PATTERN and SONG Modes

## SHIFT (Shft) Submenu

This page is for shifting the velocities up or down by a fixed amount, called the bias. The SHIFT submenu is functionally the same as the PE4 page's SHIFT submenu.

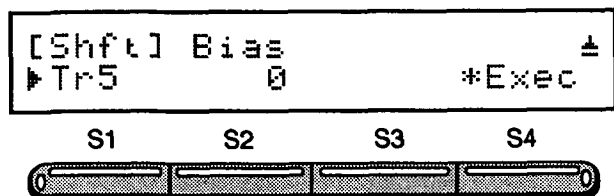

Menu Key	Field	Field Type & Possible Settings	Destination
S1	Track number	Tr5 -8/T5-8	The track to edit. (Note: The setting T5-8 selects all four song tracks.)
S2	Bias	-126 -+126	Size and direction (+/-) of the velocity shift.
S4	EXECUTE command	*Exec	Command to make the change.

Procedure:

1. Select the track or tracks.

Use the [S1] soft key or the [<CURSOR] and [CURSOR>] keys to select the first menu item.

Use the [+ / YES] and [- / NO] keys or the [DATA ENTRY] dial to change the field value.

2. Select the bias.

Use the [S2] soft key or the [<CURSOR] and [CURSOR>] keys to select the second menu item.

Use the [+ / YES] and [- / NO] keys or the [DATA ENTRY] dial to change the field value (max +126/ min -126).

3. Change the velocities.

Use the [S4] soft key (\*Exec) to shift the velocities.

Answer the question Sure? (Y/N) with either the [+ / YES] key to proceed or the [- / NO] key to cancel. You may also use the [EXIT] key to cancel.

4. Press the [EXIT] key to return to the SE4 page.

## COMPRESSION (Cmp) Submenu

This page is for rescaling the velocities to compress their dynamic range—that is, limit the contrast between loud and soft—by reducing their differences from a reference point called the threshold. The COMPRESSION submenu is functionally the same as the PE4 page's COMPRESSION submenu.

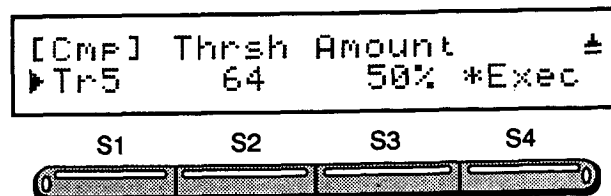

Menu Key	Field	Field Type & Possible Settings	Destination
S1	Track number	Tr5 -8/T5-8	The track to edit. (Note: The setting T5-8 selects all four song tracks.)
S2	Threshold	2-126	Reference point for calculating relative velocity.
S3	Amount	1-100%	Scaling factor for the velocity shift. The larger this percentage, the greater the amount of rescaling—that is, the closer the velocities move toward the threshold.
S4	EXECUTE command	*Exec	Command to make the change.

Procedure:

1. Select the track or tracks.

Use the [S1] soft key or the [<CURSOR] and [CURSOR>] keys to select the first menu item.

Use the [+ / YES] and [- / NO] keys or the [DATA ENTRY] dial to change the field value.

2. Select the threshold.

Use the [S2] soft key or the [<CURSOR] and [CURSOR>] keys to select the second menu item.

Use the [+ / YES] and [- / NO] keys or the [DATA ENTRY] dial to change the field value (2 - 126).

3. Select the scaling factor (Amount).

Use the [S3] soft key or the [<CURSOR] and [CURSOR>] keys to select the third menu item.

# PATTERN and SONG Modes

Use the [+ / YES] and [- / NO] keys or the [DATA ENTRY] dial to change the field value (1 ~ 100%).

## 4. Change the velocities.

Use the [S4] soft key (\*Exec) to compress the velocities.

Answer the question Sure? (Y/N) with either the [+ / YES] key to proceed or the [- / NO] key to cancel. You may also use the [EXIT] key to cancel.

## 5. Press the [EXIT] key to return to the SE4 page.

### EXPANSION (Exp) Submenu

This page is for rescaling the velocities to expand their dynamic range—that is, enhance the contrast between loud and soft—by magnifying their differences from a reference point called the threshold. The EXPANSION submenu is functionally the same as the PE4 page's EXPANSION submenu.

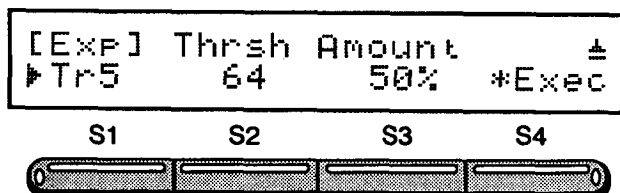

Menu Key	Field	Field Type & Possible Settings	Destination
S1	Track number	Tr5 -8 / T5-8	The track to edit. (Note: The setting T5-8 selects all four song tracks.)
S2	Threshold	2-126	Reference point for calculating relative velocity.
S3	Amount	1-100%	Scaling factor for the velocity shift. The larger this percentage, the greater the amount of rescaling—that is, the farther the velocities move away from the threshold.
S4	EXECUTE command	*Exec	Command to make the change.

Procedure:

## 1. Select the track or tracks.

Use the [S1] soft key or the [<CURSOR] and [CURSOR>] keys to select the first menu item.

Use the [+ / YES] and [- / NO] keys or the [DATA ENTRY] dial to change the field value.

## 2. Select the threshold.

Use the [S2] soft key or the [<CURSOR] and [CURSOR>] keys to select the second menu item.

Use the [+ / YES] and [- / NO] keys or the [DATA ENTRY] dial to change the field value (2 ~ 126).

## 3. Select the scaling factor (Amount).

Use the [S3] soft key or the [<CURSOR] and [CURSOR>] keys to select the third menu item.

Use the [+ / YES] and [- / NO] keys or the [DATA ENTRY] dial to change the field value (1 ~ 100%).

## 4. Change the velocities.

Use the [S4] soft key (\*Exec) to expand the velocities.

Answer the question Sure? (Y/N) with either the [+ / YES] key to proceed or the [- / NO] key to cancel. You may also use the [EXIT] key to cancel.

## 5. Press the [EXIT] key to return to the SE4 page.

# PATTERN and SONG Modes

## 3.4.5 QUANTIZE (SE5) Page

The SE5 page is for shifting data to align it closer to a particular timing scale—sixteenth notes, for example. This alignment, called quantization, is useful for correcting small timing errors. You can choose 100% quantization, which yields absolute correction or only partial quantization, which preserves a certain amount of the original fluctuation—for a more natural-sounding, “human” result.

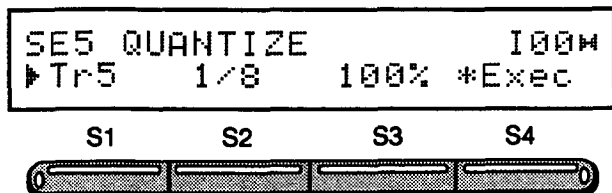

Menu Key	Field	Field Type & Possible Settings	Destination
S1	Track number	Tr5 -8/T5-8	The track to edit.
S2	Resolution	1/4 /1/4T 1/8 /1/8T 1/16 /1/16T 1/32 /1/32T	Timing interval for aligning the data. The letter "T" after a selection denotes triplets. The selections range from quarter notes to 32nd note triplets.
S3	Amount	25 -100%	Scaling factor for the QUANTIZE function. The smaller this percentage, the greater the amount of natural-sounding fluctuation that remains. One application is to use weak quantization with a triplet resolution to create a swing effect.
S4	EXECUTE command	*Exec	Command to make the change.

Procedure:

*Note: Before starting, make a backup copy of the pattern in the SONG COPY (SP7) page. The changes are irreversible, so it is always a good idea to have a spare copy “just in case”—especially for partial quantization, where achieving the right balance between correction and naturalness can take several tries.*

1. Use the SONG SELECT (SE1) page to select the song.
2. Use the [PAGE>] key to select the QUANTIZE (SE5) page.

3. Select the track or tracks.

Use the [S1] soft key or the [<CURSOR] and [CURSOR>] keys to select the first menu item.

Use the [+ /YES] and [- /NO] keys or the [DATA ENTRY] dial to change the field value.

4. Select the resolution.

Usually a relatively fine resolution—sixteenth or 32nd notes—gives the best results.

Use the [S2] soft key or the [<CURSOR] and [CURSOR>] keys to select the second menu item.

Use the [S2] soft key, [+ /YES] and [- /NO] keys or the [DATA ENTRY] dial to change the resolution.

5. Select the scaling factor.

Use the [S3] soft key or the [<CURSOR] and [CURSOR>] keys to select the third menu item.

Use the [+ /YES] and [- /NO] keys or the [DATA ENTRY] dial to change the field value.

(Although the normal choice is 100%, weak quantization in the 25% to 40% range sometimes provides correction while still leaving natural-sounding timing variations. )

6. Quantize.

Use the [S4] soft key (\*Exec) to execute the command.

Answer the question Sure? (Y/N) with either the [+ /YES] key to proceed or the [- /NO] key to cancel. You may also use the [EXIT] key to cancel.



# PATTERN and SONG Modes

## Special Case of Using the QUANTIZE Function with the RANGE Function

When the RANGE function is ON, only the notes played within the range will be affected by the QUANTIZE function. But if the beginning and end point of the RANGE are not set carefully, undesirable results can occur.

For example, take a look at the figure below. If we want to quantize a note played at sequencer position 1: 2: 40 to quarter note resolution, but the range begins at 1: 2: 12, the note will be moved to the beginning of the range (1: 2: 12) and not to the second beat (1: 2: 0).

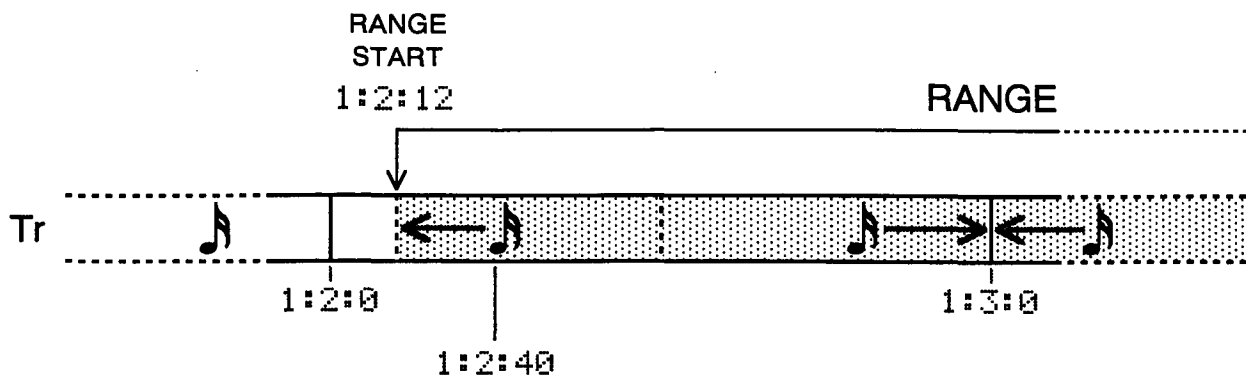

Always take great care in setting the range in accordance with your quantize resolution.

Furthermore, song track quantization can not properly quantize MIDI control data. Therefore, pitch bend and

note information and the like may become mixed and produce strange results. To avoid such undesirable consequences, use the following procedure to correctly quantize events.

# PATTERN and SONG Modes

## Procedure for Correctly Quantizing a Song Track With Complex Event Data

Note: Please refer to 3.4.6 TRACK EDIT, 3.4.7 TRACK ERASE and 3.4.8 TRACK PASTE for detailed instructions on how to copy, paste and erase song track data.

1. Copy the original track to a fresh track, the copy.

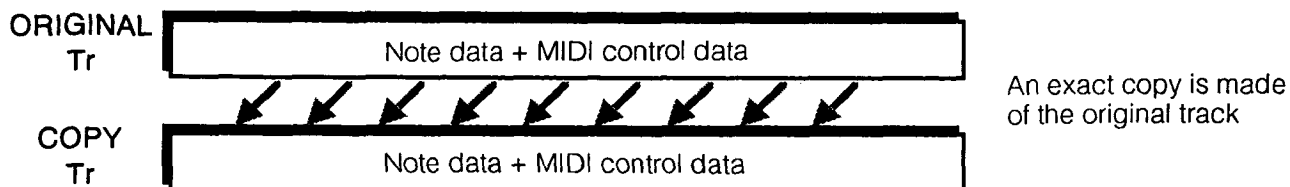

2. Erase the copy track's All Note data and erase all the original track's MIDI event data—C-Change, P-Change, Bender, Pres data.

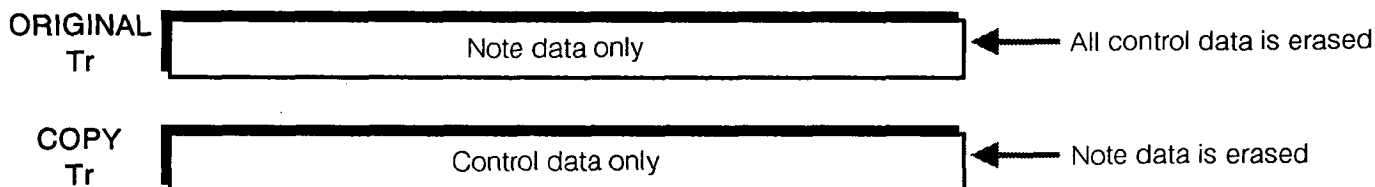

3. Quantize the original track.

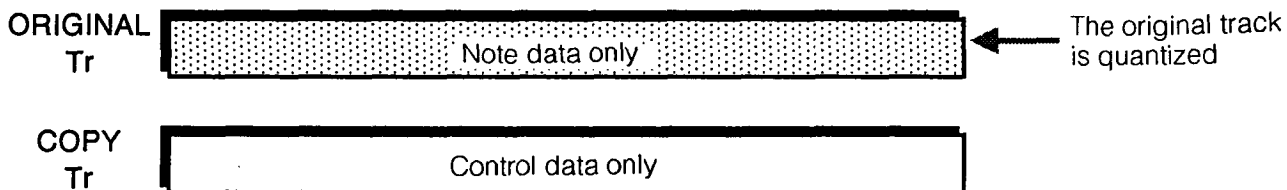

4. Bounce the copy track on to the original track.

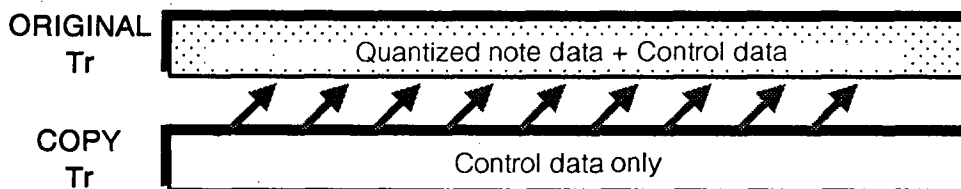

5. Erase the copy track.

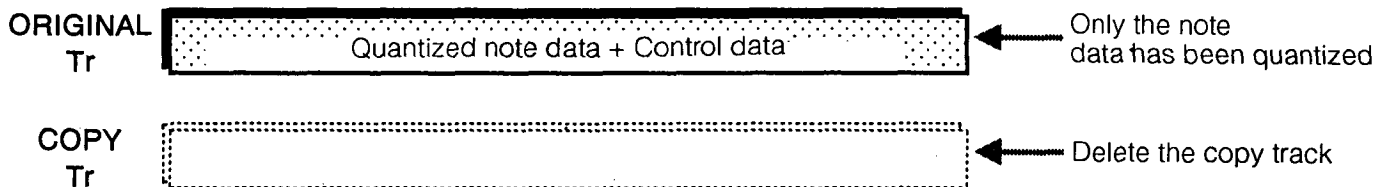

# PATTERN and SONG Modes

## 3.4.6 TRACK EDIT (SE6) Page

This page is for inserting or deleting a particular track, all tracks or a particular range of tracks. All the editing operations apply to the range specified in the SONG RANGE (SE2) page. To use the TRACK EDIT (SE6) page, the RANGE function must be on.

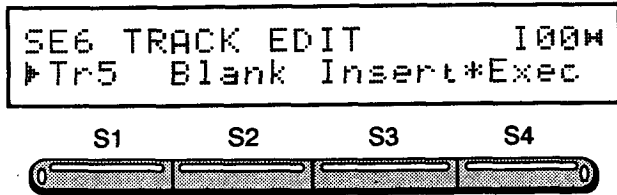

Menu Key	Field	Field Type & Possible Settings	Destination
S1	Track	Tr5-8/T5-8	The track to edit.
S2 S3	Function	Blank Insert/ Delete	Editing operation to be performed (Blank Insert or Delete).
S4	EXECUTE command	*Exec	Command to make the change.

### INSERT Function

This function inserts blank measures, as set in the SONG RANGE (SE2) page, into the song. This is done by inserting blank measures where the range was

specified, thereby shifting the preexisting data immediately following the range start point to the end of the blank range.

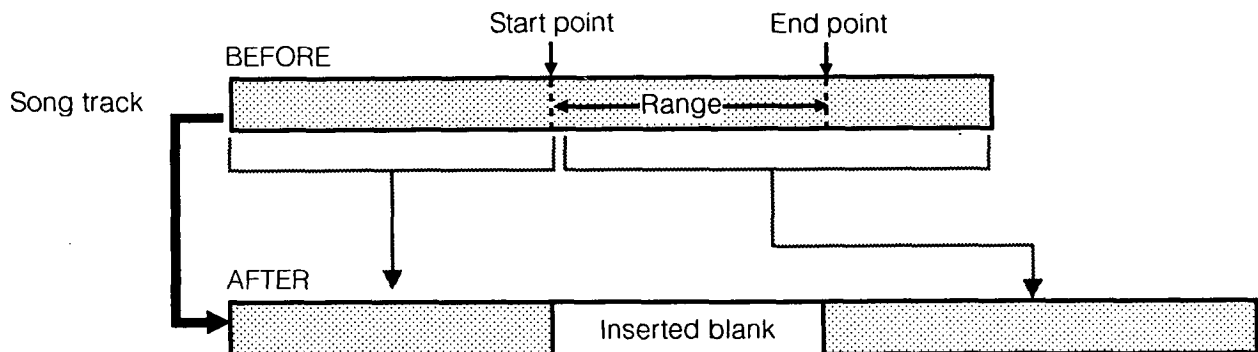

Procedure:

1. Use the SONG RANGE (SE2) page to specify the range to be inserted as a pair of starting and end points. The RANGE function must be ON.
2. Use the [PAGE>] key to select the TRACK EDIT (SE6) page.
3. Select the track or tracks.

Use the [S1] soft key or the [<CURSOR] and CURSOR>] keys to select the first menu item.

Use the [+ / YES] and [- / NO] keys or the [DATA ENTRY] dial to change the field value.

4. Select the INSERT function.

Use the [S2] soft key or the [<CURSOR] and CURSOR>] keys to select the second menu item.

Use the [+ / YES] and [- / NO] keys or the [DATA ENTRY] dial to change the field value.

5. Insert.

Use the [S4] soft key (\*Exec) to execute the command.

Answer the question Sure? (Y/N) with either the [+ / YES] key to proceed or the [- / NO] key to cancel. You may also use the [EXIT] key to cancel.

# PATTERN and SONG Modes

## DELETE Function

This function deletes everything in the range and shifts all data after the deletion point forward.

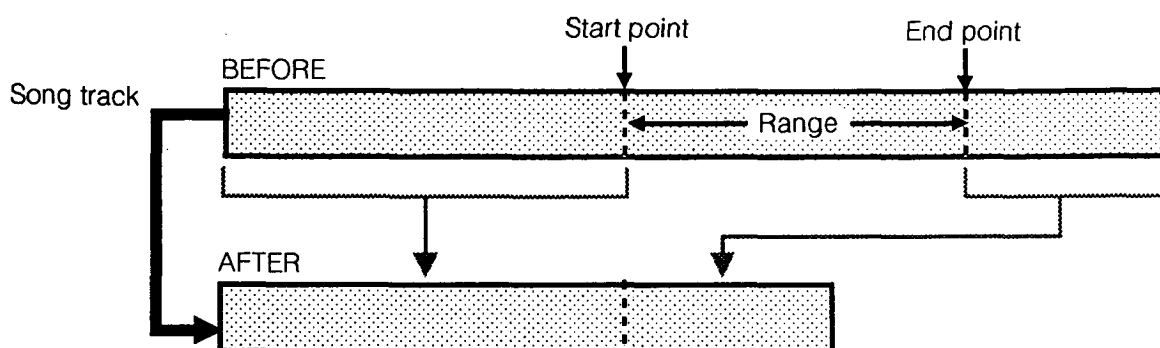

### Procedure:

1. Use the SONG RANGE (SE2) page to specify the range to be deleted as a pair of starting and end points. If the RANGE function is OFF, the whole track is deleted.

2. Use the [PAGE>] key to select the TRACK EDIT (SE6) page.

3. Select the track or tracks.

Use the [S1] soft key or the [<CURSOR] and [CURSOR>] keys to select the first menu item.

Use the [+ / YES] and [- / NO] keys or the [DATA ENTRY] dial to change the field value.

4. Select the DELETE function.

Use the [S2] soft key or the [<CURSOR] and [CURSOR>] keys to select the second menu item.

Use the [+ / YES] and [- / NO] keys or the [DATA ENTRY] dial to change the field value.

5. Delete.

Use the [S4] soft key (\*Exec) to execute the command.

Answer the question *Sure? (Y/N)* with either the [+ / YES] key to proceed or the [- / NO] key to cancel. You may also use the [EXIT] key to cancel.

# PATTERN and SONG Modes

## 3.4.7 TRACK ERASE (SE7) Page

This page is for erasing specific types of data—notes or program changes, for example—from a particular song track or all song tracks (5 ~ 8).

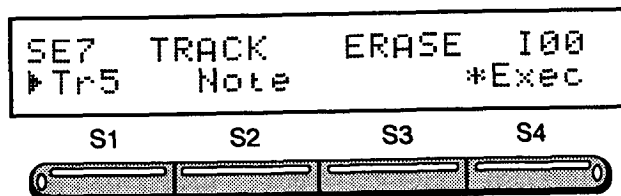

Menu Key	Field	Field Type & Possible Settings	Destination
S1	Track number	Tr5 -8 / T5-8	The track to edit. <i>(Note: The setting T5-8 selects all four song tracks.)</i>
S2 S3	Data type	Note/AllNote/ P-Change/ C-Change/ Pres/ Bender/ AllData	Type of data to erase: Note : All occurrences of a particular MIDI note number—that is, touchpad or keyboard key—in the range. AllNote : All note data in the range. C-Change : All control data in the range. P-Change : All program change data in the range. Bender : All pitch bend data in the range. Pres : All aftertouch data (channel pressure and polyphonic key pressure) in the range. AllData : All data in the range.
S4	EXECUTE command	*Exec	Command to make the change.

Procedure:

1. Use the SONG RANGE (SE2) page to specify the range to be erased as a pair of starting and end points. When the RANGE function is OFF, the whole track is selected.
2. Use the [PAGE>] key to select the TRACK ERASE (SE7) page.
3. Select the track.

Use the [S1] soft key or the [<CURSOR] and [CURSOR>] keys to select the first menu item.

Use the [+ / YES] and [- / NO] keys or the [DATA ENTRY] dial to change the track selection.

4. Select the data type—for example, All Data, which erases all data.

Use the [S2] soft key or the [<CURSOR] and [CURSOR>] keys to select the second menu item.

Use the [+ / YES] and [- / NO] keys or the [DATA ENTRY] dial to change the type of data.

5. Erase data.

Use the [S4] soft key (\*Exec) to erase data.

Answer the question Sure? (Y/N) with either the [+ / YES] key to proceed or the [- / NO] key to cancel. You may also use the [EXIT] key to cancel.

*Note: For data type Note, there is an intervening step—namely, specifying the note or notes to erase. If there is more than one, hold down the corresponding key or touchpad for one note and press the keys and touchpads for the others. The confirmation page appears when the last key or touchpad is released.*

# PATTERN and SONG Modes

## 3.4.8 TRACK PASTE (SE8) Page

This page is for pasting data from the source, one song track or a particular range in a song track and inserting, copying or bouncing it somewhere in another track, the destination. The paste operation uses the range specified in the SONG RANGE (SE2) page.

```
SE8 TRACK PASTE      I00M
▶Tr5 -> Tr6  Ins  <Past>
```



Menu Key	Field	Field Type & Possible Settings	Destination
S1	Source track	Tr5 -8	Number of the track with the data to be copied.
S2	Destination track	Tr5 -8	Number of the track to receive the data.
S3	Paste function action	Ins /COPY /Boun	Type of track paste function to perform: insert (Ins ), overwrite (COPY ) or merge (Boun ).
S4	PASTE submenu	<Past>	Submenu to specify the position at which to insert data in the destination track.

### PASTE (Past) Submenu

This page is for specifying the location to insert the data in the destination track.

```
DST Location Tr5 ->Tr6 ±
[▶ 1: 1: 0] *Exec
```



Menu Key	Field	Field Type & Possible Settings	Destination
S1 S2 S3	Location	[ : : ]	Position in song (bars, beats and ticks).
S4	Execute command	*Exec	Command to make the change.

Procedure:

1. Use the SONG RANGE (SE2) page to specify the range to be copied as a pair of starting and end points. When the RANGE function is OFF, the whole track is selected.

2. Use the [PAGE>] key to select the TRACK PASTE (SE8) page.

3. Select the source track.

Use the [S1] soft key or the [<CURSOR] and [CURSOR>] keys to select the first menu item.

Use the [+ /YES] and [- /NO] keys or the [DATA ENTRY] dial to change the field value.

4. Select the destination track.

Use the [S2] soft key or the [<CURSOR] and [CURSOR>] keys to select the second menu item.

Use the [+ /YES] and [- /NO] keys or the [DATA ENTRY] dial to change the field value.

5. Select the type of track paste function to perform: insert (Ins), overwrite (Copy) or merge (Boun).

6. Switch to the PASTE submenu.

Use the [S4] soft key to display the submenu.

7. Specify, in bars, beats and ticks, the point at which to insert the track copy in the destination track. Use the [S1], [S2], [S3] soft keys and the [<CURSOR] and [CURSOR>] keys to move between subfields.

8. Paste.

Use the [S4] soft key (\*Exec) to paste the track.

Answer the question Sure? (Y/N) with either the [+ /YES] key to proceed or the [- /NO] key to cancel. You may also use the [EXIT] key to cancel.

# PATTERN and SONG Modes

## Example of Insert

As shown below, the INSERT function places a copy of the specified range of the source track at a specific location in the destination track. As its name implies, the new data is inserted at the location, thus pushing the preexisting destination track's data to the end of the new data. The source track's data is in no way affected.

```
SE8 TRACK PASTE      I00M
▶Tr5 -> Tr6  Ins  <Copy>
```

```
DST Location Tr5 ->Tr6 ▲
[▶ 1: 2: 0]      *Exec
```

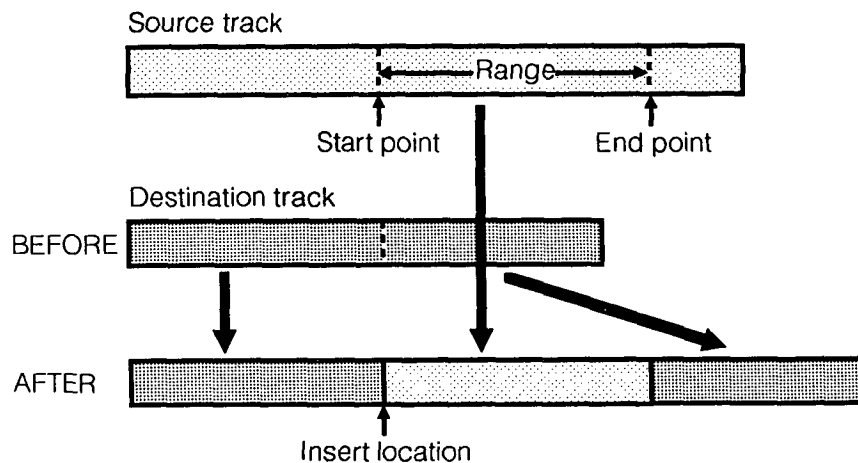

## Example of Copy

As shown below, the COPY function replaces a portion of the destination track at a starting location with a specified range from the source track. As its name implies, the new data is overwritten at the location, thus erasing the destination track's preexisting data for that range. The source track's data is in no way affected.

```
SE8 TRACK PASTE      I00M
▶Tr5 -> Tr6  COPY <Past>
```

```
DST Location Tr5 ->Tr6 ▲
[▶ 1: 2: 0]      *Exec
```

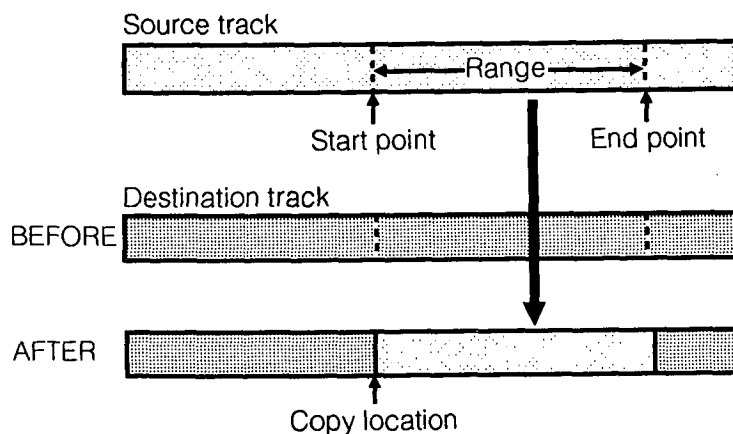

# PATTERN and SONG Modes

## Example of Bounce

As shown below, the BOUNCE function merges a portion of the destination track at a starting location with a specified range from the source track. The source track's data is combined at the location with the destination track's preexisting data to make a new two-layered section. The source track's data is in no way affected.

```
SE8 TRACK PASTE   I00M  
▶Tr5 -> Tr6 Boun <Paste>
```

```
DST Location Tr5 ->Tr6 ▲  
[▶ 1: 2: 0] *Exec
```

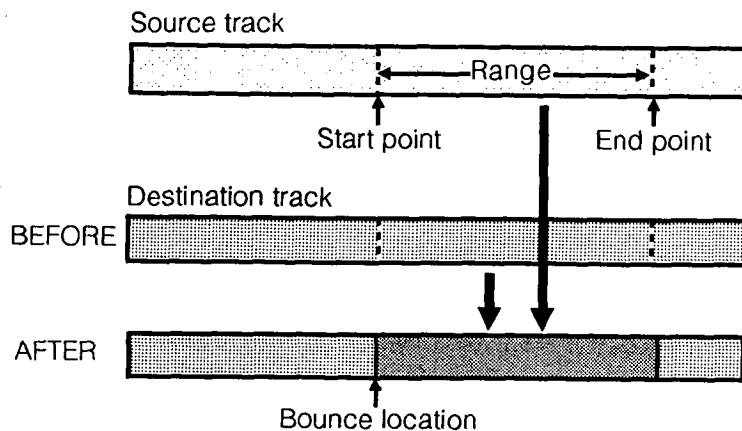



# PATTERN and SONG Modes

## Special Case— Insert/Copy/Bounce with the Same Source and Destination Track

When the source and destination track are the same, the Insert/Copy/Bounce location cannot be between the start of the song and the range's endpoint.

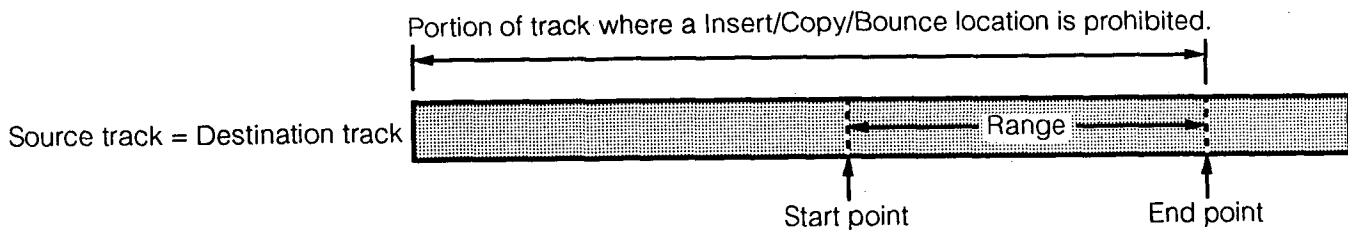

The following is a step-by-step way to achieve this by using a temporary track. By copying the contents of the original track into an unused temporary track, we now have two identical tracks to work with.

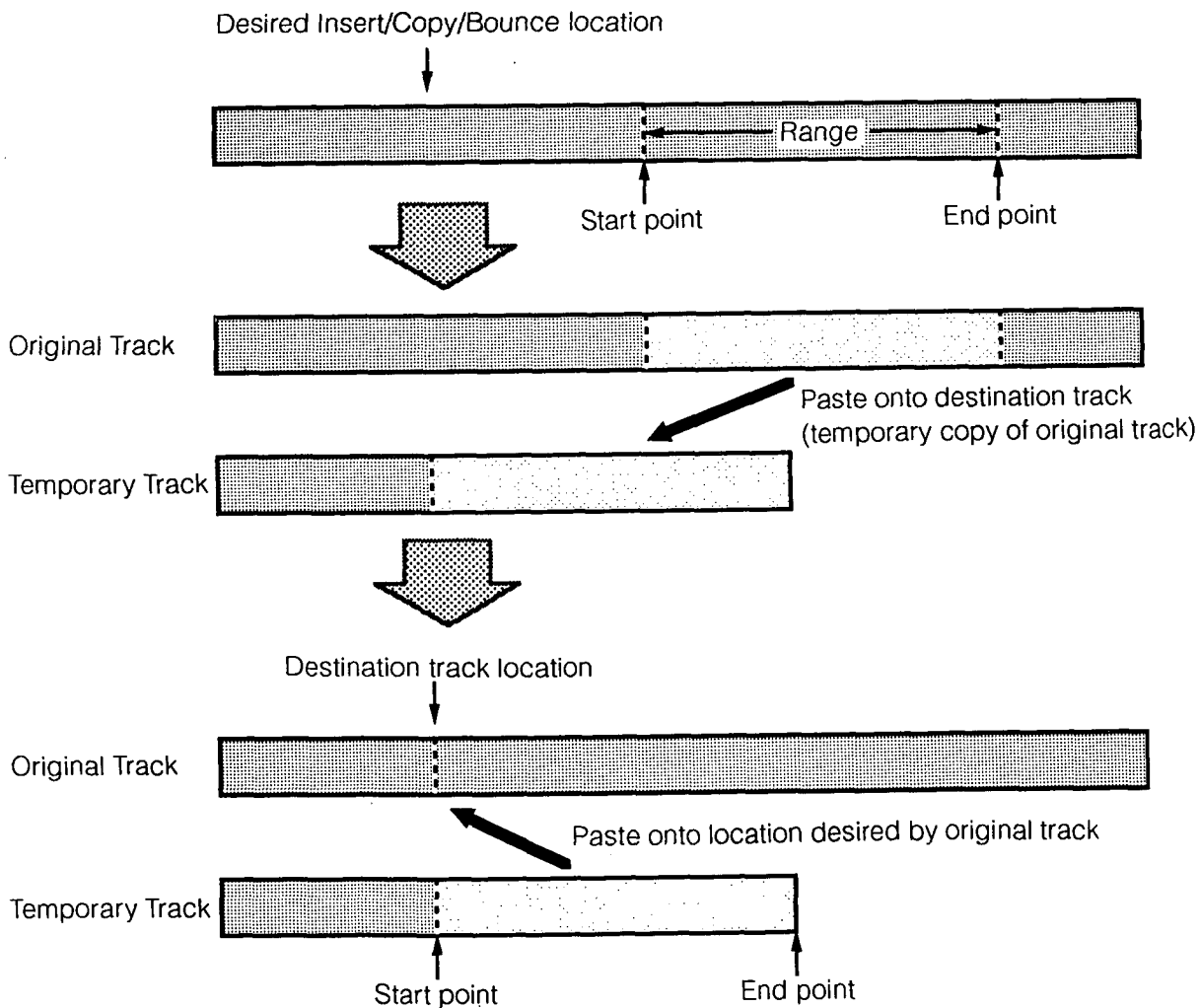

# PATTERN and SONG Modes

## 3.4.9 SONG CLEAR (SE9) Page

This page is for clearing either the current song or all songs from the memory. Cleared songs have their names reset to [\*Empty\*].

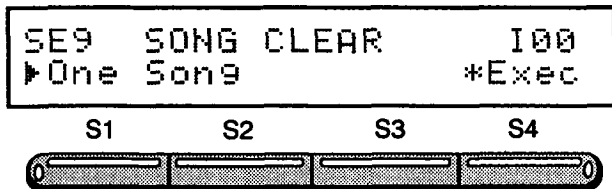

Menu Key	Field	Field Type & Possible Settings	Destination
	Selection	OneSong/ AllSongs	Choice of current song or all songs.
S4	EXECUTE command	*Exec	Command to make the change.

Procedure:

1. Select either the current song or all songs.

Use the [+ / YES] and [- / NO] keys or the [DATA ENTRY] dial to change the field value.

2. Clear song(s).

Use the [S4] soft key (\*Exec) to clear the song(s).

Answer the question Sure? (Y/N) with either the [+ / YES] key to proceed or the [- / NO] key to cancel. You may also use the [EXIT] key to cancel.

*Note: When All Songs is selected, the currently selected bank's (Int or Card) songs are cleared. The unchosen bank's songs, however, remain unchanged.*

# Chapter 4 Instrument Modes

The INSTRUMENT key provides two modes and one submode for editing timbre, instrument pad and drum kit settings: the TIMBRE and KIT modes and the PAD submode. This Chapter provides detailed descriptions of all displays for the three modes.

## 4.1 TIMBRE Mode

This mode is for editing instrument timbre (a.k.a. "voice" or "color"), the set of waveform parameters that the PCM sound sources use to generate notes for a particular percussion instrument. (In much the same way as a synthesizer generates notes for other instruments.) There are functions for, among other things, selecting the envelope, which controls the rate at which the sound peaks and fades and the modulation, which adds variation to the sound.

In the TIMBRE mode, the touchpads function differently from the other modes: all the touchpads access the same sound source, but form a rising chromatic scale, with touchpad 4 being the original pitch. Moreover, when in the TIMBRE mode, excluding sequencer play, there is no MIDI output when the pads are struck.

*Note: The preset timbres in the Pre bank are permanent and may not be edited on any page in the Timbre mode. To edit one of these timbres, use the TIMBRE COPY (T7) page to copy it to one of the other banks (Int or Card) and edit it there.*

### 4.1.1 TIMBRE SELECT (T1) Page

This page is for selecting the timbre to work with and editing the name attached the timbre.

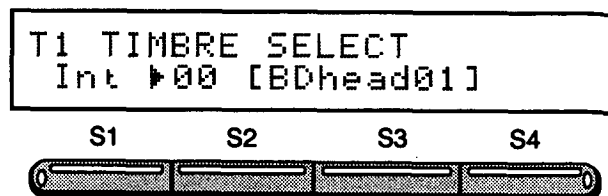

Menu Key	Field	Field Type & Possible Settings	Description
S1	Bank	Int/Card/Pre	Location of the timbre: Pre for the preset timbre bank (Note: The Pre timbres may not be edited.), Int for the internal bank of user-defined timbres or Card for the current bank on the RAM card. (Note: Use the SYSTEM mode's CARD (S12) page (see Chapter 9 SYSTEM Mode) to switch between the two banks on the RAM card.)
S2	Timbre number	00 -79	Number of the timbre.
S3	Timbre name	[            ]	Name assigned to the timbre. (Note: To edit the name, use the text editing procedures outlined in the description of the PATTERN PLAY/REC mode's PATTERN SELECT (PP1) page in Chapter 3 Pattern and Song Modes.)

# Instrument Modes

## 4.1.2 WAVEFORM ASSIGN (T2) Page

There are 75 waveforms built into the S3. (See chart of the S3's 75 Built-In Waveforms.) The two ROM card slots each allow the addition of 40 more. This page is for selecting the waveform for the timbre.

*Note: After changing ROM cards, always use this page to check the waveform assignments.*

```
T2 WAVEFORM ASSIGN
Int ▶00[BDhead01] Nom1
```

S1            S2            S3            S4



Menu Key	Field	Field Type & Possible Settings	Description
S1	Bank	Int/Card1 ~2	Location of the waveform.
S2 S3	Waveform number	Int:00 ~74 Card1/2:00 ~39	Number of the waveform. (Note: The name field to the right of this number changes automatically with this number.)
S4	NORMAL/REVERSE switch	Nom1/Revs	PCM mode: Nom1 for normal playback and Revs for reverse playback. In the reverse mode, timbres with repeating waveforms (see chart below 3) do not repeat.

## Chart of the S3's 75 Built-In Waveforms

WF #	Waveform Name	WF #	Waveform Name	WF #	Waveform Name
00	BDhead01	25	SDshel06	50	CGslap01
01	BDhead02 *	26	SDshel07	51	TBhead01 *
02	BDhead03	27	CisdHH01	52	TBhead02 *
03	BDhead04	28	CisdHH02	53	TBhead03 *
04	BDhead05	29	OpenHH01 *	54	TBshel01 *
05	BDhead06	30	OpenHH02 *	55	TBshel02 *
06	BDhead07	31	PedIHH01	56	TBshel03 *
07	BDshel01	32	TMhead01 *	57	TBside01
08	BDshel02 *	33	TMhead02 *	58	H Clap01
09	BDshel03	34	TMhead03 *	59	CowBel01 *
10	BDshel04	35	TMhead04 *	60	Tambrn01
11	BDshel05	36	TMhead05	61	Agogo 01 *
12	SDhead01	37	TMshel01 *	62	Bongo 01
13	SDhead02	38	TMshel02 *	63	Bongo 02 *
14	SDhead03	39	Crash 01 *	64	Maraca01
15	SDhead04	40	E Ride01 *	65	Cabasa01
16	SDhead05	41	B Ride01 *	66	Cabasa02
17	SDhead06	42	SidStk01	67	Shaker01
18	SDhead07	43	Stick 01	68	PotCover *
19	SDhead08	44	CGhead01 *	69	SynBas01 *
20	SDshel01	45	CGhead02 *	70	Wave 01 *
21	SDshel02	46	CGshel01 *	71	Wave 02 *
22	SDshel03	47	CGshel02 *	72	Wave 03 *
23	SDshel04	48	CGpalm01	73	Wave 04 *
24	SDshel05	49	CGmute01	74	Wave 05 *

Timbres with repeating waveforms are indicated by a \* mark.

# Instrument Modes

## 4.1.3 ENVELOPE (T3) Page

This page is for defining the envelope—that is, the relationship between loudness and time. The page also contains a switch for the Sustain function, which determines whether the envelope generator ignores (OFF) or acts on (ON) the MIDI NOTE OFF event for the note—that is, whether holding down a key or touchpad produces a note of the same length or a longer one.

This envelope is defined as a graph (See *8 Point ADSR* below). With an origin at zero and up to eight points, each of which has associated with it two values: the level at the end of the interval between that point and the preceding one and the rate at which the envelope rises or falls to that level from the level at the beginning of the interval. The higher the rate (also called "slope"), the faster the level change and the shorter the time interval.

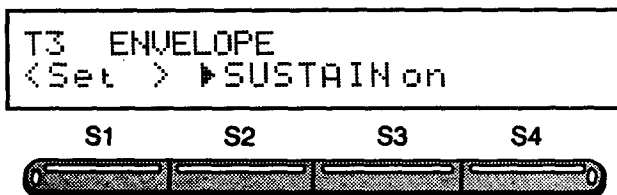

Menu Key	Field	Field Type & Possible Settings	Description
S1	SET submenu	<Set >	Submenu for setting envelope data points.
	ON/OFF switch	SUSTAINon/ SUSTAINoff	Sustain function switch governing the connection between key release (MIDI NOTE OFF event) and the sustain point: <b>ON</b> : The envelope generator pauses, if necessary, at the sustain point level until the key is released. <b>OFF</b> : The envelope generator ignores NOTE OFF events and treats the sustain point as just another envelope data point.

## SET Submenu

This page is for setting envelope data points.

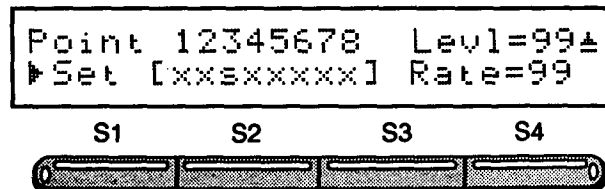

Menu Key	Field	Field Type & Possible Settings	Description
S1	Function selection field	Set/End/Sus	Choice of three functions: Edit data point levels and rates (Set), shift the end and thus make the envelope shorter or longer (End) or shift the sustain point left or right (Sus). (Note: If the Sustain function is off, the Sus choice cannot be made.)
S2 S3	Point indicators	[ ]	Point type: s (sustain), x (regular) or _ (blank — unused).
S4	Rate and level	Lev1=0 -99/ Rate=0 -99	Rate and level settings for the current data point.

*Note: This page uses the [S2] and [S3] soft keys as alternates for the [<CURSOR] and [CURSOR>] keys, respectively, for selecting the current data point. This point is indicated by the non-blinking block cursor in the point indicator field, the middle field on the lower line of the display.*

### Procedure:

1. Switch to the SET submenu.

Use the [S1] soft key to display the submenu.

2. Adjust the number of data points with the End function—4, for example.

# Instrument Modes

```
Point 12345678  Lev1=12▲
▶End [x s x x] ] Rate=96
```

S1            S2            S3            S4



Use the [S1] soft key to select the first menu item.

Use the [+ / YES] and [- / NO] keys or the [DATA ENTRY] dial to change the field value.

Use the [S2], [S3], [<CURSOR] and [CURSOR>] keys to shift the block cursor within the point indicator field.

3. Select the sustain point with the Sus function.

```
Point 12345678  Lev1=35▲
▶Sus [x x x] ] Rate=96
```

S1            S2            S3            S4



Use the [S1] soft key to select the first menu item.

Use the [+ / YES] and [- / NO] keys or the [DATA ENTRY] dial to change the field value.

Use the [S2], [S3], [<CURSOR] and [CURSOR>] keys to shift the block cursor with the s inside within the point indicator field.

4. Select a data point with the Set function.

```
Point 12345678  Lev1=99▲
Set [x x x] ] ▶Rate=99
```

S1            S2            S3            S4



Use the [S1] soft key to select the first menu item.

Use the [+ / YES] and [- / NO] keys or the [DATA ENTRY] dial to change the field value.

Use the [S2], [S3], [<CURSOR] and [CURSOR>] keys to shift the block cursor within the point indicator field.

5. Edit the rate and level fields.

Use the [S4] soft key to select the second and third menu items. Alternate presses of the [S4] soft key switch the cursor between the level and rate fields.

Use the [+ / YES] and [- / NO] keys or the [DATA ENTRY] dial to change the field value.

6. Repeat the preceding two steps for each data point.

7. Press the [EXIT] key to return to the T3 page.

# Instrument Modes

**Example:** The previous procedure outlined a 4-point ADSR (Attack-Decay-Sustain-Release curve). The S3 allows envelopes to be defined as having up to eight points. The following envelope consists of eight data points.

## 8 Point ADSR

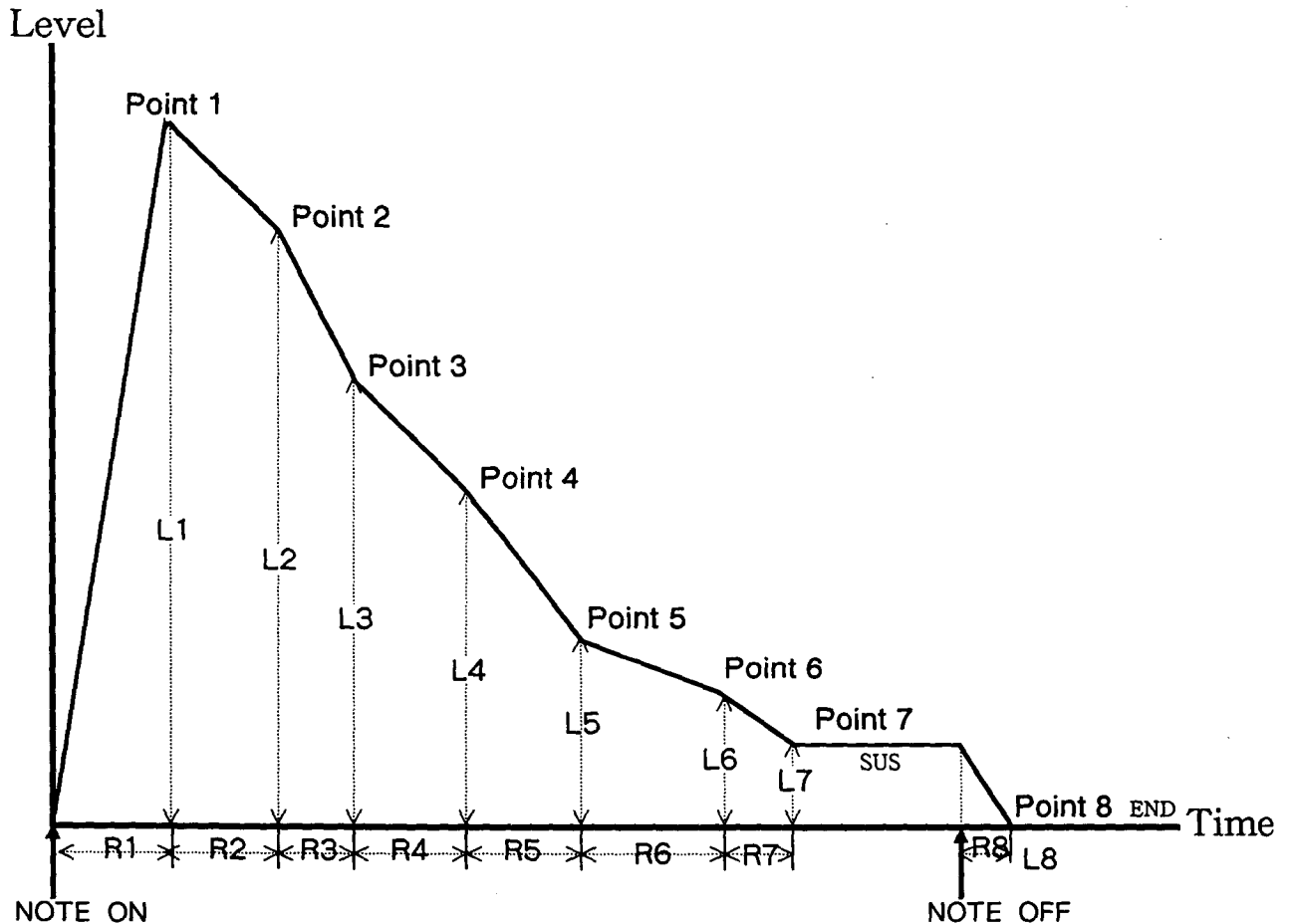

*Note: For the first data point, the preceding data point is defined as the origin because the envelope curve always starts at level 0. The length of the interval between two data points depends not only on the rate, but also on whether or not the attack or decay time is being modulated. If the level at the final data point is zero, the rate determines how fast the sound fades out. If the level is not zero, however, the output remains at that level infinitely.*

*One of these points may be chosen as the sustain point, the point at which the envelope generator pauses if the Sustain switch is ON and the NOTE OFF event is still pending.*

# Instrument Modes

## 4.1.4 AUTO BEND (T4) Page

This page controls the AUTO BEND function, a time-dependent shift in pitch. This function is especially effective with such instruments as cymbals and toms.

```
T4 AUTO BEND Pitch Rate
▶Off      0      0
```

S1            S2            S3            S4



Menu Key	Field	Field Type & Possible Settings	Description
S1	ON/OFF switch	On/Off	Master switch for the AUTO BEND function.
S2	Target pitch	-36 +36	Size, in semitones and direction (+/-) of the pitch shift. (Note: The limit is 36 semitones or three octaves in either direction.)
S4	Rate	0-99	Speed at which pitch shifts. The higher this number, the faster the pitch change.

*Note: Although the maximum allowed pitch shift is three octaves up or down, a previously set transposition value chosen on the MONITOR (T6) page's TUNE submenu may alter the three octave limit.*

## 4.1.5 MODULATION (T5) Page

This page controls the type and amount of modulation added to the timbre. Here modulation refers to the use of one type of MIDI data, the source, to modify another, the destination. There are five sources—pitch bender, modulation wheel, note number, velocity and pressure (aftertouch)—and fourteen source-destination combinations available. (See Modulation Combination Chart.)

```
T5 MODULATION Depth
01:Pitch<Bender=Off 0
```

S1            S2            S3            S4



Menu Key	Field	Field Type & Possible Settings	Description
S1 S2	Combination number	01-14	Number of the combination. (Note: The name field to the right of this number changes automatically with this number.)
S3	ON/OFF switch	On/Off	Master switch for the MODULATION function.
S4	Depth	-50 +50 (-120 +120 for Pitch)	Size and direction of the effect. The larger this number, the greater the modulation. The sign portion allows the timbre to reverse the direction of the effect—so that pushing the PITCH BEND lever on a synthesizer produces a downward pitch bend instead of an upward one, for example. When the destination is pitch, a difference in depth of 10 units corresponds to one semitone.



# Instrument Modes

## Modulation Combinations Available

	Destination	Source	
01	Pitch	Bend	The pitch varies with the position of the PITCH BEND lever (or wheel).
02	Pitch	Whel	The pitch modulation depth varies with the position of the modulation wheel.
03	Pitch	Pres	The pitch varies with the aftertouch.
04	Level	Whel	The output level varies with the position of the modulation wheel.
05	Level	Pres	The output level varies with the aftertouch.
06	Level	Note	The output level varies with the note number.
07	AtkLevi	Velo	The attack level (point #1) varies with the velocity—so that stronger keystrokes have louder (+) or quieter (-) attack levels.
08	AtkRate	Velo	The attack rate (point #1) varies with the velocity—so that stronger keystrokes have shorter (+) or longer (-) attack rates.
09	DecRate	Note	The decay rate (after point #2) varies with the note number—so that higher notes have faster decay rates, for example.
10	DecRate	Velo	The decay rate (after point #2) varies with the velocity—so that stronger keystrokes have faster decay rates, for example.
11	AutoPch	Note	The pitch on the AUTO BEND (T4) page varies with the note number—so that higher notes have more pitch bend, for example.
12	AutoPch	Velo	The pitch on the AUTO BEND (T4) page varies with the velocity—so that stronger keystrokes have more pitch bend, for example.
13	AutoRat	Note	The rate on the AUTO BEND (T4) page varies with the note number—so that higher notes exhibit a faster (+) or slower (-) pitch bend effect, for example.
14	AutoRat	Velo	The rate on the AUTO BEND (T4) page varies with the velocity—so that stronger keystrokes exhibit a faster (+) or slower (-) pitch bend effect, for example.

*Note: The aftertouch is the amount of pressure applied to a key after the key has been pressed.*

*Note: The note number gives the pitch of the note. The higher the number, the higher the pitch.*

*Note: You must turn the AUTO BEND (T4) page's auto bend function on for modulation combinations 11 ~ 14 to take effect.*

*Note: Because the maximum allowed pitch shift is three octaves up or down, the effect of modulation combinations 01 ~ 03 may vary.*

# Instrument Modes

## 4.1.6 MONITOR (T6) Page

This page and its two submenus control the tuning and output level of the timbre monitor.

*Note: These settings are not stored with the timbre. They remain in effect only in the TIMBRE mode. The effect number, for example, is overridden by the EFFECT submenu in the SONG PLAY/REC mode's SONG SETTING (SP2) page.*

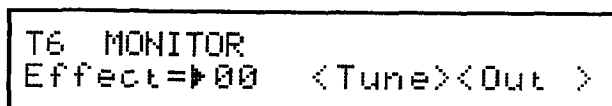

Menu Key	Field	Field Type & Possible Settings	Description
	Effect number	Effect=00 -15	Effect to use while editing the timbre.
S3	TUNE submenu	<Tune>	Submenu for tuning the timbre.
S4	OUT submenu	<Out >	Submenu for routing the timbre output and setting the level.

### TUNE Submenu

This page is for tuning the timbre—first in semitones and then in smaller units called cents.

*Note: These settings are not stored with the timbre. They remain in effect only in the TIMBRE mode.*

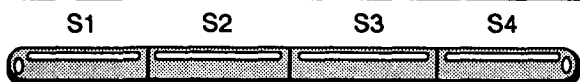
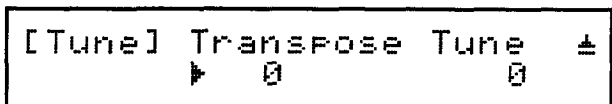

Menu Key	Field	Field Type & Possible Settings	Description
S2	Transposition value	-24 ~+24	Size, in semitones and direction (+/-) of the transposition. (Note: The limit is 24 semitones or two octaves in either direction.)
S4	Tuning value	-99 ~+99	Size, in cents and direction (+/-) of the tuning. (Note: The limit is 99 cents in either direction.)

Procedure:

1. Use the standard menu procedures.
2. Press the [EXIT] key to return to the T6 page.

### OUT Submenu

This page is for routing the timbre output to the stereo OUTPUT pair of jacks, one of the four MULTI OUT jacks, one of the two effect routings or a combination of the first with either the second or the third. It also sets the output level.

*Note: These settings are not stored with the timbre. They remain in effect only in the TIMBRE mode.*

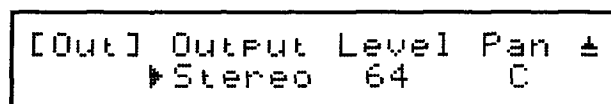

Menu Key	Field	Field Type & Possible Settings	Description
S2	Output routing	Stereo/ Multi1 -4/ Effect1 -2/ ST+M1/ST+M2/ ST+M3/ST+M4/ ST+E1/St+E2	Destination for the output: stereo OUTPUT jacks (Stereo or ST), a MULTI OUT jack (Multi1 (M1) - Multi4 (M4)), an effect send routing with Effect1 (E1) or Effect2 (E2) or a combination thereof.
S3	Level	1 -99	Output level control.
S4	Pan setting	R15 -C -L15	Stereo position: choice of 31 positions from R15 (right only) through C (center) to L15 (left only). (Note: This setting applies only to the stereo OUTPUT jacks.)

Procedure:

1. Use the standard menu procedures.
2. Press the [EXIT] key to return to the T6 page.

# Instrument Modes

## 4.1.7 TIMBRE COPY (T7) Page

This page is for copying the current timbre (the source) to another timbre (the destination) in the user timbre bank or a RAM card, where it may be edited.

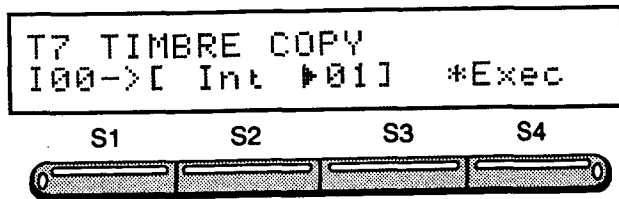

Menu Key	Field	Field Type & Possible Settings	Description
	Source	P00 ~79/ I00 ~79/ C00 ~79	Bank and timbre number for current timbre. (Note: This field is for display purposes only.)
S2	Destination bank	Int/Card	Location of the timbre to receive the copy.
S3	Destination timbre number	00 ~79	Number of the timbre to receive the copy.
S4	EXECUTE command	*Exec	Command to make the change.

Procedure:

1. Use the TIMBRE SELECT (T1) page to select the source timbre.
2. Use the [PAGE>] key to select the TIMBRE COPY (T7) page.
3. Select the destination bank.

Use the [S2] soft key or the [<CURSOR] and [CURSOR>] keys to select the second menu item.

Use the [+ / YES] and [- / NO] keys or the [DATA ENTRY] dial to change the field value.

4. Select the destination number.

Use the [S3] soft key or the [<CURSOR] and [CURSOR>] keys to select the third menu item.

Use the [+ / YES] and [- / NO] keys or the [DATA ENTRY] dial to change the field value.

5. Copy the timbre.

Use the [S4] soft key (\*Exec) to copy the timbre.

Answer the question Sure? (Y/N) with either the [+ / YES] key to proceed or the [- / NO] key to cancel. You may also use the [EXIT] key to cancel.

## 4.2 KIT Mode

This mode is for editing drum kits, the timbre combinations that the S3 uses to produce notes from touchpad strokes or their equivalents from sequencer playback or MIDI messages. Each kit consists of a name (for reference purposes only) and up to 16 percussion instruments assigned in two banks of eight to the touchpads.

*Note: The current instrument pad number appears in brackets in the upper right corner of all pages in the KIT mode and the PAD EDIT submenu but not on sub-menus. When it does, the touchpads change the pad number and the [PAD BANK/TEMPO] key switches pad banks.*

*Note: The S3 provides two internal banks of 10 drum kits each. One bank (Pre) is factory programmed and cannot be changed. The other (Int) is for storing user-defined drum kits.*

### 4.2.1 KIT SELECT (K1) Page

This page is for selecting the drum kit to be edited with the KIT mode and PAD submenu.

*Note: The current drum kit selection remains valid through all pages in the KIT mode and PAD submenu.*

The first two fields determine the two-character designation for the kit. This designation, which appears next to the three-character instrument pad designation in the upper right corner of all pages in the KIT mode and of the main pages in the PAD mode, consists of a single letter (P, I or C) for the bank plus a digit (0-9) for the kit number.

*Note: When the drum kit and instrument pad designations are on the screen, the pad number changes with each touch of a different touchpad.*

The third field is the name assigned to the drum kit; the fourth, the entrance to the PAD mode, the pages for editing the individual pads (percussion instruments) making up the drum kit.

*Note: The built-in drum kits in the Pre bank are permanent and may not be edited in the KIT mode's pages. To edit one of these drum kits, use the KIT COPY (K7) page to copy it to one of the other banks (Int or Card) and edit it there.*

# Instrument Modes

```
K1 KIT SELECT      I0[P01]
Int ▶0 [Demokit1]<PAD >
```



Menu Key	Field	Field Type & Possible Settings	Description
S1	Bank	Pre/Int/Card	Location of the drum kit: Pre for preset drum kits, Int for user-defined drum kits or Card for a RAM card.
S2	Drum kit number	0-9	Number of the drum kit to be edited.
S3	Drum kit name	[ ]	Name assigned to the drum kit. (Note: This text field changes automatically with the number, but may be edited— unless it is in the Pre bank.)
S4	PAD submenu	<PAD >	Submenu for accessing the PAD mode for editing the pads in the drum kit.

Note: A RAM card can have up to two drum kit banks. Use the SYSTEM mode's CARD (S12) page to switch banks.

Note: To edit the name, use the text editing procedures outlined in the description of the PATTERN PLAY/REC mode's PATTERN SELECT (PP1) page in Chapter 3 Pattern and Song Modes.

Procedure:

1. Select the bank.

Use the [S1] soft key or the [<CURSOR] and [CURSOR>] keys to select the first menu item.

Use the [+ / YES] and [- / NO] keys or the [DATA ENTRY] dial to change the field value.

2. Select the drum kit number.

Use the [S2] soft key or the [<CURSOR] and [CURSOR>] keys to select the second menu item.

Use the [+ / YES] and [- / NO] keys or the [DATA ENTRY] dial to change the field value.

## 4.2.1.1 PAD Submode

While actually not directly available on the four function keys, the PAD submode appears as a submenu on the KIT SELECT (K1) page, the page for selecting the drum kit to be edited with the KIT and PAD modes. The PAD submode is for assigning and editing the timbres assigned to the touchpads in the current drum kit.

Each instrument pad can contain one or two timbres, each with its own pitch, touch response, note range and output assignments. Using two timbres instead of just one, in some cases, just adds extra depth to the sound. In other cases where the attacks (heads) and decays (shells) have been separated, you must use two timbres to reconstruct the sound or create new ones.

Note: A two-character designation for the current drum kit appears next to the three-character instrument pad designation in the upper right corner of all pages in the KIT mode and of the main pages in the PAD submode. This kit designation consists of a single letter (P, I or C) for the bank plus a digit (0-9) for the kit number. When the drum kit and instrument pad designations are shown in the page, the pad number changes with each touch of a different touchpad. Change drum kits with the Kit Select (K1) page.

Note: When the Pre bank is selected as a kit location, editing is prohibited. Copy preset kits to the Int or Card banks for editing purposes.

### 4.2.1.1.1 PAD NAME (P1) Page

This page is for editing the name assigned to the instrument pad.

```
P1 PAD NAME      I0[P01]
▶ [BassDrum]
```



Menu Key	Field	Field Type & Possible Settings	Description
	Pad name	[ ]	Name assigned to the instrument pad. (Note: This text field changes automatically with each touch of a different touchpad, but may be edited— unless it is in the Pre bank.)

Note: To edit the name, use the text editing procedures outlined in the description of the PATTERN PLAY/REC mode's PATTERN SELECT (PP1) page in Chapter 3 Pattern and Song Modes.

# Instrument Modes

## 4.2.1.1.2 TIMBRE SETUP (P2) Page

This page is for assigning timbres to the pad's two timbre slots, TimA and TimB.

*Note: When only one timbre is desired, use TimA and turn TimB off.*

*Note: If TimB has been turned off, its parameters cannot be edited on any of the PAD submode's pages.*

```
P2 TIMBRE SETUP I0[P01]
▶TimA Pre 04[BDhead05]
```



Menu Key	Field	Field Type & Possible Settings	Description
S1	Timbre slot	TimA/TimB	Selection of two timbre slots.
S2	Timbre bank	Pre/Int/Card/Off	Location of timbre to use (Int, Card Pre) or OFF to disable (this choice is found only under TimB).
S3	Timbre number	00-79	Number of timbre to use.
S4			

Procedure:

1. Select the slot.

Use the [S1] soft key or the [<CURSOR] and [CURSOR>] keys to select the first menu item.

Use the [+ / YES] and [- / NO] keys or the [DATA ENTRY] dial to change the field value.

2. Select the bank or Off to disable.

Use the [S2] soft key or the [<CURSOR] and [CURSOR>] keys to select the second menu item.

Use the [+ / YES] and [- / NO] keys or the [DATA ENTRY] dial to change the field value.

3. Select the timbre.

Use the [S3] soft key or the [<CURSOR] and [CURSOR>] keys to select the third menu item.

Use the [+ / YES] and [- / NO] keys or the [DATA ENTRY] dial to change the field value.

Repeat the above for the other slot.

5. Press the corresponding touchpad to hear the results.

## 4.2.1.1.3 PAD EDIT (P3) Page

This page provides access to four submenus for editing instrument pad characteristics.

*Note: These setting override those used to edit individual timbres in the TIMBRE mode.*

```
P3 PAD EDIT I0[P01]
<Tune><Bal ><Resp><Out >
```



Menu Key	Field	Field Type & Possible Settings	Description
S1	TUNE submenu	<Tune>	Submenu for tuning pads.
S2	BALANCE submenu	<Bal >	Submenu for adjusting balance between the two timbres.
S3	RESPONSE submenu	<Resp>	Submenu for editing timbre response.
S4	OUT submenu	<Out >	Submenu for routing output.

# Instrument Modes

## TUNE Submenu

This submenu is really two pages: one (Main) for tuning the combined output of the two timbre slots and another (A/B) for tuning the timbres relative to each other.

*Note: Use the [<PAGE] and [PAGE>] keys to switch between the two pages.*

*Note: Press the [EXIT] key to return to the P3 page.*

### TUNE MAIN Page

This page is for tuning the combined output of the two timbre slots—first in semitones and then in cents.

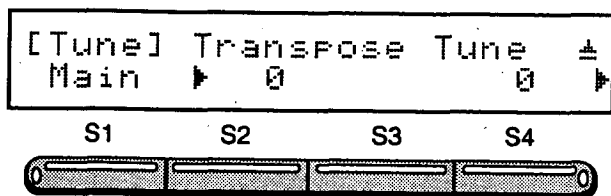

Menu Key	Field	Field Type & Possible Settings	Description
S2	Transposition value	-24 +24	Size, in semitones and direction (+/-) of the transposition. (Note: The limit is 24 semitones or two octaves in either direction.)
S4	Tuning value	-99 +99	Size, in cents and direction (+/-) of the tuning. (Note: The limit is 99 cents in either direction.)

### TUNE A/B Page

This page is for tuning the timbres assigned to the second timbre slot (TimB) relative to the first (TimA)—first in semitones and then in cents. It is accessed by pressing the [PAGE>] key from the TUNE submenu.

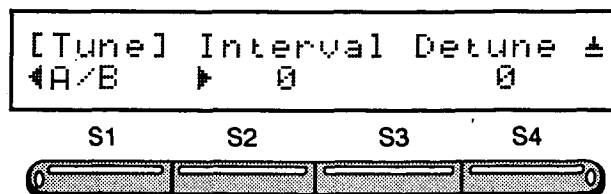

Menu Key	Field	Field Type & Possible Settings	Description
S2	Interval	-24 +24	Size, in semitones and direction (+/-) of the transposition. (Note: The limit is 24 semitones or two octaves in either direction.)
S4	Detune value	-50 +50	Size, in cents and direction (+/-) of the tuning. (Note: The limit is 50 cents in either direction.)

## BALANCE Submenu

This page is for altering the relative loudness between the timbres assigned to the two timbre slots. Increasing one timbre automatically decreases the other.

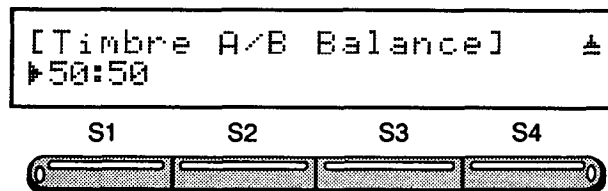

Menu Key	Field	Field Type & Possible Settings	Description
	Balance	01:99 -50:50 -99:01	Relative loudness between the two timbres.

*Note: Press the [EXIT] key to return to the P3 page.*

# Instrument Modes

## RESPONSE Submenu

This submenu is really two identical yet independent pages for adjusting the touch response curves of the timbres assigned to each timbre slot (TimA and TimB). (The touch response is the relationship between key velocity and output level.) Together they allow the creation of such effects as timbre switching, cross fading and timbre window. (See below.)

The first two fields in the page define the intersection of the two lines—that is, the threshold and the corresponding output level. The remaining two fields define the slopes of the graphs for the upper and lower velocity ranges. The larger this number, the greater the variation of output level with velocity.

The touch response curve consists of two straight-line graphs relating output to velocity for velocities above and below a reference velocity called the threshold. (See *Touch Response Curve* on following page.)

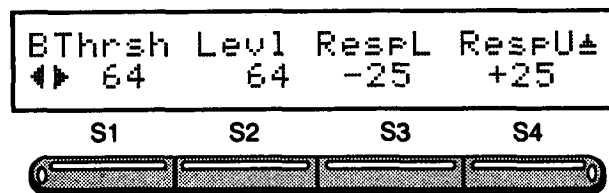
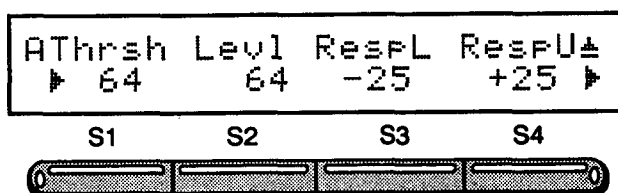

Menu Key	Field	Field Type & Possible Settings	Description
S1	Threshold	2~126	Dividing line between "upper" and "lower" velocities.
S2	Reference level	2~126	Output level at the threshold velocity. The S3 calculates all output levels for other velocities by extrapolating from the threshold output level and the slope.
S3	Response (lower)	-50 ~+50	Slope for lower half of the response curve. The slope relationship for the lower half follows a reverse output/slope relationship. Thus a negative slope increases the "fade in" effect, with -50 becoming sharply louder, -25 giving a 1:1 output and values between -1 and -24 giving a fade in starting from an output level greater than 0. A positive slope decreases output level to the threshold value, with values between 1 and +24 "fading down" to the threshold value "slowly," a value of +25 giving a 1:1 output and values between +25 and +50 giving a very quick "fade down" to the threshold value. (See <i>Touch Response Curve</i> .)
S4	Response (upper)	-50 ~+50	Slope for upper half of the response curve. The slope relationship for the upper half follows a normal output/slope relationship: negative slopes, producing "fade outs" to lower output levels and positive slopes increasing the output level to higher output levels. As above, a slope of -25 produces a decreasing 1:1 output and a slope of +25 produces an increasing 1:1 output. (See <i>Touch Response Curve</i> .)

Note: A slope of "0" makes output level independent of velocity—that is, fixed no matter what the striking force.

Note: Use the [**<**PAGE] and [PAGE**>**] keys to switch between the timbre A and B RESPONSE submenus. Press the [EXIT] key to return to the P3 page.

# Instrument Modes

## Touch Response Curve

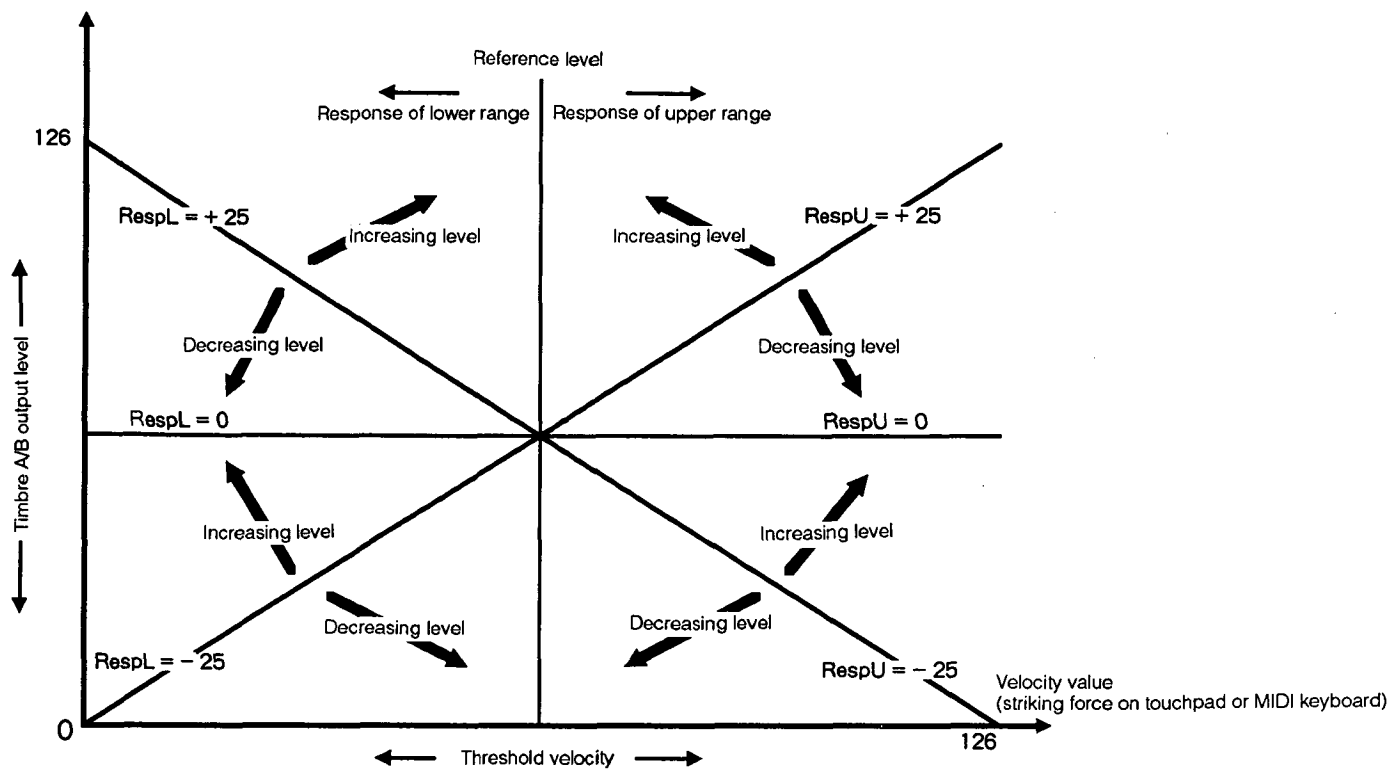

Note: Unless specified otherwise, the effect descriptions below all use the midpoint velocity (64) as the threshold and make TimA and TimB dominant in the lower and upper ranges, respectively, but the

threshold may be shifted anywhere in the velocity range (2~126) and the lower and upper range settings may be reversed.



# Instrument Modes

## Timbre Switching Effect

This effect plays the timbre assigned to timbre A up to the threshold and then rapidly switches to timbre B.

*Note: The only difference between this effect and the next, cross fading, lies in the rapidity with which they change timbres.*

Procedure:

1. Select the threshold (64) for the timbre slot A.

Use the [S1] soft key or the [<CURSOR] and [CURSOR>] keys to select the first menu item.

Use the [+ / YES] and [- / NO] keys or the [DATA ENTRY] dial to change the field value.

2. Select the slopes for the first timbre slot. This example uses a slope of -25 for the lower range and to minimize output in the upper velocity range, choose the steepest available negative slope (-50).

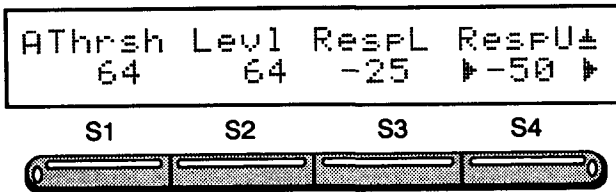

The above settings produce this graphical representation of timbre A:

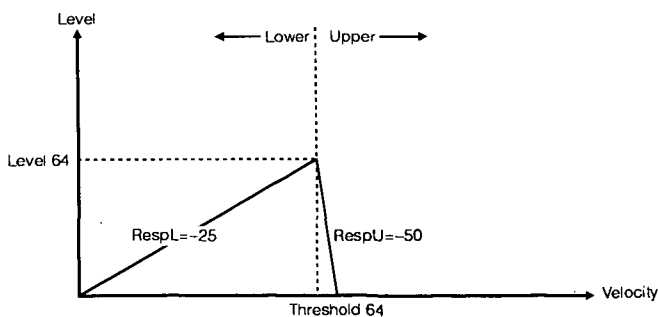

Use the [S3] soft key or the [<CURSOR] and [CURSOR>] keys to select the third menu item.

Use the [+ / YES] and [- / NO] keys or the [DATA ENTRY] dial to change the field value.

Use the [S4] soft key or the [<CURSOR] and [CURSOR>] keys to select the fourth menu item.

Use the [+ / YES] and [- / NO] keys or the [DATA ENTRY] dial to change the field value.

3. Press the [PAGE>] key to change pages.
4. Repeat the above procedure for timbre slot B. (For timbre slot B select -50 for the lower range and +25 for the upper.)
5. Test the pad with keystrokes of various strengths to see when and how the timbre shifts from A to B as the velocity increases.

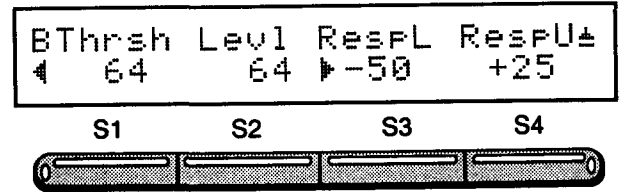

The above settings produce this graphical representation of timbre B:

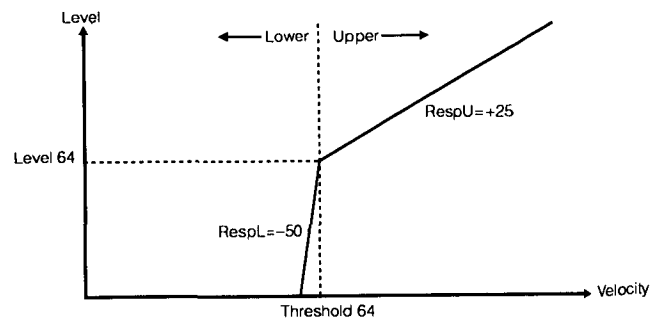

*Note: To minimize output in the lower velocity range, the steepest available negative slope (-50) was chosen.*

*Note: This example uses a slope of -50 both for the upper range of timbre A and the lower range of timbre B, but the two could just as well be different. (See The next example, Cross Fade Effect.)*

# Instrument Modes

## Cross Fade Effect

This effect makes the two timbres dominant on opposite sides of the threshold velocity and provides a transition region around that point so that one timbre fades out as the other fades in.

*Note: The width of this transition region depends on the fade in and fade out slopes as well as the difference between the threshold velocities on the two pages.*

Procedure:

1. Select the threshold (64) for timbre slot A.

Use the [S1] soft key or the [<CURSOR] and [CURSOR>] keys to select the first menu item.

Use the [+ / YES] and [- / NO] keys or the [DATA ENTRY] dial to change the field value.

2. Select the slopes for the first timbre slot. This example uses a slope of 0 for the lower range so that the output level for that timbre remains constant over that range and a negative slope (-30) for the upper range so that the output level gradually fades out.

Use the [S3] soft key or the [<CURSOR] and [CURSOR>] keys to select the third menu item.

Use the [+ / YES] and [- / NO] keys or the [DATA ENTRY] dial to change the field value.

Use the [S4] soft key or the [<CURSOR] and [CURSOR>] keys to select the fourth menu item.

Use the [+ / YES] and [- / NO] keys or the [DATA ENTRY] dial to change the field value.

3. Press the [PAGE>] key to change pages.

4. Repeat the above procedure for timbre slot B. (For timbre slot B select -30 for the lower range and +25 for the upper.)

5. Test the pad with keystrokes of various strengths to see when and how the timbre shifts from A to B as the velocity increases.

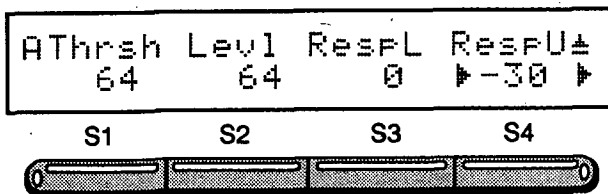

The above settings produce this graphical representation of timbre A:

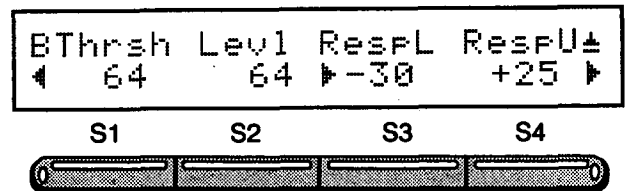
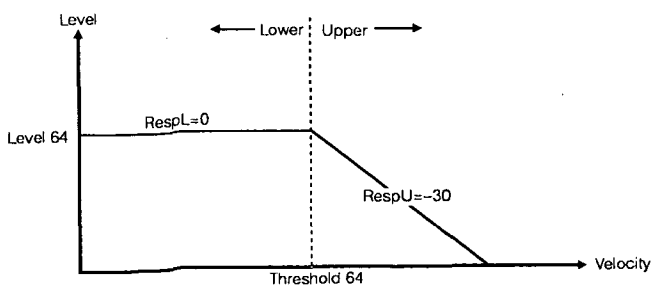

The above settings produce this graphical representation of timbre B:

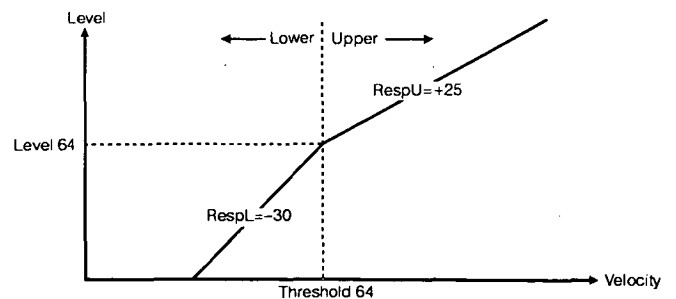

*Note: This example uses a 1:1 ratio (+25) for the touch response in the upper range for timbre B.*

# Instrument Modes

## Timbre Window Effect

The timbre window effect limits the use of the timbre assigned to a timbre slot to a particular region around the threshold velocity. The example below uses timbre slot TimB and a threshold velocity of 70.

Procedure:

1. Select the threshold for timbre slot B.

Use the [S1] soft key or the [<CURSOR] and [CURSOR>] keys to select the first menu item.

Use the [+ / YES] and [- / NO] keys or the [DATA ENTRY] dial to change the field value.

2. Select the slopes for timbre slot B.

Use the [S3] soft key or the [<CURSOR] and [CURSOR>] keys to select the third menu item.

Use the [+ / YES] and [- / NO] keys or the [DATA ENTRY] dial to change the field value.

Use the [S4] soft key or the [<CURSOR] and [CURSOR>] keys to select the fourth menu item.

Use the [+ / YES] and [- / NO] keys or the [DATA ENTRY] dial to change the field value.

3. Press the [PAGE>] key to change pages.

4. Select the threshold and slopes for the other timbre slot. (For timbre slot A select 64 for both threshold and level, -25 for the lower slope and +25 for the upper.)

5. Test the pad with keystrokes of various strengths to see when and how the second timbre appears in conjunction with the first procedure as the velocity increases.

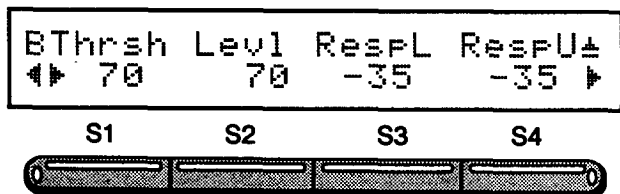

The above settings produce this graphical representation of timbre B:

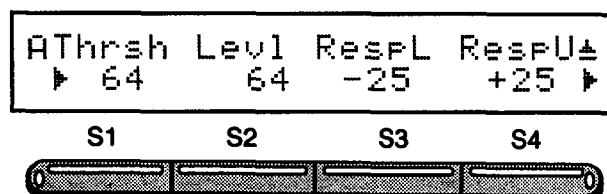
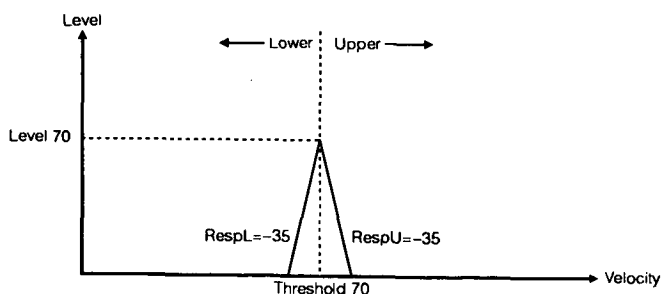

The above settings produce this graphical representation of timbre A:

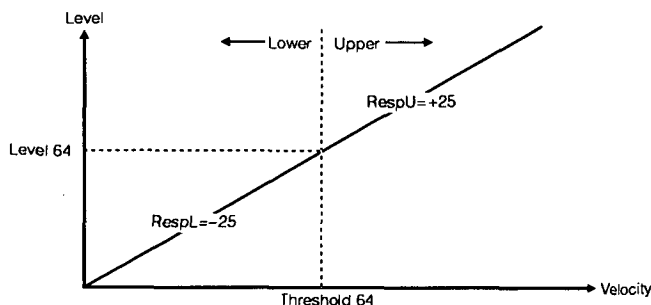

*Note: This example uses steep slopes (+/- 35) to produce a sharply defined peak. Lower numbers permit access over a wider range of velocities.*

*Note: An output level of 70 was chosen so that timbre B would be accented a little when it is heard.*

*Note: These settings can be anything from a straight-line response curve to another peak at a different threshold, for example.*

# Instrument Modes

## OUT Submenu

This page is for routing the output of the individual timbre slots to the stereo OUTPUT pair of jacks, one of the four MULTI OUT jacks (M1 ~ 4), through effect sends 1 and 2 (E1 or E2) or through a combination of stereo with M1, M2, M3, M4, E1 or E2.

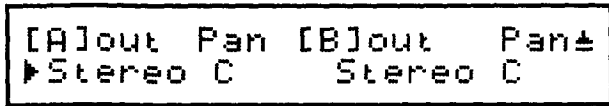

Menu Key	Field	Field Type & Possible Settings	Description
S1	Output routing (A)	Stereo/ Multi1 -4/ Effect1 -2/ ST+M1/ST+M2/ ST+M3/ST+M4/ ST+E1/ST+E2	Destination for TimA output: stereo OUTPUT jacks (Stereo or ST), a MULTI OUT jack (Multi1 (M1)-Multi4 (M4)), an effect send routing with E1 or E2 or a combination thereof.
S2	Pan setting (A)	R15 -C-L15	Stereo position for TimA: choice of 31 positions from R15 (right only) through C (center) to L15 (left only). (Note: This setting applies only to the stereo OUTPUT jacks.)
S3	Output routing (B)	Stereo/ Multi1 -4/ Effect1 -2/ ST+M1/ST+M2/ ST+M3/ST+M4/ ST+E1/ST+E2	Destination for TimB output.
S4	Pan setting (B)	R15 -C-L15	Stereo position for TimB.

Note: The number of simultaneous voices available depends on the output choice: stereo=12, multi-out=8, effect send=4. Be careful about output assignments when a pad has both timbres assigned because two voices are being used simultaneously.

### 4.2.2 PAD ARRANGE (K2) Page

This page is for assigning an instrument pad from an existing drum kit (the source) to an instrument pad in the current drum kit (the destination). This facility promotes the effective reuse of existing pads and eliminates unnecessary duplication of effort.

Note: This page does not effect the NOTE ASSIGN (K5) page.

Note: When the Pre bank is selected as a kit location, editing is prohibited and the SET command is not shown.



Menu Key	Field	Field Type & Possible Settings	Description
S1	Source bank	P/I/C	Location of the instrument pad. (P=preset, I=internal, C=card)
S2	Source kit	0-9	Number of the drum kit using the instrument pad.
S3	Source pad	P01 -P16	Number of the touchpad using the instrument pad. Use numbers 1-8 for Bank A and numbers 9 - 16 for Bank B. (Note: The name field to the right of this number changes automatically with this number.)
S4	SET command	*Set	Command to make the change.

Procedure:

1. Press the desired touchpad (destination).

Note: The destination touchpad number is indicated between the [ ] marks.

2. Select the source bank.

Use the [S1] soft key or the [<CURSOR] and [CURSOR>] keys to select the first menu item.

Use the [+ / YES] and [- / NO] keys or the [DATA ENTRY] dial to change the field value.

3. Select the source drum kit.

Use the [S2] soft key or the [<CURSOR] and [CURSOR>] keys to select the second menu item.

Use the [+ / YES] and [- / NO] keys or the [DATA ENTRY] dial to change the field value.

4. Select the source touchpad.

Use the [S3] soft key or the [<CURSOR] and [CURSOR>] keys to select the third menu item.

# Instrument Modes

Use the [+ / YES] and [- / NO] keys or the [DATA ENTRY] dial to change the field value.

Answer the question Sure? (Y/N) with either the [+ / YES] key to proceed or the [- / NO] key to cancel. You may also use the [EXIT] key to cancel.

## 5. Change the touchpad assignment.

Use the [S4] soft key to execute the command.

### 4.2.3 PAD MODE (K3) Page

This page controls three aspects of instrument pad operation: polyphonic vs. monophonic voice mode, instrument exclusivity and instrument voice priority.

```

K3 PAD MODE      I0[P01]
▶Poly ExOff Normal
    
```



Menu Key	Field	Field Type & Possible Settings	Description
S1	Overlap mode	Poly/Mono	Voice overlapping mode for repeated keystrokes: overlapping (Poly) or termination of previous notes (Mono) to eliminate overlap. The former, Poly, is necessary to ensure natural output for such instruments as cymbals; the latter, however, uses fewer resources—only a single voice—so is the better choice for both instruments that are monophonic and those that are never played in rapid succession.
S2	Exclusive group	ExA/ExB/ExOff	Instrument group: Group A (ExA), Group B (ExB) or not used (ExOff). Group A and Group B denote independent groups of instruments—open hi-hat and closed hi-hat, for example—that must not sound together with other instruments in the same group. This function resembles the preceding one in that it blocks overlap between successive notes, but differs in that the notes are from different instruments.
S3 S4	Priority	Reserve/Normal	Instrument voice priority. The Reserve group of instruments has first priority when competing for the available synthesizer voices (12 on the S3). A typical candidate for this group is the cymbals. Second priority goes to the more recent notes from those with the Normal setting. If there are no voices available, the older notes from the Normal group are terminated first. If the notes from the Reserve group exceed the limit on the number of voices, however, the results are undefined.

### 4.2.4 PAD LEVEL (K4) Page

This page sets the output level for the current instrument pad.

```

K4 PAD LEVEL      I0[P01]
▶Level=99
    
```



Menu Key	Field	Field Type & Possible Settings	Description
	Level	01 -99	Output level for the current instrument pad.

# Instrument Modes

## 4.2.5 NOTE ASSIGN (K5) Page

This page is for assigning the output note number, the note number transmitted to the MIDI OUT jacks when the touchpad is pressed and the input range, the range of note numbers for sounding the corresponding instrument pad received via the MIDI IN jack.

*Note: This page asks for a range for the incoming note data so that the sound generator can use the different pitches to modify the timbre output.*

*Note: The S3 automatically converts MIDI note numbers (0 – 127) to standard musical notation (from C-1 to G9).*

Menu Key	Field	Field Type & Possible Settings	Description
S1 S2	Original key	C-1 -G9	Note number transmitted via the MIDI OUT jacks.
S3	Bottom note	C-1 -G9	Lowest note in the range.
S4	Top note	C-1 -G9	Highest note in the range..

*Note: The range must include at least the output note number— that is, the bottom note cannot be higher than the output note number and vice versa. Setting the top and bottom notes to the output note number produces a range with only one note.*

```
K5 NOTE ASSIGN I0[P01]
Orgn1▶C 2 [ C 2 -> C 2 ]
```

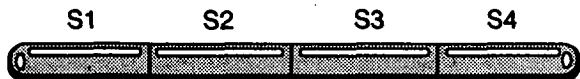

### Example:

The following example sets the transmitted note number for Pad 1 to C4, the bottom note to G3 and the top note to F4.

```
K5 NOTE ASSIGN I0[P01]
Orgn1=C 4 [G 3 ->▶F 4]
```

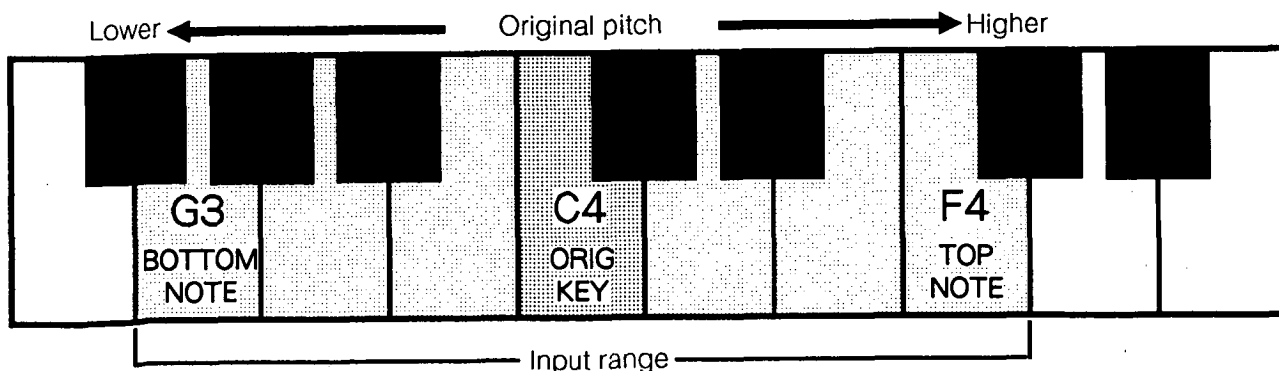

# Instrument Modes

## 4.2.6 MONITOR (K6) Page

This page is for selecting the effect assigned to the drum kit monitor.

*Note: This setting is not stored with the drum kit. It remains in effect only in the KIT and PAD modes and is overridden by the EFFECT submenu in the SONG PLAY/REC mode's SONG SETTING (SP2) page.*

```
K6MONITOR          I0[P01]
▶Effect=00
```



Menu Key	Field	Field Type & Possible Settings	Description
	Effect number	00-15	Effect to use while editing the drum kit.

## 4.2.7 KIT COPY (K7) Page

This page is for copying the current drum kit, the source, to another drum kit, the destination, in the user drum kit bank or a RAM card, where it may be edited.

*Note: This copy function operates at the drum kit level. Use the PAD ARRANGE (K2) page to copy individual instrument pads.*

```
K7 KIT COPY          I0[P01]
I0 ->[ Int ▶0 ]    *Exec
```



Menu Key	Field	Field Type & Possible Settings	Description
	Source (current drum kit)	P0-9/I0-9/ C0-9	Bank and drum kit number for current drum kit. <i>(Note: This field is for display purposes only. To change the current drum kit, use the KIT SELECT (K1) page.)</i>
S2	Destination bank	Int/Card	Location of the drum kit to receive the copy.
S3	Destination drum kit number	0-9	Number of the drum kit to receive the copy.
S4	EXECUTE command	*Exec	Command to make the change.

Procedure:

1. Use the KIT SELECT (K1) page to select the source drum kit.
2. Use the [PAGE>] key to select the KIT COPY (K7) page.
3. Select the destination bank.

Use the [S2] soft key or the [<CURSOR] and [CURSOR>] keys to select the second menu item.

Use the [+ / YES] and [- / NO] keys or the [DATA ENTRY] dial to change the field value.

4. Select the destination number.

Use the [S3] soft key or the [<CURSOR] and [CURSOR>] keys to select the third menu item.

Use the [+ / YES] and [- / NO] keys or the [DATA ENTRY] dial to change the field value.

5. Copy the drum kit.

Use the [S4] soft key to execute the command. Answer the question Sure? (Y/N) with either the [+ / YES] key to proceed or the [- / NO] key to cancel. You may also use the [EXIT] key to cancel.

# Chapter 5 Effects

An effect is a signal processor for modifying sound generator output. The S3 provides two such processors with two channels each and full facilities for programming them to achieve a wide variety of audio effects.

## 5.1 Overview of the S3's Effect Configuration

### 5.1.1 Effect Programs

The S3 provides storage for 16 effect programs. An effect program consists of two effect type sets (parameter sets for the each effect), two pan settings for modifying the stereo balance of the effect send channels and placement (P1 or P2), a parameter determining the link joining the two effects to the stereo output channels and the two effect send channels.

- The following pages assign effect programs:
- PATTERN PLAY/REC mode's MONITOR (PP2) page K/Eff submenu
- SONG PLAY/REC mode's SONG SETTING (SP2) page EFFECT ASSIGN submenu
- TIMBRE mode's MONITOR (T6) page
- KIT mode's MONITOR (K6) page

The OUT submenus for the following pages provide options for redirecting sound generator output to the stereo output channels, an effect send channel, both or neither:

- PAD mode's PAD EDIT (P3) page
- TIMBRE mode's MONITOR (T6) page

*Note: The effects apply only to the stereo output and the effect send channels. In particular, they do not apply to output to the MULTI OUT jacks. Use the OUT submenus, therefore, to direct output to a combination of the stereo output channels (ST) and the desired MULTI OUT jack (M1-M4).*

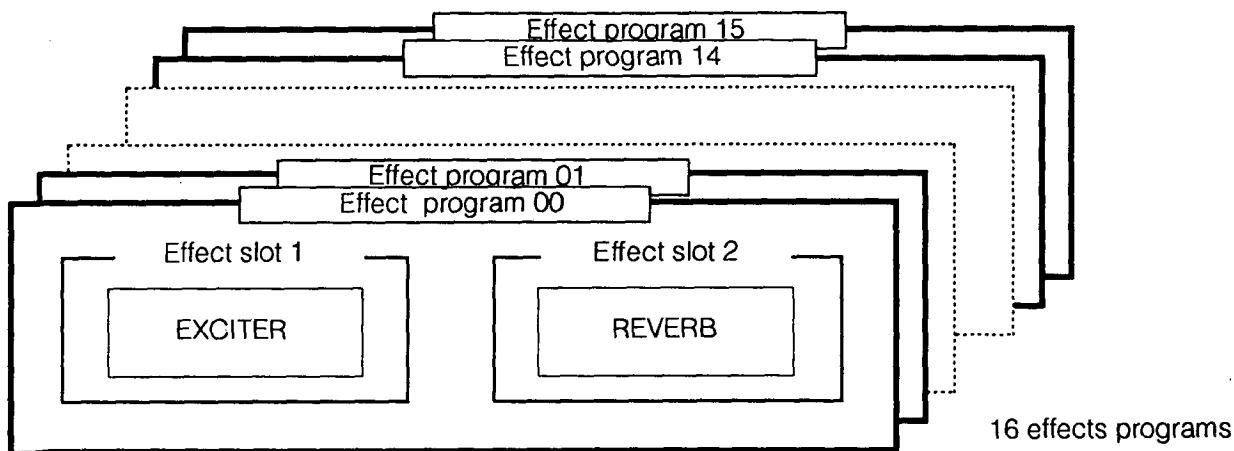



# Effects

## 5.1.2 Placement

The S3 offers a choice of two configurations for joining the two effects: Placement 1 and Placement 2.

### 5.1.2.1 Placement 1 (P1)

Placement 1 passes the output stereo channels through both effect slot 1 and effect slot 2 and the effect send channels through only effect slot 2. The pan settings modify the stereo balances of the effect send channels on their way to effect slot 2.

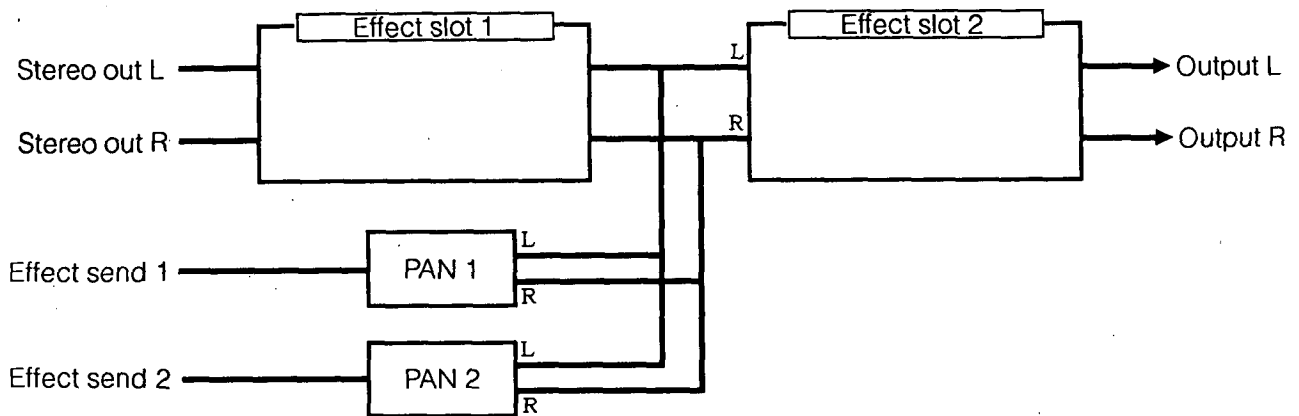

### 5.1.2.2 Placement 2 (P2)

Placement 2 passes the effect send channels through both effect slot 1 and effect slot 2 and the output stereo channels through only effect slot 2. The pan settings modify the stereo balances of the effect send channels on their way to effect slot 2.

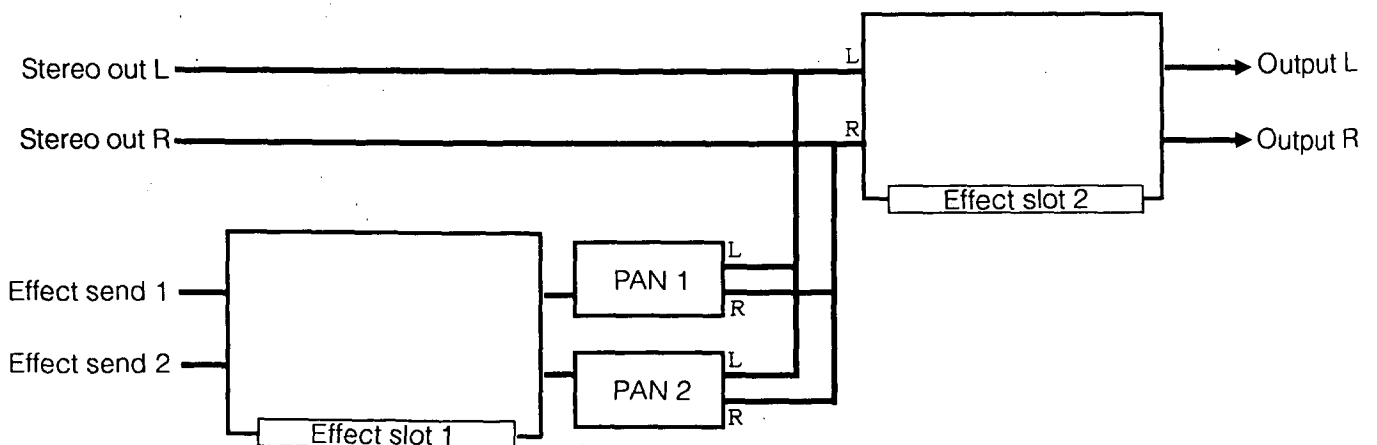

# Effects

## 5.1.3 Effect Types

There are 28 effect types, each with its own list of parameters. There is also Off (effect 00).

### S3 Available Effect Types

No.	STEREO EFFECTS		No.	COMPOUND EFFECTS	
01	HALL1	HALL REVERB 1	15	EQ	DUAL EQUALIZER
02	HALL2	HALL REVERB 2	16	EXCITE	DUAL EXCITER
03	HALL3	HALL REVERB 3	17	D/HALL	DELAY/HALL REVERB
04	ROOM1	ROOM REVERB 1	18	D/ROOM	DELAY/ROOM REVERB
05	ROOM2	ROOM REVERB 2	19	D/REF	DELAY EARLY REFLECTION
06	ROOM3	ROOM REVERB 3	20	D/DLY	DELAY/DELAY
07	E. REF1	EARLY REFLECTION 1	21	D/CHOR	DELAY/CHORUS
08	E. REF2	EARLY REFLECTION 2	22	D/FLAN	DELAY/FLANGER
09	E. REF3	EARLY REFLECTION 3	23	D/PHAS	DELAY/PHASER
10	DELAY	STEREO DELAY	24	D/TREM	DELAY TREMOLO
11	CHORUS	STEREO CHORUS	25	E/DLY	EQUALIZER/DELAY
12	FLANGE	STEREO FLANGER	26	E/CHOR	EQUALIZER/CHORUS
13	PHASER	STEREO PHASER	27	E/FLAN	EQUALIZER/FLANGER
14	TREM	STEREO TREMOLO	28	E/TREM	EQUALIZER/TREMOLO
(00) OFF			OFF		

The maximum possible number of simultaneous effects is four—two each for the left and right STEREO OUT jacks. Stereo effect types (1 – 14) assign the same effect equally to both input channels (left and right) but the compound effect types (15 – 28) assign different effects to each of the inputs, effectively doubling the number of simultaneous effects possible.

### Stereo Effects and Compound Effects

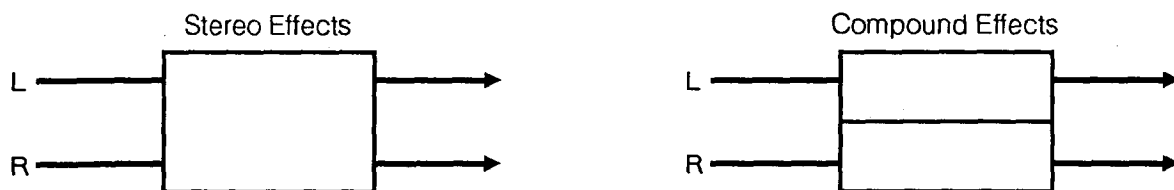

The same effect is applied to both left and right channels. The left and right channels have separate effects.

*Note: For more details about the individual effects, refer to 5.3 Editing an Effect Type*

*Note: When using a compound effect in effect slot 1 with placement 2, effect send channel 1 corresponds to the effect slot's left channel and effect send channel 2 corresponds to the effect slot's right channel. The pan controls adjust the stereo balances for the two output channels.*

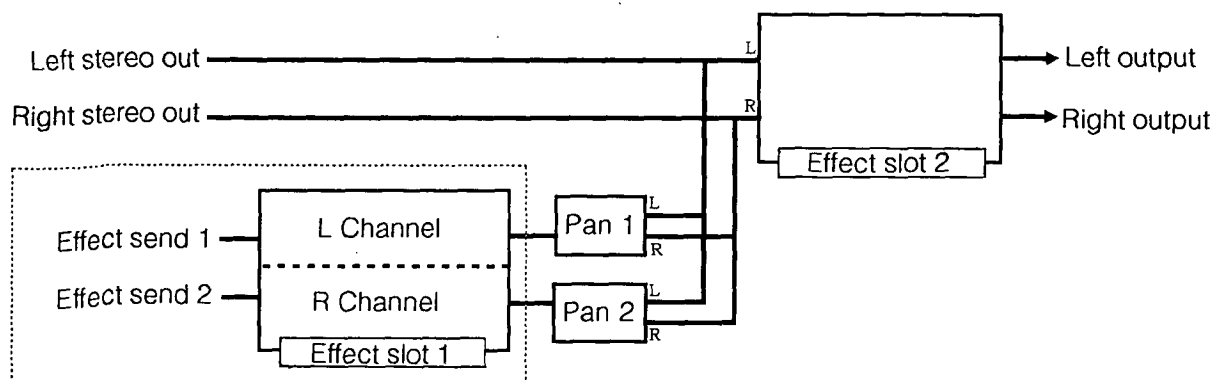

# Effects

## 5.1.4 Examples of Effect Programs

### Using Placement 1

When recording a pattern with drums and percussion, assign the Dual Exciter or the Dual Equalizer to effect slot 1 and Hall Reverb 1 to effect slot 2. In the KIT mode, assign the drum output to the stereo outputs and the percussion output to the Effect Send 1 and 2. In the below diagram, only the drums are put through

the Excite effect and the Hall Reverb 1 — the percussion is directed only to the Hall Reverb 1.

*Note: Effect Slot 1 uses the Dual Exciter as a stereo effect and therefore the left and right channels are treated equally.*

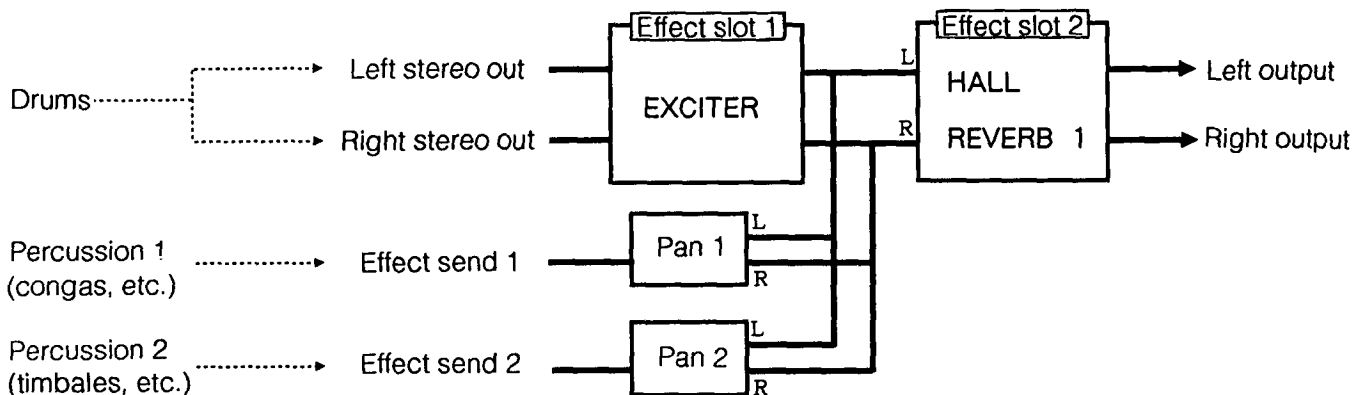

### Using Placement 2

In this example, separate effects are applied to different parts of a drum kit. As in Placement 1, a Dual Exciter or the Dual Equalizer is used in effect slot 1 and the Hall Reverb 1 effect is assigned to effect slot 2. In the KIT mode, assign the tom toms, cymbals and

hi-hat output to the stereo outputs, while the bass drum and snare drum are sent to the Effect Send 1 and 2, respectively. For this example, the Dual Exciter is used as a compound effect so the bass drum and snare drum can be given "customized" effects.

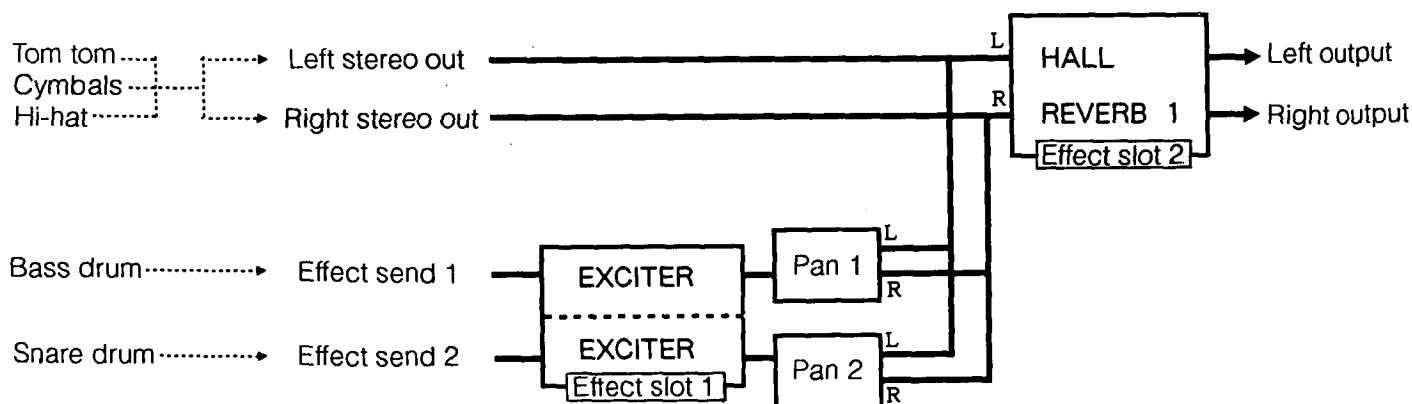

## 5.2 EFFECT (S3) Page

This page is the starting point for all effect editing operations.

Procedure:

1. Press the [GLOBAL] key until the LED inside turns red.
2. Use the [<PAGE] and [PAGE>] keys to select the EFFECT (S3) page.

### 5.2.1 Editing an Effect Program

This page and its two submenus (SET and Copy) are for editing the effect program at the highest level—that is, selecting the effect types, placement and pan settings for a particular program number. It also provides access to each effect type's particular series of parameter input screens. (See 5.3 *Editing an Effect Type*.)

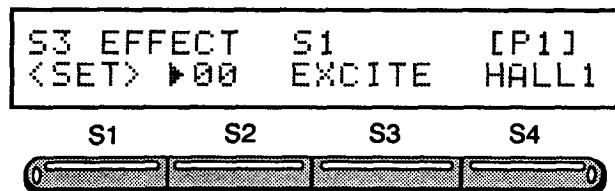

Menu Key	Field	Field Type & Possible Settings	Description
S1	SET submenu	<SET>	Submenu for setting placement and pan settings
S2	Program number	00 -15	Number of effect program to edit
S3	Effect slot 1	OFF /EFFECT TYPE	Effect for first effect
S4	Effect slot 2	OFF /EFFECT TYPE	Effect for second effect

*Note: The text fields change automatically with the effect program number.*

*Note: The upper right corner of the screen gives the current placement setting: Placement 1 ([P1]) or Placement 2 ([P2]).*

**Example:**The following procedure assigns effects DELAY and ROOM3 to effect slots 1 and 2, respectively.

Procedure:

1. Select the effect program number.
  - Use the [S2] soft key or the [<CURSOR] and [CURSOR>] keys to select the second menu item.
  - Use the [+YES] and [-/NO] keys or the [DATA ENTRY] dial to change the field value.
2. Select the effect type for effect slot 1.
  - Use the [S3] soft key or the [<CURSOR] and [CURSOR>] keys to select the third menu item.
  - Use the [+YES] and [-/NO] keys or the [DATA ENTRY] dial to change the field value.
3. Select the effect type for effect slot 2.
  - Use the [S4] soft key or the [<CURSOR] and [CURSOR>] keys to select the fourth menu item.
  - Use the [+YES] and [-/NO] keys or the [DATA ENTRY] dial to change the field value.
4. Strike the touchpads to test the new settings.
5. Switch to the SET and COPY submenus.
  - Use the [S1] soft key to display the submenu.

*Note: The effect program number appears in the upper left corner of the parameter input screens.*

*Note: The selection Off disables the effect.*

# Effects

## 5.2.2 SET Submenu

This page is for selecting the placement and pan settings for the current effect program.

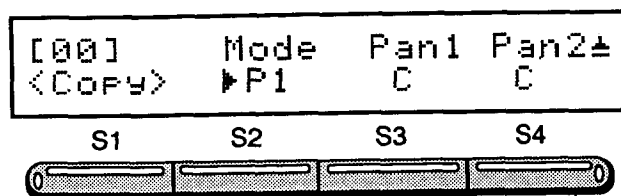

Menu Key	Field	Field Type & Possible Settings	Description
S1	COPY submenu	<COPY>	Submenu for copying the current effect program to another effect program
S2	Placement	P1/P2	Choice of serial (P1) or parallel (P2) connection
S3	Pan 1	L15 -C-R15	Stereo position for effect send 1: choice of 31 positions from R15 (right only) through C (center) to L15 (left only)
S4	Pan 2	L15 -C-R15	Stereo position for effect send 2

*Note: This setting applies only to the stereo OUTPUT jacks.*

*Note: The pan settings always apply to only the effect send channels, but whether they apply before or after effect slot 1 depends on the placement.*

Procedure:

1. Select the effect placement (P1 or P2).

Use the [S2] soft key or the [<CURSOR] and [CURSOR>] keys to select the second menu item.

Use the [+YES] and [-/NO] keys or the [DATA ENTRY] dial to change the field value.

2. Select the stereo position for the effect send 1.

Use the [S3] soft key or the [<CURSOR] and [CURSOR>] keys to select the third menu item.

Use the [+YES] and [-/NO] keys or the [DATA ENTRY] dial to change the field value.

3. Select the stereo position for the effect send 2.

Use the [S4] soft key or the [<CURSOR] and [CURSOR>] keys to select the fourth menu item  
Use the [+YES] and [-/NO] keys or the [DATA ENTRY] dial to change the field value.

## 5.2.3 COPY Submenu

This page is for copying the current effect program to another effect program.

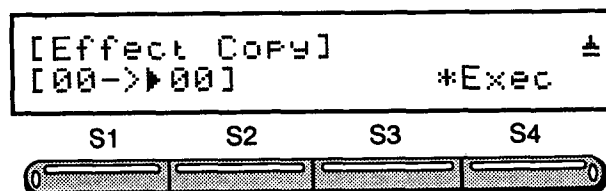

Menu Key	Field	Field & Possible Settings	Description
	Program number	00-15	Current effect program
S2	Destination program number	00-15	Number of effect program to receive the data
S4	EXECUTE command	*Exec	Command to store the program

Procedure:

1. Switch to the COPY submenu.

Use the [S1] soft key to display the submenu.

2. Select the number of the effect program to receive the data.

Use the [+YES] and [-/NO] keys or the [DATA ENTRY] dial to change the field value.

3. Store the effect program.

Use the [S4] soft key (\*Exec) to store the effect program.

Answer the question Sure? (Y/N) with either the [+YES] key to proceed or the [-/NO] key to cancel. You may also use the [EXIT] key to cancel.

4. Press the [EXIT] key to return to the SET submenu.

## 5.3 Editing an Effect

The EFFECT (S3) page is also the starting point for editing the current effect types whose names appear on the screen.

```
S3 EFFECT <Edit> <Edit>
<Set> ▶00 ROOM1 Off
```

Procedure:

1. Hold down the [SHIFT] key to change the first line of the page so that the word <Edit> appears over each effect.
2. Press the key ([S3] or [S4]) under the name of the effect to be edited.
3. Edit the parameter fields for the effect with the [+ / YES] and [- / NO] keys and the [DATA ENTRY] dial. To access other fields which are located on other pages, use the [<PAGE>] and [PAGE>] keys.

Parameter Editing Menus for the ROOM1 Effect

```
[S1] ROOM          [P1]▲
Reverb Time       ▶0.5sec
```

*Note: The number and type of fields that appear vary with the effect. (See charts below.) For example, the ROOM1 reverberation effect has the following eight parameters:*

- Reverb Time (reverberation time)
- Pre Delay (preliminary delay)
- E/R Level (early reflection level)
- High Damp (damping amount for high frequency band)
- EQ Low (gain for equalizing low frequencies)
- EQ High (gain for equalizing high frequencies)
- LchDry:Eff (left channel balance)
- RchDry:Eff (right channel balance)

Here is the Pre Delay parameter menu:

```
[S1] ROOM1          [P1]▲
Pre Delay          ▶ 22ms
```

4. Press the [EXIT] key to return to the S3 page.

## 5.4 Stereo Effects (01 ~ 14)

### 5.4.1 HALL/ROOM (01 ~ 06)

These six effects simulate the acoustic properties of rooms and halls of various sizes.

The maximum reverberation times are 9.9 seconds for HALL effects and 5.0 seconds for ROOM.

The HALL effects differ in ambience: HALL1 is a natural-sounding hall; HALL2 adds modulation; HALL3 accentuates the early reflection to simulate a large hall.

The ROOM effects offer similar variety: ROOM1 simulates a small, intimate room; ROOM2 adds extra depth; ROOM3 adds the reverberation of a large room.

Parameter	Field type & possible settings	Description
Reverb Time	0.2 -9.9sec(ROOM:5.0sec)	Reverberation time, the time that the reverb takes to decay.
Pre Delay	0-50ms	Delay to the start of early reflection.
E/R Level	0-99	Early reflection level.
High Damp	0-99%	Amount of high frequency damping.
EQ Low	-12 +12dB	Gain for equalizing (cutting or boosting) low frequencies.
EQ High	-12 +12dB	Gain for equalizing (cutting or boosting) high frequencies.
Lch>Dry:Eff	Dry -99:1 -50:50 -1:99 -Eff	Balance between direct sound and effect output for left channel.
Rch>Dry:Eff	Dry -99:1 -50:50 -1:99 -Eff	Balance between direct sound and effect output for right channel.

### 5.4.2 EARLY REFLECTION (07 ~ 09)

These three effects provide just the early reflection portions of the reverberation effects. They are especially effective for adding such effects as gate reverb and reverse gate reverb to rhythm patterns.

The three differ only in the way they change the level: E/REF1 uses the standard curve for such applications as gate reverb; E/REF2 uses a totally different curve; E/REF3 reverses the slope for such applications as reverse gate reverb for sounds with short attack times.

Parameter	Field type & possible settings	Description
E/R Time	100 -690ms	Early reflection time. The greater this value, the longer the reverberation.
Pre Delay	0-150ms	Delay to the start of early reflection.
EQ Low	-12 +12dB	Gain for equalizing (cutting or boosting) low frequencies.
EQ High	-12 +12dB	Gain for equalizing (cutting or boosting) high frequencies.
Lch>Dry:Eff	Dry -99:1 -50:50 -1:99 -Eff	Balance between direct sound and effect output for left channel.
Rch>Dry:Eff	Dry -99:1 -50:50 -1:99 -Eff	Balance between direct sound and effect output for right channel.

# Effects

## 5.4.3 STEREO DELAY (10)

This effect adds independent delays to the left and right channels. It is especially effective for sounds requiring long delays.

Parameter	Field type & possible settings	Description
Lch>DelayTime	0-430ms	Delay between direct sound and effect output for left channel.
Rch>DelayTime	0-430ms	Delay between direct sound and effect output for right channel.
Feedback	-99 +99%	Amount of feedback. A negative value reverses the phase.
High Damp	0-99%	Amount of high frequency damping.
EQ Low	-12 +12dB	Gain for equalizing (cutting or boosting) low frequencies.
EQ High	-12 +12dB	Gain for equalizing (cutting or boosting) high frequencies.
Lch>Dry:Eff	Dry -99:1 -50:50 -1:99 -Eff	Balance between direct sound and effect output for left channel.
Rch>Dry:Eff	Dry -99:1 -50:50 -1:99 -Eff	Balance between direct sound and effect output for right channel.

## 5.4.4 STEREO CHORUS (11)

This effect adds a modulated delay to double and "thicken" a sound.

Parameter	Field type & possible settings	Description
Mod Depth	0-99	Amount of modulation.
Mod Speed	1-216	Speed of modulation.
Delay Time	0-200ms	Delay between direct sound and effect output.
Mod Waveform	Sin/Tri	Choice of two waveforms for modulation: sine (Sin) or triangle (Tri).
EQ Low	-12 +12dB	Gain for equalizing (cutting or boosting) low frequencies.
EQ High	-12 +12dB	Gain for equalizing (cutting or boosting) high frequencies.
Lch>Dry:Eff	Dry -99:1 -50:50 -1:99 -Eff	Balance between direct sound and effect output for left channel.
Rch>Dry:Eff	Dry -99:1 -50:50 -1:99 -Eff	Balance between direct sound and effect output for right channel.

## 5.4.5 STEREO FLANGER (12)

This effect intensifies the modulation effect by adding feedback. It is highly effective with cymbals, snare drums and other instruments with large numbers of harmonics because various short delay times accentuate different frequencies.

Parameter	Field type & possible settings	Description
Mod Depth	0-99	Amount of modulation.
Mod Speed	1-216	Speed of modulation.
Delay Time	0-50ms	Delay between direct sound and effect output.
Feedback	-99 +99%	Amount of feedback. A negative value reverses the phase.
Mod Waveform	Sin/Tri	Choice of two waveforms for modulation: sine (Sin) or triangle (Tri).
EQ Low	-12 +12dB	Gain for equalizing (cutting or boosting) low frequencies.
EQ High	-12 +12dB	Gain for equalizing (cutting or boosting) high frequencies.
Lch>Dry:Eff	Dry -99:1 -50:50 -1:99 -Eff	Balance between direct sound and effect output for left channel.
Rch>Dry:Eff	Dry -99:1 -50:50 -1:99 -Eff	Balance between direct sound and effect output for right channel.

## 5.4.6 STEREO PHASER (13)

This effect is also known as the "phase shifter" because it shifts the phase of the input to add a swelling effect subtly different from the chorus and flanger effects.

Parameter	Field type & possible settings	Description
Manual	0-99	Median frequency for the phase shift effect.
Mod Speed	1-216	Speed of modulation.
Mod Depth	0-99	Amount of modulation.
Feedback	-99 +99%	Amount of feedback. A negative value reverses the phase.
Mod Waveform	Sin/Tri	Choice of two waveforms for modulation: sine (Sin) or triangle (Tri).
Lch>Dry:Eff	Dry -99:1 -50:50 -1:99 -Eff	Balance between direct sound and effect output for left channel.
Rch>Dry:Eff	Dry -99:1 -50:50 -1:99 -Eff	Balance between direct sound and effect output for right channel.



## 5.4.7 STEREO TREMOLO (14)

This effect modulates the output level at a selected rate. Changing the waveform and shape produces variations of the effect.

Parameter	Field type & possible settings	Description
Mod Depth	0-99	Amount of modulation.
Mod Speed	1-216	Speed of modulation.
Mod Waveform	Sin/Tri	Choice of two waveforms for modulation: sine (Sin) or triangle (Tri).
Shape	-99 -+99	Shape of the modulating waveform.
EQ Low	-12 -+12dB	Gain for equalizing (cutting or boosting) low frequencies.
EQ High	-12 -+12dB	Gain for equalizing (cutting or boosting) high frequencies.
Lch>Dry:Eff	Dry -99:1 -50:50 -1:99 -Eff	Balance between direct sound and effect output for left channel.
Rch>Dry:Eff	Dry -99:1 -50:50 -1:99 -Eff	Balance between direct sound and effect output for right channel.

## 5.5 Compound Effects (15 ~ 28)

Effects 15-28 are compound effects which apply independent effects to the two input channels. Their primary use is as effect slot 1 with placement 2.

### 5.5.1 DUAL EQUALIZER (15)

This effect provides independent 2-band equalizers for adjusting high and low frequencies on each channel.

Parameter	Field type & possible settings	Description
Lch>Low Gain	-12 -+12dB	Gain for equalizing (cutting or boosting) low frequencies.
Lch>Low Fc	250Hz/500Hz/1kHz	Cutoff frequency for low frequency band.
Lch>High Gain	-12 -+12dB	Gain for equalizing (cutting or boosting) high frequencies.
Lch>High Fc	1k/2k/4kHz	Cutoff frequency for high frequency band.
Lch>Dry:Eff	Dry -99:1 -50:50 -1:99 -Eff	Balance between direct sound and effect output for left channel.
Rch>Low Gain	-12 -+12dB	Gain for equalizing (cutting or boosting) low frequencies.
Rch>Low Fc	250Hz/500Hz/1kHz	Cutoff frequency for low frequency band.
Rch>High Gain	-12 -+12dB	Gain for equalizing (cutting or boosting) high frequencies.
Rch>High Fc	1k/2k/4kHz	Cutoff frequency for high frequency band.
Rch>Dry:Eff	Dry -99:1 -50:50 -1:99 -Eff	Balance between direct sound and effect output for right channel.

### 5.5.2 DUAL EXCITER (16)

This effect gives clarity, definition and presence to the sound. It is especially effective for making rhythms stand out.

Parameter	Field type & possible settings	Description
Lch>Blend	-99 -+99	Depth of the exciter effect.
Lch>Emphatic Point	1-10	Center frequency for exciter effect.
Lch>EQ Low	-12 -+12dB	Gain for equalizing (cutting or boosting) low frequencies.
Lch>EQ High	-12 -+12dB	Gain for equalizing (cutting or boosting) high frequencies.
Lch>Dry:Eff	Dry -99:1 -50:50 -1:99 -Eff	Balance between direct sound and effect output for left channel.
Rch>Blend	-99 -+99	Depth of the exciter effect.
Rch>Emphatic Point	1-10	Center frequency for exciter effect.
Rch>EQ Low	-12 -+12dB	Gain for equalizing (cutting or boosting) low frequencies.
Rch>EQ High	-12 -+12dB	Gain for equalizing (cutting or boosting) high frequencies.
Rch>Dry:Eff	Dry -99:1 -50:50 -1:99 -Eff	Balance between direct sound and effect output for right channel.

# Effects

## 5.5.3 D/HALL (17)

This effect applies effects DELAY and HALL to the left and right channels, respectively.

Parameter	Field type & possible settings	Description
Lch>Delay Time	0-430ms	Delay between direct sound and effect output for left channel.
Lch>Feedback	-99 +99%	Amount of feedback. A negative value reverses the phase.
Lch>High Damp	0-99%	Amount of high frequency damping.
Lch>Dry:Eff	Dry -99:1 -50:50 -1:99 -Eff	Balance between direct sound and effect output for left channel.
Rch>Reverb Time	0.2-9.9sec	Reverberation time, the time that the reverb takes to decay.
Rch>Pre Delay	0-125ms	Delay to the start of early reflection.
Rch>High Damp	0-99%	Amount of high frequency damping.

## 5.5.4 D/ROOM (18)

This effect applies effects DELAY and ROOM to the left and right channels, respectively.

Parameter	Field type & possible settings	Description
Lch>Delay Time	0-430ms	Delay between direct sound and effect output for left channel.
Lch>Feedback	-99 +99%	Amount of feedback. A negative value reverses the phase.
Lch>High Damp	0-99%	Amount of high frequency damping.
Lch>Dry:Eff	Dry -99:1 -50:50 -1:99 -Eff	Balance between direct sound and effect output for left channel.
Rch>Reverb Time	0.2-5.0sec	Reverberation time, the time that the reverb takes to decay.
Rch>Pre Delay	0-125ms	Delay to the start of early reflection.
Rch>High Damp	0-99%	Amount of high frequency damping.
Rch>Dry:Eff	Dry -99:1 -50:50 -1:99 -Eff	Balance between direct sound and effect output for right channel.

## 5.5.5 D/EREF (19)

This effect applies effects DELAY and EARLY REFLECTION to the left and right channels, respectively.

Parameter	Field type & possible settings	Description
Lch>Delay Time	0-420ms	Delay between direct sound and effect output for left channel.
Lch>Feedback	-99 +99%	Amount of feedback. A negative value reverses the phase.
Lch>High Damp	0-99%	Amount of high frequency damping.
Lch>Dry:Eff	Dry -99:1 -50:50 -1:99 -Eff	Balance between direct sound and effect output for left channel.
Rch>E/R Time	100-340ms	Early reflection time. The greater this value, the longer the reverberation.
Rch>Pre Delay	0-50ms	Delay to the start of early reflection.
Rch>Dry:Eff	Dry -99:1 -50:50 -1:99 -Eff	Balance between direct sound and effect output for right channel.

## 5.5.6 D/DLY (20)

This effect applies effects DELAY and DELAY to the left and right channels, respectively.

Parameter	Field type & possible settings	Description
Lch>Delay Time	0-430ms	Delay between direct sound and effect output for left channel.
Lch>Feedback	-99 +99%	Amount of feedback. A negative value reverses the phase.
Lch>High Damp	0-99%	Amount of high frequency damping.
Lch>Dry:Eff	Dry -99:1 -50:50 -1:99 -Eff	Balance between direct sound and effect output for left channel.
Rch>Delay Time	0-430ms	Delay between direct sound and effect output for right channel.
Rch>Feedback	-99 +99%	Amount of feedback. A negative value reverses the phase.
Rch>High Damp	0-99%	Amount of high frequency damping.
Rch>Dry:Eff	Dry -99:1 -50:50 -1:99 -Eff	Balance between direct sound and effect output for right channel.

# Effects

## 5.5.7 D/CHOR (21)

This effect applies effects DELAY and CHORUS to the left and right channels, respectively.

Parameter	Field type & possible settings	Description
Lch>Delay Time	0-430ms	Delay between direct sound and effect output for left channel.
Lch>Feedback	-99 ~+99%	Amount of feedback. A negative value reverses the phase.
Lch>High Damp	0-99%	Amount of high frequency damping.
Lch>Dry:Eff	Dry -99:1 -50:50 -1:99 -Eff	Balance between direct sound and effect output for left channel.
Rch>Mod Depth	0-99	Amount of modulation.
Rch>Mod Speed	1-216	Speed of modulation.
Rch>Mod Waveform	Sin/Tri	Choice of two waveforms for modulation: sine (Sin) or triangle (Tri).
Rch>Dry:Eff	Dry -99:1 -50:50 -1:99 -Eff	Balance between direct sound and effect output for right channel.

## 5.5.8 D/FLAN (22)

This effect applies effects DELAY and FLANGER to the left and right channels, respectively.

Parameter	Field type & possible settings	Description
Lch>Delay Time	0-430ms	Delay between direct sound and effect output for left channel.
Lch>Feedback	-99 ~+99%	Amount of feedback. A negative value reverses the phase.
Lch>High Damp	0-99%	Amount of high frequency damping.
Lch>Dry:Eff	Dry -99:1 -50:50 -1:99 -Eff	Balance between direct sound and effect output for left channel.
Rch>Mod Depth	0-99	Amount of modulation.
Rch>Mod Speed	1-216	Speed of modulation.
Rch>Feedback	-99 ~+99%	Amount of feedback. A negative value reverses the phase.
Rch>Dry:Eff	Dry -99:1 -50:50 -1:99 -Eff	Balance between direct sound and effect output for right channel.

## 5.5.9 D/PHAS (23)

This effect applies effects DELAY and PHASER to the left and right channels, respectively.

Parameter	Field type & possible settings	Description
Lch>Delay Time	0-430ms	Delay between direct sound and effect output for left channel.
Lch>Feedback	-99 ~+99%	Amount of feedback. A negative value reverses the phase.
Lch>High Damp	0-99%	Amount of high frequency damping.
Lch>Dry:Eff	Dry -99:1 -50:50 -1:99 -Eff	Balance between direct sound and effect output for left channel.
Rch>Mod Depth	0-99	Amount of modulation.
Rch>Mod Speed	1-216	Speed of modulation.
Rch>Feedback	-99 ~+99%	Amount of feedback. A negative value reverses the phase.
Rch>Dry:Eff	Dry -99:1 -50:50 -1:99 -Eff	Balance between direct sound and effect output for right channel.

## 5.5.10 D/TREM (24)

This effect applies effects DELAY and TREMOLO to the left and right channels, respectively.

Parameter	Field type & possible settings	Description
Lch>Delay Time	0-430ms	Delay between direct sound and effect output for left channel.
Lch>Feedback	-99 ~+99%	Amount of feedback. A negative value reverses the phase.
Lch>High Damp	0-99%	Amount of high frequency damping.
Lch>Dry:Eff	Dry -99:1 -50:50 -1:99 -Eff	Balance between direct sound and effect output for left channel.
Rch>Mod Depth	0-99	Amount of modulation.
Rch>Mod Speed	1-216	Speed of modulation.
Rch>Shape	-99 ~+99	Shape of the modulating waveform.
Rch>Dry:Eff	Dry -99:1 -50:50 -1:99 -Eff	Balance between direct sound and effect output for right channel.

# Effects

## 5.5.11 E/DLY (25)

This effect applies effects EQUALIZER and DELAY to the left and right channels, respectively.

Parameter	Field type & possible settings	Description
Lch>Low Gain	-6 →+6dB	Gain for equalizing (cutting or boosting) low frequencies.
Lch>Low Fc	500Hz/1kHz	Cutoff frequency for low frequency band.
Lch>High Gain	-12 →+12dB	Gain for equalizing (cutting or boosting) high frequencies.
Lch>High Fc	1k/2k/4kHz	Cutoff frequency for high frequency band.
Lch>Dry:Eff	Dry -99:1 -50:50 -1:99 -Eff	Balance between direct sound and effect output for left channel.
Rch>Delay Time	0-430ms	Delay between direct sound and effect output for right channel.
Rch>Feedback	-99 →+99%	Amount of feedback. A negative value reverses the phase.
Rch>High Damp	0-99%	Amount of high frequency damping.
Rch>Dry:Eff	Dry -99:1 -50:50 -1:99 -Eff	Balance between direct sound and effect output for right channel.

## 5.5.12 E/CHOR (26)

This effect applies effects EQUALIZER and CHORUS to the left and right channels, respectively.

Parameter	Field type & possible settings	Description
Lch>Low Gain	-6 →+6dB	Gain for equalizing (cutting or boosting) low frequencies.
Lch>Low Fc	500Hz/1kHz	Cutoff frequency for low frequency band.
Lch>High Gain	-12 →+12dB	Gain for equalizing (cutting or boosting) high frequencies.
Lch>High Fc	1k/2k/4kHz	Cutoff frequency for high frequency band.
Lch>Dry:Eff	Dry -99:1 -50:50 -1:99 -Eff	Balance between direct sound and effect output for left channel.
Rch>Mod Depth	0-99	Amount of modulation.
Rch>Mod Speed	1-216	Speed of modulation.
Rch>Mod Waveform	Sin/Tri	Choice of two waveforms for modulation: sine (Sin) or triangle (Tri).
Rch>Dry:Eff	Dry -99:1 -50:50 -1:99 -Eff	Balance between direct sound and effect output for right channel.

## 5.5.13 E/FLAN (27)

This effect applies effects EQUALIZER and FLANGER to the left and right channels, respectively.

Parameter	Field type & possible settings	Description
Lch>Low Gain	-6 →+6dB	Gain for equalizing (cutting or boosting) low frequencies.
Lch>Low Fc	500Hz/1kHz	Cutoff frequency for low frequency band.
Lch>High Gain	-12 →+12dB	Gain for equalizing (cutting or boosting) high frequencies.
Lch>High Fc	1k/2k/4kHz	Cutoff frequency for high frequency band.
Lch>Dry:Eff	Dry -99:1 -50:50 -1:99 -Eff	Balance between direct sound and effect output for left channel.
Rch>Mod Depth	0-99	Amount of modulation.
Rch>Mod Speed	1-216	Speed of modulation.
Rch>Feedback	-99 →+99%	Amount of feedback. A negative value reverses the phase.
Rch>Dry:Eff	Dry -99:1 -50:50 -1:99 -Eff	Balance between direct sound and effect output for right channel.

## 5.5.14 E/TREM (28)

This effect applies effects EQUALIZER and TREMOLO to the left and right channels, respectively.

Parameter	Field type & possible settings	Description
Lch>Low Gain	-6 →+6dB	Gain for equalizing (cutting or boosting) low frequencies.
Lch>Low Fc	500Hz/1kHz	Cutoff frequency for low frequency band.
Lch>High Gain	-12 →+12dB	Gain for equalizing (cutting or boosting) high frequencies.
Lch>High Fc	1k/2k/4kHz	Cutoff frequency for high frequency band.
Lch>Dry:Eff	Dry -99:1 -50:50 -1:99 -Eff	Balance between direct sound and effect output for left channel.
Rch>Mod Depth	0-99	Amount of modulation.
Rch>Mod Speed	1-216	Speed of modulation.
Rch>Shape	-99 →+99	Shape of the modulating waveform.
Rch>Dry:Eff	Dry -99:1 -50:50 -1:99 -Eff	Balance between direct sound and effect output for right channel.

This chapter provides a brief MIDI background and a description of the S3's MIDI interface, the MIDI mode.

## 6.1 Background

### 6.1.1 What is MIDI?

MIDI stands for Musical Instrument Digital Interface, an internationally recognized standard for connecting electronic musical instruments, personal computers and other electronic equipment so that they may communicate with one another and thus work together as a single MIDI network. This communication capability is especially important with the S3 because it makes it possible to:

- Play a Korg M1 synthesizer or other MIDI instrument from the S3's touchpads and sequencer tracks.
- Play the S3 from a Korg M1 synthesizer or other MIDI keyboard.
- Synchronize the S3 with an external sequencer.
- Play the S3 from an external sequencer, personal computer or other similarly equipped MIDI device.
- Copy pattern, song and other types of data from the S3 to a floppy disk in a computer, sequencer or other similarly equipped MIDI device.

This Section provides a brief overview of MIDI—it by no means covers the entire subject of MIDI. For further information, please consult the MINI MIDI TEXT included with the S3 or any of the many reference books now available.

MIDI devices communicate by cable with digital data arranged in groups of bytes called messages. These messages fall into two major groups: **channel messages** intended for specific devices and **system messages** for all devices in the MIDI network. The major difference is that the status byte, the first byte in the message, of a channel message contains a channel number between 1 and 16. Although each MIDI device reads all incoming messages, it disregards channel messages with channel numbers that do not match its input channel and acts on the ones with matching channel numbers.

## 6.1.2 Channel Messages

Channel messages are messages for specific devices. There are two types of channel messages.

**Channel voice messages** represent musical events—a key press, key release, pitch bend change, etc. Pressing a key on a MIDI keyboard produces a Note On message at the MIDI OUT port. This message contains three pieces of information: the channel, the note number corresponding to that key and the velocity or force with which the key was pressed.

In addition to the note-related voice messages, the S3 uses PROGRAM CHANGE messages to change drum kits, CONTROL CHANGE messages to adjust modulation and other parameters and PITCH BEND CHANGE messages to change the pitch.

### Channel Voice Messages

Message name	Status byte	Description
Note Off	8XH(1000 XXXX)	Signals the end of a note and gives its pitch and release velocity.
Note On	9XH(1001 XXXX)	Signals the beginning of a note and gives its pitch and attack velocity.
Polyphonic Key Pressure	AXH(1010 XXXX)	Gives the pressure with which the key is held down. (Also known as aftertouch.)
Control Change	BXH(1011 XXXX)	Signals a change in synthesizer controls.
Program Change	CXH(1100 XXXX)	Signals a tone change in a synthesizer, kit change in a drum machine or a similar change on other devices.
Channel Pressure	DXH(1101 XXXX)	Gives the overall pressure on the keyboard.
Pitch Bend Change	EXH(1110 XXXX)	Signals a change in position for the pitch bend wheel or lever.

The other type of channel message is the **channel mode message**, a message for changing the receiving device's response to channel voice messages. There are two such receiving mode parameters. The first, Mono/Poly parameter, determines whether the receiving instrument sounds notes monophonically or polyphonically. The second, Omni On/Off, determines whether the receiving instrument acts on all messages or just on those on its input channel.

*Note: The normal setting is Omni Off.*

## 6.1.3 System Messages

System messages are messages intended for all devices in the MIDI network—messages for synchronizing the S3 with sequencers and other MIDI devices, for example.

There are three types of system messages: **system real-time messages**, **system common messages** and **system exclusive messages**.

**System real-time messages** synchronize the timing among different sequencers during performance and recording. These include TIMING CLOCK messages for controlling the basic tempo as well as messages to start, stop and continue performance and playback of the current song. Pressing the S3's [PLAY] key, for example, sends a START message and starts the TIMING CLOCK signals. All other MIDI devices then start when they receive this message.

**System common messages** coordinate song selection and tuning among MIDI devices. The most important message in this group is the SONG POSITION POINTER message, which gives a new song position in single clock increments relative to the beginning of

the current song. This message allows the MIDI network to start performance or recording at any point in the song, not just at the beginning.

**System exclusive messages** are manufacturer-specific messages for sending data that cannot be sent as any other kind of MIDI message. Although the typical application is the transmission of song, pattern and other types of program data between similar devices from the same manufacturer, computers, sequencers and other types of MDR (MIDI Data Recorder) equipment can also read and understand such messages.

*Note: System exclusive messages consist of the status byte, an ID byte—66 (42 Hex) for Korg—a variable number of data bytes and an EOX (End of Exclusive) byte. The special message EOX is necessary because manufacturers are free to make their system exclusive messages any length necessary to contain the data.*

# MIDI

## System real-time messages

Message name	Status byte	Description
Timing Clock	F8H(1111 1000)	Keeps all MIDI devices playing at the same tempo.
Start	FAH(1111 1010)	Starts all MIDI devices at the beginning of the current song.
Continue	FBH(1111 1011)	Starts all MIDI devices at the current position.
Stop	FCH(1111 1100)	Stops all MIDI devices.
Active Sensing	FEH(1111 1110)	Signals only that the cable connection to the master is intact. (Most MIDI devices ignore these signals. Those that recognize them treat their termination to a cable disconnection, for example, as a signal to turn off any notes that may be sounding.)
System Reset	FFH(1111 1111)	Resets all MIDI devices to the settings they had when they were first turned on.

## System common messages

Message name	Status byte	Description
MIDI Time Code Quarter Frame	F1H(1111 0001)	
Song Position Pointer	F2H(1111 0010)	Changes the starting point relative to the start of the current song.
Song Select	F3H(1111 0011)	Changes the song number.
Tune Request	F6H(1111 0110)	Asks all MIDI devices to tune themselves.
End of Exclusive	F7H(1111 0111)	Signals the end of a system exclusive message.

## System exclusive messages

Message name	Status byte	Description
System Exclusive	FOH(1111 0000)	Transfers data between equipment from the same manufacturer.

## 6.2 MIDI Mode

The previous subsection discussed MIDI operations in general. This section shows how they apply to the S3. As you know, the S3's built-in sequencer records not only pattern and song tracks for its own built-in sound sources, but also MIDI data from other devices. Furthermore, the sequencer offers complete editing facilities for filtering out extraneous data, altering such parameters as timing and velocity and merging new data with old (overdubbing). This edited data can then be used to play other MIDI instruments. At the same time, however, the S3 is also a 12-voice MIDI sound source unit which sequencers and external keyboards can access over four independent channels.

The MIDI mode is for taking full advantage of all these features. There are five pages in this mode to help you control the S3's MIDI interface.

Procedure:

1. Press the [GLOBAL] key until the LED inside turns green.
2. Use the [<PAGE] and [PAGE>] keys to select the desired page.

### 6.2.1 REC CHANNEL SELECT (M1) Page

This page is for telling the S3 whether to record data from a single MIDI input channel or from all channels. The former is the normal choice for recording data from an external sequencer or similar MIDI device.

*Note: When choosing All, the S3 records all the 16 channel MIDI data on to one track in the sequencer. In this mode, MIDI channel information, however, is not recorded. Use the PP2 MIDI submenu and the SP4 MIDI submenu to change the recorded sequencer data's channel.*

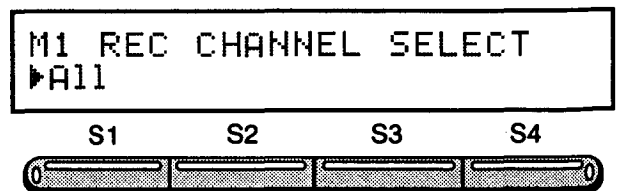

Procedure:

Menu key	Field	Field type & possible settings	Description
	MIDI channel	Ch01 -16 /A11	Channel or channels to record.

Use the standard menu procedures to choose the MIDI channel(s).

## 6.2.2 REC MESSAGE FILTER (M2) Page

This page is for filtering unwanted types of MIDI messages from the incoming stream so that they do not reach the sequencer during recording.

*Note: While recording, all the MIDI information's effects can be heard, however only those that were not filtered out will be heard upon playback.*

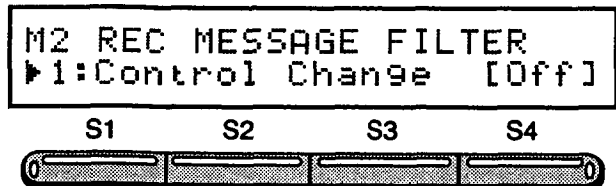

Menu key	Field	Field type & possible settings	Description
S1 S2 S3	Message type	Status: 1:Control Change/ 2:Program Change/ 3:Pitch Bender/ 4:Pressure/ 5:Velocity/	Number and type of MIDI message to filter: Changes in modulation, volume and other controls (1:Control Change), program changes (2:Program Change), pitch bend data (3:Pitch Bender), aftertouch data (4:Pressure) or note velocities (5:Velocity).
S4	Current filter status	On/Off	Ignore (On) or record (Off) the corresponding message. (Note: This field changes automatically with the message type, but may be changed.)

*Note: To set the velocity fix's level, use the PAD SENSITIVITY (S7) page's SET submenu.*

Procedure:

1. Select the message type.

Use the [S1] soft key or the [<CURSOR] and [CURSOR>] keys to select the first menu item.

Use the [+ / YES] and [- / NO] keys or the [DATA ENTRY] dial to change the field value.

2. Turn the corresponding filter ON or OFF.

Use the [S4] soft key or the [<CURSOR] and [CURSOR>] keys to select the fourth menu item.

Use the [+ / YES] and [- / NO] keys or the [DATA ENTRY] dial to change the field value.

3. Repeat the above two steps for the other message types.

## 6.2.3 RECEIVE FILTER (M3) Page

This page is for filtering unwanted types of MIDI messages from the incoming stream so that they do not reach the sound sources.

*Note: Not only do the unwanted MIDI messages get filtered out, but all data which is affected by the unwanted MIDI messages. As a result, this also means that all of this unwanted MIDI information will not be recorded.*

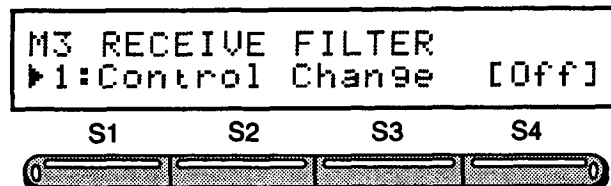

Menu key	Field	Field type & possible settings	Description
S1 S2 S3	Message type	Status: 1:Control Change/ 2:Program Change/ 3:Pitch Bender/ 4:Pressure/ 5:NoteData	Number and type of MIDI message to filter: changes in modulation, volume and other controls (1:Control Change), program changes (2:Program Change), pitch bend data (3:Pitch Bender), aftertouch data (4:Pressure) or note information (5:Note Data).
S4	Current filter status	On/Off	Ignore (On) or recognize (Off) the corresponding message. (Note: This field changes automatically with the message type, but may be changed.)

Procedure:

1. Select the message type.

Use the [S1] soft key or the [<CURSOR] and [CURSOR>] keys to select the first menu item.

Use the [+ / YES] and [- / NO] keys or the [DATA ENTRY] dial to change the field value.

2. Turn the corresponding filter ON or OFF.

Use the [S4] soft key or the [<CURSOR] and [CURSOR>] keys to select the fourth menu item.

Use the [+ / YES] and [- / NO] keys or the [DATA ENTRY] dial to change the field value.

3. Repeat the above two steps for the other message types..



## 6.2.4 MIDI OUTPUT (M4) Page

This page controls the configuration of the two MIDI OUT ports (A and B) on the rear panel—that is, whether they simultaneously act as MIDI THRU ports and whether they transmit the internal clock signal. The MIDI THRU capability is especially important when a MIDI keyboard must be connected to both the S3 and other instruments because it retransmits all messages coming in through the MIDI IN port unchanged to the MIDI OUT ports.

*Note: The settings for the two MIDI OUT ports are totally independent.*

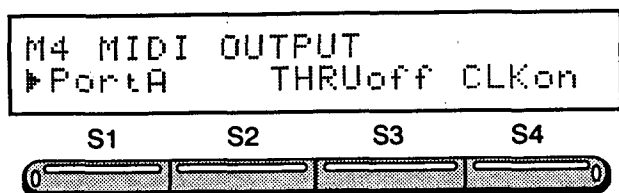

Menu key	Field	Field type & possible settings	Description
S1	MIDI port	PortA/PortB	MIDI OUT port to be configured.
S2 S3	THRU switch	THRUon/ THRUoff	Switch controlling MIDI THRU operation for the current port.
S4	Clock switch	CLKon/ CLKoff/MTC	Type of clock signal: none (CLK off), CLK on or MIDI Time Code (MTC).

*Note: When choosing MTC (MIDI Time Code), only the time code is sent, no other MIDI information is transmitted.*

Procedure:

1. Select the port.

Use the [S1] soft key or the [<CURSOR] and [CURSOR>] keys to select the first menu item.

Use the [+ / YES] and [- / NO] keys or the [DATA ENTRY] dial to change the field value.

2. Set the THRU switch.

Use the [S3] soft key or the [<CURSOR] and [CURSOR>] keys to select the second menu item.

Use the [+ / YES] and [- / NO] keys or the [DATA ENTRY] dial to change the field value.

3. Set the CLOCK switch.

Use the [S4] soft key or the [<CURSOR] and [CURSOR>] keys to select the second menu item. Use the [+ / YES] and [- / NO] keys or the [DATA ENTRY] dial to change the field value.

*Note: The CLKon setting makes the S3 the synchronization master for all MIDI devices connected to its MIDI OUT ports.*

## 6.2.5 GLOBAL CHANNEL (M5) Page

This page is for selecting the MIDI channel on which the S3 receives program change messages for its internal effects. This is also the channel that would be used to send/receive system exclusive messages.

*Note: To avoid overlap, a loss of effect program information, use a MIDI channel currently unused by the sequencer.*

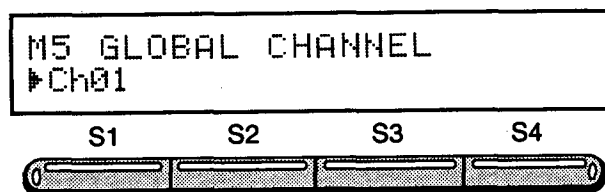

Menu key	Field	Field type & possible settings	Description
	Global channel	Ch01 -16	Channel for receiving effect change messages.

Procedure:

Use the standard menu procedures to select the channel.

## 6.3 MIDI Applications

This section describes the basic procedures for using the S3 in four typical MIDI configurations:

- As a drum machine under the control of an external MIDI keyboard.
- As a MIDI master controlling other MIDI devices.
- As a Multichannel sequencer.
- As a sound source module under the control of an external sequencer.

# MIDI

## 6.3.1 S3 under External Control

In this configuration, the S3 acts as a drum machine under the control of an external MIDI keyboard.

### Connections:

Connect the MIDI OUT port on the MIDI keyboard to the MIDI IN port on the S3.

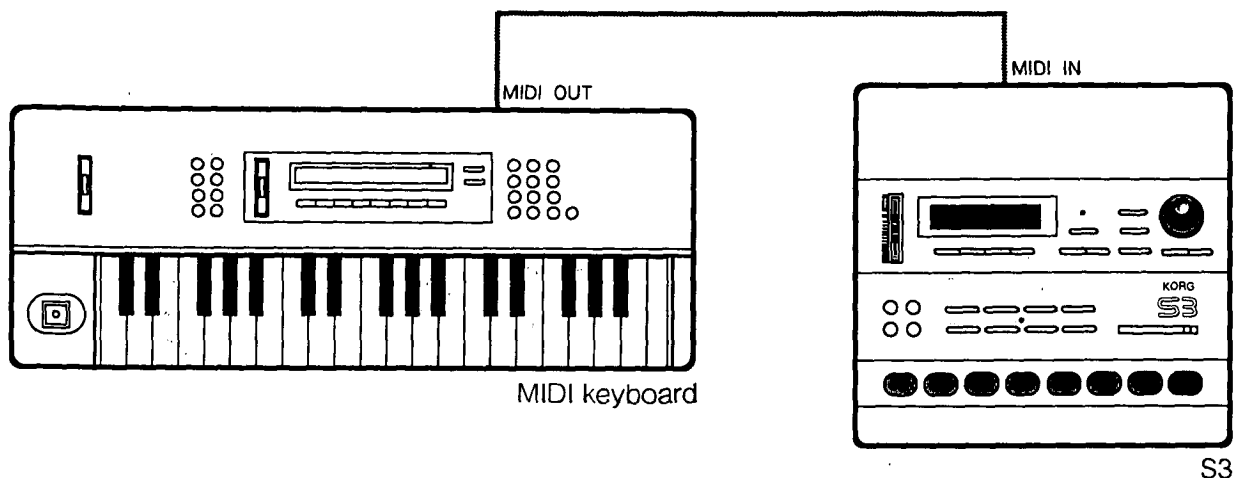

*Note: To take advantage of the S3's ability to play four drum kits simultaneously, this example assumes that the MIDI keyboard is transmitting on MIDI channels 1 ~ 4.*

*Note: This example assumes that you have already "made" a song with the SONG SELECT (SP1) page.*

### Basic Procedure:

1. Use the SONG SETTING (SP2) page's INITIAL KIT subpage to set the initial kit for your song.
2. Using the TRACK STATUS (SP4) page's MIDI subpage, set the S3's tracks 1 ~ 4 to the MIDI channels 1 ~ 4.

Use the [S4] soft key to select the fourth menu item.

Use the [S3] soft key to select the third menu item.

Use the [+ / YES] and [- / NO] keys or the [DATA ENTRY] dial to change the channel number.

Use the [S1] soft key to select the first menu item.

Use the [+ / YES] and [- / NO] keys or the [DATA ENTRY] dial to change the track number.

Repeat these steps until all four tracks are assigned MIDI channels 1 ~ 4.

```
SP4 TRACK STATUS      I00
▶Tr1  Both D1000 <MIDI>
```

```
[MIDI] Port  Ch      ±
Tr1  A+B  ▶01
```

3. Select output channel for the MIDI keyboard—channel 01, for example.

*Note: Consult the keyboard's owner's manual for the necessary procedures.*

4. (Optional) Change the drum kit assigned to the track pair, using the SP2 page

Use the [S3] soft key or the [<CURSOR] and

# MIDI

[CURSOR>] keys to select the third menu item.

Use the [+ / YES] and [- / NO] keys or the [DATA ENTRY] dial to change the field value.

5. (Optional) Edit the drum kit with the KIT mode pages.

6. Experiment with different keys on the MIDI keyboard.

## Note Numbers and the Drum Kit

There are two ways to assign the instrument pads in a drum kit to keys on the external MIDI keyboard. The first way (see Figure below) is to assign one note number per instrument pad so that the keys on the MIDI keyboard sound different instrument pads.

### One Note Per Instrument

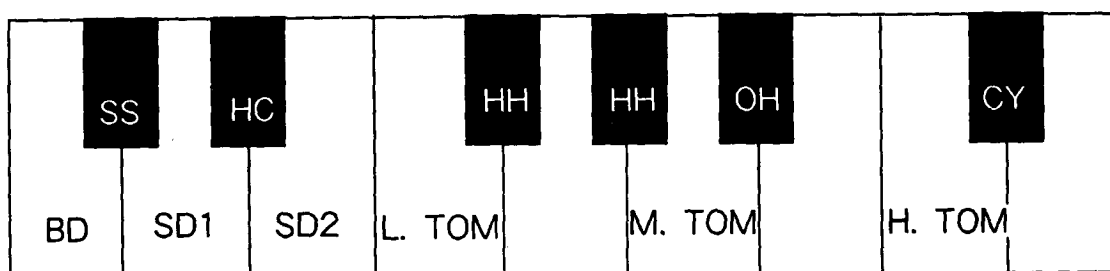

*Note: The S3 automatically converts between MIDI note numbers and standard musical notation, so there is normally no need to make a distinction between a key and its note number.*

The other way (see Figure below) is to expand the assignment to cover a range of note numbers so that each key in the range produces a different pitch of the same instrument—synthesized bass, for example.

### A Range of Notes Per Instrument

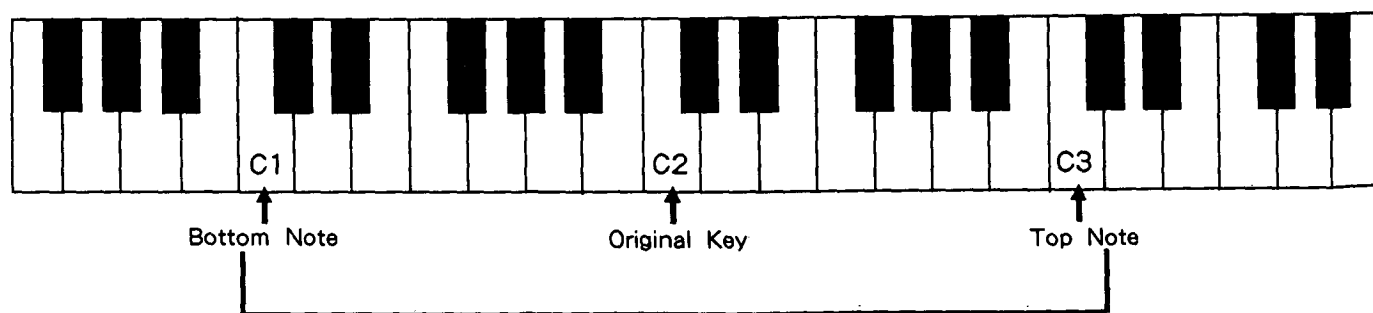

*Note: Overlapping ranges allow the same key on the MIDI keyboard to sound two or more instruments. This side-effect is sometimes desirable, sometimes not.*

The NOTE ASSIGN (K5) page provides three fields for making these assignments. The first specifies the note number transmitted by the drum kit; the second and third, the range of note numbers for sounding the drum kit.

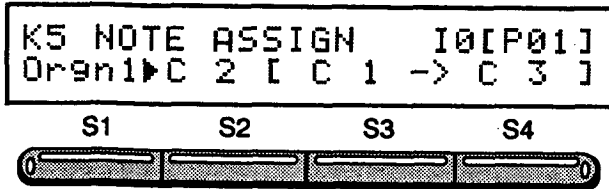

### Example 1: One note number per instrument pad

This approach assigns a single key to each instrument so that, for example, the C3 key on the MIDI keyboard sounds drum kit pad 01, a crash cymbal, for example.

1. Use the KIT SELECT (K1) page to select the drum kit.

*Note: Since this procedure involves editing the drum kit, the drum kit must be either in the internal bank of user-defined drum kits or on a RAM card.*

2. Press touchpad 1 to select the first instrument pad.

*Note: If [P09] appears in the upper right corner instead, press the [PAD BANK/TEMPO] key to switch to the lower bank and try again.*

3. Use the PAD ARRANGE (K2) page to assign the instrument pad named Crash to the current touchpad.

Use the [S3] soft key or the [<CURSOR] and [CURSOR>] keys to select the third menu item.

Use the [+ / YES] and [- / NO] keys or the [DATA ENTRY] dial to change the pad number.

Use the [S4] soft key to select and activate the fourth menu item.

Answer the question Sure? (Y/N) with either the [+ / YES] key to proceed or the [- / NO] key to cancel. You may also use the [EXIT] key to cancel.

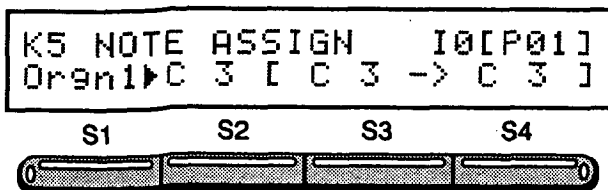

4. Use the NOTE ASSIGN (K5) page to assign a note number to the instrument pad—C3, for example.

Use the [S2] soft key or the [<CURSOR] and [CURSOR>] keys to select the second menu item.

Use the [+ / YES] and [- / NO] keys or the [DATA ENTRY] dial to change the field value.

5. Assign the same note number to the other two fields ([S3] and [S4]) as well.
6. Repeat the above procedure for all instruments.

### Example 2: Using a note range for pitch variations

This approach assigns a range of note numbers to each instrument pad so that different keys in the range produce different variations on the same instrument. It is especially effective with synthesized bass and other non-percussion instruments.

*Note: One application is to specify note ranges for all instruments to create results similar to a multisound sampler.*

Procedure:

1. Repeat steps 1-3 of the above procedure in example 1.

2. Use the NOTE ASSIGN (K5) page to assign a note number to the instrument pad.

*Note: This example uses synthesized bass as the instrument and assigns it to pad 1.*

3. Select the endpoints for the range—C2 and C4, for example.

# MIDI

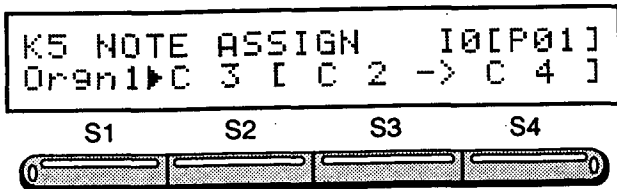

4. Experiment with different keys on the MIDI keyboard to see how instrument pitch varies with key transportation over the selected range.

*Note: If another instrument can be heard while playing the range on the MIDI keyboard, there probably is an-*

*other instrument assigned to that range. It is best to avoid overlapping instruments.*

*Note: Because the S3's scale range is  $\pm 3$  octaves, even if you set the K5 page's note range to a wider range, the range will still correspond to a maximum of  $\pm 3$  octaves. Moreover, if the P3 page's TUNE submenu's transposition value is other than 0, there is a possibility of the keys at the ends of the range on the MIDI keyboard having less than a full step separation. This unequal step problem can also occur on instruments using pitch changing effects, such as pitch bend.*

## 6.3.2 S3 as MIDI Master Controller

In this configuration, the S3 acts as a MIDI master controlling other MIDI devices.

### Connections:

*Note: The examples below assume that the MIDI device is receiving on MIDI channel 3 and that it is connected to the MIDI OUT A port.*

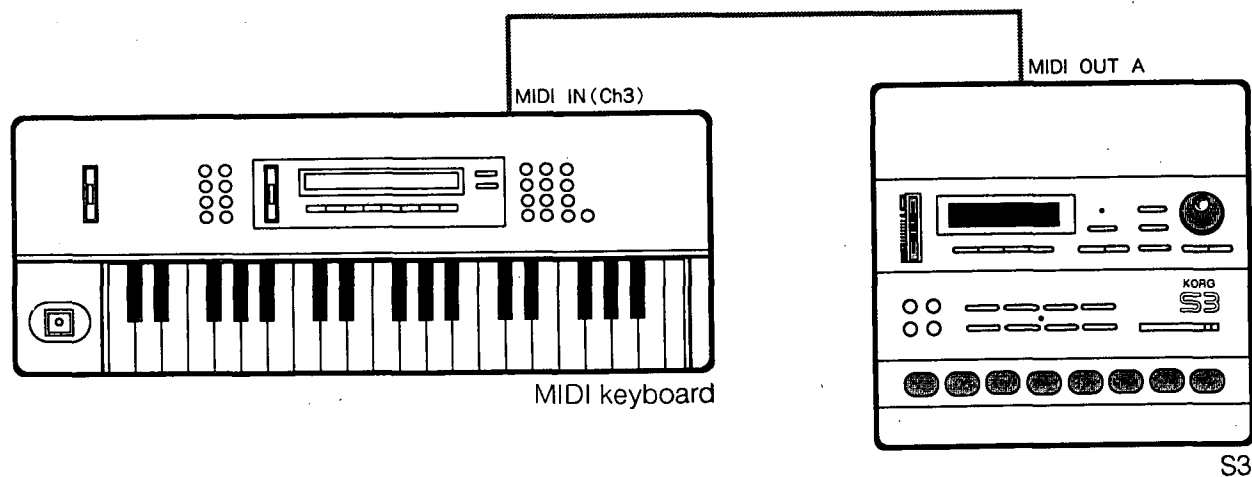

Connect a MIDI OUT port on the S3 to the MIDI IN port on the MIDI device—MIDI keyboard, for example.

*Note: This example assumes that you have already "made" a song with the SONG SELECT (SP1) page.*

## Touchpad Operation

One way to use this configuration is to connect the touchpads to a MIDI OUT port so that hitting and releasing touchpads sends the corresponding note events to other MIDI devices.

*Note: Remember that all the MIDI channel sequencer track changes are linked. Track changes to the SP4's MIDI subpage are reflected in the PP2 page's MIDI and KIT/EFFECT submenus as well as the SP2 page's INITIAL KIT submenu and the PATTERN PLAY/REC mode's and SONG PLAY/REC mode's REC READY displays.*

*Note: To find out the current pad's receiving channel, first find out what track is being used then find out that track's corresponding receiving channel on the PP2 or SP4 page's MIDI subpages.*

Procedure:

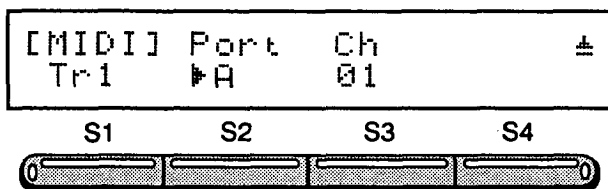

1. Use the TRACK STATUS (SP4) page's MIDI subpage to redirect touchpad output to the appropriate MIDI channel and MIDI OUT port—channel 3 and Port A (or A+B), for example.

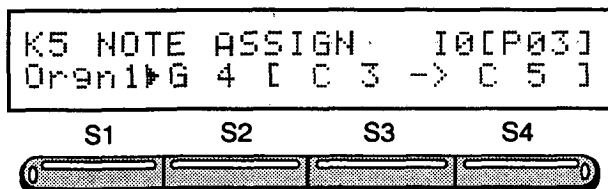

2. Use the NOTE ASSIGN (K5) page to assign note numbers to each touchpad—G4 for touchpad 3, for example.

*Note: The first field gives the note transmitted; the other two fields are for setting incoming note key windows.*

*Note: The above applies only when the PAD MODE (S6) page specifies the normal pad mode. (See Chapter 9 SYSTEM Mode.)*

*Note: When in the TIMBRE mode, except during song or pattern play, note data is not sent even if a touchpad is struck.*

## Track Operation

Even more convenient is the ability to play other instruments by playing back data stored on S3 tracks.

Procedure:

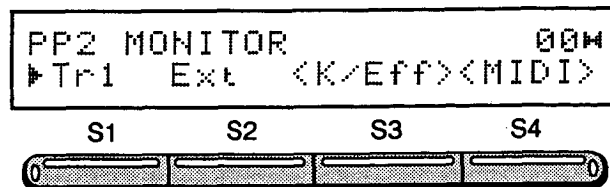

1. Use the PATTERN PLAY/REC mode's MONITOR (PP2) page or the SONG PLAY/REC mode's TRACK STATUS (SP4) page to select the track—track 1, for example.

Use the [S1] soft key or the [<CURSOR] and [CURSOR>] keys to select the first menu item.

Use the [+ / YES] and [- / NO] keys or the [DATA ENTRY] dial to change the field value.

*Note: The main difference between the two pages (PP2 and SP4) is that the track and status specifications for the SONG PLAY/REC mode are stored as part of the song data. The ones for the PATTERN PLAY/REC mode, however, are temporary settings for use in experimenting and recording.*

2. Connect the track to the MIDI OUT ports—that is, set the track output status to either Ext (MIDI only) or Both (MIDI and internal sound sources).

Use the [S2] soft key or the [<CURSOR] and [CURSOR>] keys to select the second menu item.

Use the [+ / YES] and [- / NO] keys or the [DATA ENTRY] dial to change the field value.

3. Switch to the MIDI submenu.

Use the [S4] soft key to display the submenu.

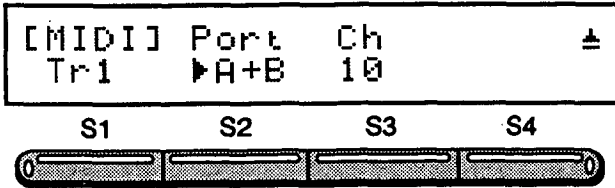

4. Select the MIDI OUT port (or ports) and the MIDI output channel—A+B (both) and channel 10, for example.

5. Press the [PLAY] key to start playback.

### 6.3.3 S3 as Multichannel Sequencer

The S3 can act as a multichannel sequencer because it has eight independent tracks—four for patterns and four for songs—which can each have a different MIDI output channel. The only difference is a minor one: the recording process uses the keys on a MIDI keyboard instead of the touchpads.

The example below uses a MIDI synthesizer to record data on pattern track 1 and play it back on a multi-timbre synthesizer module.

#### Connections:

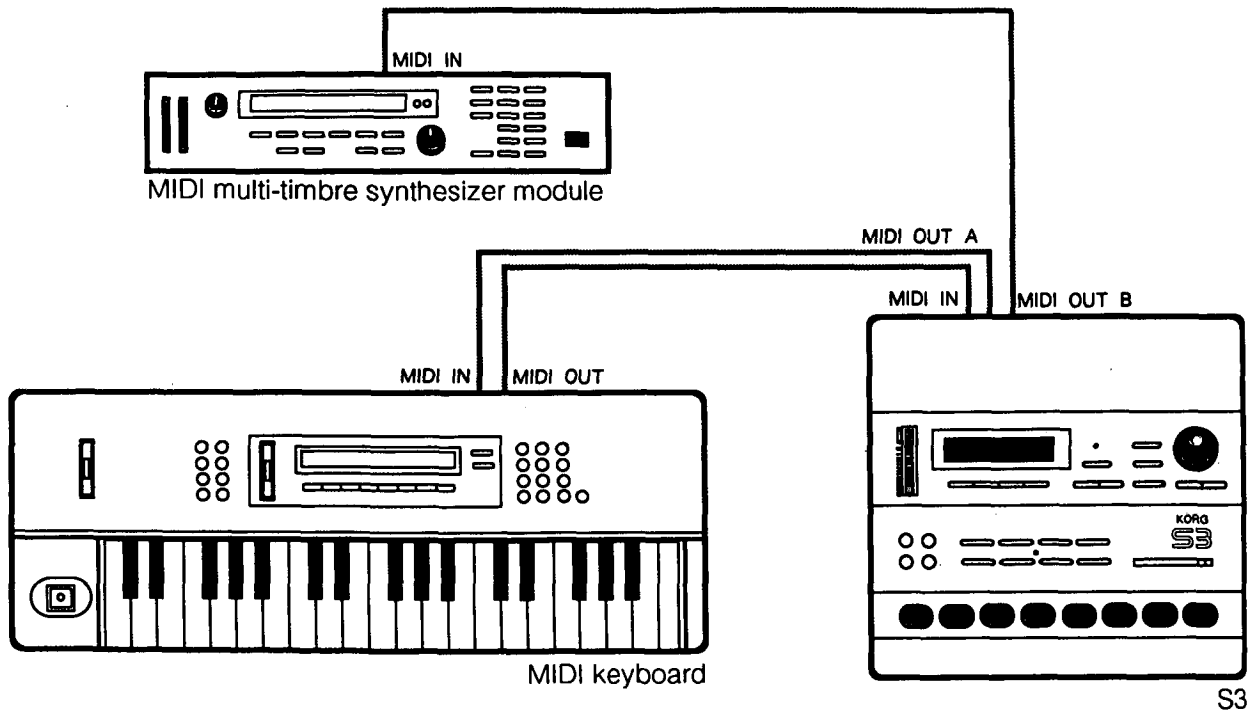

Connect the MIDI IN port and a MIDI OUT port on the S3 to the MIDI OUT and MIDI IN ports on the keyboard, respectively. Connect the other MIDI OUT port to the MIDI IN port on the MIDI multi-timbre synthesizer module.

Procedure:

```
M1 REC CHANNEL SELECT
▶All
```

1. Use the REC CHANNEL SELECT (M1) and REC MESSAGE FILTER (M2) pages to specify whether individual types of MIDI messages are to be recorded or disregarded—whether all velocity values are to be replaced with the midrange value (64), for example.

*Note: If the synthesizer is transmitting on only one channel, the safest and easiest choice is All.*

2. Use the PATTERN SELECT (PP1) page and the standard pattern recording procedures to select the pattern track on which to record—track 1, for example.

```
PP2 MONITOR 100
Tr1 ▶Ext <K/Eff><MIDI>
```

3. Use the MONITOR (PP2) page to redirect track output to the MIDI interface (Ext).

```
[MIDI] Port Ch ▲
Tr1 ▶B 02
```

Use the MIDI submenu to select the MIDI OUT port and the MIDI output channel—MIDI OUT B and channel 2, for example.

*Note: The output channel must match the input channel for the corresponding sound source in the destination module.*

```
M4 MIDI OUTPUT
PortB ▶THRUon CLKon
```

```
M4 MIDI OUTPUT
PortA ▶THRUoff CLKon
```

4. Use the MIDI OUTPUT (M4) page to activate the MIDI THRU function for the selected MIDI OUT port (B). Conversely turn port A's MIDI THRU function off to avoid sending back note data to the MIDI keyboard.

5. Set the synthesizer's MIDI output channel to match the sound source's input channel—channel 2, for example.

*Note: The above two steps ensure that the sound source module sounds during recording.*

6. Press the [REC] key to switch to the REC READY page.

```
REC READY TimSig Bars
▶Tr1 1/16 04/04 16
```

7. Select the track number (Tr1), quantization resolution (1/16), time signature and number of bars.

*Note: When the sequencer has recorded the specified number of bars, it automatically restarts at the beginning of the pattern to allow overdubbing.*

8. Press the [PLAY] key to start recording and record the keyboard output in the normal fashion.

*Note: To erase mistakes, use the Real-Time Erase function: Hold down the [S1] soft key and press the offending note (or notes) on the keyboard as the sequencer passes by them.*

9. Press the [STOP] key to terminate recording.

10. Press the [PLAY] key to play back the recorded pattern on the sound source module.

11. Repeat the above procedure for the other pattern tracks.

12. Use the SONG PLAY/REC mode procedures described in Chapter 3 *PATTERN and SONG Modes* to arrange the recorded patterns into a song.



Note: Usually pattern and song tracks are assigned the same MIDI channel. However, because the song tracks have their own output channel specifications, they do not have to use the same ones as the pattern tracks. For example, the following two screens show how to use the TRACK STATUS (SP4) page to separate song track 8 from pattern track 4—by setting the status to Ext—and route its output to MIDI output channel 8 and MIDI OUT port B via the MIDI submenu.

## MIDI Submenu

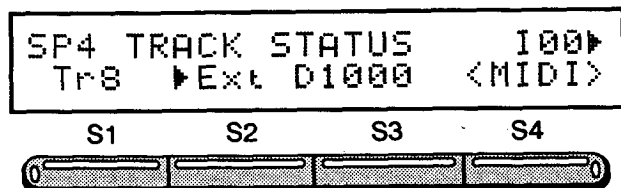
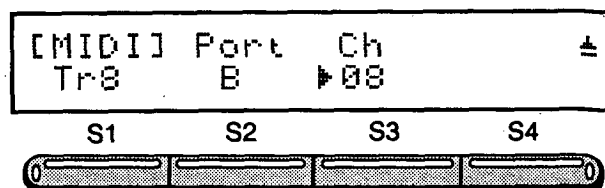

### 6.3.4 S3 as Sound Source

In this configuration, the S3 acts as a 4-channel multi-timbre sound source module under the control of an external sequencer.

#### External Connections:

Connect the MIDI OUT port on the sequencer to the MIDI IN port on the S3.

#### Internal Connections:

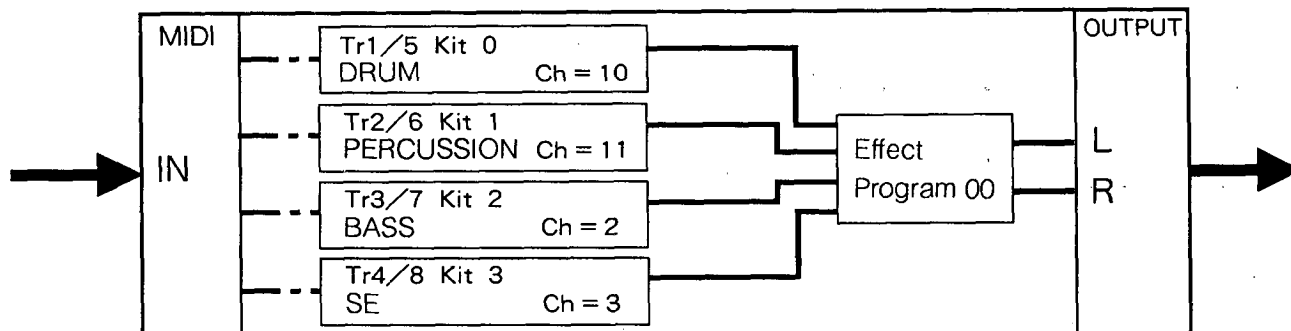

Each pattern/song track pair on the S3 can have a different MIDI input channel. And since each pattern/song track pair has a corresponding drum kit, the external sequencer can thus play the S3's sound sources if the track output status is set to Both or Int. (When track output status is set to Mute, the data is not transmitted to the corresponding drum kit.) The track output goes to the STEREO OUT jacks via the effects.

Because all the above data (drum kit selection, track status and effect program) is stored with each song, changing songs changes all these settings. When using the S3 as a sound source, think of it not as a recorder of sequencer data (the score), but as a short list containing the song's instrument and effect choices without the score.

#### Procedure:

1. Use the SONG SELECT (SP1) page to specify the song number. If necessary, use the Make command to create a song for that number.
2. Press the [PAGE] key to change to the SONG SETTING (SP2) page.



3. Switch to the INITIAL KIT submenu.

Use the [S3] soft key to display the submenu.

# MIDI

```
[Initial Kit]
▶Tr1/5 Int 0 [Drum kit]
```

4. Select a track pair—Tr1/5, for example.

Use the [S1] soft key or the [<CURSOR] and [CURSOR>] keys to select the first menu item.

Use the [+YES] and [-NO] keys or the [DATA ENTRY] dial to change the track.

5. Select the drum kit bank—Int, for example.

Use the [S2] soft key or the [<CURSOR] and [CURSOR>] keys to select the second menu item.

Use the [+YES] and [-NO] keys or the [DATA ENTRY] dial to change the bank.

6. Select the drum kit number—0, for example.

Use the [S3] soft key or the [<CURSOR] and [CURSOR>] keys to select the third menu item.

Use the [+YES] and [-NO] keys or the [DATA ENTRY] dial to change the drum kit number.

7. Repeat the above three steps for the remaining three track pairs (2/6, 2/7, 4/8). Press the [EXIT] key to return to the SONG SETTING (SP2) page.

8. Use the [PAGE>] key to change to the TRACK STATUS (SP4) page.

```
SP4 TRACK STATUS 100
▶Tr1 Mute D1000 <MIDI>
```

9. (Optional) Set the track status for the song track pairs. Turn off the track assignments for each track (1 and 5) of the song track pair 1/5, for example, by selecting the Mute setting.

Use the [S1] soft key or the [<CURSOR] and [CURSOR>] keys to select the track field.

Use the [+YES] and [-NO] keys or the [DATA ENTRY] dial to change to track 1.

Use the [S2] soft key or the [<CURSOR] and

[CURSOR>] keys to select the track status field.

Use the [+YES] and [-NO] keys or the [DATA ENTRY] dial to change to Mute.

*Note: In order to mute the kit, you must mute both tracks, not just one.*

Repeat the above steps for track 5.

10. Switch to the MIDI submenu.

Use the [S4] soft key to display the submenu.

```
[MIDI] Port Ch
▶Tr2 A+B 01
```

11. Select the MIDI OUT port(s) and the MIDI output channel for the current track.

Use the [S2] soft key or the [<CURSOR] and [CURSOR>] keys to select the MIDI port field.

Use the [+YES] and [-NO] keys or the [DATA ENTRY] dial to change to MIDI port.

Use the [S3] soft key or the [<CURSOR] and [CURSOR>] keys to select the MIDI channel field.

Use the [+YES] and [-NO] keys or the [DATA ENTRY] dial to change the MIDI channel.

Repeat the above steps for tracks 1 – 4. (Changing tracks 5-8 has no effect, however.)

12. If necessary, use the SP2 page's EFFECT submenu to assign an effect program number to the song.

```
[Effect Assign]
Effect=▶00
```

13. Return to the SONG SELECT (SP1) page to assign a name to the song. This data is also stored with the song.

```
SP1 SONG SELECT 100
Int ▶00 [MIDIset1]
```

## 6.4 Synchronizing MIDI Devices

Just as the members of an orchestra keep time with the conductor, the devices in a MIDI network must somehow synchronize themselves with each other. In the simplest network, one MIDI device connected to another, one must be the master; the other, the slave.

### 6.4.1 S3 as Master

In this configuration, the S3 provides the synchronization signal.

#### Connections:

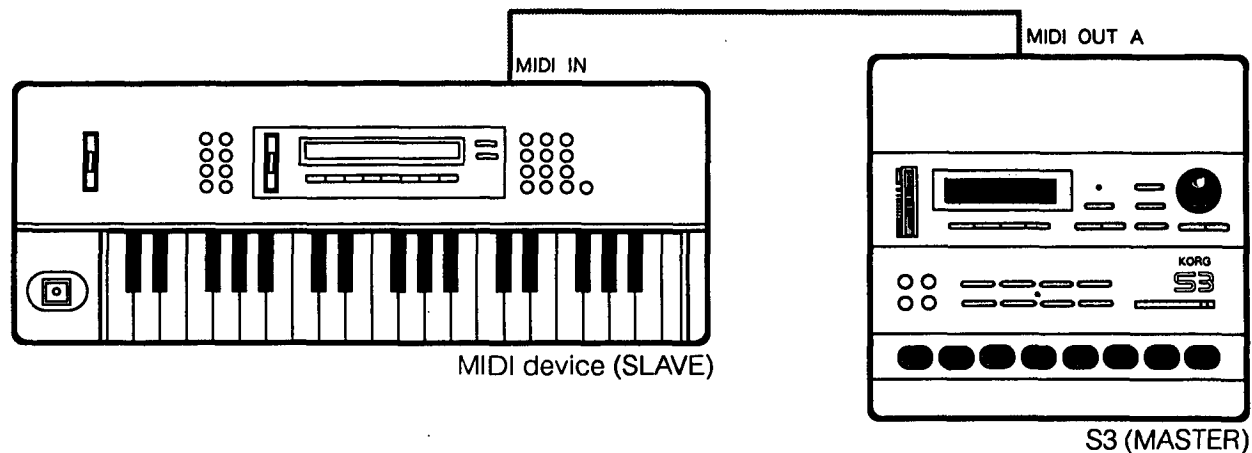

Connect a MIDI OUT port on the S3 to the MIDI IN port on the other MIDI device.

*Note: The examples below assume that the MIDI device is connected to the MIDI OUT A port.*

#### Procedure:

1. Set the slave device's clock mode to EXTERNAL or MIDI. (Consult the Owner's Manual for the device for the appropriate procedures.)
2. On the S3, start with the MIDI OUTPUT (M4) page.
3. Select the port connected to the other MIDI device—PortA, for example.

Use the [S1] soft key or the [<CURSOR] and [CURSOR>] keys to select the first menu item. Use the [+ / YES] and [- / NO] keys or the [DATA ENTRY] dial to select Port A.

4. Put the clock signal switch in its ON position.

Use the [S4] soft key or the [<CURSOR] and [CURSOR>] keys to select the fourth menu item.

Use the [+ / YES] and [- / NO] keys or the [DATA ENTRY] dial to select CLKon.

```
M4 MIDI OUTPUT
PortA   THRUof▶CLKon
```

*Note: Check the other device's MIDI implementation chart. If it supports the alternate type of synchronization, MTC, the third position may also be used.*

5. Switch to the SONG PLAY/REC mode.

# MIDI

6. If necessary, press the other device's [PLAY] key to place it on standby.
7. Press the S3's [PLAY] key to start synchronized playback.

*Note: Check the other device's MIDI implementation chart. If it supports SONG POSITION messages, it may also be possible to start a song in the middle (using the LOCATE function described in 1.2.4 Transport Keys) or to restart a song in the middle after a pause. In certain cases, the timing may be synchronized, but not the song position—that is, the slave device may lag a constant interval behind the master device.*

## 6.4.2 S3 as Slave

In this configuration, the S3 synchronizes itself with a signal from an external source.

### Connections:

Connect the MIDI IN port on the S3 to the MIDI OUT port on the other MIDI device.

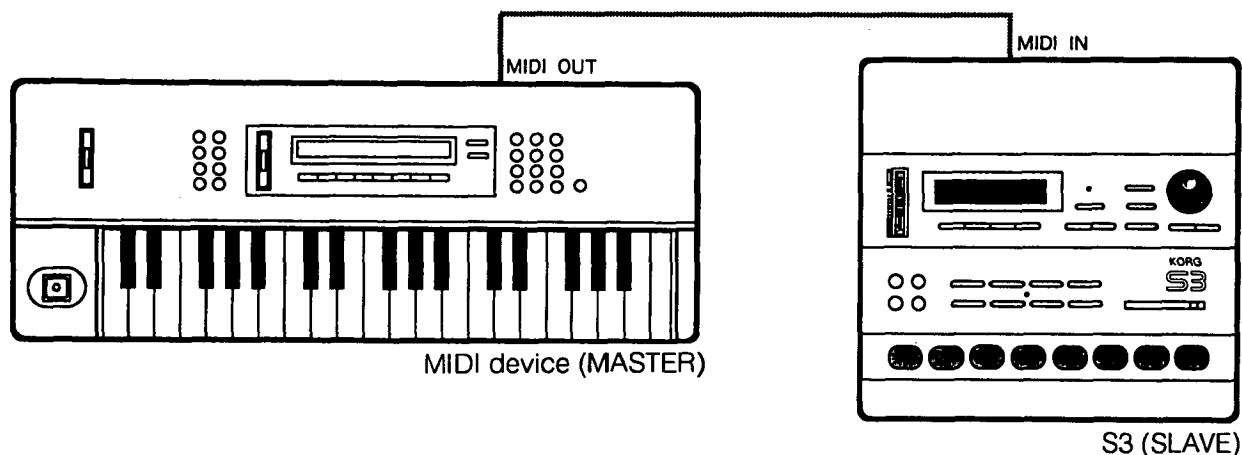

### Procedure:

```
S1 CLOCK      Source Cntrl  
30Frame      ▶MIDI On
```

1. On the S3, start with the SYSTEM mode's CLOCK (S1) page.

2. Set the SOURCE switch to MIDI.

Use the [S3] soft key or the [<CURSOR] and [CURSOR>] keys to select the third menu item.

Use the [+ / YES] and [- / NO] keys or the [DATA ENTRY] dial to select MIDI.

3. Set the Cntrl switch to On to enable both system real-time messages and system common messages.

Use the [S4] soft key or the [<CURSOR] and [CURSOR>] keys to select the fourth menu item.

Use the [+ / YES] and [- / NO] keys or the [DATA ENTRY] dial to select On.

4. Change to the SONG PLAY/REC mode.

5. Set up the master device so that it transmits a clock signal. (Consult the Owner's Manual for the device for the appropriate procedures.)
6. Press the master device's [PLAY] key to start synchronized playback.

*Note: Since the S3 supports MIDI SONG POSITION messages, the master can also direct it to start in the middle of a song. However, in this set up, there is a possibility of the slave having a time lag.*

*Note: It is also possible for the S3 to act as a slave while it is playing or recording a pattern. However, in this case, the MIDI SONG POSITION messages cannot be received and when restarting a song in the middle after a pause, synchronization with the master may be lost.*

# Chapter 7 SMPTE Synchronization

This Chapter describes the use of the Society of Motion Picture and Television Engineers (SMPTE) timing standard for synchronizing the Korg S3 rhythm workstation with film, video and audio devices.

## 7.1 Background

### 7.1.1 What is SMPTE?

The SMPTE timing standard used in motion picture and television production provides a very precise clock for recording times relative to the start of a film or video tape in hours, minutes, seconds and two smaller units—frames and bits. (There are 80 bits per frame. The length of a frame depends on the visual medium. (See 7.1.2 Frame Rates.))

Top-of-the-line commercial film, video and audio equipment use this system because it provides a convenient reference scale of markers giving the complete time right next to the data—on the audio track next to a motion picture frame, for example. This scale always gives the correct position no matter how many times the film or tape has gone back and forth. As a result, the equipment can send signals to other equipment to help them stay synchronized. The S3, for example, uses these signals to reposition the MIDI song pointer.

### 7.1.2 Frame Rates

Visual media divide their data into frames at different rates. These rates range from 24 frames per second for motion pictures to 30 frames per second for the National Television System Committee (NTSC) monochrome television standard used in North America and Japan. The S3's CLOCK (S1) page offers a choice of the following four standards:

NTSC monochrome.....	30 frames/second
NTSC color.....	29.97
European (PAL/SECAM) .....	25
Motion pictures .....	24

## 7.2 Synchronizing with SMPTE Signals

When connected to a tape recorder, the S3 uses SMPTE signals in two ways:

**Recording:** The S3 acts as an SMPTE signal generator for laying down a timing track on the tape recorder.

**Playback:** The S3 synchronizes its operation with the SMPTE timing track on the tape recorder.

*Note: The standard practice is to place the timing track at the edge of the tape—Track 1, for example.*

# SMPTÉ Synchronization

## 7.2.1 Connections

Connect the TIME OUT and TIME IN jacks at the rear of the S3 to the LINE IN and LINE OUT jacks for the timing track on the tape recorder.

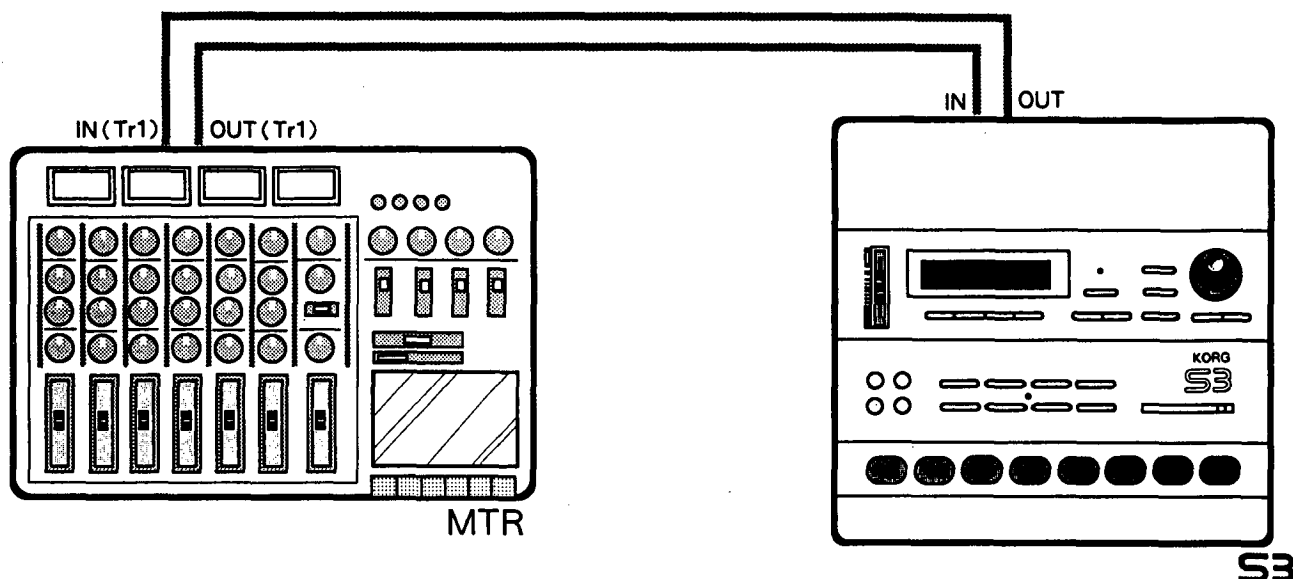

## 7.2.2 CLOCK (S1) Page

This page is for selecting the type of synchronization, the frame rate for SMPTE synchronization and response to such MIDI system real-time messages as STOP and START.

*Note: The default frame rate is 30 frames per second.*

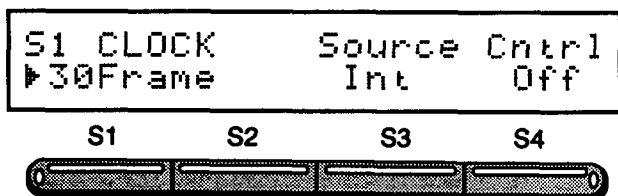

Procedure:

1. Select the frame rate.

Use the [S1] soft key or the [<CURSOR] and [CURSOR>] keys to select the first menu item.

Use the [+YES] and [-NO] keys or the [DATA ENTRY] dial to change the field value.

*Note: This setting applies to both incoming SMPTE timing signals and outgoing ones generated with the TIME CODE GENERATE (S11) page.*

2. Select the external SMPTE clock.

Use the [S3] soft key or the [<CURSOR] and [CURSOR>] keys to select the second menu item.

Use the [+YES] and [-NO] keys or the [DATA ENTRY] dial to change the field value.

Menu key	Field	Field type & possible settings	Description
S1 S2	Frame rate	24Frame /25Frame /29.97Frame /30Frame	Frame rate for SMPTE signals.
S3	Clock source	Int/MIDI/ SMPTE	Clock source: internal clock (Int) for stand-alone operation and for master operation, external MIDI clock (MIDI) for MIDI slave-SMPTE operation or external SMPTE clock (SMPTE) for synchronization with a tape recorder.
S4	Control switch	On/Off	Switch determining whether the S3 responds to (On) or ignores (Off) such MIDI system real-time messages as START, STOP and Song Position Pointer.

# SMPT E Synchronization

## 7.2.3 TIME CODE GENERATE (S11) Page

This page is for striping or recording the SMPTE timing track on the tape recorder.

*Note: As with all recording, a trial run may be necessary to determine the appropriate input level for the tape recorder. A level between -3 dB and -6 dB is usually a good starting point.*

```
S11 TIME CODE GENERATE
*Start ▶00:00:00:00:00
```



Menu key	Field	Field type & possible settings	Description
S1	START/STOP command	*Start/*Stop	Commands to start or stop the signal generator.
	Starting time	00:00:00:00:00 - 23:59:59:29:79	Current time in hours, minutes, seconds, frames and bits (1/80 frame). (Note: These numbers change automatically when the generator is running.)

Procedure:

1. Select the starting time.

Use the [←CURSOR] and [CURSOR→] keys to move between the number fields.

Use the [+ / YES] and [- / NO] keys or the [DATA ENTRY] dial to change the field value.

2. Start the tape recorder.

*Note: If this is a trial run for level adjustment purposes, leave the tape recorder on standby.*

3. Start the signal generator.

Use the [S1] soft key to execute the command.

4. Stop the signal generator.

Use the [S1] key to execute the command.

## 7.2.4 Synchronized Playback

The following procedure shows how to synchronize the S3 with the SMPTE timing signals from a tape recorder.

```
S1 CLOCK          Source Cntrl
30Frame          ▶SMPTE  Off
```



1. Use the CLOCK (S1) page to set the synchronization to external SMPTE signals.

Use the [S3] soft key or the [←CURSOR] and [CURSOR→] keys to select the third menu item.

Use the [+ / YES] and [- / NO] keys or the [DATA ENTRY] dial to change the field value.

2. Select the frame rate.

Use the [S1] soft key or the [←CURSOR] and [CURSOR→] keys to select the first menu item.

Use the [+ / YES] and [- / NO] keys or the [DATA ENTRY] dial to change the field value.

3. Switch to the SONG PLAY/REC mode's SONG SETTING (SP2) page.

```
[Song Start Time] ▲
<Next> ▶00:00:30:00:00
```





# SMPTE Synchronization

4. Use the START TIME submenu to specify the starting time—that is, the tape time signal at which to start playback.

*Note: This starting time field is not the same as the starting time field on the TIME CODE GENERATE (S11) page. The TIME CODE GENERATE page's starting time field determines the first time stamp recorded on the tape. This one specifies how long to wait after that, and therefore it must be later than the first time recorded on the tape. For example, the above screen would produce a 30-second pause if the tape's timing track started at 00:00:00:00:00.*

5. Press the [PLAY] key to put the S3 on standby.

6. Rewind and cue the tape recorder.

7. Start the tape recorder and wait for playback to start.

8. Press the [STOP] key to terminate playback.

*Note: During song playback or recording, the time code signals cannot be sent. Synchronization with the time code signals is also not possible during pattern playback or recording. Furthermore, during SMPTE synchronized playback MIDI clock, start, stop, continue and other such common MIDI synchronization messages cannot be received.*

It is also possible to start playback in the middle of the song:

1. Press the [PLAY] key to put the S3 on standby.

2. Start the tape recorder and wait for playback to start.

*Note: There is usually a slight pause because the calculations involved in converting the incoming SMPTE signals to MIDI song positions take a few bars.*

# Chapter 8 Data Dump Facilities

The S3 offers two basic methods for copying patterns, songs, timbre combinations, drum kit data, global settings and other types of user-defined data to and from external media:

- Directly to and from RAM cards.
- Indirectly via MIDI system exclusive messages to and from another S3 or a disk drive connected to a personal computer or sequencer.

*Note: This Chapter uses the term store for copying data from the S3 to external media and load for copying in the opposite direction.*

The S3 divides its data into the following groups:

**Timbre data:** All TIMBRE mode settings except those on the MONITOR (T6) page for timbres 00 ~ 79.

**Drum kit data:** All KIT mode settings except those on the MONITOR (K6) page for drum kits 0 ~ 9.

**Global/system data:** All MIDI and SYSTEM mode settings except for those on the SYSTEM EXCLUSIVE (S9), CARD (S12) and TIME CODE GENERATE (S11) pages.

**Sequencer data:** All PATTERN and SONG mode settings and data except for the settings on the PATTERN PLAY/REC mode's MONITOR (PP2) page.

*Note: Pattern and song data are always stored together. There is no way to store or load only one or the other.*

## 8.1 Storing Data on Cards

Optional RAM cards (MCR-03) are available for storing up to a total of 31 kilobytes of data.

*Note: Use only cards matching the specifications.*

*Note: Before being used with the S3, a card must be formatted. (See FORMAT Submenu below.)*

*Note: All types except sequencer and global data are stored together in banks. A card may have zero, one or*

*two banks. If there are two, only one bank—specified with the CARD (S12) page's BANK submenu—may be in use at any given time.*

*Note: Every time a new card is formatted a fixed amount of area is set aside for the global data, so even if global data is not saved, the area for other data, such as sequencer data, cannot be expanded.*

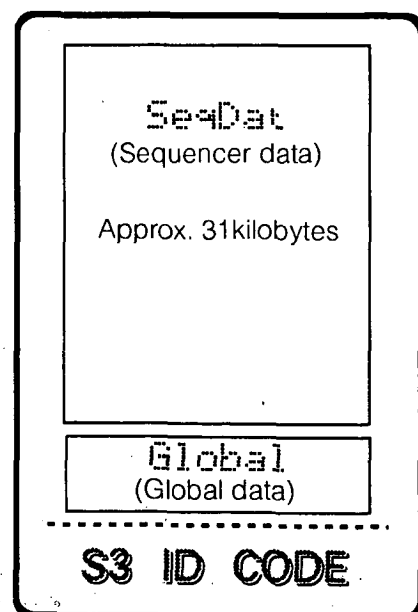
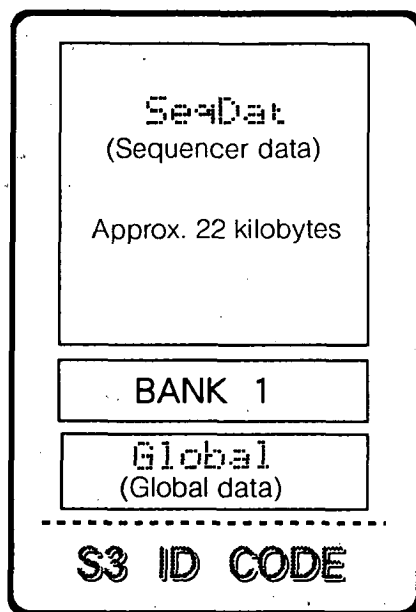
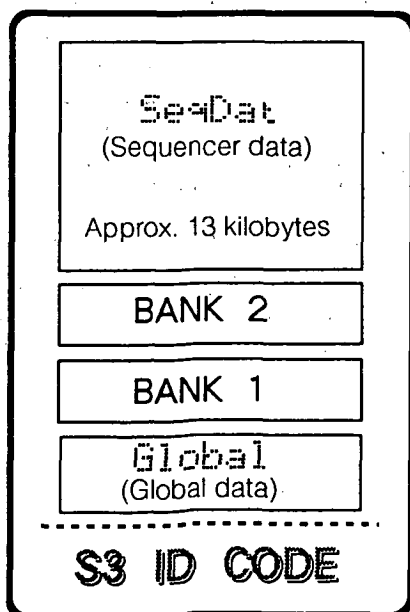

# Data Dump Facilities

## 8.1.1 CARD (S12) Page

This page offers a choice of three submenus for working with banks on the card, transferring (copying) data to and from the card and formatting (initializing) a new card for use with the S3. The current bank is displayed in the right-hand top corner of the LCD screen. If there are no banks defined, the S3 displays No Bank.

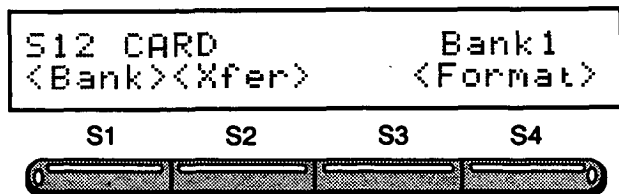

Menu key	Field	Field type & possible settings	Description
S1	BANK submenu	<Bank>	Submenu for creating, deleting and switching banks.
S2	TRANSFER submenu	<Xfer>	Submenu for transferring data to and from the card.
S4	FORMAT submenu	<Format>	Submenu for formatting a new card.

*Note: If no card is inserted, the S12 page cannot be accessed. In addition the sequencer cannot be played on this page.*

### FORMAT Submenu

This page is for formatting (initializing) a new card or a card previously used with some other equipment for use with the S3. Each card must be formatted before it can be used for saving data.

*Note: While it is possible to use other manufacturers' cards meeting the S3's specifications, the S3 warranty does not cover malfunctions or damage which occur to the S3 from the use of such cards.*

*Note: The formatting process destroys all data currently on the card.*

*Note: The formatting process puts a special identification code on the card to indicate that it is for use only with the S3.*

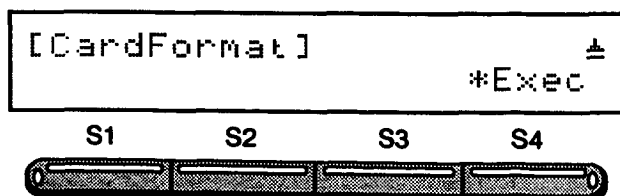

Menu key	Field	Field type & possible settings	Description
S4	EXECUTE command	*Exec	Command to proceed with the operation.

Procedure:

1. Turn the S3's power off, gently insert the card in the RAM slot at the rear of the S3 then turn the S3's power on.
2. Set the write protect switch on the card to its OFF position.
3. Switch to the FORMAT submenu
4. Give the command to proceed.

Use the [S4] soft key (\*Exec) to format the RAM card

Answer the question Sure? (Y/N) with either the [+YES] key to proceed or the [-/NO] key to cancel. You may also use the [EXIT] key to cancel.

### CARD BANK (Bank) Submenu

As mentioned above, a RAM card can have up to two banks of timbre and kit data. This page is for switching between the first and second banks, creating a new bank (if the card has fewer than two banks) and deleting a bank to make room for sequencer data.

*Note: The fewer the number of banks, the more room there is for sequencer data.*

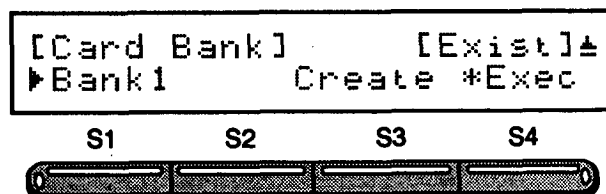

Menu key	Field	Field type & possible settings	Description
S1	Bank	Bank 1/Bank 2	Current bank number.
S2/S3	Operation	Create/Delete	Choice of commands to create a new bank or delete an existing one.
S4	EXECUTE command	*Exec	Command to proceed with the operation.

# Data Dump Facilities

Procedure:

1. Select the bank.

Use the [S1] soft key or the [<CURSOR] and [CURSOR>] keys to select the first menu item.

Use the [+ / YES] and [- / NO] keys or the [DATA ENTRY] dial to change the field value.

*Note: If this is the only change desired, press the [EXIT] key to return to the previous page.*

2. Select the operation (Create or Delete).

Use the [S2] or [S3] soft keys or the [<CURSOR] and [CURSOR>] keys to select the second menu item.

Use the [+ / YES] and [- / NO] keys or the [DATA ENTRY] dial to change the field value.

3. Make the change.

Use the [S4] soft key (\*Exec) to execute the command.

Answer the question Sure? (Y/N) with either the [+ / YES] key to proceed or the [- / NO] key to cancel. You may also use the [EXIT] key to cancel.

4. Press the [EXIT] key to return to the S12 page.

*Note: The S3 automatically optimizes storage space usage, always creating bank 1 before bank 2, and moving the data for bank 2 to bank 1 when bank 1 is deleted.*

*Note: Just after creating a bank, the S3 automatically saves the Preset timbre and kit data to the new bank.*

## CARD TRANSFER (Xfer) Submenu

This page is for transferring (copying) either all data or a particular type of data to and from cards. There is also a "verify" function for checking that the copy is identical to the original.

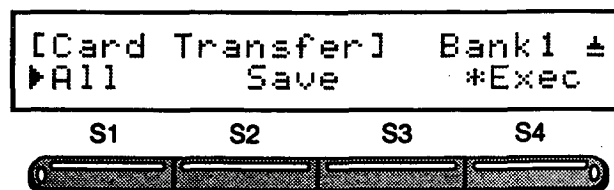

Menu key	Field	Field type & possible settings	Description
S1	Data type	Timbre / Kit / Global / SeDat / All	Type of data to copy.
S2 S3	Operation	Save / Load / Verify	Operation to perform: copy to card (Save), copy from card (Load) or compare internal data with data on card (Verify).
S4	EXECUTE command	*Exec	Command to proceed with the operation.

## 8.1.2 Saving Data to a Card

Procedure:

1. Turn the S3's power off, gently insert the card in the RAM slot at the rear of the S3 then turn the S3's power on.
2. Set the write protect switch on the card to its OFF position.
3. If the card is new, initialize it for use with the FORMAT submenu.
4. If necessary, use the BANK submenu to create a bank on the card or switch banks on the card.
5. Switch to the TRANSFER submenu.

# Data Dump Facilities

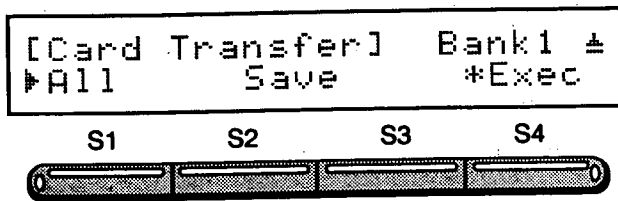

6. Select the type of data to be copied.

Use the [S1] soft key or the [<CURSOR] and [CURSOR>] keys to select the first menu item.

Use the [+ / YES] and [- / NO] keys or the [DATA ENTRY] dial to change the field value.

7. Select the operation (Save).

Use the [S2] soft key or the [<CURSOR] and [CURSOR>] keys to select the second menu item.

Use the [+ / YES] and [- / NO] keys or the [DATA ENTRY] dial to change the field value.

8. Start the operation.

Use the [S4] soft key to execute the command.

Answer the question Sure? (Y/N) with either the [+ / YES] key to proceed or the [- / NO] key to cancel. You may also use the [EXIT] key to cancel.

9. Return the write protect switch on the card to its ON position to prevent accidental erasures.
10. Press the [EXIT] key to return to the S12 page.

## 8.1.3 Loading Data from a Card

Follow this procedure to load data from a card:

1. Turn the S3's power off, gently insert the card in the RAM slot at the rear of the S3 then turn the S3's power on.
2. If necessary, use the BANK submenu to switch banks on the card.
3. Switch to the TRANSFER submenu.

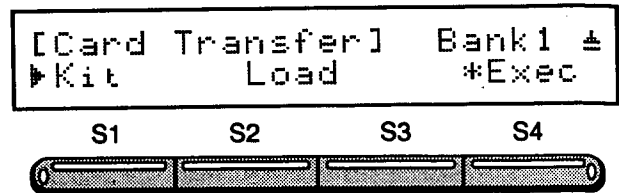

4. Select the type of data to be copied.

Use the [S1] soft key or the [<CURSOR] and [CURSOR>] keys to select the first menu item.

Use the [+ / YES] and [- / NO] keys or the [DATA ENTRY] dial to change the field value.

5. Select the operation (Load).

Use the [S2] soft key or the [<CURSOR] and [CURSOR>] keys to select the second menu item.

Use the [+ / YES] and [- / NO] keys or the [DATA ENTRY] dial to change the field value.

6. Start the operation.

Use the [S4] soft key (\*Exec) to load the data.

Answer the question Sure? (Y/N) with either the [+ / YES] key to proceed or the [- / NO] key to cancel. You may also use the [EXIT] key to cancel.

7. Press the [EXIT] key to return to the S12 page.

*Note: If you try to load data which hasn't already been saved on the card, an error occurs and the Load function is halted. Furthermore, if you select All data for a Load and certain types haven't already been saved, loading will continue, but error messages will warn you about the unsaved (and therefore unloaded) data types.*

# Data Dump Facilities

## 8.2 Exchanging Data via MIDI

The MIDI DATA DUMP, a function originally designed for transferring patch data from one S3 to another using MIDI system exclusive messages, provides access to the much greater storage capacities available on disk drives attached to personal computers, sequencers and other MIDI data recorders.

### 8.2.1 SYSTEM EXCLUSIVE (S9) Page

This page is for transferring either all data or just a particular type to and from a compatible external MIDI device—that is, another S3 or a MIDI data recorder. To transmit (send) data, use the MIDI DUMP subpage; to receive data, use the COMMUNICATION mode.

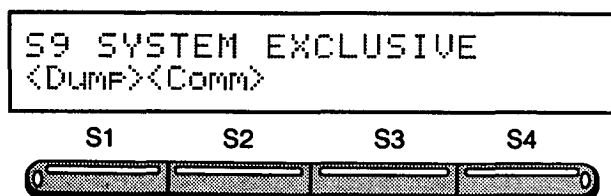

Menu key	Field	Field type & possible settings	Description
S1	MIDI DUMP submenu	<DUMP>	Submenu for MIDI dump.
S2	Communication mode	<Comm>	Submenu to start Communication mode.

*Note: The S9 page's MIDI send and receive channel is set in the MIDI mode's GLOBAL CHANNEL (M5) page. If this channel isn't set properly, data input output problems may arise. (See 6.2.5 GLOBAL CHANNEL (M5) Page.)*

### 8.2.2 MIDI DUMP (Dump) Submenu (Transmitting Data)

Use the following procedure to transmit timbres, drum kits, sequencer data, etc. to a compatible external MIDI device.

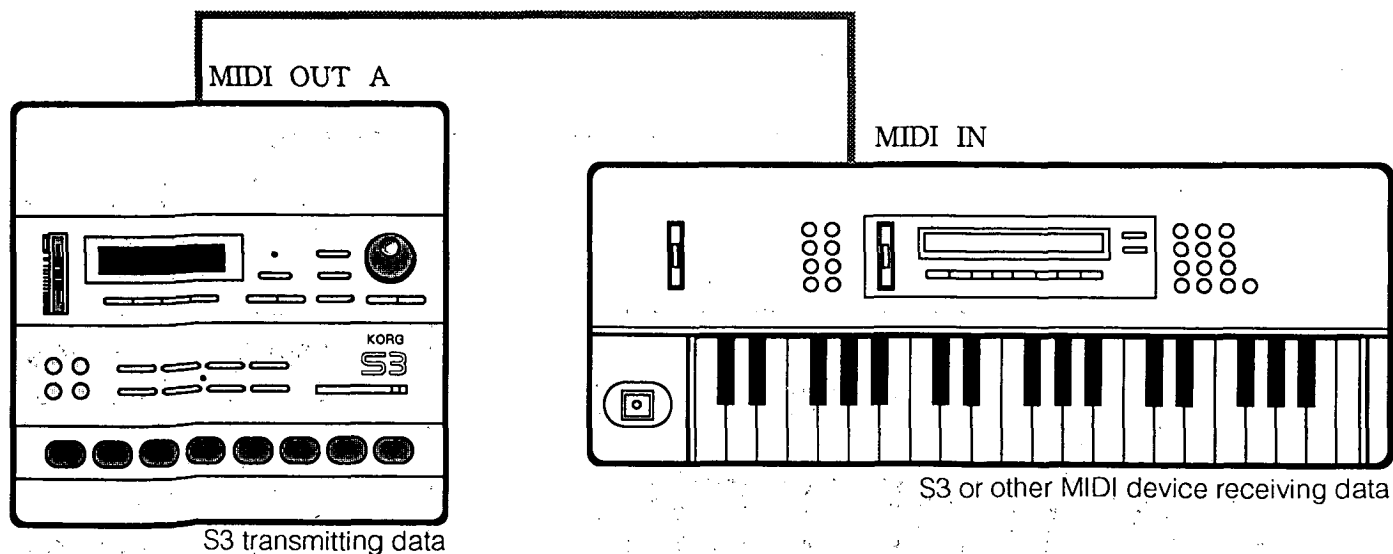

# Data Dump Facilities

Procedure:

1. Connect a MIDI OUT port to the MIDI IN port on the device to receive the data.
2. Switch to the MIDI DUMP submenu

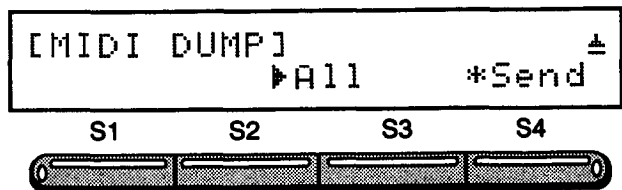

Menukey	Field	Field type & possible settings	Description
	Data type	Timbre/Kit/ Global/ Se+Dat/All	Type of data to copy.
S4	SEND command	*Send	Command to start transmission of MIDI system exclusive messages to the MIDI OUT ports.

3. Select the type of data to be transmitted (All, in this example).

Use the [+ / YES] and [- / NO] keys or the [DATA ENTRY] dial to change the field value.

4. Set up the external MIDI device so that it is ready to receive.

*Note: The procedure for the S3 appears below. For other MIDI devices, consult the Owner's Manual for the device.*

5. Start the transmission.

Use the [S4] soft key (\*Send) to send the data.

Answer the question Sure? (Y/N) with either the [+ / YES] key to proceed or the [- / NO] key to cancel. You may also use the [EXIT] key to cancel and return to the MIDI DUMP submenu.

6. Wait for the transmission to end.

7. Press the [EXIT] key to return to the S9 page.

## 8.2.3 COMMUNICATION Mode (Comm) (Receiving Data)

Use the following procedure to receive timbres, drum kits, sequencer data, etc. from a compatible external MIDI device. In the COMMUNICATION mode, the S3 can receive system exclusive messages, among others.

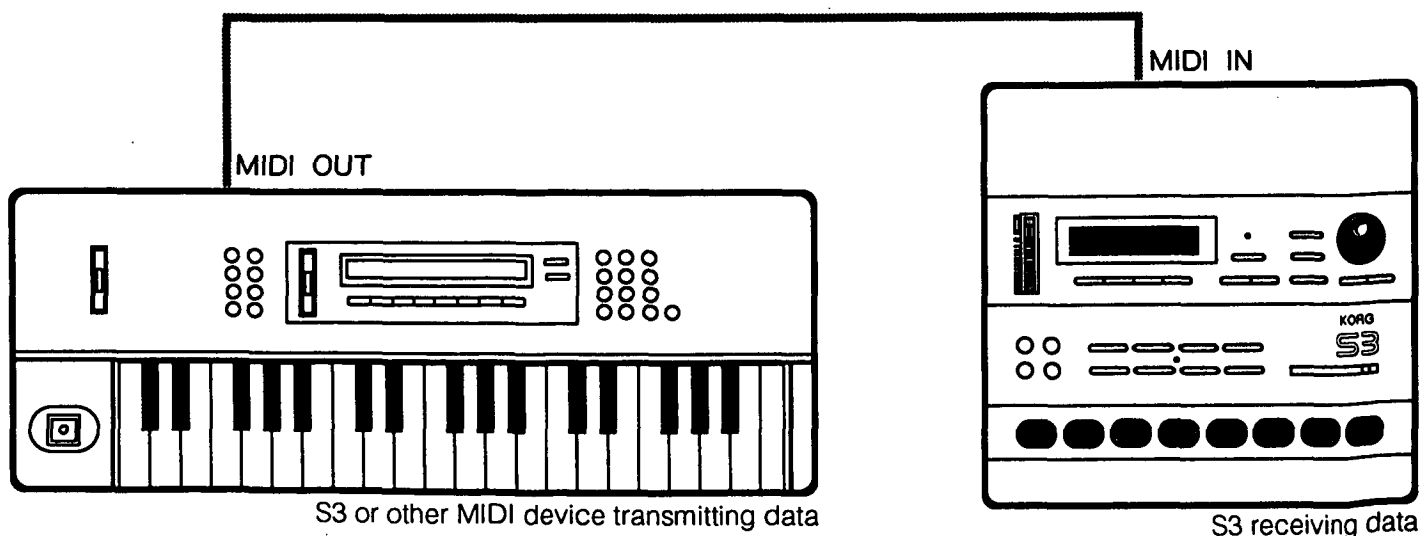

# Data Dump Facilities

Procedure:

1. Connect the S3's MIDI IN port to the MIDI OUT port on the device to transmit the data.

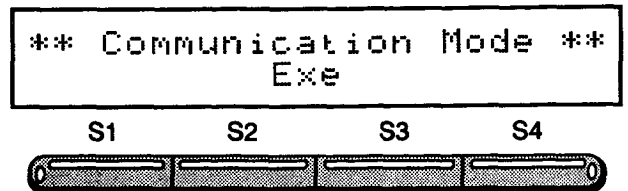
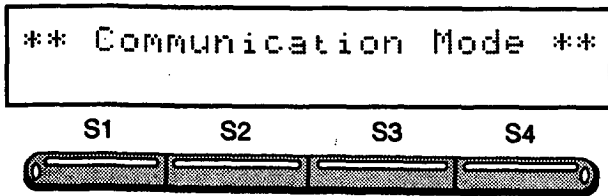

*Note: The start of transmission is indicated by an Exe message on the screen. If there is a problem, an Err message will appear. Please check all connections, and try again.*

2. Place the S3 on standby.

Switch to the SYSTEM EXCLUSIVE (S9) page.

Use the [S2] soft key to switch to the COMMUNICATION mode

*Note: Use the [EXIT] key to cancel.*

3. Transmit data from the external MIDI device.

*Note: The procedure for the S3 appears above. For other MIDI devices, consult the Owner's Manual for the device.*

4. Wait for the transmission to end.

5. Press the [EXIT] key to return to the S9 page.



# Chapter 9 SYSTEM Mode

This Chapter describes the pages in the SYSTEM mode. It assumes basic familiarity with the menu editing procedures, so it omits detailed procedures.

## 9.0.1 CLOCK (S1) Page

This page is for selecting the type of synchronization (internal, external MIDI or external SMPTE), the frame frequency for SMPTE synchronization (24 ~ 30 frames per second) and the response to such MIDI system real time messages as STOP and START, etc.

*Note: For further information, see Chapter 7 SMPTE Synchronization.*

## 9.0.2 TUNE (S2) Page

This page is for tuning all S3 output—first in semitones and then in smaller units called cents.

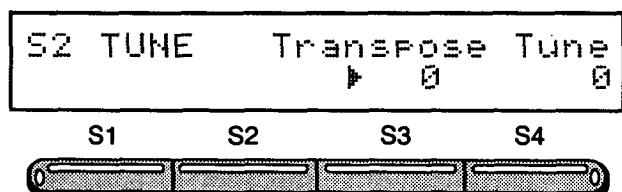

Menu key	Field	Field type & possible settings	Description
S3	Transposition value	-12 ~ +12	Amount, in semitones and direction (+/-) of transposition.
S4	Tuning value	-50 ~ +50	Size, in cents and direction (+/-) of the tuning.

## 9.0.3 EFFECT (S3) Page

This page is the starting point for all effect editing operations.

*Note: For complete information, see Chapter 5 Effects.*

## 9.0.4 METRONOME (S4) Page

This page controls the built-in metronome.

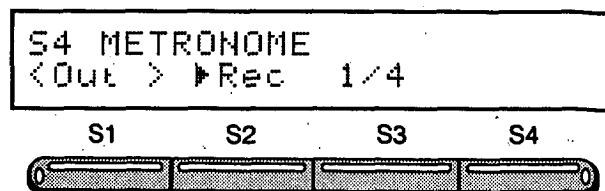

Menu key	Field	Field type & possible settings	Description
S1	OUT submenu	<Out >	Submenu for selecting the metronome's output channel, level and stereo balance.
S2	ON/OFF switch	On / Off / Rec	Switch controlling metronome operation: always on (On), always off (Off) or on for recording only (Rec).
S3	Resolution	1/2 / 1/4 / 1/4T / 1/8 / 1/8T / 1/16 / 1/16T / 1/32	Timing interval for the metronome. The letter "T" after a selection denotes triplets.

### OUT Submenu

This submenu is for selecting the metronome's output channel, level and stereo balance.

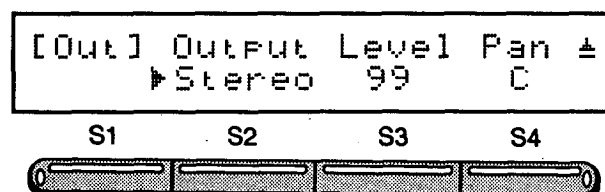

Menu key	Field	Field type & possible settings	Description
S2	Output channel	Stereo / Multi 1-4	Output destination: STEREO OUT jacks or a MULTI OUT jack.
S3	Level	1-99	Output volume.
S4	Pan setting	R15 -C- L15	Stereo position: choice of 31 positions from R15 (right only) through C (center) to L15 (left only). (Note: This setting applies only to the STEREO OUT jacks.)

# SYSTEM Mode

## 9.0.5 ROLL/FLAM (S5) Page

This page controls rolls and flams. It also has a monitor function. When the cursor is on the roll field, the touchpads produce rolls. When it is on either of the flam fields, however, they produce flams.

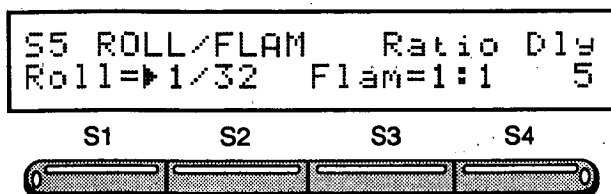

*Note: The roll quantization and flam delay settings apply only to live performances. During recording, such note spacings are overridden by the recording quantization function. To make sure high roll quantizations and short flam delays are effected, use the High resolution setting on the REC READY display's recording resolution to disable the quantizing function.*

*Note: When input is coming to the MIDI IN port, the ROLL/FLAM function has no effect.*

Menu key	Field	Field type & possible settings	Description
S1 S2	Roll quantization	1/4/1/4T/1/8/ 1/8T/1/16/1/16 T/1/32/1/32T	Resolution of notes in roll. The letter "T" after a selection denotes triplets.
S3	Flam ratio	1:1/1:2/1:4/ 1:8/1:16/1:32	Ratio of the volume of the second note to the first. ( <i>Note: This field uses ratios instead of fractions to avoid confusion with the roll quantization. The setting 1:32, for example, makes the second note 32 times louder than the first.</i> )
S4	Flam delay	01 -10	Delay between flam notes.

## 9.0.6 PAD MODE (S6) Page

This page allows the user to assign a scale to the eight touchpads to simulate the feel of a regular MIDI keyboard. This is useful for recording a bass part, for example. In addition, this pad data is output through the MIDI out ports.

*Note: If any selection other than Normal is made, this page ignores the [PAD BANK/TEMPO] key.*

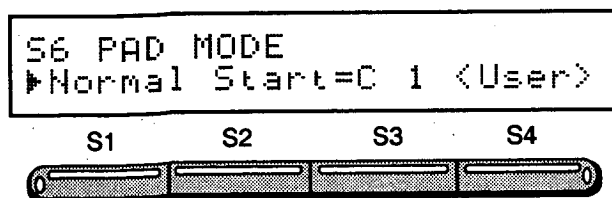

Menu key	Field	Field type & possible settings	Description
S1	Mode	Normal /Major / Chroma /User	Type of scale: note numbers assigned to individual pads with the NOTE ASSIGN (K5) page (Normal), major scale (Major), semitone scale (Chroma) or user-defined scale (User).
S2 S3	Starting note	C-1 -69	The starting point for the scale (usually the note for touchpad #1).
S4	USER submenu	<User>	Submenu for assigning a user-defined scale to the touchpads.

*Note: When the Normal, Major or Chromatic mode is selected, changes on the USER submenu are ignored.*

# SYSTEM Mode

Examples:

If the starting note is G3, the Major selection produces the following scale.

## Major



If the starting note is C3, the Chroma selection produces the following scale.

## Chroma

*Note: Because the highest note possible is G9, any scale created which supercedes this limit contains extra touchpads assigned to G9.*



## USER Submenu

This page is for assigning an arbitrary scale to the touchpads. The scale is defined as a series of intervals relative to the starting note defined on the previous page.

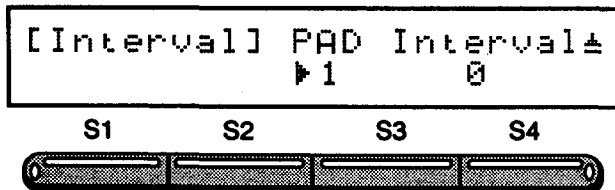

Menu key	Field	Field type & possible settings	Description
S2 S3	Touchpad number	1-8	Number of the touchpad to be assigned a note.
S4	Interval	-12 →+12	Difference, in semi-tones, between the note for the touchpad and the starting note.

# SYSTEM Mode

The example below creates the following user-defined scale with a starting note of C3.

1 : C3	2 : D3	3 : F3	4 : G3	5 : A3	6 : C4	7 : A # 2	8 : F # 2
--------	--------	--------	--------	--------	--------	-----------	-----------

Procedure:

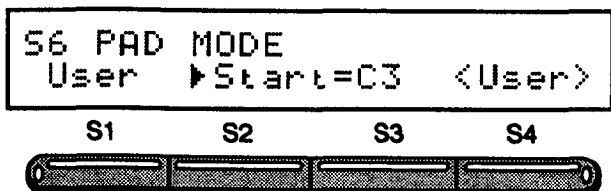

1. Use the PAD MODE (S6) page to choose the User scale.

Use the [S1] soft key or the [<CURSOR] and [CURSOR>] keys to select the first menu item.

Use the [+ / YES] and [- / NO] keys or the [DATA ENTRY] dial to change to User.

2. Set the starting note—C3, for example.

Use the [S2] or [S3] soft keys or the [<CURSOR] and [CURSOR>] keys to select the second menu item.

Use the [+ / YES] and [- / NO] keys or the [DATA ENTRY] dial to change the starting note.

3. Switch to the USER submenu.

Use the [S4] soft key to display the submenu.

4. Select the touchpad number.

Use the [S2] or [S3] soft keys or the [<CURSOR] and [CURSOR>] keys to select the third menu item.

Use the [+ / YES] and [- / NO] keys or the [DATA ENTRY] dial to change the field value.

5. Select the interval for the touchpad.

Use the [S4] soft key or the [<CURSOR] and [CURSOR>] keys to select the fourth menu item.

Use the [+ / YES] and [- / NO] keys or the [DATA ENTRY] dial to change the field value.

6. Repeat the above two steps for all touchpads.

7. Press the [EXIT] key to return to the S6 page.

## Example of an Arbitrary Touchpad Scale

PAD	2	3	4	5	6	7	8
Interval	+2	+5	+7	+9	+12	-2	-6

# SYSTEM Mode

## 9.0.7 PAD SENSITIVITY (S7) Page

This page and its SET submenu determine the relationship between touchpad key velocity and output volume.

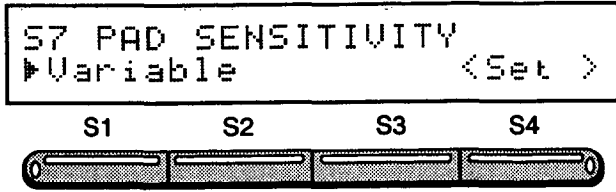

Menukey	Field	Field type & possible settings	Description
	Fix/Variable	Fix/Variable	Switch determining whether to use flat response with a constant output switch level (Fixed) or to make output level depend on key velocity (Variable).
S4	SET submenu	<Set >	Submenu for specifying the output level and the volume-velocity curve.

### SET Submenu

This page is for specifying the output level and volume-velocity response curve.

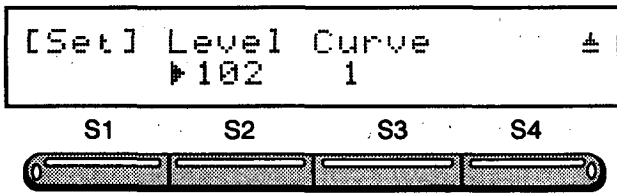

Menukey	Field	Field type & possible settings	Description
S2	Level	2-126	Output level for the Fixed sensitivity—that is, flat response and constant output level. (If Variable sensitivity was chosen, changing the output level has no effect.) This is also the output level for an assigned foot-switch. Moreover, if the REC MESSAGE FILTER's Velocity is On, this fixed output level is used.
S3	Curve	1-8	Curve (1 - 8) for the Variable sensitivity. (If Fixed sensitivity was chosen, changing the curve number has no effect.)

Note: A foot switch assigned to a touchpad always uses the fixed response. See FOOT SWITCH (S8) page below. Refer to the 6.2.2 REC MESSAGE FILTER (M2) Page for more on how to fix the velocity output level.

### Eight Possible Curve Choices

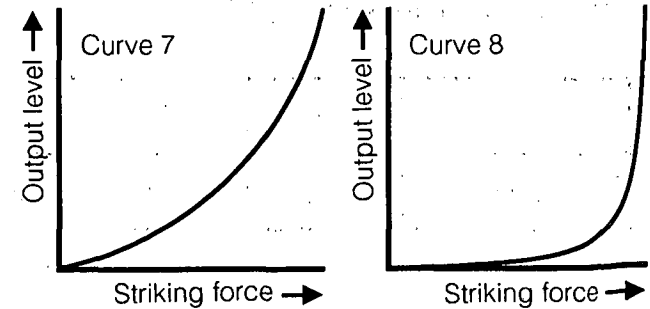
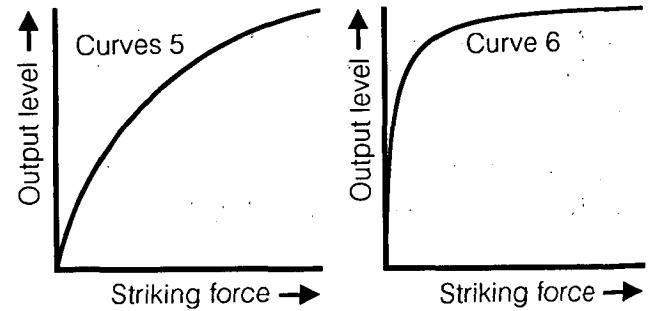
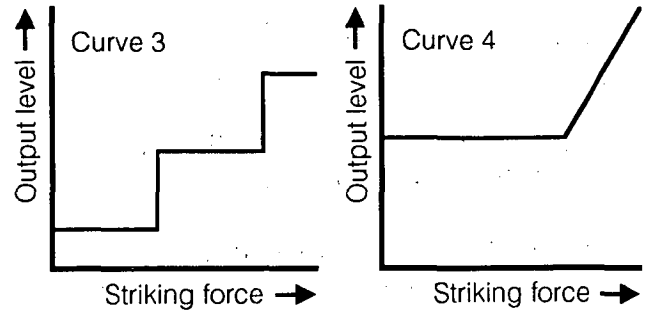
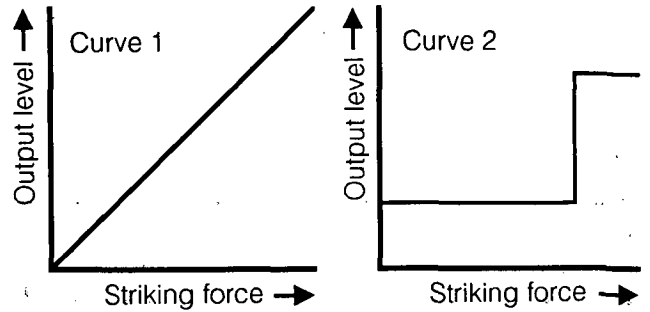

# SYSTEM Mode

## 9.0.8 FOOT SWITCH (S8) Page

This page tells the S3 how to interpret signals from the two FOOT SW input jacks.

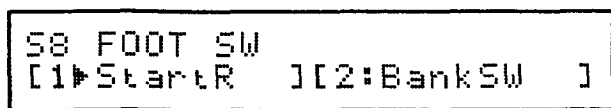

Menukey	Field	Field type & possible settings	Description
S1 S2	Switch #1 assignment	StartR/ StartC/ BankSw/ PAD1 -16/0ff	Interpretation of signal from first foot switch: START/STOP/RESTART switch (StartR), START/PAUSE/CONTINUE switch (StartC), bank switch (Bank Sw), touchpad stroke (PAD1 - PAD16) or disabled (Off).
S3 S4	Switch #2 assignment	StartR/ StartC/ BankSw/ PAD1 -16/0ff	Interpretation of signal from second foot switch.

*Note: The StartR and StartC settings start playback, but their stop functions parallel the difference between the [STOP] and [PAUSE] transport keys: the former terminates playback so that the next START signal (from a foot switch or the [PLAY] key) restarts from the beginning; the latter simply introduces a pause so that the next START signal causes playback to resume at the current position.*

*Note: A foot switch assigned to a touchpad always has a flat response curve with a constant output level specified on the PAD SENSITIVITY (S7) page's SET submenu.*

Procedure:

1. Select the assignment for the first foot switch.

Use the [S1] or [S2] soft keys or the [<CURSOR] and [CURSOR>] keys to select the first menu item.

Use the [+ / YES] and [- / NO] keys or the [DATA ENTRY] dial to change the field value.

2. Select the assignment for the second foot switch in a similar manner.

## 9.0.9 SYSTEM EXCLUSIVE (S9) Page

This page controls the transmission of S3 programming data between one S3 and another using MIDI SYSTEM EXCLUSIVE messages.

*Note: For further information, see Chapter 8 Data Dump Facilities.*

## 9.0.10 TIME CODE GENERATE (S10) Page

This page controls the generation of SMPTE time codes for recording on the timing track of a tape recorder.

*Note: For further information, see Chapter 7 SMPTE Synchronization.*

## 9.0.11 FREE MEMORY (S11) Page

This page tells how much space (bytes) has been used on the RAM card and in the internal bank. When a card is not inserted or an improper card is inserted, an error occurs and the card's free memory is shown by the ? marks. This page is for information purposes only. Nothing on it can be changed.

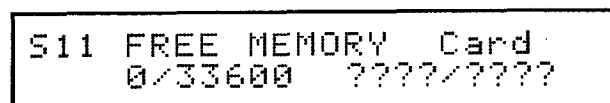

*Note: While the capacity of the internal bank is fixed at 33600 bytes, the RAM card's available sequencer data capacity varies according to the number of banks:*

Banks	Sequencer Capacity (bytes)
0	31,232
Bank 1 only	22,272
Banks 1 & 2	13,312

*Note: Because the maximum capacity of the internal sequencer memory is still larger than a card's memory without banks, it is necessary to perform the following procedure to save the internal memory to cards:*

Procedure:

1. Format two or more RAM cards.
2. Use the PATTERN COPY (PE9) page to save patterns to one card.
3. Use the SONG COPY (SP7) page to save songs to another card.

## **9.0.12 CARD (S12) Page**

This page controls the transmission of S3 programming data between the S3 internal bank and a data bank on a RAM card. It also provides facilities for formatting (initializing) cards for use with the S3.

*Note: For further information, see Chapter 8 Data Dump Facilities.*

# Appendix A: Error and Warning Messages

## A.1 All Modes

The following messages can appear in any mode:

```
** No Card Inserted **  
Press Any Key...
```

The unit is unable to complete the specified read or write operation because there is no card in the corresponding slot. Insert a card and repeat the operation.

```
** Invalid Card **  
Press Any Key...
```

The corresponding card is either for a different machine, uninitialized (unformatted), or not MCR-Q3 format. In the latter case, the card must first be initialized for use with the S3 using the FORMAT submenu on the CARD (S12) page. (See 8.1.1 *CARD (S12) Page*.)

```
*ROM or Protected Card *  
Press Any Key...
```

The corresponding card is either a read-only (ROM) card or a RAM card with its write protect switch in the ON position. Either change cards or set the RAM card's write protect switch to the OFF position.

```
*** MIDI FiFo Full ***  
Press Any Key...
```

The MIDI input (FiFo- first-in, first-out) buffer has overflowed. In other words, MIDI data has been coming in too fast for the S3.

```
*** Card Removed ***  
Press Any Key...
```

There is no card in the PCM or program slot. Check the slots and insert (or reinsert) cards as necessary.

---

## A.2 Pattern and Song Modes

The following messages can appear in either the SONG or PATTERN modes:

```
Warning:32 Poly Overflow  
Press Any Key...
```

The total number of notes requested on all tracks during playback or recording exceeds the unit capacity of 32 polyphonic sound sources.

```
** Kit Input Error **  
Press Any Key...
```

The sequencer track already contains a drum kit change at the current position. Either delete or edit the existing change.

```
** Rep Input Error**  
Press Any Key...
```

The requested repeat command either has no pattern data to repeat or would exceed the limit of four nesting levels. In the former case, arrange pattern data before using the repeat command.

```
*** Now Converting ***  
*****
```

The S3 is busy converting the raw pattern or song data in the recording buffer into sequencer format.

*Warning: Interrupting this process can lead to irretrievable loss of sequencer data.*



# Error and Warning Messages

```
** Rec Buffer Full **  
Press Any Key...
```

There is too much raw pattern or song data to fit in the recording buffer. When this error occurs, the S3 automatically converts the data, allowing the user to begin recording again.

```
** Edit Buffer Full **  
Press Any Key...
```

There is too much pattern or song data in the edit buffer. Either eliminate unnecessary data or edit the data one range at a time.

```
*** MemoryFull ***  
Press Any Key...
```

There is no more room for pattern and song data in the specified storage area (internal memory or RAM card). Make room with the PATTERN CLEAR (PP6 or PE13) pages or the SONG CLEAR (SP8 or SE9) pages.

*Note: Another possibility is the CARD (S12) page's CARD BANK DELETE function; but it may be too drastic as it eliminates all timbre and drum kit data in the bank as well.*

*Note: Use the FREE MEMORY (S11) page often to avoid this type of error.*

```
*** Illegal Range ***  
Press Any Key...
```

The result of a BLANK INSERT (PE7) page command or PATTERN APPEND (PE10) page command would exceed the length limit of 99 bars per pattern.

```
*PunchIn/OutPointErr*  
Press Any Key...
```

The specified PUNCH OUT point (REC MODE (SP5) page) is before the PUNCH IN point. Reverse the two specifications and repeat the operation.

```
** Pattern Exist **  
OverWrite?(Y/N)
```

The specified destination for the PATTERN COPY (PE9) page's command already contains data. Press the [+ / YES] key to replace that data with the new or press the [- / NO] key to cancel.

```
*** Song Exist ***  
OverWrite?(Y/N)
```

The specified destination for the SONG COPY (SP7) page's command already contains data. Press the [+ / YES] key to replace that data with the new or press the [- / NO] key to cancel.

```
Warning:Tr Size Mismatch  
Song Track > PTN Track
```

The song track is longer than the pattern track. Proceeding with the operation renders the excess portion of the song track inaccessible for further editing or length adjustments. Either lengthen the pattern track or delete bars to shorten the song track. (See Chapter 3 *PATTERN and SONG Modes*.)

# Error and Warning Messages

```
** Measure Overflow **  
Press Any Key...
```

The result of an ARRANGE (P3) page command would exceed the length limit of 999 bars per song.

```
**Time Offset Overflow**  
Press Any Key...
```

The TOTAL TIME specification on the SONG SETTING (SP2) page's submenu would require a tempo outside the supported range (40-250).

```
*** No song Range ***  
Press Any Key...
```

There is no range specification for the BLANK INSERT command on the SONG EDIT mode's TRACK EDIT menu screen. Specify a range and repeat the command.

---

## A.3 Instrument Mode

The following message appears only in the INSTRUMENT mode:

```
*** No Card Bank ***  
Press Any Key...
```

The card does not have a bank to hold the copy of the specified timbre or drum kit data. Use the CARD (S12) page's BANK CREATE command to create the bank and then repeat the copy operation.

---

## A.4 System Mode

The following messages can appear only in the SYSTEM mode:

```
** Communication Mode **  
Err
```

The S3 has detected an error in the incoming SYSTEM EXCLUSIVE data. Check the MIDI setup—connectors, cables, interface settings, etc.—and restart the data transfer from the sending equipment.

*Note: If the S3's Communication Mode cuts off the data transfer, it initializes only the function in which the error occurred.*

```
Warning:Card Memory Full  
Data Size>Card Memory
```

The pattern and song data in the internal memory is too big to transfer to the sequencer data area on the RAM card with the CARD (S12) page's TRANSFER command.

```
*** No Card Bank ***  
Press Any Key...
```

The card bank specified as the destination for copying the specified data—timbre, drum kit or ALL—with the CARD (S12) page's TRANSFER submenu's SAVE command does not exist. Use the CARD (S12) page's BANK CREATE command to create the bank and then repeat the copy operation.

# Error and Warning Messages

```
** Memory Compress **  
Bank2->Bank1(Press Key)
```

You have used one of the CARD BANK CREATE or CARD BANK DELETE commands incorrectly—that is, have tried either to create bank 2 on a card without bank 1 or to delete bank 1 on a card with bank 2. The former case results in the creation of bank 1; the latter, the automatic transfer of all data from bank 2 to bank 1 followed by the deletion of bank 2.

*Note: For further details, see 8.1 Storing Data on Cards.*

```
*** No Timbre Data ***  
Press Any Key...
```

The CARD (S12) page's CARD LOAD command cannot find the specified type of data on the card.

*Note: Specifying ALL causes the command to repeat once for each of the four data types: sequencer, timbre, drum kit and global. Pressing any key clears the error message and causes the command to continue with the remaining types.*

```
*** Verify Error ***  
Press Any Key...
```

The CARD (S12) page's CARD VERIFY command has found an error. In other words, the data in the internal memory and on the card do not match.

```
** Verify Complete **  
Press Any Key...
```

The CARD (S12) page's CARD VERIFY command has succeeded. In other words, the data in the internal memory matches that on the card.

```
** Card Save Error **  
Press Any Key...
```

The CARD (S12) page's CARD SAVE command has been interrupted by premature removal of the destination card. Reformat the card because the data on it is not valid.

```
** Card Load Error **  
Please Initialize!
```

The CARD (S12) page's CARD LOAD command has been interrupted by premature removal of the source card. Turn off the S3 and perform an All System Initialize because the internal data is not valid. (To re-initialize, hold the S1 soft key and the STOP transport key during power up and then press the +/yes key.)

# Appendix B: Troubleshooting

The following pages outline procedures that you can use to diagnose and correct some of the more common problems with your S3.

The first step, however, is to determine whether the problem lies in the S3 itself or in the cables and other equipment connected to it:

- Plug a pair of headphones into the S3. If they produce output, check the external equipment as well as the connections between them and the S3.
- Switch the S3 off for a minute or two and then back on to see if noise from the AC power lines or radio frequency interference from equipment in the immediate vicinity has disrupted the microprocessor's operation.

- Remove and reinsert the ROM card several times to dislodge any foreign matter than may be blocking the card connector pins.
- Try changing drum kits and timbres. If the symptoms persist, the problem is most likely not in the voice generators, but elsewhere—the MIDI IN connector, for example.
- Try disconnecting the cable from the MIDI connector.

Hereafter is a list of common problems, their probable causes and possible solutions.

## 1. Nothing appears on the screen when the unit is switched on.

CAUSE	POSSIBLE SOLUTION
The AC adaptor is not securely connected to the S3 or the electrical outlet.	Check the electrical connections.
The display contrast is too low.	Adjust the contrast with the control located on the bottom panel of the S3.

## 2. There is no sound.

CAUSE	POSSIBLE SOLUTION
The output wires or MIDI cables to other equipment are not securely connected.	Check the connections at both ends.
The volume controls on the S3 and external equipment are set too low.	Adjust the volumes.
The PATTERN MONITOR (PP2) page's status is set to Mute or Ext.	Change to Both or Int.
The SONG MONITOR (SP4) page's status is set to Mute or Ext.	Change to Both or Int.
The TIMBRE ENVELOPE (T3) page's settings are incorrect.	Enter new settings either manually or by copying a preset timbre with the TIMBRE COPY (T7) page.
The timbre exceeds the limit on voices (12 notes simultaneously).	Either reduce the number of voices or reserve the necessary voices with the PAD MODE (K3) page.
The PAD EDIT (P3) page's RESPONSE CURVE settings are incorrect.	Enter new settings either manually or by copying a preset drum kit with the KIT COPY (K7) page.
The PAD EDIT (P3) page's OUTPUT settings are incorrect.	Enter new settings either manually or by copying a preset drum kit with the KIT COPY (K7) page.
The metronome does not sound because the METRONOME (S4) page's settings are incorrect.	Set the metronome ON/OFF switch to On (or REC) and adjust the output settings.

# Troubleshooting

## 3. The output volume is too low or does not vary with force on the pads.

CAUSE	POSSIBLE SOLUTION
The PAD SENSITIVITY (S7) page is set to Fix.	Change the setting to Variable and select an appropriate response curve.
The PAD FIX level (S7 page) is too low.	Raise the level.
The PAD (P3) page's RESPONSE curve is not appropriate.	Enter new settings either manually or by copying a preset drum kit with the KIT COPY (K7) page.
The PAD LEVEL (K4) page's OUTPUT setting is 1.	Raise the level.

## 4. Pressing the PLAY key does not start the sequencer.

CAUSE	POSSIBLE SOLUTION
The CLOCK (S1) page's SOURCE setting is MIDI or SMPTE.	Change the setting to Int.
The song contains either no patterns or empty patterns.	Use the ARRANGE (SP3) page to construct a song from patterns. If a pattern appears as a question mark (?), it has yet to be recorded.

## 5. Switching from a PATTERN mode to a SONG mode changes the tone color.

CAUSE	POSSIBLE SOLUTION
The SONG SETTING (SP2) page's INITIAL KIT setting for a track is hasn't been assigned yet.	Assign initial drum kits to all tracks.

## 6. The tone color of a pattern has changed.

CAUSE	POSSIBLE SOLUTION
You have edited the pad settings with the PAD ARRANGE (K2) page.	Restore the settings either manually or by copying a preset drum kit with the KITCOPY (K7) page.

## 7. Editing does not change the tone color.

CAUSE	POSSIBLE SOLUTION
You are trying to edit a preset timbre or preset drum kit.	Copy it to the internal memory and edit it there.

## 8. The S3 does not record.

CAUSE	POSSIBLE SOLUTION
The REC CHANNEL SELECT (M1) page's setting does not match the transmitting channel.	Change the setting to either All or the correct channel.
The REC MESSAGE FILTER (M2) page's function is operative.	Turn off the filters for the types of MIDI messages to be recorded.
The RECEIVE FILTER (M3) page's function is operative.	Turn off the filters for the types of MIDI messages to be recorded.
You are trying to record a pattern or song on a card.	Record to the internal memory and then copy the result to the card.

## 9. The S3 does not record flams and rolls.

CAUSE	POSSIBLE SOLUTION
The REC READY display's recording resolution setting is too coarse.	Change the setting to High during the standby (REC READY) state. <i>Note: The S3 cannot record flams and rolls from an external MIDI keyboard.</i>

# Troubleshooting

## 10. A song plays back at a different tempo.

CAUSE	POSSIBLE SOLUTION
The SONG SETTING (SP2) page's INITIAL TEMPO setting differs from the desired tempo.	Change the setting.
The SONG SETTING (SP2) page's TEMPO MAP settings differ from the desired tempos.	Change the settings or clear the entire map.

## 11. Playback uses a different drum kit.

CAUSE	POSSIBLE SOLUTION
The song contains a spurious drum kit change.	Use the SONG ARRANGE (SP3) page's DELETE command to eliminate the drum kit change. Or choose the correct drum kit.
A pattern or song track contains a spurious program change message.	Use the PATTERN ERASE (PE12) page or the TRACK ERASE (SE7) page to eliminate the program change.

## 12. Playback uses a different effect program.

CAUSE	POSSIBLE SOLUTION
The MIDI channel for a track containing a drum kit change or a program change is the same as the GLOBAL CHANNEL (M5) page's setting.	Change the GLOBAL CHANNEL setting to eliminate such conflicts.

## 13. The S3 cannot save data to a RAM card.

CAUSE	POSSIBLE SOLUTION
The card's write protect switch is in its ON position.	Set the switch to its OFF position. <i>Note: To avoid damaging the card data, never insert or withdraw the card with this switch in its OFF position.</i>
The card has not been initialized for use with the S3.	Initialize the card with the CARD (S12) page's FORMAT command.
There are no banks on the card.	Create a bank with the CARD (S12) page's BANK CREATE command.

## 14. The S3 does not receive MIDI NOTE messages properly.

CAUSE	POSSIBLE SOLUTION
The MIDI send and receive channels do not agree.	Change the TRACK STATUS (SP4) page's and TRACK MONITOR (PP2) page's channel settings.
The note ranges do not agree.	Use the NOTE ASSIGN (K5) page to change the note ranges for the tone colors.
The RECEIVE FILTER (M3) page's function is operative.	Turn off the filters for the types of MIDI messages to be recorded.

## 15. The S3 does not receive MIDI EXCLUSIVE messages properly.

CAUSE	POSSIBLE SOLUTION
The MIDI send and receive channels do not agree.	Change the GLOBAL channel settings (M5).
The S3 is not in the communications mode.	Activate the SYSTEM EXCLUSIVE (S9) page's COMMUNICATIONS mode.

# Appendix C: RAM Cards

## RAM Card Components

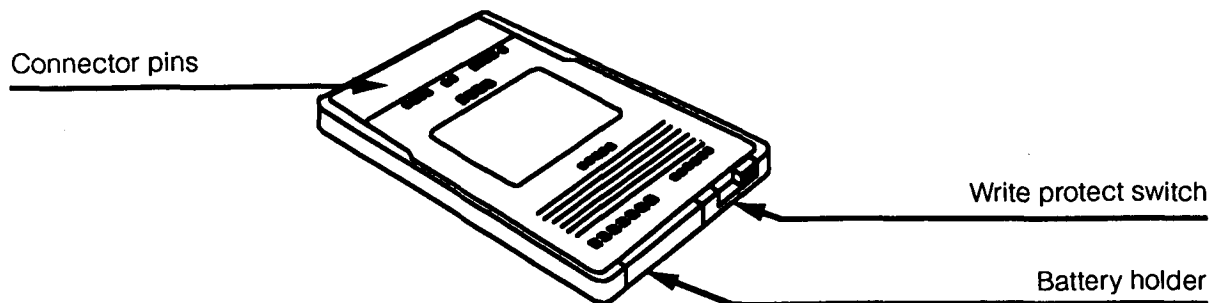

## C.1 Inserting a Battery

The RAM card uses a lithium battery (Model No. CR2016) to keep the data inside from fading away.

### Inserting the Battery

Procedure:

1. Turn the card over so that the connector pins face downward.
2. Grasp the battery holder by the slot provided and pull it out of the card.
3. Place the battery in the holder with the large plus sign facing upwards.
4. Slide the holder back into the card until it clicks into place.

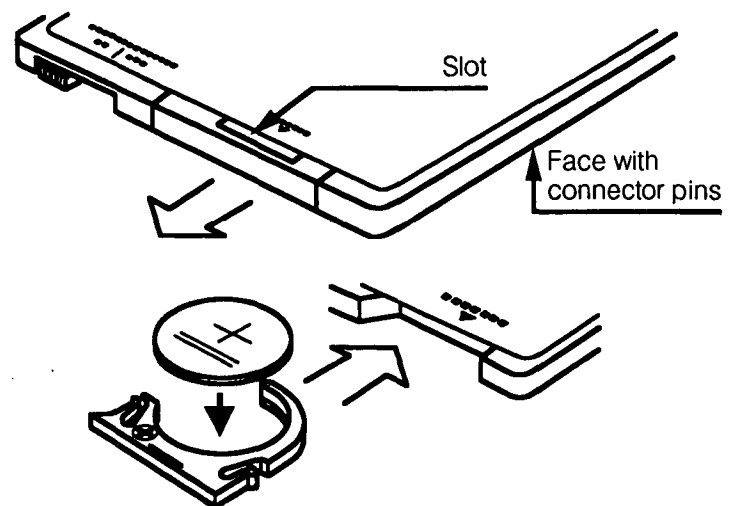

## C.2 Write Protect Switch

The write protect switch is a safety device that protects the data on a card from accidental erasure and other types of damage. We recommend that you leave it in the ON position except when you specifically wish to write data to the card. (The switch has no effect on reading data from the card.) In particular, never insert or withdraw the card with this switch in its OFF position.

## C.3 Changing a Battery

Under normal use, the lithium battery maintains the data inside the card for one year. To avoid data loss due to battery failure, promptly change the battery when one year has passed.

### Changing the Battery

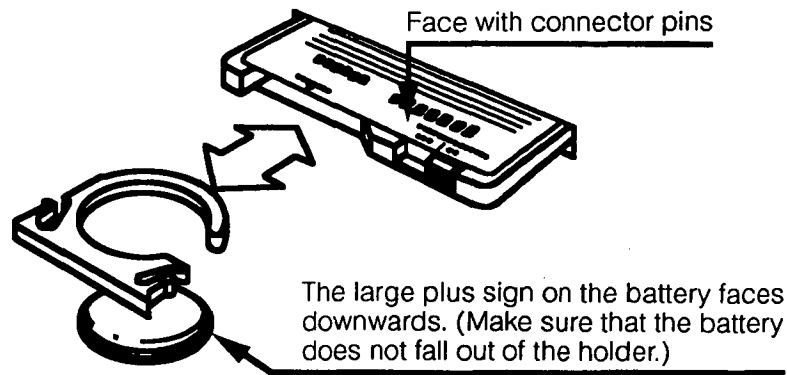

*Note 1: Storage at temperatures in excess of 40°C (104°F) shortens battery life.*

*Note 2: Always use the specified type of battery (Model No. CR2016).*

*Note 3: Always change the battery with the card inserted in the S3 with the power on. Otherwise, the data will dissipate the instant that you extract the battery holder.*

### Procedure:

The procedure for changing a battery is essentially the same as that for inserting a battery into a new card (see C.1 Inserting a Battery).

Keep in mind that Notes 1 and 2 above do not only pertain to changing and/or inserting of the battery, but also to battery care in general.



# Appendix D: MIDI Implementation

## 1. TRANSMITTED DATA

### 1 - 1 CHANNEL MESSAGES

STATUS	SECOND	THIRD	DESCRIPTION
1000 nnnn	0kkk kkkk	0100 0000	NOTE OFF
1001 nnnn	0kkk kkkk	0vvv vvvv	NOTE ON vvv vvvv = 2-126 (NOTE 1)
1010 nnnn	0kkk kkkk	0vvv vvvv	POLYPHONIC KEY PRESSURE (NOTE 2)
1011 nnnn	0ccc cccc	0vvv vvvv	CONTROL CHANGE (NOTE 2) ccc cccc = 0-120
1100 nnnn	000p pppp	-----	PROGRAM CHANGE (NOTE 3)
1101 nnnn	0vvv vvvv	-----	CHANNEL PRESSURE (NOTE 2)
1110 nnnn	0bbb bbbb	0bbb bbbb	PITCH BEND (NOTE 2)

- NOTES
- Velocity value will be recorded with 6bit resolution (0vvv vvv0) then transmitted.
  - Recorded data only.
  - Caused by KIT CHANGE Events programed in song.  
0~9 : Internal  
10~19 : Preset  
20~29 : Card
  - Recorded data (from external) will be transmitted.

### 1 - 2 SYSTEM MESSAGE

STATUS	SECOND	THIRD	DESCRIPTION
1111 0001	0nnn dddd	-----	MIDI TIME CODE QUARTER FRAME (NOTE 1)
1111 0010	0ggg gggg	0hhh hhhh	SONG POSITION POINTER (NOTE 2)
1111 0011	00ss ssss	-----	SONG SELECT (NOTE 3) ss ssss = 0-59
1111 1000	-----	-----	TIMING CLOCK (NOTE 2)
1111 1010	-----	-----	START (NOTE 2)
1111 1011	-----	-----	CONTINUE (NOTE 2)
1111 1100	-----	-----	STOP (NOTE 2)

- NOTES
- Transmitted when CLOCK = MTC.  
nnn : Message Type (Frame = 24, 25, 30d, 30)  
dddd : Value
  - Transmitted when CLOCK = On.
  - Transmitted when selected song was existing.  
0-29 : Internal  
30-59 : Card

### 1 - 3 UNIVERSAL SYSTEM EXCLUSIVE MESSAGE (DEVICE INQUIRY)

BYTE	DESCRIPTION
1111 0000	EXCLUSIVE STATUS
0111 1110	NON REAL-TIME MESSAGE
0000 nnnn	MIDI GROBAL CHANNEL
0000 0110	INQUIRY MESSAGE
0000 0010	IDENTITY REPLY
0100 0010	KORG ID (MANUFACTURES ID)
0010 1001	SB ID (FAMILY CODE LSB)
0000 0000	(FAMILY CODE MSB)
0000 0000	(MEMBER CODE LSB)
0000 0000	(MEMBER CODE MSB)
0nnn nnnn	ROM NUMBER (MINER VERSION LSB)
0000 0000	(MINER VERSION MSB)
0vvv vvvv	SOFT VERSION (MAJOR VERSION LSB)
0000 0000	(MAJOR VERSION MSB)
1111 0111	END OF EXCLUSIVE

- NOTES Transmit in COMMUNICATION MODE only.

## 2. RECOGNIZED RECEIVE DATA

### 2 - 1 CHANNEL MESSAGE

STATUS	SECOND	THIRD	DESCRIPTOIN
1000 nnnn	0kkk kkkk	0xxx xxxx	NOTE OFF (NOTE 1)
1001 nnnn	0kkk kkkk	0vvv vvvv	NOTE ON (NOTE 2) vvv vvvv = 1-127 vvv vvvv = 0: NOTE OFF
1010 nnnn	0kkk kkkk	0vvv vvvv	POLYPHONIC KEY PRESSURE (NOTE 3)
1011 nnnn	0ccc cccc	0vvv vvvv	CONTROL CHANGE (NOTE 4) ccc cccc = 0-120
1100 nnnn	0ppp pppp	-----	PROGRAM CHANGE (NOTE 5)
1101 nnnn	0vvv vvvv	-----	CHANNEL PRESSURE
1110 nnnn	0xxx xxxx	0bbb bbbb	PITCH BEND (NOTE 6)

- NOTES
- Velocity value will be ignored.
  - Velocity value will be recognized with 7-bit resolution but will be recorded with 6bit resolution (0vvv vvv0).
  - Not recognized, but recorded.
  - Modulation Wheel (ccc cccc = 1) message will be recognized. Other messages will not be recognized, but they will be recorded.
  - This will be used to change Kit.  
0~9 : Internal  
10~19 : Preset  
20~29 : Card  
When nnnn = Global channel, Effect program will also be changed.  
0~15 : 00-15  
Surplus of 30 (or 16) will be used to change Kit (or Effect program), when program number outside this range was sent. Program number will be recorded with its own number, above 30 (or 16).
  - LSB will be ignored, but will be recorded.

### 2 - 2 SYSTEM MESSAGE

STATUS	SECOND	THIRD	DESCRIPTION
1111 0010	0ggg gggg	0hhh hhhh	SONG POSITION POINTER (NOTE 1)
1111 0011	0sss ssss	-----	SONG SELECT (NOTE 2) 0sss ssss = 0-29
1111 1000	-----	-----	TIMING CLOCK (NOTE 3)
1111 1010	-----	-----	START (NOTE 1)
1111 1011	-----	-----	CONTINUE (NOTE 1)
1111 1100	-----	-----	STOP (NOTE 1)

- NOTES
- Recognized when CONTROL = On.
  - Recognized in selected song is existing and when sequencer is stopped.  
0-29 : Internal  
30-59 : Card  
Surplus of 60 will be used to select Song, when song number outside this range was sent.
  - Recognized when CLOCK Source = MIDI.

### 2 - 3 UNIVERSAL SYSTEM EXCLUSIVE MESSAGE (DEVICE INQUIRY)

BYTE	DESCRIPTION
1111 0000	EXCLUSIVE STATUS
0111 1110	NON REAL-TIME MESSAGE
0000 nnnn	MIDI GROBAL CHANNEL
0000 0110	INQUIRY MESSAGE
0000 0001	INQUIRY REQUEST
1111 0111	END OF EXCLUSIVE

# MIDI Implementation

## 3.SYSTEM EXCLUSIVE MESSAGES

### S3 SYSTEM EXCLUSIVE

1st Byte = 1111 0000 (F0; Exclusive Status	Header
2nd Byte = 0100 0010 (42; KORG ID	
3rd Byte = 0011 nnnn (3n; Format ID n: Global channel	
4th Byte = 0010 1001 (29; S3 ID	
5th Byte = 0fff ffff (ff; Function Code	
6th Byte = 0ddd dddd (dd; Data	
: : :	
: : :	
: : :	
Last Byte = 1111 0111 (F7; End of Exclusive..... EOX	

### 3 - 1.TRANSMITTED SYSTEM EXCLUSIVE DATA Function Code List

Function (Hex)	Description
51	GLOBAL DATA DUMP *
44	KIT DATA DUMP
52	ALL KIT DATA DUMP *
40	TIMBRE DATA DUMP
4C	ALL TIMBRE DATA DUMP *
56	PATTERN DATA DUMP
58	SONG DATA DUMP
57	ALL SEQUENCE DATA DUMP *
45	WAVEFORM NAME DUMP
50	ALL DATA (GLOBAL, SEQ, KIT, TIMBRE) DUMP *
23	DATA RECEIVE COMPLETED
24	DATA RECEIVE ERROR

Transmits in COMMUNICATION MODE  
Those \* marked messages can be transmitted in dump menu.

### 3 - 2.RECOGNIZED RECEIVE SYSTEM EXCLUSIVE DATA Function Code List

Function (Hex)	Description
0E	GLOBAL DATA DUMP REQUEST
15	KIT DATA DUMP REQUEST
0D	ALL KIT DATA DUMP REQUEST
10	TIMBRE DATA DUMP REQUEST
1C	ALL TIMBRE DATA DUMP REQUEST
09	PATTERN DATA DUMP REQUEST
0A	SONG DATA DUMP REQUEST
0B	ALL SEQUENCE DATA DUMP REQUEST
16	ALL WAVEFORM NAME DUMP REQUEST
0F	ALL DATA (GLOBAL,SEQ,KIT,TIMBRE) DUMP REQUEST
50	ALL DATA (GLOBAL,SEQ,KIT,TIMBRE) DUMP
51	GLOBAL DATA DUMP
44	KIT DATA DUMP
52	ALL KIT DATA DUMP
40	TIMBRE DATA DUMP
4C	ALL TIMBRE DATA DUMP
56	PATTERN DATA DUMP
58	SONG DATA DUMP
57	ALL SEQUENCE DATA DUMP
45	WAVEFORM NAME DUMP
41	PARAMETER CHANGE

Recognizes in COMMUNICATION MODE

### 3 - 3.MIDI EXCLUSIVE FORMAT

#### (1). ALL DATA (GLOBAL, KIT, TIMBRE, SEQUENCE DATA) DUMP REQUEST

Byte	Description	Recognize
F0,42,3n,29	EXCLUSIVE HEADER	
0000 1111	ALL DATA DUMP REQUEST	0Fh
1111 0111	EOX	

Receives this message, and transmits Func=50h message.

#### (2). GLOBAL DATA DUMP REQUEST

Byte	Description	Recognize
F0,42,3n,29	EXCLUSIVE HEADER	
0000 1110	GLOBAL DATA DUMP REQUEST	0Eh
1111 0111	EOX	

Receives this message, and transmits Func=51h message.

#### (3). KIT DATA DUMP REQUEST

Byte	Description	Recognize
F0,42,3n,29	EXCLUSIVE HEADER	
0001 0101	KIT DATA DUMP REQUEST	15h
0000 kkkk	KIT # (see NOTE # 1)	
1111 0111	EOX	

Receives this message, and transmits Func=44h message.

#### (4). ALL KIT DATA DUMP REQUEST

Byte	Description	Recognize
F0,42,3n,29	EXCLUSIVE HEADER	
0000 1101	ALL KIT DATA DUMP REQUEST	0Dh
1111 0111	EOX	

Receives this message, and transmits Func=52h message.

#### (5). TIMBRE DATA DUMP REQUEST

Byte	Description	Recognize
F0,42,3n,29	EXCLUSIVE HEADER	
0001 0000	TIMBRE DATA DUMP REQUEST	10h
0ttt tttt	TIMBRE # (see NOTE # 2)	
1111 0111	EOX	

Receives this message, and transmits Func=40h message.

#### (6). ALL TIMBRE DATA DUMP REQUEST

Byte	Description	Recognize
F0,42,3n,29	EXCLUSIVE HEADER	
0001 1100	ALL TIMBRE DATA DUMP REQUEST	1Ch
1111 0111	EOX	

Receives this message, and transmits Func=4Ch message.

#### (7). PATTERN DATA DUMP REQUEST

Byte	Description	Recognize
F0,42,3n,29	EXCLUSIVE HEADER	
0000 1001	PATTERN DATA DUMP REQUEST	09h
0ppp pppp	Pattern # (see NOTE # 3)	
1111 0111	EOX	

Receives this message, and transmits Func=56h message.

# MIDI Implementation

## (8). SONG DATA DUMP REQUEST

Byte	Description	Recognize
F0,42,3n,29	EXCLUSIVE HEADER	
0000 1010	SONG DATA DUMP REQUEST	0Ah
000s ssss	Song # (see NOTE # 4)	
1111 0111	EOX	

Receives this message, and transmits Func=58h message.

## (9). ALL SEQUENCE DATA DUMP REQUEST

Byte	Description	Recognize
F0,42,3n,29	EXCLUSIVE HEADER	
0000 1011	ALL SEQUENCE DATA DUMP REQUEST	0Bh
1111 0111	EOX	

Receives this message, and transmits Func=57h message.

## (10). WAVEFORM NAME DUMP REQUEST

Byte	Description	Recognize
F0,42,3n,29	EXCLUSIVE HEADER	
0001 0110	ALL WAVEFORM NAME DATA DUMP REQUEST	16h
1111 0111	EOX	

Receives this message, and transmits Func=45h message.

## (11). ALL DATA (GLOBAL,KIT,TIMBRE,SEQUENCE DATA) DUMP

Byte	Description	Transmit Recognize
F0,42,3n,29	EXCLUSIVE HEADER	
0101 0000	ALL DATA DUMP	50h
0ddd dddd	Data (see ④ ALL DATA DUMP Format)	
:	:	
:	:	
1111 0111	EOX	

Receives this message, and transmits Func=23h message or Func=24h message.  
Receives Func=0Fh message, and transmits this message.

## (12). GLOBAL DATA DUMP

Byte	Description	Transmit Recognize
F0,42,3n,29	EXCLUSIVE HEADER	
0101 0001	GLOBAL DATA DUMP	51h
0ddd dddd	Data (see ① GLOBAL DATA DUMP Format)	
:	:	
:	:	
1111 0111	EOX	

Receives this message, and transmits Func=23h message or Func=24h message.  
Receives Func=0Eh message, and transmits this message.

## (13). KIT DATA DUMP

Byte	Description	Transmit Recognize
F0,42,3n,29	EXCLUSIVE HEADER	
0100 0100	KIT DATA DUMP	44h
0000 kkkk	KIT # (see NOTE # 1)	
0ddd dddd	Data (see ② KIT DATA DUMP Format)	
:	:	
:	:	
1111 0111	EOX	

Receives this message, and transmits Func=23h message or Func=24h message.  
Receives Func=15h message, and transmits this message.

## (14). ALL KIT DATA DUMP

Byte	Description	Transmit Recognize
F0,42,3n,29	EXCLUSIVE HEADER	
0101 0010	ALL KIT DATA DUMP	52h
0ddd dddd	Data (see ③ ALL KIT DATA DUMP Format)	
:	:	
:	:	
1111 0111	EOX	

Receives this message, and transmits Func=23h message or Func=24h message.  
Receives Func=0Dh message, and transmits this message.

## (15). TIMBRE DATA DUMP

Byte	Description	Transmit Recognize
F0,42,3n,29	EXCLUSIVE HEADER	
0100 0000	TIMBRE DATA DUMP	40h
0ttt tttt	TIMBRE # (see NOTE # 2)	
0ddd dddd	Data (see ④ TIMBRE DATA DUMP Format)	
:	:	
:	:	
1111 0111	EOX	

Receives this message, and transmits Func=23h message or Func=24h message.  
Receives Func=10h message, and transmits this message.

## (16). ALL TIMBRE DATA DUMP

Byte	Description	Transmit Recognize
F0,42,3n,29	EXCLUSIVE HEADER	
0100 1100	ALL TIMBRE DATA DUMP	4Ch
0ddd dddd	Data (see ④ ALL TIMBRE DATA DUMP Format)	
:	:	
:	:	
1111 0111	EOX	

Receives this message, and transmits Func=23h message or Func=24h message.  
Receives Func=1Ch message, and transmits this message.

## (17). PATTERN DATA DUMP

Byte	Description	Transmit Recognize
F0,42,3n,29	EXCLUSIVE HEADER	
0101 0110	PATTERN DATA DUMP	56h
0ddd dddd	Data (see ④ PATTERN DATA DUMP Format)	
:	:	
:	:	
1111 0111	EOX	

Receives this message, and transmits Func=23h message or Func=24h message.  
Receives Func=09h message, and transmits this message.

## (18). SONG DATA DUMP

Byte	Description	Transmit Recognize
F0,42,3n,29	EXCLUSIVE HEADER	
0101 1000	SONG DATA DUMP	58h
0ddd dddd	Data (see ⑦ Song DATA DUMP Format)	
:	:	
:	:	
1111 0111	EOX	

Receives this message, and transmits Func=23h message or Func=24h message.  
Receives Func=0Ah message, and transmits this message.

## (19). ALL SEQUENCE DATA DUMP

Byte	Description	Transmit Recognize
F0,42,3n,29	EXCLUSIVE HEADER	
0101 0111	ALL SONG DATA DUMP	57h
0ddd dddd	Data (see ⑥ ALL Song DATA DUMP Format)	
:	:	
:	:	
1111 0111	EOX	

Receives this message, and transmits Func=23h message or Func=24h message.  
Receives Func=08h message, and transmits this message.

## (20). ALL WAVEFORM NAME DUMP

Byte	Description	Transmit
F0,42,3n,29	EXCLUSIVE HEADER	
0100 0101	ALL WAVEFORM NAME DATA DUMP	45h
0ddd dddd	Data (see ④ ALL WAVEFORM NAME DUMP Format)	
:	:	
:	:	
1111 0111	EOX	

Receives Func=16h message, and transmits this message.

# MIDI Implementation

## (21). PARAMETER CHANGE

Byte	Description	Recognize
F0,42,3n,29	EXCLUSIVE HEADER	41h
0100 0001	PARAMETER CHANGE	
0000 cccc	TABLE TYPE (see NOTE # 5)	
0nnn nnnn	TABLE NUMBER (EFFECT #,KIT #,TIMBRE #)	
0aaa aaaa	TABLE OFFSET (BYTE POINTER) (LSB bit6-0)	
0aaa aaaa	TABLE OFFSET (BYTE POINTER) (MSB bit13-7)	
0ddd dddd	Value (LSB bit6-0) (see Value format)	
0ddd dddd	Value (MSB bit15-7) (see Value format)	
1111 0111	EOX	

Receives this message, and transmits Func=23h message or Func=24h message.  
TABLE NUMBER will be ignored when cccc = 0.

## (22). DATA LOAD COMPLETED

Byte	Description	Transmit
F0,42,3n,29	EXCLUSIVE HEADER	23h
0010 0011	DATA LOAD COMPLETED	
1111 0111	EOX	

Transmits this message when received data is loaded.

## (23). DATA LOAD ERROR

Byte	Description	Transmit
F0,42,3n,29	EXCLUSIVE HEADER	24h
0010 0100	DATA LOAD ERROR	
1111 0111	EOX	

Transmits this message when received data fails in loading.

## DUMP DATA Format

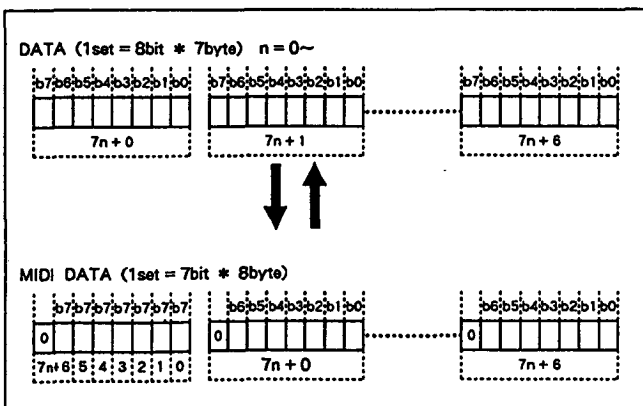

## VALUE DATA Format

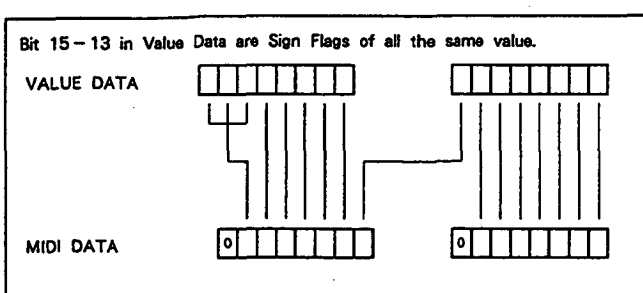

NOTE # 1 : kkkk = 0 ~ 9 ..... KIT # 0 ~ # 9  
NOTE # 2 : 0ttt 1ttt = 0 ~ 79 ..... TIMBRE # 0 ~ # 79  
NOTE # 3 : 0ppp pppp = 0 ~ 99 ..... PATTERN # 0 ~ # 99  
NOTE # 4 : 000s ssss = 0 ~ 29 ..... SONG # 0 ~ # 29  
NOTE # 5 : 0000 cccc = 0 ~ 06 ..... TABLE TYPE

0 .... System setting table (51byte) (SEE NOTE # 6)  
1 .... Effect parameter table (25 \* 16byte) (SEE NOTE # 7)  
2 .... Kit name table (8 \* 10byte) (SEE NOTE # 8)  
3 .... Pad Original note # table (16 \* 10byte) (SEE NOTE # 9)  
4 .... Pad Note # range table (32 \* 10byte) (SEE NOTE # 10)  
5 .... Pad data table (29 \* 16 \* 10byte) (SEE NOTE # 11)  
6 .... Timbre data table (67 \* 10byte) (SEE NOTE # 12)

## NOTE # 6 : SYSTEM SETTING TABLE (51 Byte)

	7	6	5	4	3	2	1	0	
0	CLOCK Source (1 : Internal 2 : MIDI 3 : SMPTE)								
1	Control On/Off (1 : Off 2 : On)								
2	SMPTE Frame Type								(Frame Type)
3	TUNE Transpose (-12 --- > 12)								1:24 4:29.97
4	Tune (-50 --- > 50)								2:25 6:30
5	METRONOME On/Off (1 : Off 2 : On 3 : Rec)								(Beat)
6	Beat (3-48)								48:1/2 8:1/8T
7	Output Assign (0-3,F0h)								24:1/4 6:1/16
8	Panpot (0-30)								16:1/4T 4:1/16T
9	Level (1-99)								12:1/8 3:1/32
10	ROLL Resolution (16-192)								(Output Assign)
11	FLAM Ratio (1-6)								F0h:Stereo
12	Time (1-10)								0:Multi 1
13	PAD Mode (1-4)								1:Multi 2
14	Start Note # (0-127)								2:Multi 3
15	User Scale Interval PAD2 (-24--> 24)								3:Multi 4
16	PAD3								(Panpot) Center=15
17	PAD4								(PAD Mode)
18	PAD5								1:Normal
19	PAD6								2:Major
20	PAD7								3:Chromatic
21	PAD8								4:User
22	PAD Sensitivity (1 : Vari 2 : Fix)								
23	Fix Level (2-126) even value only								
24	Velocity Curve (1-8)								
25	FOOT SW 1 Mode (1-20)								(Foot sw Mode)
26	2 Mode (1-20)								1:Off
27	Track Kit # - Track1/5 -								2:Start-R
28	- Track2/6 -								3:Start-C
29	- Track3/7 -								4:BankSw
30	- Track4/8 -								5-20:PAD1-16
31	Track MIDI Channel - Track1/5 -								
32	- Track2/6 -								
33	- Track3/7 -								
34	- Track4/8 -								
35	Record Channel Select (1-16,17)								
36	Record Filter - Control Change -								(Record Filter)
37	- Program Change -								1:Filter On
38	- Pitch Bend -								2:Filter Off
39	- Pressure -								
40	- Velocity -								
41	Receive Filter - Control Change -								(Receive Filter)
42	- Program Change -								1:Filter On
43	- Pitch Bend -								2:Filter Off
44	- Pressure -								
45	- Note Data -								
46	MIDI Clock Out Ach								(Clock Out)
47	MIDI Clock Out Bch								1:Off
48	MIDI Thru Ach (1 : Off 2 : On)								2:On
49	MIDI Thru Bch (1 : Off 2 : On)								3:MTC
50	Global MIDI Channel (0-15)								

# MIDI Implementation

NOTE # 7 : EFFECT PARAMETER TABLE (25\*16=400 Byte)

	7	6	5	4	3	2	1	0	
0	Effect1 Pattern No.(1-29)								(Pattern No.) 1-28: Effect No. 29: Off
1	Effect2 Pattern No.(1-29)								
2	Effect1 Ch-L Effect Balance (0-100)								
3	Effect1 Ch-R Effect Balance (0-100)								
4	Effect2 Ch-L Effect Balance (0-100)								
5	Effect2 Ch-R Effect Balance (0-100)								
6	Output3 (Send1) Pan (1-101)								
7	Output4 (Send2) Pan (1-101)								
8		Place	E2-R	E2-L	E1-R	E1-L			(Place) 0: P2 1: P1
9	Effect1 Setting Data 1								(Effect On/Off) 0: Off 1: On
10	2								
11	3								
12	4								
13	5								
14	6								
15	7								
16	8								
17	Effect2 Setting Data 1								E1 Effect Parameter
18	2								
19	3								
20	4								
21	5								
22	6								
23	7								
24	8								
									E2 Effect Parameter

## EFFECT SETTING DATA

01 : HALL REVERB 1									
	7	6	5	4	3	2	1	0	
0	Reverb Time (0-97)								
1	(NU)								
2	High Damp (0-99)								
3	Pre Delay (0-150)								
4	E/R Level (0-99)								
5	(NU)								
6	EQ High (-12-->12)								
7	EQ Low (-12-->12)								

02 : HALL REVERB 2									
	7	6	5	4	3	2	1	0	
0	Reverb Time (0-97)								
1	(NU)								
2	High Damp (0-99)								
3	Pre Delay (0-150)								
4	E/R Level (0-99)								
5	(NU)								
6	EQ High (-12-->12)								
7	EQ Low (-12-->12)								

03 : HALL REVERB 3									
	7	6	5	4	3	2	1	0	
0	Reverb Time (0-97)								
1	(NU)								
2	High Damp (0-99)								
3	Pre Delay (0-150)								
4	E/R Level (0-99)								
5	(NU)								
6	EQ High (-12-->12)								
7	EQ Low (-12-->12)								

04 : ROOM REVERB 1									
	7	6	5	4	3	2	1	0	
0	Reverb Time (0-48)								
1	(NU)								
2	High Damp (0-99)								
3	Pre Delay (0-150)								
4	E/R Level (0-99)								
5	(NU)								
6	EQ High (-12-->12)								
7	EQ Low (-12-->12)								

05 : ROOM REVERB 2									
	7	6	5	4	3	2	1	0	
0	Reverb Time (0-48)								
1	(NU)								
2	High Damp (0-99)								
3	Pre Delay (0-150)								
4	E/R Level (0-99)								
5	(NU)								
6	EQ High (-12-->12)								
7	EQ Low (-12-->12)								

06 : ROOM REVERB 3									
	7	6	5	4	3	2	1	0	
0	Reverb Time (0-48)								
1	(NU)								
2	High Damp (0-99)								
3	Pre Delay (0-150)								
4	E/R Level (0-99)								
5	(NU)								
6	EQ High (-12-->12)								
7	EQ Low (-12-->12)								

07 : EARLY REFLECTION 1									
	7	6	5	4	3	2	1	0	
0	E/R Time (0-59)								
1	Pre Delay (0-150)								
2	(NU)								
3	(NU)								
4	(NU)								
5	(NU)								
6	EQ High (-12-->12)								
7	EQ Low (-12-->12)								

08 : EARLY REFLECTION 2									
	7	6	5	4	3	2	1	0	
0	E/R Time (0-59)								
1	Pre Delay (0-150)								
2	(NU)								
3	(NU)								
4	(NU)								
5	(NU)								
6	EQ High (-12-->12)								
7	EQ Low (-12-->12)								

# MIDI Implementation

09 : EARLY REFLECTION 3									
	7	6	5	4	3	2	1	0	
0	E/R Time (0-59)								
1	Pre Delay (0-150)								
2	(NU)								
3	(NU)								
4	(NU)								
5	(NU)								
6	EQ High (-12-->12)								
7	EQ Low (-12-->12)								

14 : STEREO TREMOLO									
	7	6	5	4	3	2	1	0	
0	Depth (0-99)								
1	Speed (1-216)								
2							0	0	Wv
3	Shape (-99-->99)								
4	(NU)								
5	(NU)								
6	EQ High (-12-->12)								
7	EQ Low (-12-->12)								

(Wv) 0 : Sin  
1 : Tri

10 : STEREO DELAY									
	7	6	5	4	3	2	1	0	
0	Delay Time L (0-430)								L
1									H
2	Feedback (-99-->99)								
3	High Damp (0-99)								
4	Delay Time R (0-430)								L
5									H
6	EQ High (-12-->12)								
7	EQ Low (-12-->12)								

15 : DUAL EQUALIZER									
	7	6	5	4	3	2	1	0	
0	High Fc (1-3)								
1	Low Fc (1-3)								
2	High Gain (-12-->12)								
3	Low Gain (-12-->12)								
4	High Fc (1-3)								
5	Low Fc (1-3)								
6	High Gain (-12-->12)								
7	Low Gain (-12-->12)								

L  
R

11 : STEREO CHORUS									
	7	6	5	4	3	2	1	0	
0	Depth (0-99)								
1	Speed (1-216)								
2							0	1	Wv
3	(NU)								
4	Delay Time (0-200)								
5	(NU)								
6	EQ High (-12-->12)								
7	EQ Low (-12-->12)								

(Wv) 0 : Sin  
1 : Tri

16 : DUAL EXCITER									
	7	6	5	4	3	2	1	0	
0	Blend (-99-->99)								
1	Emphatic Point (0-9)								
2	EQ High (-12-->12)								
3	EQ Low (-12-->12)								
4	Blend (-99-->99)								
5	Emphatic Point (0-9)								
6	EQ High (-12-->12)								
7	EQ Low (-12-->12)								

L  
R

12 : STEREO FLANGER									
	7	6	5	4	3	2	1	0	
0	Depth (0-99)								
1	Speed (1-216)								
2							1	1	Wv
3	Feedback (-99-->99)								
4	Delay Time (0-50)								
5	(NU)								
6	EQ High (-12-->12)								
7	EQ Low (-12-->12)								

(Wv) 0 : Sin  
1 : Tri

17 : DELAY/HALL REVERB									
	7	6	5	4	3	2	1	0	
0	Delay Time (0-430)								L
1									H
2	Feedback (-99-->99)								
3	High Damp (0-99)								
4	Reverb Time (0-97)								
5	(NU)								
6	High Damp (0-99)								
7	Pre Delay (0-125)								

13 : STEREO PHASER									
	7	6	5	4	3	2	1	0	
0	Depth (0-99)								
1	Speed (1-216)								
2							0	0	Wv
3	Feedback (-99-->99)								
4	Manual (0-99)								
5	(NU)								
6	(NU)								
7	(NU)								

(Wv) 0 : Sin  
1 : Tri

18 : DELAY/ROOM REVERB									
	7	6	5	4	3	2	1	0	
0	Delay Time (0-430)								L
1									H
2	Feedback (-99-->99)								
3	High Damp (0-99)								
4	Reverb Time (0-48)								
5	(NU)								
6	High Damp (0-99)								
7	Pre Delay (0-125)								

# MIDI Implementation

19 : DELAY/EARLY REFLECTION									
	7	6	5	4	3	2	1	0	
0	Delay Time (0 - 420)								L
1									H
2	Feedback (-99 --> 99)								
3	High Damp (0 - 99)								
4	E/R Time (0 - 24)								
5	Pre Delay (0 - 50)								
6	(NU)								
7	(NU)								

20 : DELAY/DELAY									
	7	6	5	4	3	2	1	0	
0	Delay Time L (0 - 430)								L
1									H
2	FeedbackL (-99 --> 99)								
3	High Damp L (0 - 99)								
4	Delay Time R (0 - 430)								L
5									H
6	Feedback R (-99 --> 99)								
7	High Damp R (0 - 99)								

21 : DELAY/CHORUS										
	7	6	5	4	3	2	1	0		
0	Delay Time (0 - 430)								L	
1									H	
2	Feedback (-99 --> 99)									
3	High Damp (0 - 99)									
4	Depth (0 - 99)									
5	Speed (1 - 216)									
6				0	0	Wv	(Wv) 0 : Sin 1 : Tri			
7	(NU)									

22 : DELAY/FLANGER										
	7	6	5	4	3	2	1	0		
0	Delay Time (0 - 430)								L	
1									H	
2	Feedback (-99 --> 99)									
3	High Damp (0 - 99)									
4	Depth (0 - 99)									
5	Speed (1 - 216)									
6				1	0	0				
7	Feedback (-99 --> 99)									

23 : DELAY/PHASER									
	7	6	5	4	3	2	1	0	
0	Delay Time (0 - 430)								L
1									H
2	Feedback (-99 --> 99)								
3	High Damp (0 - 99)								
4	Depth (0 - 99)								
5	Speed (1 - 216)								
6	Feedback (-99 --> 99)								
7	(NU)								

24 : DELAY/TREMOLO									
	7	6	5	4	3	2	1	0	
0	Delay Time (0 - 430)								L
1									H
2	Feedback (-99 --> 99)								
3	High Damp (0 - 99)								
4	Depth (0 - 99)								
5	Speed (1 - 216)								
6	(NU)								
7	Shape (-99 --> 99)								

25 : EQUALIZER/DELAY									
	7	6	5	4	3	2	1	0	
0	High Fc (1 - 3)								
1	Low Fc (2 - 3)								
2	High Gain (-12 --> 12)								
3	Low Gain (-6 --> 6)								
4	Delay Time (0 - 430)								L
5									H
6	Feedback (-99 --> 99)								
7	High Damp (0 - 99)								

26 : EQUALIZER/CHORUS										
	7	6	5	4	3	2	1	0		
0	High Fc (1 - 3)									
1	Low Fc (2 - 3)									
2	High Gain (-12 --> 12)									
3	Low Gain (-6 --> 6)									
4	Depth (0 - 99)									
5	Speed (1 - 216)									
6	1				0	0	Wv	(Wv) 0 : Sin 1 : Tri		
7	(NU)									

27 : EQUALIZER/FLANGER										
	7	6	5	4	3	2	1	0		
0	High Fc (1 - 3)									
1	Low Fc (2 - 3)									
2	High Gain (-12 --> 12)									
3	Low Gain (-6 --> 6)									
4	Depth (0 - 99)									
5	Speed (1 - 216)									
6				1	0	0				
7	Feedback (-99 --> 99)									

28 : EQUALIZER/TREMOLO									
	7	6	5	4	3	2	1	0	
0	High Fc (1 - 3)								
1	Low Fc (2 - 3)								
2	High Gain (-12 --> 12)								
3	Low Gain (-6 --> 6)								
4	Depth (0 - 99)								
5	Speed (1 - 216)								
6	(NU)								
7	Shape (-99 --> 99)								

# MIDI Implementation

NOTE # 8 : KIT NAME TABLE (8 \* 10 = 80 Byte)

	7	6	5	4	3	2	1	0													
0																					
1																					
2																					
3																					
4																					
5																					
6																					
7																					

in ASCII code.      KIT 0 name      KIT 9 name

NOTE # 9 : PAD ORIGINAL NOTE # TABLE (16 \* 10 = 160 Byte)

	7	6	5	4	3	2	1	0												
0	PAD # 1 original note #																			
1	PAD # 2 original note #																			
2	PAD # 3 original note #																			
3	PAD # 4 original note #																			
4	PAD # 5 original note #																			
5	PAD # 6 original note #																			
6	PAD # 7 original note #																			
7	PAD # 8 original note #																			
8	PAD # 9 original note #																			
9	PAD # 10 original note #																			
10	PAD # 11 original note #																			
11	PAD # 12 original note #																			
12	PAD # 13 original note #																			
13	PAD # 14 original note #																			
14	PAD # 15 original note #																			
15	PAD # 16 original note #																			

KIT 9 PAD Original Note # table      KIT 0 PAD Original Note # table

original note # : 00h ~ 7Fh

@."Original note #" for each Pad has to be set within the limits of "note # range".  
 @.MIDI FILTER refers to this table to send note # when PAD is hit.

NOTE # 10 : PAD NOTE # RANGE TABLE (32 \* 10 = 320 Byte)

	7	6	5	4	3	2	1	0												
0	bottom note # / pad # 1																			
1	top note # / pad # 1																			
2																				
3																				
4																				
5																				
6																				
7																				
8																				
9																				
10																				
11																				
12																				
13																				
14																				
15																				
16																				
17																				
18																				
19																				
20																				
21																				
22																				
23																				
24																				
25																				
26																				
27																				
28																				
29																				
30	bottom note # / pad # 16																			
31	top note # / pad # 16																			

KIT 0 PAD Note # Range table      KIT 9 PAD Note # Range table

bottom,top note # : 00h~7Fh  
 (bottom note # <= original note # <= top note #)

@."Original note #" for each Pad has to be set within the limits of "note # range".



# MIDI Implementation

NOTE # 11 : PAD DATA TABLE  
(29 \* 16 \* 10 = 4640 Byte)

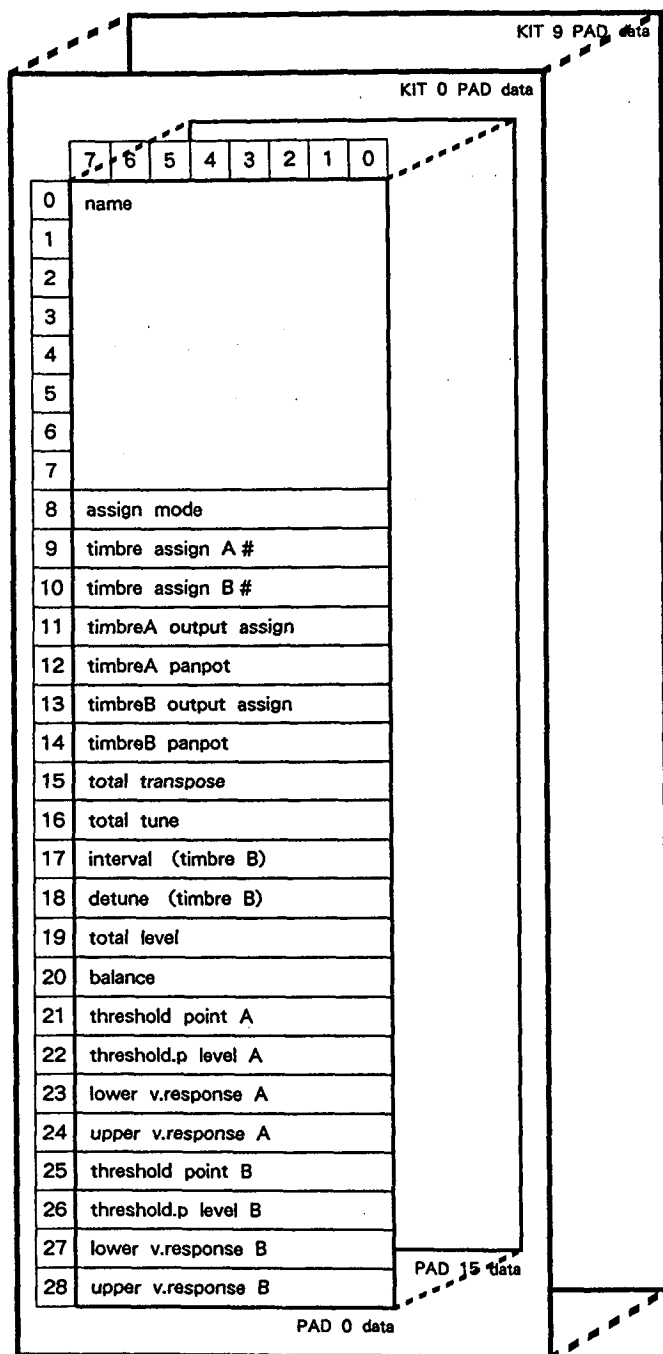

## c). timbre assign A #, B #

00h ~ 4Fh : RAM TIMBRE 0 ~ RAM TIMBRE 79  
50h ~ 9Fh : CARD TIMBRE 0 ~ CARD TIMBRE 79  
A0h ~ EFh : ROM TIMBRE 0 ~ ROM TIMBRE 79  
F0h ~ F3h : internal TIMBRE 0 ~ internal TIMBRE 3  
FEh : not assigned TIMBRE #

In case of CARD TIMBRE, "System data" shows which is used Card Bank # 1 or # 2 in use. Timbre A # cannot take FEh.

## d). timbre A, B output assign

00h : multiout 1  
01h : multiout 2  
02h : multiout 3  
03h : multiout 4  
04h : effect send 1  
05h : effect send 2  
08h : multiout 1 and stereo out  
09h : multiout 2 and stereo out  
0Ah : multiout 3 and stereo out  
0Bh : multiout 4 and stereo out  
0Ch : effect send 1 and stereo out  
0Dh : effect send 2 and stereo out  
F0h : off and stereo out

## e). timbre A, B panpot

00h : L 15	0Fh : center	10h : R 1	F0h : off
01h : L 14		11h : R 2	
02h : L 13		12h : R 3	
03h : L 12		13h : R 4	
04h : L 11		14h : R 5	
05h : L 10		15h : R 6	
06h : L 9		16h : R 7	
07h : L 8		17h : R 8	
08h : L 7		18h : R 9	
09h : L 6		19h : R 10	
0Ah : L 5		1Ah : R 11	
0Bh : L 4		1Bh : R 12	
0Ch : L 3		1Ch : R 13	
0Dh : L 2		1Dh : R 14	
0Eh : L 1		1Eh : R 15	

## f). total transpose

Transposition of TIMBRE A, B from original pitch.  
-24~-0~+24 [\*100cent] : by semitone, +- 2octave

## g). total tune

Fine pitch of TIMBRE A, B -99~-0~+99 [cent] :

## h). interval (timbre B)

Transposition of TIMBRE B from TIMBRE A  
-24~-0~+24 [\*100cent] : by semitone, +- 2octave

## i). detune (timbre B)

Fine pitch of TIMBRE B -50~-0~+50 [cent] :

## j). total level

Output level 0~99 :

## k). balance

Output balance of TIMBRE A/B -99~-0~+99 :

## l). timbre A, B threshold point

Velocity point that divides velocity response between upper and lower. 2~126, 126 == lower only, even value only.

## m). timbre A, B threshold point level

level of threshold point. 2~126, even value only.

## n). timbre A, B lower velocity response

Output response of velocity data up to "timbre A, B threshold point velocity" -50~-0~+50 :

## o). timbre A, B upper velocity response

Output response of velocity data over "timbre A, B threshold point velocity" -50~-0~+50 :

## a). name

PAD NAME ( 8characters in ASCII )

## b). assign mode

00h : mono  
01h : poly  
02h : exclusive group A mono  
03h : exclusive group A poly  
04h : exclusive group B mono  
05h : exclusive group B poly  
06h : reserved mono  
07h : reserved poly  
08h : reserved exclusive group A mono  
09h : reserved exclusive group A poly  
0Ah : reserved exclusive group B mono  
0Bh : reserved exclusive group B poly

# MIDI Implementation

NOTE # 12 : TIMBRE DATA TABLE  
(47 \* 80 = 3760 Byte)

	7	6	5	4	3	2	1	0
0	name							
1								
2								
3								
4								
5								
6								
7								
8	waveform assign #							
9	flag (hold, etc.)							
10	end point							
11	sustain point							
12	rate (point 1)							
13	level							
14	rate (point 2)							
15	level							
16	rate (point 3)							
17	level							
18	rate (point 4)							
19	level							
20	rate (point 5)							
21	level							
22	rate (point 6)							
23	level							
24	rate (point 7)							
25	level							
26	rate (point 8)							
27	level							
28	end pitch							
29	rate							
30								
31								
32								
33	intensity # 0							
34	intensity # 1							
35	intensity # 2							
36	intensity # 3							
37	intensity # 4							
38	intensity # 5							
39	intensity # 6							
40	intensity # 7							
41	intensity # 8							
42	intensity # 9							
43	intensity # 10							
44	intensity # 11							
45	intensity # 12							
46	intensity # 13							

level envelope

auto pitch bend

modulation flow control flags

TIMBRE #79 data

TIMBRE 0 data

a). name

TIMBRE name (8 characters in ASCII)

b). waveform assign #

Waveform # for assign to TIMBRE  
00h~4Ah : INTERNAL WAVEFORM 0~74  
50h~77h : PCM CARD 1 WAVEFORM 0~39  
78h~9Fh : PCM CARD 2 WAVEFORM 0~39  
F0h : not assigned WAVEFORM #

c). flag (damp,etc.)

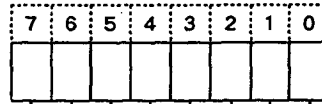

- 1 : level envelope hold on
- 1 : play mode "reverse" on
- 0 : undefined
- 0 : undefined
- 0 : undefined
- 0 : undefined
- 0 : undefined
- 0 : undefined

level envelope hold  
Omits Note off

play mode "reverse"  
Off... oneshot play or loop play (depend on loop mode)  
On ... reverse play

d). level envelope

- d-1). end point  
0~7 :  
@.sustain point <= end point
- d-2). sustain point  
0~7 :  
@.sustain point <= end point
- d-3). rate / point 0~point 7  
0~99 :
- d-4). level / point 0~point 7  
0~99 :

e). auto pitch bend

- e-1). end pitch  
-36~+36 : by semitone, + -3 octaves
- e-2). rate  
rate to end pitch  
0~99 :

f). modulation (# 1)

f-1). flow control flags

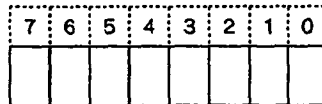

- level envelope
- auto bend
- note #-) pitch 0: active
- note #-) pitch 0: normal/1: reverse
- undefined
- undefined
- undefined
- undefined

# MIDI Implementation

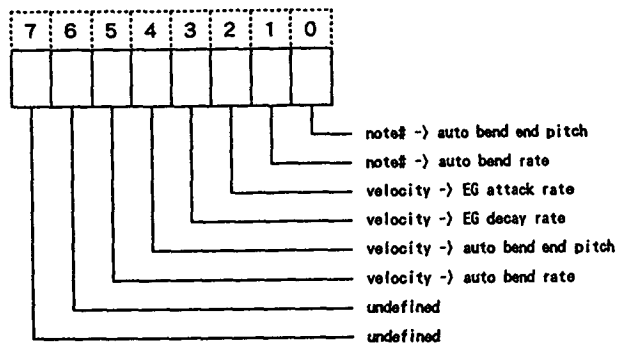
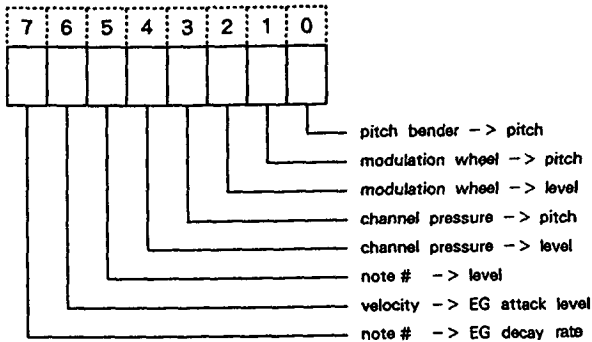

⊙. 1 = active

g - 2). intensity # 0	pitch bender -> pitch	- 120~0~+ 120 :
g - 3). intensity # 1	modulation wheel -> pitch	- 120~0~+ 120 :
g - 4). intensity # 2	modulation wheel -> level	- 50~0~+ 50 :
g - 5). intensity # 3	channel pressure -> pitch	- 120~0~+ 120 :
g - 6). intensity # 4	channel pressure -> level	- 50~0~+ 50 :
g - 7). intensity # 5	note # -> level	- 50~0~+ 50 :
g - 8). intensity # 6	velocity -> EG attack level	- 50~0~+ 50 :
g - 9). intensity # 7	note # -> EG decay rate	- 50~0~+ 50 :
g - 10). intensity # 8	note # -> auto bend end pitch	- 50~0~+ 50 :
g - 11). intensity # 9	note # -> auto bend rate	- 50~0~+ 50 :
g - 12). intensity # 10	velocity -> EG attack rate	- 50~0~+ 50 :
g - 13). intensity # 11	velocity -> EG decay rate	- 50~0~+ 50 :
g - 14). intensity # 12	velocity -> auto bend end pitch	- 50~0~+ 50 :
g - 15). intensity # 13	velocity -> auto bend rate	- 50~0~+ 50 :

## ① GLOBAL DATA DUMP FORMAT

[SYSTEM DATA (51 byte)] (SEE NOTE # 6)  
[EFFECT DATA (25 byte \* 16)] (SEE NOTE # 7)

51byte = 7 \* 7 + 2 -> 8 \* 7 + (2 + 1) = 59byte  
400byte = 7 \* 57 + 1 -> 8 \* 57 + (1 + 1) = 458byte  
59 + 458 = 517byte

## ② KIT DATA DUMP FORMAT

[KIT NAME (8 byte)] (SEE NOTE # 8)  
[PAD ORIGINAL NOTE # (16 byte)] (SEE NOTE # 9)  
[PAD NOTE # RANGE (32 byte)] (SEE NOTE # 10)  
[PAD DATA (29 byte \* 16)] (SEE NOTE # 11)

8byte = 8byte  
16byte = 7 \* 2 + 2 -> 8 \* 2 + (2 + 1) = 19byte  
32byte = 7 \* 4 + 4 -> 8 \* 4 + (4 + 1) = 37byte  
464byte = 7 \* 66 + 2 -> 8 \* 66 + (2 + 1) = 531byte

8 + 19 + 37 + 531 = 595byte

## ③ ALL KIT DATA DUMP FORMAT

[KIT DATA 0] (SEE ②KIT DATA DUMP FORMAT)  
:  
:  
[KIT DATA 9]  
595byte \* 10 = 5950byte

## ④ TIMBRE DATA DUMP FORMAT

[TIMBRE DATA (47 byte)] (SEE NOTE # 12)  
47byte = 7 \* 6 + 5 -> 8 \* 6 + (5 + 1) = 54byte

## ⑤ ALL TIMBRE DATA DUMP FORMAT

[TIMBRE DATA 0] (SEE ④TIMBRE DATA DUMP FORMAT)  
:  
:  
[TIMBRE DATA 79]  
54byte \* 80 = 4320byte

## ⑥ PATTERN DATA DUMP FORMAT

[PATTERN # (1 byte)]  
[TRACK1 SIZE (2 byte)]  
[TRACK2 SIZE (2 byte)]  
[TRACK3 SIZE (2 byte)]  
[TRACK4 SIZE (2 byte)]  
[PATTERN STATUS DATA (10 byte)]  
[1,2,3,4 TRACK DATA]

1byte = 1byte  
2byte = 2 -> 3 = 3byte  
2byte = 2 -> 3 = 3byte  
2byte = 2 -> 3 = 3byte  
2byte = 2 -> 3 = 3byte  
10byte = 7 \* 1 + 3 -> 8 \* 1 + (3 + 1) = 12byte  
Tr\_data = 7 \* a + b -> 8 \* a + (b + 1) = (8 \* a + b + 1) byte

1 + 3 + 3 + 3 + 3 + 12 + (8 \* a + b + 1) = 8 \* a + b + 26 byte

If designated PATTERN does not exist  
[PATTERN # (1 byte)]  
[zero (3 byte)]

4 byte

# MIDI Implementation

## ⑦ SONG DATA DUMP FORMAT

[SONG NUMBER (1 byte)]  
[SEQUENCE TRACK SIZE (2 byte)]  
[TRACK 5 SIZE (2 byte)]  
[TRACK 6 SIZE (2 byte)]  
[TRACK 7 SIZE (2 byte)]  
[TRACK 8 SIZE (2 byte)]  
[TEMPO TRACK SIZE (2 byte)]  
[FIXED VALUE "4" (2 byte (1 word))]  
[SONG STATUS DATA (89 byte)]  
[SEQUENCE,5,6,7,8,TEMPO,TRACK DATA+ 00 00 00 00 (? + 4byte)]

1byte = = 1byte  
2byte = 2→3 = 3byte  
2byte = 2→3 = 3byte  
2byte = 2→3 = 3byte  
2byte = 2→3 = 3byte  
2byte = 2→3 = 3byte  
2byte = 2→3 = 3byte  
2byte = 2→3 = 3byte  
2byte = 2→3 = 3byte  
89byte =  $7 * 12 + 5 \rightarrow 8 * 12 + (5 + 1) = 102$ byte  
Tr\_data =  $7 * c + d \rightarrow 8 * c + (d + 1) = (8 * c + d + 1)$  byte

$1 + 3 + 3 + 3 + 3 + 3 + 3 + 3 + 102 + (8 * c + d + 1) = 8 * c + d + 125$  byte

If designated SONG does not exist

[SONG # (1 byte)]  
[zero (3 byte)]

4 byte

## ⑧ ALL SEQUENCE DATA DUMP FORMAT

[SEQUENCE DATA SIZE (2 byte)]  
[SEQUENCE DATA START ADDRESS (2 byte)]  
[PATTERN DATA DIRECTORY (300 byte)]  
[SONG DATA DIRECTORY (90 byte)]  
[SEQUENCE DATA]

2byte = 2→3 = 3 byte  
2byte = 2→3 = 3 byte  
300byte =  $7 * 42 + 6 \rightarrow 8 * 42 + (6 + 1) = 343$  byte  
90byte =  $7 * 12 + 6 \rightarrow 8 * 12 + (6 + 1) = 103$  byte

SEQUENCE DATA =  $7 * e + f \rightarrow 8 * e + (f + 1) = (8 * e + f + 1)$  byte

$(8 * c + d + 118) * 30$  byte

$3 + 3 + 343 + 103 + (8 * e + f + 1) = 8 * e + f + 453$  byte

## ⑨ WAVEFORM NAME DUMP FORMAT

[WAVEFORM NAME 0 (8 byte)]  
[LOOP MODE 0 (1 byte)]  
:  
:  
[WAVEFORM NAME 154 (8byte)]  
[LOOP MODE 154 (1 byte)]

8byte = = 8byte  
1byte = = 1byte

8 + 1 = 9byte (1 waveform)

9 \* 155 = 1395byte

## ⑩ ALL DATA DUMP FORMAT

[GLOBAL DATA] (SEE ① GLOBAL DATA DUMP FORMAT)  
[ALL KIT DATA] (SEE ② ALL KIT DATA DUMP FORMAT)  
[ALL TIMBRE DATA] (SEE ⑤ ALL TIMBRE DATA DUMP FORMAT)  
[ALL SEQUENCE DATA] (SEE ⑧ ALL SEQUENCE DATA DUMP FORMAT)

# Specifications

## Specifications

<b>Voice generation</b>	Korg's Sonic Integrity (SI) system (100% digital processing)
<b>Number of voices</b>	12
<b>Number of touchpads</b>	8 (complete with touch sensors)
<b>Signal processor</b>	16-bit processor
<b>Effects</b>	2 independent digital stereo multieffectors
<b>Built-in waveforms</b>	75
<b>Timbres</b>	160 (80 preset + 80 user-programmable)
<b>Drum kits</b>	20 (10 preset + 10 user-programmable)
<b>Sequencer capacity</b>	30 songs, 100 patterns
<b>Sequencer tracks</b>	8 (4 pattern tracks + 4 song tracks)
<b>Resolution</b>	1/192
<b>Tempo</b>	40 ~ 250
<b>External synchronization</b>	MIDI, SMPTE (30, 29.97, 25, 24 NDF)
<b>Output jacks</b>	R and L/MONO, 4 MULTI OUT, headphones
<b>Card slots</b>	2 ROM + 1 RAM
<b>MIDI jacks</b>	1 IN + 2 OUT/THRU (OUT/THRU under software control)
<b>Display</b>	Backlit LCD, 24 characters x 2 lines
<b>External dimensions</b>	13.7(W) x 13.3(D) x 2.2(H) inches
<b>Weight</b>	5.7 lbs
<b>Accessories</b>	AC adaptor (9 V DC)
<b>Optional Accessories</b>	PCM ROM cards, MCR-03 RAM cards, LB-60 multipurpose carrying case, S3 carrying case

Function		Transmitted	Recognized	Remarks
Basic Channel	Default	1 - 16	1 - 16	Memorized
	Changed	1 - 16	1 - 16	
Mode	Default	×	Mode 3	
	Messages	×	×	
	Altered	*****		
Note Number	: True Voice	0 - 127	0 - 127	
		0 - 127	0 - 127	
Velocity	Note ON	○ 9n v = 2 - 126	○ 9n v = 1 - 127	
	Note OFF	×	×	
After Touch	Key's	×	×	
	Channel's	×	○	
Pitch Bender		×	○	
Control Change	1	×	○	Modulation Wheel
	2 - 120	×	×	
Program Change	: True #	○ (0 - 29) * 2 *****	○ (0 - 127) 0 - 29	Kit Change & Effect Change
System Exclusive		○ * 3	○ * 3	
System Common	: Song Pos	○	○	
	: Song Sel	○	○	
	: Tune	×	×	
System Realtime	: Clock	○	○	
	: Command	○	○	
Aux Messages	: Local ON/OFF	×	×	* 4
	: All Notes OFF	×	○	
	: Active Sens	×	×	
	: Reset	×	×	

Notes \* 1 : transmit if SEQUENCER recorded data.  
 \* 2 : transmit all PROGRAM # if SEQUENCER recorded data.  
 \* 3 : transmit/receive if in Communication Mode.  
 \* 4 : can't record into SEQUENCER.

Mode 1 : OMNI ON, POLY  
 Mode 3 : OMNI OFF, POLY

Mode 2 : OMNI ON, MONO  
 Mode 4 : OMNI OFF, MONO

○ : Yes  
 × : No

# CANADA

---

THIS APPARATUS COMPLIES WITH THE "CLASS B" LIMITS FOR RADIO NOISE EMISSIONS SET OUT IN RADIO INTERFERENCE REGULATIONS.

CET APPAREIL EST CONFORME AUX NORMES "CLASSE B", POUR BRUITS RADIOELECTRIQUES. TEL QUE SPECIFIER DANS LE REGLEMENT SUR LE BROUILLAGE RADIOELECTRIQUE.

---

## **THE FCC REGULATION WARNING**

---

This equipment generates and uses radio frequency energy and if not installed and used properly, that is, in accordance with the manufacturer's instructions, may cause interference to radio and television reception. It has been type tested and found to comply with the limits for a class B computing device in accordance with the specifications in Subpart J of Part 15 of FCC Rules, which are designed to provide reasonable protection against such interference in a residential installation. However, there is no guarantee that interference will not occur in a particular installation. If this equipment does cause interference to radio or television reception, which can be determined by turning the equipment off and on, the user is encouraged to try to correct the interference by one of the following measures:

- *Reorient the receiving antenna.*
- *Relocate the equipment with respect to the receiver.*
- *Move the equipment away from the receiver.*
- *Plug the equipment into a different outlet so that equipment and receiver are on different branch circuits.*

If necessary, the user should consult the dealer or an experienced radio/television technician for additional suggestions. The user may find the following booklet prepared by the Federal Communications Commission helpful. "How to Identify and Resolve Radio-TV Interference Problems". This booklet is available from the US Government Printing Office, Washington D.C. 20402, stock No. 004-000-0003454.

---

**N O T I C E**

KORG products are manufactured under strict specifications and voltages required by each country. These products are warranted by the KORG distributor only in each country. Any KORG product sold without a warranty card or not carrying a serial number disqualifies the product from the manufacturer's/distributor's warranty and liability. This requirement is for your own protection and safety.

**KORG** KORG INC.

15-12, Shimotakaido 1-chome, Suginami-ku, Tokyo, Japan.

